

DIGITAL Personal Workstation *a/au-Series*

Installation and Setup Guide

Part Number: EK-ALMIG-SI. A01

April 1998

April 1998

Digital Equipment Corporation makes no representations that the use of its products in the manner described in this publication will not infringe on existing or future patent rights, nor do the descriptions contained in this publication imply the granting of licenses to make, use, or sell equipment or software in accordance with the description.

Possession, use, or copying of the software described in this publication is authorized only pursuant to a valid written license from DIGITAL or an authorized sublicensor.

© Digital Equipment Corporation 1998. All rights reserved.

The following are trademarks of Digital Equipment Corporation: DIGITAL, OpenVMS and the DIGITAL logo.

The following are third-party trademarks:

Microsoft and MS-DOS are registered trademarks and Windows NT is a trademark of Microsoft Corporation. UNIX is a registered trademark in the United States and other countries, licensed exclusively through X/Open Company, Ltd.

FCC Information - Class B

This equipment has been tested and found to comply with the limits for a Class B digital device, pursuant to Part 15 of the FCC rules. These limits are designed to provide reasonable protection against harmful interference in a residential installation.

Any changes or modifications made to this equipment may void the user's authority to operate this equipment.

This equipment generates, uses, and can radiate radio frequency energy and, if not installed and used in accordance with the instructions, may cause harmful interference to radio communications. However, there is no guarantee that interference will not occur in a particular installation. If this equipment does cause harmful interference to radio or television reception, which can be determined by turning the equipment off and on, the user is encouraged to try to correct the interference by one or more of the following measures:

- Reorient or relocate the receiving antenna
- Increase the separation between the equipment and receiver
- Connect the equipment into an outlet on a circuit different from that to which the receiver is connected
- Consult the dealer or an experienced radio/TV technician for help

The user may find the following booklet prepared by the Federal Communications Commission helpful: *How to Identify and Resolve Radio-TV Interference Problems*. This booklet is available from the U.S. Government Printing Office, Washington, D.C., 20402. Stock No. 004-00398-5.

All external cables connecting to this basic unit need to be shielded. For cables connecting to option boards, see the option manual or installation instructions.

This digital apparatus does not exceed the Class B limits for radio noise emissions set out in the radio interference regulations of the Canadian Department of Communications.

Table of Contents

1 Getting Started

Before You Begin	1-1
Initial System Inventory	1-1
Pre-Startup Checklist	1-2
Creating a Comfortable Work Environment	1-2
Installing Your System	1-4
Network Connection	1-5
Connecting External System Devices	1-6
Starting Your System	1-8
Preloaded Operating System Software	1-9
Turning Off Your System	1-9
Microsoft Windows NT	1-9
DIGITAL UNIX	1-9
OpenVMS	1-10
System Security	1-10
Chassis Lockdown Hasp	1-10
Kensington Lock	1-10
Passwords	1-11

2 Setting Up an Operating System

Starting a Windows NT Installation	2-1
Starting a DIGITAL UNIX or OpenVMS Installation	2-5
Updating Firmware	2-5
Microsoft Windows NT Operating System Firmware	2-6
Using the Flash Update Utility from AlphaBIOS	2-6
Updating Firmware from AlphaBIOS	2-6
Preparing a Firmware Floppy Diskette	2-6

Contents

DIGITAL UNIX and OpenVMS Operating System Firmware.....	2-6
Update Utility	2-6
Using the Flash Update Utility from the SRM Console	2-7

3 Troubleshooting

Tips	3-1
Logging Equipment	3-2
System Troubleshooting	3-2

4 Customer Support

Product Information.....	4-1
Support Resources/Checklist.....	4-1

Preface

Welcome









This guide describes how to install, set up, and troubleshoot your DIGITAL Personal Workstation *a/au-Series* system. Topics covered include:

- System inventory
- Ergonomics
- Connection of external devices
- System installation
- Preloaded operating system software
- System security
- Troubleshooting
- Customer support

The following table shows symbols used in this guide and their meanings:

Symbol	Meaning
WWW	Indicates a reference to material located on a Web site.
	Indicates an inventory step or checklist.

Preface

Symbol	Meaning
	Used to alert users to Warnings and Cautions.
	Indicates installation and connection steps.
	Indicates system startup and turning off steps.
	Indicates system security topics.
	Indicates topics on operating system installation or firmware updates.
	Indicates general troubleshooting tips.
	Indicates system logging or general product information.
	Indicates topics on system troubleshooting.

NOTE: Throughout this guide, illustrations and some textual explanations are intended as examples only; based on your system's particular hardware configuration, operating system version, firmware update version, and so forth, your system's display may differ.

Customer Support

See the Checklist in Chapter 4, Customer Support, for instructions on finding support and additional information on the use of your new workstation.

Feedback

Our readers' opinions about this guide or any other DIGITAL product are important to us. If you have any comments, please send e-mail to reader_comments@eng.pko.dec.com.

Please reference order number EK-ALMIG-SI. A01 in your correspondence.

1

Getting Started

This chapter includes an inventory of the items shipped with your system and tells you how to start, install, restart, and turn off your system. Information about preloaded software and guidelines for system security are included as well.

Your DIGITAL Personal Workstation is a high-performance system that uses the latest microprocessor and core logic technology. Housed in a mini-tower box, the system can stand alone or function as a client in an office network environment.

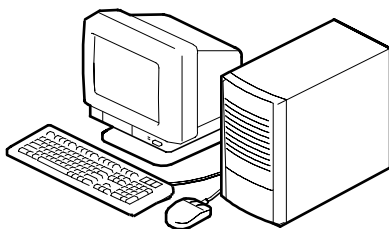

A typical DIGITAL Personal Workstation configuration is shown here. Your system may differ.



Before You Begin

Initial System Inventory

Check to make sure you received the following components with your system, and note the items in a safe place, for later reference:

-
- | | | | |
|--------------------------------------|-------------------------------------|-----------------------------------|--------------------------------------|
| <input type="checkbox"/> Monitor | <input type="checkbox"/> System box | <input type="checkbox"/> Mouse | <input type="checkbox"/> Video cable |
| <input type="checkbox"/> Power cords | <input type="checkbox"/> Microphone | <input type="checkbox"/> Keyboard | <input type="checkbox"/> Headphones |
-

Your system may include different components from those listed. Consult the shipping list that came with your system for an accurate listing of parts. If you think something is missing, contact your distributor or DIGITAL representative.

Getting Started

Pre-Startup Checklist

Before you start your system, perform the following checks:

- Review the information supplied with your system, including user documentation.
- Select a well-ventilated site for your system near a grounded power outlet and away from sources of excessive heat. The site also should be isolated from electric noise (for example, spikes, sags, and surges) produced by devices such as air conditioners, large fans, radios, and televisions.
- Save all shipping containers and packing material for repackaging or moving the system later.

NOTE: Do not install optional hardware or application software until you have started your system and verified that the base system is working correctly.

⚠ WARNING: When unpacking and moving system components, be aware that some components (such as the monitor) may be too heavy for you to lift alone safely. If you are doubtful about whether you can lift these items alone, please get assistance.

Creating a Comfortable Work Environment

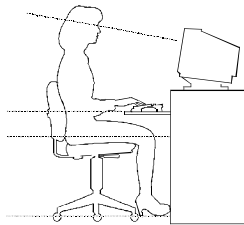

If you exercise poor posture while you work or if your equipment is poorly set up, certain recent scientific articles suggest that personal injury may result. Other articles suggest that there is no cause and effect. Because the safety of our users is a great concern to Digital Equipment Corporation, we strongly urge that you read and follow the precautions outlined in the figure and Table 1-1. In addition, be sure to adjust your work space so that you are comfortable, and change your position frequently.

⚠ WARNING: If you experience pain or discomfort while using your system, rest and review the posture and work habits instructions. If pain or discomfort continues, discontinue use and report the condition to your job supervisor or physician.

Table 1-1: Recommendations for Posture and Work Habits

Adjust	To allow the following conditions
Chair	1. Feet are flat on the floor. 2. Legs are vertical and form a right angle to the floor. 3. Your thighs are horizontal, and they are not bearing weight. Keep the backs of your knees away from the seat so you do not compress the area behind them, which could restrict the blood flow. 4. Your upper body is erect and your lower back is supported with a backrest.
Keyboard and Mouse	5. Your wrists are straight and do not flex more than 15 degrees. They are supported and do not rest on sharp edges. If you use a mouse, rest your hand on the mouse so your wrist is not on the work surface. Operate the mouse close to your body's centerline. 6. Upper arms are straight down at your sides, and elbows are close to your sides and support your arm weight. Forearms are at a 70- to 90-degree angle. 7. If you use a mouse, rest your hand on the mouse so that your wrist is not on the work surface. Operate the mouse close to your body's centerline.
Head	8. Avoid neck strain. Your head should incline downward, but no more than 15 to 20 degrees.
Monitor	9. No higher than the level of your eyes and at the correct distance for your vision. 10. Avoid eye fatigue, which can be caused by glare, image quality, uncomfortable furniture, eye height, and uncorrected vision. If you cannot focus to read at different distances, you may need special glasses. Relax your eyes periodically by focusing on distant objects.
Work breaks	Take periodic work breaks. Morning, lunch, and afternoon breaks during the 8-hour workday meet most recommendations. Take advantage of work breaks to move around and do other activities.
Lighting	Avoid direct lighting or sunlight on the screen, which causes glare and reflections. Place lighting behind or to the side of your work area, and distribute the lighting evenly on your work area.
Noise	Keep background noise at a minimum. Background noise above 65 dBA is tiring. Sound-absorbing materials (for example, curtains, carpeting, and acoustic tile) can help reduce background noise.
Temperature	20 – 23 degrees C (68 - 74 degrees F).
Humidity	30% – 70%.
Ventilation	Provide adequate air ventilation to operate the equipment and avoid fatigue.
Work Space	> 70 cm (28 inches) center to center, preferably between > 152 cm (60 inches).

Getting Started



Installing Your System

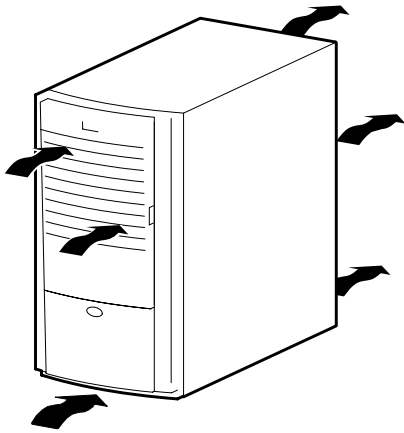

This section shows the installation and connection steps for your system.

NOTE: All connectors are keyed with icons on the back of the system box.

⚠ CAUTION: To ensure proper cooling, verify that air can flow freely into the system front and out the rear of the system. Position your system so that air can flow freely to and from the vents, as shown. Do not block any of the vents, especially those on the system rear or bottom front.

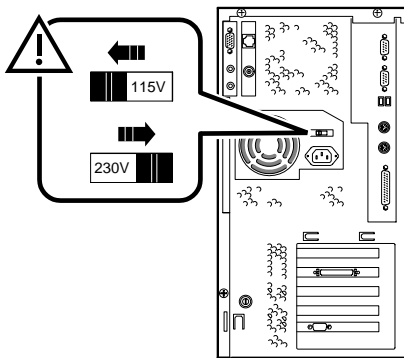

To connect system components, follow these steps:

1. Confirm that the voltage selector switch matches your local voltage (either 115 Volts or 230 Volts), as shown.

⚠ CAUTION: Improper voltage selection can damage the system's power supply!

Getting Started

2. Connect the mouse and keyboard, as shown.

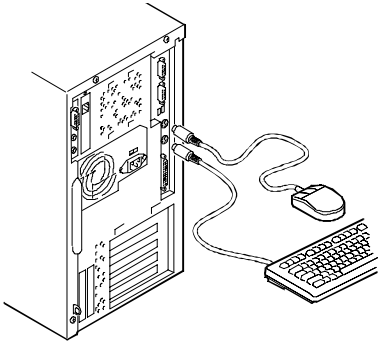

3. Connect the monitor, as shown.

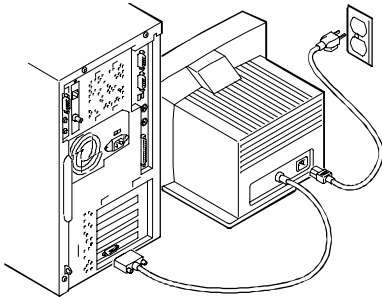

Network Connection

Your DIGITAL Personal Workstation has an embedded Ethernet LAN controller. Refer to the figure, which shows the MAU (media adapter unit) installed, and connect your system to the network. Your system was preconfigured with either a 100-Mbps MII (media independent interface) *or* a 10-Mbps MAU.

Getting Started

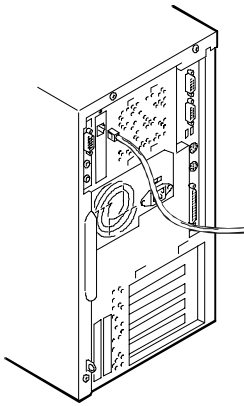

The internal network cables are already installed for you. Optional network kits are available. Contact your DIGITAL representative for more information about the availability of these options.

Connecting External System Devices

The following section describes how to install external devices into your system.

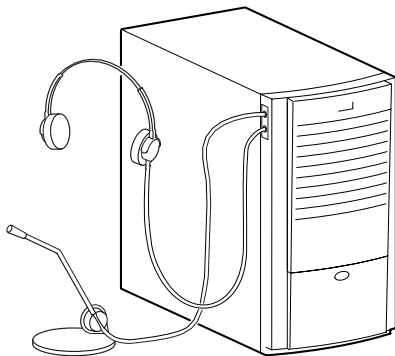

1. Connect the microphone and headphones into the icon-keyed connectors on the side of the system box, as shown.
2. If a SCSI controller is installed and you have an optional external SCSI (Small Computer System Interface) device or SCSI storage box, connect the SCSI cable to the SCSI port on the controller card.

If you purchased speakers for your workstation, refer to the figure and perform the following steps to connect them:

1. Unpack the speakers.
2. Plug the secondary speaker cable into the primary speaker ("Speaker Output").
3. Connect the loose cable to the primary speaker ("Audio Input") and to the top connector on the adapter card ("Speaker Out").

Getting Started

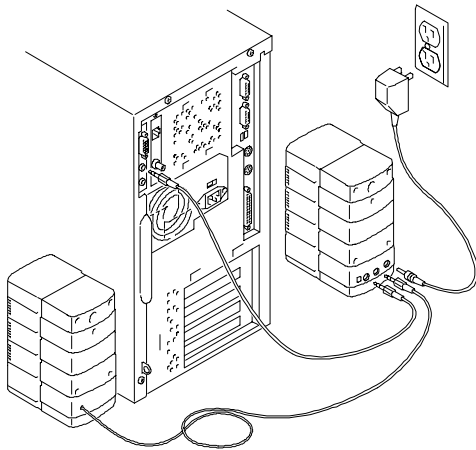

4. Connect the AC adapter cord to the primary speaker.
5. Plug the speaker AC adapter into a power outlet.

NOTE: The figure shows a typical speaker system. Your speakers and connections may vary, depending upon the make and model you purchased.

Refer to the documentation that came with your speakers for further information.

If you purchased a MIDI/joystick device for your workstation, refer to the figure and perform the following steps to connect it:

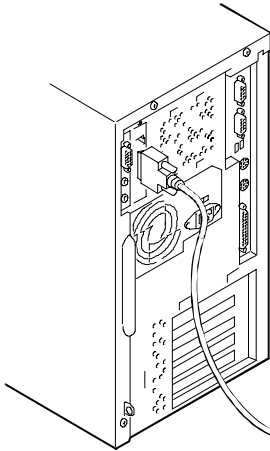

1. Unpack the MIDI/joystick device.
2. Connect the MIDI/joystick device cable into the MIDI port connector on the adapter card, as shown.

Getting Started

Perform the following steps to connect a local printer to your workstation:

1. Review your printer documentation and perform any pre-installation instructions before attempting to connect it to your workstation.
2. Make sure your printer and workstation are turned off.
3. Plug the printer cable into the appropriate printer port (the parallel port for a parallel printer, in figure, or a serial port for a serial printer).
4. Turn on your printer and workstation.
5. Configure your printer for operation with your workstation.

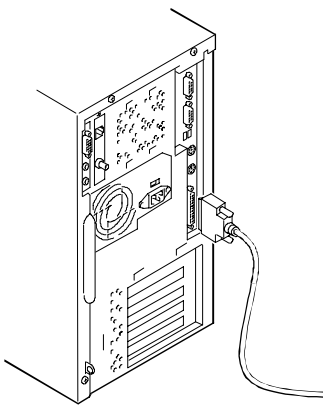

Refer to your operating system online Help and printed documentation for instructions on installing your printer's device driver.



Starting Your System

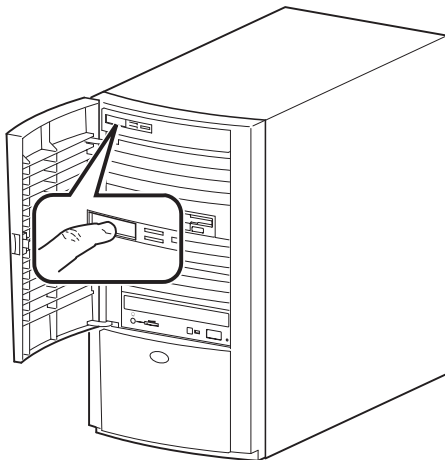

Perform the following steps to start (boot) your DIGITAL Personal Workstation:

⚠ CAUTION: Verify the correct voltage setting for your system before proceeding.

1. Plug the power cord into the system and then into the wall outlet.
2. Turn on any external devices, system unit power button (shown in figure), and monitor power.
3. After waiting for the monitor to warm up, if necessary, adjust the contrast and brightness to obtain a readable screen display.

Refer to the information supplied with your monitor for adjustment instructions.

4. Allow your system to complete the power-on self test (POST) and device initialization. (This takes approximately one [1] minute.)

Preloaded Operating System Software

Your system was preloaded with the operating system that you specified when ordering your system (i.e., Microsoft Windows NT, DIGITAL UNIX, or OpenVMS). See Chapter 2, Setting Up an Operating System, for instructions on reinstalling an operating system.



Turning Off Your System

Before turning off your system, save and close all open files according to the steps outlined for your specific operating system. If you turn the system off without saving and closing files, you might lose some or all of your work.

⚠ CAUTION: Do not turn off power to your system or peripherals until the shutdown sequence has completed.

⚠ WARNING: Always disconnect the power cord from the wall before servicing your system.

Microsoft Windows NT

Perform the following steps, in order, to turn off your system:

1. Close any application data files you have open as well as any applications you have running. Most application programs prompt you to save the information before closing.
2. To shut down your operating system:
 - Click on `Start` on the Windows NT toolbar.
 - Select `Shut Down...`
 - The Shut Down Windows menu displays. You are asked to confirm the shutdown.
 - Select `Shut Down` and click the `Yes` button.
3. Wait for the operating system to complete the shutdown process. Your system displays a message indicating it is safe to turn off or restart the system.
4. To turn off power, press the system unit power button.
5. Disconnect the power cord from the wall before servicing your system.

DIGITAL UNIX

Perform the following steps, in order, to turn off your system:

1. Close any open application data files as well as any running applications. Most application programs prompt you to save the information before closing.
2. To shut down your operating system:

NOTE: You must be a superuser to shut down the system.

Getting Started

- Open a terminal window.
 - Type `Shutdown -h now`.
 - The system returns to the SRM console.
3. Your system displays `>>>` indicating it is safe to turn off or restart the system.
 4. To turn off power, press the system unit power button.
 5. Disconnect the power cord from the wall before servicing your system.

OpenVMS

Perform the following steps, in order, to turn off your system:

1. Close any open application data files as well as any running applications. Most application programs prompt you to save the information before closing.
2. To shut down your operating system, follow these steps:
 - Log into the system account.
 - Open a terminal window (if not already opened).
 - Type `Shutdown`.
 - The system returns to the SRM console.
3. Your system displays `>>>` indicating it is safe to turn off or restart the system.
4. To turn off power, press the system unit power button.
5. Disconnect the power cord from the wall before servicing your system.



System Security

Chassis Lockdown Hasp

The system is equipped with a lock welded onto the back of the chassis. To use this security feature, use a lock of your choice to attach the system to a secured surface such as a table, cabinet, and so forth.

Kensington Lock

If you ordered an optional Kensington lock (order number PCP3H-AG), refer to the figure and secure the lock onto your system as shown.

Getting Started

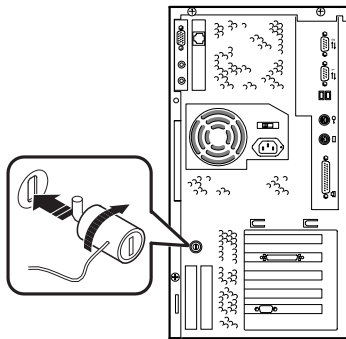

1. Insert the lock into the opening at the back of the system.
2. Turn the lock clockwise to secure it.
3. Connect the power cord and plug it into the wall outlet.
4. Turn on the system.

Passwords

For additional security, most screen saver and pause screen displays can have password protection enabled. See Chapter 3, Troubleshooting.

2

Setting Up an Operating System

Refer to the specific operating system information you received for details.

NOTE: This information provides what you need to begin an operating system installation. Once you have started an installation, follow the on-screen instructions, which may differ slightly from what is documented here.

This chapter describes how to install an operating system; set up partitions for a Microsoft Windows NT installation; and update firmware.

Refer to Table 2-1 for instructions on installing the Microsoft Windows NT operating system on a properly partitioned and formatted disk; see Table 2-2 for instructions on setting up partitions for an NT installation. Refer to Table 2-3 for instructions on installing the DIGITAL UNIX or OpenVMS operating systems.

⚠ CAUTION: If you boot from a DIGITAL UNIX disk and also occasionally boot Microsoft Windows NT from another disk, use caution when you run the Windows NT Disk Administrator. When the Disk Administrator detects additional disks, it updates the system configuration. The Disk Administrator prompts you for permission to write a signature to the additional disks. Writing the signature to a DIGITAL UNIX disk *destroys* the boot block on that disk and makes the operating system on that disk no longer bootable. Select **NO** when you are asked if you want to write a signature to your DIGITAL UNIX disk.



Starting a Windows NT Installation

DIGITAL partitions and formats disk 0 on the first SCSI controller in non-RAID Windows NT systems. The partitions are set up as follows:

- Partition 1 (typically, the “C” drive) is the size of the disk less 6 MB and formatted FAT. Normally, you select “convert to NTFS” during the Windows NT installation.

Setting Up an Operating System

- Partition 2 (typically, the “D” drive) is 6 MB, formatted FAT, and identified as the system partition.

Table 2-1 describes how to install Microsoft Windows NT operating system on a properly partitioned and formatted disk.

NOTE: You must have the AlphaBIOS console installed and running in order to install the Windows NT operating system.

Table 2-1: Starting a Microsoft Windows NT Installation

Step	Action	Result or Displayed Text
1	From the AlphaBIOS boot screen, press [F2].	AlphaBIOS setup screen displays.
2	Insert the Microsoft Windows NT Workstation CD-ROM into the CD drive. Press [Enter].	CD-ROM drive is ready.
3	Select Install Windows NT.	Windows NT setup procedure starts. The following message is displayed: Setup could not determine the type of computer you have, or you have chosen to manually specify the computer type. Select the computer type from the following list, or select “Other” if you have a device support disk provided by your computer manufacturer. . . . => Other
4	Select Other.	“Please insert the disk labeled Manufacturer-supplied hardware support disk into drive A:.”
5	Insert the floppy diskette labeled Hardware Support Disk for Microsoft® Windows NT® 4.0 (AK-R1SHH-CA) into the floppy drive. Press [Enter].	You have chosen to configure a computer for use with Windows NT using a device support disk provided by the computer’s manufacturer. Select the computer type from the following list, or press [Esc] to return to the previous screen. =>DIGITAL Personal Workstation 433a, 500a, 600a (Your screen may show a different series name.)
6	Select DIGITAL Personal Workstation 433a, 500a, 600a. (Your screen may show a different series name.) Press [Enter].	Setup could not determine the type of one or more mass storage devices installed in your system, or you have chosen to manually specify an adapter. Currently, Setup will load support for the Qlogic PCI SCSI Host adapter.

Setting Up an Operating System

Table 2-1: Starting a Windows NT Installation, *continued*

Step	Action	Result or Displayed Text
7	Type "S" to select additional devices. <i>or</i> Press [Enter] if you do not want to specify additional storage devices.	Select the SCSI adapter you want from the following list, or select "Other" if you have a device support disk provided by an adapter manufacturer. . . . =>Other
8	Select Other .	"Please insert the disk labeled Manufacturer-supplied hardware support disk into Drive A:."
9	Insert the floppy diskette labeled Hardware Support Disk, Disk 1 of 1 (AK-RC1YA-CA) in drive A. Press [Enter] to select the driver.	You have chosen to configure a SCSI adapter for use with Windows NT, using a device support disk provided by an adapter manufacturer. Select the SCSI adapter you want from the following list, or press [Esc] to return to the previous screen. =>e.g., Microsoft ATAPI driver
10	Press [Enter] to load the driver.	Follow the screen prompts for mass-storage device-loading support.
11	To continue, Press [Enter].	Setup will load support for the following mass storage devices: Qlogic PCI SCSI Host Adapter Microsoft ATAPI driver
12	(DIGITAL does not recommend selecting [R] to repair Windows NT.) Press [Enter] to continue with Setup.	Welcome to Setup. The Setup program for the Microsoft® Windows NT® operating system version 4.0 prepares Windows NT to run on your computer. To learn more about Windows NT Setup before continuing, press [F1]. To set up Windows NT now, press [Enter]. To repair a damaged Windows NT version 4.0 installation, press [R]. To quit Setup without installing Windows NT, press [F3].
13	Press [Enter].	Setup has recognized the following mass storage devices in your computer: Qlogic PCI SCSI Host Adapter Microsoft ATAPI driver
14	Press [Enter].	The Microsoft Windows NT licensing agreement displays.
15	Use the [Page Down] keypad to scroll through the Windows NT licensing agreement.	A message indicating your choices displays.

Setting Up an Operating System

Table 2-1: Starting a Windows NT Installation, *continued*

Step	Action	Result or Displayed Text
16	Press [F8] to indicate your acceptance of the licensing agreement.	A message indicating your choices displays.
17	Press [Enter] to confirm your choice.	Setup has found Windows NT on your hard disk in the directories shown below.
<i>NOTE: Follow the screen prompts to choose a partition, to confirm a partition, and to decide whether or not to format the partition.</i>		
18	Press [Enter] to accept the choice.	Setup will now examine your hard disks.
19	Insert the floppy diskette (AK-R1SHH-CA) into the floppy drive. Press [Enter].	Please insert the disk labeled Hardware Support Disk for Microsoft® Windows NT® 4.0.
20	Follow screen prompts.	Please wait while Setup copies files to the hard disk.
21	Press [Enter] to restart your computer.	This portion of Setup has completed successfully.
22	Follow the screen prompts to set up the reinstalled Windows NT operating system.	The Windows NT operating system loads and starts.

If you are installing the operating system on a disk that has not been partitioned and formatted, refer to Table 2-2.

Table 2-2: Setting Up Partitions for a Windows NT Installation

Step	Action	Result
1	From the AlphaBIOS boot screen, press [F2].	AlphaBIOS setup screen displays.
2	Select <code>Hard Disk Setup...</code> Press [F6] to format disk. Press [F7] for express <code>Hard Disk Setup</code> .	If disk 0 is not partitioned, a message asking if you would like to proceed with default disk partitioning displays.
3	Press [F10] to continue.	Express Setup Complete screen displays.
4	Press [Enter].	A list of disks, including partitions, displays.
5	Press [Escape].	AlphaBIOS setup screen displays. Refer to Table 2-1 to re-attempt a Windows NT installation.

Setting Up an Operating System



Starting a DIGITAL UNIX or OpenVMS Installation

To start a DIGITAL UNIX *or* OpenVMS installation, follow the steps in Table 2-3.

NOTE: The SRM console must be installed and running in order to perform a DIGITAL UNIX or OpenVMS installation. If the AlphaBIOS console is running, refer to the DIGITAL Personal Workstation System Reference and Maintenance Guide for instructions on loading the SRM firmware.

WWW See (<http://www.workstation.digital.com/>) for more information.

Table 2-3: Starting a DIGITAL UNIX or OpenVMS Installation

Step	Action	Result
1	At the SRM prompt, type: <code>>>>set boot_osflags ""</code>	Clears the <code>boot_osflags</code> variable.
2	At the SRM prompt, type: <code>>>>set auto_action halt</code>	Halts the system at the console prompt each time the system is turned on, crashes, or when the reset button is pushed.
3	At the SRM prompt, type: <code>>>>set os_type (e.g., DIGITAL UNIX or OpenVMS)</code> <code>>>>init</code>	Sets the operating system (DIGITAL UNIX <i>or</i> OpenVMS).
4	Insert the DIGITAL UNIX <i>or</i> OpenVMS CD-ROM into the CD drive.	CD-ROM drive is ready.
5	At the SRM prompt, type: <code>>>>show device</code>	List of devices displays: <code>dka0.0.0.4.0 DKA0 TOSHIBA CD-ROM XM-56 1796</code> <code>dkc0.0.0.1008.0 DKC0 RZ1BA-BS 3001</code> <code>dvc100.1.0.1008.0 DKC100 SEAGATE ST15150W 9107</code> <i>NOTE: For OpenVMS, the CD-ROM is DQA0.</i>
6	From the SRM console, boot the DIGITAL UNIX <i>or</i> OpenVMS CD-ROM. <code>>>>boot dka400</code>	Installation information is displayed, and you are prompted to select an option. For more information, see the DIGITAL UNIX <i>Installation Guide</i> or the DIGITAL OpenVMS <i>Installation Guide</i> .



Updating Firmware

The DIGITAL Personal Workstation system contains flashROM for the console firmware. The flashROM contains the power-on self test (POST), AlphaBIOS console firmware (for

Setting Up an Operating System

the Microsoft Windows NT operating system), and the SRM console firmware (for the DIGITAL UNIX and OpenVMS operating systems).

This section explains how to use the firmware update utility to install firmware upgrades. Consult the appropriate operating system-specific section (e.g., Microsoft Windows NT, DIGITAL UNIX, or OpenVMS).

NOTE: The user is responsible for performing system firmware upgrades.

Consult your upgrade documentation for more information.

Microsoft Windows NT Operating System Firmware

Using the Flash Update Utility from AlphaBIOS

You may update the firmware by either using the supplied CD *or* by copying the firmware from the Internet onto a floppy diskette.

Updating Firmware from AlphaBIOS

To update the firmware from AlphaBIOS using the firmware CD or floppy diskette, follow these steps:

1. Shut down the Windows NT operating system and restart the system.
2. Insert the Firmware Update CD-ROM or a floppy diskette (prepared as the next section describes) into the appropriate drive.
3. From the AlphaBIOS boot screen, press [F2] to enter AlphaBIOS setup.
4. From the AlphaBIOS setup screen, select `Upgrade AlphaBIOS`.

HINT: AlphaBIOS verifies the system image and displays the old and new firmware versions.

5. Follow the screen prompts to complete the update.

Preparing a Firmware Floppy Diskette

If you have access to the network, you may use an Internet browser to copy the firmware from: <ftp.digital.com/pub/Digital/Alpha/firmware> area. Follow the directions outlined at the site.

DIGITAL UNIX and OpenVMS Operating System Firmware

Update Utility

Use the update utility to update your SRM firmware. The update utility contains two images: the update utility itself and the SRM image.

Setting Up an Operating System

Using the Flash Update Utility from the SRM Console

To update the firmware from the SRM console, do the following:

1. Insert the Firmware Update CD-ROM into the CD-ROM drive.
2. Type the show device command to determine the device ID of the CD-ROM drive.

```
>>>SHOW DEVICE
```

```
dka0.1.0.4.0          DKA0          CD-524E      4.0D
dkc100.1.0.10098.0   DKC100        RZ29B       0016
dva0.0.0.0.1         DVA0
ewa0.0.0.3.0         EWA0          00-00-F8-75-44-22
pkc0.7.0.1009.0     PKC0          SCSI Bus ID 7    5.27
pqa0.0.0.4.0         PQA0          PCI EIDE
pqb0.0.1.4.0         PQB0          PCI EIDE
```

3. Boot the Firmware Update Utility CD-ROM using the device ID display in step 2.

```
>>>b -fl 0,a0 dka0 (for DIGITAL UNIX) or dqa0 (for OpenVMS)
```

Bootfile: e.g.,[alpha433au]as433au_vx_x.exe (where x_x is the appropriate version)

You should see a display that reflects your system's particular hardware configuration and firmware update version while the update utility is loading and executing, for example:

```
bootstrap code read in
base = 1d4000, image_start = 0, image_bytes = 151e00
initializing HWRPB at 2000
initializing page table at 1c6000
initializing machine state
setting affinity to the primary CPU
jumping to bootstrap code
ff.fe.fd.fc.fb.fa.f9.f8.f7.f6.f5.CPU 0 speed is 2.00 ns
(500MHz)
ef.ee.ed.ec.eb.f4.ea.e9.e8.e7.e5.e4
Digital Personal Workstation 500au Consolbe V6.7-249 built
on Feb 19, 1998 at 11:01:35
>>>(boot pmem:180000 -flags 0)
bootstrap code read in
base = 180000, image_start = 0, image_bytes = 800000
initializing HWRPB at 2000
initializing page table at 7be000
initializing machine state
setting affinity to the primary CPU
jumping to bootstrap code
```

Setting Up an Operating System

```
Digital Personal Workstation 500 au Firmware Update V6.78
Use HELP or ? for help
Update
VERIfy
List
Show
DUmp
VERBose
NVerbose
DEbug
NDebug
?
Apu->
```

4. To update the firmware, type `update` and `SRM`. The following information is displayed as the firmware is being updated. The actual information may change between versions.

```
Apu-> update SRM
APU-I Are you ready to Program (SRM) ROM Device? (Y/N)Y
APU-I Erasing (SRM) ROM device
APU-I Programming (SRM) ROM device
APU-I Verify loaded (SRM) ROM image
APU-I Verify loaded (SRM) ROM image done
APU-I Programming (SRM) ROM completed
APU-I Verify SRM
SRM ROM verify successful
Apu-> Verbose
Verbose :Apu-> Verify SRM
Version = v6.7-250
```

5. To exit the update utility, cycle the power. Leave the power off for at least 45 seconds.

NOTE: Commands such as `Dump`, `List`, `Show`, and `Verify` must have verbose mode enabled.

3

Troubleshooting

This chapter describes initial as well as some detailed troubleshooting for your DIGITAL Personal Workstation.

Refer to the documentation supplied with additional options if you experience problems with specific options that you have installed.



Tips

Use these troubleshooting tips should your computer ever fail to operate correctly.

- Keep it simple; troubleshoot one problem at a time. Also, only make one change at a time. For example, if your SCSI hard disk drive fails to boot, do not try all the suggested actions at once. Instead, start with one suggestion such as checking the cables. After securing the cables, try booting your computer. If it does not work, try another suggestion.
- Look for abnormal computer, keyboard, and monitor light-emitting diode (LED) indications. For example, make sure the power-on LED lights when you turn on your computer and the drive access indicators light when using either the diskette drive or hard disk drive.
- If you installed external devices, make sure all cables are correctly and securely connected to the appropriate devices and that the devices are installed correctly.
- If you installed devices inside the computer, make sure nothing was bumped or jarred loose, and that all cable connections are securely in place.
- Make sure all device drivers are installed correctly.
- Press the Reset (or Halt) button. Try rebooting your system.

Troubleshooting

- Pay close attention to any error message that appears on your screen. If the error message is hardware related, refer to the troubleshooting tables later in this chapter for recommended actions.
If the error message is operating system-related, refer to online Help and the appropriate operating system documentation supplied with your computer.
- README files might be factory installed, on the CD-ROM disk, or as printed material. This README information can help you setup, configure, and operate your computer.

NOTE: If DIGITAL support tells you to return a failed component, pack it in its original container and then return it to DIGITAL or your DIGITAL authorized distributor as instructed.

- Check that the power indicator is on and that the fan is running.
- Check the power indicator on the monitor. Also, check the monitor, keyboard, and mouse cables to ensure that they are connected and seated properly.
- Contact DIGITAL Services or your service provider for software- or hardware-related problems.



Logging Equipment

Record all model numbers and serial numbers of your hardware components in the Checklist portion of Chapter 4, Customer Support.



System Troubleshooting

Table 3-1 lists how to identify and solve problems that could occur with your system, disk drive, audio, and monitor.

Troubleshooting

Table 3-1: System Troubleshooting

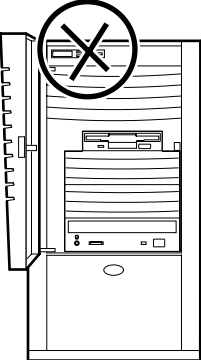
Problem	Possible Cause	Action
<p>Power indicator not on.</p> 	<p>System is not plugged in.</p> <p>System is not turned on.</p> <p>No power at the wall outlet.</p> <p>Internal power supply cables not reconnected after installing options.</p> <p>Power supply failure.</p> <p>Correct voltage not set.</p> <p>Fans not connected.</p> <p>Fan vents blocked.</p> <p>Power switch cable not plugged into riser card.</p>	<p>Plug the system in, and then turn it back on.</p> <p>Push the power button.</p> <p>Use another wall outlet.</p> <p>Reconnect power cables.</p> <p>Contact your service representative.</p> <p>Unplug the system, set correct voltage on system back, and turn system back on. <i>(NOTE: The power supply may have been damaged.)</i></p> <p>Connect fans to the riser card.</p> <p>Remove obstruction from fan vents.</p> <p>Plug front-panel power switch cable into the riser card.</p>

Troubleshooting

Table 3-1: System Troubleshooting, *continued*

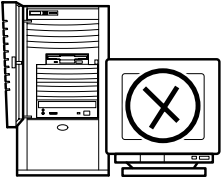
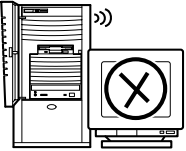
Problem	Possible Cause	Action
<p>Power is on, but there is no screen display and no beeps.</p> 	<p>Monitor brightness and contrast controls are not correctly set.</p> <p>Monitor is off.</p> <p>Monitor cable or power cord is incorrectly installed.</p> <p>Configuration error.</p> <p>Monitor is defective.</p> <p>Bad monitor cable.</p> <p>Defective video controller module.</p> <p>Keyboard or video controller missing or malfunctioning.</p>	<p>Adjust the brightness and contrast controls.</p> <p>Ensure AC power cord is plugged in and turn on the monitor.</p> <p>Check all monitor connections.</p> <p>Refer to the video module documentation for more information.</p> <p>Try another monitor.</p> <p>Try another cable.</p> <p>Replace the video module.</p> <p>The console tests for keyboard and video before displaying information. Check connections.</p>
<p>Power is on, but there is no screen display.</p> 	<p>Various possible causes.</p>	<p>Listen carefully for computer beep codes; record the number of beeps and their patterns and then check the beep codes below:</p> <p>1-3-3 No usable memory detected</p> <p>1-1-4 Firmware in flashROM is corrupted</p>

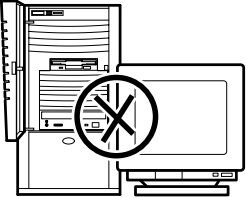

Troubleshooting

Table 3-1: System Troubleshooting, *continued*

Problem	Possible Cause	Action
<p>System does not boot.</p> 	<p>Operating system software is not installed on the hard disk drive.</p> <p>Hard drive cable is not connected or there is no power to the drive.</p> <p>System cannot find the boot device.</p> <p>Environment variables incorrectly set.</p> <p>Hard disk drive is not correctly formatted or the requested partition does not exist.</p> <p>There is no software on the requested partition.</p> <p>Windows NT overwrote the UNIX or OpenVMS boot block.</p>	<p>Install the appropriate operating system.</p> <p>Connect hard drive signal and power cables.</p> <p>Check the system configuration for correct device parameters. Use the firmware to display system configuration. Look at the hard disk configuration to determine what hard disk is available. Verify the operating system selection information.</p> <p>For AlphaBIOS: From the Boot screen, press [F2] to go to setup. From there, go to the desired location to correctly set the environment variables.</p> <p>For DIGITAL UNIX or OpenVMS: Type <code>>>>show all</code> to get a list of all environment variables.</p> <p>Format the hard disk drive or correctly partition the hard disk drive using the supplied software.</p> <p>Install software on the requested partition or point to the correct partition.</p> <p>Reinstall the operating system.</p>

Troubleshooting

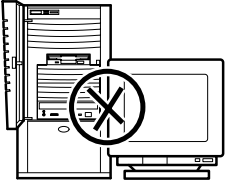
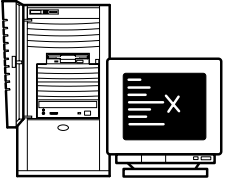
Table 3-1: System Troubleshooting, *continued*

Problem	Possible Cause	Action
<p>System boots automatically when you don't want it to.</p> 	<p>System is set to autoboot.</p>	<p>For DIGITAL UNIX <i>or</i> OpenVMS users: When SRM starts, press [Ctrl/C] to stop the autostart countdown. Type >>>auto_action halt to change a variable.</p> <p>For Windows NT users: When AlphaBIOS starts, press a ↓ to stop the autostart countdown. Go to Setup to change a variable.</p>
<p>Target boot device not listed in the SRM display system configuration.</p> 	<p>Loose power and/or data cable.</p> <p>SCSI bus too long.</p> <p>SCSI drive not set as drive 0.</p> <p>SCSI termination is done incorrectly.</p>	<p>Secure all signal and power cable connections.</p> <p>Alter SCSI bus to correct length in compliance with the 1.5-meter limitation for combined cable and signals on the circuit board.</p> <p>Reset SCSI drive as drive 0.</p> <p>Terminate the extreme ends of each signal. Make sure that there are two, and only two, terminators. Make sure there is no extra termination. Check that there is active termination only.</p>
<p>No response to keyboard commands.</p> 	<p>Keyboard is password protected.</p> <p>Keyboard is not connected.</p> <p>Keyboard is connected to the mouse port.</p>	<p>Enter the keyboard password, if supported by your operating system.</p> <p>Connect the keyboard to the keyboard port.</p> <p>Connect the keyboard to the keyboard port.</p>

Troubleshooting

Table 3-1: System Troubleshooting, *continued*

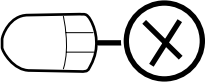
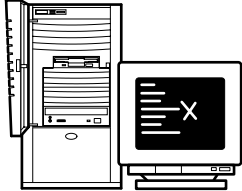
Problem	Possible Cause	Action
<p>No response to mouse commands.</p> 	<p>Mouse is not connected.</p> <p>Mouse is connected to the keyboard port.</p> <p>Mouse driver not installed.</p> <p>Mouse ball sticking.</p>	<p>Connect the mouse and restart the operating system.</p> <p>Connect the mouse to the mouse port and restart the operating system.</p> <p>Install the appropriate mouse driver. Refer to your supplied application software documentation.</p> <p>Clean the mouse.</p>
<p>System forgets some environment variables or the time-of-day while powered off.</p>  <p>For DIGITAL UNIX <i>or</i> OpenVMS users: System starts AlphaBIOS rather than SRM firmware. <i>or</i> System forgets user preference for SRM firmware and starts AlphaBIOS firmware when powered on.</p>	<p>Dead battery.</p> <p>No contact between battery holder and battery.</p>	<p>Replace the lithium battery. Use a DIGITAL (P/N 12-41474-05) or type 2032 three-Volt DC lithium battery. See the DIGITAL <i>Personal Workstation System Reference and Maintenance Guide</i> for details.</p> <p>Carefully adjust metal tab on battery holder to allow contact with battery.</p>

Troubleshooting

Table 3-1: System Troubleshooting, *continued*

Problem	Possible Cause	Action
<p>Security mode is enabled. Password does not work.</p> 	<p>User does not have correct password.</p>	<p>For Windows NT users, perform the following steps:</p> <ol style="list-style-type: none">1. Power off the system.2. Open the system box.3. Power on the system and wait for the console to start.4. Press the password reset button on the MLB.5. Power off the system.6. Reassemble system.7. Power on the system.8. Set new password if desired. <p><i>NOTE: Take care to remember your password.</i></p> <p>Get necessary configuration data from the equipment log where you recorded it.</p> <p>If you are a DIGITAL UNIX or Open VMS user, consult Chapter 4 for instructions on contacting DIGITAL Customer Support.</p>

Troubleshooting

Table 3-2: Disk Drive Troubleshooting

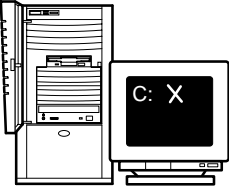
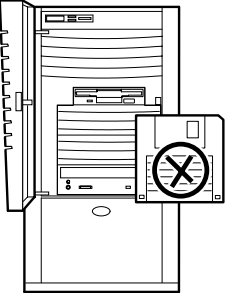
Problem	Possible Cause	Action
<p>Hard disk drive cannot read or write information.</p> 	<p>Incorrect SCSI drive ID settings.</p> <p>Loose or incorrectly installed cables.</p> <p>Disk drive is not correctly formatted or partitioned.</p> <p>External drive not powered up.</p>	<p>Set the SCSI ID. Refer to the disk drive installation instructions.</p> <p>Make sure all cables are correctly installed.</p> <p>Format and partition as required using the supplied operating system.</p> <p>Turn on the external drive.</p>
<p>Floppy drive cannot read or write information.</p> 	<p>Floppy diskette is not formatted.</p> <p>Floppy diskette is wrong density.</p> <p>Floppy diskette is worn or damaged.</p> <p>Floppy diskette is write protected.</p> <p>Floppy drive is empty.</p> <p>Floppy drive power or data cable not connected.</p> <p>Floppy drive data cable connector installed backwards.</p>	<p>Format the floppy diskette.</p> <p>Use a floppy diskette of the proper density for your drive.</p> <p>Try another floppy diskette.</p> <p>Slide the write-protect switch so the hole is not visible.</p> <p>Insert a floppy diskette.</p> <p>Connect floppy drive power or data cable.</p> <p>Install floppy drive data cable connector correctly.</p>

Troubleshooting

Table 3-3: Audio Troubleshooting

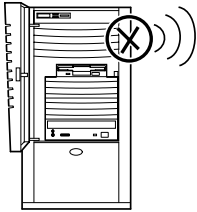
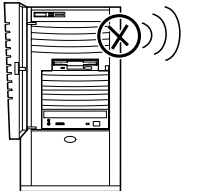
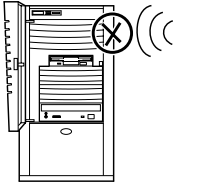
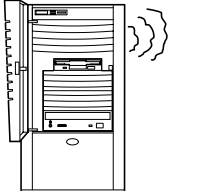
Problem	Possible Cause	Action
<p>No sound.</p> 	<p>Cables not plugged in.</p> <p>Driver not installed.</p> <p>Volume control set low.</p> <p>Headset plugged in.</p> <p>No power to external speakers.</p> <p>Internal speaker not connected.</p>	<p>Plug in the cables.</p> <p>Install the driver.</p> <p>Use an on-screen volume control (if available) to increase the volume.</p> <p>Unplug headset and plug microphone into correct connector.</p> <p>Plug in external speakers.</p> <p>Connect internal speaker.</p>
<p>No keyboard beeps.</p> 	<p>Jumpers J40 (all sound enabled) or J41 (buzzer) are not in place.</p>	<p>Make sure J40 and J41 are enabled: that is, jumpers connect both pins one and two on the MLB.</p>
<p>Cannot record.</p> 	<p>Cables not plugged in.</p> <p>Record volume level set low.</p>	<p>Plug in the cables.</p> <p>Use the appropriate control to increase the record level.</p>
<p>Distorted sound.</p> 	<p>Record volume level set high.</p>	<p>Reduce the volume level. (Use amplified speakers.)</p>

Troubleshooting

Table 3-4: Monitor Troubleshooting

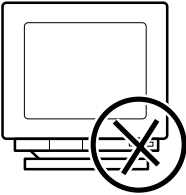
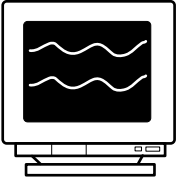
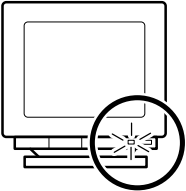
Problem	Possible Cause	Action
<p>Monitor power indicator is not on.</p> 	<p>Monitor is turned off.</p> <p>Power cord is not connected.</p> <p>No power at wall receptacle.</p> <p>Monitor is defective.</p>	<p>Turn on the monitor.</p> <p>Connect the power cord to the system or a wall receptacle.</p> <p>Use another receptacle.</p> <p>Try another monitor.</p>
<p>Distorted, rolling, or flickering screen display, or wrong/uneven color.</p> 	<p>Adjustments incorrect.</p> <p>Wrong type of monitor.</p> <p>Defective monitor.</p> <p>Monitor signal cable loose or damaged.</p>	<p>Adjust accordingly.</p> <p>Try another monitor.</p> <p>Try another monitor.</p> <p>Inspect connector pins. Replace cable if damaged.</p>
<p>Monitor power indicator is flashing.</p> 	<p>Monitor cable not connected.</p>	<p>Connect monitor cable.</p>

4

Customer Support

This chapter provides information on obtaining additional product operating instructions as well as ways to obtain advanced troubleshooting assistance.



Product Information

Several resources are available to answer your questions about using and maintaining your system as well as product- and operating-system-related updates.

WWW Go to <http://www.workstation.digital.com/products/guides/>.

- DIGITAL *Personal Workstation a/au-Series System Reference and Maintenance Guide* (available May 1998). Detailed service-, maintenance-, FRU-, and configuration-related information.
- DIGITAL *Personal Workstation a/au-Series Technical Information Guide* (available May 1998). Detailed information on CPU, ISA, PCI, interrupts, registers, addressing, connectors and cables, LEDs, and FRU replacement, among other topics.
- DIGITAL *Personal Workstation au-Series Operating System Installation Guide* (EK-ALUNX-OS). Instructions on running multiple operating systems.

Your distributor or DIGITAL representative can provide information on products and services as well



Support Resources/Checklist

In addition to the resources listed above, DIGITAL provides telephone customer support available at 1-800-354-9000 (in the United States) or 1-800-267-5251 (in Canada). To reach customer support through the Web, go to http://www.digital.com/services/mcs_howto.htm. To make the most of your telephone or

Customer Support

Web inquiry, please fill in the following checklist prior to placing a call to ensure that the customer support staff have the information necessary to process your request.

BEFORE YOU CALL, fill in the following information:	
Today's date	
Customer company name Address Contact name Phone number	
System model number Serial number Date of purchase	
Software platform and version	
Layered software applications	
System configuration	CPU/MLB/revision: Firmware Console SRM: PALcode VMS: OSF: BIOS SRM: ARC: Riser card/revision: Memory/size (in total MB): Graphics cards: Number of drives/revision: Power supply/revision: Monitor type:
Problem description	When did the problem start? Is the system new? Did the problem start after an upgrade? Some time after installation? Is the error repeatable? Does the error happen occasionally? Intermittently? Are there any network-related issues?
Customer impact	Is the system running? Down?
Solutions attempted so far	What diagnostics have been used for testing? (POST, boot operating system, etc.) What hardware has been replaced?

Index

A

- AlphaBIOS
 - console, 2–2
- Audio
 - troubleshooting, *table*, 3–10

B

- Battery
 - type, 3–7
- Boot
 - multiple, precautions, 2–1

C

- Checklist
 - pre-startup, 1–2
- Console
 - update utility, 2–6
- Customer support
 - checklist, 4–12
 - telephone numbers, 4–12

D

- DIGITAL UNIX, 1–9
 - installing, 2–5
 - installing, *table*, 2–5
 - updating firmware, 2–6
- Disk drive
 - troubleshooting, *table*, 3–9

E

- Equipment
 - logging, 3–2
- Ergonomics, 1–2
- Ethernet LAN, 1–5
- External devices
 - connecting, 1–6

F

- Firmware
 - preparing a floppy diskette, 2–6
 - update utility, 2–6
 - updating, 2–1, 2–5
- Flash
 - update utility, 2–6

L

- Local printer
 - connecting, 1–8

M

- Microsoft Windows NT, 1–9
- MIDI/joystick
 - connecting, 1–7
- Monitor
 - troubleshooting, *table*, 3–11

Index

N

Network

connection, 1–5

O

OpenVMS, 1–10

installing, 2–5
installing, *table*, 2–5
updating firmware, 2–6

Operating system

installing, 2–1

P

Partitions

setting up, 2–1
setting up, *table*, 2–4

Problem solving, 3–1

R

Reset button, 3–1

Resources

product information, 4–12
Web sites, 4–12

S

SCSI

controller, 1–6

Security

Kensington lock, 1–10
lockdown hasp, 1–10
system, 1–10

Software

preloaded, 1–9

Speakers

connecting, 1–6

System

configuration, 1–1
cooling, 1–4
installation and connection, 1–4

inventory, 1–1

passwords, 1–11

security, 1–10

startup, 1–8

startup, voltage selection, 1–4

turning off, 1–9

turning off, 1–9

voltage, 1–4

System components

lifting, 1–2

T

Troubleshooting, 3–1, 3–2

audio, *table*, 3–10

basic tips, 3–1

boot device not listed, 3–6

boot problem, 3–5

dead battery, 3–7

disk drive, *table*, 3–9

disk read and write problem, 3–9

display problems, 3–11

keyboard, 3–6

monitor power indicator problem, 3–11

monitor, *table*, 3–11

mouse, 3–7

system forgets settings, 3–7

system, *table*, 3–3

U

Update utility, 2–6

W

Web sites, 4–12

Windows NT

installing, 2–1

installing, *table*, 2–2

updating firmware, 2–6

Work environment

recommendations, 1–3