

HP 200LX

User's Guide



HP 200LX User's Guide



HP Part No. 1216-90001
Printed in Singapore
Edition 1

 Printed on recycled paper

Notice

This manual and any examples contained herein are provided "as is" and are subject to change without notice. **Hewlett-Packard Company makes no warranty of any kind with regard to this manual, including, but not limited to, the implied warranties of merchantability and fitness for a particular purpose.** Hewlett-Packard Co. shall not be liable for any errors or for incidental or consequential damages in connection with the furnishing, performance, or use of this manual or the examples herein.

The above disclaimers and limitations shall not apply to consumer transactions in Australia and the United Kingdom and shall not affect the statutory rights of consumers.

©Hewlett-Packard Co. 1996. All rights reserved. Reproduction, adaptation, or translation of this manual is prohibited without prior written permission of Hewlett-Packard Company, except as allowed under the copyright laws.

The programs that control this product are copyrighted and all rights are reserved. Reproduction, adaptation, or translation of those programs without prior written permission of Hewlett-Packard Co. is also prohibited.

Quicken is a registered trademark of Intuit, Inc. Lotus and 1-2-3 are registered trademarks of Lotus Development Corporation. Microsoft and MS-DOS are registered trademarks of Microsoft, Incorporated. LapLink Remote Access is a trademark of Traveling Software, Inc.

© Trustees of Columbia University in the City of New York, 1989. Permission is granted to any individual or institution to use, copy, or redistribute Kermit software so long as it is not sold for profit, provided this copyright notice is retained.

**Hewlett-Packard Singapore (Private) Limited
Asia-Pacific Personal Computer Division
452 Alexandra Road
Singapore 119961**

HP Software Product License Agreement

Important: Please carefully read this License Agreement before operating the equipment. Rights in the software are offered only on the condition that the Customer agrees to all terms and conditions of the License Agreement. **Operating the equipment indicates your acceptance of these terms and conditions.** If you do not agree to the License Agreement, you may return the unopened package for a full refund.

In return for payment of the applicable fee, HP grants the Customer a license in the software, until terminated, subject to the following:

Use:

- Customer may use the software on any one computer.
- Customer may not reverse assemble or decompile the software.

Copies and Adaptations:

- Customer may make copies or adaptations of the software:
 - For archival purposes, or
 - When copying or adaptation is an essential step in the use of the software with a computer so long as the copies and adaptations are used in no other manner.
- Customer has no other rights to copy unless they acquire an appropriate license to reproduce which is available from HP for some software.
- Customer agrees that no warranty, free installation, or free training is provided by HP for any copies or adaptations made by Customer.
- All copies and adaptations of the software must bear the copyright notice(s) contained in or on the original.

Ownership:

- Customer agrees that they do not have any title or ownership of the software, other than ownership of the physical media.
- Customer acknowledges and agrees that the software is copyrighted and protected under the copyright laws.
- Customer acknowledges and agrees that the software may have been developed by a third party software supplier named in the copyright notice(s) included with the software, who shall be authorized to hold the Customer responsible for any copyright infringement or violation of this License Agreement.

Transfer of Rights in Software:

- Customer may transfer rights in the software to a third party only as part of the transfer of all their rights and only if Customer obtains the prior agreement of the third party to be bound by the terms of this License Agreement.
- Upon such a transfer, Customer agrees that their rights in the software are terminated and that they will either destroy their copies and adaptations or deliver them to the third party.
- Transfer to a U.S. government department or agency or to a prime or lower tier contractor in connection with a U.S. government contract shall be made only upon their prior written agreement to terms required by HP.

Sublicensing and Distribution: Customer may not sublicense the software or distribute copies or adaptations of the software to the public in physical media or by telecommunication without the prior written consent of HP.

Termination: HP may terminate this software license for failure to comply with any of these terms provided HP has requested Customer to cure the failure and Customer has failed to do so within thirty (30) days of such notice.

Updates and Upgrades: Customer agrees that the software does not include updates and upgrades which may be available from HP under a separate support agreement.

Export Clause: Customer agrees not to export or re-export the software or any copy or adaptation in violation of the U.S. Export Administration regulations or other applicable regulations.

Edition History

Edition 1 October 1996

Contents

Part 1. Getting Started

1 Getting Started

A look at Your Palmtop PC-----	1-1
Hardware Features-----	1-2
Software Features-----	1-2
Activating Password Protection-----	1-4
Managing Memory-----	1-5
Types of Memory in the Palmtop-----	1-5
Saving Data-----	1-6
Backing Up Data-----	1-6
Terminology-----	1-6
Using Memory Cards-----	1-7
Resetting your Palmtop-----	1-8
Battery-Saving Tips-----	1-9
Application Screens-----	1-9
The Elements of an Application Screen-----	1-10
Controlling the Display Size with ZOOM-----	1-10
PIM Application Views: List and Record-----	1-11
The Date List-----	1-11
The Data Record-----	1-12
Screen Annunciators-----	1-13
Menus-----	1-13
Using Dialog Boxes-----	1-15
The Elements of Dialog Box-----	1-15
Navigating Dialog Boxes and Records-----	1-16
A Look at the Keyboard-----	1-19
Keyboard—Upper Part-----	1-19

Keyboard--Lower Part -----	1-20
Cancel and Undo Operations -----	1-21
Selecting Items in Lists -----	1-21
Deleting Items in Lists -----	1-22
Standard Menu Commands -----	1-22
Using File Commands-----	1-23
Specifying Files-----	1-23
Setting Passwords for Files-----	1-25
Searching for Specific Text-----	1-25
Copying or Moving Information -----	1-26
The Clipboard: Copying, Cutting, and Pasting-----	1-26
Smart Clip: Copying Multiple Data Fields from Records -----	1-28
Getting Answers Fast: Online Help-----	1-31
What About Games?-----	1-32

2 About 1-2-3

Differences Between 1-2-3 on the Palmtop and 1-2-3 Release 2.4 on the PC -----	2-2
Additions to 1-2-3 on the Palmtop-----	2-2
Deletions from 1-2-3 on the Palmtop -----	2-2
Modifications to 1-2-3 for the Palmtop -----	2-3
About Configuration Settings-----	2-4

Part 2. Personal Information Management

3 The Appointment Book

Scheduling Appointments-----	3-2
Types of Appointment Lists -----	3-8
Changing the Current Date-----	3-12
Editing and Deleting Appointments -----	3-13
Running a Program or System Macro at a Certain Time--	3-15
To-Do Lists -----	3-16
Using Multiple Appointment Books-----	3-18
Translating appointment Books -----	3-19
Setting Options and Defaults for the Appointment Book -	3-19
Appointment Book Function Keys-----	3-23

4 The Phone Book and the Database

About the Phone Book Application-----	4-1
Adding to and Editing a Phone Book-----	4-2

Searching a Phone Book-----	4-4
Using Multiple Phone Books -----	4-5
Quick-Dialing from the Phone Book -----	4-5
Translating Phone Books-----	4-5
Creating your Own Database -----	4-6
About Database Structures-----	4-7
Defining a New Database Structure -----	4-10
Modifying a Database Definition -----	4-14
Modifying the DataCard -----	4-15
Searching a Database -----	4-16
Sorting Data Lists -----	4-16
Rearranging the Columns in Data Lists -----	4-17
Defining Subsets of a Database -----	4-18
Displaying Existing Subsets -----	4-19
Defining a New Subset -----	4-19
Using the Category Field -----	4-21
Using Multiple Criteria in a Subset Definition -----	4-23
Editing or Deleting Subset Definitions -----	4-25
Advanced subset Selection-----	4-25
SSL Syntax-----	4-26
Relational Operators-----	4-26
Boolean Operators -----	4-27
Comparison of SSL and Define Subset Screen ---	4-28
SSL Examples -----	4-29
Limits While Using the Phone Book and Database -----	4-30
Phone Book and Database Function Keys -----	4-30

5 World Time

City lists -----	5-1
Specifying your Local City-----	5-2
Adding a City to World Time-----	5-3
Editing or Deleting a City -----	5-5
Creating your Own City list (Custom Cities) -----	5-5
Using the Map -----	5-6
Converting Times Across Time Zones -----	5-7
About the Settings for Daylight Savings Time-----	5-8
Using Subsets of the City List -----	5-9
Copying or Moving Information -----	5-10
Limits While Using World Time-----	5-10
World Time Function Keys-----	5-11

6 The Stopwatch

7 The Memo Editor

Creating a Memo	7-2
Saving Memo Files	7-3
Saving Memos as ASCII Text Files	7-4
Settings for Saving Memo Files	7-5
Password Protection for Memos	7-5
Formatting a Memo	7-6
Editing or Reading a Memo	7-7
Copying or Deleting Information	7-9
Smart Clip: Copying Multiple Fields From Records	7-9
Deleting, Copying, or Inserting Memos	7-10
Searching a Memo File	7-11
Options for Displaying the Memo	7-11
Using Outline-Style Numbering	7-13
Starting Outline (Hierarchical) Numbering	7-14
Editing Existing Outlined Text	7-15
Printing a Memo	7-15
Setting Up Printing Information	7-16
Memo Editor Function Keys	7-18

8 The Note Taker

Creating a Note	8-2
Editing or Deleting Notes	8-3
Changing the DataCard	8-4
Searching the Note Taker	8-5
Using Multiple Note Taker Files	8-6
Using Subsets of the Note Taker	8-6
Limits While Using the Note Taker	8-6
Note Taker Function Keys	8-7

Part 3. Pocket Quicken

9 Pocket Quicken Basics

About Files and Accounts	9-1
About Categories and Groups	9-4
What's a Category?	9-5
What's a Group?	9-6
Use the Group Field for Expense Reporting	9-8
Using the Register	9-9

Entering Transactions-----	9-10
The Add Transaction Screen -----	9-10
Using QuickFill and QuickKeys -----	9-14
Splitting Transactions -----	9-14
Transferring Money between Accounts-----	9-15
Changing your Entry Preferences-----	9-16
Sharing Data with Desktop Quicken-----	9-17
Using the Connectivity Pack to Merge or	
Synchronize Quicken Files -----	9-17
Importing and Exporting Pocket Quicken Files -----	9-17
Disk Space -----	9-19
10 Balancing your Pocket Quicken Checkbook	
The General Reconciling Procedure-----	10-1
Balancing your Account for the First Time -----	10-2
Reconciling the Account-----	10-3
Solving Problems-----	10-4
Correcting Differences -----	10-4
Having Pocket Quicken Adjust for Differences -----	10-5
Updating Your Previously Reconciled Balance -----	10-6
Adding Earlier Transactions to Pocket Quicken-----	10-7

11 Creating and Printing Pocket Quicken Reports

Part 4. The HP Financial Calculator

12 Calculator Basics and Math Functions

Simple Arithmetic-----	12-2
About the Calc Line-----	12-2
The Calculator Keyboard-----	12-3
Operator Priority-----	12-5
Percent -----	12-6
Other Keyboard Arithmetic -----	12-6
Using the Automatic Constant in Calculations-----	12-7
Storing and Recalling Numbers -----	12-8
Using the History Stack-----	12-8
Using Registers-----	12-10
Moving Values Between the Calc Line and 1-2-3-----	12-12
The Point-and-Shoot Method of Data Entry-----	12-12
Clearing Information from Calculator Memory -----	12-14
Using RPN with the Calculator-----	12-14

Technical Math Functions-----	12-15
13 Business percentage calculations	
14 Time value of money and interest conversions	
The TVM Screen -----	14-1
Making TVM Calculations-----	14-3
Calculating Amortization -----	14-7
Sending an Amortization Table to 1-2-3 or a Printer ---	14-13
Calculating Interest Rate Conversions -----	14-15
If Compounding and Payment Periods Differ-----	14-16
Additional TVM Examples -----	14-18
Yield of a Discounted (or Premium) Mortgage----	14-18
Loans with Fees -----	14-20
A Tax-Free Account-----	14-22
A Taxable Retirement Account-----	14-24
15 Uneven Cash Flow Calculations	
NPV and IRR%: Discounting Cash Flows-----	15-1
Making Cash-Flow Calculations -----	15-2
The Cash-Flow Function Keys -----	15-3
Uneven Cash Flow Examples-----	15-3
Plotting-----	15-8
16 Currency and Other Unit Conversions	
Converting Currencies-----	16-1
Changing the List of Currencies -----	16-2
Converting Other Units-----	16-3
17 Statistics	
Entering and Editing Data-----	17-1
Saving Statistical Data in a File-----	17-2
Statistics Calculations -----	17-3
Curve Fitting and Forecasting -----	17-5
Plotting the Curve Model for your Data -----	17-8
18 Date Calculations	
19 Using the Solver and Function Plotting	
The Solve Catalog-----	19-1
Entering and Editing Equations-----	19-2

Calculating with Your Solver Equations	19-5
Clearing and Deleting Solver Equations and Variables	19-5
Solve Catalog Function Keys	19-7
Using Multiple Equation Lists.....	19-7
Using the Solver in a 1-2-3 Worksheet.....	19-8
How the Solver Works.....	19-11
Halting and Restarting an Iterative Search.....	19-12
Entering Guesses.....	19-12
Rules for Writing Equations	19-13
Length of Equations	19-13
Variable Names	19-13
Constants	19-14
Functions	19-14
Operators, Parentheses, and the Order of Calculations	19-14
Date Formats.....	19-15
Solver Functions.....	19-15
Typing Aids for Solver Functions.....	19-21
Conditional Expressions (IF Function).....	19-22
Order of Logical Operations.....	19-22
Creating Function Keys for Multiple Equations (S Function).....	19-23
The TVM Functions.....	19-24
The Summing Function (SIGMA)	19-25
Examples of Solver Equations.....	19-26
Simple Annual Interest.....	19-26
Advance Payments (Leasing)	19-27
Discounted Notes	19-28
Moving Average	19-29
Simulating a Toss of Dice	19-31
Distance between Two Locations	19-32
Finding Several Solutions to an Equation	19-33
Creating Solver Files on a PC or Another Editor	19-35
Function Plotting	19-36
How Function Plotting Works.....	19-42
Selecting the Expression to Plot	19-42
Setting the Plot Conditions	19-43
Interacting with the Graph.....	19-44

- 20 Configuring and Customizing the Calculator**
- Configuration Options ----- 20-1
- Creating Your Custom Calculator Application ----- 20-2

Part 5. System Management

- 21 The Setup Utility**
- Setting the Date and Time ----- 21-2
- Specifying Audio Volume and Display Intensity ----- 21-3
- Allocating Memory between System RAM and the RAM
 Disk for 200LX 1MB and 2MB ----- 21-4
- Allocating Memory within System RAM for 200LX 1MB
 and 2MB ----- 21-5
- Changing Country Defaults, Punctuation, Currency, and
 Code Page Settings ----- 21-6
- Specifying the Sorting Order for Lotus 1-2-3 ----- 21-8
- Specifying a Topcard or Picture Display ----- 21-8
- Closing Com1 to Save Power ----- 21-9

- 22 The Filer and File Management**
- Take Care of Your Data ----- 22-2
- Working with Files ----- 22-2
- Viewing a Directory ----- 22-5
- Changing the Current Directory ----- 22-8
- Using Plug-in Memory Cards ----- 22-8
- Backing Up a Directory's Files ----- 22-9
- Directories and File Name Extensions Used
 By Palmtop Applications ----- 22-10
- Using the Split Screen ----- 22-11
- Transferring Files between Your HP 200LX
 and Another Computer ----- 22-12
- Transferring Files Using an IR Connection ----- 22-12
- Transferring Files between an HP 100LX
 and an HP 200LX ----- 22-14
- Transferring Files between an HP 95LX
 and an HP 200LX ----- 22-15

- 23 System macros**
- Creating system Macros ----- 23-1
- Creating Macros that Execute Other Macros ----- 23-3
- Saving and Opening Sets of System Macros ----- 23-4

Clearing (Deleting) System Macros	23-4
System Macros and Lotus 1-2-3.....	23-5
System Macros Examples	23-5
24 Managing your applications	
Installing Applications.....	24-1
Icons View and List View of Applications	24-3
Starting, Quitting, and Deleting Applications.....	24-4
Managing Memory.....	24-5
Types of Memory	24-5
Determining Memory Usage	24-6
Maximizing System RAM.....	24-6
25 MS-DOS in Your Palmtop PC	
Accessing the DOS Prompt	25-1
Files and Directories	25-3
DOS Commands in your Palmtop.....	25-5
Standard DOS Commands	25-6
Special utility Commands	25-8
Support Country NLS Defaults	25-11
How to Use KEYBEZ.....	25-11
Installing DOS Applications.....	25-13
Tips on Running DOS Applications	25-14
Controlling the Appearance of a DOS Display	25-16
Customizing your system	25-17
About the MS-DOS Startup Procedure	25-17
Boot (Reset) Options	25-18

Part 6. External Communications

26 Datacomm	
Configuring for Datacomm	26-2
Using Configuration Files	26-5
Preparing your Hardware.....	26-6
Making Serial Connections	26-6
Beginning and Ending a Communication Session.....	26-9
Customizing your Display for Datacomm	26-10
Capturing Data in a File.....	26-11
Automating Datacomm Procedures.....	26-12
Transferring Files.....	26-13
Character Translation between Code Pages	26-14

27	Using a Modem with Your Palmtop PC	
	Equipment you Need-----	27-1
	Connecting to a Serial Modem -----	27-2
	Connecting to a Card Modem -----	27-2
	Using a Card Modem in the Plug-in Slot-----	27-3
	About Batteries and Card Modems-----	27-3
28	Using a Printer with your Palmtop PC	
	Equipment you Need-----	28-1
	Preparing to Print using Serial Connection -----	28-2
	Preparing to Print using Infrared -----	28-2
	Printing-----	28-2
	Printing from PIM Applications-----	28-3
	Printing to a File (Creating an ASCII Data File) ----	28-5
	Setting up Printing Information (Setup) -----	28-5
29	cc:Mail	
	About cc:Mail-----	29-1
	What you Need to Make it Work -----	29-1
	Starting cc:Mail the First Time-----	29-2
	Receiving and Reading Messages-----	29-3
	Replying to Messages-----	29-4
	Creating and Sending Messages-----	29-4
	About Folders -----	29-5
	About Address Books and Mailing Lists-----	29-6
	Addressing Options -----	29-10
	Managing your Messages -----	29-11
	Printing in cc:Mail -----	29-13
	Importing and Attaching Files to a Message -----	29-13
	Changing your Communication Settings-----	29-14
	Understanding cc:Mail's Host-----	29-15
	Understanding cc:Mail's Prefix-----	29-15
	Creating another Modem File-----	29-16
	Using an Interactive Connection to the Post Office -----	29-18
30	Using Laplink Remote Access	
	What you Need to Make it Work -----	30-1
	Running Laplink Remote Access on your Palmtop -----	30-2

Part 7. Appendixes and Index

A Warranty, Support, and Service

Limited One-Year Warranty-----	A-1
What is Covered-----	A-1
What is not Covered-----	A-1
Customer Support -----	A-2
If your Palmtop Requires Service-----	A-3
HP Marketing Headquarters Outside the U.S.-----	A-3

B Batteries and environmental limits

Removing and Installing Batteries-----	B-2
Rechargeable Batteries -----	B-4
AC Adapter Information -----	B-6
Environmental Limits for your Palmtop and Plug-in Cards-----	B-6

C Character set

Character Set Tables-----	C-1
Generating Special Characters -----	C-4

D South and East European Language Support

How to Access Character Sets and Keyboard Layouts --	D-1
Running KEYBEZ-----	D-2
Printing Considerations-----	D-3
Keyboard Overlays & Code Page Tables -----	D-3
Greek and Cyrillic Overlays-----	D-4
Hungarian and Polish Overlays -----	D-5
Slavic and Turkish Overlays -----	D-6
CP 437G (PC Latin/Greek)-----	D-7
CP 437T (PC Turkish)-----	D-8
CP 852 (PC Latin-2)-----	D-9
CP 866 (PC Cyrillic) -----	D-10

E Regulatory Information

F Games

Part 1

Getting Started

Getting Started

Before You Begin. Install the batteries, adjust the display contrast, set the time and date, and fill out the Topcard as described at the beginning of the *Quick Start Guide*.

A Look at Your Palmtop PC

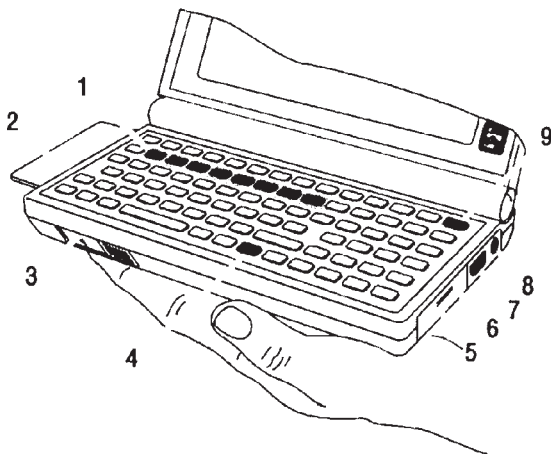

- | | |
|--------------------------------|--|
| 1. Application keys | 6. IR port (Infrared radiates through the plastic) |
| 2. Plug-in card slot (drive A) | 7. Serial port |
| 3. Card-eject slide switch | 8. AC adapter jack |
| 4. Menu key | 9. ON/OFF key |
| 5. Backup battery cover | |

1 Hardware Features

Among the palmtop PC's hardware features are

- A rugged “clamshell” design, which protects the keyboard and display when you're on the go.
- A CGA-compatible, 80× 25 character display with a “zoom” capability for text-based applications.
- A PCMCIA release 2.0, type II plug-in card slot.
- An Infrared (IR) port for wireless communications.
- A serial port for communications to a PC, modem, printer, or other serial device.
- A typewriter keyboard layout with a “sticky” shift key—you don't need to hold down  while you press another key; you press it to activate it and then press the other key. Shifted key definitions are shown in orange on the keyboard.

Software Features

The second row on the palmtop keyboard contains a set of green application keys.

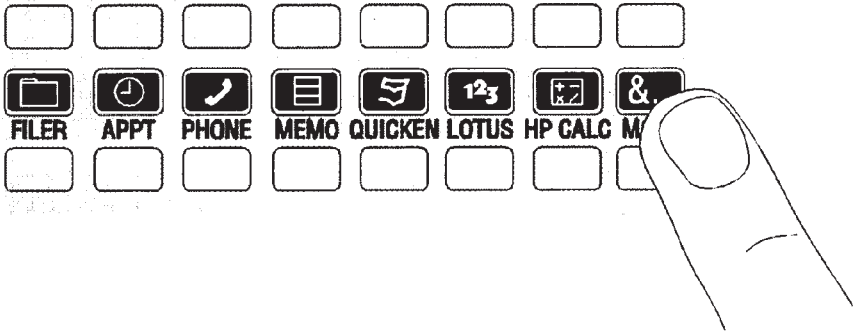

Green Application Keys

These keys enable you to run the built-in applications. The last key in the row, , gives you access to additional built-in applications that show up in the display.

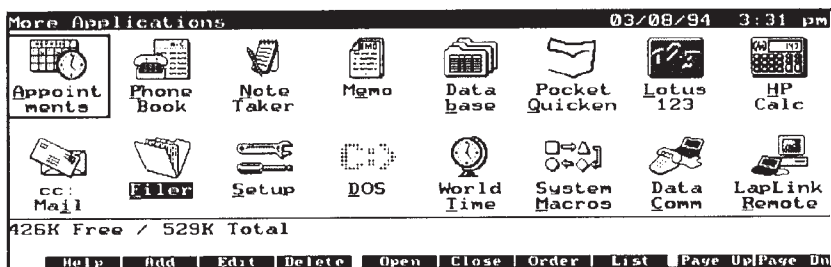

More Applications Screen

Use **(F10)** (Page Dn) to see additional applications.

The Built-in Applications

Press	To Start	Press	To Start
	The Filer	S	The Setup Utility
	Pocket Quicken	C	Datacomm
	The Appointment Book	W	The Stopwatch
	The Phone Book	B	The Database
	The Memo Editor	N	The Note Taker
	Lotus 1-2-3	D	MS-DOS
	The Calculator	T	World Time
	Applications Manager	M	System Macros
		I	cc:Mail
		R	LapLink Remote
		+	Hearts+Bones
		U	Lair of Squid
		O	Demo program

Note

Help is always available within any application by simply pressing the **(F1)** key (**(CTRL)+(F1)** in Datacomm). Because it's built in, the help system is a portable quick-reference guide.

To quit an application, press **(MENU)** **(Q)**. It is not necessary to quit one application before starting another, but quitting applications helps free up system memory.

Activating Password Protection

You can protect your entire palmtop from being used by other people by setting a password. Setting passwords for individual files is covered under “Setting Passwords for Files” later in this chapter. You can set a machine-locking password to work in one of two ways:

- **Auto-lock mode.** Whenever the palmtop is turned off, times out, or is reset by a system reset, you must enter the password before you use it.
- **Manual-lock mode.** Turn the palmtop off by pressing **[ON] + [ENTER]**—hold down **[ON]**, press and release **[ENTER]**—to activate password protection. When the palmtop times out, is reset, or is turned off by just pressing **[ON]**, you *do not* need to enter the password to use the machine.

When password protection is activated and you turn on your palmtop, you must respond to the prompt by typing your password and pressing **[ENTER]** before you can use the unit.

Rules for the password:

- It will be case-sensitive.
- It can have up to 12 characters.
- You can use only the lower 128 characters in the character set. These are generally the characters on the keyboard. For a complete list of these characters, see *Appendix C*.
- You cannot use control characters.

Caution

- Be sure to record your password in a safe place. To resume operation if you forget it, you'll need to perform a hard reset as described on page 1-8. Please note that this will erase all data on drive C and all settings will be reverted to their default states.
 - If you use the KEYBEZ utility to remap the keyboard, take care to choose a password that won't be affected by the remapping.
-

To set or change a password:

1. Press **[F5]** **[D]** to start the DOS application.
2. Type **PASSWORD** and press **[ENTER]**.

3. Follow the instructions on the screen. (Remember to press **ENTER** after each response to a prompt.) When you are told to verify your password, simply type it again.
4. Type **EXIT** and press **ENTER** to quit DOS.

When you first set a password, it is automatically implemented in manual-lock mode—password protection is activated only when you turn off your palmtop by pressing **ON**+**ENTER**. You can change this to auto-lock mode, or deactivate password protection altogether, by following the next procedure.

To change the mode or deactivate password protection:

1. Press **&...** **D** to start the DOS application.
2. Do one of the following:
 - a. Type **PASSWORD /A** to implement auto-lock mode.
 - b. Type **PASSWORD /M** to implement manual-lock mode.
 - c. Type **PASSWORD /D** to deactivate password protection.
3. Press **ENTER**. (If you're deactivating password protection, you'll need to enter the old password at this point.)
4. Type **EXIT** and press **ENTER** to quit DOS.

Managing Memory

Types of Memory in the Palmtop

ROM. Permanent memory that contains the built-in applications and that cannot be erased or overwritten. ROM contains a permanent **ROM disk**, which is designated drive D.

System RAM. Workspace for open applications. Open spreadsheets and memos that haven't been saved reside here.

RAM disk. Storage space for saving files when you're done working on them. The RAM disk is designated drive C and is used just like a hard disk on a PC.

Memory cards. Plug-in memory for additional storage space for data and programs. The plug-in slot is designated drive A, and memory cards are used like floppy disks on a PC.

1 Saving Data

Data that you enter using most of the palmtop applications is saved *automatically* when you enter it. The stored file (either on drive A or C) is changed as you edit it.

However, in 1-2-3, the Memo Editor, the Calculator, and System Macros a stored file is not changed until you formally save changes. A worksheet or memo is copied into system RAM where it is edited. When it is saved, the changed copy is moved back to drive A or C and, unless you save it under another name or path, it overwrites the original copy.

All palmtop applications follow standard MS-DOS conventions for file and path names.

Note Your palmtop contains a directory on drive C called ..DAT. You should not remove or rename this directory because it is used by several of the built-in applications.

Backing Up Data

It's a good idea to regularly back up drive C like you would any PC hard disk. Use the Filer to copy the files to a memory card or, if you have the Connectivity Pack, to a PC. The backup procedure is described under "Backing Up a Directory's Files" in chapter 22.

Terminology

Active application. The topmost open application—the one being displayed.

Current file. The current file in a given application is the open, displayed file.

Open application. An open application (started by pressing its green application key) is open until you explicitly quit it—even if it is not displayed because other applications are open also. As long as an application is open, it uses system RAM.

Opening a file. When a stored file is opened in an application, you can view and modify it.

Quitting (or closing) an application. When you quit an application it is no longer open and therefore uses no system RAM.

Saving a file. When you save a file, it is stored in the directory under the name you specify.

Saving changes. When you save changes to a memo, 1-2-3 worksheet, system macro, or Calculator file, any existing file of the same name and path is updated. Changes to files in the other palmtop applications are automatically saved as you make them.

Using Memory Cards

Your palmtop supports PCMCIA 2.0 type I or type II memory cards, which enable you to significantly expand data and program storage. Terms you sometimes hear that refer to memory cards include **mass storage cards**, **PC cards**, **flash cards**, **flash disks**, and **RAM cards**.

A memory card plugged into your palmtop is designated drive A, and you use it just like you would use a floppy disk on your PC.

At the time of this writing, HP provides three flash memory cards (called Flash Disks) for your palmtop: the HP F1012A (5 MB card), the HP F1013A (10 MB card), and the HP F1014A (20 MB card). See your dealer for purchase information.

To insert and remove a card:

Caution	Be sure to turn off the palmtop before inserting or removing a plug-in card. Otherwise, data loss could result.
----------------	---

To insert a card, hold it with the logo on top and push it in the slot on the left side of the palmtop until it won't go in any further. A fully-inserted card is flush with the palmtop case. To remove a card, slide the card-eject switch to the left.

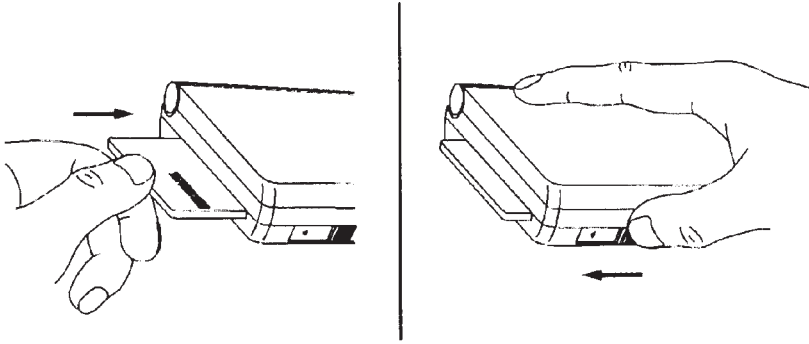

Inserting and Removing a Card

Resetting Your Palmtop

If your palmtop fails to respond to keystrokes or otherwise behaves unusually, you should do a **system reset** (also called **rebooting** the computer). **Do not remove the batteries.**

Caution A system reset erases the contents of system RAM (but not the RAM disk). Therefore, any data not already saved will be lost.



You perform a system reset by pressing **CTRL**+**ALT**+**DEL** (that is, holding down **CTRL** and **ALT** and then pressing **DEL**).

If a system reset doesn't work, as a last resort you can attempt a **hard reset** by simultaneously pressing **CTRL**+**ON**+**↑** (the gold arrow). You will be asked whether or not you want to initialize the RAM disk, which erases its contents. If you type y (for yes) and press **ENTER**, a hard reset will occur *and all data is lost*; if you type n (for no) and press **ENTER**, a system reset is attempted.

Caution A hard reset erases the contents of system RAM and the RAM disk. *All data on drive C (the RAM disk) will be lost.* Also, settings changed via the Setup Utility (for example, battery charging) will revert to their default states.

If resetting your system as described above doesn't fix your problem, contact Customer Support as described on the inside back cover of this manual.

Battery-Saving Tips

- Use rechargeable batteries as described in appendix B.
- Use the AC adapter (HP F1011A) whenever possible.
- Quit Datacomm and the Filer (press  ) when you're not using them. These applications use the serial port and therefore require slightly more power than the other applications.
- When you see the message telling you that the main batteries are low, replace them (or recharge them) as soon as possible. This will help you get the most out of your backup battery. See appendix B for instructions on changing batteries.
- Always install fresh, high quality batteries (all of the same brand).
- Remove high-current plug-in cards—this does *not* include memory cards—when you're not using them. For example, plug-in modem cards are notorious for draining batteries quickly, *even when you're not using the modem*. Therefore, be sure to take out a modem card when you're not using it, and when you are using it, use the AC adapter.

Application Screens

To start an application:

- Press its green **application key**.
- If the application is not on the keyboard, press , then press the underlined letter as shown.

To quit an application:

- Press  .

1 The Elements of an Application Screen

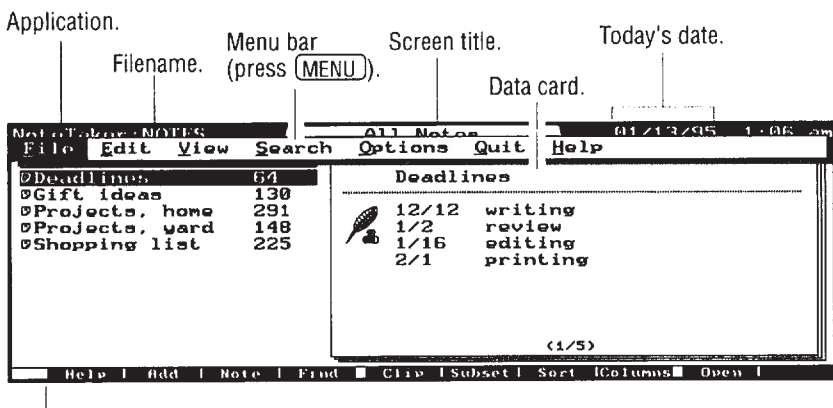

Function-key labels for **F1**–**F10**.

An Application Screen

- **Screen title** identifies the particular screen.
- **Menu bar** displays the menu of commands. Press **MENU** or **ALT** to display the menu bar. (If the computer beeps, you need to press **ESC** first.)
- **Function-key labels** show current functions for keys **F1** to **F10**.

Controlling the Display Size with ZOOM

To change the size of the characters:

- Press **F9** ZOOM (that is, **F9** then the **spacebar**) to change the size of the displayed characters in text-based applications, such as the Memo Editor and 1-2-3. ZOOM cycles through three different display sizes (1-2-3 uses only the first two):
 - **80 columns × 25 lines**. This fits as much information on the palmtop display as on your PC display. It produces the smallest characters.
 - **64 columns × 18 lines**. This is the only size for most built-in applications.
 - **40 columns × 16 lines**. This produces the largest characters.

PIM Application Views: List and Record

The palmtop Personal Information Management (PIM) applications (Appointment Book, Phone Book, Note Taker, Database, World Time) present information in two major **views**:

- **The data list** summarizes each record with a one-line entry.
- **The data record** shows you all the information for one **item** (list entry). For instance, an appointment record contains everything about your 10:00 appointment (when, where, how long, what for, and so on).

The Data List

This lists the data records in the current application file. Each record has a one-line entry.

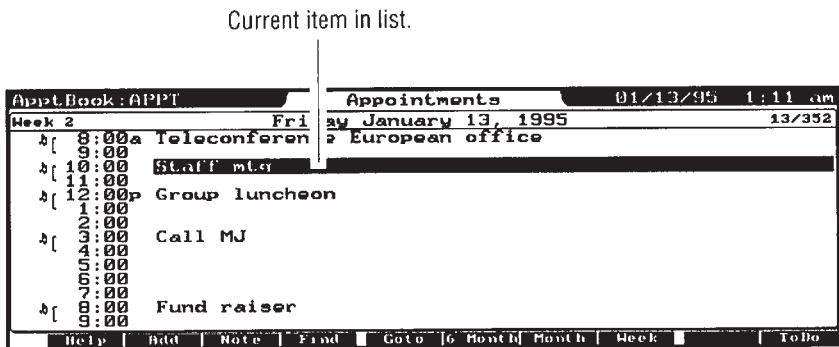

An Appointment List

- Use **▲** and **▼** to highlight any item and scroll through the list. To jump further, use **Fn** HOME, **Fn** END, **Fn** PG UP, and **Fn** PG DN.
- Press **ENTER** to display the complete record of the highlighted item.
- Press **F2** (Add) to add a new item.

The Data Record

The record defines each item in detail. The data appear in labeled fields.

Field name. Text box.

The screenshot shows a window titled 'Appointment/Event' with the following fields and labels:

- Field name:** Points to the 'Description' field containing 'Staff mtg'.
- Text box:** Points to the 'Start Time' field containing '10:00am'.
- Note Field:** Points to the 'Note' field containing 'Bring report on construction.'
- Pressing [F10] saves the record as is and closes it.** Points to the 'Repeat' button in the bottom right corner.



Other visible fields include: Start Date (1/13/1995), End Time (11:00am), No. Consecutive Days (1), Location, Alarm (Enabled), Leadtime (5), Views (Week, Month), and Repeat Status (None). The bottom menu bar includes: Help, Add, Note, Find, Clip, Calendar, Repeat, Cancel, Done.

An Appointment Record

- Use **TAB** or **↑ TAB** to move from field to field.
- Press **ALT**+underlined letter to move directly to a field. In the above example, **ALT+N** moves the cursor to the Note field.
- Press **F10** to save and close the record.
- Press **ESC** or **F9** to cancel changes to a record.
- The Note field provides an area for text entry and editing. Pressing **F3** (Note) provides a full-screen area for text editing.

Screen Annunciators





Annunciators displayed on the screen indicate certain conditions that are in effect.

Annunciator	Meaning	Location
↑	The  shift is on.	Lower corner. ¹
✳	The  shift is on.	Lower corner. ¹
⌘	Insert mode. Cursor shows underlying character.	
⌘	Replace mode. Cursor hides underlying character.	
	End of text field.	Cursor.
_ (underscore)	Cursor for 1-2-3.	
▲	Caps Lock is on.	Lower corner. ¹
⌘	Busy. The palmtop is processing information.	Center.

¹ Lower right for 1-2-3 and DOS screens; lower left for other applications.

Menus

There are three ways to perform palmtop operations:

- Using **keys** that perform operations, like  and .
- Using **function keys** ( through ) , which perform the operations shown on the current **function-key labels**.
- Using menu **commands**, which appear in **pull-down menus** under the menu bar.

All commands appear in menus. Most of the more common ones also appear on function-key labels. Many others are on the keyboard.

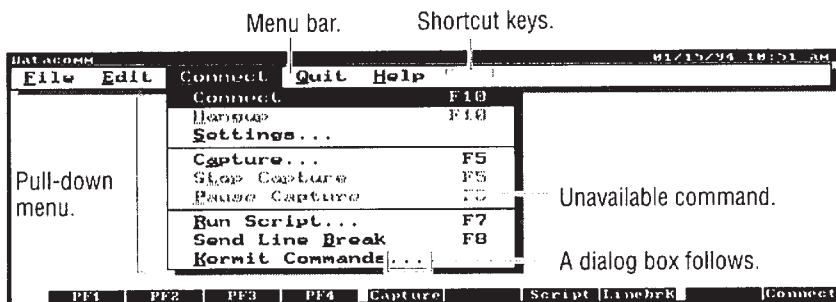

Function-key labels.

Menu Commands and Function Keys

- **Menu bar.** Press **CTRL** or **ALT** to display it. To select a command, press the underlined letter key (press **F** for File, for example) or highlight the command (press an arrow key) and press **ENTER**.
- **Pull-down menu.** Shows the commands under the menu item. To select a command, press its underlined letter.

Unavailable command. If a command appears dimmed (“grayed”), then it is not available at this time.

Ellipsis (...). This command will display a **dialog box** to solicit more information.

Shortcut keys (hot keys). You can press these keys *instead of* displaying menus and selecting commands. For instance, pressing **F5** in Datacomm is a shortcut for **CTRL** **C** **A** (Connect Capture).

- **Function-key labels.** The currently active functions for the corresponding top-row keys **F1** through **F10**.

To scan the menu commands:

1. Press **CTRL**.
2. Press **ENTER** to pull down the first menu.
3. Press **▶** to move across the main menu, displaying each pull-down menu.

This gives you an overview of the features available in an application.

To cancel a menu:

- Press **ESC**.

This returns the previous display.

Using Dialog Boxes

Dialog boxes appear in response to certain commands or functions that require more information from you. A dialog box appears shaded and on top of its parent screen, indicating that it arises from a broader context.

If you are asked for information, you can specify it by typing it in or by selecting an option from a list box. Labeled function keys are available for certain standard responses.

The Elements of a Dialog Box

Option buttons. Current field. List box (unopened).

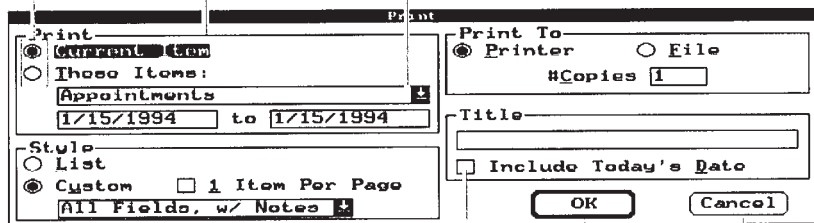

Check box. Command buttons.

A Dialog Box: Print Specification

- **Current field.** Your current position is shown by a highlighted field or by a cursor in a box.
- **Option buttons.** Options in the same group box are mutually exclusive, so you can select only one. An option button might include a list box for further choices.

- **List box.** A list box offers a list of choices. **Drop-down** list boxes initially are closed, as in the picture above. A closed list box shows one line—the current selection.
- The  indicates a **list box** that you can open to display more lines. When the cursor is in this field, press **(ALT)+(▼)** simultaneously to open it. (**(ALT)+(▲)** closes it.)
- **Check Box.** Select as many check boxes as you want.
- **Text box.** You can type information here. The top box in a list box is also a text box, but some list boxes are not editable (changeable).
- **Function keys.** The functions change with the context, except for **(F1)** (Help), **(F9)**, and **(F10)**. Press **(F10)** (OK) when you are finished filling out the dialog box. Or press **(F9)** (or **(ESC)**) to cancel any changes.
- **Command buttons.** These are large, rounded boxes for OK, Cancel, and a few other commands. *All command buttons are also available as function keys.*

Navigating Dialog Boxes and Records

To move to a field (in a record or a dialog box):

- From *any* field, simultaneously press **(ALT)+underlined letter**.
or
- Tab to the field (**(TAB)** or **(↑) (TAB)**).

To select an option button:

- Simultaneously press **(ALT)+underlined letter**.
or
- Tab to the option-button group, and then arrow to the specific option to turn it on.
- If there is a box next to the option button, press **(TAB)** to move to it and fill it in or make a selection.

To check and uncheck a box:

- Simultaneously press **(ALT)+underlined letter**.
or
- Tab to the check box, and then press **(spacebar)**.

To use a command button:

There is always a default, outlined command button, usually the “OK” button.

- Press **ENTER** to execute the default command button.
or
- Press the corresponding function key (such as **F10** for OK).
or
- Press **ALT**+underlined letter simultaneously.
or
- Tab to a different command button and press **ENTER**.

To use a list box:

List boxes offer a choice of options. Some list boxes are editable; that is, you can add your own choices.

- Select the list box first, such as by tabbing to it.
- To open a list box, simultaneously press **ALT**+**▼**. (**▼** stands for **ALT**+**▼**, just as an underlined letter stands for **ALT**+letter.)
- To scroll through a list box, press **▼** or **▲**. This automatically changes the selection shown in the text box on top.
- To quickly locate an item in a *non-editable* list box, type its first letter (or more). The highlight bar moves to the next item starting with that letter. (If the list box is editable, then typing edits it.)
- To close a list box, press **ALT**+**▲** or **ESC**.

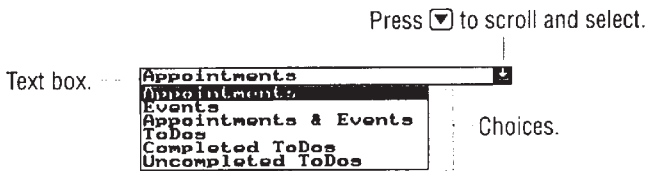

An Open List Box

To complete or exit a dialog box record:

- Press **(F10)** to save what you've specified.
or
- Press **(ESC)** or **(F9)** (Cancel) to cancel what you've specified.
or—in a dialog box only—
- Press **(ENTER)** to execute the command button that is “on” (highlighted). (Record screens have no command buttons.)

Example: Practice Filling In a Dialog Box. You can practice the techniques described in this section by calling up a File Print dialog box. Record screens have many of these same elements.

1. Press **(⌘)** **(⌘)** **(F)** **(P)** for the Appointment Book's File Print dialog box.

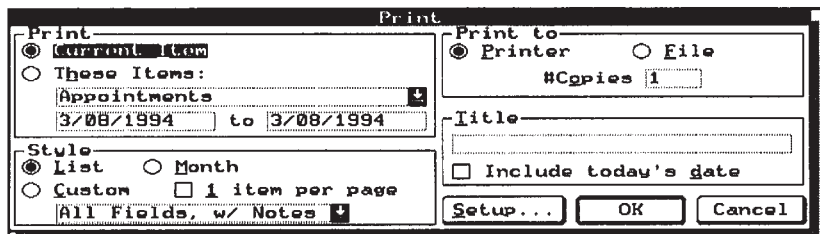

2. Practice navigating and filling in the fields.
3. Practice turning on option buttons, marking check boxes, opening a list box, and scrolling through it.
4. Press **(ESC)** to cancel what you've done.
5. Press **(⌘)** **(Q)** to quit the application.

A Look at the Keyboard

These diagrams of the keyboard call out keys with special functions.

Keyboard—Upper Part

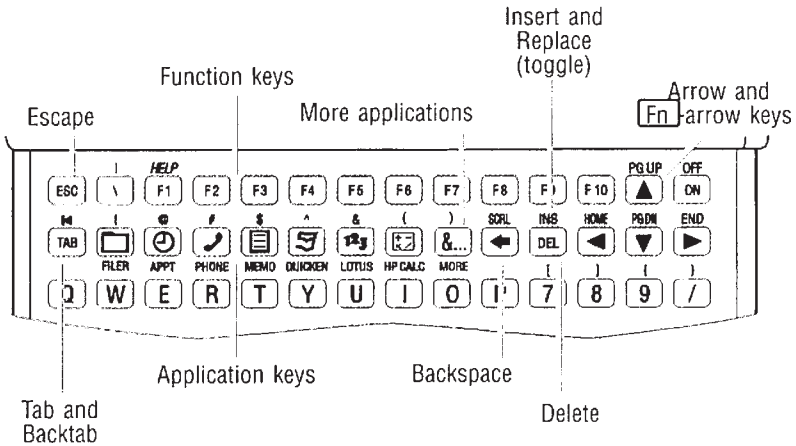

Escape (**ESC**). Cancels or “backs out” of the current context.

Function keys. (**F1**) is always **HELP**. The other function keys change their operations according to the labels along the bottom of the screen. (Some external applications may use (**F11**) and (**F12**), accessed as (**Fn**) (**1**) and (**Fn**) (**2**).

More (**&...**). Provides access to all applications.

Insert (**Fn**) (**DEL**). Toggles between text-overwrite and text-insert.

Arrow keys. Move the cursor in text or move the highlight bar in a list of items. The (**Fn**)-shifted arrow keys move the cursor or bar further: to the top of the file or the beginning of a line (**HOME**), to the bottom of a file or end of a line (**END**), or by pages (**PG UP**, **PG DN**).

Tab and backtab (**Fn**) (**TAB**). Move the cursor among data fields, such as when you are filling in fields of information.

Application keys. Immediately start the specified application.

Delete (**DEL**). Deletes a character at the cursor or a highlighted item in a list.

Keyboard—Lower Part

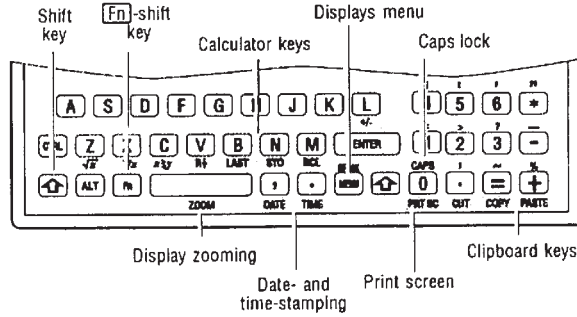

Keys:

Caps Lock (⇧ 0)

MENU

Calculator keys

Shift

Function shift

ZOOM

Date and Time
stamping

Clipboard keys

Description:

Toggles capitalization on and off.

displays the current menu of commands.

ALT doubles for MENU except in 1-2-3, where 7 is used.

In the Calculator application *only*, these keys are redefined by the symbols in white underneath them. These are *not* shifted.

Operations and characters printed in orange *above* the keys are shifted. Press ⇧ first, then the key. You do *not* need to hold ⇧ down while pressing the second key. To cancel the shift mode, press ⇧ again.

Operations printed in purple *below* or *above* the keys are Fn-shifted. Press Fn first, then the key. You do *not* need to hold Fn down while pressing the second key. To cancel the shift mode, press Fn again.

Switches the resolution of the display. The effect varies from application to application.

Insert the current date and time into the current text line in built-in applications.

Cut, copy, or paste selected items or text and save them in the Clipboard buffer.

Cancel and Undo Operations

Key or Command	Description
ESC	Cancels the current activity and restores the previous screen.
Cancel (F9)	Cancels dialog boxes without taking any action. Also closes open records without saving new information.
Break (CTRL +BREAK)	Sends a standard PC break.
Quit (END Q)	Closes the current (active) application.
Undo (END E U)	Reverses the last data-altering or file-altering action, such as deleting, editing, cutting, or pasting records, or merging files. Undo does not work in all situations; check the Edit menu for it. You can also undo an undo operation.

Selecting Items in Lists

Some operations can act on more than one item in a list at a time. You can, for instance, delete several Phone Book entries at a time by first **selecting** and then deleting the desired items (names).



You can **select** items in most lists of records or files.

Selecting and De-Selecting

Keys	Description
spacebar	Selects or de-selects an item in a list, marking it with a ♦.
↑ spacebar	Selects or de-selects <i>all</i> items in a list.
↑ + ▶	Selects a range in a text field by highlighting it. (Use any arrow key.)



To select items in a list:

1. Highlight the item. (**▲** and **▼** move the highlight bar.)
2. Press **spacebar**. This marks the item with a ♦. (This is a toggle: pressing **spacebar** again de-selects.)
3. Repeat to select more items.

To select all items at once, press  . This is also a toggle.



Deleting Items in Lists

To delete items in a list:

1. Highlight the item. (If you want to delete more than one item, press  to select each item.)
2. Press   to delete all selected items.

Example: Deleting Three Phone Book Items. Select Austin, Brumal, and Davis. (Arrow to a name, then press .)

◆Austin, James	750-9001
Billings, Jane	912-5538
◆Brumal, George	788-2127
Cord, Kenneth	555-8761
◆Davis, Charles	763-9967

Then press   to delete them. This leaves:

Billings, Jane	912-5538
Cord, Kenneth	555-8761

Standard Menu Commands

Every application has its own set of menus. However, there is a core group of menus that is common across most applications, particularly those for Personal Information Management. Because of the different purposes of the different applications, not all the standard commands are in every application.

Pressing  in an application displays its main menu. The **standard menu commands** are:

```
File Edit View Options Quit Help
```

- **File menu:** To manage files, such as opening, copying, and printing.
- **Edit menu:** To edit text or entire records, such as copying, deleting, and undoing.

- **View menu:** To display different portions or perspectives of information, such as subsets, split screens, and mail lists.
- **Options menu:** The options vary widely among applications.
- **Quit:** To exit the current application.
- **Help menu:** To read online Help information.

Many menu commands have alternative access on function keys or keyboard keys. For instance, the Edit menu includes Delete, which is the same as pressing **DEL**.

Using File Commands

Specifying Files

Many File commands in PIM, the Calculator, Pocket Quicken, cc:Mail, and Datacomm ask you to specify a file name to act upon. The palmtop uses standard MS-DOS file naming conventions.

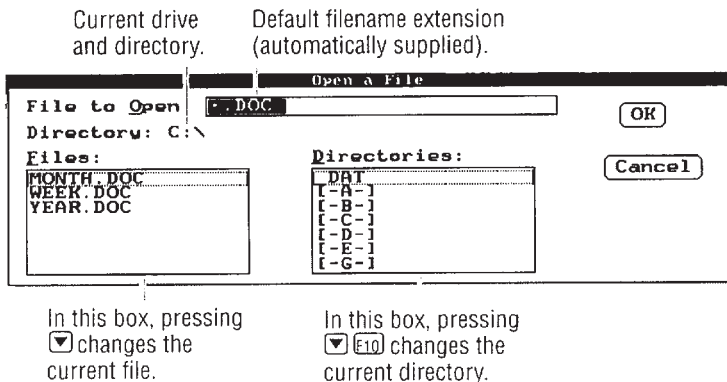

Dialog Box for File Open

To specify the file name in a dialog box:

- Type in the full file name yourself.
or
- Select the file name and/or directory using the Files and Directories list boxes. This is a memory aid if you don't remember all the existing directory and file names. It is also a shortcut to typing.

To type the file name yourself:

1. Type the file name into the file name text box. If the current directory shown below this box is not correct, then type the full path name (*drive:\directory\... \filename*).
2. Press **(F10)**.

To select the file using the list boxes:

- If the Files box shows the file you want, tab to the Files box and highlight the file name. Press **(F10)**.
- If Files does not show the file you want, then check other drives and directories:
 1. Tab to the Directories box and highlight the directory or drive you want. Drive specifications appear as [**-A-**], etc. The parent directory appears as *...*
 2. Press **(F10)** (or **(ENTER)**) to change the current directory or drive and display its files.
 3. If the file you want appears in the Files box, then select the Files box (press **(ALT)+(F)**), highlight the file you want, and press **(F10)**.

To view files in the current directory (wildcards):

You can use wildcards to display all files matching a certain name pattern. The wildcard *** stands for any number of characters. The wildcard *?* stands for any one character.

1. In the file name text box, type the file names you want to search for. For instance, **.doc* stands for all files with the extension *.DOC*.
2. Press **(F10)**. This displays a list of matching files in the Files box.

Setting Passwords for Files

You can protect PIM files, 1-2-3 files, and Pocket Quicken files by using passwords. (To protect your entire palmtop from being used, see “Activating Password Protection” near the beginning of this chapter.) *Once you set a password for a file, the file is not retrievable without the password.*

Rules for the password:

- It will be case-sensitive.
- It can have up to 16 characters.
- Any characters, including spaces, are valid.

To set or change a PIM or Pocket Quicken file’s password:

- Press **FILE** **F** **W** (File Password) and follow the directions.

You can password-protect a 1-2-3 file using the normal 1-2-3 method.

To delete a PIM or Pocket Quicken file’s password:

- Use **FILE** File Password and leave the new password blank. (Do not press **spacebar**.)

Searching for Specific Text

The **FIND** function key (**F4**) is present in the PIM applications (covered in part 2 of this manual) and in the Solver (covered in chapter 19).

To find a text string:

1. While displaying a list or record, press **F4** (Find). *Note that appointments and to-do items are searched separately—you must display the appropriate context.*
2. Fill in the box with the characters or text to search for.
3. Optional: Tab to and select the check boxes you want (press **spacebar** to change). One makes the search include the Note fields, and the other discriminates upper from lower case letters.

4. Press **F10** or **F4** (Next) to search forward from the current position.
- Or press **F3** (Previous) to search *backward* from the current position.

To repeat the search, press **↵** **F4**. A successful search stops when it finds the first instance of matching text. Either the matching text or the list item containing the matching text will be highlighted, depending on the current display. (Lists do not display all the text that the full records do, so the matching text might not appear in the list.)

If your records include extensive notes in the Note field, you can speed up a search by *not checking* Include Notes for the search.

Copying or Moving Information

The Clipboard: Copying, Cutting, and Pasting

The Clipboard is a buffer that saves the last item that was copied or cut. The Clipboard operations are COPY, CUT, and PASTE. These operations work within all built-in applications.

Clipboard Operations

Keys	Description
Fn COPY	Copies the highlighted item or text or field into the Clipboard buffer.
Fn CUT	Deletes the highlighted item or text or field and stores it in the Clipboard buffer. DEL acts like CUT <i>without</i> saving to the Clipboard buffer.
Fn PASTE	Copies the item or text or field from the Clipboard buffer into the list or text field where the cursor is.

To highlight a range of text:

- Move the cursor to the beginning of the text, then press **↵**+**▶** to highlight the range you want.

Pressing any arrow key cancels the highlighting.

To move or copy a piece of text:

1. Highlight the desired text range.
2. Press **Fn** CUT to move the text, or press **Fn** COPY to copy it.
3. Move the cursor to the new location for the selected text. (This can be in a different application.)
4. Press **Fn** PASTE.

To move or copy an item in a list:

1. Highlight the item.
2. Press **Fn** CUT to move the item, or press **Fn** COPY to copy it.
3. Move the cursor to the new location for the item. (This can be in a different application.)
4. Press **Fn** PASTE.

You cannot move or copy more than one item at a time.

About Moving and Copying an Item in a List

Copying or cutting an entry in a list copies its entire data record to the Clipboard buffer. Within an application screen you can move an entire entry (such as an appointment) around. Across applications, however, an entry can be moved or copied only as a piece of text, not as a complete record. For example, you cannot copy a Phone Book record to a Database list. However, you can copy its data fields (as unformatted text) to the Note field of a Database record or to a memo in the Memo Editor.

The format of the item that COPY or CUT copies into the Clipboard buffer is determined by the first Smart Clip definition (covered in the next section). By default, COPY and CUT copy all fields of the item into the Clipboard.

To delete a piece of text:

1. Highlight the desired text range. (Press **Home**+**Right Arrow**.)
2. Press **Fn** CUT or **DEL**. CUT stores the deleted text in the Clipboard buffer, while **DEL** does not.

1 Smart Clip: Copying Multiple Data Fields from Records

Smart Clip is available in the PIM applications and uses the Clipboard to copy formatted information quickly from *predefined fields* in the current application to another location (a memo or a text field). You might want, for example, to quickly copy several fields of information from a database to a memo in the Memo Editor or to a note in the Note Taker.

In most PIM applications, `Clip` provides predefined field-copying choices. In addition, you can define your own Smart Clips and control the formatting (the layout) of Smart Clip fields.

To define your own Smart Clip:

1. In a database, press `(F5)` (Clip).
2. Press `(F2)` `(F2)` (Define Field). Select a field name.
 - **Optional Formatting.** This group box is only for arranging fields in columns. Otherwise, leave this field blank and the correct width is automatically determined.
 - **Suppress Line if Empty.** If checked, this suppresses a carriage return after the specified field *if* the selected record has no data for that field. This prevents missing data from producing a blank line in the clipped output. This option inserts the code `, ?` into the Smart Clip definition.
 - **Reverse Name.** If checked, this reverses the order of the names in a field, such as the Name field in the Phone Book. Names usually appear in a record last name first. Reverse Name would switch Doe, Jane to Jane Doe.
3. Press `(F10)` when done defining the field.
4. To add another field, add space (press `(spacebar)`) or start a new line (press `(ENTER)`). Press `(F2)` again and fill out the dialog box as above. You can add as many fields as you want. Press `(F10)` when done.
5. You can also enter text or punctuation among the fields, including a final carriage return (`(ENTER)`) to separate records of text. For example:

Suppress Line if Empty.

All of these check boxes will be clipped, checked or unchecked.

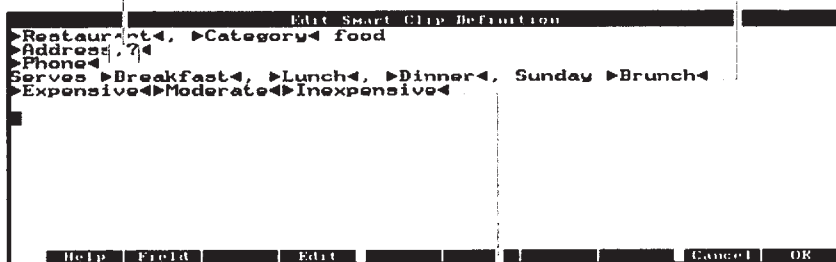

Only the "on" option button will be clipped.

A Smart Clip with Extra Text and Punctuation

6. Press **(F10)** when done with the Define Smart Clip screen.
7. Type a name for this Smart Clip definition and press **(F10)**. If you do not supply a name, then the new Smart Clip definition is named "Unnamed". However, the next unnamed Smart Clip definition will overwrite (replace) the previous one.
8. The Smart Clip is now defined, named, and ready to use. Press **(ESC)** to exit the Smart Clip screens. (Or press **(F10)**, which clips the defined fields from the specified records, if any, and saves them in the Clipboard.)
9. If you want to use this Smart Clip now, then follow the next procedure.

To clip information from a PIM application:

1. Select the records whose information you want to clip:
 - To select one record, highlight that entry in the list or open its record.
 - To select more than one record, mark each desired record by highlighting it in the list and pressing **(spacebar)**.
 - To select (or de-select) all records in the current list, press **(Ctrl)** **(E)** **(A)**.
2. Press **(F5)** (Clip) to display the Smart Clip list.
3. Highlight the Smart Clip you want and press **(F10)**.
4. Open the application and the record into which you'd like to copy this information.

5. Tab to the text field that should receive this information. A **text field** is any part of a memo, or any field meant for entering text, like an appointment Description or a Note field.
6. Press **[Fn] PASTE**.

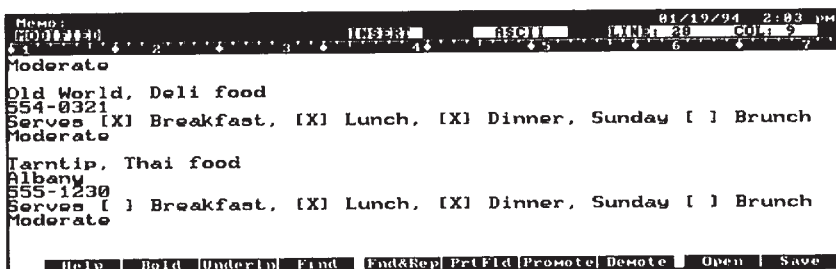

Using Smart Clips with Check Boxes and Option Buttons

- A check box field in a Smart Clip definition appears as the named check box when you paste the Smart Clip for the selected records. The check box will be checked or unchecked, depending on its status in a record.
- An option button in a Smart Clip definition appears as just its field name (without the button) when you paste the Smart Clip *if* the option button is turned on in a record. If a button is off, then nothing will be clipped.
- When including option buttons in a Smart Clip definition, you should include *all* of them from the same group, since option buttons are mutually exclusive and only the one that is “on” in a record will be clipped.

To edit or rename a Smart Clip:

1. In a PIM application, press **[F5]** (Clip).
2. Highlight the desired Smart Clip.
3. Press **[F3]** to rename the highlighted Smart Clip.
4. Press **[F4]** to edit the highlighted Smart Clip.
 - Press **[DEL]** to delete the highlighted field.
 - Press **[F4]** to edit the highlighted field.
 - Press **[F2]** to add another field.
5. Press **[F10]** when done. Press **[ESC]** to exit the Smart Clip screens.

To delete a Smart Clip definition:

1. In a PIM application, press **(F5)** (Clip).
2. Highlight the Smart Clip you want to delete.
3. Press **(F7)** **(F10)** (Delete OK).

To restore a Smart Clip definition you have just deleted (or edited), escape the Smart Clip list, then select **(EDIT)** Edit Undo. Use undo before doing another operation.

Getting Answers Fast: Online Help

The fastest way to get information about how to use any application is to use the built-in **online Help** information.

Press **(F1)** at any time to see **context-sensitive Help**; that is, information regarding your current situation on the palmtop (the current menu, display, or pending operation). (In the Datacomm application, press **(CTRL)+(F1)**.)

The Help menu offers different types of Help. Press **(MENU)** **(H)** to display it.

The Help Commands

Command	Description
Index	List of Help topics for the current application.
Getting Started	Basic use of the palmtop. Not application-specific. A good place to start learning about your palmtop.
How to Use Help	Keystrokes in the Help system.
About <i>application</i>	Copyright and version information.

Here is a typical help screen from the Appointment Book:

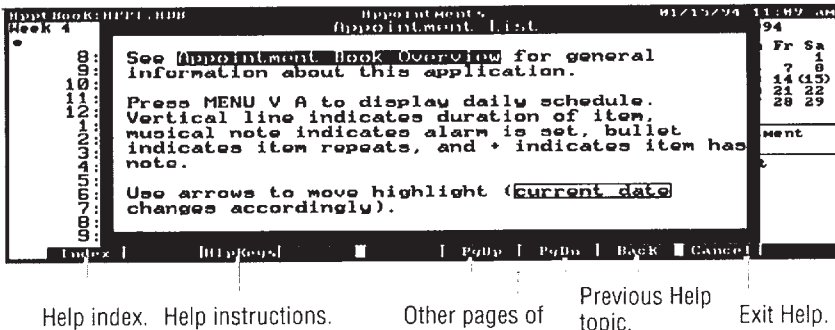

A Typical Help Screen

The outlined words are **links** to more Help topics. To find out what “current date” means, for instance, press **▼** to move the highlight to current date, then press **ENTER**.

To return to the previously displayed Help topic, press **F8** (Back).

Press **ESC** or **F9** (Cancel) to exit the Help system.

What About Games?

Your HP 200LX has two games built in: Hearts & Bones and Lair of Squid.

See appendix F for instructions on starting the games.

About 1-2-3

Because the vast majority of our customers are already Lotus® 1-2-3® users and have requested *less* product documentation, this chapter describes only the features of 1-2-3 Release 2.4 that are particular to your palmtop.

If you want additional documentation, there are excellent books about using 1-2-3 available—visit your local bookstore for a recommendation. And remember, HELP is always available; just press **(F1)** (HELP) to get online information about the 1-2-3 command you are using.



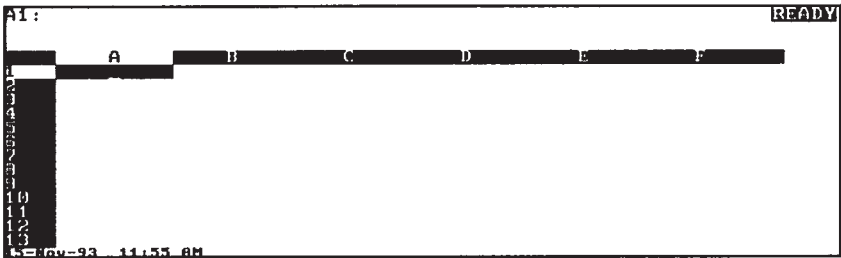



No Installation Required. To start 1-2-3 simply press **(123)**. The default display size is 64 columns × 18 lines.



Pressing **(Fn)** ZOOM (that is, **(Fn)** followed by the spacebar) switches back and forth between the 64-column × 18-line display and an 80-column × 25-line display (the common PC screen size). Try it and watch the screen size change.

With the help of the Connectivity Pack, you can transfer worksheets between your palmtop and another PC. The Connectivity Pack for your palmtop is available from your HP dealer.

To enter, edit, and move around a worksheet:

- You enter the data, labels, formulas, and formats as you would in any version of 1-2-3.
- You edit cells as you would expect, using  (backspace),  (delete),  (EDIT), and  (GOTO).
- You move around the worksheet as you would expect, using arrow keys and cursor-movement keys. Note that PGUP, PGDN, HOME, and END are -shifted keystrokes (for example, you press  then  to execute HOME).



To leave 1-2-3:

- You can either quit 1-2-3 ( ) , or simply press another application key.

Differences between 1-2-3 on the palmtop and 1-2-3 Release 2.4 on the PC

Although the palmtop version of the 1-2-3 Release 2.4 is essentially the same as the packaged version for your PC, there are some important differences. Even if you're a 1-2-3 expert, you should read the following descriptions of the additions, deletions, and modifications to your palmtop 1-2-3.

Additions to 1-2-3 on the Palmtop

- Backsolving 1-2-3 values using the Calculator.
- Clipboard functions for copying material from one location to another:  COPY copies a defined range to the Clipboard, and  PASTE inserts this material into the current location.

Deletions from 1-2-3 on the Palmtop

- The Install utility: No installation is necessary on the palmtop. The collating sequence (sorting order) and the printer configuration are set in the Setup utility.
- The landscape printing option.
- WYSIWYG and color support.

- Mouse support.
- The Tutorial add-in and tutorial files.
- The Translate utility.
- The Access system (to access PrintGraph, Translate, and 1-2-3).
- The SmartIcons add-in.
- The SmartPics™ files.
- The Backsolver add-in.
- The Background printing option.
- The PrintGraph program. (However, you can print a displayed graph by pressing  PRTSC.)
- The Viewer and Auditor add-in.
- The Macro Library Manager.

Modifications to 1-2-3 for the Palmtop

- Write-protected cells appear no different from other cells. The PR protection indicator appears in the control panel when a protected cell is highlighted.
- Because of ROM memory constraints, the Help text is less extensive.
- The macro commands {BIGLEFT}, {BIGRIGHT}, {PGUP}, and {PGDN} will operate differently depending on whether your palmtop is displaying 64 columns × 18 lines or 80 columns × 25 lines.
- There is no 123.EXE file, so you cannot start 1-2-3 from DOS.
- To save memory, the default status for the Undo feature is off (disabled). Select /Worksheet Global Default Other Undo Enable to turn Undo on.
- Add-ins must be run from RAM. To work, therefore, an add-in must fit in RAM, must work with any size screen in MDA or CGA mode, and must have been developed using the Add-In Toolkit specifications.
- The collating sequence for 1-2-3 can be set only in the Setup utility.

About Configuration Settings

1-2-3 can specify many configuration settings under /Worksheet Global Default. The Setup utility (**&...** **S**) establishes many other settings for the palmtop, *including for 1-2-3*. A few settings appear in *both* Setup and 1-2-3: date format, time format, punctuation, currency, and printing (interface and baud).

- Setup's time and date formats do not affect 1-2-3 cells.
- Setup supplies **default** (initial) values to 1-2-3 for punctuation and currency, as well as for the printer interface, baud, and name.
- If you make a printer, punctuation, or currency setting in 1-2-3, it overrides the setting in Setup.

Remember that for a /Worksheet Global Default setting command to remain in effect after the current session, you must preserve it with the Update command. Otherwise, the settings for the next session will take default values from Setup again.

To set the printer configuration:

1. Press **&...** **S** **&...** **O** **P** to select the printer configuration screen in Setup.
2. If you're not already there, tab to the baud group box.
3. Use the arrow keys to select the specific baud for your printer (the default is 9600).
4. Tab to the interface group box.
5. Use the arrow keys to select the interface. (Com1 is the default, and there is currently no HP infrared printer available.)
6. Tab to the list box containing the list of printers.
7. Use the arrow keys to highlight the name of the printer that is compatible with yours. A Kodak Diconix printer, for instance, can have its option switches set to be compatible with either the Epson or the IBM. You then select the Name setting in Setup that matches the printer's compatibility.
8. Press **F10** to save your settings.
9. Press **&...** **Q** to exit Setup.

Part 2

Personal Information Management

The Appointment Book

When you first start the Appointment Book (press **Q**), you see the daily appointment list, which is a schedule of the day's appointments.

Alarm set.
Note included.
Repeating
appointment.
Shows duration
of appointment.

These labels correspond to the function keys (**F1** - **F10**).

ENTER opens the record for the highlighted appointment.

In the daily appointment list use **▲** or **▼** to highlight an appointment, then press **ENTER** to see the appointment record.

Example Appointment Record

From an appointment record, you can return to the appointment list by pressing **F10** (to save any changes) or **F9** (to cancel any changes). From the appointment list,

- To see a weekly appointment list, press **F8** (Week).
- To see a monthly list, press **F7** (Month).
- To return to the daily appointment list, press **F9** (Appt).

Scheduling Appointments

To schedule an appointment:

1. Press **⏏** to start the Appointment Book
2. Press **⏏** **A** **A** to display the screen to add an appointment. (As a shortcut, you could instead press **F2** (Add).)
3. Fill in the fields. (Use **TAB** or **ALT**+*underlined letter* to move among them; use **spacebar** to check/uncheck a box.)

Description. This text provides the entry for the appointment list.

Start and End Times. The End Time is optional. Pressing **+** or **-** changes the time by fifteen minutes. (**⏏** **+** and **⏏** **-** change the time by one minute.)

Location. Optional. This information also appears in the appointment list, following an **E**.

Alarm. If the alarm is enabled (box checked), the palmtop will beep for the appointment. Press **spacebar** to disable the alarm (box not checked) for that one appointment. The **leadtime** sets how far ahead of the appointment time the alarm will go off.

Note. Optional. The Note field provides a large field for any additional information. Pressing **F3** (Note) displays a full-screen note.

Start Date. Pressing **+** or **-** changes the date by one day.

No. Consecutive Days. If the appointment goes for more than one day, fill in No. of Consecutive Days (or set a Daily Repeat Option).

Views. If these boxes are checked, this appointment shows up in the weekly and monthly appointment lists (schedules).

4. Optional: Press **F8** (Repeat) to specify a repeating appointment.
5. Press **F10** when done. Or press **ESC** to cancel the information.

Repeat Options

Frequency	Other Specifications	Examples
No Repeat	Cancels the existing repeat option, if any.	
Daily	Interval can be any number of days.	Every 5th day; every 30th day.
Weekly	Interval can be any number of weeks.	Every Wednesday; every other Friday.
Monthly	Interval can be any number of months. Can specify by date or by position in the month.	The 7th of every month; the first Wednesday every 3 months.
Yearly	Interval can be any number of years. Can specify by date or by position in the year.	August 7th every 2 years; the first Wednesday in August every year.
Custom	Can specify by date or by day position in specified months.	The 7th of January, April, and October every year; the first and third Monday and Wednesday in June, July, and August every year.

Example: Scheduling an Appointment. Schedule a dental appointment for 2:30 pm on July 15, 1994. Set the alarm to go off 30 minutes prior to the appointment to give you time to drive to the dentist's office.

Keys:



Dentist



2.3p

Description:

Starts the Appointment Book.

Opens up an appointment record.

Fills in the Description field.

Sets the start time of 2:30 pm.

- TAB** Moves to the End Time field. The default end time is an hour after the start time. Since an hour is about right, there's no need to type in another end time.
- TAB** Suite 324 Highlights and fills in the Location field.
- ALT**+**L** 30 Skips to the Alarm Leadtime field and enters 30 minutes (the default is 5 minutes). (Pressing **ALT** along with an underlined letter takes you directly to that field.)
- TAB** Brush before leaving. Enters a note to yourself.
- TAB** 7/15/94 Enters the date of the appointment.

Appointment/Event		07/10/94 2:25 pm	
Description	Dentist		
Start Time	2:30pm	Start Date	7/15/1994
End Time	3:30pm	No. Consecutive Days	1
Location			
Alarm		Views	
<input checked="" type="checkbox"/> Enabled		<input checked="" type="checkbox"/> Week <input checked="" type="checkbox"/> Month	
Leadtime	30	Repeat Status: None	
Note			
help Add Note Find Clip GCalend Repeat Cancel Done			

- F10** Saves this appointment and displays the appointment list for July 15, 1994.
- F5** **F4** Restores today as the current date.

On July 15 an alarm will sound at 2:00 pm to remind you of your dental appointment. You simply press **ESC** to clear the alarm.

Example: Scheduling a Bi-Weekly Repeating Appointment.

Schedule a repeating appointment for your bi-weekly staff meeting, which is held in Shasta Room every other Wednesday at 9:30 am.

Keys:

[F2]

[F4] **[A]** **[A]**

Staff Mtg

[TAB] 9:3a

[TAB] 11

[TAB] Shasta Room

[ALT]+**[N]** Take donuts and agenda.

[F8] **[W]**

[TAB] 2

[TAB] W

[TAB]

[TAB]

Description:

Starts the Appointment Book.

Opens up an appointment record.

Fills in the Description field.

Sets the start time of 9:30 am.

Sets an end time of 11:00 am.

Highlights and fills in the Location field.

Enters a note to yourself. (Pressing **[ALT]** along with an underlined letter takes you directly to that field.)

Opens the Weekly Repeat Options for you to fill out.

Sets the appointment to repeat every other week.

Sets its day to be Wednesday.

Highlights the default starting date, which is tied to the Start Date in the appointment record.

Highlights the default ending date, which defaults to 5 years from the Start Date. Enter another date if that duration is too long.

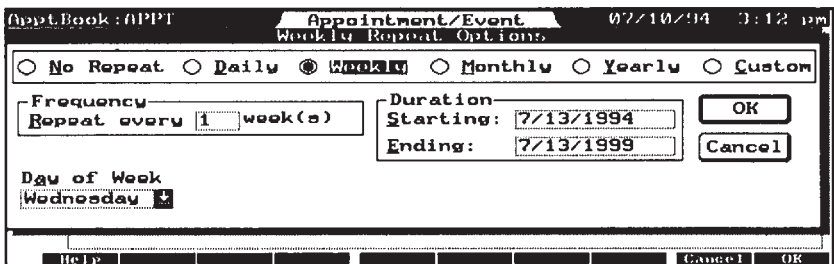

F10

Saves this repeat information and returns you to the appointment record. Notice the Repeat Status below the Views box.

3

Appt Book: APPT Appointment/Event 07/10/94 1:39 am

Description **Staff Mtg**

Start Time **9:30am** Start Date **7/13/1994**

End Time **11:00am** No. Consecutive Days **1**

Location **Shasta Room**

Alarm

Enabled Week Month

Leadtime **5** Repeat Status: **Weekly**

Note **Take donuts and agenda.**

Help Add Note Edit Copy Calendar Repeat Cancel Done

F10 **F5** **F4**

Saves this record and returns you to the appointment list for today. Now, every other Wednesday an alarm will sound 5 minutes before your staff meeting; simply press **ESC** to clear the alarm.

To set a snooze alarm:

- When an alarm goes off, press **spacebar**. This sets the alarm to recur in 5 minutes. Any past-due alarm then appears.
- To postpone the display of past-due alarms until after the snooze interval, press **F10** **spacebar**.
- For a longer snooze interval, press **spacebar** up to 11 times total. Each press equals 5 minutes. Press **←** to decrease the snooze interval by 5 minutes.

To schedule an event:

An **event** is an item associated with a day but not a time.

1. In the Appointment Book, press **ESC** **A** **E**. This opens an appointment record with the Start Time and End Time fields preset to **None** for an event.
2. Fill in the rest of the fields as for adding an appointment.
3. Press **F10** when done.

Example: Scheduling a Yearly Repeating Event. Oregon's trout fishing season regularly opens the last Saturday in April. Schedule the annual opening day as a repeating event.

Keys:

Description:

[O]

Starts the Appointment Book.

[F8] [A] [E]

Opens up an appointment record for an event.

Trout season opens

Fills in the Description field.

[ALT]+[C] Oregon

Fills the Location field.

[TAB] Plan a trip to Odell Lake.

Enters a note.

[F8] [Y]

Selects the Yearly Repeat Options.

[ALT]+[P]

Moves to the Repeat By Day Position field.

[TAB] L

Selects Last.

[TAB] S

Selects Saturday. (If Sunday appears, press **[S]** again to see Saturday.)

[TAB] A

Selects April. (If August appears when you press **[A]**, press it again to see April.) This completes selecting the last Saturday in April.

[ALT]+[E]
5/01/2005

Sets the event to repeat until May 2005.

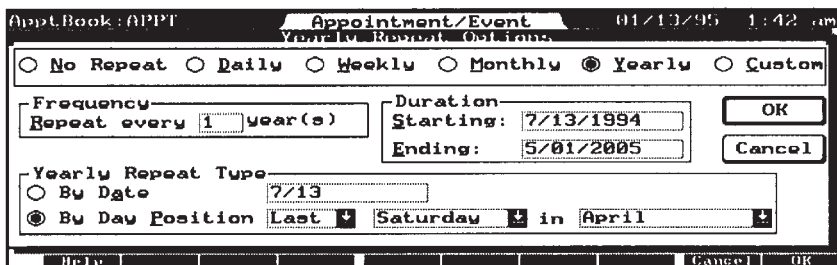

F10 F10

Saves the record and returns you to the appointment list at the date of the first occurrence. Now, the opening of Oregon's trout season will appear on your appointment list as a repeating event.

Types of Appointment Lists

There are daily, weekly, and monthly appointment lists (schedules), as well as a six-month calendar.

Week number in year.

Days remaining in year.

Today's date.

The screenshot shows a window titled 'Appointments' with a menu bar (File, Edit, View, Options, Help) and a toolbar (New, Open, Print, Save, Find, Goto, G. Month, Month, Week, Today). The main display area shows 'Week 2 Friday January 13, 1995 13/352'. The appointment list is as follows:

1	[8:00a	
3	[9:00	
5	•	10:00	Staff mtg
7	[11:00	
9	[12:00p	
11	[1:00	
1	[2:00	
3	•	3:00	Call MJ
5	[4:00	Pick up books
7	[5:00	
9	[6:00	
11	[7:00	
	[8:00	

On the right, a calendar for January 1995 shows the current date as 1/13/95. The 'Next Appointment' box displays: '1/25 9:30a Staff Mtg', 'ToDo / at', '01 Pay Dre 01/15', and 'Type .notes'. A dashed line points from the 'Today's date' label to the date in the calendar.

Appointment date.

Daily Appointment List (Appt)

Symbol	Meaning
•	Repeating appointment.
☐	Appointment includes Note.
⌚	Alarm.
[Duration of appointment.

Current appointment. Overlapping appointments. Today's date.

Appt Book: RPPT, RDB	Week				01/15/94 11:56 AM			
Jan '94	Sun 9	Mon 10	Tue 11	Wed 12	Thu 13	Fri 14 <Sat 15>		
9:00a	.	.	Book Fai	Book Fai	Help at	Take fin		
10:00		
11:00	Call Bos		
12:00p	.	Evaluation session	Pick up	.	Pick up	Lunch w/		
1:00		
2:00	Lap swim		
3:00	Project meeting	.		
4:00		
5:00	.	Soccer p	.	.	.	Dentist		
6:00	Meet w/		
7:00		
Help	Add	Note	Find	Go to	6 Month	Month	Appt	To Do

Weekly Appointment List (Week)

A multiple-day event. Today's date.

Appt Book: RPPT	JANUARY 1994				01/15/94 8:13 PM			
Sunday	Monday	Tuesday	Wednesday	Thursday	Friday	Saturday		
26	27	28	29	30	31	1		
	*Staff Retr	*Staff Retr	*Staff Retr	*Staff Retr				
2	3	4	5	6	7	8		
Lap swim			Book Fair					
9	10	11	12	13	14	15		
					Pick up RR			
16	17	18	19	20	21	22		
23	24	25	26	27	28	29		
Help	Add	Note	Find	Go to	6 Month	Month	Appt	To Do

Current Appointment Book date.
Monthly Appointment List (Month)

- | | |
|--------|--------------------|
| Symbol | Meaning |
| - | p.m. appointment. |
| X | Event. |
| ... | More appointments. |

Current Appointment Book date.

Today's date.

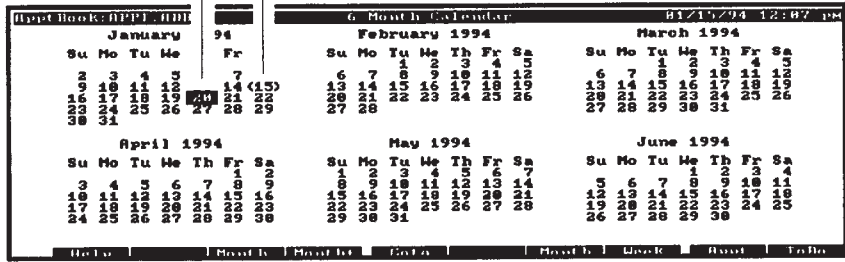

Six-Month Calendar (6 Month) — No Appointments

Moving Around Appointment Lists

Keys	Description
▲, ▼	Moves the highlight bar through times, days, weeks, or months, depending on the display. If the highlight moves to a different day, that becomes the current date.
⬆, ▲, ⬇, ⬆	Moves the highlight to the previous/next week.
◀, ▶	Moves the highlight to the previous or next day.
⌘ PGUP, ⌘ PGDN	Moves the highlight to the previous/next day part, month, or half-year (depending on the context).
⌘ HOME, ⌘ END	Moves the highlight to the beginning/end of the current day, or to the first/last displayed date (depending on the context).
⌘ + ◀, ⌘ + ▶	Moves the highlight to the previous or next day that has an appointment or event.
⌘ + ▲, ⌘ + ▼	Moves the highlight to the previous or next appointment or event.
⌘ TAB	Moves the highlight between appointments and events. (If no events, it just beeps.)

To view all the events for a month:

1. In the Appointment Book, press **VIEW** **V** **E** (View All-Events).
2. Press **F9** (Appt) to return to the daily appointment list.

Tips for scheduling:

- Check your schedule before adding a new appointment. Check your monthly (**Month**), then weekly (**Week**), then daily schedules for successive overviews of available days and times.
- Another way to start adding an appointment: When an appointment list is displayed, any typed character will automatically open the appointment record and start filling in the Description field.
- An alternative to filling in the Start Date field in the appointment record is to change the current date *before* executing Add. Use the arrow keys or Goto function to change the current date.
- Filling out the appointment record: Another way to fill in the Date fields is to call up the small, one-month calendar (press **F6**). Use arrow keys to highlight a date in the calendar. When you press **ENTER**, the calendar's date will be recorded in the Date field.
- Filling out the appointment record: The Time and Date fields accept any delimiter characters (**:**, **/**, space, **.**, or **,**) for the date and time. For example, typing 11 **spacebar** 3 in the Time field enters 11:30AM, and typing 3P enters 3:00PM. Typing 11.3 in the Date field enters November 3 (in the current or next year, as appropriate).
- Filling out the appointment record: To enter an afternoon time, type P, PM, or use 24-hour time.
- To change the displayed time intervals in a daily or weekly appointment list (schedule), press **Fn** ZOOM.

Changing the Current Date

Note The **current date** is the date currently displayed or highlighted. This is *not* the same as **today's date** (the **system date**), which can be changed only via the Setup utility.

3

Starting from a list, you can change the current date to the next day by pressing **▶** and to the previous day by pressing **◀**. Try it and notice how the date changes.

To change the current date to any date (Goto):

1. Start from any list (daily, weekly, monthly, 6-month, or To-Do). If necessary, press **ESC** to display a list.
2. Press **F5** (Goto).
3. Type the date to go to and press **ENTER**. (As a shortcut, try using the arrow keys.)

When you press **F5** (Goto), you can also use the Goto function keys. (**TAB** moves the cursor between the calendar and the date box.)

Function Keys for Goto (**F5**)

Key Label	Changes the Current Date
nDay- , nDay+	Backward or forward <i>n</i> number of days, which you specify.
Today	To today's date.
Month- , Month+	Backward or forward one month.
Year- , Year+	Backward or forward one year.

Editing and Deleting Appointments

To edit (change) an appointment:

1. Start from the daily (or weekly) appointment list. (Press `App't`, if necessary.)
2. If necessary, change to the desired date (use `Go to`).
3. Use the arrow keys to highlight the appointment you want to edit.
4. Press `ENTER` to display the appointment record.
5. Tab to and edit the field you want to change. (Try using `+` and `-` when you edit the time, date, and alarm fields.)
6. Press `F10` to save your changes. Or press `ESC` to cancel them.

To change a repeating appointment to a one-time appointment:

1. *Open the record for the date that you want to keep.* Highlight the repeating appointment you want to change.
2. Press `F8` to display Repeat Options.
3. Arrow to the option button No Repeat.
4. Press `F10` three times (to confirm the change).

To delete an appointment:

Deleting an appointment removes it from the Appointment Book.

1. Start from the daily (or weekly) appointment list. (Press `App't`, if necessary.)
2. If necessary, change to the desired date (use `Go to`).
3. Use the arrow keys to highlight the appointment to delete.
4. Press `DEL`.

If you highlight and try to delete an occurrence of a repeating appointment, you'll see the Repeating Item Delete dialog box.

- If you want to delete just the one appointment, press `F10`.
- If you want to delete more than one occurrence:
 1. Press `▼`.
 2. Tab to the range boxes and enter the range you want to delete.
 3. Press `F10` to delete the range. Press `ESC` to cancel the delete.

To restore a deleted appointment (Undo):

- Press **(Ctrl) (E) (U)** immediately after the deletion.

To delete all appointments and to-do items before or after a date:

This deletes *all* Appointment Book entries for the given period. If you want, you can save the removed items in an **archive** (back-up) file.

3

1. Press **(Ctrl) (F) (R)** (File Remove).

Specify a filename here *only* if you check here.

Remove Items

Remove All Appointments, Events, and To-Dos:

Before 1/15/1994 Save Removed Items in Archive

After 1/15/1994

Archive to: *.ADB

Directory: C:_DAT

Files: APPT.ADB

Directories: [-A-]
[-B-]

OK Cancel

Dialog Box for File Remove

2. Highlight Before or After and specify the date.
3. If you want to save the deleted items in an archive file, check the appropriate box and specify the name of the archive file.
4. Press **(F10)** when done.

Similarly, you can use File Extract (**(Ctrl) (F) (E)**) to back up (“extract”) all items before or after a given date.

Running a Program or System Macro at a Certain Time

You can set an appointment to run a program or a system macro rather than set off an alarm.

For example, you could use this feature to set the palmtop to use a macro to automatically open Datacomm and log onto an information service (using a script file) during a low-use, low-cost time of night.

To set an appointment that runs a program or macro:

1. Press **F2** or **ESC** **A** **A** to add a new appointment.
2. Start the Description field with | for a program or || for a system macro. (| is shifted **\"** key.)

For a program: Follow the | with the full **pathname** (file name and directory names) of the program to run. The program must have a .EXE, .COM, or .BAT extension, and it must exist already. An example of a Description to run the program SALESGIF (subdirectory SALES, subdirectory _DAT) is:

```
|C:\_DAT\SALES\SALESGIF.EXE
```

For a system macro: Follow the || with the number (1-10) of the macro to run.

3. Fill out the other fields as for other appointments, except for these fields, which have special meanings:

Alarm. Must be enabled (checked) to run the program.

Location. Specifying Q (quiet) in this field suppresses any error message that might result from running the specified program or macro.

4. Press **F10**.

When the time comes and the program or macro runs, the screen displays the result of the program or macro. A program ends with the message, `Press any key to exit from DOS...`

Specifying Q for the Location suppresses this message and returns the display automatically to the context that preceded this "appointment".

Note

A program cannot run if a DOS application is open when the appointment comes due.

To-Do Lists

To-do lists are much like appointment lists: You can view a list of to-do items; and, if you want more details about an item, you can display its record. Press **(F10)** (ToDo) from an appointment list to display the current day's to-do list.

3

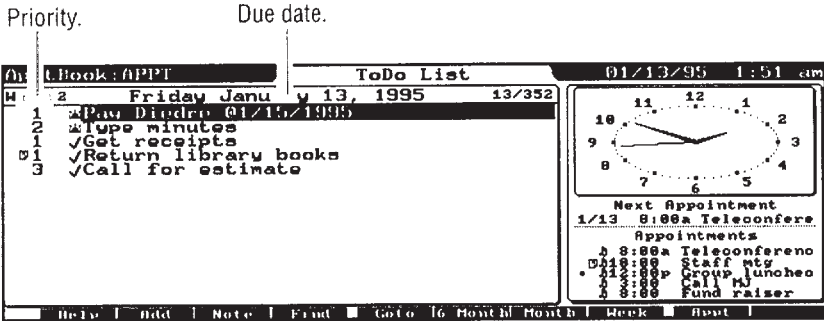

A To-Do List

Symbol	Meaning
★	Item new today (its first occurrence).
✓	Completed item (checked off).
!	Item due today (and not yet checked off).
●	Item past-due (and not yet checked off).
☐	Item includes Note.
•	Repeating item.

Highlight an item and press **(ENTER)** to see its complete record:

The first date the item appears.

Carries forward an item that is not checked off.

Appointment Book: APP1 ToDo 01/13/95 1:52 am

Description: Paw Driedro

Start Date: 1/13/1995

Due Date: 1/15/1995 Carry Forward

Priority: 1 Repeat Status: None

Note: Extra for snow days.

Help | Add | Note | Find | Goto | Calendar | Repeat | Cancel | Done

3

A To-Do Item's Record

To add a to-do item to the list:

1. In the Appointment Book, press **ADD** **A** **T**.
2. Fill in the fields. (Use **TAB** or **ALT**+letter to move among them.)

Description. This will appear in the to-do list.

Start Date. The first date a to-do item appears. Pressing **+** or **-** changes the date by one day.

Due Date. Optional. If the to-do item has not been checked off, an exclamation point appears on the due date in the to-do list. Then, on subsequent days a sad face appears until the item is checked off.

Priority. Every to-do item has a priority number (one or two digits and/or letters), which you can type in. The items are sorted by their priority; numbers are sorted before letters. Multiple items can have the same priority.

Note. Optional. The Note field provides a large field for any additional information. Pressing **Note** (**F3**) displays a full-screen note.

Carry Forward. If this box is checked, then the to-do item reappears in each day's list until the item is marked as completed. Pressing **spacebar** checks/unchecks this box. (Note that Carry Forward repeats an item, using more memory.)

3. Press **F10** when done. Or press **ESC** to cancel the information.

To scan a to-do list:

- Use the arrow keys to move the highlight bar through a list of items. When you want to see more details about an item, press **ENTER**

to see its record; when you're done with it, press **ESC** to return to the list.

To check off a completed to-do item:

1. Highlight the completed item.
2. Press **-** or **spacebar**. The item is checked and moved to the bottom of the list.
3. Highlighting it again and pressing **-** or **spacebar** clears the checkmark.

More Information about To-Do Items

- On a to-do item's due date, an exclamation point appears next to it in the to-do list.
- When the item is past due, a sad face appears instead.
- You search, edit, and delete to-do items the same way you do appointments.
- You can use **Repeat** (**F8**) to create repeating to-do items the same way you create repeating appointments.

Using Multiple Appointment Books

You can create more than one Appointment Book file, thereby creating more than one appointment list in this application. Use **File New** or **File Copy** to create a new Appointment Book file. Use **File Merge** to merge another Appointment Book file into the current one.

Only the Appointment Book currently open will activate alarms.

Translating Appointment Books

HP 100LX files need no translation to be used in your HP 200LX; they share the same file format.

To translate an HP 95LX Appointment Book to an HP 200LX Appointment Book:

1. Copy an HP 95LX Appointment Book file to your HP 200LX via the infrared serial port, a serial cable, or a plug-in memory card (see chapter 22).
2. In your HP 200LX Appointment Book, open ( File Open) the copied file, *filename.ABK*.
3. When prompted, specify a new file name (other than APPT) *without* any extension.

File Open then translates the .ABK file to an HP 200LX Appointment Book file, automatically supplying the extension .ADB. This operation can take 1 to 5 minutes for an average-sized Appointment Book.

Setting Options and Defaults for the Appointment Book

The options and defaults that you can set are

- Clock display (in appointment list; in to-do list).
- Calendar display (in appointment list; in to-do list).
- Next-appointment display (in appointment list; in to-do list).
- Graph of appointments (in appointment list; in to-do list).
- Timeline—the time intervals shown for the daily appointment list.
- Default appointment and to-do settings.
- Alarm volume and sound.
- Daily greeting.

The Day Graph shows the duration of an appointment.

Your next appointment. Calendar (or clock).

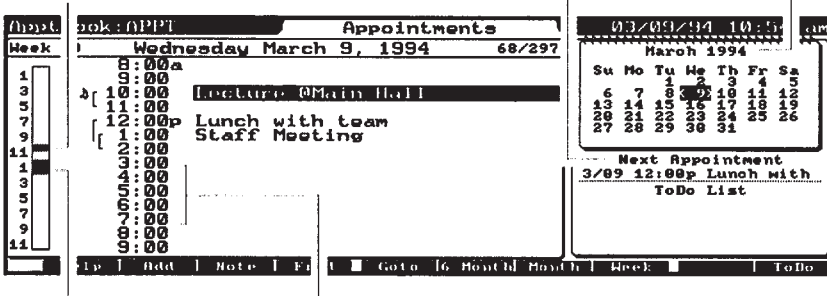

3

Overlapping appointments. Timeline.

Possible Components of an Appointment List

To change the clock, calendar, Next Appointment, or Day Graph in an appointment or to-do list:

- For the appointment list, press (Options Customize-Appointments-View). For the to-do list, press (Options Customize-ToDo-List-View).

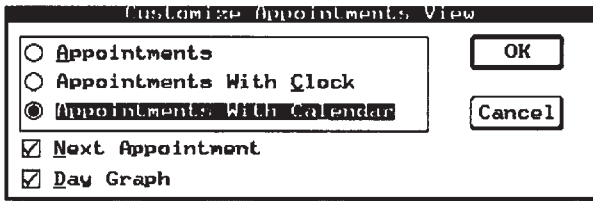

- Highlight the option button for the desired display: with a clock in the corner, a calendar, or neither.
- Check the relevant check boxes if you would like to see the Next Appointment called out in a side box and/or see a vertical Day Graph that shades in the times and durations of the current day's appointments. (Next Appointment can appear only in conjunction with the clock or calendar.)
- Press when done (or to cancel).

To change the appointment timeline setting:

1. In the Appointment Book, press **APP** **O** **T** (Options Timeline).
2. Select the timeline option you prefer: displaying no times except those for scheduled appointments (Appointments Only), or displaying regular times at intervals of 15, 30, or 60 minutes.
3. Enter the first hour of the day for the timeline. (This affects times you fill in when adding an appointment: If you don't specify a.m. or p.m. when filling in a time field, then the time is assumed to be *after* the first hour of the day.)
4. Select whether the calendars and the weekly and monthly timelines should start with Sunday or Monday.
5. Press **F10** when done (or **ESC** to cancel).

To change the time intervals in the daily/weekly timeline:

1. Display the timeline, which appears in the daily and weekly appointment lists (schedules).
2. Press **F11** ZOOM. ZOOM cycles through the time intervals: 60 minutes, 30 minutes, 15 minutes, and no intervals (just appointments).

To change the default settings for appointments:

1. In the Appointment Book, press **APP** **O** **D** (Options Appointment-Defaults).
2. Set the following default values:
 - Appointment Duration.** This determines the default End Time for a new appointment.
 - Alarm.** Enabled or not (on or off), and Leadtime (how long before the appointment the alarm goes off).
 - Items to See in Week/Month View.** Whether appointments and events should appear in the weekly and monthly appointment lists. (They always appear in the daily list.)
3. Press **F10** when done (or **ESC** to cancel).

To change the default settings for to-do items:

1. In the Appointment Book, press **APP** **O** **E** (Options ToDo-Defaults).
2. Set the following default values:

Carry Forward. Uncompleted to-do items are carried forward to today if Carry Forward is set.

Priority. The default priority for a to-do item. The priority can have one or two letters/numbers; numbers are sorted first.

3. Press **(F10)** when done (or **(ESC)** to cancel).

3 To change the alarm volume and sound:

1. In the Appointment Book, press **(M)** **(O)** **(B)** (Options Alarm-Beep).
2. Checking Mute overrides the volume level. You might choose to mute all alarms when going into a meeting, for example.
3. Select (by tabbing and arrowing) the volume level and the sound.
 - The Custom choice requires the presence of a programming statement in a file named C:_DAT\ALARM.SND. (Create this file as an ASCII file using the Memo Editor.) This file can have up to 511 characters.
4. To test the volume and sound, press **(F3)**. To cancel the test, press any key.
5. Press **(F10)** when done (or **(ESC)** to cancel).



Commands for Custom Alarm Programming

Command	Parameters	Meaning
A..G	+ or # (sharp) - (flat)	Plays this note in current octave, length, and tempo.
K	0 (disabled) 1 (enabled)	Any keystroke terminates the alarm sound. Default is 0.
L	1 to 64 (8 is whole, 16 is half, etc.)	Sets length of following notes. Default is 8.
M	N (normal) L (legato) S (staccato)	Playing style. Default is N.
O	0 to 7	Sets current octave. Default is 4.
P	1 to 64	Sets one pause of length <i>n</i> . 64 is shortest.
T	0 to 255	Sets tempo. Higher is faster. Default is 150.
V	0 to 3	Sets volume. Higher is louder.
period		Extends a note's duration by half.
space or comma		Affects readability only.

Parameters follow the commands. For example, the beginning of Mary Had a Little Lamb can be written as:
T230 K1 EDCDEEE. DDDP10 EGG.

To turn off the daily greeting:

The first time your palmtop is turned on each day it shows you your appointments, events, and to-dos for the day. This is called the daily greeting.

1. In the Appointment Book, press   (Options) to display the Options commands.
2. Press  (Daily-Greeting) to uncheck and turn off the daily greeting feature.

Repeat the above steps to turn the daily greeting back on.

Appointment Book Function Keys

What the function keys do depends on whether the current context is appointments or to-dos.

Function Keys for an Appointment or To-Do List

Key Label	Description
Add	Opens a template to define a new appointment or to-do item.
Note	Shows you the contents of the Note field for the highlighted item.
Find	Searches for the specified text (a character string).
Goto	Changes the current (displayed) date to the one specified.
6 Month	Displays the six-month calendar.
Month	Displays the current month's appointments and events.
Week	Displays the current week's appointments and events.
Appt	Displays the current day's appointments and events.
ToDo	Displays the current day's to-do list.

Function Keys for an Appointment or To-Do Record

Key Label	Description
Add	Opens a template to define a new appointment or to-do item.
Note	Provides a full-screen note field.
Find	Searches for the specified text (a character string).
Clip	To copy predefined fields (a Smart Clip) from the Appointment Book to the Clipboard. Also to define new Smart Clips. Smart Clip definitions are also used in Custom Style printing. See page 1-28.
Calendr	Displays a small calendar for reference and date entry.
Repeat	Defines a repeat interval for an appointment or to-do item.

The Phone Book and the Database

The Phone Book and Database are two separate, but related applications. The Phone Book is a database that has been predefined to hold names, phone numbers, and so on. The Database application enables you to build your own databases. Most of the topics and procedures in this chapter apply to both applications.

About the Phone Book Application

Press **☑** to start the Phone Book. At first the Phone Book will be empty, but when you add items it will look like this:

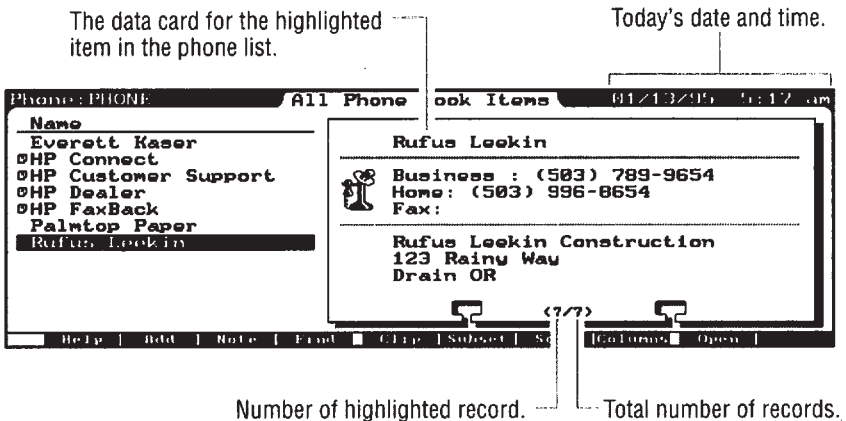

A Typical Phone Book List

Each individual or business has its own **record** of information. You view a record of information by highlighting the one you want and pressing **ENTER**.

Phone: PHONE		Phone Item		01/13/95 5:12 am	
Name	Rufus Lookin				
Business	(503) 789-9654	Home	(503) 996-8654		
Alternate		Fax			
Title	Owner	Category	▼		
Company	Rufus Lookin Construction				
Address1	123 Rainy Way				
Address2					
City	Drain	State	OR	Zip	
Note					
Help Add Note Find Clip Prev Next Cancel Done					

A Phone Book Record

From a phone record, you can return to the phone list by pressing **(F10)** (to save any changes) or **(F9)** (to cancel any changes).

Adding to and Editing a Phone Book

To add a record to the Phone Book:

1. Press **(F2)** to start the Phone Book and display an empty record.

Phone: PHONE		Phone Item		01/13/95 5:13 am	
Name					
Business		Home			
Alternate		Fax			
Title		Category	▼		
Company					
Address1					
Address2					
City		State		Zip	
Note					
Help Add Note Find Clip Prev Next Cancel Done					

2. Type in the name. Enter names either last-name first or first-name first, but be consistent because of alphabetic sorting.
3. Type information into the rest of the fields, pressing **(TAB)**, **(↑)**, **(TAB)**, or **(ALT)+underlined letter** to move from field to field.
 - a. Some fields can hold more than the window shows. Press **(▶)** or **(◀)** to view long fields.

- b. The Note field provides an extra-large field. Press **Note** to display a full-screen note. Any item with a note displays a **☐** to its left in the Phone list.
 - c. The Category field includes any categories entered for other records. See page 4-21.
4. Press **F10** when done or press **F2** to open a new record. Or press **ESC** to cancel the information.

To edit (change) a phone record:

1. Display the phone list. (Press **ESC** or **F10**, if necessary.)
2. Highlight the item you want to edit (either use the arrow keys or just start typing the name and watch the display scroll as you type).
3. Press **ENTER** to display the record.
4. Tab to and edit the fields you want to change. (To clear a field, press **DEL**.)
5. Press **F10** to save your changes. Or press **ESC** to cancel them.

To delete a phone record:

1. Display the phone list. (Press **ESC** or **F10**, if necessary.)
2. Highlight the item you want to delete (either use the arrow keys or just start typing the name and watch the display scroll as you type).
 - If you want to delete several items, select each one by highlighting it and pressing **spacebar**.
3. Press **DEL**.

To restore the last deleted item (Undo):

- Press **MEMO** **E** **U**.

To add or delete a field:

Since the Phone Book is simply a defined database structure, you can alter its structure by starting the Database application and opening the Phone Book file there. Use **MEMO** File Modify-Database to edit the Phone Book structure (see page 4-14). However, you should not change the Phone Book structure if you plan to use the Import function in the Connectivity Pack.

To remove the data card from the phone list:

You can control whether the data card is displayed in the phone list.

1. Display the phone list. (Press **ESC** or **F10**, if necessary.)
2. Press **VIEW** V (View) to see the View commands.
3. The default state of the Show-DataCard option is on (checked).
Press D to uncheck the box and remove the card from the list.

To restore the data card to the phone list, press **VIEW** V D (View Show-DataCard) to recheck the option.

To customize the information on the data card:

The data card is simply a Smart Clip of the information on a data record. You can edit the existing definition of the data card Smart Clip using **F5** (Clip) from the phone list. (Note in the data card definition that - and = are formatting commands that render thin and thick lines.) For more information on editing Smart Clips, see page 1-28.

Searching a Phone Book

You can scan the Phone Book by scrolling through the Phone list (**▲**, **▼**) or by looking through sequential records (**Next** , **Prev**).

To look up a name (speed-locate):

1. Display the phone list. (Press **ESC** or **F10**, if necessary.)
2. Start typing the name; the list scrolls as you type.
3. Press **ENTER** when the name is highlighted.

To find any piece of text:

1. From a phone list or record, press **F4** (Find).
2. Fill in the dialog box with the characters or text to search for.
3. Optionally tab to and select (press **spacebar**) the boxes for including notes in the search and for discriminating upper and lower case.
4. Press **F10** to search from the beginning of the list.
 - Or press **F4** (Next) to search through the list from the current (highlighted) position.
 - Or press **F3** (Previous) to start the search *backwards* through the list from the current position.
5. To repeat the last search, press **↑** **F4**.

A successful search stops at the first instance of matching text. Either the matching text (if a phone record is displayed) or the item containing the matching text (if the phone list is displayed) is highlighted.

Using Multiple Phone Books

You can create more than one Phone Book file, thereby creating more than one phone list in this application. Use **MENU** File New or **MENU** File Copy to create a new Phone Book file. Use **MENU** File Merge to merge another Phone Book file into the current one.

Translating Phone Books

HP 100LX files need no translation to be used in your HP 200LX; they share the same file format. However, an HP 100LX Phone Book, Database, or Note Taker file displayed in your HP 200LX will look slightly different than a corresponding HP 200LX file. You can make data from your HP 100LX be displayed just like HP 200LX data by merging the HP 100LX file with an HP 200LX file—use **MENU** File Merge.

To translate an HP 95LX Phone Book to an HP 200LX Phone Book:

1. Copy an HP 95LX Phone Book file to the HP 200LX via the infrared serial port, a serial cable, or a plug-in memory card (see chapter 22).
2. In the HP 200LX Phone Book, open (**F10** File Open) the copied file, *filename.PBK*.
3. When prompted, specify a new file name (other than PHONE) *without* any extension.

File Open then translates the .PBK file to an HP 200LX Phone Book file, automatically supplying the extension .PDB. This operation could take several minutes for a very large Phone Book.

Since the two types of phone records do not have exactly the same fields, this is how the information will be distributed:

Phone Book Translation

HP 95LX Field	becomes	HP 200LX Field
Name (30 characters)		Name (29 characters)
Phone		Business Phone
Address		Note

If you want, you can then use the Clipboard functions (**F11** CUT and **F12** PASTE) to move the information from one HP 200LX field (like Note) to another (like Address1).

Creating Your Own Database

Press (**F10**) (**B**) to start the Database application. A **database** has two distinct parts:

- A **structure** (or **template**) that defines the **fields** the database has. The fields will hold data and are labeled by **field names**.
- The data **records**. Each record contains its data values in the defined fields. The database **list** lists all the records in a database.

The Database application comes with one prepared database file for information about restaurants. You can use this built-in database structure (file name RESTR.GDB) to see what the Database

application is like and practice using it. The Phone Book application (☑) is another example of a built-in database structure. In fact, you open, add to, delete, edit, search, etc., a database and its records in the same way you do a phone book.

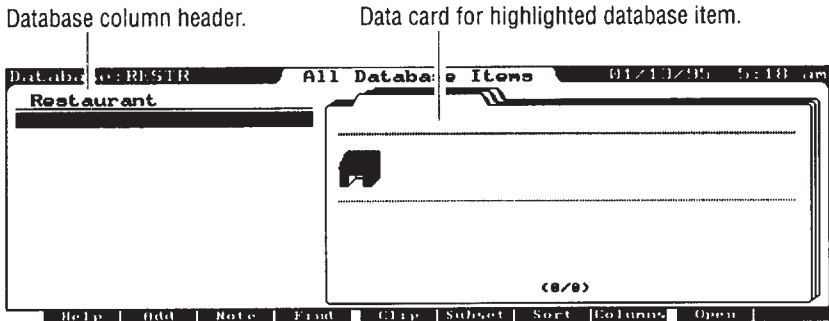

A Database List with No Data Records

In addition, you can define a database to contain the data fields you want, with any size and placement of fields.

About Database Structures

You can create a new database by:

- Defining a new database structure, then filling out records for it.
- Copying an existing database structure, then filling out new records for it. You can also modify this structure before filling out the data records.

File Commands for Defining Databases

File Commands	Description
Define-New-Database	To define a new database structure.
File New	To copy the current database structure but not its data. (Use for a new set of data.)
Modify-Database	To modify the current database structure.

A **database** is made up of a structure and many records of data (like phone records). The **structure** defines the **data fields** by **field name**, **field type**, and visual arrangement.

A field name.

A text field.

The Category field.

The screenshot shows a database form with the following fields and controls:

- Restaurant**: Text field
- Phone**: Text field
- Address**: Text field
- Category**: Text field with a dropdown arrow
- Meals**: Group box containing:
 - Breakfast
 - Lunch
 - Dinner
 - Brunch
 - All Night
- Food Quality**: Group box containing:
 - Excellent
 - Good
 - Fair
- Cost**: Group box containing:
 - Expensive
 - Moderate
 - Inexpensive
- Serves Liquor
- Good for Kids
- Vegetarian Menu
- Note**: Text field
- Number**: Numeric field

At the bottom, there are buttons: Help, Add, Note, Find, Clip, Prev, Next, Cancel, Done.

Check boxes.

The Note field.

A group box.

Option buttons.

A Database Structure

Field Types for Database Structures

Field Type	Description
Text	Provides a box for text. The box will hold 1½ times more characters than its length shows (at least 10). For more space, add more than one text field.
Number	For numeric data.
Date or Time	For date or time data using any punctuation as delimiters. Dates and times must match the format used for the system date and time (set in the Setup utility). For time, the number must represent hours and minutes. For example, the input 1.30 means 1 hour 30 minutes, not 1.3 hours.
Label	For descriptive text without a box. Provides a label for each record. It has no data.
Group box	For visual grouping of the fields inside it. (Option buttons <i>must</i> appear inside a group box.) If the group box is too small, you can increase its size.
Option button	To indicate one choice from a set of choices. <i>The option set must appear in a group box.</i> Option buttons in the same group box are mutually exclusive.

Field Types for Database Structures (continued)

Field Type	Description
Check box	To indicate yes/no (on/off) choices. Check boxes can be grouped together into a group box for appearance, but each one must be checked or unchecked independently of the others.
Category	For categorizing records. You can create a data subset based on a category of records. Limit: one Category field per database. The Category field is a special drop-down list box that is editable. The same category choices (up to 32) are available from all records of the same database. You cannot add category choices while defining the database.
Note	For adding notes in a large field with text-editing features. Limit: one Note field per database structure.

Defining a New Database Structure

To add and define the new fields:

1. In the Database application, press **⌘ F D** (File Define-New-Database). You see the Add Field dialog box:

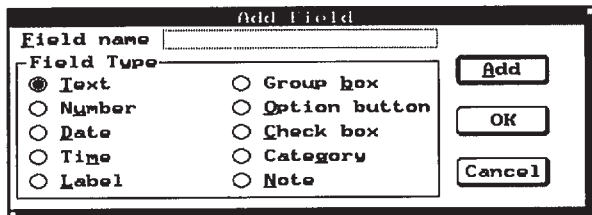

2. Type in the name for a data field. A field name can have up to 20 characters. Names are not case-sensitive, and they ignore non-alphanumeric characters and leading digits. (The & character has a special meaning explained later.)
3. Tab to the **Field type** group box and select the type of field.
4. To add another field, press **⌘ F2**. All fields will appear on one screen (**page**) initially, eventually overlying one another. You can move the fields apart at any time.

5. You can have up to four pages per database structure. To access the next page press **FN** **▼**.
6. When done adding fields, press **F10**. If one field disappears under another one, just press **TAB** until the hidden field is highlighted. Use arrow keys to move it.

4 To move or size a database field:

Keys	Description
▲ , ▼ , ▶ , ◀	Moves the current (highlighted) field up, down, right, left. To move to a previous or following page, use CUT and PASTE.
↕ arrow	Moves the current field by finer increments.
CTRL + ▶ , CTRL + ◀	Adjusts the width of the current field. (You can also adjust the height of Group boxes and Note fields.)
FN CUT and FN PASTE	For moving the current field to another page. (Use PG UP or PG DN before pasting.) Option buttons or Check boxes inside a Group box can move with the group box.

To add a group box with option buttons (or check boxes):

Option buttons *must* exist inside a group box.

1. Add the group box first.
2. Add the option buttons (or check boxes). They automatically appear inside the group box. (You can move check boxes out.)
3. To hold more than three buttons, enlarge the group box. (Otherwise, additional buttons overlies the bottom button.)
4. Add any additional option buttons. Highlight any overlapping buttons—one at a time—and move them apart.

To give a field a shortcut key:

You can always select a field in a database structure by tabbing to it. You can also create a **shortcut key** (as part of the database definition) to select a field quickly in an open record.

- Include an ampersand when you define the field name. The letter it precedes will be underlined. For instance, specifying a field name as &Name makes the field name appear as Name. Its shortcut is **ALT**+**N**. (You cannot use the characters F, E, V, S, O, Q, H; they are already used by the system.)

- To use the shortcut, simultaneously press **(ALT)**+*underlined letter*. You can use the same shortcut key on different pages of the database.

To edit or delete a field in the Define New Database screen:

Key Label	Description
Edit	To change the name or the type of the current field. <i>You can change the type only if you have not yet saved this field in the database structure (by saving it with a file name).</i>
Delete	To delete the current field. (Also deletes any data associated with this field.)

Caution If you delete a field from a database structure, *this will also delete any Smart Clip definition or Subset definition that contained this field.*

To save and name the new database:

1. Press **(F10)** to save the database structure. (Or press **(ESC)** **(F5)** (No) to cancel the new database structure.)
2. Name the new database. The default file extension is .GDB (for General Data Base). You do not need to type in the extension.

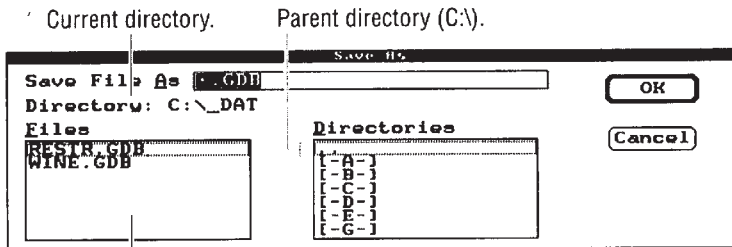

All of the files in the current directory ending in .GDB.

3. Press **(F10)** when done.
4. This displays the list for the newly defined database. Since there are no records yet, the list is empty except for some column

headers. You can now enter data into this database using **(F2)** (Add).

Example: Defining a Database for a Wine Collection. Define a database structure like this and name it WINE.GDB.

4

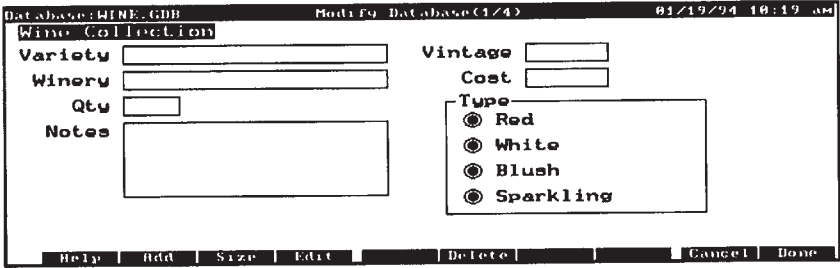

Keys:

(B...) **(B)**

(MENU) **(F)** **(D)**

Wine Collection

(ALT)+ (L) **(ENTER)**

Variety **(ALT)+ (T)**

(ENTER)

Winery **(ENTER)**

(ENTER) **(▶)**

(F2) Vintage

(ALT)+ (U) **(F10)**

(▶) ... (▲) (▲)

(F2) Cost **(F10)**

(▶) ... (▲)

Description:

Opens the Database application.

Starts the Define New Database procedure with an Add Field dialog box.

Adds the label "Wine Collection". Pressing **(ENTER)** is the same as pressing **(F2)**.

Adds a text field for the Variety.

Adds a Winery text field and moves it over to align with the previous field. **(ENTER)** **(ENTER)** are the same as **(F10)**.

Adds a Vintage number field.

Moves Vintage field to right of Variety field.

Adds a Cost number field.

Moves Cost field to right of Winery.

- (F2) Qty (F10) (▶)** Adds and aligns a Qty number field.
- (F2) Notes** Adds, narrows, moves, and deepens a Notes note field.
- (ALT)+(N) (F10)**
- (CTRL)+(◀) ...**
- (▶) (▶)**
- (CTRL)+(▼) ...**
- (F2) Type** Adds a Type group box.
- (ALT)+(B) (ENTER)**
- Red (ALT)+(O) (ENTER)** Adds a Red option button.
- White (ENTER)** Adds other option buttons and displays the database structure. The last two buttons overlie each other, making them illegible.
- Blush (ENTER)**
- Sparkling (F10)**
- (▼)** Moves last option button down.
- (⬆) (TAB)** Backtabs to highlight the Type group box.
- (CTRL)+(▼) ...** Enlarges Type box to hold all buttons.
- (F10)** Saves new structure definition.
- wine (F10)** Names this database file WINE.GDB in the current directory. Displays the new, empty database list, ready for data entry.

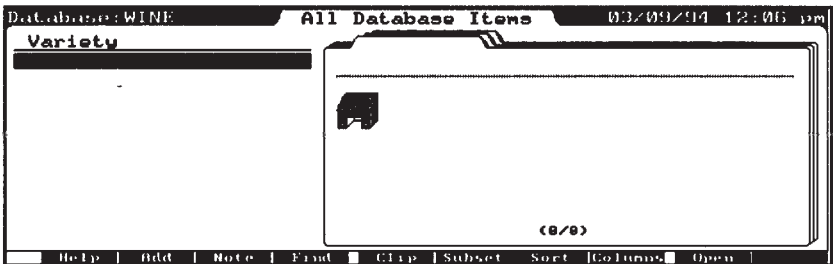

Once you have entered wines into the list, the data card will display specifics on the current (highlighted) wine.

Modifying a Database Definition

Follow these instructions to edit the definition of a database structure that has already been saved and named. The data set (if any) is not affected by a change to the name or position of a field.

4 To edit the database structure:

1. Display the database list of the file you want to edit. If the file is *not* currently displayed, use **(F9)** (Open) to display it. (Type in or select the database file name and press **(F10)**.)
 - Do *not* open a record or display a database structure.
2. Press **(F10)** **(F)** **(F)** (File Modify-Database).
3. Use the same techniques you used while defining the new database structure. When done, press **(F10)** to save the modified structure, or press **(ESC)** to cancel the modifications.

Key Label	Description
Add	Adds a new field.
Size	Size mode. Pressing arrow keys now changes the size of the current field. Shortcut: (CTRL)+ arrow key. Press MOVE to cancel Size mode.
Edit	To rename the current field <i>before it's saved</i> .
Delete	Deletes the current field.
arrow keys and (↑) arrow keys	Moves the current field, unless Size mode is on.

Note In order to protect any existing data, you cannot edit the field type once it has been saved in a database structure.

To restore the original database structure:

- Select **(F10)** Edit Undo before doing another operation. You can also undo an undo operation.

To duplicate a database structure:

This duplicates a database definition without its data. Do this if you want an identical or similar database definition for a new set of data.

1. If the database you want to copy is *not* currently displayed, use **F9** (Open) to display it.
2. Press **MENU** **F** **N** (File New).
3. Name the new database file and press **F10**.
4. The new database is now ready for you to modify or enter data.

Modifying the DataCard

The DataCard that shows up in your database list screen contains information from the record of the highlighted entry. When you create your database, the first 10 fields you add are by default put into the DataCard definition. Information from these fields will appear in the DataCard. You can change the DataCard definition, and you can altogether remove the DataCard from the list screen.

To customize the information on the DataCard:

The DataCard is simply a Smart Clip of the information on a data record. You can edit the existing definition of the DataCard Smart Clip using **F5** (Clip) from the database list screen. Note in the data card definition that - and = are formatting commands that render thin and thick lines. For more information on editing Smart Clips, see chapter 1.

To remove the DataCard from the database list screen:

1. Display the database list. Press **ESC** or **F10**, if necessary.
2. Press **MENU** **V** (View) to see the View commands.
3. The default state of the Show-DataCard option is on (checked). Press **D** to uncheck the box and remove the card from the list.

To restore the data card to the database list, press **MENU** **V** **D** (View Show-DataCard) to recheck the option.

Searching a Database

You search a database you create just like you search a Phone Book database: scroll through the database list (,) or look through sequential data records (`Next` , `Prev`). For specific searches, use `speed-locate` or `Find` , as explained on page 4-4.

4

Sorting Data Lists

By default, your database (including Phone Book) records are sorted in the list in order by the top left field of the record (which is the leftmost column). You can change

- Which field to use for sorting. The choice of field determines whether the sorting method is alphabetical (Text field), numerical (Number field), or chronological (Date and Time fields).
- Whether to sort in ascending (the usual) or descending order.
- Whether to have second and third sorting fields to break sorting ties (such as for two phone records named Dave Johnson).

To change the sorting method:

This affects just the current list (or the current subset of a list).

1. Display the list.
2. Press (Sort).
3. Select the first sorting field. Use to highlight your choice. (Use + to view the whole list.)
4. To change the order (ascending/descending), tab to the check box and press .
5. If you wish, tab to and specify second and third sorting fields.
6. Press when done. Or press to cancel the information.

Example: Types of Sorting in the Phone Book. If the sorting field is a Name field, sorting occurs alphabetically. Ascending means from A to Z, so Aardvark appears before Zebu in the list. If the sorting field is a number field, sorting occurs numerically. Ascending means from lower to higher, so 2000 appears before 2026. (Only numbers in number fields can be sorted numerically.) If the sorting field is a date or time field, sorting occurs chronologically. Ascending means from earlier to later, so 6/1/1993 appears before 6/1/1994.

Rearranging the Columns in Data Lists

You can customize the appearance of a database (including Phone Book) list by altering how many columns are displayed, how wide they are, and which data fields the columns represent.

For instance, you could change the appearance of a phone list from this:

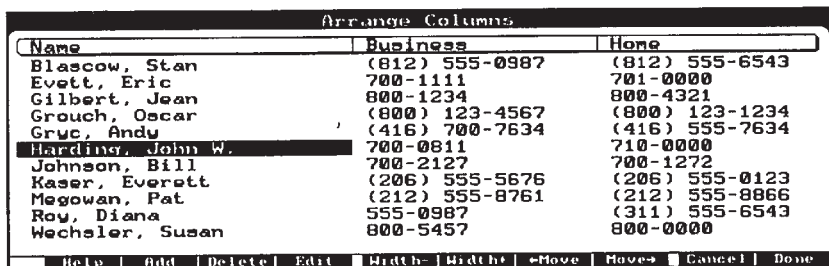

Name	Business	Home
Blascow, Stan	(812) 555-0987	(812) 555-6543
Evett, Eric	700-1111	701-0000
Gilbert, Jean	800-1234	800-4321
Grouch, Oscar	(800) 123-4567	(800) 123-1234
Gruc, Andy	(416) 700-7634	(416) 555-7634
Harding, John W.	700-0811	710-0000
Johnson, Bill	700-2127	700-1272
Kaser, Everett	(206) 555-5676	(206) 555-0123
Mogowan, Pat	(212) 555-8761	(212) 555-8866
Roy, Diana	555-0987	(311) 555-6543
Wechsler, Susan	800-5457	800-0000

to this:

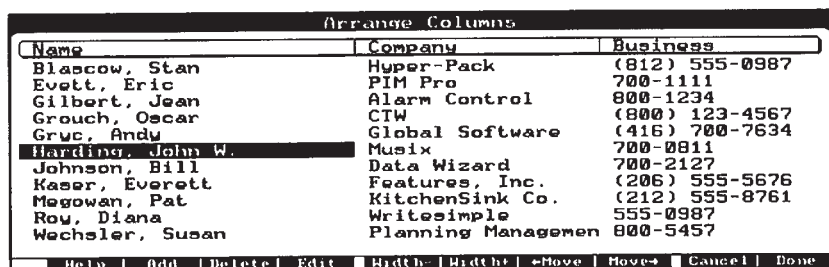

Name	Company	Business
Blascow, Stan	Hyper-Pack	(812) 555-0987
Evett, Eric	PIM Pro	700-1111
Gilbert, Jean	Alarm Control	800-1234
Grouch, Oscar	CTW	(800) 123-4567
Gruc, Andy	Global Software	(416) 700-7634
Harding, John W.	Musix	700-0811
Johnson, Bill	Data Wizard	700-2127
Kaser, Everett	Features, Inc.	(206) 555-5676
Mogowan, Pat	KitchenSink Co.	(212) 555-8761
Roy, Diana	Writesimple	555-0987
Wechsler, Susan	Planning Managemen	800-5457

To rearrange the columns in a list:

This affects just the current list (or the current subset of a list).

1. Display the list.
2. Press **(F8)** (Columns).
3. Highlight (arrow to) the column you want to alter or move.
4. Use the function keys described below.
5. Press **(F10)** to save the rearrangement. Or press **(ESC)** to cancel it.

Function Keys for Rearranging Columns (Columns)

Key Label	Description
Add	Adds a specified column to the right of the current column.
Delete	Deletes the highlighted column. Leaves a blank column on the right side.
Edit	Changes the highlighted column to the one you specify (by field name).
Width-	Narrows the highlighted column.
Width+	Widens the highlighted column.
←Move	Swaps positions with the column on the left.
Move→	Swaps positions with the column on the right.

Note Rearranging the columns affects the appearance of the list only. It does not affect the actual data in the records.

Defining Subsets of a Database

The `Subset` function displays a specified subset of your Database. You define the subset by filling out a database template according to the field contents you want to select for. For example, you could define a subset of the wine database that selects and displays only the white wines.

Note Defining subsets does not affect the original, complete list of records.

The `Subset` function does *not* create new or separate databases. It defines and displays a *subset of the current database*. Subsets have names, but they are not separate files.

Displaying Existing Subsets

To display an existing subset:

1. While displaying a database list, press **(F6)** (Subset).
2. Highlight the desired subset name and press **(F10)**.

To display the complete database list again:

1. While displaying the database list, press **(F6)** (Subset).
2. Highlight “All (Database, Phone Book, etc.) Items” in the list of subset choices and press **(F10)**.

Defining a New Subset

To define a subset:

You can define up to 16 subsets.

1. While displaying the database list, press **(F6)** (Subset).
2. Press **(F2)** (Define). The Define Subset screen displays a copy of the current database structure.
3. Fill in one or more fields with the contents you want to select for.
4. Press **(F10)**.
5. Type a name for the new subset and press **(F10)**. This displays the subset list with the new name highlighted. If you do not type in a name, then the new subset is named “Unnamed Subset”. However, the next unnamed subset will overwrite (replace) the previous one.
6. Press **(F10)**. This displays the new subset (whose name appears in the title bar).

Using Check Boxes and Option Buttons in a Subset Definition

- By default, check boxes in the Define Subset screen are dimmed. This means they are **neutral**; that is, either status (checked or not) in a record will qualify for the subset. Use **(spacebar)** to cycle through selected, not selected, or neutral (shaded).
- By default, option buttons are not on. This means they are **neutral**; that is, either status (on or off) in a record will qualify for the subset. (To specify that an option button *must be off* to qualify for the subset, you must use an SSL statement. See “Advanced Subset Selection” later in this chapter.)

- If a check box is checked or an option button is on, then a record that matches this status will qualify for the subset.

To set an option button in a subset definition:

- Tab and/or arrow to the option button you want and press the **spacebar**. (This is different from the usual way of setting an option button by arrowing.)
- You cannot turn on more than one option button.

Example: Defining a Database Subset. Define a subset of the restaurant database (RESTR.GDB) that displays only restaurants that are open all night. Save this subset under the name “All-Night Places.” To define this subset, check the All Night check box in the Meals group box.

Keys:

R... **B**

F9 restr **F10**

F6 **F2**

ALT+**T**

Description:

Opens the Database. If RESTR.GDB is not displayed, do the next step:

Displays the built-in restaurant database (though the list is empty if you haven’t added data records).

Opens the Define Subset screen, which is identical to the database structure.

Highlights the All Night check box and turns it on. The other check boxes remain dimmed (neutral).

Define Subset		
Restaurant <input type="text"/>		
Phone <input type="text"/>	Category <input type="text"/>	
Address <input type="text"/>		
Meals		
<input type="checkbox"/> Breakfast	<input type="checkbox"/> Lunch	
<input type="checkbox"/> Dinner	<input type="checkbox"/> Brunch	
<input checked="" type="checkbox"/> All Night		
Food Quality		
<input type="checkbox"/> Excellent		
<input type="checkbox"/> Good		
<input type="checkbox"/> Fair		
Cost		
<input type="checkbox"/> Expensive		
<input type="checkbox"/> Moderate		
<input type="checkbox"/> Inexpensive		
<input type="checkbox"/> Serves Liquor	<input type="checkbox"/> Good for Kids	<input type="checkbox"/> Vegetarian Menu
Note <input type="text"/>		
Help Cancel OK		

- F10** All-Night Places Names this subset “All-Night Places”.
- F10**
- F10** Displays this subset.
- F6** **▲** **F10** Selects and displays the complete database list again (“All Database Items”).

Using the Category Field

Information in the Category field of a record is often used to define a subset. For example, the Phone Book has two built-in (predefined) categories in the Category field: “Business” and “Personal”. You could specify one of these categories in each record to distinguish between business and personal Phone Book records.

The Category field is a list box that is editable and allows *multiple selections*. For instance, you can compose the multiple category “Business;SW Club;Local”. The list box maintains a list of all possible categories used in other records; you select from the list (or add to it) the category choices you want for each individual record, if any.

To use a Category list box:

- To open a category list box, tab to it (or press **ALT**+**G**) and press **▼**.
- To make a selection from the choices given, highlight the choice and press **spacebar**. The choice will be added to the text box. A semicolon separates multiple selections in the text box.
- To remove a selection, highlight the choice and press **spacebar** again.
- To close a category list box, press **ALT**+**▲** or **ESC**.

Define Subset			
Name			
Business		Home	
Alternate		Fax	
Title		Category	Personal
Company			Business
Address1			Personal
Address2			
City		State	Zip
Note			
Help		General	
		Cancel OK	

An Open Category Box

Note

Each database structure can have one Category field. Each Category field can have up to 32 category choices or 255 characters (no more than 128 characters per choice).

To edit a category list box:

- To add a category choice to the list, close the list box and type the new entry.
- To delete a category choice from the list, highlight it and press **DEL**.
- To de-select a category choice, highlight it in the list and press **spacebar**.

Example: Using the Category Field to Define Subsets. Create a personal phone list and a business phone list by defining two subsets based on the Category field in each Phone Book record.

For a record to appear in one of these lists, it must contain "Personal" or "Business" in its Category field. If a record belongs in *both* categories, then select (press **spacebar**) both categories.

The subset definition (Subset Define) for the personal phone list would look like this:

Define Subset Screen for a Personal Phone List

Name this subset “Personal” and a corresponding one “Business”.

When you want to display one of these subsets, press **Subset**, highlight the subset name, and press **(F10)**. (To display the original list again, select the subset named All Phone Book Items.)

Using Multiple Criteria in a Subset Definition

To define a subset with multiple criteria:

You can make a subset definition more sophisticated by filling out more than one field and/or by including more than one possible entry in a field. In the Define Subset screen,

1. If you want more than one field searched to compile the subset, then fill in as many fields as you want. *The subset will include only records for which all the specified fields qualify.*
2. If you want to specify more than one possible match for a field, then separate those possible matches with a comma. (A logical OR.)
3. If you want a subset to exclude a certain field entry, then precede that entry by a hyphen. (A logical NOT.)
4. If you want to specify a range of numbers, precede a number by $<$, $>$, $=$, $<=$, $>=$, or $<>$ (*not equal to*).
5. If you want to specify a criterion that could appear in *any* field, precede it with $*$. For example, entering $*English$ in the Restaurant field will select for “English” in any field in the record.

Field Selection Criteria Define Subset Screen

4

Definition in Field	Values That Qualify
empty	Any value in this field.
<i>value</i>	If this field contains the given value.
* <i>value</i>	If <i>any</i> field contains the given value.
<i>value, value</i>	If this field contains <i>either</i> of the given values.
<i>value&value</i>	If this field contains <i>both</i> of the given values.
- <i>value</i>	If this field does <i>not</i> contain the given value.
= <i>value</i>	If this field <i>exactly</i> matches the given value, with no extra characters. For example, =red will <i>not</i> match red and green or red;green.
< <i>value</i>	If this field has one of these unequal relations with the given value.
<= <i>value</i>	
> <i>value</i>	
>= <i>value</i>	
<> <i>value</i>	

Example: Defining a Subset with Multiple Criteria. The subset definition below will display a subset of the restaurant database. The subset will comprise restaurants in Paris that serve Algerian or Moroccan food of excellent quality.

Define Subset

Restaurant

Phone Category

Address

Meals <input type="checkbox"/> Breakfast <input type="checkbox"/> Lunch <input type="checkbox"/> Dinner <input type="checkbox"/> Brunch <input type="checkbox"/> All Night	Food Quality <input checked="" type="radio"/> Excellent <input type="radio"/> Good <input type="radio"/> Fair	Cost <input type="radio"/> Expensive <input type="radio"/> Moderate <input type="radio"/> Inexpensive
<input type="checkbox"/> Serves Liquor <input type="checkbox"/> Good for Kids <input type="checkbox"/> Vegetarian Menu		
Note <input type="text"/>		

Subset Definition with Multiple Criteria

Editing or Deleting Subset Definitions

To edit or rename a subset definition:

1. While displaying the database list, press **F6** (Subset).
2. Highlight the desired subset.
3. Press **F4** (Edit) or **F3** (Rename).
4. Make the changes and press **F10** when done.
5. Press **F10** again. This displays the edited subset.

To delete a subset definition:

1. While displaying the database list, press **F6** (Subset).
2. Highlight the subset you want to delete.
3. Press **F7** **F10** (Delete OK).

To restore a subset definition you have just deleted (or edited), escape the subset list, then select **MENU** Edit Undo. Use undo before doing another operation.

Advanced Subset Selection

The **General** function (**F2** in the Define Subset screen) lets you use the Subset Specification Language (SSL) to create subset criteria as command statements that are too complex for the Define Subset screen (such as comparing values in different fields).

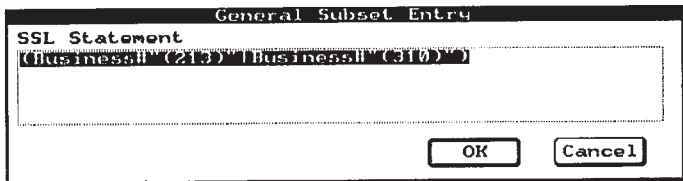

An SSL Statement

To see the SSL statement for a subset specification:

1. Press **F6** **F2** (Subset Define) and fill out the template, or press **F6** **F4** (Subset Edit) for an existing subset definition.
2. Press **F2** (General) if available.

SSL Syntax

SSL statements use relational operators and Boolean operators to select records for the subset. Spaces around operators are optional.

Relational Operators

4

Relational operators test the relationship between two arguments. The test usually compares a field (by its field name) with some value, but it can also compare two fields. The test is not case-sensitive. If the test result is true, then the record being tested passes the filter.

Arguments for Relational Tests

Argument	Description
<i>fieldname</i>	The field name must match the field name given in the record's template. If the field name has any non-alphanumeric characters, the name must be enclosed in { }. You can test any field with a relational operator <i>except</i> those with check boxes and option buttons.
<i>value</i>	There are three types of values: strings (enclosed in ""), numbers, and others (enclosed in { }). Other-type values are times, dates, and application-defined data types.

If a field and a value are compared, they must be of the same type (string, number, date, etc.).

Relational Operators

Operator	Meaning	Example
=	Does field match exactly another field or value?	City="Boston" Home=Business
<>	Does field <i>not</i> match exactly another field or value?	Score<>0
<, <=	Is field less than or equal to the value?	Date< {10/12/92} Income<=25000
>, >=	Is field greater than or equal to the value?	{Start Time}> {12:00a} Latitude>=0
->	Is the field a member of the given set of strings? The set is either the given values or a range of values. A range is two values separated by .. (includes boundary values).	State-> "MI", "OH" Zip-> "97000" .. "97999"
#	Does the field contain the given value?	Phone# "(503)" Note# "Cougar"
!field#	Does the field <i>not</i> contain the given value?	!City# "Detroit"

Testing Check Boxes and Option Buttons. Although check boxes and option buttons are not operators, their states (on/off) can be tested to yield a Boolean result (true/false). For example, `Enabled` tests whether the Enabled check box (for an alarm) is checked.

Boolean Operators

Boolean operators act on relational operations to negate, extract, or combine results when filtering records to create a subset. If a test result is true, then the record being tested passes the filter. Boolean operators have lower precedence than relational operators.

Boolean Operators (in order of precedence)

Operator	Example	Selects Record If:
! (NOT)	!Phone# "503"	Phone field does <i>not</i> contain (503).
	!Enabled	The alarm is <i>not</i> enabled.
& (AND)	State="VA" & City<>"Richmond"	State is VA but City is <i>not</i> Richmond.
(OR)	State="HI" State="AK"	State is either HI or AK.

To apply an operation on a string to any field:

- Use *"*string*" to select records containing the specified string.

For example, to select (for a subset) all phone records with the dialing prefix 750 in any field, enter the SSL statement *"750".

Comparison of SSL and Define Subset Screen

Define Subset screens are translated internally to SSL statements for interpretation of the subset criteria. The following table compares the two methods of subset definition: using the Define Subset screen and using the General function (SSL statement) to define some subset criteria in the Category field. (SSL statements may include parentheses to clarify order of operation.)

Examples Comparing Define Subset and SSL in Definitions for the Category Field

Define Subset	SSL Statement	Selects Record If:
red,green	Category#"red" Category#"green"	Category field contains red or green or both.
-red	! Category#"red"	Category field does <i>not</i> contain red .
-red,green	! Category#"red" Category#"green"	Category field contains green or does <i>not</i> contain red .
red & green	Category#"red" & Category#"green"	Category field contains both red and green .
=red,green	Category="red" Category#"green"	Category field matches exactly red or contains green .
*red,*green	*"red" *"green"	Any field contains red or green or both.

SSL Examples

This SSL statement defines a Phone Book subset for all Massachusetts phone numbers and all phone numbers without area codes:

```
Phone#"(508)" | Phone#"(617)" | !Phone#"("
```

This SSL statement defines a Phone Book subset for all West Coast business clients:

```
State->"CA", "OR", "WA", "BC" & Category#"Business" &  
Category#"Client"
```

This SSL statement defines a Phone Book subset for all suppliers in major western Oregon cities:





```
Category="supplier" & State#"OR"  
& City->"Portland", "Salem", "Eugene", "Medford"
```

Limits While Using the Phone Book and Database

- Maximum number of records (items) in a Phone Book file: limited by available disk space. Theoretical maximum: about 5,000.
- Maximum number of data characters per text field: $1\frac{1}{2}$ times the visible length, or at least 10.
- Maximum number of data characters in a Note: 32 KB (about 30 screens).
- Maximum number of choices in a Category field: 32 (or 255 total characters, with no more than 128 characters per choice).
- Maximum number of fields per database structure: 99 (fewer if long fields).
- Maximum number of pages in a database structure: 4.
- Maximum number of subsets in a database: 16.

Phone Book and Database Function Keys

Function Keys for Define-New-Database and Modify-Database

Key Label	Description
Add	Opens a dialog box to define a new database field.
Size	Turns Size mode on. Pressing  ,  ,  , and  now enlarges or diminishes the current field. Shortcut:  +arrow key.
Move	Turns Size mode off. Pressing arrow keys now moves the current field.
Edit	Opens a dialog box to edit the current field.
Delete	Deletes the current field.

Function Keys for the Phone and Data Lists

Key Label	Description
Add	Opens a template to add a new Database record.
Note	Displays the full-screen Note for the highlighted item, <i>if the current database has a Note field.</i>
Find	Searches for the specified character string (letters or other characters).
Clip	To copy predefined fields (a Smart Clip) from a database to the Clipboard. Also to define new Smart Clips and to edit the data card. See page 1-28. Smart Clip definitions are also used in Custom Style printing.
Subset	To display and/or define a specified subset of the data list.
Sort	Specifies how to sort the records for the list.
Columns	Specifies how many columns appear in a list, how wide they are, and which fields they display.
Open	To open a different Database file.

Function Keys for a Phone and Data Record (an Item)

Key Label	Description
Add	Opens a structure to define a new Database record.
Note	Displays the full-screen note, <i>if the database structure has a Note field.</i>
Find	Searches for the specified character string (letters or other characters).
Clip	To copy predefined fields (a Smart Clip) from a database to the Clipboard. Also to define new Smart Clips.
Prev	Displays the previous record.
Next	Displays the next record.

Function Keys for Defining Subsets and Smart Clips

Key Label	Description
Define	To define a new subset or Smart Clip.
Rename	To rename the highlighted subset or Smart Clip definition.
Edit	To edit the highlighted subset or Smart Clip definition.
Delete	To delete the highlighted subset or Smart Clip definition.

4

World Time

Press **[R...]** **[T]** to start World Time. World Time is a database of cities, including information about

- Local time and Daylight Savings Time.
- Location on a map, with latitude and longitude.
- Telephone dialing prefixes.

You can also create your own list of cities, called Custom Cities.

City Lists

-- You define this.

If this is??:?? , define the local city.

WorldTime:WORLD		All Cities	01/10/94	6	26 pm
Local City					
Greenwich	United Kingdom	6:26 pm			
All Cities					
Aarhus	Denmark	✓	7:26 pm		
Abadan	Iran		9:56 pm		
Abidjan	Ivory Coast, R. of		6:26 pm		
Abu Dhabi	United Arab Emirates		10:26 pm		
Acapulco	Mexico	✓	12:26 pm		
Accra	Ghana		6:26 pm		
Addis Ababa	Ethiopia		9:26 pm		
Adelaide	Australia	*	+	4:56 am	
Aden	Yemen A.R.		9:26 pm		

Current city.

[▲] and **[▼]** move the highlight bar. **[ENTER]** opens the record.

List of All Cities (All)

Symbol	Meaning
☼	Daylight Savings Time is on.
+	Time is tomorrow.
-	Time is yesterday.
✓	City is also in Custom Cities list.
📌	Note is included.

5 To open a city's record:

- In a city list, highlight a city (use or , or simply start typing the city's name) and press .

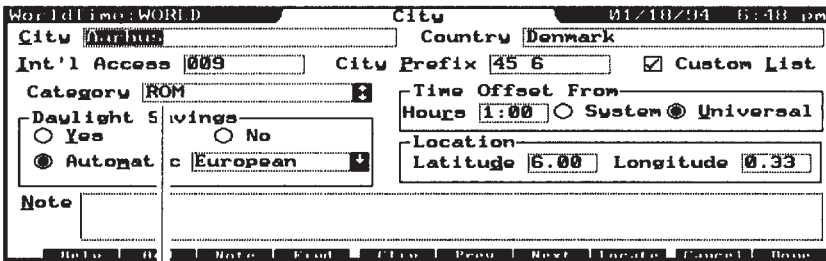

A built-in city.

Press to see the previous or next city record.

A City Record

To look up a city (speed-locate):

1. Display a city list. (Press or , if necessary.)
2. Start typing the name of the city. The list scrolls as you type, highlighting the first matching city.
3. Press when done, or arrow to the city you want.

The speed-locate operates as it does in the Database and the Phone Book.

Specifying Your Local City

Your local city is the reference point for the World Time application.

Example: Specifying the Local City. Select Chicago as your local city. (Substitute a city in your time zone, if you like.)

Keys:

(R...) **(T)**

chi

(F7) **(F10)**

Description:

Starts World Time. (If the All Cities list isn't displayed, press **F11** (**(F9)**) to see it.)

Highlights Chicago. (The list scrolls as you type, highlighting the first matching city.)

Selects Chicago as the local city and updates the system time to the time in Chicago.

The first time you set your local city, its time is set from the palmtop's clock setting, called the **system time**. If you change the local city to a city in another time zone, you'll be asked if you want the system time automatically changed to reflect the difference in time zones. If you respond **YES**, remember that alarms and appointments will come due based on the time in the new local city.

Adding a City to World Time

Since the All Cities list does not include every location in the world, you can add other cities to the list.

To add a city:

1. In World Time, press **(F2)** (Add).

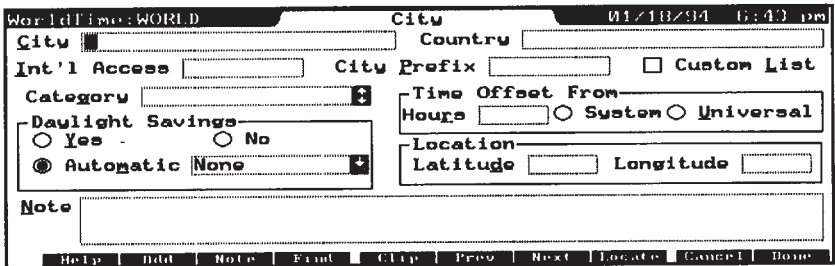

2. Fill in the fields. (Use **(TAB)** or **(ALT)+letter** to move among fields.)
City and Country.
International Prefix. Optional. The international telephone access code for dialing *out of* this city.

City Prefix. Optional. Telephone dialing prefixes to reach this country and city.

Custom List. Check this box (press **spacebar**) to include this city in the Custom Cities list, as well as the All Cities list.

Category. Optional. Includes a list of any categories used for other cities. You can enter a new category or press to see the full list and select an existing category. You can categorize the cities in any way you want, and use this information later to view a **subset** of cities. The category "ROM" means that that city belongs to the original All Cities list.

Time Offset From. Number of hours' difference between this city's time and either the current palmtop time ("System") or Greenwich Mean Time ("Universal"). If the offset is *positive*, then the city's time is *later than* System or Universal time; if the offset is *negative*, then the time is *earlier*. The time offset is for *standard time* only, not daylight savings time.

Daylight Savings. Can be set to be always on (Yes), always off (No), or to automatically switch. The Automatic schedules available are for North America, Southern Hemisphere, and Europe.

Location. Optional. The easiest way to fill this in is to use the **Locate** function (). Use the arrow keys to pinpoint the city's location, then press . (The values shown are degrees and decimal fractions thereof, *not* degrees and minutes.)

Note. The Note field provides a large field for any additional information. Pressing **Note** displays a full-screen note.

3. Press when done. Or press to cancel the information.

Tips

- If you are adding a series of records, press just instead of between records. This saves the current record *and* opens a new template.
- The fields can hold more than the window displays. Press or to view long fields.
- If you don't know a new city's time offset, then look up a city of the same time zone in the All Cities list and note its time difference from Universal time.
- The Category field is useful for categorization and viewing subsets. For example, you could indicate here the official language, and later display a list of Spanish-speaking locales.

Editing or Deleting a City

To edit (change) a city:

1. Display a city list: if necessary, press **F9** (Custom or All).
2. Highlight the city you want to edit.
3. Press **ENTER** to open the record.
4. Edit the fields. (Use **TAB** or **ALT**+underlined letter to move among fields.)
 - To clear a field, highlight it and press **DEL**.
 - To restore a field's previous contents, press **ESC**.
5. Press **F10** to save your changes. Or press **ESC** to cancel them.

To delete a city:

Deleted cities are removed from both All Cities and Custom Cities lists.

- Highlight a city and press **DEL**.
 - If the city belongs to the original version of the All Cities list, the original version is restored. (Original records in ROM cannot be deleted.)
 - If the city is one you added, it is completely deleted.

You can select multiple cities (use **spacebar**) and delete them all at once.

To restore the just-deleted cities, press **DEL** **E** **U** (Edit Undo).

Creating Your Own City List (Custom Cities)

The Custom Cities list allows you to define your own list of cities. You can compile this list by checkmarking cities in the All Cities list or by checking the Custom List box in a city's record.

To put a city in the Custom Cities list:

1. Display the All Cities list (press **F11**, if necessary).
2. Highlight the city you want to put in the Custom Cities list.
3. Press **+**. This places a checkmark after the name, indicating that this city is now in the Custom Cities list, as well.

Albuquerque, NM

USA

✓

12:19 PM

Press **F9** (Custom) to display your Custom Cities List.

To remove a city from the Custom Cities list, highlight the city and press **-**.

Using the Map

To see a city on the map:

1. In a city list, highlight the city.
2. Press **F10** (Map).
3. To open the city's record, press **ENTER**.

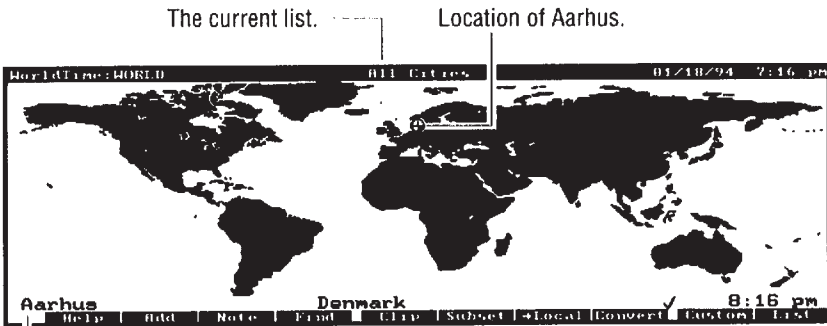

Pressing **▼** or **▲** changes cities.

Pinpointing a City on a Map (MAP)

To display a list again, press **F10** again.

Converting Times Across Time Zones

Time conversions let you pick any time in a city and find out the corresponding time elsewhere. For instance, you can find out what time it is here when it is 5:00 p.m. in Barcelona. Actually, you can see what time it is *in any city* when it is 5:00 p.m. in Barcelona.

5

To specify a time in a city and temporarily convert the time for all other cities:

1. Select the city: either highlight it in a city list or display it on the map.
2. Press **(F8)** (Convert).
3. Type in the time as *hours.minutes*. (A period serves as well as a colon.) In the 12-hour time format, typing *a* indicates a.m., *p* p.m.

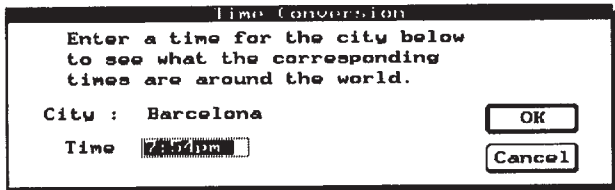

4. Press **(F10)**. This displays the corresponding times in your local city and in all other cities. A + before the time means the time is *tomorrow*, while a - means the time is *yesterday*.
5. Press **(ESC)** to return to the normal display (current times).

About the Settings for Daylight Savings Time

The three daylight savings time (DST) settings are:

- **Yes:** For locations that are always on DST. Also for cities that are currently on DST, but will go off it on an irregular schedule. (You then change the setting yourself.)
- **No:** For locations that do not use DST. Also for cities that are currently off DST, but will go onto it on an irregular schedule. (You then change the setting yourself.)
- **Automatic:** For locations that go onto and off of DST on a regular schedule. These schedules are provided:
 - Northern:** The schedule used in most of North America (first Sunday in April to last Sunday in October).
 - Southern:** The schedule used in most of the southern hemisphere (last Sunday in October to first Sunday in March).
 - European:** The schedule used in most of Europe (last Sunday in March to Last Sunday in September).
 - None:** The same as No DST.

Note

For convenience' sake, some countries have an Automatic DST setting even if their schedule does not exactly match the defined one.

To change the DST setting (a shortcut):

If you want to change the DST setting for several cities, it is faster to use this shortcut than to change the city's record.

1. Display a city list and highlight the city.
2. Press to change the setting. cycles through the three settings: Yes (Y), No (N), and Automatic (A).
3. Repeat for the next city. The change is made to the city's record, and so it affects both city lists (All Cities and Custom Cities).

Using Subsets of the City List

Using **Subset**, you can display a **subset** of the All Cities list that meets any criteria you specify. For example, you could display just those cities in a certain country, or just those cities that don't use daylight savings time.

For instructions on using the Subset feature, see page 4-18 or the online Help.

Example: To Define the Subset: All Cities in Mexico. Create a subset that displays all the cities in Mexico.

1. Press **(F6)** (Subset) **(F2)** (Define). Fill in just the Country field, leaving all other fields neutral. "Neutral" means that any status will qualify for the subset. (The dimmed Custom List check box is neutral.)

Define Subset

City Country

Int'l Access City Prefix Custom List

Category

Time Offset From

Hours System Universal

Daylight Savings

Yes No

Automatic

Location

Latitude Longitude

Note

Help General Cancel OK

The Subset Definition: Cities in Mexico

2. Press **(F10)**, name the subset Mexico, then view it: Mexico **(F10)** **(F10)**.

Name of subset.

5

WorldTime: WORLD			Mexico	01/18/94	8:06 pm
Local City					
Greenwich	United Kingdom	8:06 pm			
Mexico					
Acapulco	Mexico	✓	2:06 pm		
Campeche	Mexico		2:06 pm		
Cancun	Mexico		2:06 pm		
Ciudad Victoria	Mexico		2:06 pm		
Durango	Mexico		2:06 pm		
Ensenada	Mexico		12:06 pm		
Guadalajara	Mexico		2:06 pm		
Hermosillo	Mexico		1:06 pm		
La Paz	Mexico		1:06 pm		

The List of Cities in Mexico

3. To display the All Cities list again, press **F9**.

Copying or Moving Information

You can use the Clipboard functions to copy and move information within World Time, as well as to and from other applications. You can also use Smart Clip (**CliP**) to copy formatted information quickly from *predefined fields* in the current application to another location. The clipping features are described in chapter 1.

Limits While Using World Time

- Maximum number of cities in a list: limited by available RAM disk space. Theoretical maximum: about 5,000. (All Cities list has about 480 cities to begin with.)
- The association of some cities with certain countries is currently in flux, such as in eastern Europe and the former Soviet Union. The countries given here were correct at the time of this writing, but could change. You can edit a city's record if its country changes.
- The latitude and longitude values are accurate to one-third of a degree. The values are given with decimal fractions of a degree.
- Maximum characters in a Note: 32 KB (about 30 screens).

World Time Function Keys

Function Keys for a City List or Map

Key Label	Description
Add	Opens a template to define a new city.
Note	Displays the full-screen Note for the highlighted city.
Find	Searches for the specified character string (letters or other characters).
Clip	To copy predefined fields (a Smart Clip) from World Time to the Clipboard. Also to define new Smart Clips. Smart Clip definitions are also used in Custom Style printing. See page 1-28.
Subset	To display and/or define a specified subset of the city list.
→Local	Sets the highlighted city as the local city.
Convert	Converts times across time zones.
Custom	Displays the Custom Cities list. (Toggles with All .)
All	Displays the All Cities list. (Toggles with Custom.)
Map	Displays the map if a list is visible. (Toggles with List.)
List	Displays the current list if the map is visible. (Toggles with Map .)

Function Keys for a City Record (an Item)

Key Label	Description
Add	Opens a template to define a new city.
Note	Displays the full-screen note field for this record.
Find	Searches for the specified character string (letters or other characters).
Clip	To copy predefined fields (a Smart Clip) from World Time to the Clipboard. Also to define new Smart Clips.
Prev	Displays the previous city's record.
Next	Displays the next city's record.
Locate	Pinpoints the location of the current city on the map. Moving the cross hairs changes the latitude and longitude specified for the current city.

The Stopwatch

Press **[&...]** **[W]** to start the Stopwatch application, which has a stopwatch, countdown timer, and alarm clock.

Countdown time in minutes
(or hours:minutes).

Time elapsed for stopwatch.

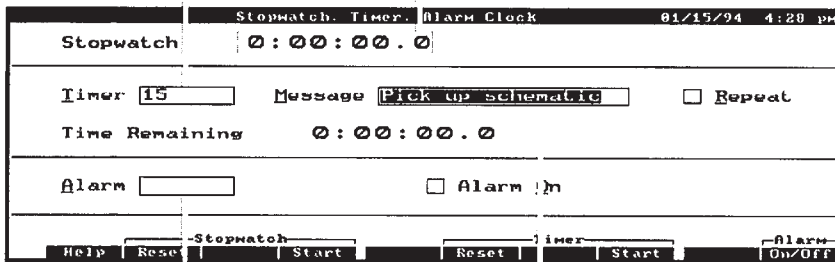

Clock time for alarm.

Optional. Displayed when
countdown time = zero.

The Stopwatch, Countdown Timer, and Alarm Clock

To use the Stopwatch:

1. Press **[F2]** to reset the time to zero, if necessary.
2. Press **[F4]** to start time counting.
3. Press **[F4]** to stop counting. (Press **[F4]** again to restart.)

If the stopwatch reaches 24 hours, it resets to zero and continues.

To use the Countdown Timer:

1. In the Timer field, enter the number of minutes (or *hours:minutes*) to count down.
2. Optional: tab to the Message field and change the message to be displayed when the countdown reaches zero.
3. If you want the Timer to continue repeating the countdown until you stop it, tab to the Repeat check box and press **[spacebar]**.

4. Press **F8** to start the countdown.
5. Press **F8** to stop the countdown, if necessary.
6. Press **ENTER** or **ESC** to erase the message at the end of the countdown.

The countdown either stops at zero (the default) or continues counting negatively, depending on the setting of **Timer Stop-Timer-at-Zero**.

To cause the Countdown Timer to count past zero (negative time):

- Press **Timer** **T** **Z**. This removes the checkmark next to the Stop-Timer-at-Zero command.

Repeat these steps to check the setting, causing the Timer to stop counting at zero.

To stop the Countdown Timer at any time:

1. Press **F8**.
2. Press **F6** to reset the Timer's countdown time as specified. (This does not *start* the countdown.)

To use the Alarm Clock:

1. Press **ALT**+**A** and enter the clock time for the alarm.
2. Press **F10** to set the alarm. This checks the Alarm On check box.

When the alarm goes off, press any key to stop the alarm.

To cancel an alarm that is set, press **F10**. This removes the check from the Alarm On check box.

The Memo Editor

Press **(F2)** to start the Memo Editor. Each memo you create is a separate file.

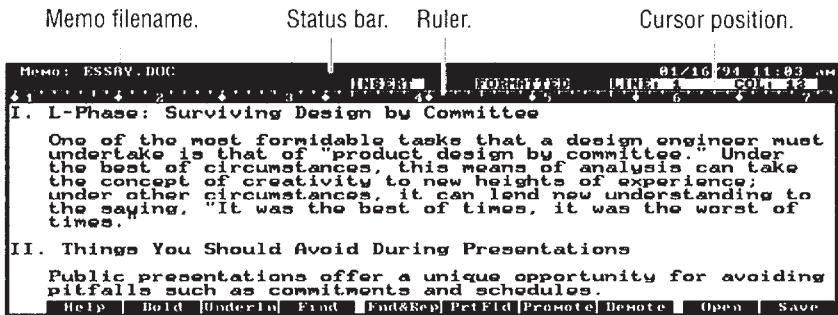

The Memo Editor is a text editor with these formatting features:

- Automatic word wrapping at the ends of lines (no need to press **(ENTER)**).
- Bold, underline, and normal typefaces.
- Different font sizes for the display.
- Settings for tabs, margins, and display spacing.
- Insert mode (inserts text) and Replace mode (writes over text).
- Outline (hierarchical) numbering available.
- Formatted and unformatted (ASCII) file status.

Creating a Memo

Each memo you create is a separate file.

To start a new memo:

1. Press **(F1)** to start the Memo Editor.
2. If the screen shows no text, you can start typing immediately. You will name the memo later when you save it.
3. If another memo is already displayed, press **(DEL)** **(F)** **(N)**. The File New command automatically closes any open file first, prompting you to save it, if necessary.
4. Write your memo text.

Editing a Memo

Keys	Description
(Fn) INS	Toggles between Insert mode and Replace (type-over) mode for text entry.
(CTRL) + (Fn) INS	Inserts a line.
(CTRL) + (DEL)	Deletes a line.
(CTRL) + (ENTER)	Breaks to a new line, even in Replace mode.

Moving Around a Memo

Keys	Description
(Fn) PG UP, (Fn) PG DN	Moves backward or forward in memo by one screenful.
(Fn) HOME, (Fn) END	Moves to beginning or end of line.
(CTRL) + (←) , (CTRL) + (→)	Moves backward or forward one word.
(CTRL) + (Fn) HOME, (CTRL) + (Fn) END	Moves to beginning or end of memo.
(TAB)	Moves cursor to next tab stop.

To “stamp” the current date or time in a memo:

- Press **Fn** DATE or **Fn** TIME. This inserts the current date or current time at the position of the cursor.

Date and time stamping are different from date and time print fields. Print fields insert codes into the memo that are interpreted only during printing.

Saving Memo Files

Any changes to a memo file are not saved on the RAM disk until you complete the save procedure.

To save a memo:

1. Press **F10** when the memo is done or you want to save what you’ve written so far.
2. If the memo is new and has no name yet, you’ll be prompted to name it: Type a new file name of up to 8 characters and press **ENTER**. The Memo Editor automatically appends .DOC to the file name. (To enter a name *without* a file extension, include a final period after the name.)

If you want to save the file in a different directory or drive than the current one, type the full path name in the box, such as A:\BUDGET\NEWMEMO.

To back up a memo onto a memory card:

This copies the current memo file to a memory card in drive A, the plug-in slot.

1. Open the memo file you want to back up.
2. Press **Ctrl** **F** **A** (File Save-As).
3. Specify a new or existing file on drive A (**Alt**: \filename) for the backup copy.
4. Press **F10**.

Saving Memos as ASCII Text Files

Memo Editor files are one of two types:

- **Formatted.** The file contains all the formatting information of the Memo Editor's features: margins, headers, typeface, outlining, and so on.
- **ASCII (Unformatted).** An ASCII file is just characters (letters, numbers, spaces). *It has no formatting*, other than line breaks (made by pressing **ENTER**). The margins are automatically set at 9 and 72.

A new file is ASCII until you enter some formatting information.

If you want to create or edit a file for use in another program (whether a palmtop application or not), you should save it as an ASCII (unformatted) file. *Programs other than the Memo Editor cannot read a Memo-Editor-formatted file.* For instance, if you wanted to transfer a memo from the palmtop to a PC with WordPerfect, you should transfer it as an ASCII file.



To save a memo file as an ASCII file:

When you want to save or convert a memo file to ASCII, you can either change the file from formatted to ASCII (same file name), or create an ASCII copy of the formatted file (new file name).

1. Press **☰** to start the Memo Editor.
2. Open the file you want to convert.
3. Press **☰** **F** **A** (File Save-As).
4. Accept the given file name (to alter the current file) or type a new one (to make an ASCII copy). (This does not affect the memo you see on the screen, it affects the version saved on disk.)
5. Check the ASCII check box (**TAB** **spacebar**).
6. Press **F10** to save the new format (or **ESC** to cancel it).

Tips





- To make it easy for you to distinguish formatted and ASCII files by their file names, you could change the file name extension for each ASCII file from .DOC (the default for a Memo Editor file) to something else, such as .TXT. (The Memo Editor can detect the status of a file regardless of its extension.)

- The Save As dialog box also appears the first time you save a file, since you must give a new file a name. The ASCII check box appears unchecked if the file has any formatting information in it; otherwise it appears checked.
- A shortcut for  File Save-As is  .





Settings for Saving Memo Files

To turn auto-saving on or off:



Auto-saving automatically saves the current state of the current memo every few minutes.

1. In the Memo Editor, press    (Options Setup).
2. Press the  to check or clear the Auto-save check box.
3. If you're turning auto-saving on, tab to the Frequency box and enter the number of minutes between auto-saves.
4. Press  when done.

To change the default memo file name extension:

1. In the Memo Editor, press    (Options Setup).
2. Tab to the Default File Extension box and enter the new file name extension to replace .DOC as the default when you save and open files.
3. Press  when done.

Password Protection for Memos

You can set or change a password for a memo by pressing   . Password protection for a memo takes effect the first time the memo is saved after the password has been set. Note that when you copy a file, its password (if any) is copied, too. Password protected files can be deleted, but a forgotten password cannot be removed from a file.

Formatting a Memo

To start boldface, underlined, or bold underlined text in a memo:

1. Press **F2** (boldface), **F3** (underlining), or **F2 F3** (bold underlining) to start the new typeface.
2. Type the text you want in that typeface.
3. Press **F2** to stop boldface, **F3** to stop underlining, or **F2 F3** to stop bold underlining.

To change the typeface of existing text:

1. Highlight the text you want to change by simultaneously pressing **↑** and an arrow key.
2. Press **F2** for boldface and/or **F3** for underlining.

To set headers and footers:

1. Press **END** **T** **H**. (Use **TAB** to move among the fields.)
2. Enter the text for the header and/or footer you want.
3. Press **F10** (or **ESC** to cancel).

To set the margins:

The space for the left margin does not appear in the display, though it is shown on the ruler. The left margin does appear on the printed page. This setting applies to the current file only.

1. Press **END** **T** **M** (Format Margins).
2. Fill in the fields.
 - Left sets the number of columns (or characters) of indentation from the left side of a page.
 - Right sets the last available column on the right side of the page.
3. Press **F10** when done. (Or **ESC** to cancel the settings.)

To set or delete a tab stop:

1. Press **END** **T** **T**.
2. Use the left and right arrow keys to position the vertical bar to the location for a tab stop.
3. Press **F4** to set the tab or **F5** to delete it.

To insert a page break (for printing):

1. Press **MEMO** **E** **I**.
2. Highlight Page break and press **F10**.

To add page numbers (for printing):

1. If you want the page numbers to appear in a header or footer on each page, press **MEMO** **T** **H** (Format Header/Footer).
2. Press **F6** (PrntFld).
3. Select "Page number field" and press **F10**. The code **▶PAGE** appears. This is converted to the actual page number during printing.
4. If you need to close the Header/Footer dialog box, press **F10**.

To add date and time fields (for printing):

1. If you want the date or time field to appear in a header or footer on each page, press **MEMO** **T** **H** (Format Header/Footer).
2. Press **F6** (PrntFld).
3. Select "Date field" or "Time field" and press **F10**. The code **▶DATE** or **▶TIME** appears. This is converted to the date or time at the time of printing.
4. If you need to close the Header/Footer dialog box, press **F10**.

Editing or Reading a Memo

To open an existing memo:

1. Press **MEMO** **F** **O**.
2. Type its file name and press **ENTER**. The File Open command automatically closes any open file, prompting you to save it if necessary.

To re-open one of the last two memos opened:

1. Press **MEMO** to start the Memo Editor.
2. Press **MEMO** **F** **1** (or **MEMO** **F** **2**).

To delete a block of text:

1. Hold down **↑** and press an arrow key until all the text you want to delete is highlighted.
2. Press **DEL**.

You can also use CUT as described in the following procedure.

To CUT, COPY, PASTE:

The Clipboard holds text that has been “cut” (erased) or copied so that it can be “pasted” back in. The Clipboard keys are shown in purple on the keyboard (for instance, you press **Fn** then **.** to execute a cut).

1. Select the text of interest by highlighting it: place the cursor at the beginning of the text region, then simultaneously hold down **↑** and press an arrow key until the text you want is highlighted.
2. Press **Fn** COPY (to copy) or **Fn** CUT (to delete or to move text). Both COPY and CUT move the highlighted text into the Clipboard buffer.
3. If you want to copy or move the text, move the cursor to the new location to insert the text.
4. Press **Fn** PASTE to copy the selected text into place.

If you CUT something by mistake, press **Fn** PASTE to restore it.

To save editing changes:

- Press **F10** (Save).

To cancel editing changes:

If you are using the Auto-save option, only the changes since the last auto-save can be canceled (not saved).

1. Press **Ctrl** **Q** to quit the Memo Editor. A dialog box will ask whether you’d like to save the changes to the current file.
2. Press **F5** (No).

Copying or Deleting Information

Smart Clip: Copying Multiple Fields from Records

Smart Clip uses the Clipboard to copy information quickly from the current application to another one. For example, you might want to copy a name and phone number from the Phone Book into a memo. (For more information, see also page 1-28.)

To clip information from another application into a memo:

1. Start the application you want to copy from.
2. Select the records (highlight and press **spacebar**) whose information you want to clip. (To select or de-select all records in the current list, press **Ctrl** **E** **A**.)
3. Press **F5** to display the Smart Clip list.
4. Highlight the Smart Clip you want and press **F10**.
5. Open the memo you want to copy to.
6. Place the cursor where you want the information to be copied.
7. Press **Fn** **PASTE**.

Example: Clipping Appointment Information into a Memo.







Suppose you are writing a memo and would like to include information about an appointment. You can use Smart Clip to quickly copy that information into your memo. (Note that in the Appointment Book, you can clip only one record at a time.)

1. Leave the memo and the Memo Editor open.
2. Press **Q** and open the appointment record you want (highlight it in the list, press **ENTER**).
3. Press **F5** (Clip) and select the Smart Clip for "All Fields, No Notes". Press **F10** when done.
4. Press **⏏**, position the cursor where you want to insert the information, and press **Fn** **PASTE**.

Deleting, Copying, or Inserting Memos







To delete a memo file:

Use the Filer application to delete files.

1. Press  to start the Filer.
2. Highlight the file to delete. If it is not in the display, you might need to open its directory first: highlight the name of the directory and press .
3. Press   . Press  to confirm.





To rename a file, use the Filer application's File Rename command.

To copy a memo file:

1. Press  to open the Memo Editor.
2. Open the memo to copy, if it is not already displayed.
3. Press    (File Save-As).
4. Type the new file name for the copy in the Save File As box.
5. Press  to create the copy (or  to cancel).

To insert another file into a memo:

Insert only other memo (.DOC) or ASCII files into a memo.

1. Press  to open the Memo Editor.
2. Open the memo that will receive the insertion.
3. Press    (File Insert).
4. Enter the name of the file you want to insert into the current memo.
5. Press  to insert the file.

Searching a Memo File

To find any piece of text in a memo:

1. With a memo open, press **F4** (Find) and fill out the dialog box.
2. Press **F4** (Next) to search forward or press **F3** (Previous) to search backward from the current position.

To repeat the search, press **↶** **F4**.

To find and replace any piece of text:

1. From the beginning of a memo, press **F5** (Fnd&Rep) and fill out the dialog box.
2. Press **F4** (FindNxt). This starts the search from the current position.
 - To replace the found text, press **F5** (Replace).
 - To leave the found text unchanged, press **F4** (FindNxt).
 - To automatically replace all text that matches, press **F6** (Rep All).

To go to (move the cursor to) a specific line in a memo:

1. With a memo open, press **GNU** **S** **G** (Search Goto-Line-Number).
2. Type in the line number and press **F10**.

You can find the line number of the cursor's current position in the status line (upper right).

Options for Displaying the Memo

To change the size of the characters in the display:

- Press **Fn** **ZOOM** (or use **GNU** **View Character-Size**). This cycles through three different display sizes:
 - 40 columns by 16 lines (biggest print).
 - 64 columns by 18 lines (default).
 - 80 columns by 25 lines (smallest print).

To change the spacing between lines in the display:

1. Press **ESC** **V** **Z** (View Character-Size).
2. Press **TAB** to select the Display Line Spacing box.
3. Enter a number, 1 through 9. This sets the number of **pixels** between lines. A pixel is one dot on the screen.
4. Press **F10** (or **ESC** to cancel).

This setting does not affect printing.

To display or hide the ruler:

The ruler marks column numbers, margins, and tab settings.

- Press **ESC** **V** **R** (View Ruler). This toggles the ruler on and off.

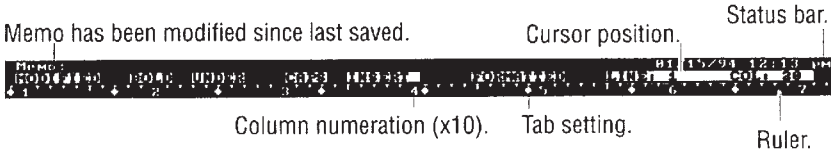

To display or hide the status bar information:

The status bar tells you whether the current file has been **MODIFIED** since last saved, has **BOLD**face and/or **UNDER**lining on, has capitalization on (**CAPS**), is in **INSERT** or **REPLACE** mode, or has formatting codes or not (**FORMATTED** or **ASCII**). It also shows the line and column position of the cursor.

- Press **ESC** **V** **S** (View Status). This toggles the status bar on and off.

To display or hide control characters:

When turned on, this displays carriage-return and tab characters.

- Press **ESC** **V** **C** (View Ctrl-Characters). This is a toggle setting.

Using Outline-Style Numbering

Outline numbering creates text entries set off by indentation and hierarchical numbering. This can include indented text that is *not* numbered.

When outlining is active, it does this:

- Each time you press (ENTER), another number or letter automatically appears in the proper sequence at the left margin or after an indentation.
- You can change the level of numbering using Promote (F7) and Demote (F8). Demoting makes an item subordinate and promoting makes an item superior to the one above it.

Up to seven levels of hierarchy.

```
Memo: ANIMAL.DOC                                01/17/94 11:27 AM
I. The Animal Kingdom
  A. Vertebrates
    1. Reptiles
    2. Mammals
      a. Primates
        i) Lemuroidea
          ii) Anthropeidea
            a) Platyrrhini
            b) Catarrhini
              1) Cercopithecidae
              2) Pongidae
        b. Carnivores
          i) Creodonta
          ii) Fissipodia
            a) Aelluroidea
            b) Arctoidea
```

Outlined Text with Roman Numerals

Numbered heading.

Unnumbered text.

```
Memo: BASIC.DOC                                01/17/94 11:23 AM
1. Basic Operation
  The basic operations are described below.
  1.1. Register Transfer
    The most basic of all operations is the transfer of
    information from one register to another.
  1.2. Memory Read/Write
    This operation initiates a transfer between the memory
    and the memory buffer.
  1.3. Bit Testing
    There must be a way to test one bit in a register and
    alter the sequence of control.
2. Target Level
```

Outlined Text with Decimal Numeration

Starting Outline (Hierarchical) Numbering

First choose the numbering type:

This affects the current memo only. It affects the entire memo, including existing text that is above the cursor's position.

1. Press **MEMO** **T** **O** (Format Outline).
2. Arrow to highlight Decimal or Roman numeral.
3. If you want to adjust the indentation, press **TAB** and enter a number of character spaces (1-5).
4. Press **F10**.

Then use Promote or Demote to start numbering:

Promote and Demote affect the numbering of the current line, whether the line has text already or not.

1. Press **F7** to start numbering on the current unnumbered line.
2. If the line has no text yet, enter your text.
3. Press **ENTER** at the end of the entry. Another number (the next one in sequence) appears. To remove a final number without text, press **▲** or **▼**.

To create a sub-topic (subordinate entry) and increase indentation:

- Press **F8** (Demote). This “demotes” the numbering level of the current line, such as from I. to A. or 1.1 to 1.1.1.

To create a super-topic (superior entry) and decrease indentation:

- Press **F7** (Promote). This “promotes” the numbering level of the current line, such as from I.B. to II. or from 1.1.2 to 1.2.

To enter text without numbering:

- Press **F8** until there is no beginning number.

Pressing **F8** again moves the unnumbered text back out to the margin. Once you have entered unnumbered, unindented text like this, the next promotion or demotion *starts a new outline* (level I. or 1.).

To stop outline numbering and indentation:

- Simply press **F8** (or **F7**) until numbering and indentation are gone, leaving the line flush against the left margin.

This affects the current line and future text, but not previous text.

Editing Existing Outlined Text

To remove numbering from a subtopic:

1. Place the cursor on the line in question, and press **F8** until the numbering disappears.
2. If you want the text flush left, press **F8** again.

To promote or demote existing text:

Promoting raises the outline level of the current line, while demoting lowers it.

1. Place the cursor on the line to change.
2. Press **F7** (Promote) or **F8** (Demote).

Printing a Memo

There are three paths to take for printing memos:

- **Print to Printer:** You can print a memo using a printer connected to the palmtop.
- **Print to Printer with Connectivity Pack:** You can print a memo from a PC that has the Connectivity Pack installed. (Copy the memo file from the palmtop to the PC, then print the file to the PC's printer using the Connectivity Pack Memo Editor.)
- **Print to File:** You can print a memo from another computer that does *not* have the Connectivity Pack by printing to a file and transferring it with Datacomm.

About Printing to a Printer. Printing to a printer requires that a serial printer is properly connected to the palmtop, and that both the printer and the palmtop are properly configured. You configure the

printer settings for the palmtop via the Setup utility (**&...** **S** **MEMO** **O** **P**). Chapter 28 should help you set up most printers.

About Printing to a File. Printing to a file creates a print file that contains control codes that the printer (the one specified in the Setup utility) can interpret. To copy this file to another computer, use one of the file-transfer protocols given in the Datacomm application (**&...** **C**). You can then print out this memo file by copying the binary file to a printer.

To print a memo from the palmtop:

1. Press **MEMO** to start the Memo Editor.
2. Open the file you want to print (**F9**).
3. Press **MEMO** **F** **P** (File Print).
4. Highlight either the Printer or the File option button in the Print-to box.
5. Press **F10** to print.

Setting Up Printing Information

Press **MEMO** **F** **P** **S** (File Print Setup) to specify:

- How much printing should appear on a page.
- Starting and/or ending the print-out with special information (initialization and termination strings).

Maximum number of printed lines per page.
You can change this for shorter or longer sheets.

The screenshot shows a dialog box titled "Print Setup". It has the following fields and controls:

- Page Length (in lines):** A numeric input field containing the value "60".
- Top Margin (in lines):** A numeric input field containing the value "0".
- Bottom Margin (in lines):** A numeric input field containing the value "0".
- Initialization String:** A text input field that is currently empty.
- Termination String:** A text input field that is currently empty.
- Buttons:** "OK" and "Cancel" buttons are located on the right side of the dialog.

Printer-control sequences to set up or end the printing job.

Field	Meaning
Page Length	Specifies the lines of printable area on the paper. For paper $8\frac{1}{2} \times 11$ inches: The default page length (60) is appropriate for sheet-fed printers (such as HP Laserjet and HP Deskjet types), as well as for fanfold-paper printers set to skip the paper's perforations. Other fanfold-paper printers require a page-length setting of 66 lines. (See the printer's manual for more information.)
Top Margin	Specifies the number of blank lines to leave above the printed text. Default is zero lines for sheet-fed printers (like HP Laserjet and HP Deskjet) because the page length setting already takes top and bottom margins into account. Many fanfold-paper printers need a top margin setting of three.
Bottom Margin	Specifies the number of blank lines to leave below the printed text. Default is zero lines for sheet-fed printers (like HP Laserjet and HP Deskjet) because the page length setting already takes top and bottom margins into account. Many fanfold-paper printers need a bottom margin setting of three.
Initialization String	Specifies optional printer-control sequences (up to 128 characters) before the print-out begins. An initialization code might set landscape mode or select a certain font set. The exact codes and meanings depend on the printer.
Termination String	Specifies optional printer-control sequences (up to 128 characters) after the print-out ends. A termination code might set a form-feed to occur at the end of the print-out or reset portrait mode (for the next print-out). The exact codes and meanings depend on the printer.

To enter a control code on the palmtop:

- Type `\nnn`, where *nnn* is a three-digit control code. For example, the control code for ESC is typed as `\027`.

Refer to your printer's owner's manual for information on which control codes are available and what they do.

Memo Editor Function Keys

Key Label	Description
Bold	Starts/stops boldface; makes selected text bold.
UnderIn	Starts/stops underlining; makes selected text underlined.
Find	Searches for the specified text.
Fnd&Rep	Searches for the specified text and replaces it as specified.
PrntFld	To mark the spot where a page break, page number, current time, or current date should be inserted during printing.
Promote	Raises the hierarchical numbering one level for the current line.
Demote	Lowers the hierarchical numbering one level for the current line. (Use also to eliminate numbering.)
Open	Asks for the name of a memo file to open.
Save	Saves the current memo file.

The Note Taker

The Note Taker lets you create, save in a list, search, and edit short notes. Use the Memo Editor to create or edit larger memos, but use the Note Taker when you want to jot down brief notes and keep them in a list for quick and easy access. Since the notes are organized as items in a list rather than as separate files, they are easy to scan, sort, search, and organize.

Press **(F2)** **(N)** to start the Note Taker.

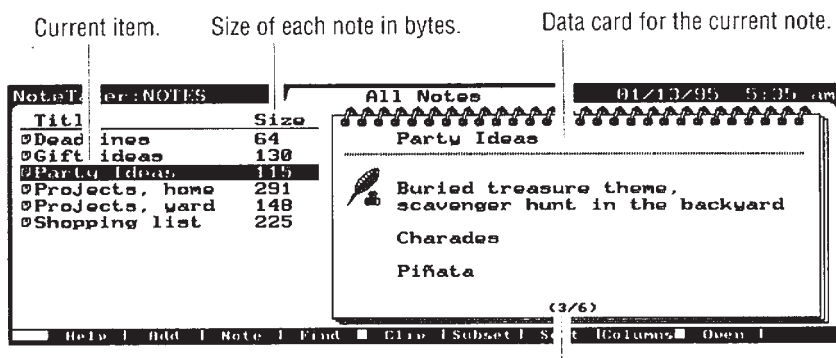

The third of six total entries.

The Note List

To open a note record:

- In the note list, highlight an item and press **(ENTER)** or **(F3)** (Note). (Note displays the Full Screen Note.)
- Press **(F6)** (Prev) or **(F7)** (Next) to see other notes.

The text of the note can fill more than one screen. To see more text in the Note field or Full Screen Note, press **(Fn)** PG DN or **(Fn)** PG UP.

Creating a Note

Each note can be up to 32 KB long (about 30 screens).

To add a new note:

1. In the Note Taker, press **F2** (Add).
2. Fill in the fields. (Use **TAB** to move among fields.)
 - a. **Title**. Identifies the note in the note list.
 - b. The main, unlabeled field is for your text.
 - c. **Category**. Includes a list of any categories used for notes. You can enter a new category or press **▼** to see the list and select an existing category. This field can have up to 32 category choices or 255 characters (no more than 128 characters per choice). You can categorize the records to view subsets of notes just like you would view subsets of phone records or cities from the World Time city list.
3. Press **F10** when done, or press **F2** to add another note. This saves the note automatically. (Or press **ESC** to *not* save the note.)

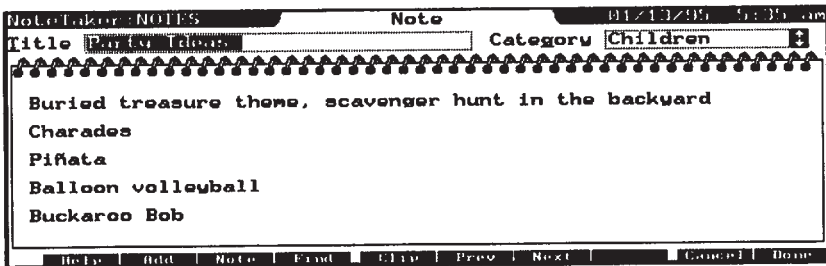

Full screen note (more text space).

Adding a Note Record

To “stamp” the current time or date in a note:

- Press **F11** DATE or **F11** TIME. This inserts the current date or current time at the position of the cursor.

To save a note as an ASCII (unformatted text) file:

1. Highlight the note in the note list, or open the note record.
2. Press **F3** **F2** (Note Save-As).
3. Enter the file name. (There is no default file extension.)

4. Press **F10** to save the file. (Or press **ESC** to cancel.)

Editing or Deleting Notes

To edit (change) a note:

1. Display the note list.
2. Highlight the item you want to edit.
3. Press **ENTER** or **F3** (Note) to open the note's record.
4. Edit the Title, Category, or Note.
 - To clear the Title or Category, highlight it and press **DEL**.
 - To restore the previous Title or Category, press **ESC**.
5. Press **F10** to save your changes. (Or press **ESC** to cancel them.)

To copy or move note information:

- You can use the Clipboard functions to copy and move information within the Note Taker, as well as to and from other applications.
- You can use Smart Clip to copy formatted information quickly from *predefined fields* in one application to another location. For example, you might want to copy a name and phone number from the Phone Book into a note. `Clip` provides predefined choices of fields to copy, and lets you define others yourself. The predefined Smart Clip from the Note Taker is "All Fields".

The Clipboard and Smart Clip are covered in chapter 1.

To copy a complete note record:

1. Display the note list and highlight the note you want to copy.
2. Press **Fn COPY**.
3. Press **Fn PASTE**. The new note is sorted with the other notes.

To insert an ASCII text file into a note:

1. In the Note Taker, open the note you want to add to.
2. Press **F3** (Note) to display the Full Screen Note.
3. Position the cursor where you want to insert the text.
4. Press **F3** (Insert).
5. Specify the file name. It must be an ASCII text file.
6. Press **F10**.

To clear (erase) the text of a note:

1. Highlight the note in the list or open its record.
2. Press **F3** (Note) to display the Full Screen Note.
3. Press **F4** (Clear) to erase the Note field.

To delete a note:

1. Display the note list.
2. Highlight the note to delete.
 - If you want to delete several notes, select each note by highlighting it and then pressing **spacebar**.
3. Press **DEL**.

To restore the last deleted or edited note:

- Press **END** **E** **U** (Edit Undo) before doing another operation.

To erase all notes:

1. Display the note list.
2. Press **END** **E** **A** (Edit Select-All).
3. Press **DEL** **F10**.

This deletes all the records from the current Note Taker file.

Changing the Data Card

The data card that shows up in your list of notes screen contains information from the record of the highlighted note. You can turn on (the default) or off the data card so that it is or is not displayed from the list screen. You can also redefine what the data card contains.

To remove the data card from the notes list:

1. Display the notes list. (Press **ESC** or **F10**, if necessary.)
2. Press **END** **V** (View) to see the View commands.
3. The default state of the Show-DataCard option is on (checked). Press **D** to uncheck the box and remove the card from the list.

To restore the data card to the notes list, press **END** **V** **D** (View Show-DataCard) to recheck the option.

To customize the data card definition:

The data card is simply a Smart Clip of the information on a note record. You can edit the definition of the data card Smart Clip using **F5** (Clip) from the notes list. (Note in the data card definition that - and = are formatting commands that render thin and thick lines.) For more information on editing Smart Clips, see page 1-28.

Searching the Note Taker

To look up a note (speed-locate):

1. Display the note list.
2. Start typing the title of the note.
3. Press **ENTER** when done, or arrow to the title you want.

The speed-locate operates as it does in the Database and the Phone Book.

To find any piece of text in the notes:

1. From the note list or record, press **F4** (Find).
2. Fill in the box with the characters or text to search for. Optional: Select the check boxes (press **spacebar** to change) for the options you want.
3. Press **F10** to search forward from the beginning of the list.
 - Or press **F4** (Next) to search forward from the current (highlighted) position.
 - Or press **F3** (Previous) to search *backward* from the current position

To repeat the search, press **↑ F4**.

If you want to search through only the titles or categories of the notes (and not the bodies of the notes), you can speed up a search by *not* checking Include Notes for the search.

Using Multiple Note Taker Files

You can create more than one Note Taker file, thereby creating more than one notes list in this application. Use **[F5]** File New or **[C]** File Copy to create a new Note Taker file. Use **[M]** File Merge to merge another Note Taker file into the current one.

8

Using Subsets of the Note Taker

The **Subset** function displays a specified subset of your note list. You determine the subset by filling out the Title, Category, and/or Note fields according to the contents you want to select for. For example, you could display the titles of just those notes in the Category "Children", or just those notes that mention "computer." To define and view subsets of the note list, follow the instructions under "Defining Subsets of a Database," page 4-18.

Limits While Using the Note Taker

- Maximum number of notes (items) in Note Taker (one file): limited by available RAM disk space. Theoretical maximum: about 5,000.
- All the notes are part of one file. However, you can create more than one Note Taker file if you wish.
- Maximum length of a note: 32 KB characters (about 30 screens).

Note Taker Function Keys

Function Keys for the Note List

Key Label	Description
Add	Opens a template to write a new note.
Note	Displays Full Screen Note for highlighted item.
Find	Searches for the specified character string (letters or other characters).
Clip	To copy predefined fields (a Smart Clip) from the Note Taker to the Clipboard. Also to define new Smart Clips and to edit the data card. See page 1-28. Smart Clip definitions are also used in Custom Style printing.
Subset	To display and/or define a specified subset of the note list.
Sort	Specifies how to sort the notes for the list.
Columns	Specifies how many columns appear in a list, how wide they are, and which fields they display.
Open	To open a different Note Taker file.

Function Keys for a Note Record (an Item)

Key Label	Description
Add	Opens a template to write a new note.
Note	Displays the Full Screen Note.
Find	Searches for the specified character string (letters or other characters).
Clip	To copy predefined fields (a Smart Clip) from the Note Taker to the Clipboard. Also to define new Smart Clips.
Prev	Displays the previous note.
Next	Displays the next note.

Function Keys for the Full Screen Note

Key Label	Description
Save As	Saves the current note in the specified ASCII text file.
Insert	Copies the specified ASCII text file into the current note at the position of the cursor.
Clear	Erases the Note field.

Part 3

Pocket Quicken



Pocket Quicken Basics

If you haven't started Pocket Quicken yet, turn to chapter 4 in the *Quick Start Guide* and follow the instructions there. Then read the material here as necessary.

This chapter covers the concepts fundamental to Pocket Quicken: files, accounts, categories, groups, transactions, and the register. If these Quicken terms aren't familiar, you should read the next few pages to gain an understanding of how Pocket Quicken data is organized. Also, at the end of this chapter is a section about sharing Pocket Quicken data with a desktop version of Quicken.

About Files and Accounts

Quicken data is kept in files. Within a file, you create one or more **accounts** to store different types of transactions. Accounts can be cash, credit card, or bank/check (savings or checking).

The initial file created when you start Pocket Quicken is called QDATA.PDT. (All Pocket Quicken files have a .PDT extension.)

Most users need only one file for their data, but may use several accounts within that file. For example, within one file you might have separate accounts for your checks, your cash, a company credit card, and a personal credit card.

You can **password protect** a Pocket Quicken file by following the instructions on page 1-25.

To set up an additional account:

If you followed the instructions in chapter 4 of the *Quick Start Guide*, you should have set up a Pocket Quicken account.

1. In Pocket Quicken press **(F7.00)** **(L)** **(A)** (Lists Account) to see the list of accounts.
2. Press **(F2)** (Add) to see the Add Account screen.
3. Fill in the Add Account screen, pressing **(TAB)** after each entry. Press **(F1)** (Help) if you need a description of the fields—**(ESC)** then returns you to where you were.
4. When you're finished, press **(F10)** (Save).

Adding an Account

To display the list of accounts:

There are two lists of accounts that you can display:

- Press **(ESC)** until you reach the main list of accounts, which is your Pocket Quicken Home Base screen. You can do most tasks starting from here.
- Press **(CTRL)+ (A)** to display a list of accounts in the current Pocket Quicken data file.

To select another account to use:

The account selected becomes the current account for transactions.

1. Press **(CTRL)+ (A)**.
2. Use **(▲)** and **(▼)** to highlight the account you want to use and press **(ENTER)**.

To edit information about an account:

You can change the name of a Pocket Quicken account and its description.

1. Press **(CTRL)+ (A)**.
2. Highlight the account you want to edit and press **(F4)** (Edit).
3. Change the information as desired, pressing **(TAB)** after each entry.

4. When you're finished, press **F10** (Save).

To delete an account:

Deleting an account permanently removes all of that account's records from your file. *Once you delete an account there is no way to recover it.* When you delete an account, Pocket Quicken also deletes the account name from the category field of any transfer transactions.

1. Press **ESC** until you reach the Pocket Quicken Home Base screen (the list of accounts).
2. Highlight the account you want to delete.
3. Press **DEL**.
4. Respond to the warning by selecting whether you want other accounts' transfer references to this account to be removed from the other accounts or not.
5. Press **F10** (Delete) to complete the deletion or **F9** (Cancel).

To trim your data file:

You can "trim" the current Quicken data file to remove old transactions. This doesn't reduce the file size, but it does make room for new transactions to be added without increasing the file size. Before you trim a file, you might want to use the Filer to make a backup copy of the file.

1. Press **ESC** until you reach the Pocket Quicken Home Base screen (the list of accounts).
2. Press **CTRL** **F** **T** (File Trim).
3. Enter a date before which transactions will be removed.
4. Uncheck the relevant check box if you do not want to keep uncleared transactions before the set date.
5. When you're finished filling in the screen, press **F10** (OK).

To set up additional files:

Most people need only one Pocket Quicken file. However, you may want to set up additional files to keep, for example, your personal finances separate from your business finances; or, you may want to keep a separate file for each year's accounts.

1. Press **ESC** until your reach the Pocket Quicken Home Base screen (the list of accounts).
2. Press **CTRL** **F** **N** (File New).

3. Fill in the Create New File screen, pressing **[TAB]** after each entry.
 - Don't give the file name an extension; Pocket Quicken automatically gives the file a .PDT extension.
 - Press **[F1]** if you need Help.
4. When you're finished, press **[F10]** to create the file.

A newly created Pocket Quicken file becomes the current file. You will need to set up accounts in it before you can add transactions.

To choose another file:

When you start Pocket Quicken, it opens the last file you used.

1. Press **[ESC]** until you reach the Pocket Quicken Home Base screen (the list of accounts).
2. Press **[MENU] [F] [O]** (File Open) to open another Pocket Quicken file. For more information on file commands, see Using file commands in chapter 1.

About categories and groups

Pocket Quicken offers you two independent ways to organize your transactions: using categories and using groups.

The screenshot shows the 'Add Transaction Screen' in Pocket Quicken. The window title is 'Pocket Quicken - 000110.PDT' and the menu bar includes 'File', 'Edit', 'Utilities', 'Transfer', 'Tools', 'Report', 'Window', 'Control', and 'Screen'. The main area contains the following fields:

- Date: 3/11/1994
- Amount: 6.00
- Category: (empty)
- Trip: (empty)
- Memo: (empty)
- Account: Checking
- Transaction Type: Check
- Cleared Status: Not cleared

At the bottom right, it displays 'Ending Balance: 6.00'. The status bar at the bottom shows '000110.PDT' and '000110.PDT'.

Add Transaction Screen

What's a Category?

A category tells you how you got your income (salary, dividends, bonus, etc.) or where you spent your money (auto, food, charity, etc.). Categories enable you to combine similar transactions in reports. For example, you could get a report of all your charitable gifts for last year.

- Pocket Quicken provides you with predefined categories when you create your data file.
- All accounts in a file share the same set of categories.
- Categories can have subcategories, such as Fuel, Loan, and Service under the Auto expense category (Auto:Fuel, Auto:Loan, Auto:Service).
- You can add and delete categories from the list, and you can demote categories to subcategories and promote subcategories to categories.

You assign categories to transactions as you fill in the Add Transaction screen. That process is covered in detail later in this chapter in the section “Entering Transactions.”

To display the category list:

- Press **FN** **L** **C** (Lists Category); or, as a shortcut, press **CTRL**+**C**.

To add a new category or subcategory to the list:

1. Press **FN** **L** **C** (Lists Category) to display the category list.
2. Press **F2** (Add) and fill in the fields. (Press **F1** if you need Help.)
3. When you're finished, press **F10** (Save).

You can also add a category or subcategory on the fly when you're entering a transaction. Simply type a new category name in the category field, press **ENTER**, and respond to the prompt. (For a subcategory, type the category name, a colon, and then the new subcategory name.) The new category is added to the list.

To change a category or subcategory:

When you edit a category or subcategory, you can change its name, description, or type. Change the Category Type field to promote a

subcategory to a category (income or expense), demote a category to a subcategory of another category, or move a subcategory to be under another category.

1. Press **[MENU]** **[L]** **[C]** (Lists Category) to display the category list.
2. Highlight the category you want to change.
3. Press **[F4]** (Edit) and make your changes.
4. When you're finished, press **[F10]** (Save).

To delete a category or subcategory from the list:

When you delete a category, it is erased from the category field of any transactions to which it was assigned. When you delete a subcategory, its name is erased from the category list, but any transactions to which it was assigned are reassigned to its parent category.

Before a category with subcategories can be deleted, you must promote the subcategories or move them to another category.

1. Press **[MENU]** **[L]** **[C]** (Lists Category) to display the category list.
2. Highlight the category you want to delete.
3. Press **[F8]** (Delete).

To merge two categories:

Merge two categories by making the category you don't want into a subcategory of the other category. Then, delete the subcategory. That way all its transactions are automatically reassigned to the parent category. (See the previous procedures for changing categories and deleting categories.)

What's a Group?

Groups are independent of categories; you use groups to separate transactions by trip, client, project, or class. For example, you could assign all transactions on a business trip to a trip named Phoenix, and then generate an expense report for that trip. Or, you might assign transactions for food, auto, hotel, etc. to a particular client so that you could later get a report of all you spent on that client.

If you're familiar with a desktop version of Quicken, you'll notice that group is analogous to class. In fact, if you exchange data between

Pocket Quicken and a desktop version of Quicken, the group and class lists are merged.

In Pocket Quicken you can change the group field title among **Trip** (the default), **Project**, **Client**, or **Class** (a general group). Also, the groups you set up can have subgroups for further refining reports.

To change the group field title:

1. Press **CTRL** **O** **G** (Options Group) to see the Group Preferences screen.
2. Select a title for the field from the Group Name list.
3. Optional: Check the Auto Fill box if you want Pocket Quicken to enter a group name automatically in each transaction. If you check this box, press **TAB** and type the group name you want to use.
4. When you're finished, press **F10** (Save).

Now, whenever you enter a transaction, the group field will have the title you specified, and, optionally, the group you specified will be entered as the default group automatically.

To display the group list:

- Press **CTRL** **L** **G** (Lists Group), or, as a shortcut, press **CTRL** + **L**.

To add groups and subgroups to the list:

1. Press **CTRL** **L** **G** (Lists Group) to display the group list.
2. Press **F2** (Add) and fill in the fields. (Press **F1** if you need Help.)
3. When you're finished, press **F10** (Save).

You can also add a group or subgroup when you're entering a transaction. Simply type a new group name in the group field, press **ENTER**, and respond to the prompt. (For a subgroup, type the group name, a colon, and the new subgroup name.) The new group is added to the list.

Use the Group Field for Expense Reporting

One of the most useful features of Pocket Quicken is the ability to track travel and entertainment expenses and then print them in a report. The group field enables you to make this happen. Here are some hints for effectively using the group field to track travel and entertainment expenses:

- Set the group field title to best match your needs. If you track mostly trip expenses, use Trip; if you track mostly client-associated expenses, use Client; if you track mostly project-related expenses, use Project. However, if you track a mixture of expenses associated with various clients, trips, and projects, use the more general title of Class.
- Add groups to the group list that reflect the character of the group of expenses. For example, you might create a group named Boston for tracking expenses on a business trip to Boston.
- Use subgroups if you need to further refine your reports. For example, say you have a group named ClientA to track all your expenses associated with a particular client. If you make regular trips to that client's city, you might want to track the expenses for each trip by using the subgroups Trip1, Trip2, Trip3, etc. That way, you can get information about the total money spent on ClientA as well as the money spent on each trip you took to visit him.
- Use categories as you normally would to track the type of expenses: food, lodging, auto, etc. That way you can get information on how much you spent on food, etc. for a specified group.
- Whenever you want a printed report for a certain trip, client, etc., create your report using Pocket Quicken and then print it using the Memo Editor. See chapter 11 for more details.

Using the Register

The account register is much the same as a paper check register for a checking account. It shows date, check number, payee, and payment or deposit amount for all transactions in the current account.

Account name.

A plus (+) sign indicates a deposit;
no sign indicates a payment.

1994		Check#	Payee	Category/Trip	C	Pmt/Dep+
3/8			Balance Forward	[Checking]	X	1,043.00+
3/8			Mycompany	Bonus		1,500.00+
3/10	563		Al's Auto Repair	Auto:Service	*	100.00
3/10	564		NW Electric			58.26
3/11	565		Tubby's Ice Cream			12.95
						2,371.79

Ending Balance: 2,371.79

A Register for a Checking Account

A quick way to search the register is to type the first letter of a payee's name and watch the highlight move. Keep typing the first letter of the payee's name until that payee is highlighted.

You use the register not only to view collective transactions in an account, but as a convenient starting point to accomplish many common Pocket Quicken tasks.

Tasks That Start from the Register

Task	Commands or Keys
Entering a new transaction.	Add (F2)
Zooming in to see more entries on the screen.	Zoom (F5)
Displaying the current account balance at the highlighted entry.	Balance (F6)
Voiding the highlighted transaction.	Void (F8)
Leaving the register to display the Home Base (the list of accounts).	Accts (F9)
Editing the highlighted transaction.	Edit (F10)
Deleting the highlighted transaction.	DEL

9

Entering Transactions

The transaction is the heart of Pocket Quicken. Enter a transaction whenever you move money into or out of an account.

The Add Transaction Screen

Press (F2) (Add) from an account register to see the Add Transaction screen.

Pocket Quicken: QDDFB.PBT Add Transaction 03/11/94 3:36 pm

Date: 3/11/1994

Payee: _____

Amount: 0.00 ChkNum: _____

Category: _____

Trip: _____

Memo: _____

Account: Checking

Transaction Type: Check

Cleared Status: Not cleared

Ending Balance: 0.00

Help | Add | Splits | Reset | Prev | Next | Void | Cancel | Save

Add Transaction Screen

To enter a transaction, fill in the Add Transaction screen and then press (F10) (Save). The palmtop beeps and returns to the register.

Here's a description of the fields in the Add Transaction screen:

Field	Description
Date	Enter the date of the transaction; the default is the current date. You can use QuickKeys (shortcut keys) to fill in certain dates—for example, <input type="button" value="+"/> and <input type="button" value="-"/> increment the date by one day. To see a complete list of these keys from the Add Transaction screen, press <input type="button" value="F1"/> (Help), tab to Date, and press <input type="button" value="ENTER"/> ; press <input type="button" value="ESC"/> to return where you were.
Payee	Enter the name of the party to whom you paid money or from whom you received money.
Amount	Enter the amount of the transaction. Don't worry about the sign of the amount; Pocket Quicken automatically adds or subtracts the amount from the account based on the type of transaction—for example, a deposit is added to the account.
ChkNum	Enter the transaction number (optional). For a check, enter the check number; for a payment or invoice, enter the invoice number. When the cursor is in this field, you can use <input type="button" value="+"/> or <input type="button" value="-"/> to change the current transaction number by one.
Category	Enter the category to use for reports (optional). If you enter a new category, you'll be prompted to add it to the category list. To see the category list, press <input type="button" value="▼"/> . You can use this list to select a category for the transaction by highlighting the category you want and pressing <input type="button" value="ENTER"/> .
Trip	To enter a subcategory, separate it from the category with a colon—for example, Auto:Fuel. This is the group field, and Trip is the default title. (See "What's a Group?" earlier in this chapter if you want to change the group field title.) Enter the name of the group to use for reports (optional). If

you enter a new group, you'll be prompted to add it to the group list.

To see the group list, press . You can use this list to select a group for the transaction by highlighting the group you want and pressing .

To enter a subgroup, separate it from the group with a colon—for example, Portland:Visit1.

- | | |
|------------------|--|
| Memo | Enter a one-line description of the transaction (optional). |
| 9 Account | Enter the account for the transaction. The current account is the default. If you enter a new account name, you'll be prompted to create the new account, which, once created, becomes the current account for your transactions.

To see the list of accounts, press <input type="button" value="▼"/> . You can use this list to select an account for the transaction by highlighting the one you want and pressing <input type="button" value="ENTER"/> . The account you select becomes the current account. |
| Transaction Type | Enter the transaction type, such as check or deposit. Use <input type="button" value="▲"/> and <input type="button" value="▼"/> to cycle through the acceptable types. |
| Cleared Status | Leave the status as Not Cleared for normal transactions. This field is used by Pocket Quicken during the reconciliation process. The only time you should select Cleared or Reconciled is when you're entering historical transactions that have already cleared your bank. |

To add a transaction to a Pocket Quicken account:

1. From an account register press (Add) and fill in the Add Transaction screen, pressing after each entry. For information on a field, see the above descriptions or use for Help.
2. When you're finished, press (Save).

To edit a transaction:

1. In an account register, highlight the entry you want to edit.
2. Press **ENTER**.
3. Move to and edit the fields you want to change. (Use **TAB** to move from field to field.)
4. When you're finished, press **F10** (Save), or press **ESC** to cancel.

Note

If you change the check number or date, the location of the transaction in the register may also change—Pocket Quicken sorts transactions in the register by date and then by check number.

9

If you want to edit only the group or category field for an existing transaction, there is a shortcut:

1. In an account register, highlight the entry you want to edit.
2. Press **CTRL+C** to display the category list, or press **CTRL+L** to display the group list.
3. Highlight the category or group you want to use and press **F10** (Use).

This shortcut enables you to easily add a category or group to a transaction at a later, more convenient time.

To delete a transaction:

Deleting a transaction permanently removes it from the register and file. (Instead of deleting a numbered check, consider voiding it.)

1. In an account register, highlight the entry you want to delete.
2. Press **DEL**.

To void a transaction:

By voiding a check in the register rather than deleting it, you maintain consecutively numbered check records. The word VOID is inserted before the payee name on the transaction and the check is marked as cleared. A voided check remains in the register; a deleted check does not.

1. In an account register, highlight the entry you want to void.
2. Press **F8** (Void).

Using QuickFill and QuickKeys

When entering transactions, you can use **QuickFill** and **QuickKeys** to save you time and keystrokes.

QuickFill When you start typing in the Payee, Category, Account, or Transaction-type field, Pocket Quicken automatically fills in the field with potential matches to what you're typing. Keep typing until QuickFill matches the entry you want, then press **TAB** to move to the next field.

For a subcategory, type a colon and then start typing the subcategory name.

You can turn QuickFill on or off (the default is on) by pressing **Ctrl** **O** **Q** (Options Quickfill). If you want more information on the QuickFill preferences, look up QuickFill in the online Help index.

QuickKeys In some cases you can press a single key to complete an entire field. An example is pressing **T** in the date field to insert today's date. Once you're familiar with Pocket Quicken, look up QuickKeys in the Help index to get more information and see a list of available QuickKeys.

Splitting Transactions

Sometimes you need to divide a transaction between multiple categories or groups. For example, one check to a computer store might cover a piece of hardware, some software, and some office supplies. You can split a transaction like that to assign portions of the total amount to different categories or groups. You can enter up to 30 splits for a single transaction.

To split a transaction:

1. Fill in the Add Transaction screen for the total amount of the transaction and then press **F3** (Splits) to see the Transaction Splits screen.

2. Fill in the Category, Group, Memo, and Amount for each portion of the transaction. Use **F6** (Prev) and **F7** (Next) to move between splits.
3. When you're finished entering splits, press **F10** (Done) to save the splits and return to the Add Transaction screen.
4. Press **F10** (Save) to save the transaction.

To edit a split transaction:

1. In an account register, highlight the entry with the splits you want to edit and press **ENTER**.
2. Press **F3** (Splits).
3. Move to and edit the fields you want to change. Use **F6** (Prev) and **F7** (Next) to move between splits, and use **TAB** to move from field to field.
4. When you're finished, press **F10** (Done).

Look up Transactions, Splitting in the online Help index for more details about splitting transactions.

Transferring Money between Accounts

You can use account transfers to record many types of transactions:

- Movement of funds from a checking account to a savings account.
- Cash advances from your credit card to your checking account.
- Payments from your checking account to your credit card account.

Note

Accounts appear at the bottom of the category list in brackets ([] or { }). Accounts in square brackets ([]) represent accounts from the current Pocket Quicken file, and accounts in curly brackets ({ }) represent accounts from another version of Quicken that are not present in your file. Account names are added to the category list automatically whenever you create a new account and whenever you import data that has transfers to accounts that don't exist in Pocket Quicken (those transfers are preserved within Pocket Quicken).

When you complete the transaction, Pocket Quicken automatically creates a parallel transaction in the receiving account. If the source

transaction is a payment or decrease, the destination transaction is a deposit or increase.

To record a transfer transaction:

1. Fill in the Add Transaction screen for the full amount of the transfer.
2. In the Category field, select the receiving account as the category:
 - a. Press **▼** to display the category list.
 - b. Press **F10** END to move to the end of the list.
 - c. Highlight the account in brackets that you want to be the receiving account and press **ENTER**.
3. When you're finished, press **F10** (Save) to save the transaction.

You can also split a transfer transaction between accounts. If you assign more than one portion of the split to a single destination account, Pocket Quicken sums those portions and enters one transfer transaction for that destination account.

Changing Your Entry Preferences

You can change the way a few things work during transaction entry. See the illustration in the following procedure to see what you can change.

To change entry preferences:

1. Press **ESC** **O** **E** (Options Entry).

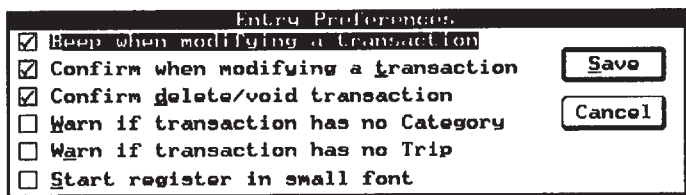

Entry Preferences

2. Use **TAB** to move to the preference you want to change. (If you need a description of a preference, press **F1** for Help.)
3. Press **spacebar** to check or uncheck it (turn it on or off).
4. When you're finished making changes, press **F10** (Save).

Sharing Data with Desktop Quicken

If you have a desktop version of Quicken, you can merge or synchronize a Pocket Quicken file with a desktop Quicken file. This capability enables you to keep the same accounts on both your palmtop and desktop computers accurate and up-to-date. Take the palmtop on the road; and when you return, merge or synchronize your Pocket Quicken file with your desktop Quicken file.

The best way to combine data from Pocket Quicken files and desktop Quicken files involves using the palmtop Connectivity Pack.

Using the Connectivity Pack to Merge Or Synchronize Quicken Files

The Connectivity Pack Xlate/Merge utility enables you to synchronize, merge, or copy Quicken files between your palmtop and desktop PCs. See the Connectivity Pack user's guide for instructions.

Importing and Exporting Pocket Quicken Files

If you don't have the Connectivity Pack, you can exchange data with desktop Quicken by using the Import and Export commands. However, you still need a way to transfer a file from one system to another. For instance, if you have a memory-card drive on your PC, you can use a memory card as the medium; or, you can connect the computers with the HP 1015A serial cable and then use Kermit or XMODEM protocol to transfer the file.

Export Exports transactions from the current Pocket Quicken account and saves them to a Quicken Interchange Format (.QIF) file. A .QIF file, when imported by another Quicken version, is converted into the appropriate format and merged with a data file on that other version. Use this command on a Pocket Quicken account when you want to merge some or all of the data with a file on a desktop version of Quicken. If you want to export transactions from more than one Pocket Quicken account, you must use the Export command separately for each account.

Note

Exported data must conform with the requirements of the receiving version of Quicken. The requirements for different versions of desktop Quicken are in the online Help index under the topic Exporting.

Import

Takes a file in the Quicken Interchange Format (.QIF) and merges the data with a Pocket Quicken (.PDT) file. Use this command when you've exported data from another system and want to merge it with your Pocket Quicken file.

9**To export Pocket Quicken data from the current account:**

1. Press **(ESC)** until you reach the Pocket Quicken list of accounts.
2. Press **(F10)** **(F)** **(E)** (File Export).
3. Answer the displayed questions for what transactions and lists to export. (Press **(F1)** for Help.)
4. Press **(F10)** (File) and name the export file. (Press **(F1)** for Help.)
5. When finished, press **(F10)** (OK) to complete the export.

The result of this procedure is that you've created a .QIF file in the current directory that is ready to be transferred and imported to another version of Quicken.

To import a .QIF file into Pocket Quicken:

When you export a desktop Quicken file for importing into Pocket Quicken, you need to create several QIF files on the desktop version—one with only accounts and category information, and one for each account containing only the transactions for that account. Import the account and category information first, then the account transactions.



1. Press **(ESC)** until you reach the Pocket Quicken list of accounts.
2. If you're importing a set of transactions, highlight the account you want it to go into.
3. Press **(F10)** **(F)** **(I)** (File Import).
4. Select the file to import and then press **(F10)** (OK).
5. Answer the displayed questions for what data to import. (Press **(F1)** for Help.)
6. When finished, press **(F10)** (Import) to merge the data in the .QIF file with the data in the current file.

Disk Space

Pocket Quicken requires disk space to store transactions. If insufficient disk space is available to store a new transaction, the following message is displayed:

Quicken needs more disk space to complete this operation. Please go into FILER and erase files to make space. Select Retry once space is available.

When this message appears.

1. Select **F8** (Abort). (Do not select Retry or your Quicken file will be damaged.)
2. Press  and delete unneeded files to free a minimum of 5000 bytes of disk space.
3. Press  and reenter your transaction.

Balancing your Pocket Quicken checkbook

Pocket Quicken enables you to balance or “reconcile” your bank statement with your Pocket Quicken account. You can balance to the degree of accuracy that works for you. You can track down every cent if you prefer, but Pocket Quicken doesn’t require you to balance to the penny.

The General Reconciling Procedure

When your bank statement arrives, follow these basic steps to reconcile your account. If you have two or more statements that need reconciling, start with the earliest statement and reconcile each one individually.

1. If this is the first time you’ve reconciled the bank account, check to see if you need to enter more transactions or update your opening balance. See the following section, “Balancing Your Account for the First Time”.
2. Start reconciling by entering information from your current bank statement. See the section entitled “Reconciling the Account”.
3. Mark the transactions that have cleared your bank account in the Reconcile window. See the section entitled “Reconciling the Account” Step 4.
4. Compare the totals of cleared items in the Reconcile window with those on your bank statement. See the section entitled “Reconciling the Account” Step 5.

Balancing Your Account for the First Time

Before you can reconcile your account for the first time, you need to do two things:

1. Enter *all* transactions into your account that have not been previously marked as cleared. These are all transactions that have not shown up on previous bank statements. In most cases you'll be reminded to enter all uncleared transactions because the transactions appear on your bank statement when you're trying to reconcile. (You can enter these transactions in the register as you find them during reconciliation.)
- 10 2. Update your Pocket Quicken opening balance to reflect the amount actually in your account when you began using Pocket Quicken. (This amount should match the opening balance on your bank statement.) You can edit the opening balance entry in your register, or you can create an adjustment at the end of your first reconciliation.

Example. Suppose the ending balance on the bank statement for your checking account was \$200.52 on December 31, 1994. You started using Pocket Quicken on January 12, 1995. You used the ending balance from your December bank statement as the balance for your Pocket Quicken checking account. Then you entered transactions from your paper check register from January 1 to 12 into Pocket Quicken. From January 12 on, you entered all transactions into Pocket Quicken every few days as they occurred.

In February you receive your January 31 bank statement. You see two checks (totaling \$80) that you wrote in December had not cleared the bank by your December statement. Now they have cleared the bank, so they appear on the January bank statement. You didn't enter those checks in Pocket Quicken because they occurred before January 1. Even though those two checks were written before the date of your first Pocket Quicken transaction, you need to enter them into the register. If you don't enter these uncleared transactions, Pocket Quicken will create an adjustment entry at the end of the reconciliation to reflect the \$80 difference.

Reconciling the Account

To reconcile the current account with the bank statement:

1. Press **ENTER** **A** **E** (Activities Reconcile).

Taken automatically from your account.

You enter the ending balance from your bank statement.

Starting Balances	
Statement Opening Balance	1,043.00
Statement Ending Balance	0.00
Srvc Chrg	Date: 3/11/1994
Category	
Interest	Date: 3/11/1994
Category	

If you enter service charge or interest amounts here, those transactions will be added to the register.

The Reconcile Register Screen

2. Enter the ending balance from your bank statement, any service charge information, and any interest information. Press **TAB** after each entry.
3. When you're finished with this screen, press **F10** (Next) to see a list of all uncleared transactions.
4. Compare your bank statement list to this list—verify that the amounts are the same and that there are no missing entries in Pocket Quicken that have cleared the bank.
 - For an uncleared transaction that matches the bank statement transaction, highlight it and press **F3** (Clear).
 - For a bank statement transaction that is not in the uncleared list, use **F2** (Add) to enter it. Be sure to select Cleared in the Cleared Status field.
 - For a transaction that has an incorrect amount or other error, use **F4** (Edit) to correct it. Be sure to mark the transaction as cleared, also.
5. When you've finished clearing transactions, press **F10** (Done). If you get the Congratulations! message, press **ENTER** to complete

the reconciliation. If, however, you see a warning message, the account doesn't balance. See the next section for what to do.

Solving Problems

If your account doesn't balance, you'll see the reconcile Warning screen when you press **Done** to complete reconciliation.

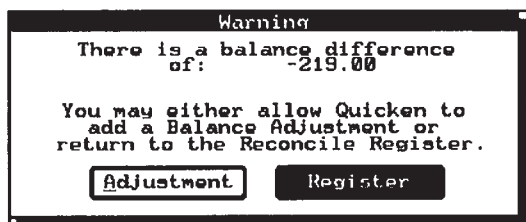

Reconcile Warning Screen

If the difference is small, you may want to have Pocket Quicken adjust for it—see the later section “Having Pocket Quicken Adjust for Differences.” Otherwise, you'll need to track down the cause of the difference to make your account balance.

Correcting Differences

If your account doesn't balance, the difference is usually due to one or more of the following reasons:

- Incorrect number of payments or deposits checked off as cleared.
- Incorrect dollar amounts on some items.
- Incorrect opening or ending account balances.

Check the Number of Payments and Deposits. Check the register for missing or mislabeled payments or deposits that are on your bank statement but not on your check register. Systematically check to see if

- You missed recording an item in the check register.
- You missed marking an item as cleared.
- You mistakenly marked an item as cleared.

- You entered any transactions twice.
- You entered a payment as a deposit or a deposit as a payment.

Check the Dollar Amounts of Items. If there's no problem with the number of items marked as cleared, compare the dollar amounts of the checks and deposits on your register to the bank statement. Keep in mind that you may have recorded all items, but typed an amount incorrectly, or that the bank may have made a mistake by processing a transaction for a different amount than you wrote it for.

Check the Opening and Ending Balances. Incorrect opening or closing balances are particularly likely sources of problems for your first reconciliation.

Having Pocket Quicken Adjust for Differences

You might decide to ignore the difference between your check register and the bank statement. Ignoring the difference is appropriate if the amount is small and you feel it is not worth your time to track it down. Even though you decide to ignore the difference, you'll want to have Pocket Quicken enter an adjustment for the amount of the difference. That way you'll be starting with accurate totals the next time you reconcile your account.

To have Pocket Quicken add a balance adjustment:

1. Press **A** (Adjustment) from the reconcile Problem screen to have Pocket Quicken create an adjusting entry to your register.

Balance Adjustment

Quicken is about to add this balancing entry to your register. Please edit the optional category and the date.

Add

Cancel

Payee: Balance Adjustment

Amount: -219.00

Category: [dropdown]

TranType: Deposit

Date: 3/11/1994 [dropdown]

2. You have the option of editing the Date and Category fields. When you're finished editing, press **F10** (AddAdj) to add the adjustment transaction to the register.

Updating Your Previously Reconciled Balance

If the opening balance from your bank statement was different from the amount Pocket Quicken expected as your previously reconciled balance, you need to account for the difference. The balance might differ for one of these reasons:

- **You are balancing your Pocket Quicken account for the first time.**
Pocket Quicken uses the amount of the opening balance in your register as the opening balance amount for your bank statement when you reconcile. When you set up the Pocket Quicken account, you may have entered a balance that was different from the actual amount in your bank account. Also, there are probably transactions missing from your Pocket Quicken account that affect the balance. See “Balancing Your Account for the First Time” earlier in this chapter.
- **You were using Pocket Quicken and reconciling your bank account, then you started recording earlier transactions in Pocket Quicken.**
For example, say it’s July. You started recording transactions in May and subsequently reconciled your account for May and June. Then you went back and recorded transactions starting in January so you could generate more comprehensive reports. After entering these earlier items, you noticed that the ending balance in the check register was incorrect. So, you updated the date and amount of the opening balance for the account. In this case see “Adding Earlier Transactions to Pocket Quicken” later in this chapter.
- **You have started reconciling with the current bank statement, but you have not reconciled each of the previous month’s statements.**
You should reconcile one month at a time, starting with the earliest month.
- **You have changed or deleted a previously reconciled transaction.**
Pocket Quicken always asks you to confirm a change to a previously reconciled transaction. You may need to continue reconciling and have Pocket Quicken record an adjustment transaction when the reconciliation is complete.

Adding Earlier Transactions to Pocket Quicken

If you've used Pocket Quicken to record and reconcile transactions, you may want to add earlier transactions to your account so you can create more comprehensive reports. To keep information in your account accurate, you need to follow the steps in the example below.

Example: Adding Earlier Transactions to Your Account. In this example we assume that you started entering transactions in June. When you set up the Pocket Quicken bank account, you used the ending balance from your May statement as the opening balance for the account. You've already reconciled your June bank statement. Now you want to go back and add earlier transactions starting on January 1.

1. Make note of the ending balance in your Pocket Quicken register before you begin to enter earlier transactions.
2. Change the date and amount of the Opening Balance transaction in the Pocket Quicken register to reflect the opening balance on January 1.
3. Enter all the earlier transactions starting January 1 into your account, just as you would enter any current transaction.
4. When you have finished entering transactions, the ending balance in the register should be the same as it was when you started.
5. Reconcile all the transactions that you entered for previous months (January to May).
6. Now you can reconcile for the current month (June).

Creating and Printing Pocket Quicken Reports

Using Pocket Quicken you can create three types of reports:

- Your transaction register for an account.
- The balances of all accounts in your Quicken data file.
- An “expense report”—the transactions (income and expense) for a selected group, date range, and/or account, sorted by categories.



You use Pocket Quicken to create a report file, and then you use the Memo Editor to view or print the file. When the report is created, connect a printer and print the report file like you would any other memo. (When you open the report file in the Memo Editor, remember the file will reside in the directory in which you created it. The path to your report file could be, for example, C:\QUICKEN\.)

Note

When you print a Pocket Quicken report using the Memo Editor, you should change the margins to 1 (left) and 81 (right) to get the best looking reports. (In the Memo Editor menu, select Format Margins to set the margins.)

To create a report file for the current register:

This creates a printable file containing transactions from the current account. Use the Memo Editor to print or view the file. (Remember to change the margins in the Memo Editor to 1 (left) and 81 (right) before you print.)

1. Press    (Reports Transaction) to see the Create Transaction Report screen.

Create Transaction Report

Account register: Checking Create
Title TRANSACTION REPORT
Report dates 1/1/1994 through 3/11/1994 Cancel
 Include splits?

11

2. Fill in the screen, pressing **(TAB)** to move between fields.
 - Title. Optional: Enter a title for the report. If you don't change it, Pocket Quicken uses the title "TRANSACTION REPORT".
 - Report dates. Enter the beginning and ending dates for the range you want to print.
 - Include Splits. Use the spacebar to check this box if you want to include split information in the report. (For information on splitting transactions, see page 9-14.)
3. When you're finished filling in the screen, press **(F10)** (Create) to see the list of print files.

Note

If you choose an existing file to print to, it will be overwritten.

Also, don't give a new file name an extension. Pocket Quicken automatically gives report files a .DOC extension.

4. Type or highlight a file name and press **(F10)** (OK).

To create a report file for all current balances:

This creates a printable file containing all account balances in your Pocket Quicken data file. Use the Memo Editor to print or view the file. (Remember to change the margins in the Memo Editor to 1 (left) and 81 (right) before you print.)

1. Press **(MEMO)** **(R)** **(B)** (Reports Balances) to see the Create Account Balances Report screen.

Create Account Balances Report

Title: ACCOUNT BALANCES REPORT

Include balances as of: 3/11/1994

2. Fill in the screen, pressing **(TAB)** to move between fields.
 - **Title.** Optional: Enter a title for the report. If you don't change it, Pocket Quicken uses the title "ACCOUNT BALANCES REPORT".
 - **Include Balances as of.** Enter the date for which you want the balances.
3. When you're finished filling in the screen, press **(F10)** (Create) to see the list of print files.

Note

If you choose an existing file to print to, it will be overwritten.

Also, don't give a new file name an extension. Pocket Quicken automatically gives report files a .DOC extension.

4. Type or highlight a file name and press **(F10)** (OK).

To create a report file for categories:

This creates a printable file that lists all transactions by category. The list can be restricted by dates, by account, and/or by group, creating a specific expense report. Use the Memo Editor to print or view the file. (Remember to change the margins in the Memo Editor to 1 (left) and 81 (right) before you print.)

Use this procedure to create a business expense report.

1. Press **(R)** **(C)** (Reports Category) to see the Create Category Report screen.

Create Category Report

Title

Account:

Current Account

All Accounts

Report dates through

Trip (optional)

2. Fill in the screen, pressing **(TAB)** to move between fields.
 - **Title.** Optional: Enter a title for the report. If you don't change it, Pocket Quicken uses the title "ITEMIZED CATEGORY REPORT".
 - **Account.** Select Current Account to constrain the report to the current account only; or select All Accounts (the default) if you want the report to cover all accounts in the current file.
 - **Report dates.** Enter the beginning and ending dates for the range you want to print.
 - **TRIP.** Optional: Enter a group for the report. If you enter a name here, you will create an expense report by category for just the trip (or client, project, or class) you specify.
3. When you're finished filling in the screen, press **(F10)** (Create) to see the list of print files.

Note

If you choose an existing file to print to, it will be overwritten.

Also, don't give a new file name an extension. Pocket Quicken automatically gives report files a .DOC extension.

4. Type or highlight a file name and press **(F10)** (OK).

Part 4

The HP Financial Calculator

Calculator Basics and Math Functions

The palmtop Financial Calculator has its own set of applications for problems of

- General arithmetic (chapter 12).
- Business percentages, including markup and margin (chapter 13).
- Time value of money and amortization (chapter 14).
- Interest rate conversions (chapter 14).
- Uneven cash flows (chapter 15).
- Currency and other unit conversions (chapter 16).
- One- and two-variable statistics (chapter 17).
- Date calculations (chapter 18).
- Solver equations that you enter (chapter 19).
- Function graphing (chapter 19).
- Customizing the Calculator (chapter 20).

Press **[F2]** to start the Calculator, and press **[MENU]** **[A]** to see the list of applications to choose from:

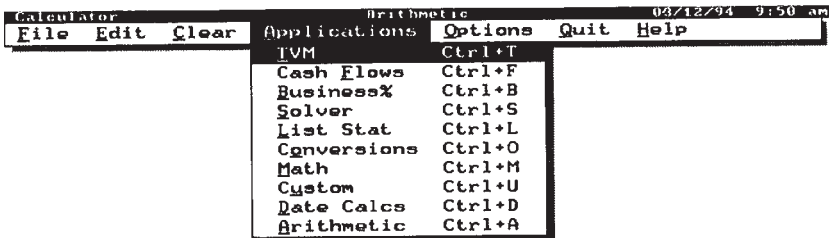

The rest of this chapter describes many of the basic features of the Calculator as well as the technical math functions available in the Math application.

Simple Arithmetic

Here is an example of simple arithmetic in the Calculator using algebraic syntax. Notice how [=] completes the calculation.

Keys:



54.69 [+] 28.33



[*] 6 [-] 200 [=]

Description:

Starts the Calculator.

Adds 54.69 to 28.33 and displays 83.02 in the calc line.

Multiplies the previous result by 6, subtracts 200 from that result, and displays 298.12 in the calc line.

12

About the Calc Line

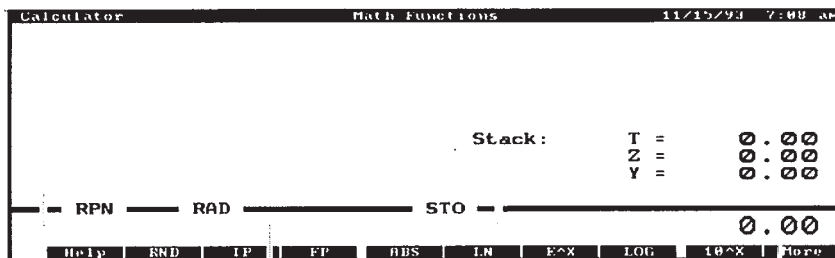

Annunciators display above the calc line.

Calc line.

The calc line. This is where you enter numbers and see results. You can do arithmetic whenever the calc line is present in any of the Calculator applications.

The annunciator area. The top part of the box surrounding the calc line is the area the Calculator uses to display **annunciators**—symbols that tell you when the Calculator is in a special state or mode.

- The **ALG/RPN annunciator** describes how the palmtop expects you to enter calculations—either in algebraic syntax (the default) or in Reverse Polish Notation.
- The **RAD/GRAD annunciator** tells you how angles are interpreted: radians (RAD), grads (GRAD), or degrees (no annunciator). This annunciator displays only in the math screen and the Solver.
- The **STO/RCL annunciator** turns on when you're storing or recalling the contents of registers.
- The **Popul/Sample annunciator** tells you which model is used to calculate the statistics in the List Stat application.
- The **1-Var/2-Var annunciator** indicates the number of columns for statistics data entry in the List Stat application.

Chapter 20 tells you how to set or change modes of operation.

To clear the calc line:

- Press **DEL**. (Use **←** to delete only the rightmost number, character, or operator.)

To enter a negative number:

- Type the number and press **+/-** (the **L** key).

To view displayed numbers to their full precision:

1. Press **Fn** ZOOM.
2. Press **ESC** to continue.

The Calculator Keyboard

The Calculator uses primarily three areas of the keyboard:

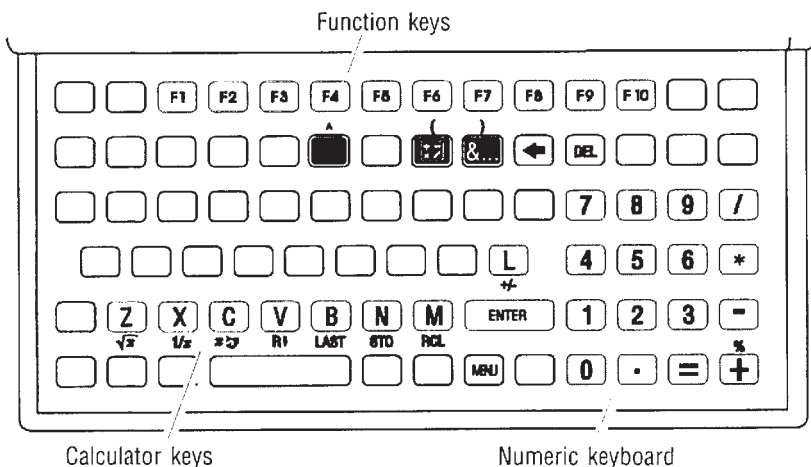

12

About the Special Calculator Keys. Most of the time the alpha keys are not active within the Calculator. The Calculator takes advantage of this by redefining the bottom row of alpha keys (**Z**, **X**, **C**, etc.) along with the **L** key to give you a set of special Calculator keys. The Calculator definitions are printed just below the corresponding keys—**Z** becomes \sqrt{x} , **X** becomes $1/x$, etc.

Key	Description
\sqrt{x}	Calculates the square root of the number in the calc line.
$1/x$	Calculates the reciprocal of the number in the calc line.
$x \leftrightarrow y$	If the calc line contains a number, exchanges that number with the result of the previous calculation. If the calc line contains two numbers separated by an operator, swaps the order of the numbers (for example, 3/4 changes to 4/3).
R↓	Rolls down the history stack.
LAST	Copies the result of the previous calculation into the current calculation.
STO	Copies a number from the calc line into the designated register or variable.
RCL	Recalls the number from the designated register or variable.
+/-	Makes a positive number negative or a negative number positive. For example, pressing +/- with the number 118 in the calc line changes it to -118. Pressing it a second time makes the number positive again.

Operator Priority

When you string calculations together, the palmtop uses a system of operator priority to evaluate expressions:

Operator	Priority
\wedge	First
$*$ and $/$	Second
$+$ and $-$	Third

The Calculator calculates an intermediate result when the next operator you enter has a lower or equal priority. When the next operator has higher priority, the Calculator retains the previous numbers. For example, in the calculation $9 + 12 / 3 =$, division has a higher priority than addition. Thus, the 9 and $+$ are retained as a pending operation until the division is completed.

Example. Calculate 4×7^3 plus 5×7^2 plus 6.

Keys:

[C]

4 [*] 7 [\wedge]

3 [+]

5 [*]

7 [\wedge]

2 [+]

6 [=]

Description:

Starts the Calculator.

\wedge has a higher priority than $*$. (\wedge is the shifted [5] key.)

Calculates 4×7^3 , and the calc line shows 1,372.00+.

$*$ has a higher priority than $+$.

\wedge has a higher priority than $*$.

Adds 5×7^2 to 1,372.

Completes the calculation and displays 1,623.00.

If a calculation requires that operations be done in an order inconsistent with operator priority (for example, addition *before* multiplication), use parentheses. You can have a maximum of eight pending operations.

Percent

In most cases, $\boxed{\%}$ (the shifted $\boxed{+}$ key) divides the number furthest to the right in the calc line by 100. The exception is when a plus or minus sign precedes the number. Then, the $\boxed{\%}$ key uses the rightmost number as a percent, and calculates that percent of the number preceding the plus or minus sign.

Example: Percentages. Find 27% of 85.3.

Keys:	Description:
$\boxed{C/A}$	Starts the Calculator.
85.3 $\boxed{*}$ 27 $\boxed{\%}$	Divides 27 by 100.
$\boxed{=}$	Calculates 27% of 85.3 and displays 23.03.

12

Example: Calculating Simple Interest. You borrow \$1,250 from a relative, and agree to repay the loan in a year with 7% simple interest. How much money will you owe?

Keys:	Description:
1250 $\boxed{+}$ 7 $\boxed{\%}$	Interest on the loan (7% of \$1250) is \$87.50.
$\boxed{=}$	Displays 1,337.50, the total amount you must repay at the end of 1 year.

Other Keyboard Arithmetic

Examples. The other keyboard arithmetic keys are $\boxed{\sqrt{x}}$ (the \boxed{Z} key), $\boxed{1/x}$ (the \boxed{X} key), and $\boxed{\wedge}$ (the shifted $\boxed{5}$ key). They act on the number furthest to the right in the calc line.

Keys:

4

20

1.1 2

The function is useful for calculating the root of a number.

125 3

Description:

Starts the Calculator.

Calculates the reciprocal of 4 to be 0.25.

Calculates the square root of 20 to be 4.47.

Calculates 1.1^2 to be 1.21.Calculates $1/3$ and displays 125.00^0.33.

Calculates the cube root of 125 to be 5.00.

Using the Automatic Constant in Calculations

An **automatic constant** is an operator (+, −, *, /, or ^) and a number or percentage that can be used for repetitive calculations. To initiate an automatic constant, press an operator twice followed by a number or percentage. Once initiated, the constant is displayed to the right of the calc line in brackets, for example [+5%].

Example. Calculate 128×3.2 , 219×3.2 , and 316×3.2 .

Keys:

128 3.2

219

316

Description:

Starts the Calculator.

Stores *3.2 as a constant and multiplies 128 by 3.2. The result and constant are displayed: 409.60 [*3.20].

Multiplies 219 by 3.2 and displays 700.80 [*3.20].

Multiplies 316 by 3.2 and displays 1,011.20 [*3.20].

Example. Calculate $10 + 10\%$, $11 + 10\%$, and $25 + 10\%$.

Keys:

10 10

25

Description:

Stores $+10\%$ as a constant and adds 10% to 10. The result and constant are displayed:
11.00 [+10.00%].

Adds 10% to 11 and displays
12.10 [+10.00%].

Adds 10% to 25 and displays
27.50 [+10.00%].

The K Abbreviation. If the constant causes the contents of the calc line to become too long, the constant is abbreviated as K, as in [+K%].

Clearing the Constant. Pressing clears the constant and the result from the calc line. Pressing another operator key or clears just the constant and leaves the result.

12

Storing and Recalling Numbers

You can store and recall numbers using the history stack and using registers.

Using the History Stack

The **history stack** is a four-level record of activities within the Calculator. It includes the calc line and three levels “above” the calc line. When you start a new operation on the calc line, the previous contents move up to level 1, bumping level 1 contents to level 2, level 2 to level 3, and level 3 off the stack. Numbers are lost when bumped off the stack.

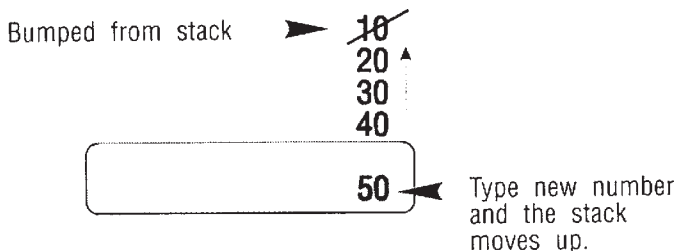

The history stack is shared by all Calculator applications, and if you clear the stack (by pressing **2ND** **C** **S**), the numbers change to 0's. The current state of the stack is always displayed in the Calculator Math application. (You can also set it to be viewed in Arithmetic and Custom—press **2ND** **O** **M** and select Show Stack.)

- The **R↓** key (**V** when the Calculator is active) “rolls” the history stack down one line. For example, pressing **R↓** once with the above stack moves 50.00 to the top of the stack (level 3) and rolls the other numbers down one level, putting 40.00 in the calc line. Pressing **R↓** four times cycles through the entire stack.
- The **x↔y** key (**C** when the calculator is active) normally swaps a number in the calc line with the number in stack level 1. For example, if your stack looks like the one in the previous illustration, pressing **x↔y** puts 40.00 in the calc line and moves 50.00 to level 1. The exception to this rule is when you have an incomplete calculation in the calc line. Then, **x↔y** swaps the two operands. For example, pressing **x↔y** changes 2.00/3.00 in the calc line to 3.00/2.00.
- The **LAST** key (**B** when the Calculator is active) copies the number in level 1 of the history stack into a calculation you are in the process of doing.

Using Registers

The Calculator has 10 **registers** (storage locations), numbered 0 through 9, that can be used to store and recall numbers.

Viewing Registers

The current values in the registers can be viewed in the Arithmetic and Custom applications: Press **MEM** **O** **M** and select Show Registers.

Using **STO** and **RCL**

To store or recall a number, press **STO** (**N** when the Calculator is active) or **RCL** (**M** when the Calculator is active), followed by a number in the range 0 through 9.

STO copies the number from the calc line to a designated register. If there is more than one number in the calc line, **STO** copies *only the rightmost number*. **RCL** recalls the stored number back to the calc line.

To cancel the store or recall after you've pressed **STO** or **RCL**, press **ESC** or **←**.

STO and **RCL** can also be used with variables. For example, pressing **STO** **PMT** (the payment function-key in TVM) stores the rightmost number in the calc line into the variable *PMT*. Pressing **RCL** **PMT** copies the contents of *PMT* into the calc line.

Doing Arithmetic inside Registers

The Calculator lets you do arithmetic on numbers that are stored *inside* registers regardless of which Calculator application you are in.

Example: Register Arithmetic. Store 45.7 in register 3, multiply that number by 2.5, and store the result back in register 3.

Keys:	Description:
45.7 STO 3	Stores 45.7 into register 3.
2.5 STO * 3	Stores 114.25 (45.7×2.5) into register 3.
RCL 3	Displays the contents of register 3.

The following table shows the options for arithmetic inside registers:

Keys	New Number in Register
(STO) (+)	old number in register + number in calc line
(STO) (-)	old number in register - number in calc line
(STO) (*)	old number in register × number in calc line
(STO) (/)	old number in register ÷ number in calc line

You can also do arithmetic on numbers stored in variables. For example, 2 (STO) (*) PMT multiplies the current contents of *PMT* by 2 and stores the product in *PMT*.

Using the M Register

Register 0 (the M register) is a special register that has its own set of “shortcut” memory keys. You can use the (STO) key-combinations and (RCL) with register 0 just like you would with the rest of the registers, or you can use the four function keys ((F7) through (F10)) that are present whenever you’re in the Arithmetic application. These keys do storage operations on register 0 with a minimum of keystrokes.

M Register Keys in the Arithmetic Application

Keys	Description
⇨M ((F7))	Stores the value in the calc line into register 0. (Same as (STO) 0.)
R⇨M ((F8))	Recalls the contents of register 0 to the calc line. (Same as (RCL) 0.)
M+ ((F9))	Adds the value in the calc line to the old value in register 0 and stores the sum in register 0. (Same as (STO) (+) 0.)
M- ((F10))	Subtracts the value in the calc line from the old value in register 0 and stores the difference in register 0. (Same as (STO) (-) 0.)

Moving Values between the Calc Line and 1-2-3

If you're using the Calculator while you have an open 1-2-3 worksheet, you have the ability to copy values from the calc line to a 1-2-3 cell and from a 1-2-3 cell to the calc line. Any numbers copied into 1-2-3 this way are treated as values by 1-2-3. (If you use the Clipboard to move a number to 1-2-3, it is interpreted by 1-2-3 as a label.)

To copy the rightmost number in the calc line to a 1-2-3 cell:

1. Press **STO** **spacebar** from the Calculator. The open 1-2-3 worksheet is displayed.
2. Move the cell pointer to the cell you want to receive the number.
3. Press **ENTER**. The number from the calc line is copied to the highlighted cell, and you're returned to the Calculator.

12 To copy a number in a 1-2-3 cell to the calc line:

1. Press **RCL** **spacebar** from the Calculator. The open 1-2-3 worksheet is displayed.
2. Move the cell pointer to the cell with the value you want to copy.
3. Press **ENTER**. The number in the highlighted cell is copied to the calc line.

If in step 2 you selected an empty cell or a cell with a label, 0.00 is returned to the calc line.

The Point-and-Shoot Method of Data Entry

Most of the examples in the Calculator part of this manual demonstrate entering data using the function keys that correspond to the variables on the screen. An alternate method for data entry involves highlighting a variable on the screen using the arrow keys, typing a number, and then pressing **▲**, **▼**, or **ENTER**. Then, once you've entered all the necessary data, you can highlight the variable to solve for and press the spacebar to return the answer.

This "point-and-shoot" method is available throughout the Calculator whenever a list of variables is displayed.



Example: Using Point-and-Shoot to Calculate a Mortgage Payment. The owner of Bunsen's Burner, a local Cajun food restaurant, has taken out a 30-year (360-month) mortgage on his eatery. The amount is \$200,000 at 10% annual interest. Calculate his monthly payment.

Keys:

Description:

Selects the TVM application.

Clears any prior TVM data.



Highlights the *N* variable.

360 

Enters the number of payments and highlights *I%YR*.

10 











Enters the interest rate.

200000 

Enters the amount of the mortgage.



Calculates the monthly payment.

Calculator		Time Value of Money - case 1		11/19/93 7:14 am	
Number of periods.....	N =		360.00		
Annual interest.....	I%YR =		10.00		
Present value.....	PV =		200,000.00		
Payment.....	PMT =		-1,755.14		
Future value.....	FV =		0.00		
Payments per year.....	P/YR =		12		
Begin/End mode.....	B/E =		END		
			PMT = -1,755.14		
         					

Clearing Information from Calculator Memory

- To clear the data associated with the current Calculator application, press **MEM** **C** **D**. For example, if you're in the TVM application, pressing **MEM** **C** **D** clears all your TVM data.
- To clear the calc line, press **MEM** **C** **C**.
- To clear the history stack, press **MEM** **C** **S**.
- To clear the storage registers, press **MEM** **C** **R**.

Pressing **DEL** is another way to clear just the calc line.

Using RPN with the Calculator

If you're an experienced RPN user, you may want to configure the Calculator to operate in RPN mode—press **MEM** **O** **M** and then select RPN in the Operation Mode box.

When the Calculator is in RPN mode, the **RPN** annunciator is displayed at the left side of the calc line.

Reverse Polish Notation (RPN) is based on an unambiguous, parentheses-free mathematical logic known as “Polish Notation,” developed by the Polish logician Jan Lukasiewicz (1878–1956). While conventional algebraic notation places the operators *between* the relevant numbers or variables, Lukasiewicz’s notation places them *before* the numbers or variables. For optimal efficiency of the stack, we modified that notation to specify the operators *after* the numbers. Hence the term *Reverse Polish Notation*, or *RPN*.

There are several easy-to-follow books designed to explain RPN to the beginner. One such book is *ENTER* by Jean-Daniel Dodin. It’s available at the time of this writing from:

EduCALC
27693 Cabot Road
Laguna Niguel, CA 92677 USA
Telephone: 800 677-7001 (Credit card orders only)

Technical Math Functions

Press **2nd** **MEM** **A** **M** to start the Calculator Math application, which gives you function key labels at the bottom of the display for the technical math functions. (As a shortcut from anywhere else in the Calculator, you can press **CTRL**+**M** to get to the Math application.)

There are four sets or **pages** of function keys—pressing **More** (**F10**) shows you the next page, and pressing **More** (**↑**) shows you the previous page. The Calculator remembers the current page when you leave the math functions screen so that it is displayed again when you return.

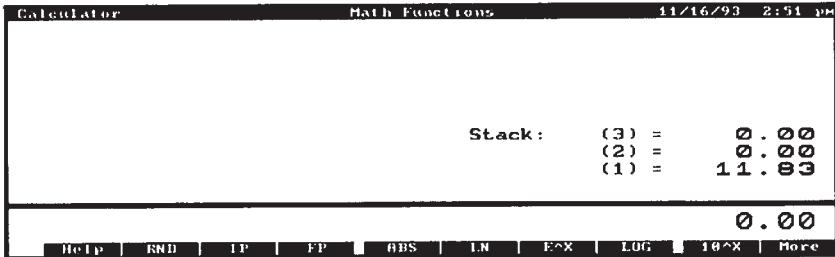

12

Pressing **More** (**F10**) brings up another "page" of math functions.

Unless noted otherwise in the following tables, the technical math functions operate on the rightmost real number in the calc line.

Page 1 Set of Math Functions

Key Label	Function
RND	Rounds number to number of displayed decimal places. (Before rounding, the stored version of the number may have additional non-zero digits that are not displayed.)
IP	Integer part of real number in calc line.
FP	Fractional part of real number in calc line.
ABS	Absolute value of real number in calc line.
LN	Natural (base e) logarithm of a positive number.
E ^X	Natural antilogarithm; e ^x .
LOG	Common (base 10) logarithm of a positive number.
10 ^X	Common (base 10) antilogarithm; 10 ^x .

12

Example: Rounding a Number. This example assumes numbers are displayed to two decimal places.

Keys:



Description:

Selects the Calculator Math application. (You may need to press **MORE** to see the function key used in this example.)



Calculates 7.2781. The result is displayed to two decimal places—7.28—but the entire number is in memory and is used in any further calculations.

RND

Rounds the number to 7.28. (7.2781 is no longer in Calculator memory.)

Example: Logarithmic Functions. Find the natural log of 47.5.

Keys:

Description:



Selects the Calculator Math application.
(You may need to press **More** to see the function keys used in this example.)

47.5 LH

Natural log of 47.5 is 3.86.

E[^]X

Natural antilogarithm of 3.86 is 47.50.

Page 2 Set of Math Functions

Key Label	Function	Key Label	Function
PI	π (3.14159265359)	ASIN	arc sine
SIN	sine	ACOS	arc cosine
COS	cosine	ATAN	arc tangent
TAN	tangent		

12





Changing the Angle Mode. The trigonometric functions in the previous table (except for π), and the polar/rectangular-coordinate conversion functions in the next table, interpret angles in degrees, radians, or grads, depending on the angle mode. The Annunciators at the top-left part of the calc line indicate the mode—the RAD annunciator indicates Radians mode, the GRAD annunciator indicates Grads mode, and no annunciator indicates Degrees mode.

To change the angle mode, press and then select the desired angle mode.

Example: Trigonometric Functions. This example assumes the angle mode is set to Degrees.

Keys:

Description:

    Selects the Calculator Math application. (You may need to press **MORE** to see the function keys used in this example.)

15 **SIN** Sine of 15° is 0.26.

2.73 **ATAN** Arc tangent of 2.73 is 69.88.

Page 3 Set of Math Functions

Key Label	Function
→DEG	To degrees; converts the number from a radian value to its decimal degree equivalent.
→RAD	To radians; converts the number from a decimal degree value to its radian equivalent.
→HR	To hours; converts the number from hours(degrees)-minutes-seconds-decimal seconds format (H.MMSSss or D.MMSSss) to decimal hours (or degrees) format.
→HMS	To hours-minutes-seconds; converts the number from decimal hours (or degrees) to hours(degrees)-minutes-seconds-decimal seconds format (H.MMSSss or D.MMSSss).
XCOORD	Stores the x -coordinate or calculates the x - and y -coordinates.
YCOORD	Stores the y -coordinate or calculates the x - and y -coordinates.
RADIUS	Stores the radius or calculates the radius and angle.
ANGLE	Stores the angle or calculates the radius and angle.

Example: Angle and Hour Conversions. In this example you may have to press `More` (`F10`) after you start the Math application to get to the `PI` function key.

Keys:

Description:

<code>2nd</code> <code>MEM</code> <code>A</code> <code>M</code>	Selects the Calculator Math application.
1.79 <code>*</code> <code>PI</code> <code>=</code>	Calculates 1.79π to be 5.62.
<code>More</code> <code>→DEG</code>	Converts 5.62 radians to 322.20 degrees.
90.2015 <code>→HR</code>	Converts 90 degrees, 20 minutes, 15 seconds to 90.34 decimal degrees.

Example: Coordinate Conversions. Convert the rectangular coordinates (10,−15) to polar coordinates. This example assumes the angle mode is set to Degrees.

Keys:

Description:

<code>2nd</code> <code>MEM</code> <code>A</code> <code>M</code>	Selects the Calculator Math application. (You may need to press <code>More</code> to see the function keys used in this example.)
10 <code>XCOORD</code>	Stores the x -coordinate.
15 <code>+/-</code> <code>YCOORD</code>	Stores the y -coordinate.
<code>RADIUS</code>	Calculates the radius and angle and displays <code>RADIUS = 18.03.</code>

Page 4 Set of Math Functions

Key Label	Function
X	Stores x for calculating combinations and permutations.
Y	Stores y for calculating combinations and permutations.
Cx, y	Combinations; calculates the number of different <i>sets</i> containing y items that can be taken from a larger group of x items. Different orders of the same y items are not counted separately.
Px, y	Permutations; calculates the number of different <i>arrangements</i> of y items that can be taken from a larger group of x items. Different orders of the same y items are counted separately.
$N!$	Calculates the factorial of the rightmost number in the calc line.
SEED	Stores a seed for the random number generator. A seed is a number that initiates the sequence of random numbers. Pressing 0 SEED uses a new seed from the system clock. To specify a particular seed, key in a non-zero number and press SEED . You can repeat a random number sequence by storing the same non-zero seed.
RAN#	Displays a random number between 0 and 1. All random numbers have 12 significant digits.

12

Example: Probability Functions. Calculate combinations and permutations.

Keys:



Description:

Selects the Calculator Math application. (You may need to press MORE to see the function keys used in this example.)

5 X Stores x .

3 Y Stores y .

Cx, y Calculates combinations: $Cx, y = 10.00$.

Px, y Calculates permutations: $Px, y = 60.00$.

Business Percentage Calculations

To start the Calculator Business% application press **F7** **ON** **A** **B**. (Or, as a shortcut from anywhere within the Calculator, press **CTRL**+**B**.) Business% has two screens: one for calculating percent change and percent of total, and one for calculating markup and margin. Press **More** (**F10**) to switch between the two screens:

Calculator		Business Percentages		11/15/93 7:22 AM	
Old value.....	OLD	=	110,000.00		
New value.....	NEW	=	115,000.00		
Percent change.....	%CHG	=	12.00		
Total amount.....	TOTAL	=	675,840.00		
Part of total.....	PART	=	234,576.00		
Percent of total.....	%TOTAL	=	34.71		
			%CHG = 12.00		
Help	OLD	NEW	%CHG	TOTAL	More

Percent Change and Percent of Total

Calculator		Business Percentages		11/15/93 7:23 AM	
Cost.....	COST	=	49.00		
Price.....	PRICE	=	78.40		
Mark up.....	MARKUP	=	60.00		
Margin.....	MARGIN	=	37.50		
			PRICE = 78.40		
Help	COST	PRICE	MARKUP	MARGIN	More

Markup and Margin

To calculate percent change:

The percent change function keys are OLD (F3), NEW (F4), and %CHG (F5). Percent change is expressed as a percentage of the *OLD* number.

1. Display the percent change screen.
2. Type the old number and press (F3), and type the new number and press (F4).
3. Press (F5) to return the percent change to the calc line.

To calculate percent of total:

The percent of total function keys are TOTAL (F7), PART (F8), and %TOTAL (F9).

1. Display the percent change screen.
2. Type the total and press (F7), and type the part and press (F8).
3. Press (F9) to return the percent of total to the calc line.

13

To calculate markup and margin:

Markup calculations are expressed as a percent of *cost*. **Margin** is markup expressed as a percent of *price*.

1. Display the markup and margin screen.
2. Type the cost and press (F6), and type the price and press (F7).
3. Press (F8) or (F9) to return the markup or margin to the calc line.

For the percent and markup/margin calculations you can actually calculate any unknown variable as long as the others are known. For example, you can calculate selling price by entering the known cost and desired markup or margin and then pressing PRICE (F7). Similarly, if you know the percent change and the new number, you can calculate the old number.

Time Value of Money and Interest Conversions

The time-value-of-money (TVM) application enables you to do compound-interest, amortization, and interest-rate-conversion calculations. You can use TVM to solve virtually any financial problem involving a series of cash flows (money received or money paid) that meets these criteria:



- The dollar amount is the same for each payment.
- The payments occur at regular intervals.
- Payment periods coincide with the compounding periods.

For uneven or irregular cash flow problems, see chapter 15, “Uneven Cash Flow Calculations.”

The TVM Screen

Press **2nd** **7** **2nd** **0** **A** **T** to start TVM.

Calculator		Time Value of Money - case 1		11/15/93 7:26 AM	
Number of periods.....	N	=		0.00	
Annual interest.....	I%YR	=		0.00	
Present value.....	PV	=		0.00	
Payment.....	PMT	=		0.00	
Future value.....	FV	=		0.00	
Payments per year.....	P/YR	=		12	
Begin/End mode.....	B/E	=		END	
					0.00
Help Insert Icons B/E P/YR N I/YR PV PMT FV					

Key Label	Description
Amort	Brings up the amortization screen and function keys (see "Calculating Amortization" later in this chapter).
Iconv	Brings up the interest conversion screen and function keys (see "Calculating Interest Rate Conversions" later in this chapter).
B/E	Switches the payment mode between BEGIN (for payments made at the beginning of periods) and END (for payments made at the end of periods).
P/YR	Stores the number of payments or compounding periods per year. The value must be an integer in the range 1 through 999.
N	Stores or calculates the total number of payments (or compounding periods). N can be expressed in any unit of time—for example, days, months, or years.  N multiplies the number in the calc line by P/YR and stores the result in N . For example, if P/YR is 12, pressing 30  N stores 360 in N .
I/YR	Stores or calculates the nominal <i>annual</i> interest rate as a percentage.
PV	Stores or calculates the present value of a series of future cash flows. To a lender or borrower, PV is the amount of the loan; to an investor, PV is the initial investment. PV always occurs at the beginning of the first period.
PMT	Stores or calculates the amount of each periodic payment. The payments are the same amount, and no payments are skipped. Payments can occur at the beginning or end of each period.
FV	Stores or calculates the future value—the amount of the final cash flow, or the compounded value of the series of previous cash flows. FV always occurs at the end of the last period.

The **Amort** (amortization) and **Iconv** (interest rate conversion) function keys bring up other screens with their own function keys. If the amortization or interest conversion screen is displayed when you start TVM, you can press **(ESC)** to get back to the main TVM screen.

Switching TVM Cases. The Calculator lets you keep two different sets of TVM variables in memory, cases 1 and 2. To switch cases, press **(▶)** or **(◀)**—the case number at the top of the screen and the values in the variables change.

Clearing TVM Variables. The Calculator retains the values stored in the TVM variables until they are changed or cleared. To clear the variables for the displayed TVM case—the other case is not affected—

press **END** **C** **D**. This clears N , $I\%YR$, PV , PMT , and FV to 0, sets P/YR to 12, and sets End mode.

Making TVM Calculations

To make TVM calculations, follow this general procedure:

1. Press **2nd** **FV** **A** **T** to start TVM.
2. If necessary, press **ESC** to display the main TVM screen.
3. Check and set these TVM conditions:
 - Number of payments per year (use P/YR).
 - Payments at beginning or end of periods (use B/E).
4. Enter values for the four known TVM variables.
5. Find the unknown value.

Conventions for Entering TVM Values. Cash flows are either positive or negative, depending on your perspective. A loan is a *positive* cash flow (money coming in) to the borrower and a *negative* cash flow (money going out) to the lender. Money deposited in a savings account is a negative cash flow for the investor and a positive cash flow for the bank. Keep in mind as you enter values and view results that money flowing to you is a positive number and money flowing from you is a negative number. Use **+/-** to change the sign.

Also, make sure the timing of payment—at the beginning of each period or at the end of each period—is set properly for your problem (**END** is the default). Use B/E to switch the payment mode.

The next few pages contain a series of TVM examples. Also, see “Additional TVM Examples” at the end of this chapter.

Example: A Car Loan. Otto Tailfin is financing the purchase of a car with a 3-year loan at 10.5% annual interest, compounded monthly. The purchase price of the car is \$11,250, and his down payment is \$2500. What are his monthly payments? (Assume that payments start at the end of the first period.)

Keys:

Description:

Starts the TVM application.

Clears any prior TVM data.

3  

Enters the total number of monthly payments.

10.5 

Enters the annual interest rate.

11250  2500 

Enters the amount of the loan as the present value.

0 

Enters 0 as the future value because the loan will be completely paid off at the end of 3 years. (This step is really not necessary because *FV* was set to 0 when the data was cleared above.)



Calculates a monthly payment of \$284.40.

14



Example: A Mortgage with a Balloon Payment. Russ T. Pipes has taken out a 25-year, \$75,250 house mortgage at 13.8% annual interest. He expects to sell the house in 4 years, repaying the loan in a balloon payment. Find the size of the balloon payment—the value of the mortgage after 4 years of payments.

Keys:

Description:

Starts the TVM application.

Clears any prior TVM data.

25  

Enters 300 as the total number of monthly payments.

13.8 

Enters the annual interest rate.

75250 

Enters the amount of the mortgage as the present value.

0 

Enters 0 as the future value.



Calculates the monthly payment of \$894.33.

894.33	+/-	F9	Stores the actual dollars-and-cents payment, which is the computed payment rounded to 2 decimal places. (Otherwise, <i>PMT</i> would have fractional cents as previously calculated.)
4	↑	F6	Enters the number of payments in 4 years.
	F10		Calculates the balloon to be \$73,408.81.

Example: A Savings Account. Penny Horder deposits \$2000 into a savings account that pays 7.2% annual interest, compounded annually. If she makes no other deposits into the account, how long does it take for the account to contain \$3000?

Keys:

Description:

2nd	MEMO	A	T	Starts the TVM application.
2nd	C	D		Clears any prior TVM data.
1	F5			Sets 1 compounding period per year.
7.2	F7			Enters the annual interest rate.
2000	+/-	F8		Enters the amount of the deposit.
3000	F10			Enters the future value.
	F6			Calculates 5.83 years.

Since the calculated value of N is between 5 and 6, it will take 6 years of annual compounding to achieve a balance of at least \$3,000. The actual balance at the end of 6 years can be calculated:

6	F6	Enters 6 as N .
	F10	Calculates the balance to be \$3,035.28 after 6 years.













Example: A Lease. Sandy Lome is leasing farm equipment for 4 years. The monthly payment of \$2400 is due today. An additional \$2400 payment at the beginning of the leasing period replaces the final payment. The leasing agreement includes an option to buy the equipment for \$15,000 at the end of the leasing period. Calculate the capitalized value of the lease, assuming that the interest rate Lome pays to borrow funds is 18%, compounded monthly.

Make the calculation in four steps:

1. Calculate the present value for the 47 monthly payments—the initial investment required to make the monthly payments.
2. Add the advance payment to the result of step 1.
3. Calculate the present value of the buy option—the initial investment required to generate the option price after 48 months.
4. Add the values calculated in steps 2 and 3.

Step 1. Calculate the present value of the monthly payments.

14

Keys:	Description:
   	Starts the TVM application.
  	Clears any prior TVM data.
	Set payments at the beginning of the periods.
47 	Enters the number of payments.
18 	Enters the annual interest rate.
2400  	Enters the monthly payment.
	Calculates the present (capitalized) value of the 47 monthly payments to be \$81,735.58.

Step 2. Add the additional advance payment to *PV* and store the answer.

$\boxed{+}$ 2400 $\boxed{=}$ Adds the advance payment to *PV*.
 $\boxed{\text{STO}}$ 1 Stores 84,135.58 in register 1.

Step 3. Find the present value of the buy option.

48 $\boxed{\text{F6}}$ Enters the number of periods.
15000 $\boxed{+/-}$ $\boxed{\text{F10}}$ Enters the amount of buy option.
0 $\boxed{\text{F9}}$ Clears *PMT*.
 $\boxed{\text{F8}}$ Calculates the present value of the buy option to be \$7,340.43.

Step 4. Add the results of steps 2 and 3.

$\boxed{+}$ $\boxed{\text{RCL}}$ 1 $\boxed{=}$ Calculates \$91,476.00 to be the present (capitalized) value of the lease.

14

Calculating Amortization

Amortization calculations determine the amounts applied toward principal and interest in a payment or series of payments. When you're in TVM and press **AMORT** ($\boxed{\text{F2}}$), you get the amortization function keys:

Key Label	Description
GO	Calculates the amortization for a group of payments. If you enter a number in the calc line and then press GO, that number is used as the number of payments in the group; if you press GO without entering a number, the current number of payments per year (<i>P/YR</i>) is used, which is 12 unless you change it.
 GO	Calculates the amortization for a number of groups, specified by the number you type in the calc line.
Adjust	Displays the amortization adjustment screen and function keys.
I%YR'	Stores or calculates a new interest rate or returns the current interest rate to the calc line.
PMT'	Stores or calculates a new payment amount or returns the current payment to the calc line.
BAL	Returns the amount of the remaining balance of the loan to the calc line. (Pressing STO BAL stores a new balance.)
INT	Returns the amount of the payments applied toward interest to the calc line.
ACCUM	Returns the amount of accumulated interest since the start of the amortization (period 0) to the calc line.
PRIN	Returns the amount of the payments applied toward principal to the calc line.
1-2-3	Specifies the current 1-2-3 worksheet as the destination for the amortization table. When an amortization table is generated, it is sent to the 1-2-3 worksheet starting at the current cell. This feature works only when a 1-2-3 worksheet is currently loaded.

To make amortization calculations:

1. Start TVM by pressing **2ND** **A** **T**.
2. Check that these TVM conditions are set:
 - Number of payments per year.
 - Payments at beginning or end of periods.
3. Store values for three TVM variables: $I\%YR$, PV , and PMT . These variables define the payment schedule. (For an adjustable rate mortgage, also store the total number of payments in N .)
4. Press **Amort** (**F2**) to select the amortization screen.
5. Do one of the following:
 - Simply press **GO** (**F2**) to calculate amortization for the number of periods stored in P/YR (default is 12).
 - Enter the number of payments to amortize, then press **GO** (**F2**).
6. For an Adjustable Rate Mortgage (ARM):
 - a. At the point in the schedule where the interest rate changes, adjust it by typing the new rate in the calc line and pressing **I%YR'** (**F4**).
 - b. Calculate the adjusted payment by pressing **PMT'** (**F5**).
 - c. Optionally press **Adjust** (**F3**) to select the amortization adjustment screen. (This screen enables you to adjust other amortization variables, if necessary, for your particular problem.)
 - d. Continue using **GO** (**F2**) to calculate the adjusted amortization schedule.
 - e. When you're finished, press **ESC** to return to the amortization screen.

To start the amortization schedule over, press **2ND** **C** **D** to clear the data and begin again.

Amortization calculations use values of PV , PMT , and INT rounded to the number of decimal places specified by the current display setting. However, the stored values of PV and PMT do not change. Amortization uses all 16 digits of $I\%YR$.

Pressing **ESC** from the amortization screen returns you to the main TVM screen.

Example: Amortization Schedule for a Home Mortgage. Part 1.

Rufus Leekin has taken out a 30-year, \$65,000 mortgage at 12.5% annual interest. Calculate his monthly payment, and then calculate the first year's payments that are applied toward principal and interest.

Keys:

Description:

- Starts the TVM application.
- Clears any prior TVM data.
- 30 Enters the number of payments.
- 12.5 Enters the annual interest rate.
- 65000 Enters the amount of the mortgage.
- Calculates \$693.72 as the monthly payment.
- Selects the amortization screen.
- Calculates the amortization for the first year (12 payments).

14

Calculator		TVM Amortization - case 1		11/15/93 7:28 AM
Group	1	Payments	1 - 12	
Payments per Group:			12	
Amort interest rate.....		IXYR' =		12.50
Amort payment.....		PMT' =		-693.72
Remaining balance.....		BAL =		64,788.52
Interest.....		INT =		-8,113.16
Accum. interest.....		ACCUM =		-8,113.16
Principal.....		PRIN =		-211.48
				-693.72
Help Go Adjust 1/YR' PMT' BAL INT ACCUM PRIN 1-2-3				

Part 2. Calculate the loan balance after 3 1/2 years. (You've already amortized the first 12 months, so if you amortize 30 more months, you will have amortized a total of 42 months, or 3 1/2 years.)

- 30 Calculates the amortization for the next 30 payments. After 3 1/2 years, Rufus has an unpaid balance of \$64,129.05.

Example: Adjustable Rate Mortgage. Part 1. Pete Moss took out a \$100,000, 20-year ARM to purchase the building for his garden supply store. His interest rate for the first year is 8.25%. Moss expects the rate for the second year to increase to 8.75%. How would the increase affect his monthly payment for the second year?

Keys:

Description:

2nd **FV** **A** **T**

Starts the TVM application. (You may need to press **ESC** to display the main TVM screen.)

2nd **C** **D**

Clears any prior TVM data.

20 **↑** **F6**

Enters the number of payments.

8.25 **F7**

Enters the annual interest rate.

100000 **F8**

Enters the amount of the mortgage.

F9

Calculates the monthly payment of \$852.07.

F2

Selects the amortization screen.

F2

Calculates the amortization for the first year (12 payments). His remaining balance is \$97,948.74.

8.75 **F4**

Enters the adjusted interest rate (*1/YR'*).

F5

Calculates the adjusted payment (*PMT'*). The number of remaining periods is updated automatically to 228.

Calculator		TVM Amortization		Case 1		11/15/93 7:30 AM			
Group	1	Payments	1 - 12						
Payments per Group:			12						
Amort interest rate.....		IXYR'	=			8.75			
Amort payment.....		PMT'	=		-882.62				
Remaining balance.....		BAL	=	97,948.74					
Interest.....		INT	=	-8,173.58					
Accum. interest.....		ACCUM	=	-8,173.58					
Principal.....		PRIN	=	-2,051.26					
							PMT' = -882.62		
Help	Go	Back	1/YR'	PMT'	BAL	INT	ACCUM	PRIN	1-2-3

Moss's monthly payment would increase from \$852.07 in year 1 to \$882.62 in year 2.

Part 2. How much would Moss pay in interest the second year?

F2 Calculates amortization for the second year. Pete's interest total for the second year is \$8,487.46.

Example: Graduated Payment Mortgage. To purchase a vacation condominium, Biff Beamer took out a 15-year, 12.5% GPM for \$95,000. His monthly payment for the first 2 years is \$875, after which time the payment increases to fully amortize the loan. What will the remaining balance be at the end of the 2 years? How much will Biff's payment have to increase to fully amortize the loan by the end of the original 15-year period?

Keys:

Description:

F2 **ESC** **A** **T** Starts the TVM application. (You may need to press **ESC** to display the main TVM screen.)

ESC **C** **D** Clears any prior TVM data.

15 **↑** **F6** Enters the number of payments.

12.5 **F7** Enters the annual interest rate.

95000 **F8** Enters the amount of the mortgage.

875 **+/-** **F9** Enters the monthly payment during the first 2 years.

F2 Selects the amortization screen.

24 **F2** Calculates the amortization for the first 2 years, showing a remaining balance of \$98,106.01.

F5 Calculates the payment required to fully amortize the loan over the remaining number of periods. For the last 13 years of the loan Biff's monthly payment will be \$1,275.15.













Note

The previous example involves **negative amortization**—a case in which payments are less than accrued interest for a time, causing the principal to increase by the difference between paid and accrued interest. In negative amortization the interest amounts shown in the amortization screen reflect the *accrued* interest, not the interest *paid*. As long as the payment is less than the accrued interest for the period, you can calculate the interest paid for a group of payments by multiplying the payment amount by the number of payments in the group.



Sending an Amortization Table to 1-2-3 or a Printer

14

To print an amortization table:

1. From the amortization screen, press     to turn printing on. When printing is on, a PRINT annunciator appears in the upper-right corner of the display.
2. Use  and   to generate the parts of the table you want printed. (  is very useful here because it prints the table for the *number of groups* specified in the calc line.) The groups are printed as they are generated.
3. When you're finished printing, press     again to turn printing off. Leaving the amortization screen also turns off printing.

To send an amortization table to the current 1-2-3 worksheet:

1. From within TVM press `Amort` () then 1-2-3 (). The current 1-2-3 worksheet is displayed.
2. Move the cell pointer to the cell where you want to start receiving input and press . Eight amortization column headings are put into the worksheet and you are returned to the amortization screen. The amortization screen now shows a 1-2-3 annunciator in the upper-right corner of the screen to remind you that output will be sent to 1-2-3.

- Calculate amortization as described earlier in this chapter. Each time you press **GO** (or **↑ GO**) the results are sent to the current 1-2-3 worksheet—a row of information is sent for each group of payments calculated.
- When you no longer want the results sent to the current worksheet, press **1-2-3 (F10)** again. The 1-2-3 annunciator turns off.

When you display the worksheet, you'll be able to see the amortization output. Here is an example of five groups sent to a worksheet:

Group	BAL	PRIN	INT	ACCUM	#PMTS	IXVR	PMT
1	972.73	200.00	10.00	10.00	5	12.00	200.00
2	772.73	200.00	9.00	19.00	5	12.00	200.00
3	572.73	200.00	8.00	28.00	5	12.00	200.00
4	372.73	200.00	7.00	37.00	5	12.00	200.00
5	172.73	200.00	6.00	46.00	5	12.00	200.00

14

The table sent to the worksheet comprises eight columns of data:

Column	Description
Group	The group number.
BAL	The remaining balance at the end of that group of payments.
PRIN	The principal paid for that group of payments.
INT	The interest paid for that group of payments.
ACCUM	The accumulated interest paid.
#PMTS	The number of payments in that group.
I%YR	The annual interest rate for that group of payments.
PMT	The periodic payment for that group.

Calculating Interest Rate Conversions

Interest rates are generally stated as *nominal annual interest rates*. A nominal annual interest rate is an annual rate that is compounded *periodically*—for example, 18% per year, compounded monthly (12 times per year). When investments have different compounding periods, *effective interest rates* are used to compare them. The effective rate is the annual rate that would produce the same interest earnings as the nominal rate compounded P times per year. For example, earning 18% annual rate compounded monthly (nominal rate) is equivalent to earning 19.56% effective annual interest.

The Calculator lets you easily convert interest rates for comparison. When you press **MC/ON** **A** **T** to start TVM and then press

ICONV (**F3**), you get the interest conversion screen with the following function keys:

Key Label	Description
P/YR	Stores the number of payments per year.
I%YR	Stores or calculates the nominal annual rate.
EFF%	Stores or calculates the effective annual rate.
I%PER	Stores or calculates the periodic interest rate ($I\%YR \div P/YR$).
CONT	Stores or calculates the continuously-compounded rate.
360/365	Stores or calculates the rate based on the 360/365 method. (This is a very specialized method sometimes used in the savings industry. If you don't know about it, don't worry—it's too complicated to explain here.)

Storing any of the interest rate values *automatically* updates the others. Storing **P/YR** updates the other values based on the effective rate. Also, pressing **RCL** before a function key recalls that value to the calc line.











Pressing **ESC** from the interest conversion screen returns you to the main TVM screen.

Example: Converting and Comparing Interest Rates. Rodeo star Buck Doff is considering how to invest his recent winnings. He has two investment options: One promises to pay 13.6% annual interest, compounded daily, and the other promises to pay 14.0%, compounded

semi-annually. Which of Doff's options would give him the highest effective rate?

Keys:

Description:

- | | |
|---|---|
|     | Starts the TVM application. (You may need to press  to display the main TVM screen.) |
|  | Selects the interest conversion screen. |
| 365  | Enters the number of compounding periods in option 1. |
| 13.6  | Enters the nominal annual rate for option 1, and returns an effective annual rate of 14.57%. |
|  | Selects interest conversion screen, case 2. |
| 2  | Enters the number of compounding periods in option 2. |
| 14.0  | Enters the nominal annual rate for option 2, and returns an effective annual rate of 14.49%. |

14

Use  to switch back and forth between case 1 and case 2 to compare the effective rates. The effective annual rate for option 1 (14.57%) is higher than that for option 2 (14.49%).



If Compounding and Payment Periods Differ

TVM in the Calculator assumes that the compounding periods and the payment periods are the same. However, regularly occurring deposits and withdrawals do not necessarily coincide with the investment's compounding periods. To solve a TVM problem where they don't coincide, first convert the interest rate to an equivalent interest rate with compounding periods that match the regular deposits or withdrawals.

Example: A Savings Account with Compounding Periods Different from Payment Periods. Starting today, Penny Horder makes monthly deposits of \$25 into an account paying 5% interest compounded daily (365-day basis). At the end of 7 years, how much will Penny receive from the account?

Keys:



365 

5 

12 





7  

25  

0 



Description:

Starts the TVM application. (You may need to press  to get the main TVM screen.)

Clears any prior TVM data.

Selects the interest conversion screen.

Enters the number of compounding periods.

Enters the nominal annual rate for daily compounding, and returns an effective annual rate of 5.13%.

Enters monthly compounding periods, and calculates the equivalent nominal rate for monthly compounding at 5.01%.

Displays the main TVM screen.

Sets payment mode to beginning of a period.

Enters the total number of periods.

Enters the payment per period.

Enters the present value.

Calculates that Penny's account will have \$2,519.61 after 7 years.

Example: Canadian Mortgages. In Canadian mortgages, interest is compounded semi-annually while payments are made monthly. The *Canadian mortgage factor* is calculated by converting the stated nominal interest rate (compounded semi-annually) to the nominal rate compounded monthly (the payment period). The factor is then used as the TVM variable $I\%YR$.

The multinational law firm of Honig, Bradley, and Erickson has opened a Canadian office in Toronto. What is the monthly payment

required to fully amortize their 30-year, \$300,000 Canadian mortgage with an interest rate of 11.5%?

Keys:

2nd **7** **MEMO** **A**

T

MEMO **C** **D**

F3

2 **F3**

11.5 **F4**

12 **F3**

ESC

30 **↑** **F6**

300000 **F8**

0 **F10**

F9

Description:

Starts the TVM application. (You may need to press **ESC** to get the main TVM screen.)

Clears any prior TVM data.

Selects the interest conversion screen.

Enters the number of compounding periods.

Enters the nominal annual interest rate and calculates 11.83% as the effective annual rate.

Enters monthly compounding periods, and calculates 11.23% as the equivalent nominal rate for monthly compounding (the *Canadian mortgage factor*).

Displays the main TVM screen.

Enters the total number of periods.

Enters the present value.

Enters the future value.

Calculates Honig, Bradley, and Erickson's monthly payment to be \$2,910.09.

14

Additional TVM Examples

Yield of a Discounted (or Premium) Mortgage

The annual yield of a mortgage bought at a discount or premium can be calculated given the original mortgage amount (PV), interest rate ($I\%YR$), periodic payment (PMT), balloon payment (if any) (FV), and the price paid for the mortgage (new PV).

Example: Yield of a Discounted Mortgage. Seymour Profit wishes to purchase a \$100,000 mortgage from Skip Towne. Towne originally issued the mortgage at 9% interest for 20 years. Since the mortgage

was issued, 42 monthly payments have been made. The loan is to be paid in full (a *balloon payment*) at the end of its fifth year. What is the yield if the purchase price of the mortgage is \$79,000?

1. Calculate PMT for the fully amortized loan ($N = 20 \times 12$, $FV = 0$, $PV = -100,000$, and $I\%YR = 9$).
2. Calculate the balloon payment (FV). (Use PMT from step 1, $N = 5 \times 12$).
3. Store the number of payments remaining until the balloon payment as N ($5 \times 12 - 42$), and store the proposed purchase price as PV ($-79,000$); calculate $I\%YR$ (the annual yield).

Step 1. Calculate PMT .

Keys:

2nd **FV** **2nd** **A**
T

Description:

Starts the TVM application. (You may need to press **ESC** to display the main TVM screen.)

2nd **C** **D**

Clears any prior TVM data.

20 **↑** **F6**

Enters the total number of monthly payments for a full 20-year mortgage.

9 **F7**

Enters the annual interest rate.

100000 **+/-** **F8**

Enters the amount of the original loan.

0 **F10**

Enters 0 as FV .

F9

Calculates the monthly payment received from the borrower to be \$899.73.

Step 2. Calculate the balloon.

5 **↑** **F6**

Enters the number of payments in 5 years.

F10

Calculates the balloon due in 5 years to be \$88,707.05.

Step 3. Calculate the yield.

RCL **F6** **-** 42
F6

Enters the number of payments remaining until the balloon payment.

79000 **+/-** **F8**

Enters proposed, discounted purchase price.

F7

Calculates annual yield for discounted mortgage with balloon to be 20.72%.

Loans With Fees

The **annual percentage rate**, APR, incorporates fees charged when a mortgage is issued, which effectively raises the interest rate. The actual amount received by the borrower (PV) is reduced, while the periodic payments remain the same.

Example: APR of a Loan with Fees. Ernest Munnie is charged two points for the issuance of his mortgage. (One point is equal to 1% of the mortgage amount.) If the mortgage amount is \$60,000 for 30 years and the interest rate is 11.5% annually with monthly payments, what APR is Ernie paying?

1. Calculate PMT , using $PV = \$60,000$ and $I\%YR = 11.5\%$.
2. Adjust PV to reflect the amount of the loan minus the fees. Then, calculate the APR ($I\%YR$), using the PMT calculated in step 1 (all other values remain the same).

Step 1. Calculate PMT .

Keys:

2nd **CLR TVM** **A**
T

Description:

Starts the TVM application. (You may need to press **ESC** to display the main TVM screen.)

2nd **C** **D**

Clears any prior TVM data.

30 **↑** **F6**

Enters the number of monthly payments.

11.5 **F7**

Enters the annual interest rate.

60000 **F8**

Enters the amount of the loan.

0 **F10**

Enters 0 as FV since there's no balloon payment.

F9

Calculates \$594.17 as the monthly payment.

Step 2. Adjust *PV* and calculate the APR.

RCL **F8** **-**
2 **%** **F8**

Enters the actual amount of money received by the borrower.

F7

Calculates the APR to be 11.76%.

Example: Interest-Only Loan with Fees from the Lender's Point of View. Bill Lender is making a \$1,000,000, 10-year, 10.5% (annual interest) *interest-only* loan with an origination fee of 3 points. What is the yield to Bill? Assume that the interest-only payments are made monthly. (*PMT* is $\$1,000,000 \times 10.5 \div 12$, *FV* is the entire loan amount, and *PV* is the loan amount minus the points.)

Keys:

2nd **F7** **2nd** **A**
T

Description:

Starts the TVM application. (You may need to press **ESC** to display the main TVM screen.)

2nd **C** **D**

Clears any prior TVM data.

10 **↑** **F6**

Enters the number of monthly payments (120).

1000000 **F10** **+/-**
F8

Enters loan amount and balloon payment (the entire loan).

10.5 **F7**

Enters annual interest rate.

F9

Calculates and stores the monthly payment of \$8,750.

RCL **F8** **-** 3
% **=** **F8**

Enters amount borrowed (total—points) as \$970,000. ($PV = -970,000$.)

F7

Calculates APR, the yield to the lender, as 11.00%.

A Tax-Free Account

You can use the TVM screen to calculate the future value of a tax-free or tax-deferred account, such as an IRA or Keogh account. Current tax law will determine the extent to which the account is tax-free. The purchasing power of the future value depends on the inflation rate and the duration of the account.



- N = the number of payments until retirement.
- $I\%YR$ = the annual dividend rate.
- PV = the present value of the retirement account.
- PMT = the amount of your deposit. (It must be constant for the duration of the account.)
- FV = the future value of the retirement account.

Example: Future Value and Purchasing Power of a Tax-Free Account. Part 1. Les Tacksis plans to open an individual retirement account with a dividend rate of 8.175%, and invest \$2,000 at the beginning of each year until he retires in 35 years. Calculate the account balance at retirement.

14

Keys:

  



1 



35 

8.175 

0 

2000  



Description:

Starts the TVM application. (You may need to press  to display the main TVM screen.)

Clears any prior TVM data.

Sets payments per year to 1.

Sets payment mode to BEGIN.

Enters the number of periods.

Enters the dividend rate.

The present value is 0 before the first payment.

Enters the annual deposit.

Calculates \$387,640.45 as the amount in the account at retirement.

Part 2. How much has Les paid into the account at retirement?

RCL F9 *
RCL F6 =

Calculates $PMT \times N$ to be \$70,000.00.

Part 3. How much interest has the account earned. (The interest earned equals the difference between FV and the total amount deposited.)

+ RCL F10
=

Calculates the interest part of FV to be \$317,640.45.

Part 4. If his post-retirement tax rate is 15%, what is the after-tax future value of the account? Assume only interest is taxed.

* 15 % =

Calculates taxes, 15% of total interest.

+/- + RCL
F10 =

Subtracts taxes from total FV to calculate after-tax FV to be \$339,994.39.

Part 5. Calculate the purchasing power of this amount in today's dollars, assuming an 8% annual inflation rate.

F10
0 F9
8 F7
F8

Calculates the purchasing power in today's dollars to be \$22,995.36. (A negative number for PV in the display indicates money available to flow *from* the investor, so it represents positive purchasing power.)

A Taxable Retirement Account

The following example calculates the future value of a *taxable* retirement account that receives regular, annual payments. The annual tax on the interest is paid out of the account. (Assume the deposits have been taxed already.)

- N = the number of payments until retirement.
- $I\%YR$ = the annual interest rate diminished by the tax rate: $interest\ rate \times (1 - tax\ rate)$.
- PV = the current amount in the retirement account.
- PMT = the amount of the annual payment.
- FV = the future value of the retirement account.

Example: Future Value and Purchasing Power of a Taxable Retirement Account. Part 1. Izzy Smart is considering investing his money with E. Norma Spayback Investment Company. They claim that if Izzy invests \$3,000 with them each year for 35 years at a dividend rate of 8.175%, with dividends taxed as ordinary income, he'll be rich at retirement with close to \$500,000. Exactly how much would Izzy have in the account at retirement? Assume a tax rate of 28%, and that payments begin today.

Keys:

2ND **FV** **A**
T

2ND **C** **D**

1 **F5**

F4

35 **F6**

8.175 **-** 28 **%**

F7

0 **F8**

3000 **+/-** **F9**

F10

Description:

Starts the TVM application. (You may need to press **ESC** to get the main TVM screen.)

Clears any prior TVM data.

Sets payments per year to 1.

Sets payment mode to **BEGIN**.

Enters the number of periods.

Enters and stores the dividend rate diminished by the tax rate as 5.89%.

The present value is 0 before the first payment.

Enters the annual deposit.

Calculates \$345,505.61 as the future value of the taxed account. Due to taxation, this is *not* “close to \$500,000.”

Part 2. What would be the purchasing power of that amount in today’s dollars, assuming 8% annual inflation?

0 **F9**

No payments (*PMT*).

8 **F7**

I%YR

F8

Calculates the purchasing power in today’s dollars to be \$23,368.11. (A negative number for *PV* indicates money to flow *from* the investor, so it is positive purchasing power.)

Uneven Cash Flow Calculations

When you press **CF** **MENU** **A** **F**, you get the Cash Flows application, which enables you to calculate internal rate of return (IRR%), net present value (NPV), net uniform series (NUS), and net future value (NFV). Also, you can plot net present value versus the annual interest rate.

NPV and IRR%: Discounting Cash Flows

15

The NPV and IRR% functions are frequently referred to as *discounted cash flow functions*. When a cash flow is discounted, you calculate its present value. When multiple cash flows are discounted, you calculate the present values and add them together.

The net present value (NPV) function finds the present value of a series of cash flows. The annual nominal interest rate must be known to calculate NPV.

The internal rate of return (IRR%) function calculates the annual nominal interest rate that is required to give an NPV of zero.

The utility of these two financial tools becomes clear after working a few examples.

Making Cash-Flow Calculations

To make cash-flow calculations:

1. Organize your cash flows. (Just like with TVM, money flowing from you is negative, and money flowing to you is positive.) Put equal, consecutive cash flows into groups.
2. Press **2nd** **FV** **2nd** **A** **F** to start the Cash Flow application.
3. If necessary, clear prior data by pressing **2nd** **C** **D**.
4. Enter the number of compounding periods per year.
5. If you plan to calculate NPV, NUS, or NFV, enter the annual interest rate.
6. Enter the amount of the initial investment.
7. Enter the amount of the next cash flow. (If this amount occurs more than once consecutively, enter in the right-hand column the number of times it occurs.)
8. Repeat the previous step for all cash flows and groups.
9. Press the function key for what you want to calculate: IRR%, NPV, NUS, or NFV.

15

Here is what some cash-flow data might look like:

Cash-flow amounts.

Calculator: CFLOW.CFL		Cash Flow	11/15/93	7:49 AM
	Init. Flow:	-50,000.00		1
	Flow# 1) <-	10,000.00		3
	2)	10,000.00		4
	3)	0.00		1
P/YR = 1	4)	15,000.00		3
	5)			
	6)			
	7)			
	8)			
	9)			
I%YR = 0.00				
IRR%/YR = 11.30				
Help Insert Delete IRR%/YR NPV NUS NFV I/YR P/YR Plot				

Number of occurrences.

An Example of Cash-Flow Data

You can save your cash-flow data in files for future use by using **2nd** **F** **C**. Cash-flow files are automatically given a .CFL extension. You open cash-flow files using **2nd** **F** **O**.

The Cash-Flow Function Keys

Key Label	Description
Insert	Inserts cash flows into the list at the highlight.
Delete	Deletes the highlighted cash flows.
IRR%/YR	Calculates the <i>annualized</i> internal rate of return--the annual interest rate at which the net present value of the cash flows equals 0.
NPV	Calculates net present value--the present value of a series of cash flows plus the initial cost of the investment, computed for a specified periodic interest rate.
NUS	Calculates net uniform series--the dollar amount of regular, equal cash flows having a present value equivalent to the net present value.
NFV	Calculates net future value--the future value of the net present value.
I%/YR	Stores the annual nominal interest rate.
P/YR	Stores the number of periods per year.
Plot	Plots NPV vs. the periodic interest rate.

15

Uneven Cash Flow Examples

Example: Calculating IRR%, NPV, NUS, and NFV of an Investment. Part 1. An investor makes an initial investment of \$80,000 and expects returns over the next 5 years as shown in the table below:

Year 1	\$5,000
Year 2	\$4,500
Year 3	\$5,500
Year 4	\$4,000
Year 5	\$115,000

Calculate IRR%, NPV, NUS, and NFV, assuming an annual interest rate of 10.5%.

Keys:

2 **MEMO** **A**
F

MEMO **C** **D**

1 **F9**

80000 **+/-** **ENTER**

5000 **ENTER** 4500

ENTER 5500

ENTER 4000

ENTER 115000

ENTER

F4

10.5 **F8**

F5

F6

F7

Description:

Starts the Cash Flow application.

Clears any prior data.

Enters 1 compounding period per year.

Enters the investment as the initial cash flow

Enters the cash flows over the life of the investment.

Calculates the IRR% per year to be 11.93.

Enters the annual interest rate.

Calculates the NPV to be \$4,774.63.

Calculates the NUS to be \$1,275.66.

Calculates the NFV to be \$7,865.95.

15

Part 2. Assuming the same interest rate, calculate NPV if cash flow number 4 is reduced from \$4,000 to \$1,000.

Highlight flow# 4

Use the arrow keys to highlight the \$4,000 cash flow.

1000 **ENTER**

Inserts \$1,000 in its place.

F5

Calculates the NPV to be \$2,762.43.

Example: An Investment with Grouped Cash Flows. You are considering an investment that requires a cash outlay of \$50,000 with the following annual returns:

Flow 1	3 annual payments of \$5,000
Flow 2	4 annual payments of \$10,000
Flow 3	1 annual payment of \$0
Flow 4	3 annual payments of \$15,000

Calculate IRR%. Also, find the NPV at an annual interest rate of 9%.

Keys:

2nd **FV** **A**
F

Description:

Starts the Cash Flow application.

2nd **C** **D**

Clears any prior data.

1 **F9**

Enters 1 compounding period per year.

50000 **+/-** **ENTER**

Enters the initial investment.

5000 **▶** 3
ENTER 10000 **▶**

Enters the groups of cash flows.

4 **ENTER** 0

ENTER 15000 **▶**

3 **ENTER**

F4

Calculates an IRR% of 11.30.

9 **F8** **F5**

Enters the interest rate and calculates an NPV of \$6,728.63.

Example: An Investment with Quarterly Returns. You have been offered an opportunity to invest \$20,000. The investment returns quarterly payments over 4 years as follows:

Year 1	4 payments of \$500
Year 2	4 payments of \$1,000
Year 3	4 payments of \$2,000
Year 4	4 payments of \$3,000

Calculate the annual rate of return for this investment.

Keys:

4

20000

500 4

1000 4

2000 4

3000 4

Description:

Starts the Cash Flow application.

Clears any prior data.

Enters 4 periods per year, based on quarterly payments.

Enters the initial investment.

Enters the groups of cash flows.

Calculates the annual return to be 9.72%.

15

Example: Deposits Needed for a Future Expenditure. Your son will be starting college in 12 years, at which time he will need \$15,000 at the beginning of each year for 4 years. How much should you deposit each month into a fund paying 9% annual interest to meet his educational expenses?

To do this calculation, enter the withdrawals into a cash flow list along with zero for all the deposits. Then, store the annual interest rate and calculate NUS. NUS is the periodic deposit equivalent to the withdrawals.

Keys:

0

0 12 12

1

15000

0 11

15000

0 11

15000

0 11

15000

9

Description:

Starts the Cash Flow application.

Clears any prior data and resets the number of periods per year to 12.

Enters zero as the initial cash flow.

Enters 143 months (after the initial investment) until the first withdrawal.

Enters the freshman year withdrawal.

Enters 11 more months until the next withdrawal.

Enters the sophomore year withdrawal.

Enters 11 more months until the next withdrawal.

Enters the junior year withdrawal.

Enters 11 more months until the next withdrawal.

Enters the senior year withdrawal.

Enters the interest rate.

Calculates an NUS of 182.30. Starting this month, you would need to make monthly payments of \$182.30 into this fund for your son's education.

Plotting

Pressing Plot (F10) when you're in the Cash Flow application enables you to plot NPV versus I%/YR for the current cash-flow data. Here is a plot using the autoscale feature (Auto) for the second example in this chapter.

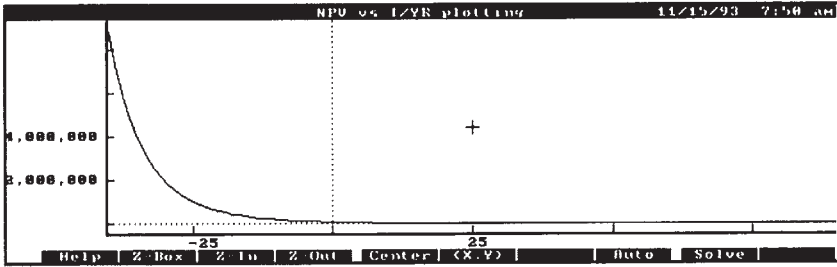

15

For a more detailed explanation of the plotting parameters and procedures, see "Function Plotting" in chapter 19.

Currency and Other Unit Conversions

Press **(F2)** **(EDIT)** **(A)** **(O)** to see the Conversions menu. (Or, as a shortcut from within the Calculator, press **(CTRL)+(O)**.)

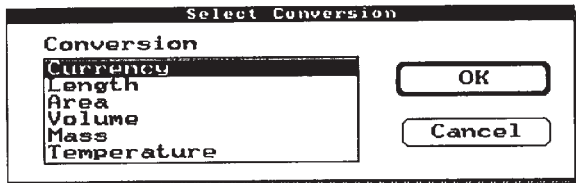

Highlight the units you want to convert and press **(ENTER)**. (To highlight a unit type, either use the arrow keys or type the first letter of the word.)

Pressing **(ESC)** from any conversion screen returns you to the Select Conversions menu. Also, pressing **(EDIT)** **(C)** **(D)** clears all the displayed unit values.

Converting Currencies

Since exchange rates change frequently, you have the ability to change exchange rates between currencies.

To change exchange rates:

1. From within Currency Conversions, press **(F2)** (Edit) to display the Currency Conversions Edit screen.
2. Use the arrow keys to highlight a currency.
3. Type the exchange rate for that currency. (A rate of 0 removes a currency from consideration when you calculate exchanges.)

4. Press **▼** or **ENTER**.
5. Repeat the steps 4 through 6 for all the desired currencies. (Note that **F10** (More) enables you to see all three screens of currencies.) Here is what a list might look like.

Calculator		Currency Conversions Edit		11/19/93 7:23 AM											
Update currency conversion rates.															
Dollar	Rate =		1.00											
Yen	Rate =	123.	00											
Mark	Rate =	1.	58											
Franc	Rate =	5.	33											
Lira	Rate =	1,450.	00											
Pound	Rate =	0.	64											
Canadian \$	Rate =	1.	28											
				0.00											
<table border="1"> <tr> <td>Help</td> <td>Name</td> <td>Dollar</td> <td>Yen</td> <td>Mark</td> <td>Franc</td> <td>Lira</td> <td>Pound</td> <td>Canada</td> <td>More</td> </tr> </table>						Help	Name	Dollar	Yen	Mark	Franc	Lira	Pound	Canada	More
Help	Name	Dollar	Yen	Mark	Franc	Lira	Pound	Canada	More						

16

6. When you're finished assigning rates, press **ESC** to return to the main Currency Conversions screen.

To calculate exchanges:

- From within Currency Conversions, type the number of units and press the function key for the corresponding currency—for example, 20 **F8** (POUND). All the currencies are shown simultaneously in equivalent amounts—in this case, in amounts equal to 20 Pounds.

A currency value can be returned to the calc line by pressing **RCL** followed by the function key for the currency you want.

Changing the List of Currencies

You can add up to five currencies to the list of currencies, plus you can change the name of any currency in the original list. Effectively, this means that you can create a list with any 21 currencies you want.

To change the name of a currency:

1. From within Currency Conversions, press **F2** to display the Currency Conversions Edit screen.
2. Highlight the currency you want to change and press **F2** (Name).
3. Type the new name and press **ENTER**.
4. Type the exchange rate for the new currency and press **ENTER**.
5. Repeat steps 2 through 4 for all changes you want to make.

6. When you're finished, press **(ESC)** to return to the main Currency Conversions screen.

You can use the previous procedure to add a new currency to the bottom of the list by highlighting an empty currency line in step 2. (Use **(F10)** to find a page of currencies with empty lines.)

Converting Other Units

Besides currency conversions, you have the ability to convert related units within the categories of length, area, volume, mass, and temperature.









To convert units of length, area, volume, mass, or temperature:

1. Press **(\rightarrow)** **(MENU)** **(A)** **(O)** to start the Conversions application.
2. Select the type of units you want to convert (highlight and press **(ENTER)**).
3. Type a value and press the function key corresponding to its unit. (If the unit you want isn't currently displayed, remember that **(F10)** displays another screen of related units for most unit types.)

A unit value can be returned to the calc line by pressing **(RCL)** followed by the function key for the unit you want.

Example: Length Conversion. How many meters are there in 1 mile?

Keys:

-   
- 
-  
- 1 
-  

Description:

Starts the Conversions application.

Displays the length conversions screen.

Enters 1 mile and displays the conversions.

Returns the number of meters to the calc line. There are 1609.34 meters in 1 mile.

16

Calculator		Length Conversions		11/15/93 8:09 am	
miles.....	mile	=			1.00
yards.....	yard	=		1,760.00	
feet.....	foot	=		5,280.00	
inches.....	inch	=		63,360.00	
kilometers.....	km	=		1.61	
meters.....	meter	=		1,609.34	
centimeters.....	cm	=		160,934.40	
millimeters.....	mm	=		1,609,344.00	
				meter =	1,609.34
					

Statistics

When you press **(2nd)** **(STAT)** **(A)** **(L)** (or **(CTRL)**+**(L)** from anywhere in the Calculator), you get the List Stat application, which enables you to

- Calculate statistics for a column of data.
- Fit a curve to a set of data.
- Forecast estimates.
- Graph your data and curve.

17

Entering and Editing Data

You can enter data in either one column for one-variable statistics or two columns for paired-variable statistics. When you're in the **data edit screen**, **(F4)** switches between one and two columns.

Calculator: STAT, STAT		Statistics: Edit X		11/15/93 8:01 am	
Item	1)		340.00		
	2)		175.00		
	3)		450.00		
	4)		780.00		
	5)		625.00		
	6)		245.00		
	7) <-				
	8)				
	9)				
Sum:			2,615.00		
				1-Var	245.00
Help		Insert	Delete	2-Var	SwapVar
		Sort	SUM	STATs	

Data Edit Screen with One Column of Data

To enter statistical data:

1. Press **(2nd)** **(STAT)** **(A)** **(L)** to start the List Stat application.
2. If the data edit screen is not displayed, press **(ESC)** one or more times or press **Edit (F10)** to see it.

3. If the displayed number of columns (one or two) is not right for your data, press **F4**.
4. Type in your data, pressing **ENTER** after each number.

To edit a list of data:

- Highlight an entry to change, type a number, and press **ENTER**.

You can also use these keys in the data edit screen:

Data Editing Function Keys

Key Label	Description
Insert	Inserts new data at the highlight, moving the rest of the data down.
Delete	Deletes the highlighted number. (Note that the <i>data pair</i> is deleted, whether both numbers are displayed or not.)
Sort	Numerically sorts the column with the highlight from least to greatest. (Pairs of data are kept together.)
SwapVar	Swaps the position of the two columns of data, even if only one column is displayed. Note: If you've entered only one column of data, SwapVar swaps that column with a column of zeros; pressing SwapVar swaps back the original data.

17

To clear data:

- From the data edit screen, press **ESC** **C** **D** to clear the entire data list. (Both columns are cleared, even if only one is visible.)



Saving Statistical Data in a File

When you switch to another application or open another data file, changes to the current file are saved automatically. The default statistics file is **STAT.STA**.

- You can copy data to another file that you name by using **ESC** **F** **C** (File Copy). If you don't specify a file extension, the palmtop automatically appends the extension **.STA** for you.
- Use **ESC** **F** **O** to open another statistical data file.

Statistics Calculations

To calculate statistics for a column of data:

1. Make sure the highlight is in the column of data you want to use to calculate the statistics (use  or .
2. Press **Stats** (.

Here are the function keys available when you press **Stats** :

Stats Function Keys

Key Label	Description
MEAN	Recalls the mean value to the calc line.
STDEV	Recalls the standard deviation to the calc line.
MIN	Recalls the minimum value to the calc line.
MEDIAN	Recalls the median value to the calc line.
MAX	Recalls the maximum value to the calc line.
W. MEAN	Recalls the weighted mean to the calc line. (This key appears only when two columns of data are visible in the data edit screen.)
G. STDEV	Recalls the grouped standard deviation to the calc line. (This key appears only when two columns of data are visible.)
Sample Popul	 switches between sample and population for the model used to calculate the standard deviation and grouped standard deviation. Use SAMPLE to get unbiased results based on a <i>sample</i> of a population; use POPUL to get results based on data for an entire population. The Sample/Popul annunciator (just above the calc line) indicates the current mode.
Edit	Returns to the data edit screen.

Example: Statistics Calculations. Nimrod Archery Company had the following phone bills during the past 6 months:

Month	Phone Expense	Month	Phone Expense
1. March	\$340	4. June	\$780
2. April	\$175	5. July	\$625
3. May	\$450	6. August	\$245

To prepare for this example:

1. Press **2nd** **MEMO** **A** **L** to start the List Stat application.
2. Press **MEMO** **C** **D** to clear any prior data.
3. If **F4** shows **1-Var**, press it to display only one column of data. (When you press **1-Var**, the label changes to **2-Var**.)

Now calculate population statistics for the data and return the standard deviation to the calc line.

Keys:

Description:

- 340 **ENTER**
- 175 **ENTER**
- 450 **ENTER**
- 780 **ENTER**
- 625 **ENTER**
- 245 **ENTER**

Enters the data.

17

F9

Calculates and displays the statistics.

At this point if **F9** shows **Popul**, press it to choose the population statistics model for the standard deviation. (When you press **Popul**, the **Popul** annunciator appears above the calc line.)

F3

Returns the standard deviation to the calc line.

Calculator: STAT, STD		Statistics: X		11/15/93 8:04 AM				
Mean Value.....	MEAN	=	435.83					
Standard Deviation.....	STDEV	=	211.37					
Minimum Value.....	MIN	=	175.00					
Median Value.....	MEDIAN	=	395.00					
Maximum Value.....	MAX	=	780.00					
		1-Var	Popul					
			211.37					
Help		MEAN	STDEV	MIN	MEDIAN	MAX	Sample	Edit

To calculate weighted mean and grouped standard deviation:

1. Within the List Stat application, enter data into two columns, with the first column (x-column) containing the numeric data and the

second column (y-column) containing the weights or frequencies of each number.

2. Press **Stat** (**F9**) to see the values for weighted mean and grouped standard deviation. (To recall a value to the calc line, press the function key for the value you want.)

Curve Fitting and Forecasting

The Calculator enables you to find a mathematical relationship between two sets of numbers (x -values and y -values) using curve fitting. Once the curve is calculated, you can use it to do forecasting (what if?) calculations.

To calculate the curve, the Calculator uses one of four models. The default is Linear and stays in effect until you change it.

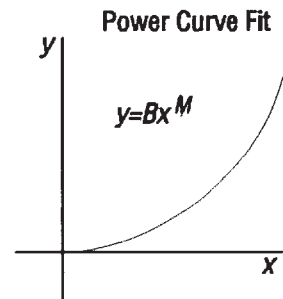
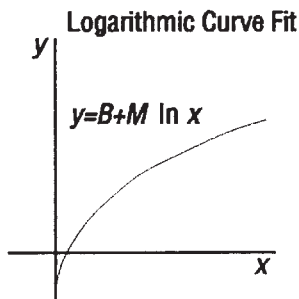
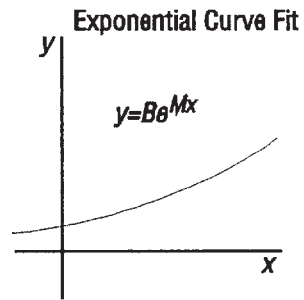
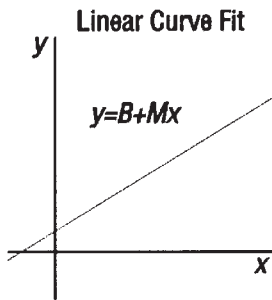

To do curve fitting and forecasting:

1. Within the List Stat application, enter two columns of data. With two columns visible, the left column represents the x -values and the right column represents the y -values.
2. Press **Forecast** (**F8**) and check the correlation coefficient to ensure the current model is acceptable.
3. If necessary, change the model by pressing (**F7**).
4. To do forecasting, type a number and press the function key for the known value—**XVALUE** or **YVALUE**.

Example: Curve Fitting and Forecasting. For the past 6 weeks the manager of Tom's and Jerry's Pet Store has kept records of their sales and the number of minutes of radio advertising that were purchased:

	Minutes of Advertising	Sales
Week 1	2	\$1,400
Week 2	1	\$920
Week 3	3	\$1,100
Week 4	5	\$2,265
Week 5	5	\$2,890
Week 6	4	\$2,200

17

Part 1. Determine whether there is a linear relationship between the amount of radio advertising purchased and the weekly sales.

To prepare for this example:

1. Press (**F7**) (**2ND**) (**A**) (**L**) to start the List Stat application.
2. Press (**2ND**) (**C**) (**D**) to clear any prior data.
3. If (**F4**) shows $Z=Var$, press it to display two columns of data.

Keys:

2 (**ENTER**) 1400

(**ENTER**)

1 (**ENTER**) 920

(**ENTER**)

Description:

Enters the first data pair.

Enters the second data pair.

3 **ENTER** 1100
ENTER

Enters the rest of the data.

5 **ENTER** 2265
ENTER

5 **ENTER** 2890
ENTER

4 **ENTER** 2200
ENTER

F8

Calculates the curve and displays the forecast screen.

If the forecast model is not Linear, press **F7** **L** **F10** to select it.

Calculator: STAT, STAT		Forecast		11/15/93 9:06 AM	
X Value.....	Y Value.....	XVALUE =	YVALUE =	0.00	0.00
Correlation.....		CORR =		0.90	
Slope.....		SLOPE =		425.88	
Intercept.....		INTRCPT =		376.25	
Forecast model.....		Model =		LINEAR	
				2-Var	2,200.00
Help XVALUE YVALUE CORR SLOPE INTRCPT Model Stats Plot Edit					

17

The correlation coefficient of 0.90 satisfies the manager that it is a linear relationship.

Part 2. Estimate the level of sales if 7 minutes of advertising were purchased.

7 **F2** **F3**

Enters 7 as the x -value and displays a y -value of 3,357.38. Tom's and Jerry's can expect around \$3,300 in sales with 7 minutes of radio advertising.

To view statistical summations:

1. Display the data edit screen (press **ESC**) one or more times if necessary).
2. Press **Frcast** (**F8**) then **Sums** (**F8**).
3. To recall a value to the calc line, press the function key for the summation value you want.

Here are the summation values for the data in the previous example:

Calculator: STAT,STR		Sums		11/15/93 8:07 AM	
Sum X.....	Sum X =		20.00		
Sum Y.....	Sum Y =	10,775.00			
Sum X*Y.....	Sum XY =	41,595.00			
Sum X ²	Sum X ² =	80.00			
Sum Y ²	Sum Y ² =	22,338,725.00			
			2-Var	3,357.38	
Help		Sum X	Sum Y	Sum XY	Sum X ² Sum Y ² Frcast

17

Plotting the Curve Model for Your Data

The easiest way to plot the curve model for your data is to use the autoscale feature:

1. Display the data edit screen (press **ESC**) one or more times if necessary).
2. Make sure both columns of data are visible (press **2-Var** if necessary).
3. Press **Frcast** (**F8**).
4. Press **Plot** (**F9**).
5. Press **Auto** (**F3**) to display the curve.
6. When you're finished viewing the curve, press **ESC**.

In addition, you can take advantage of the Calculator function-plotting power and flexibility as described in chapter 19 under "Function Plotting."

Date Calculations

Press **⇧** **DATE** **A** **D** to start the Date Calculations application. You can use Date Calculations to

- Determine the day of the week for any date.
- Find the number of days between two dates.
- Determine the date a given number of days in the future or past.

Date Calculation Function Keys

Key Label	Description
DATE1 DATE2	Stores or calculates a date, using the current Calculator date format—month/day/year (MM.DDYYYY), day.month.year (DD.MMYYYYY), or year.month.day (YYYY.MMDD). Also displays the day of the week. If you omit YYYY, the current year is used. (See the next page for more information on date formats.)
DDAYS	Stores or calculates number of days between <i>DATE1</i> and <i>DATE2</i> using the actual calendar. The actual calendar recognizes leap years.
360/YR	Calculates number of days between <i>DATE1</i> and <i>DATE2</i> using the 360-day calendar (based on 30-day months).
365/YR	Calculates number of days between <i>DATE1</i> and <i>DATE2</i> using the 365-day calendar (ignores leap years).
TODAY	Displays the current date, which can then be stored in <i>DATE1</i> or <i>DATE2</i> .

About Calculator Date Formats

The Setup utility enables you to set the current date format for your palmtop. The 11 different formats in Setup correspond to three formats that the Calculator uses. See chapter 21 for instructions on changing the current date format.

Date Formats: Calculator vs. Setup Utility

Calculator	Setup Utility	
DD.MMYYYY	(DD-MMM-YY) (MMM-YY) (DD.MM.YY) (DD.MM)	(DD-MMM) (DD/MM/YY) (DD/MM)
MM.DDYyyy	(MM/DD/YY)	(MM/DD)
YYYY.MMDD	(YY-MM-DD)	(MM-DD)

Example: Calculating Dates. What day of the week is July 4, 1996? How many days between July 4, 1996 and September 23, 1997? What day is 90 days after July 4? What day is 180 days prior to July 4? Assume the current date format is month/day/year (MM.DDYyyy).

Keys:

Description:



Starts the Date Calculation application.

7.041996

Enters July 4, 1996 in the current date format.



July 4, 1996 falls on a Thursday.

9.231997 

Enters September 23, 1997 in *DATE2*.



The actual number of days between *DATE1* and *DATE2* is 446.



90  

October 2 is 90 days after July 4, 1996.

180   

January 6 is 180 days prior to July 4, 1996.

To clear the Date Calculation variables:

- Press   . *DATE1* and *DATE2* are reset to today's date.

Using the Solver and Function Plotting

The Solver enables you to enter your own equations with variables into the Calculator. You can solve for any of the variables using special function keys, one for each variable, that the Solver creates for you. You can also plot an equation against any of its variables.

Your equations can be named and saved in the **Solve Catalog** for later use.

The Solve Catalog

Press **F6** **EQN** **A** **S** to start the Solver. If a screen entitled Solve Catalog is not displayed, press **ESC** repeatedly until it is. Until you enter some equations, your Solve Catalog will be empty, but here is an example with some equations.

Optional names.

Equations.

Optional names.	Equations.
Carpet	$PPSY * L * W / 9 = COST$
Volume	$V = L * W * H$
	$Rate * Time = Distance$
	$s_1^2 + s_2^2 = h^2$
Ec Order Qty	$EOQ = \sqrt{2 * FIXCST * SALES / (CARRY\% / 100 * PRICE)}$
Salary	$hours * rate = pay$

Press Edit (F6) to edit or view the highlighted equation.

Entering and Editing Equations

The Solve Catalog can contain as many equations as your palmtop's memory permits. Entering equation names is optional.

Solver Example. Suppose you frequently buy carpet and must calculate how much it will cost. The price is quoted to you per square yard. Regardless of how you do the calculation (even if you do it longhand), you use an equation:

$$\begin{array}{ccccccc} & \text{Price per} & & \text{Length} & & \text{Width} & \\ & \text{square} & & \text{(feet)} & & \text{(feet)} & \\ & \text{yard} & & & & & \\ & \swarrow & & \downarrow & & \swarrow & \\ & \text{PPSY} & \times & \text{L} & \times & \text{W} & = \text{COST} \\ & \hline & & & 9 & & & \\ & & & \uparrow & & & \\ & & & \text{Converts square feet to square yards.} & & & \end{array}$$

19

Part 1. Enter the above Carpet equation into the Solver.

Keys:



Carpet [ENTER]



PPSY [*] L [*]
W [/] 9 [=]
COST

Description:

Selects the Solve Catalog. (If you don't see a screen entitled Solve Catalog, press [ESC] until you see it.)

Ensures the highlight is at the end of the catalog and in the name field (the left side of the screen where equation names are displayed).

Enters the equation name into the name field.

Moves the highlight to the equation field.

Automatically displays the solve editor and types the Carpet equation.

(F10) (F9)

Verifies the equation, enters it into the equation list, and selects the solve calc screen. (If the Solver detects an error in the equation, the cursor in the solve editor locates the problem. Correct the error and press (F10) (F9) again.)

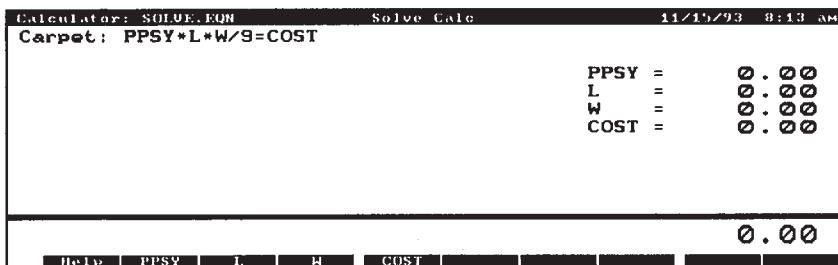

19

Part 2. Calculate the cost of carpet needed to cover a 9 foot by 12 foot room. The carpet costs \$22.50 per square yard.

Keys:

22.5 (F2)

12 (F3)

9 (F4)

(F5)

Description:

Stores the price per square yard in *PPSY*.

Stores the length.

Stores the width.

Calculates the cost, \$270.00.

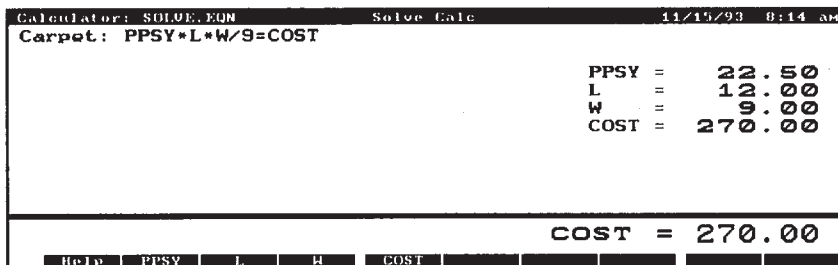

Part 3. Determine the most expensive carpet you can buy if the maximum amount you can pay to carpet the room is \$300.

The following steps illustrate the “point-and-shoot” way to enter a value into a variable and to solve for a variable. Point-and-shoot is described in detail in chapter 1.

Keys:

 300  

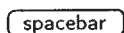











Description:

Stores \$300 in *COST* and moves the cursor to the *PPSY* cell.

Calculates the maximum price per square yard you can pay to be \$25.00.

To enter an equation and its name:

1. Press     to display the Solve Catalog. (You may need to press  one or more times, also.)
2. Move the highlight bar up or down to the position you want to enter the new equation.
3. Type the equation. When you start typing, the **solve editor** automatically starts. Follow these guidelines:
 - To improve readability, you can add spaces between elements.
 - You can add a comment at any point in an equation. Simply start and end the comment with an exclamation point (!).
 - Press  to break an equation at any point to improve clarity.
 - The maximum length of an equation is about 2000 characters, and a single equation can have up to 256 different variables.
4. Press .
5. (Entering a name is optional.) Press  to highlight the name field. Type a name and press .

When you're ready to use the equation, press **Calc** () , at which point the Solver verifies the equation. If the equation cannot be interpreted, the Solver briefly displays: *Invalid equation* and the cursor is positioned before the first character the Solver could not interpret. Check to be sure you've made no typing mistakes and that you've followed the rules for writing equations described later in this chapter.

To edit an equation or its name:

- From the Solve Catalog, press **F6** (Edit) to edit the highlighted equation or name. (To cancel an edit, press **ESC**.)

Calculating with Your Solver Equations

To perform a calculation:

1. Display the Solve Catalog screen.
2. Highlight the equation you want to calculate.
3. Press **□=□** (**F9**). This selects a new screen dedicated to the current equation where each variable is represented by a function key.
4. Store your known values by typing a value and then pressing the function key for the associated variable. You must store values in all variables but one.
5. Press the function key for the value you want to calculate. If the Solver is able to find a solution to the equation, the answer is displayed in the calc line.

In most cases, this is all you will need to know about how the Solver works. However, there are certain types of equations that are more difficult to solve. If, during the calculation, the display temporarily shows sets of changing numbers, such as:

```
A: 1.500000000000 -  
A: 1.13476129834 +
```

the Solver is searching for a solution. See “How the Solver Works” later in this chapter.

Clearing and Deleting Solver Equations and Variables

To clear (set to zero) a set of variables:

1. Display the Solve Catalog.
2. Highlight the desired equation and press **F9**.
3. Press **□=□** **C** **D**.

Caution

Be sure you display the solve calc screen (press **F9**), not the Solve Catalog screen to clear the variables for an equation. If you press **MEMO** **C** **D** in the Solve Catalog screen, you will erase *all* variables and *all* equations.

About Shared Solver Variables. If two or more equations contain the same variable names, that variable (and its value) is shared among the equations in which it appears. If you delete or clear a shared variable, its value is lost to all the equations that share it.

To delete an empty line, a name, or an equation and/or its variables:

- In the Solve Catalog highlight the empty line, name, or equation and use **F3** (Delete). (**ESC** cancels the delete command.)
-

Note

When deleting an equation, you should first delete its variables (as long as none are shared variables) to free up memory.

If you delete the equation's variables but not the equation, the variables are created again with values of zero the next time you use the equation.

To delete all variables and/or all equations:

1. Display the Solve Catalog.
 2. Press **MEMO** **C** **D**.
 3. Use **▲** to select all equations, all variables, or both.
 4. Press **F10** to delete them, or press **F9** to cancel the delete.
-

Note

When you delete variables, you free up for other uses the memory they used. If you do not delete the equations, the variables are created again with values of zero the next time you use the equation. (The memory used by a single variable is 15 bytes plus a byte for each character in the variable.)

Solve Catalog Function Keys

Solve Catalog Function Keys

Key Label	Description
Insert (F2)	Inserts a blank row above the highlighted row. This row is ready to accept your new name and your new equation.
Delete (F3)	Deletes highlighted name, highlighted equation and/or its variables, or a blank row.
Find (F4)	Searches names or equations (whichever field is highlighted) for specified characters. (See "Searching for Specific Text" in chapter 1 for details.)
Edit (F6)	Allows you to edit highlighted name or equation. Also allows you to view long equations.
1-2-3 (F8)	Displays the Solve 1-2-3 screen. Allows you to "back-solve" a 1-2-3 worksheet; that is, make a cell containing a formula equal to a desired value by solving for a specified input cell.
Calc (F9)	Verifies the equation or expression and selects the solve calc screen.
Plot (F10)	Displays function plotting.

19

Using Multiple Equation Lists

The Calculator Solver application enables you to manage different equation lists using the standard File commands.

- Use **Ctrl** **F** **C** (File Copy) to copy an equation list to a new file. (If you save the equation list using an existing file name, the new file will overwrite the old file.)
- Use **Ctrl** **F** **O** (File Open) to open an existing equation list file.
- Use **Ctrl** **F** **N** (File New) to create a new, empty equation list.
- Use **Ctrl** **F** **M** (File Merge) to merge another equation list into your current list at the position of the highlight.

Using the Solver in a 1-2-3 Worksheet.

A worksheet often contains a series of cells where all but one contain variable *values* (the variable *names* are the cell names), and where that one remaining cell contains the result of a formula calculation. The formula uses the other cell names as its variables, and the contents of those other cells are the values for those variables.

Normally, the values in the variable cells are entered first, then the formula cell calculates the result. The Solve Catalog's 1-2-3 feature (1-2-3) allows this calculation order to be reversed. Rather than have the formula-cell's value *calculated last*, it's *entered first*, and a *variable-cell's* value is *calculated last*. This variable cell is called the **solve cell**, and this method of calculating for that cell's value is called **backsolving**.

To calculate a 1-2-3 solve cell value that will produce a specified formula cell value:

1. Use 1-2-3 to create worksheet segment that includes a formula cell and the data cells representing all the variables used in the formula cell. Ensure that this worksheet is the current worksheet.
2. Enter values into all but one of the data cells. The remaining data cell is the solve cell.
3. Press **F7** **Alt** **A** **S** (and press **ESC** one or more times, if necessary) to display the Solve Catalog.
4. Press 1-2-3 (**F8**) to display the calculator's Solve 1-2-3 screen.
5. Press **Form** (**F8**) to display the current 1-2-3 worksheet.
6. Move the cursor to highlight the formula cell.
7. Press **ENTER** to define that cell as the formula cell and to return to the calculator's Solve 1-2-3 screen.
8. Type the value of the result you want that formula cell to calculate and press **VALUE** (**F9**).
9. Press **Solve** (**F10**) to display the current 1-2-3 worksheet.
10. Move the cursor to highlight the data cell you choose to be the solve cell—the cell whose value is to be determined.
11. Press **ENTER** to define that cell as the solve cell and to return to the calculator's Solve 1-2-3 screen. The cell's value is calculated, displayed in the Solve 1-2-3 screen, and entered in the worksheet.

To restore the solve cell to its previous value:

- Press \square (F5). The solve cell is restored to the value it had just before the last backsolve took place.

To set up a solver worksheet:

1. Write down your chosen formula (like $\text{DISTANCE} = \text{RATE} * \text{TIME}$), then convert it to an expression by subtracting the right side from the left (like $\text{RATE} * \text{TIME} - \text{DISTANCE}$).
2. Reserve a set of adjacent 1-2-3 cells, one for each variable in your expression and the last one (the formula cell) for the expression itself.
3. Enter the expression into the formula cell.
4. Press $\left[\rightarrow \right]$ $\left[\text{MENU} \right]$ $\left[A \right]$ $\left[S \right]$ (and press $\left[\text{ESC} \right]$ one or more times, if necessary) to display the Solve Catalog.
5. Press 1-2-3 (F8) to display the Solve 1-2-3 screen.
6. Press FORM (F8) to display the current 1-2-3 worksheet.
7. Move the cursor to the formula cell.
8. Press $\left[\text{ENTER} \right]$ to define that cell as the formula cell and to return to the calculator's Solve 1-2-3 screen.
9. Type 0 as the result you want that cell to calculate and press $\left[\text{VALUE} \right]$ (F9). Your solver worksheet is now ready to be used.

To use a solver worksheet:

This procedure starts with the worksheet set up as described in the above procedure "To set up a solver worksheet:". This worksheet is now the current worksheet. You know the values of all but one of the variables, and you'll use this solver worksheet together with the Calculator's Solve 1-2-3 screen to solve for that unknown.

1. If the Solve 1-2-3 screen is not displayed, display the Solve Catalog, then press 1-2-3 (F8).
2. Press $\left[\text{123} \right]$ to display the solver worksheet.
3. Enter values into all but one of the variable's cells.
4. Move the cursor to the unknown variable's cell.
5. Press $\left[\rightarrow \right]$ $\left[\text{F10} \right]$ $\left[\text{ENTER} \right]$ and see the solution in the calc line labeled *Solve result*. If the expression in the worksheet's formula cell does not evaluate to zero exactly, that cell will contain a very small number.
6. To solve for another variable, repeat these steps.

Example: Creating and Using a Solver Worksheet. This example demonstrates how to set up the solver worksheet and how to use it.

The equation used in this example is $\text{RATE} * \text{TIME} = \text{DISTANCE}$. The solver worksheet uses expressions, not equations, so forming left – right gives the expression $(\text{RATE} * \text{TIME}) - \text{DISTANCE}$. If you want to press keys as you follow this example, create the worksheet shown in the following figure. Cells B3, B4, and B5 contain values only; no formulas. Cell B8 contains the formula $+B3*B4-B5$. When the example starts, this worksheet is the current worksheet.

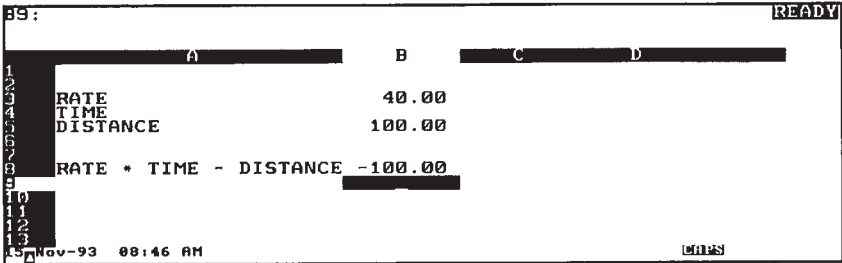

19

Keys:

Description:

123

Displays the solver worksheet containing the formula $(\text{RATE} * \text{TIME}) - \text{DISTANCE}$ in cell B8.

highlight cell B3

Move the cursor to cell B3.

40 **▼** **▼** 100

Enters 40 miles per hour into B3 and 100 miles into B5.

▼ **▼** **▼**

Moves the cursor to cell B8.

F2 **DIRTY** **A**

Displays the Solve Catalog. (You may have to press **ESC** one or more times.)

S

1-2-3 **(F8)**

Displays the Calculator's 1-2-3 screen.

Form **(F8)**

Displays the current 1-2-3 worksheet. The cursor highlights cell B8, the formula cell.

- ENTER** Defines B8 as the formula cell and returns to the Calculator's 1-2-3 screen.
- 0 VALUE (**F9**) Enters the value the formula cell is to calculate.
- Solve (**F10**) Displays the worksheet. The formula cell, B8, is highlighted.
- ▲** (*4 times*) Highlights cell B4, TIME. This is the cell whose value is to be calculated to force cell B8 to equal zero.
- ENTER** Defines B4 (TIME) as the solve cell and returns to the solve 1-2-3 screen. The calculation is performed and the display shows 2.5 hours (the `Solve result`) as the time required to cause `RATE * TIME - DISTANCE (B8)` to equal zero. If you return to the worksheet, you'll see that B8 now contains 0.

How the Solver Works

Initially, the Solver tries to find a *direct* solution by rearranging the equation and then solving for the variable. If the Solver finds a direct solution, the Calculator displays the answer on the calc line, and no other information is displayed.

If the Solver is unable to find a direct solution, the Solver tries to find an *iterative* solution. This involves searching for the answer by estimating a set of answers, seeing how close they are to a solution, and then making another set of estimates. The Calculator displays the current estimates (“guesses”) while the Solver is searching for an answer iteratively. You should keep in mind that *there may be more than one solution to an equation*, and that it may be necessary for you to enter guesses in order to influence which solution the Solver finds.

Since the process of finding an iterative solution is very complex, there are four possible outcomes that you should be aware of:

- The Calculator displays an answer but displays no message. It is very likely that the Solver has found a solution. The Calculator may display additional information if you repeat the calculation by pressing the function key for the variable you solved for.
- The Calculator displays an answer and automatically displays a message. The Solver has found a possible solution, but you must use judgement in interpreting the results.
- The Calculator displays `Try again. Bad guesses.` This indicates that the Solver cannot begin the search with the current guesses. (See the following section “Entering Guesses.”)
- The Calculator displays `Solution not found` because the Solver was unable to find a solution. Check to see if your equation and stored values are correct. If the equation is correct, you may be able to find a solution by entering very good guesses.

Halting and Restarting an Iterative Search

19

When the Solver is searching for an iterative solution, you can halt the calculation by pressing any key. The Calculator displays the best estimate the Solver has found so far, and the message `Interrupted`. You can restart the search from where it left off by pressing the function key for the variable you are solving for. Or, you can restart the search using your own guesses.

Entering Guesses

Entering your own guesses serves two purposes. First, it can save time by telling the Solver where to start searching. Second, if more than one solution exists, entering guesses can help the Solver select the answer you want. You can enter guesses in the Solve Calc screen at these times:

- Before beginning the calculation, after you’ve stored a value for every variable except the unknown variable.
- After you’ve halted the iterative search.
- After the Solver has returned an answer, and you want to begin searching for another answer somewhere else.

You can enter one or two guesses. If you enter one guess, the Solver makes a second guess. If you enter two guesses, the Solver starts searching for a solution in the range between the two guesses.

To enter guesses:

- To enter only one guess, key in the value and press the function key for the variable twice.
- To enter two guesses, key in the first guess and press the function key once, and then key in the second guess and press the function key twice.

Rules for Writing Equations

The rules for writing equations use several terms:

- *Variables* are the named items for which you store or calculate values.
- *Constants* are numbers—for example, \$10,000, 360 days.
- *Operators* perform arithmetic—for example, * and -.
- *Functions* do calculations using mathematical capabilities built into the Solver—for example, $\text{SQRT}(x)$, $\text{USPV}(i\%,n)$, and $\text{DDAYS}(d1,d2,cal)$.

Length of Equations

An equation cannot exceed 2279 characters and cannot contain more than 256 different variables. There are no other limits as long as there is sufficient memory to store it.

Variable Names

Solver variable names can be a maximum of 15 characters long and must be all one word (no spaces allowed). The following characters are not allowed in variable names: +, -, *, /, ^, (,), <, >, =, :, ;, !, {, }, [,], and |. Also, the character currently defined as argument separator (, in US mode and . in European mode) is not allowed in variable names. You cannot use NOT, AND, OR, or XOR as variable names, nor can you use the names of functions that have no arguments as variable names. A variable name cannot begin with a number. Variable names are case sensitive.

The first seven characters of the variable names become function key labels. Therefore, make sure no two variables have the same first seven characters.

Constants

Constants must be keyed in as numbers without digit separators or other characters.

Functions

An equation can contain any of the functions shown in the “Solver Functions” table later in this chapter. Functions are built-in shortcuts to creating complex expressions.

Operators, Parentheses, and the Order of Calculations

19

When necessary, use parentheses to control the order of calculations. Without parentheses, the Solver does calculations using the same rules as those used by an algebraic calculator. These rules are:

Functions First. For example, when solving for D in the equation $A*\text{SQRT}(B+C)=D$, the Solver calculates $\sqrt{(B+C)}$ and then multiplies the answer by A .

Exponentiation before Multiplication and Division. For example, an equation typed in as $A*B^3=C$ is interpreted as $A \times B^3 = C$. B is raised to the 3rd power and *then* multiplied by A . To raise $A \times B$ to the 3rd power, write the equation: $(A*B)^3=C$.

Multiplication and division before addition and subtraction. For example, an equation typed in as $A+B/C=12$ is interpreted as:

$$A + \frac{B}{C} = 12$$

To divide the sum $A + B$ by C , type the equation: $(A+B)/C=12$.

You cannot use parentheses for “implied” multiplication. For example, an equation printed in a book as $P_{SN} = P_S(1 - F)$ can be typed into the Solver as $P_{SN}=P_S*(1-F)$. The $*$ sign must be inserted between P_S and the parenthesis.

Date Formats

The functions CDATE, DATE, and DDAYS, either return a date or use one or more dates as arguments. The format in which these dates are expressed depends on the date format set in the Setup Utility. The formats shown in the second and third columns give the Calculator date formats shown in the first column.

Date Formats: Calculator vs. Setup Utility

Calculator	Setup Utility	
DD.MMYYYY	(DD- <i>MMM</i> -YY) (<i>MMM</i> -YY) (DD.MM.YY) (DD.MM)	(DD- <i>MMM</i>) (DD/ <i>MM</i> / <i>YY</i>) (DD/ <i>MM</i>)
MM.DDYYYY	(<i>MM</i> / <i>DD</i> / <i>YY</i>)	(<i>MM</i> / <i>DD</i>)
YYYY.MMDD	(<i>YY</i> - <i>MM</i> - <i>DD</i>)	(<i>MM</i> - <i>DD</i>)

Note that you won't see the entire date in the display unless you've set the number format to be All or Fixed Point with 6 digits. To change the format press and fill out the Number Format dialog box.

Solver Functions

The table on the following pages lists the Solver functions. Lowercase characters in parentheses stand for numbers, variable names, or numeric expressions that the functions use to do their calculations.

Solver Functions

Function	Description
ABS(<i>x</i>)	Absolute value.
ACOS(<i>x</i>)	Arc cosine. ¹
ALOG(<i>x</i>)	Common (base 10) antilogarithm; 10^x
ANGLE(<i>x</i> , <i>y</i>) ²	Returns polar coordinate angle Δ given (<i>x</i> , <i>y</i>) rectangular coordinates. ¹
ASIN(<i>x</i>)	Arc sine. ¹
ATAN(<i>x</i>)	Arc tangent. ¹
CALCCELL (<i>input list</i> , <i>output range</i> , <i>row</i> , <i>col</i>) ²	You can specify <i>row</i> , <i>col</i> , just <i>row</i> , or neither. <i>input list</i> is zero or more inputs to the worksheet of the form: [<i>expr</i> , <i>range</i> , <i>row</i> , <i>col</i>]. For each input, the expression is evaluated and stored in the appropriate cell in the worksheet. Then the worksheet is recalculated, and the value of the output cell is returned.
CDATE	Current date. ³
COMB(<i>x</i> , <i>y</i>)	Number of combinations of <i>x</i> items taken <i>y</i> at a time.
COS(<i>x</i>)	Cosine. ¹
CPCOL	Returns the worksheet column number of the current cell pointer.
CPROW	Returns the worksheet row number of the current cell pointer.
CTIME	Current time in HH.MMSS, 24-hour format.
DATE(<i>date</i> , <i>n</i>)	The date <i>n</i> days after (when <i>n</i> is positive) or before (when <i>n</i> is negative) the specified <i>date</i> . ³

1 Uses the current angle mode—degrees, radians, or grads. To change the angle mode, press .

2 Use the current argument separator when keying in formulas.

3 Uses the current date format, DD.MMYYYY, MM.DDYyyy, or YYYYY.MMDD. See the earlier section “Date Formats.”

Solver Functions (continued)

Function	Description
DDAYS(<i>d1</i> , <i>d2</i> , <i>cal</i>)	The number of days between dates <i>d1</i> and <i>d2</i> . ¹ <i>cal</i> designates the calendar: <ul style="list-style-type: none"> ■ <i>cal</i>=1 for the actual calendar, which recognizes leap years. ■ <i>cal</i>=2 for the 365-day calendar, which ignores leap years. ■ <i>cal</i>=3 for the 360-day calendar, which uses 12, 30-day months.
DEG(<i>x</i>)	Converts <i>x</i> in radians to decimal degrees.
EXP(<i>x</i>)	Natural antilogarithm; e^x .
EXPM1(<i>x</i>)	$e^x - 1$.
FACT(<i>x</i>)	Factorial; <i>x</i> is an integer ≥ 0 .
FLOW(<i>filename</i> , <i>row</i>)	The specified cash flow from the specified cash-flow file. (The file name must be entered <i>without</i> a DOS path and file extension. The .CFL extension and the current path from the Cash Flows application are assumed.)
FP(<i>x</i>)	Fractional part.
FV(<i>n</i> , <i>i</i> % <i>yr</i> , <i>pv</i> , <i>pmt</i> , <i>p/yr</i> , <i>m</i>)	TVM function for FV. ²
G(<i>var</i>)	The GET function returns the contents of <i>x</i> .
HMS(<i>x</i>)	Converts <i>x</i> in decimal hours (degrees) to H.MMSS (D.MMSS) format.
HR(<i>x</i>)	Converts <i>x</i> in H.MMSS (D.MMSS) format to decimal format.
IDIV(<i>x</i> , <i>y</i>)	Integer part of the quotient $x \div y$.
IF(<i>con</i> , <i>alg1</i> , <i>alg2</i>)	If conditional expression <i>con</i> is true, use algebraic expression <i>alg1</i> ; otherwise, use <i>alg2</i> . (IF is discussed later in this chapter.)

1 Uses the current date format, DD.MMYYYY, MM.DDYYYY, or YYYY.MMDD. See the earlier section "Date Formats."

2 See the section "The TVM Functions" later in this chapter.

Solver Functions (continued)



Function	Description
INT(x)	The greatest integer less than or equal to x .
INV(x)	Reciprocal, $1/x$.
IP(x)	Integer part.
ITEM(<i>filename</i> , <i>row,col</i>)	Returns the value of the designated statistics data (from a .STA file). If you don't specify a column, it defaults to 1. ¹
I%YR(n,pv,pmt , $fv,p/yr,m$)	TVM function for I%YR. ²
L(<i>var,alg</i>)	The LET function evaluates the algebraic expression <i>alg</i> , stores the result in x , and also returns that result as the value of the L function.
LENGTH(<i>range</i>)	Returns the number of worksheet rows in the given range.
LN(x)	Natural (base e) log of x .
LNPI(x)	$\ln(1+x)$.
LOG(x)	Common (base 10) log of x .
MAX(x,y)	Larger of x and y .
MIN(x,y)	Smaller of x and y .
MOD(x,y)	The remainder of the division $x \div y$; $\text{MOD}(x,y) = x - y \times \text{INT}(x \div y)$.
N($i\%yr,pv,pmt$, $fv,p/yr,m$)	TVM function for N . ²
PERM(x,y)	Permutations of x items taken y at a time.
PI	π ; 3.141592653589793 (16 digits).
PMT($n,i\%yr,pv$, $fv,p/yr,m$)	TVM function for PMT . ²
PV($n,i\%yr,pmt$, $fv,p/yr,m$)	TVM function for PV . ²
RAD(x)	Converts x in decimal degrees to radians.
RADIUS(x,y)	Returns polar coordinate radius R given (x,y) rectangular coordinates.

1 *filename* must be entered *without* a DOS path and extension. The current path and standard extension from the application are assumed.

2 See the section "The TVM Functions" later in this chapter.

Solver Functions (continued)

Function	Description
RAN# or RAND	Pseudo-random number ($0 \leq r < 1$).
RCLCELL (<i>range, row, col</i>)	You can specify <i>row</i> and <i>col</i> , just <i>row</i> , or neither. Returns the value of the designated worksheet cell.
RND(<i>x, y</i>)	<i>x</i> rounded to <i>y</i> decimal places (when $0 \leq y \leq 15$) or to $ y $ significant digits (when $-16 \leq y \leq -1$). When $y=16$, <i>x</i> is rounded to number of decimal places given by current display setting.
S(<i>var</i>)	<i>var</i> is a variable; S(<i>var</i>) is used with the IF function to create a set of function keys from more than one equation. (S is discussed later in this chapter.)
SGN(<i>x</i>)	Sign of <i>x</i> (+1 if $x > 0$, 0 if $x = 0$, -1 if $x < 0$).
SIGMA (<i>cv, c1, c2, s, alg</i>)	Sums values of the algebraic expression (<i>alg</i>) for values of the counter variable (<i>cv</i>). <i>cv</i> starts with value <i>c1</i> and is incremented in steps of <i>s</i> , to a final value of <i>c2</i> . (SIGMA is covered in more detail later in this chapter.)
SIN(<i>x</i>)	Sine. ¹
SIZEC(<i>filename</i>)	Returns the last flow number in the specified cash-flow file. ²
SIZES(<i>filename</i>)	Returns the number of statistics rows in the specified statistics-data file. ²
SPFV(<i>i%, n</i>)	Future value of a single \$1.00 payment; equivalent to $(1 + i\% \div 100)^n$. <i>n</i> is the number of compounding periods, <i>i%</i> is the interest rate per compounding period, expressed as a percentage.
SPPV(<i>i%, n</i>)	Present value of a single \$1.00 payment; equivalent to $1 \div \text{SPFV}(i\%, n)$. <i>n</i> is the number of compounding periods. <i>i%</i> is the interest rate per compounding period, expressed as a percentage.
SQ(<i>x</i>)	x^2
SQRT(<i>x</i>)	\sqrt{x}

1 Uses the current angle mode—degrees, radians, or grads. To change the angle mode, press   .

2 *filename* must be entered *without* a DOS path and extension. The current path and standard extension from the application are assumed.

Solver Functions (continued)

Function	Description
STOCELL(<i>expr</i> , <i>range,row,col</i>)	You can specify <i>row</i> , <i>col</i> , just <i>row</i> , or neither. Evaluates the expression and stores the result in the designated worksheet cell. The worksheet is not recalculated.
#T(<i>filename</i> , <i>flownum,row</i>)	Group size of the specified cash flow in the specified cash-flow file. ¹
TAN(<i>x</i>)	Tangent. ²
TRN(<i>x,y</i>)	<i>x</i> is truncated to <i>y</i> decimal places (when $0 \leq y \leq 15$) or to $ y $ significant digits (when $-16 \leq y \leq -1$). When <i>y</i> equals 16, <i>x</i> is truncated to the number of decimal places given by the current display setting.
USFV(<i>i%,n</i>)	Future value of a uniform series of \$1.00 payments; equivalent to $(SPFV(i\%,n)-1) \div (i\% \div 100)$. <i>n</i> is the number of payments. <i>i%</i> is the periodic interest rate, expressed as a percentage.
USPV(<i>i%,n</i>)	Present value of a uniform series of \$1.00 payments; equivalent to $USFV(i\%,n) \div SPFV(i\%,n)$. <i>n</i> is the number of payments. <i>i%</i> is the periodic interest rate, expressed as a percentage.
WIDTH(<i>range</i>)	Returns the number of worksheet columns in the given range.
XCOORD(<i>R,Δ</i>)	x-coordinate of polar coordinates. (Uses the current angle mode—degrees or radians.)
YCOORD(<i>R,Δ</i>)	y-coordinate of polar coordinates. (Uses the current angle mode—degrees or radians.)

1 *filename* must be entered *without* a DOS path and extension. The current path and standard extension from the application are assumed.

2 Uses the current angle mode—degrees, radians, or grads. To change the angle mode, press .

Typing Aids for Solver Functions

Solver functions may either be typed in or entered with the help of function keys. For example, when you're entering an equation and want to use the function PMT, you can press **Fin** **PMT** to display PMT(,,,,). The commas (argument separators) and parentheses are displayed as well as the three letters. As you type in the arguments to the function, use **▶** to skip over the commas and parentheses. After entering the function, press **ESC** to display the previous set of function keys.

Here are the function keys in the solve editor that give you typing aids.

Solve Editor Function Keys

Key Label	Description
Math	Provides typing aids for RND, IP, FP, ABS, LN, EXP, LOG, ALOG, SQRT, SQ, INV, TRN, LNP1, EXPM1, IDIV, INT, MOD, MIN, MAX, SGN, SIGMA.
Trig	Provides typing aids for PI, SIN, COS, TAN, ASIN, ACOS, ATAN
Conv	Provides typing aids for DEG, RAD, HR, HMS, XCOORD, YCOORD, RADIUS, ANGLE, CTIME, CDATE, DATE, DDAYS.
Prob	Provides typing aids for COMB, PERM, FACT, RAN#.
Fin	Provides typing aids for N, I%YR, PV, PMT, FV, SPFV, SPPV, USFV, USPV.
Other	Provides typing aids for STOCELL, RCLCELL, CALCCELL, LENGTH, WIDTH, CPCOL, CPROW, IF, OR, XOR, AND, NOT, S, L, G.
NUM+	Inserts into the editor the last number or other operand displayed in the calc line. The number is inserted in full precision.

Conditional Expressions (IF Function)

Equations can include conditional expressions using the IF function. For example, the Solver accepts the equation: $BONUS=IF(SALES>3000, .02*SALES, .01*SALES)$. The two commas inside the parentheses stand for “THEN” and “OR ELSE.” According to this equation, if *SALES* is greater than 3000, then *BONUS* equals $.02 \times SALES$; otherwise, *BONUS* equals $.01 \times SALES$.

In general, the form of the IF function is:

$IF(\text{conditional expression}, \text{algebraic expression}, \text{algebraic expression})$

A conditional expression can also be an algebraic expression. If the algebraic expression evaluates to zero, it is interpreted as false. Otherwise, true. For example, if *A* equals -1 in the algebraic expression $A+1$, the expression is false. If *A* equals any other number, the expression is true.

The logical and relational operators that can be used in conditional expressions are described in the table below:

Operators Used in Conditional Expressions

Logical Operators: NOT, AND, OR, XOR

Relational Operators: > Greater than
< Less than
= Equal to
>= Greater than or equal to
<= Less than or equal to
<> Not equal to

Order of Logical Operations

Logical operations are done after arithmetic operations (addition, subtraction, etc.). For example, the expression

$A+1 \text{ OR } B=5$

is true if $A <> -1$ and/or $B=5$. The expression is false only if $A=-1$ and $B <> 5$.

When there are two or more, they are done in the order NOT first, then AND, and finally OR or XOR. Thus, the expression

$$A=360 \text{ AND } B=12 \text{ OR } A=365$$

is true if A equals 360 and B equals 12, or if A equals 365.

Here are several examples of equations using conditional expressions:

Equation: $E=IF(7<A \text{ AND } A\leq 15, 2*A/6, 3*A+10)+C$

Meaning: If A is greater than 7 and less than or equal to 15, then $B=(2\times A\div 6)+C$. Otherwise, $B=(3\times A+10)+C$.

Equation: $VALUE=FIRST+IF(NOT FIRST=0, 1/FIRST, 0)$

Meaning: If $FIRST$ is unequal to 0, then $VALUE=FIRST+(1\div FIRST)$. If $FIRST=0$, then $VALUE=FIRST$.

Equation: $T=W*IF(A=0 \text{ XOR } B=0, A+B, A*B)$

Meaning: $T=W\times(A+B)$ if A or B , but not both, equals 0. Otherwise, $T=W\times A\times B$. In other words,

When $A=0$ and $B\neq 0$, $T=W\times B$

When $A\neq 0$ and $B=0$, $T=W\times A$

When $A=0$ and $B=0$, $T=0$

When $A\neq 0$ and $B\neq 0$, $T=W\times A\times B$.

Creating Function Keys for Multiple Equations (S Function)

The S (solving for) function is used with the IF function to group equations and to specify the conditions where one or the other is used. For example, consider these equations for calculating gross pay:

Wage pay based on an hourly wage:

$$WPAY=WAGE*HRS$$

where:

$WPAY$ = gross wage pay.

$WAGE$ = hourly wage.

HRS = hours worked.

Salary pay based on a fixed salary plus a 5% sales commission:

$$SLPAY=SALRY+.05*SALES$$

where:

$SLPAY$ = gross salary pay.

$SALRY$ = the fixed salary.

$SALES$ = sales.

To use the S function, the equations must first be rearranged to place 0 on one side of each equation:

$WPAY - WAGE * HRS = 0$
 $SLPAY - SALRY - .05 * SALES = 0$

To create one set of function keys that can be used for either equation:

$IF(S(WPAY), WPAY - WAGE * HRS, SLPAY - SALRY - .05 * SALES) = 0$

IF(S(WPAY) tests the condition: Solving for *WPAY*?

If the condition is true, the expression $WPAY - WAGE * HRS$ is used.

If the condition is false, the expression $SLPAY - SALRY - .05 * SALES$ is used.

The =0 ending is optional. If it's omitted, =0 is implied.

The S function appears within the IF function in the conditional expression. In this case, the conditional expression is true if you solve for *WPAY*, and false if you solve for anything else. The algebraic expressions in the IF function are the two equations, rewritten to gather all the terms on one side of the equation, so that each expression is equal to 0.

19

The IF function can be set equal to an expression common to both equations. For example, the equations $X + Y + (10/A) = Z$ and $Q + R + (10/A) = T$ can be combined to $IF(S(X) OR S(Y) OR S(Z), X + Y - Z, Q + R - T) = -10/A$. Note that the Solver uses the second equation when solving for *Q*, *R*, *T*, or *A*.

The TVM Functions

The five Solver TVM functions allow you to write equations that do calculations analogous to the calculations done in the TVM Calculator application:

$N (i\%yr, pv, pmt, fv, p/yr, m)$
 $I\%YR (n, pv, pmt, fv, p/yr, m)$
 $PV (n, i\%yr, pmt, fv, p/yr, m)$
 $PMT (n, i\%yr, pv, fv, p/yr, m)$
 $FV (n, i\%yr, pv, pmt, p/yr, m)$

Each function calculates one TVM value, given the values for all the others. For example, the first function calculates *N* (the total number

of payments or compounding periods), given the annual percentage interest rate, present value, payment amount, future value, number of payments per year, and the Begin/End mode.

The parameters of the functions (the contents of the parentheses) are defined identically (with one exception) to the TVM application's variables. The exception is that m stands for the Begin/End mode (B/E). Use $m=1$ for Begin mode, $m=0$ for End mode.

You can give the parameters any legal variable name; for example you can use *LOAN* in place of pv . Parameters can also be algebraic expressions. For example, the following equation calculates the monthly payment for a car loan:

`CARPMT=FMT(MONTHS,I%YR,PRICE-DOWN,0,12,0)`

MONTHS is the number of monthly periods (n).

DOWN is the down payment.

PRICE is the purchase price.

PRICE-DOWN is the present value (pv).

The first 0 is the final value (fv).

12 is the payments/year (p/yr).

The final 0 specifies End mode.

Notice that `FMT` is *not* a variable in the equation—it is the name of the function.

The Solver TVM variables are not shared with the variables in the Calculator's TVM application. For example, the variable *I%YR* in the *CARPMT* equation is separate from the TVM variable *I%YR*.

The Summing Function (SIGMA)

The SIGMA function provides the ability to do a variety of summing operations. The function has the form:

`SIGMA(counter variable , starting value , ending value , step size , algebraic expression)`

The **counter variable** takes on a series of values, beginning with the **starting value**, and incrementing according to the **step size**, until it passes the **ending value**. For each value of the counter, the **algebraic expression** is evaluated, and the value is added to the previous value.

The function returns the final summation. The counter variable is not represented by a function key.

The following equation contains a counter I and two other variables, X and $THESUM$:

```
THESUM=SIGMA(I, 1, 6, 1, I*X)
```

The counter I runs from 1 through 6 in steps of 1—that is, 1, 2, 3, 4, 5, 6. For each value of I , $I \times X$ is calculated and added to the sum. If you store 3 in X and then solve for $THESUM$, the Solver calculates $THESUM = 63$; that is, $3 + 6 + 9 + 12 + 15 + 18$.

Examples of Solver Equations

19 Simple Annual Interest

The following equation calculates the amount due for a loan with simple annual interest, given the duration of the loan. Both the principal and interest are paid in a lump sum at the end of the loan period. This $LOAN, DAYS$ equation assumes a 365-day calendar basis.

```
DEBT = LOAN + LOAN * I% / 100 * DAYS / 365
```

where

$DEBT$ = the total owed at the end of the loan period.

$LOAN$ = the original amount (principal) lent.

$I\%$ = the annual interest rate as a percent.

$DAYS$ = the number of days of the loan.

If you know the dates for the course of the loan, rather than the number of days, use this $LOAN, DATES$ equation:

```
DEBT = LOAN + LOAN * I% / 100 *  
DDAYS( DATE1, DATE2, IF( BASIS=365, 1, 3 ) ) / BASIS
```

where

$DATE1$ = the date the loan commences.

$DATE2$ = the date the loan ends.

$BASIS = 360$ for a 360-day basis.

$BASIS = 365$ for a 365-day basis.

Example: Simple Interest for a Specified Number of Days. You lend a friend \$450 for 60 days, charging 7% simple annual interest (calculated on a 365-day basis). What is the total amount he will owe you in 60 days?

Starting from the solve calc screen for the LOAN,DAYS equation,

Keys:	Description:
450 LOAN	Stores loan amount.
7 I%	Stores interest rate.
60 DAYS	Stores term of loan.
DEBT	Calculates \$455.18 due in 60 days.

Example: Simple Interest From the Dates of the Loan. On March 26, 1992, you borrow \$1,200 from a relative. You promise to repay the loan, with 8% simple interest (to be calculated on a 365-day basis), on June 12, 1993. How much will you owe?

Starting from the solve calc screen for the LOAN,DATES equation,

Keys:	Description:
1200 LOAN	Stores loan amount.
8 I%	Stores interest rate.
3.261992 DATE1	Stores date of loan (assumes current date format is MM.DDYYYY).
6.121993 DATE2	Stores repayment date.
365 BASIS	Stores calendar basis.
DEBT	Calculates \$1,316.52 to be repaid.

Advance Payments (Leasing)

Occasionally payments are made in advance, such as in leasing. Leasing agreements sometimes call for the extra payments to be made when the transaction is closed. A residual value (salvage value) can also exist at the end of the normal term.

The following equation named ADV calculates the monthly payment and the annual yield when one or more payments are made in

advance. It can be modified to accommodate periods other than monthly by changing the number 12 to the appropriate number of payment periods per year.

$$PMT = (-PV - FV * (SPPV(I\%YR/12, N))) / (USPV(I\%YR/12, N - \#ADV) + \#ADV)$$

where

- PMT* = the monthly payment amount.
- PV* = the value of the equipment.
- FV* = the residual value.
- I%YR* = the annual interest rate as a percent.
- N* = the total number of payments.
- #ADV* = the number of advance payments.

Example: Leasing With Advance Payments. Equipment worth \$750 is leased to you for 12 months. The equipment is assumed to have no salvage value at the end of the lease. You agree to make three payments at the time of closing. What is the monthly payment if the annual interest rate is 10%?

19

Starting from the solve calc screen for this example's equation,

Keys:	Description:
750 PV	
12 N	
0 FV	
3 #ADV	
10 I%YR	Stores known values.
PMT	Calculates a \$64.45 monthly payment.

Discounted Notes

A note is a written agreement to pay the buyer of the note a sum of money plus interest. Notes do not have periodic coupons, since all interest is paid at maturity. A discounted note is a note that is purchased below its face value. In the following two equations, the calendar basis is actual/360. To find the price given the discount rate, use the following NOTE,PRICE equation:

$$PRICE = RV - (DISC * RV * DDAYS(SETT, MAT, 1) / 360000)$$

To find the yield given the price (or to find the price given the yield), use the NOTE, YIELD equation:

$$YIELD = (RV - PRICE) / PRICE * 360000 / DDAYS(SETT, MAT, 1)$$

where

PRICE = the purchase price per \$100 face value.

YIELD = the yield as an annual percentage.

RV = the redemption value per \$100.

DISC = the discount rate as a percent.

SETT = the settlement date (in current date format).

MAT = the maturity date (in current date format).

Example: Price and Yield of a Discounted Note. What are the price and yield of the following U.S. Treasury Bill: settlement date July 16, 1991; maturity date December 17, 1991; discount rate 8.7%? (Assume MM.DDYYYY format.)

Starting from the solve calc screen for the NOTE, PRICE equation,

Keys:	Description:
7.161991 SETT	
12.171991 MAT	
8.7 DISC	
100 RV	Stores known values.
PRICE	Calculates a price of \$96.28.

Starting from the solve calc screen for the NOTE, YIELD equation,

YIELD	Calculates a 9.04% yield.
-------	---------------------------

Moving Average

Moving averages are often used to predict trends in data over time. In moving average calculations, a specified number of values are averaged. Each time a new value is acquired, the oldest is discarded.

The following Solver equation named MOVAVG calculates the moving average of data stored in a 1-2-3 worksheet.

MAVG=SIGMA(I,MAX(1, LAST-N+1), LAST, 1, RCLCELL
 (name, I))/MIN(LAST, N)

where

N = the number of values averaged in each calculation.

LAST = the entry number of the most recent value to be averaged.

name = the range name of the first data cell.

Example: Moving Average. Calculate a three-month moving average for the number of units manufactured during the first half of the year. Manufacturing volumes were:

January	February	March	April	May	June
4400	5360	2900	3670	4040	3200

If you want to preserve the current worksheet, save it to a file before you erase it.

19

Keys:

Description:

Starts 1-2-3.

Erases the worksheet and moves to cell A1.

RNCVOL

Creates the range name VOL for cell A1.

Names first cell of data range.

4400

5360

2900

3670

4040

3200

Enters data.

Displays Solve Catalog and highlights bottom of equation list. If the Solve Catalog screen is not displayed, press one or more times.

Now type the MOVAVG equation, substituting WOL for *name*, and press **Calc** (**F9**) to display the solve calc screen. Then,

Keys:	Description:
3 W	Stores number of points.
3 LAST	Stores entry number of last entry to be averaged.
MAVG	Calculates an average of 4,220.00 for months 1, 2, and 3.
4 LAST	“Moves” <i>LAST</i> down one entry.
MAVG	Calculates an average of 3,976.67 for months 2, 3, and 4.
5 LAST	“Moves” <i>LAST</i> down one entry.
MAVG	Calculates an average of 3,536.67 for months 3, 4, and 5.
6 LAST	Calculates an average of 3,636.67 for months 4, 5, and 6.
MAVG	

Simulating a Toss of Dice

The Solver random number function **RAN#** can simulate the toss of one or more six-sided dice. The equation

$$\text{TOSS}=\text{IP}(\text{RAN}\#*6+1)$$

generates integers in the range 1 through 6. Similarly,

$$\text{TOSS}=\text{IP}(\text{RAN}\#*6+1)+\text{IP}(\text{RAN}\#*6+1)$$

simulates the toss of two dice and gives the sum of both.

1. Type the equation for the appropriate number of dice and press **Calc** (**F9**).
2. Press **TOSS** as many times as desired to see the results of the tosses.

Distance between Two Locations

The following Solver equation calculates the approximate statute miles between two places, given their longitudes and latitudes. The longitudes and latitudes are entered in degrees-minutes-seconds format (D.MMSS); South Latitude and East Longitude are negative numbers. The Calculator must be in Degrees mode.

```
DISTANCE=69.0466*ACOS(SIN(HR(LT1))
*SIN(HR(LT2))+COS(HR(LT1))*
COS(HR(LT2))*COS(HR(LG1)-HR(LG2)))
```

where

$LG1, LT1$ = the longitude and latitude of the first place.

$LG2, LT2$ = the longitude and latitude of the second place.

19 Example: Calculating the Distance Between Two Places. Find the statute miles between Philadelphia, Pennsylvania ($40^{\circ}35'N$, $75^{\circ}10'W$) and Corvallis, Oregon ($44^{\circ}35'N$, $123^{\circ}16'W$).

If the RAD or GRAD annunciator is displayed, press and select Degrees angle mode.

Starting from the solve calc screen for this example's equation,

Keys:	Description:
40.35 LT1	
75.10 LG1	Stores latitude and longitude for Philadelphia.
44.35 LT2	
123.16 LG2	Stores latitude and longitude for Corvallis.
DISTAN	Calculates the distance to be 2,425.31 statute miles.

Finding Several Solutions to an Equation

Example: Solving A Cubic Equation. The equation $x^3 - 5x^2 = 10x - z$ can have more than one solution for x . The Solver can find each solution or root using function plotting. The procedure below shows one way to do this.

You'll plot this equation for a particular value of z .



1. Select **2ND** **A** **S** to display the Solve Catalog. If necessary, press **ESC** one or more times.
2. Type $x^3-5*x^2=10*x-z$ into the solve editor and press **F10**.
3. Press **Cursor Left** (**F9**) to enter the expression into the equation list and display function key labels for x and z .
4. Type 20 and press **z** (**F3**) to assign the value 20 to z .
5. Press **ESC** to display the Solve Catalog.
6. Press **Plot** (**F10**) to display the function plotting screen.
7. Press **2ND** **C** **D** to set the function-plotting conditions to initial values.
8. Press **Auto** (**F3**) to auto-plot the equation. YMIN and YMAX will be chosen to ensure that the curve is shown on the screen.

Function plotting accepts both equations and expressions, but it converts equations into expressions before plotting by subtracting the right side of the equation from the left side. So the graph you see is actually a plot of $x^3 - 5x^2 - 10x + 20$ against values of x .

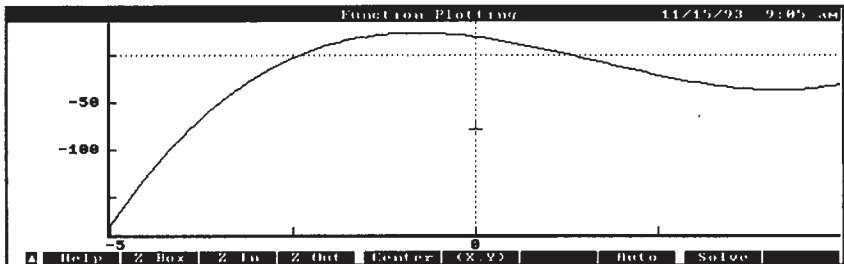
Your screen should look like this:



9. Press **Z-Out** (**F4**) to zoom out five times and to show the curve crossing the x-axis three times (to show the three x-values where the expression equals zero).

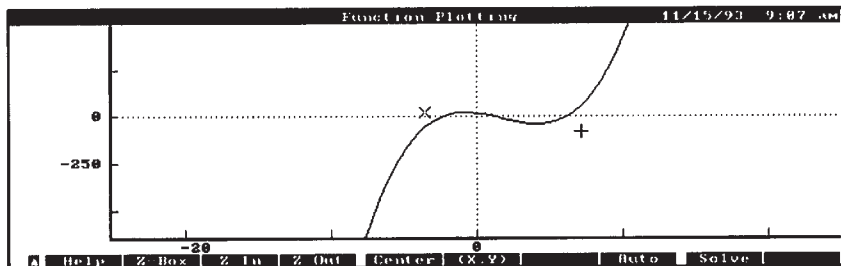

10. Start the definition of a zoom box by moving the cursor to the upper-left corner of an imaginary box that includes all three x-axis crossings (all three roots). To move the cursor by jumps, press an arrow key. To move the cursor by individual dots (pixels) on the screen, press and hold  while pressing an arrow key.
11. Press Z-Box () to fix this upper-left corner.
12. Move the cursor to locate the lower-right corner of the zoom box. Your screen should look something like this:

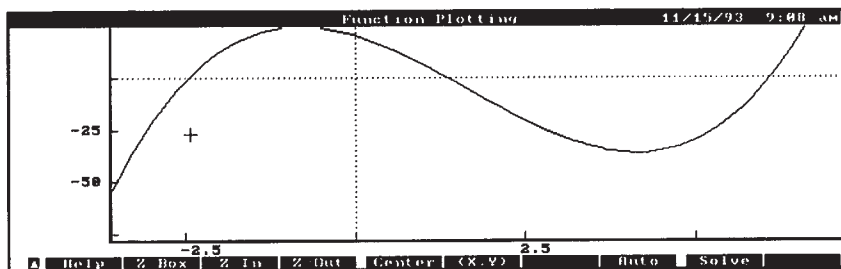

19

13. Press Z-Box again to enlarge the boxed area to full-screen size.
14. Move the cursor near the left root. Your screen should look something like this:



15. Press . You'll see the root: $x = -2.44$
16. Find the other two roots in a similar way—move the cursor near each root and press . You'll see each of these roots displayed in turn:

$$x = 1.34$$

$$x = 6.10$$

17. Press **[ESC]** **[ESC]** to return to the Solve Catalog.

Creating Solver Files on a PC or Another Editor

An equation list may be created using an editor outside of the Solve application. Each name/equation line entry is bounded by curly brackets. The vertical line (press **[↑]** **[\]**) is used to separate the name from the equation. If the line entry consists of a name only, the vertical line follows the name. If the line entry consists of an equation only, no vertical line is used.

Consider the following to be the contents of a word processor or editor file. This file defines four lines of an equation list.

```
(Graph#1|x^3-5*x^2-10*x+z)
(Note Price|)
(y=sin(x))
(Graph#2|x^4-60*x^3-595*x^2-1770*x-1656)
```

When this file is retrieved or inserted into the equation list, the four added lines will look like this:

```
Graph#1      x^3-5*x^2-10*x+z
Note Price
              y=sin(x)
Graph#2      x^4-60*x^3-595*x^2-1770*x-1656
```

Function Plotting

The Solver's function plotting lets you draw a graph and determine roots of an equation or mathematical expression. You can autoscale the graph so the curve is sure to appear in the display. You can also zoom in and zoom out to see more detailed or wider views of the graph, and you can display the coordinates of any point on the graph. The general procedures below are followed by an example that demonstrates the power and flexibility of Calculator function plotting.

To draw a graph:

1. Highlight an equation in the Solve Catalog.
2. Press **Plot** (**F10**).
3. Press **INIT** **C** **D** to set the plot conditions to their initial values. (Or, if you know the range of interest, enter values for XMIN and XMAX—use **XMIN** (**F5**) and **XMAX** (**F6**).)
4. Press **F3** (Auto) to draw the graph.

When you first use function plotting, the graph boundaries and the resolution have these values:

XMIN = -5.00
XMAX = 5.00
YMIN = -3.00
YMAX = 3.00
RES = 112.00

Step 3 above resets the plot conditions to these initial values. Another approach to steps 3 and 4 is to set XMIN, XMAX, YMIN, and YMAX yourself and press **Draw** (**F4**).

To zoom in (to view a smaller region of the graph in more detail):

1. Do one of the following:
 - Press **↑** **Z-IN** (**F3**) or **Z-IN** one or more times. Each press of **↑** **Z-IN** zooms in by a factor of 5 and autoscales the y-axis. Each press of **Z-IN** zooms in on both axes by a factor of 5.
 - Press **X** **Z-IN** to zoom in just the x-axis, or press **Y** **Z-IN** to zoom in just the y-axis.
 - Use an x, y zoom box.

- a. Use the arrow keys to move the cursor to one corner of the area you wish to expand.
 - b. Press **Z-Box** (**F2**).
 - c. Move the cursor to the diagonally opposite corner.
 - d. Press **Z-Box** again to enlarge the defined area to fill the entire screen.
- Use an x, autoscale-y zoom box.
 - a. Move the cursor horizontally to an x-value that defines one end of the x-range you want to expand.
 - b. Press **Z-Box** (**F2**).
 - c. Move the cursor horizontally to an x-value that defines the other end of the x-range you want to expand.
 - d. Press **↕ Z-Box** to enlarge the defined x-range to fill the entire screen and autoscale the y-axis.

To zoom out (to view a larger region of the graph in less detail):

- Use **↕ Z-Out** (**F4**) or **Z-Out** to zoom out just like you use **Z-IN** to zoom in.

19

To display the coordinates of any point on the screen:

1. Press **(X, Y)** one or more times until **Coord** is displayed in the upper left corner of the display (coordinate mode is active).
2. Use the arrow keys or shifted arrow keys (hold down **↕** and press the arrow keys repeatedly) to select the point you want. Then read on the screen the coordinates of that point.

To display a function's value for any point on the curve:

1. Press **(X, Y)** one or more times until **Trace** is displayed in the upper left corner of the display (trace mode is active).
2. Use the arrow keys or shifted arrow keys (hold down **↕** and press **▶** or **◀** repeatedly) to display the x-value you want. Then read on the screen the corresponding function value.

To digitize a point's coordinates (to display the coordinates with full accuracy):

1. Move the cursor to the desired x-value, y-value, or point.
2. Do one of the following (the display will not change):
 - Press **X** **ENTER** to digitize the x-value.
 - Press **Y** **ENTER** to digitize the y-value.

- Press both \boxed{X} $\boxed{\text{ENTER}}$ and \boxed{Y} $\boxed{\text{ENTER}}$, in turn, to digitize a point.
3. The coordinate or coordinates will be entered into the calculator's history stack. If you enter the x-coordinate first, the x-value will be in level 1 and the y-value in the calc line. To view these values, use $\boxed{x\>y}$ or press $\boxed{\text{INFO}}$ \boxed{A} \boxed{M} to start the Math application.

To solve for the roots of a function graphically:

1. Do one of the following:
 - Move the cursor to an XVAR value close to a root (where the curve crosses the x-axis). This locates an initial guess for the root. Often, zooming out helps to find all roots.
 - (Optional for cases where the root is not as easily found.) Press $\boxed{Z\text{-Box}}$ to mark (x) the first guess, then move the cursor to another XVAR value to define a second guess. These two guesses should be on either side of the expected location of the root.
2. Press $\boxed{\text{spacebar}}$ to display the value of the root. If a "questionable solution" is found (a gap, pole, etc.), a message is displayed to that effect followed by the "root" on the top line.
3. Repeat the last two steps to solve for any additional roots.

To find the coordinates of an extremum (maximum or minimum):

An extremum is a point on a graph where the sign of the curve's first derivative changes (where a graph shows a local maximum or minimum). This procedure shows you how to zoom in repeatedly on the area containing the extremum until your measurement of its coordinates achieves the desired accuracy.

1. If the extremum is not already visible, zoom out (press $\boxed{Z\text{-Out}}$) until it's visible on the graph.
2. Press $\boxed{\langle X, Y \rangle}$ one or more times to select trace mode.
3. Move the cursor to the point of the extremum to display its coordinates.
4. Define a tight "x, autoscale y zoom box" around the extremum by moving the cursor just to the left of the extremum and pressing $\boxed{Z\text{-Box}}$, and then moving cursor horizontally just to the right of the extremum and pressing $\boxed{\uparrow}$ $\boxed{Z\text{-Box}}$. The smaller the x-range containing the extremum, the greater zoom you'll create.
5. Move the cursor to the point of the extremum.
 - If these coordinates show the accuracy you want, you can move the coordinates of the extremum to the Calculator stack

by pressing **X** **ENTER** **Y** **ENTER**—see the earlier procedure “To digitize a point’s coordinates (to display the coordinates with full accuracy):”.

- If you want more accurate coordinates, zoom in again (repeat steps 5 and 6) until they are accurate enough.

If the number of places used to display the coordinates prevents you from seeing the accuracy you want, you can usually show between 6 and 8 decimal places for each coordinate, depending on the sign of the mantissa and exponent. Press **MODE** **O** **N** and set the Number Format to Scientific and the Number of Digits to 6, 7, or 8, and then redraw.

Example: Finding the Roots of an Equation. This example shows how to find graphically the two roots of the equation $x^2 + 10x = 75$.

Keys:

2ND **MODE** **A**

S

▶ **FN** **▶**

x **^** 2 **+** 10

x **=** 75

F10

Description:

Displays the Solve Catalog screen. If it’s not displayed, press **ESC** one or more times.

Ensures the highlight is at the end of the equation field.

(The **^** key is **2ND** **^**.)

Enters the equation.

Enters and highlights the equation in the Solve Catalog.

F10

Displays the function plotting screen.

2nd **C** **D**

Initializes the function plotting data. The plot-variable is x.

F3

Plots the equation as the expression $x^2 + 10x - 75$. Note that the equation is converted to an expression by subtracting the right side from the left.

The minimum and maximum x-values (the left and right boundaries) are those specified by XMIN and XMAX in the function plotting screen. The minimum and maximum y-values (the bottom and top boundaries) are chosen by the Auto function to ensure that the curve is displayed on the screen.

ESC

Returns to the function plotting screen. This screen shows that Auto set these values: YMIN = -105 and YMAX = 5.

Draw **(F4)**

Redraws the graph.

19

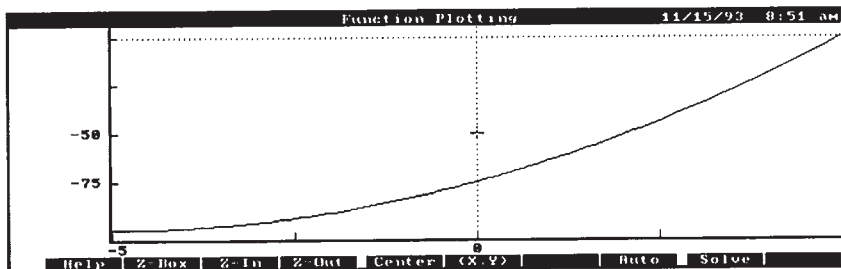

 F4

Zooms out and autoscales the y-axis in one operation. The range covered by the x-axis is increased by 5 times, and the y-axis range is automatically chosen (autoscaled) to ensure that the curve appears on the screen. Both roots are now shown (where the curve crosses the x-axis).

 (8 times)

Moves the cursor to an x-value near the left root. The cursor position now locates an initial guess for this root. (The initial guess is determined only by the x-value of the cursor's position, so there's no need to move the cursor to a y-value close to zero.)

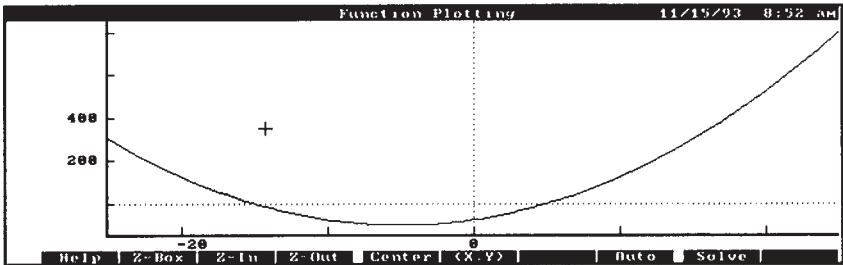

 spacebar

Solves for the left root and displays its value, -15 .

 (11 times)

Moves the cursor to locate an initial guess for the right root.

 spacebar

Solves for the right root and displays its value, 5 .

How Function Plotting Works

When a function is plotted, evenly spaced values of the plot variable are connected by straight lines. The number of these plotted points is determined by RES (resolution), the plot boundaries are given by XMIN, XMAX, YMIN, and YMAX, and the plot variable is given by XVAR. These values are shown in the screen that displays plot conditions.

A RES value of 10 means that the XVAR values between XMIN and XMAX are divided into 10 equal parts. If XMIN is -50 and XMAX is +50, the function would be plotted for x-values of -50, -40, -30, . . . +40, and +50, and each of these plotted points would be connected by straight lines to produce the graph.

Selecting the Expression to Plot

19

Every graph is a plot of a function versus an independent variable (the XVAR value). You select a function or an equation to plot (the current equation) from the Solver's equation list. If you plot an equation of the form $y = f(x)$, the function $f(x)$ is plotted. If you plot an equation of the form expression = expression (such as $x^3 + 10x = 5x^2 + 75$), the Calculator automatically changes it into a single expression (no equal sign) by *subtracting the right side of the equation from the left side* ($x^3 + 10x - 5x^2 - 75$). The value of this expression is then plotted against XVAR.

This table shows examples of how equations would be converted to expressions by function plotting, and what choices you would have for the independent variable, XVAR.

Expression or Equation in Equation List	What's Plotted as y-value	XVAR Choices
$y = \sin(x)$	$\sin(x)$	y^1 , x
$\sin(x)$	$\sin(x)$	x
$(PPSY*L*W)/9 = \text{COST}$ (from previous example)	$(PPSY*L*W)/9 - \text{COST}$	PPSY, L, W, COST
$(PPSY*L*W)/9$	$(PPSY*L*W)/9$	PPSY, L, W

1 If y is selected as XVAR, the plot is $y = \sin(x)$, which is a straight line since $\sin(x)$ is a constant.

Setting the Plot Conditions

Function plotting uses two screens, one that shows plot conditions and one that shows the graph. You set the plot conditions first when you press **Plot** (**F10**) from the Solve Catalog. The function keys provided are described in the following table.























Function Keys Active in the Function Plotting and Plot Conditions Screen

Key Label	Description
Auto	Sets the upper and lower boundaries of the graph (YMAX and YMIN) to ensure that the curve will appear in the display, then draws the graph of the current equation. Using Auto (F3) is generally the easiest way to begin plotting an equation.
Draw	Draws the graph of the current equation using the values of the variables described below in this table.
XMIN	Defines the left boundary of the graph; the minimum x-axis value or XMIN. To change this value, type the value and press XMIN (F5).
XMAX	Defines the right boundary of the graph; the maximum x-axis value or XMAX. To change this value, type the value and press XMAX (F6).
YMIN	Defines the lower boundary of the graph; the minimum y-axis value or YMIN. To change this value, type the value and press YMIN (F7).
YMAX	Defines the upper boundary of the graph; the maximum y-axis value or YMAX. To change this value, type the value and press YMAX (F8).
XVAR	Specifies the independent variable. Pressing XVAR cycles through the equation's variables, specifying each in turn as the independent variable.
RES	Determines the resolution; the number of XVAR values for which the function is plotted. Larger values of RES provides greater accuracy but the graph is drawn more slowly. To change this value, type the value and press RES (F10). (RES is ignored when plotting statistics data with a linear model.)







Interacting with the Graph

Once the graph is drawn, you can use specially defined keys to zoom in, zoom out, define a part of the graph to enlarge, find the function's roots, and perform other operations. These special keys and their actions are described in the following table.

Keys Active in the Function Plotting and Interactive Graphics Screen

Keys	Description
 ,   , 	Moves graphics cursor around the graph by jumps.
 ,   ,   ,   , 	Moves the graphics cursor around the graph by individual dots (pixels).
 +   +   +   + 	Pans the graph in the direction of the arrow.
Z-In	Zooms in by a factor of 5.
Z-Out	Zooms out by a factor of 5.
 Z-In	Zooms in by a factor of 5 and autoscales the y-axis.
 Z-Out	Zooms out by a factor of 5 and autoscales the y-axis.
Center	Centers the graph at the graphics cursor position.
 Center	Centers the graph at the graphics cursor position and autoscales the y-axis.

Keys Active in the Function Plotting and Interactive Graphics Screen (continued)



Keys	Description
Z-Box	<p>Press once to set a mark (x) that remains when the cursor is moved. (This mark defines one corner of a zoom box or the first of two guesses for a root.) Move the cursor and press it again to enlarge to full screen the portion of the graph defined by the cursor position and the mark. If, after setting the mark and moving the cursor, you press  Z-Box, it enlarges to full screen the x-axis portion of the graph defined by the cursor position and the mark and then autoscales the y-axis.</p>
Solve or 	<p>Solves for a root using either one or two guesses chosen as follows:</p> <ul style="list-style-type: none"> ■ the first guess is provided by the XVAR value of the cursor's position when  is pressed. ■ For two guesses the first is provided by the XVAR value of a mark (x), produced at the cursor's position when Z-Box is pressed. The second guess is provided by the XVAR value of the cursor's position when  is pressed.
(X, Y)	<p>When pressed repeatedly, rotates through three graph display modes:</p> <ul style="list-style-type: none"> ■ Standard mode, showing labeled axes only. ■ Coordinate mode, where the coordinates of the cursor position are displayed as the cursor moves throughout the interactive graphics screen. ■ Trace mode, where the cursor traces the function as you press  and , and the value of the function is displayed for each cursor position (for each XVAR-value).

Keys Active in the Function Plotting and Interactive Graphics Screen (continued)



Keys	Description
ESC	Exits the graph and displays the Function Plotting screen.
X ENTER or ENTER	Enters the x-value of the cursor's position into the calc line. To exit the graph and view the calc line, press ESC .
Y ENTER	Enters the y-value of the cursor's position into the calc line. To exit the graph and view the calc line, press ESC .
X ENTER Y ENTER	Enters both the x-value and the y-value of the cursor's position into the history stack. If you enter the x-coordinate first, the x-value will be in level 1 and the y-value in the calc line. To view these values, use x\leftrightarrowy or start the Math application to see the history stack.

Configuring and Customizing the Calculator

Configuration Options

To see the Calculator Options menu, press   .

To change the Number Format:



When you press   , you see four choices for how numbers are displayed in the calc line.

Format	Description
Fixed Point	Sets the displayed number of digits to the right of the decimal point to a fixed number. (That number is set by the Number of Digits option.)
Scientific	Displays numbers in scientific notation. For example, 13,246.5798 is displayed as 1.325e4.
Engineering	Displays numbers in engineering notation. For example, 13,246.5789 is displayed as 13.25e3.
All	Displays numbers to their full precision.

The Number of Digits field lets you specify the number of digits to be displayed to the right of the decimal point for Fixed Point format.

Regardless of the way numbers are displayed, the Calculator stores most numbers to their full precision.

To change the Calculator Modes:





When you press   , you see the choices for affecting Calculator modes of operation.

Angle Mode	Angles interpreted as Degrees, Radians, or Grads.
Operation Mode	Gives you two choices for the syntax for entering calculations: RPN or conventional Algebraic.

Show Stack If you select this check box, the current stack is always displayed in Arithmetic, Custom, and Math.

Show Registers If you select this check box, the storage registers are always displayed in Arithmetic and Custom.

To change the Startup Application:





1. Within the Calculator press   .
2. Use  to select your new Startup application.
3. Press .

When you quit and then restart the Calculator, you see the “Startup” application. Also, when no menu is displayed and you press , you return to your Startup application.

20 Creating Your Custom Calculator Application

You can create a “Custom” Calculator application by assigning functions or applications to a set of function keys.







To create your Custom application:

1. Within the Calculator press   .
2. Tab to the function key you want to define.
3. Use  to select the function you want to assign to that function key. (Shortcut: Try typing the first letter of the function you want; repeat that letter until your function is displayed.)
4. Repeat steps 2 and 3 for other function keys.
5. Press  to save and start your Custom application.

To start your Custom application from another application:

- Press    .

To make Custom your Startup Application:

1. Press    .
2. Use  to highlight Custom (it’s near the bottom of the list) and press .

Part 5

System Management



The Setup Utility

The Setup utility establishes these settings for your palmtop PC:

- Battery type and recharging (see appendix B for information).
- Printer configuration (see chapter 28 for information).
- Date, time, and their formats.
- Volume and screen contrast.
- Memory allocation.
- International Default Settings (currency symbols, etc.).
- Character sorting order (for applications other than 1-2-3).
- 1-2-3 sorting order (collating sequence).
- Topcard display (or other customized image).

To start Setup press **[F2]** **[S]** (or **CTRL+[F2]**).

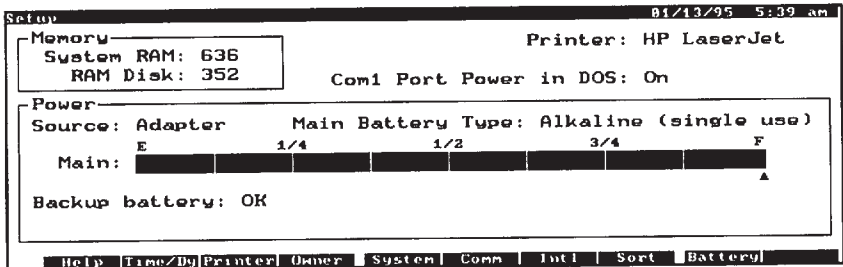

This display shows

- The current division of RAM between system RAM and RAM disk.
- The battery status.
- The current printer type.
- The status of Com1-port power when DOS is open.

Setting the Date and Time

The current date and time setting establishes the current date and time throughout the palmtop. The format settings, however, do not affect 1-2-3 except in the printing of headers and footers. (1-2-3 has its own commands for format settings.)

To set the current date:

1. In Setup, press **[F10]** **[O]** **[D]**.
2. Tab to the **Current Date** and edit the highlighted date using the same format to show the new date (you can drop leading zeros).
3. Press **[F10]**.

The date **delimiters** (punctuation between numerals) can be any one of these: hyphen, slash, space, colon, period, or comma. The current date can be in any year from 1980 through 2099. You can specify years 1980 through 2079 by their last two digits—for example, 1993 can be entered as 93. To specify years 2080 through 2099, you must enter all four digits.

To set the date format:

1. In Setup, press **[F10]** **[O]** **[D]**.
2. Tab to the **Date Format** list box.
3. Arrow to your format choice (see the table below). Not all choices are displayed at the same time. Arrow to scroll the complete list.
4. Press **[F10]**.

The following table shows the available format options, each including an example date of August 14, 1994.

Date Formats

Format	Example	Format	Example
DD-MMM-YY	14-AUG-94	YY-MM-DD	94-08-14
DD-MMM	14-AUG	MM/DD	08/14
MMM-YY	AUG-94	DD/MM	14/08
MM/DD/YY	08/14/94	DD.MM	14.08
DD/MM/YY	14/08/94	MM-DD	8-14
DD.MM.YY	14.08.94		

To set the current time:

1. In Setup, press **ENTR** **O** **D**.
2. Tab to the **CURRENT TIME** and edit the highlighted time using the same format to show the new time (you can drop leading zeros).
3. Press **F10**.

The time **delimiters** (punctuation between numerals) can be any one of these: hyphen, slash, space, colon, period, comma, or h m s.

To set the time format:

1. In Setup, press **ENTR** **O** **D**.
2. Tab to the **TIME FORMAT** list box.
3. Arrow to your format choice (see the table below). Not all choices are displayed at the same time. Arrow to scroll the complete list.
4. Press **F10**.

The following table shows the available format options, each including an example time of 2:03:07 pm.

Time Formats

Format	Example	Format	Example
HH:MM:SS (AM/PM)	02:03:07 pm	HH,MM,SS	14,03,07
HH:MM (AM/PM)	02:03 pm	HHhMMmSSs	14h03m07s
HH:MM:SS	14:03:07	HH:MM	14:03
HH.MM.SS	14.03.07	HH.MM	14.03
		HH,MM	14,03
		HHhMMm	14h03m

Specifying Audio Volume and Display Intensity

To adjust the audio volume:

1. In Setup, press **ENTR** **O** **S**.
2. Tab to **VOLUME**.
3. Press **▶** to increase or **◀** to decrease volume. As you change volume, a beep sounds to demonstrate that volume.
4. Press **F10**.

To adjust the display contrast from any application:

- To darken: Press **ON**+**+**
- To lighten: Press **ON**+**-**.
- To invert light and dark: Press **ON**+**∇**.

Allocating Memory between System RAM and the RAM Disk for 200LX 1MB and 2MB

The Setup utility enables you to change the allocation of built-in RAM (memory) between the System RAM and the RAM disk.

- **System RAM** is workspace memory used by applications, the Clipboard, and DOS.
- The **RAM disk** (drive C) is used by your palmtop to save files just as a hard disk is used in a desktop PC.

Guidelines for Choosing a System RAM/Ram Disk Division

- If you can't open additional applications because you have run out of memory, either close unused applications or increase system RAM.
- If you can't save additional files in drive C (RAM disk) created by your applications, either delete unneeded files or increase RAM disk.

21

To change RAM memory allocation between system and disk:

1. Press **ESC** **MENU** **A** **L** to close all open applications.
2. Press **ESC** **S** **MENU** **O** **S**.
3. Tab to Memory.
4. Press **▶** and **◀** to change allocation (in kilobytes). You can't decrease RAM disk allocation under what is required to store files currently on disk.
5. Press **F10** (or **F9** to cancel).

Allocating Memory within System RAM for 200LX 1MB and 2MB

The Setup utility enables you to allocate System RAM among general workspace, the Clipboard, static data, and DOS. Your palmtop was shipped with these default memory values (with the remainder of System RAM left over for general workspace):

Clipboard: 4K
Static data: 10K
DOS: 96K

Clipboard system RAM is the RAM used by the Clipboard to store information. If you get an insufficient memory message when you use the Clipboard, either reduce the size of what you are putting in the Clipboard, or increase the amount of Clipboard system RAM.

Static data system RAM is the RAM used by some System-Manager compliant applications you can add to your palmtop that run like built-in applications. Do not change the static RAM value unless you load a System-Manager compliant program that states it needs a different amount of static RAM, or you find that the loaded program can't run when you switch back to it.

DOS system RAM is the RAM available for use by DOS and DOS applications when you run DOS from the Applications Manager. If you set DOS system RAM to 200K bytes of memory, for example, and then press **Ctrl** **D** to open DOS, the System Manager first checks to see if 200K is free. If 200K is available, it launches DOS. Then when you attempt to run your DOS application, it will run successfully if it requires no more than 200K. If you set this number too high, you may not be able to get a DOS prompt, or other applications may not have enough remaining memory to run.



To allocate system RAM for Clipboard, static data, and DOS:

1. From Setup, press **MENU** **O** **S** **F8**.
2. Tab to the text box for the type of system RAM you want to change.
3. Type a number of kilobytes within the limits shown.
4. Repeat steps 2 and 3 to change other memory allocations.
5. Press **F10** (or **F9** to cancel).

Changing Country Defaults, Punctuation, Currency, and Code Page Settings

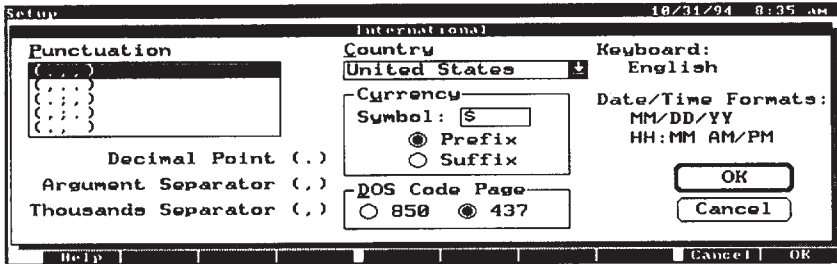
In Setup, press    to see the International dialog box:













1. Tab to the field you want to change.
2. Use the arrow keys select the setting you want. (You must type in the desired currency symbol.)
3. Repeat for other fields.
4. Press  (or ) to cancel.

Here is some relevant information about the International settings:

21

- As you select a country, the defaults for punctuation, date and time formats, currency symbol plus prefix/suffix, character sort order (for applications other than 1-2-3), and the available choices for DOS code page are chosen to agree with those used in the selected country. (You can still change individual settings if you like.)
- This table shows how to type various currency symbols.

How to Display Currency Symbols

	Keystrokes	Currency Symbol
Press	 	\$
Press	 	£
Press	 	¥
Press	 	¢
Press	 	f

- In order for new punctuation and currency settings to take effect in 1-2-3, you must quit 1-2-3 and then restart it. Also, the settings in any 123.CNF file present at startup take precedence over the settings made here.
- Changes you make in the International dialog box using Setup affect only System Manager Applications. They do not affect applications that you run from the DOS prompt. To make changes in these settings that affect both System Manager *and* DOS applications, make the changes using the special DOS command KEYBEZ. See appendix D for information on KEYBEZ.
- The Punctuation setting establishes the symbols used by the Calculator and the default symbols used by 1-2-3.
- The table below describes the punctuation symbols you can choose from.

Punctuation Symbols

Combination	Examples		
	Decimal Point	Argument Separator	Thousands Separator
. , ,	2.3	@PMT(B1,B2/12,B3)	1,234
, . .	2,3	@PMT(B1.B2/12.B3)	1.234
. ; ,	2.3	@PMT(B1;B2/12;B3)	1,234
, ; .	2,3	@PMT(B1;B2/12;B3)	1.234
. , space	2.3	@PMT(B1,B2/12,B3)	1 234
, . space	2,3	@PMT(B1.B2/12.B3)	1 234
. ; space	2.3	@PMT(B1;B2/12;B3)	1 234
, ; space	2,3	@PMT(B1;B2/12;B3)	1 234

- If a DOS application requires a code page different than the default for your country, you can select the other option in the DOS Code Page field.
- A code page change does not affect a DOS task that is already open. A change becomes effective when you open DOS after you make the change.

Specifying the Sorting Order for Lotus 1-2-3

The Sort command specifies the sorting order—called the *collating sequence*—used in 1-2-3 by the /Data Sort command.

To change the 1-2-3 sorting order:

1. In Setup, press **MEMU** **O** **1** (the number 1).
2. Arrow to the sorting order you want.
3. Press **F10**.

Specifying a Topcard or Picture Display

The Topcard appears whenever you quit all applications.

You can create a monochrome graphics image (a picture) to appear in place of the Topcard if you have PC graphics software that uses the .PCX file format. A picture will appear instead of the Topcard whenever you quit all applications.

To fill out a new Topcard:

1. In Setup, press **MEMU** **O** **O**.
2. Tab to and fill out your Name, Title, and Company.
3. Check or uncheck the Show Picture box (use the **spacebar**) depending on whether or not you want the default picture to surround your Topcard information.
4. Press **F10** (or press **F9** to cancel).
5. To display your new Topcard, quit all open applications (press **&...** **MEMU** **A** **L**).

To substitute a customized graphic image for the Topcard:

1. Create the desired image in a .PCX graphics file on a PC. To fill the display, the .PCX file should contain a monochrome image (single plane) that is 640 pixels by 200 pixels. If it's larger, the pixels beyond the 640 by 200 frame will not be displayed. If it's smaller, a portion of the display will be blank.
2. Transfer the file to your palmtop (for example to the C:_DAT directory).
3. Press **&...** **S** to start the Setup utility.

4. Press **CTRL** **O** **O** **F8**.
5. Type or highlight the path and name of your .PCX file.
6. Press **F10**.
7. If necessary, press **ALT**+**S** to place a check in the Show Picture box.
8. Press **F10**.
9. To display your new picture, quit all open applications (press **CTRL** **A** **L**).

To remove your graphic image and restore the Topcard:

1. In Setup press **CTRL** **O** **O**.
2. Press **F8**.
3. Tab to the Directories list box, arrow to D, and press **ENTER**.
4. Arrow to _SYS and press **ENTER**.
5. Press **ALT**+**F** and arrow to TOPCARD.PCX.
6. Press **ENTER** **F10**.
7. To confirm that you have the default Topcard back, quit all applications.

Closing Com1 to Save Power

You can save battery power when DOS is open by disabling/closing Com1 when you're not using it. However, if you use a DOS communications program, make sure the serial port is enabled/open.)

1. From Setup, press **CTRL** **O** **C** (Options Communications-Port).
2. Clear the checkbox Enable Com1 Port in DOS (tab to the field and press **spacebar**, if necessary).
3. Press **F10** **CTRL** **Q**.

The Filer and File Management

In your palmtop PC, data is saved in electronic files just like in any PC. The plug-in card slot is designated drive A and the internal RAM disk (analogous to a PC hard disk) is designated drive C. One difference, however, between your palmtop and most PCs is that the palmtop *automatically saves files in most applications as you work*. This is true for all applications except 1-2-3, the Memo Editor, and the Calculator. In these applications you must go through a saving process to save your data.

The built-in applications use DOS file-naming conventions. MS-DOS in the palmtop is described in chapter 25.

The application that enables you to manage your files—in other words to copy, delete, and otherwise organize them—is the Filer. Press  to start the Filer. If you *do not* have a card plugged in, you should see a listing of your root directory (C:\) similar to the following screen. (If you *do* have a card plugged in, you'll see a split screen with the root directory on one side and a directory for the card on the other. For more information see “Using the Split Screen” near the end of this chapter.)

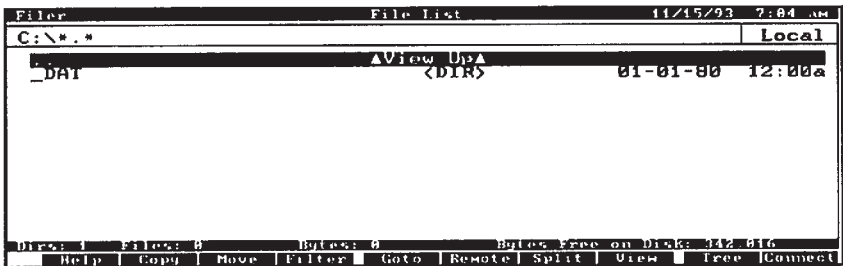

The Root Directory on Drive C

Among its many files, the root directory also lists at least one subdirectory, `_DAT` (marked `<DIR>`). `_DAT` contains many configuration files, such as the file for the printer settings, and will also contain files you create as you use your palmtop.

Do not delete or rename the `_DAT` directory.

Take Care of Your Data

You should take care of the data on your palmtop like you would on any PC. Here are some helpful suggestions:

- Close (Quit) applications when you're finished using them. One approach is to quit all open applications and return to the initial display (Topcard) at the end of each day.
- Back up your data files regularly by copying them to a memory card or, if you have the Connectivity Pack, to a PC. (Backing up is covered later in this chapter.)
- Carry an extra set of AA batteries so that you can replace your batteries as soon as the low-battery warning is displayed. If your batteries die while files are open, you could lose data.
- Change the backup battery *as soon as possible* after you see the low backup battery warning message.
- Close (Quit) all applications and turn off the palmtop before changing batteries.

22

Working with Files

The Filer is your file manager—it lists directories and the files in those directories. You can use these lists to copy, move, delete, rename, and print files.

Example: Making a Directory for 1-2-3 Files. Create the subdirectory `C:\123` for your 1-2-3 worksheet files.

Keys:

c:\

123 **F10**
D **ESC** c:\123
ENTER
U**Description:**

Starts the Filer and opens a dialog box for creating a directory.

Sets the path.

Names and creates the subdirectory.

Starts 1-2-3 and selects the default settings screen.

Makes the new 123 directory the default for new 1-2-3 files.

Updates the 1-2-3 configuration file so that C:\123 remains the default directory in future 1-2-3 sessions.

Quits the 1-2-3 menu and returns to the Filer.

To copy or move a file or directory:

1. In the Filer, use the arrow keys to highlight the name of the file or subdirectory. (As a shortcut, just start typing its name.)
2. Press **F2** (copy) or **F3** (move).
3. Type the new file or directory name. (If you specify a path with subdirectories that don't exist, the Filer will ask if you want them created. Respond by pressing **F10** (OK) or **F9** (Cancel).)
4. Press **F10** to perform the operation, or press **ESC** to cancel.

To delete a file or directory:

Do not delete the `_DAT` directory.

1. In the Filer, highlight the name of the file or subdirectory you want to delete. (When you delete a directory, any files or directories it contains are also deleted.)
2. Press **DEL**.
3. Press **F10** to perform the deletion, or press **ESC** to cancel.

To attempt to recover deleted files or directories:

1. In the Filer, display the directory list that contained the deleted files or directories.
2. Press **DEL** **F** **U**.

3. Type a file specification for the files or directories you want to recover. The ? and * wildcards are allowed. To see all candidates for Undelete, accept *.* as the undelete-file specification.
4. Tab to the File Type option box and arrow to your choice.
5. Press **F10**.
6. File and directory names are displayed with ? replacing the first characters. Arrow to highlight one of the files or directories you want to undelete and press **ENTER**.
7. The name of the highlighted file or directory is displayed. Type the character that should replace the ? and press **F10** to attempt recovery. A message will report the success or failure of your attempt.
8. Press **F10**.

To rename a file or directory:

1. In the Filer, highlight the name of the file or directory to rename.
2. Press **FN** **F** **N**.
3. Type a new file or directory name and press **F10**.

To view the contents of text (ASCII) files:

1. In the Filer, highlight the file name and press **F8**.
2. Use arrow keys, **FN** HOME, **FN** END, **FN** PGUP, and **FN** PGDN to view every part of the file.
3. To return to the directory display, press **F8** or **ESC**.

To run an executable file:

Files with file name extensions of .EXE, .COM, or .BAT are executable files.

1. In the Filer's Directory List view, highlight the name of the executable file you want to run.
2. Press **ENTER**.

To search for text in a file:

1. In the Filer, display the directory containing the file to search.
2. Press **FN** **O** **E**.
3. In the Text Search text box, type the text you want to find.
4. Select the files to search in one of these ways:
 - To search all files in the directory, press **F10** to display the Text Search Results dialog box.

- To search a particular file or set of files, press **TAB** and edit the offered file name (*.*) to define the file or files you want to search (you can use the wildcards * and ?). Then press **F10** to display the Text Search Results dialog box.
5. In the Text Search Results dialog box, arrow to the file you want to see and press **F8**.
 6. To view another file containing the search text, press **F8**, then repeat step 5.
 7. To end the search, press **F8** **F10**.

You can tag several files and directories to do multiple copies, moves, deletes, and prints all at once.

1. In the Filer, highlight a file or directory and press **spacebar**.
2. Repeat step 1 as often as you want.
3. To de-select, highlight the file or directory and press **spacebar**.

You can also use **Ctrl** **O** **T** (Options Tag) to select the currently highlighted file or directory, all files and directories above or below the highlight, and all files and subdirectories in the directory. If you select None, all files and directories will be de-selected.

Viewing a Directory

In the Filer you can switch between a **File List view** and a **Directory Tree view** (shows no file names) by pressing **F9**.

- { C is the current drive.
- \ (following C:) is the root directory.
- ._dat is the current directory.
- C:_dat is the path to the current directory
- *.* is the designator for all files in ._dat.

Subdirectories of ._dat. Dates of creation.

File	File	File	02/09/94	3:11 AM
C:_dat*.*				
	ΔView Up▲			Local
GAMES	<DIR>	02-20-94	11:32a	
STOCKS	<DIR>	02-12-94	9:48a	
appmer	dat	01-07-94	3:27p	
calc	env	02-11-94	4:17p	
ccmail	ini	01-24-94	5:15p	
filer	env	01-07-94	9:13a	
memo	env	01-19-94	9:16a	
setup	env	01-07-94	9:13a	
tripl-94	doc	01-19-94	9:16a	
Dir(s): 2	File(s): 7	Byte(s): 18,480	Byte(s) Free on Disk: 348,240	
Help	Copy	Move	Filter	Go to
			Remote	Split
			View	Tree
				Connect

Current file. File size in bytes. Times of creation.

File List View

Subdirectory of C:\ These dots mean NASDAQ contains one or more subdirectories.

22

File	Directory Tree		02/09/94	3:29 AM
C:_.*				
		ΔView Up▲		Local
._DAT				
GAMES				
STOCKS				
NYSE				
NASDAQ...				
ASE				
Directories: 6			Bytes Free on Disk: 348,240	
Help	Copy	Move	Filter	Go to
			Remote	Split
			Sync	Tree
				Connect

Subdirectories of STOCKS. **Directory Tree View**

You can also Sync the view to combine both the File List and Directory Tree views in one split screen. To Sync (or Unsync) the view, press **F8**.

Tree view of C:_dat directory.

List view of C:_dat directory.

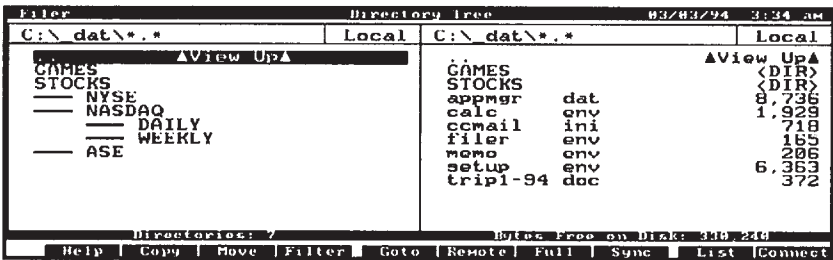

Sync View

To display a subset of the current directory:

1. Press **(F4)**.
2. Using the wildcards ? and *, specify the current directory's files you want displayed. For example, the file specification *.TXT specifies all files in the directory with the .TXT extension.
3. Press **(F10)**. The subset you choose will remain until you change it or quit the Filer.

To display a complete directory listing when viewing a subset:

- Press **(F4)** **(F8)**.

To choose the way files are sorted in a directory listing:

1. In the Filer, press **(MENU)** **(O)** **(S)** to display the file sorting choices.
2. Fill out the dialog box. (Press **(F1)** if you need help with the fields.)
3. Press **(F10)**.

Changing the Current Directory

To reach a higher-level directory:

- Either press **(ESC)**,
- Or highlight **▲View Up▲** and press **(ENTER)**.

To reach a lower-level directory:

1. Highlight the subdirectory name.
2. Press **(ENTER)**.

To display any other directory or drive:

- In the Filer, press **(F5)**.
- Or, press **(ESC)** to display the drive list. Then highlight the drive and press **(ENTER)**.

Using Plug-in Memory Cards

Drive A holds plug-in memory cards.

Caution

Turn the palmtop off before inserting or removing any plug-in memory card. Otherwise, the information on the card may be lost.

To format a plug-in memory card:

Many memory cards come preformatted—for example HP Flash Disk cards—but if you find you need to format a memory card, follow the procedure here.

1. Ensure that no program is running in MS-DOS. (If a DOS program is running, a card cannot be formatted.)
2. Turn off the palmtop, insert the memory card, and turn on the palmtop.
3. In the Filer, press **(MENU)** **(O)** **(C)**. *You will lose the present contents of your memory card when you complete the next step.*
4. Press **(F10)**.

To copy (back up) a file to a memory card (drive A):

1. With the Filer closed and the palmtop off, insert the card.
2. Press **ON** **☐**.
3. Highlight the file on drive C (left side of the screen) that you want to copy to A.
4. If you want to copy the file into a subdirectory on drive A, open the subdirectory:
 - a. Press **▶** to switch the highlight bar to drive A.
 - b. Highlight the subdirectory to open and press **ENTER**.
 - c. Press **◀** to move back to drive C.
5. Press **F2** **F10** to copy the file to A using the same file name.

Note If the screen appears to hang while transferring data between drives A and C, do not reset your palmtop until after about 30 seconds. Should a message prompt appears, select **RETRY** to avoid data corruption. Otherwise, you can reset your palmtop.

Backing Up a Directory's Files

You can back up a directory to a plug-in memory card or to a PC using the Connectivity Pack. Install the card or the Connectivity Pack before backing up.

To back up a directory's files to a new or existing directory:

1. In the Filer, display the listing of the directory whose files you want to back up. The directory name and its path will be displayed at the top left of your screen.
2. Press **MENU** **F** **B**.
3. Type a path and name of a new or existing directory that will contain your backup. This path could be to a memory card or, if you have the Connectivity Pack and use LapLink Remote Access, to a PC. *Do not end the text you type in the To: text box with a \.*
4. Press **TAB** and highlight to select either *All directories and files* or *Files only*.
5. **Optional:** Tab to and select *Modified files only* and/or *Overwrite existing files*.
6. Press **F10**.
7. If any directories in the path do not now exist, you'll be asked if you want to create them. Press **F10**.

Directories and File Name Extensions Used by Palmtop Applications

The following table will help you identify files that belong to specific applications. (Most applications automatically give a file a specific extension when the file is saved, and most files are by default saved in the C:_DAT directory.)

Standard File Name Extensions

Application	File Name Extension	File Use
Appt Book	.ADB	Appointment books
cc:Mail	.ADE	cc:Mail Local Address Book update
cc:Mail	.ATT	cc:Mail message attachment
1-2-3	.BAK	Backup worksheets
Datacomm	.CAP	Capture files
cc:Mail	.CCM	cc:Mail inbox
Calculator	.CFL	Cash flow lists
Datacomm	.CTF	Character translation files
Datacomm	.DCF	Configuration files
Memo Editor	.DOC	Memos and Quicken print files
Many App's	.ENV	Environment files
Calculator	.EQN	Solver equation lists
App. Mgr.	.EXM	Sys. mgr. compliant prgms.
Filer	.FCF	Configuration files
cc:Mail	.FLD	cc:Mail folders
DOS	.FON	Format files, related to KIT files
Database	.GDB	Databases
cc:Mail	.IDX	cc:Mail address book index
DOS	.KIT	Keyboard Information Table files
Datacomm	.LCF	Script files
System Macros	.MAC	Macro sets (1-10 macros)
cc:Mail	.MSG	cc:Mail messages
Note Taker	.NDB	Notes
Setup	.PCF	Printer configuration files
Setup	.PCX	Topcard graphics
Phone Book	.PDB	Phone books
1-2-3	.PIC	Graphs
1-2-3	.PRN	Print or text files
Calculator	.STA	Statistics lists
Pocket Quicken	.PDT	Pocket Quicken data files
1-2-3	.WK1	Worksheets
World Time	.WDB	Worldtime files

Using the Split Screen

The split screen (two-window) display makes file transfer and backup much easier. You highlight the file in one window and display the destination directory in the other window. Then press two keys to complete the transfer. You don't have to remember or type the path and file name.

If there is a plug-in card in drive A, a split screen displays when you open the Filer for the first time. The left window displays the root directory (C:\) and the right window shows A:\.

To switch between split and full screen display:

- In the Filer, press **(F7)**.

To move the highlight between split windows:

- Press **(▶)** or **(◀)**.

To copy or move files and directories using a split screen:

1. In the Filer, press **(F7)** to display a split screen.
2. In the window containing the highlight, make the destination directory current. The directory's path will display at the top left of the screen; for instance, C:_dat*.*.
3. Use **(▶)** or **(◀)** to place the highlight in the other window.
4. Highlight or tag the files or directories to copy or move. The figure below shows how your screen might look at this point if you were copying PICTURE2.PCX from drive A to the directory C:_DAT.

C:_dat*.*		Local	A:\pictures*.*		Local
..		▲View UpA	..		▲View UpA
cemail	ini	718	picture1	pcx	2,110
compuser	dcf	628	picture2	pcx	5,230
dowJones	dcf	628	topcard	pcx	6,157
filer	env	165	topscar	pcx	9,173
genie	dcf	628			
mci	dcf	628			
setup	env	6,363			

Dir: 0 Files: 4 Bytes: 22,674 Bytes Free on Disk: 429,856

Help | Copy | Move | Filter | Goto | Remote | Full | View | Free | Connect

5. Press either **F2** (copy) or **F3** (move). The destination defaults to the current path in the other window.
6. Press **F10**.

You can use the above procedure for operations between your palmtop PC and a desktop PC using the Connectivity Pack. Using an IR transfer, you can copy or move files and directories between two palmtops or between your palmtop and another PC equipped with IR capability..

To select (tag) multiple files and/or subdirectories:

Transferring Files between Your HP 200LX and Another Computer

You can copy and move files and directories between your HP 200LX and another computer in several ways:

- Using a memory card compatible with both computers. (Both computers must accept PCMCIA 2.0 memory cards.) You copy or move from one computer to a memory card, then insert that card into the other computer and copy or move from card to computer.
- Using a serial cable and Datacomm (see chapter 26).
- Using the Connectivity Pack (see the *Connectivity Pack User's Guide*).
- Using an IR connection.

Transferring Files Using an IR Connection

Your palmtop includes an IR port that enables you to perform most of the file and directory operations described in this chapter. Only the undelete command is unavailable during IR communication. No cable or additional software is required.

The following steps are required for IR communication:

1. Configure each computer for IR communication.
2. Position the two computers for IR communication.
3. Establish IR communication for file and directory transfer.

These steps are covered by the following procedures.

To configure an HP 200LX for IR communication:

1. From the Filer, press **[MENU]** **[C]** **[R]**.
2. Arrow to the baud rate supported by the two computers:
 - For HP 200LX to HP 95LX IR communication, use 2400 baud.
 - For HP 200LX to HP 200LX IR communication, use 57,600 baud.
3. Tab to **Interface** and arrow to **Infrared**.
4. Press **[ALT]+[S]** to reach the **Server Mode** option box and highlight **Enabled** on the HP 200LX chosen to be the server (the unit you *won't* work from).
5. Press **[F10]**.

To position the two computers for IR communication:

- Place the two computers with their infrared ports directly opposite each other and separated by about 1½ inches, as shown in the figure below. The **client** (the computer you'll operate) should face you so you can operate it conveniently. The infrared port is lined up with the third row of keys, counting from the top (the third row contains the **[7]**, **[8]**, and **[9]** keys).

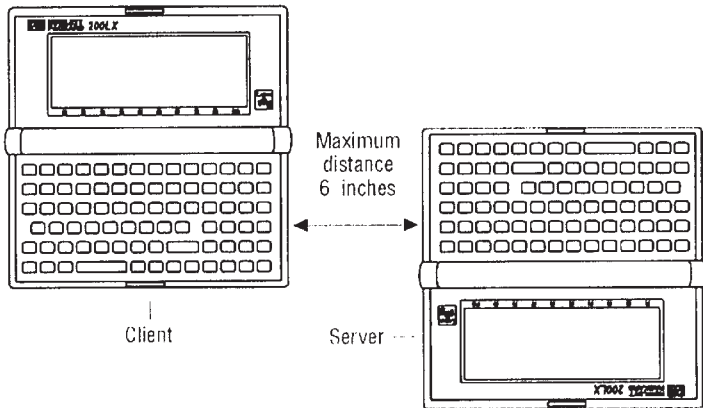

To transfer files and directories by IR between two palmtops:

Once the two palmtops are configured and positioned, do the following on the client:

1. Press **F6** to establish IR communication between both palmtops. (If you see only one window in the display, press **F7** to see the split screen.) The left window (“Remote”) shows the **server** directory list. The right window (“Local”) shows the **client** directory list (the one you are working at). *If you have trouble establishing the connection, start Datacomm (**Ctrl** **C**) on both computers, then return to the client’s Filer and press **F6** again.*
2. Display the listing for the **destination** directory (where you want to put the files).
3. Highlight the **source** file that you want to copy or move and select it (press **spacebar**). You can select more than one file.
4. Press **F2** (Copy) or **F3** (Move).
5. The dialog box should show the destination directory name. If not, type the path and name of the destination directory.
Do not type \ as the final character.
6. Press **F10**.
7. Press **F10** to break the IR connection.

To switch a window between local and remote directory displays:

The Filer will not display two remote directories simultaneously.

- Press **F6**. The Local/Remote indicator at the top-left of the window indicates whether the displayed directories are local or remote.

To turn an IR connection off:

When you’re not using it, be sure to turn off IR to conserve battery power.

- Press **F10** (disconnect). (When no connection is active, **F10** is labelled **Connect**.)

Transferring Files between an HP 100LX and an HP 200LX

HP 100LX files share the same format as HP 200LX files. Therefore, the procedures in this chapter that cover transferring files between HP 200LX’s also apply to transferring files between an HP 100LX and an HP 200LX.

Transferring Files between an HP 95LX and an HP 200LX

You can transfer ASCII files between an HP 95LX and an HP 200LX in either direction. You can also transfer HP 95LX Appointment Book and Phone Book files to an HP 200LX. (You cannot use HP 200LX Appointment and Phone Book files on the HP 95LX.)

About HP 95LX Appt Book and Phone Book Files. When you open for the first time a transferred HP 95LX Appointment or Phone Book file, the HP 200LX senses the HP 95LX file format and automatically starts a translation process. You are prompted to give a name to translate the file to—fill out the Translate dialog box and press (F10). Note that HP 95LX Appointment and Phone book files have the extensions .ABK and .PBK, while HP 200LX Appointment and Phone book files have the extensions .ADB and .PDB.

To configure an HP 95LX for IR communication:

- From the Filer, press (MENU) (R) (C) (I) (3) (Q) (Q)
(Remote-Set Config Interface 3(Infrared) Quit Quit).

Note

Do not copy the C:_DAT directory between the HP 95LX and the HP 200LX. There are files of the same names that would be copied over and lost. Instead, copy just those individual files that you want.

To transfer files and directories by IR between an HP 95LX and an HP 200LX:

Note that a copy or move operation for an HP 95LX Appointment Book to an HP 200LX will take 1 to 3 minutes for a book of average size. An average Phone Book should take less than a minute.

Configure and position the HP 95LX and HP 200LX as on page 22-13.

1. On the HP 200LX, press (F6) to establish IR communication. (If you see only one window in the display, press (F7) to see the split screen.) The left window (“Remote”) shows the HP 95LX’s directory list. The right window (“Local”) shows the HP 200LX’s directory list. *If you have trouble establishing the connection, start*

*Datacomm on both computers, then return to the HP 200LX Filer and press **F6** again.*

2. Display the listing for the **destination** directory (where you want to put the files).
3. Highlight the **source** file that you want to copy or move and select it (press **spacebar**). You can select more than one file.
4. Press **F2** (Copy) or **F3** (Move).
5. The dialog box should show the destination directory name. If not, type the path and name of the destination directory. *Do not type \ as the final character.*
6. Press **F10**.
7. Press **F10** to break the IR connection.

System Macros

The System Macros application enables you to record keystrokes for repetitive tasks. When you want to perform this task again, you can run your macro program and let it “press” the keys for you.

When you create a macro, you assign it to one of the function keys (F1) through (F10). To run a macro, you press (Fn) plus the function key to which the macro was assigned. You can run a system macro from the Topcard display or from any application except DOS or System Macros.

Creating System Macros

A macro can contain a maximum of 255 keystrokes. (To overcome this limit see “Creating Macros That Execute Other Macros” later in this chapter.)

To create a system macro from the System Macro application:

1. Press (Esc) (M) to open System Macros.
2. Arrow to the function key you want your macro assigned to.
3. Press (F8) (F10) to initiate macro recording. You are automatically switched back to your previous application.
4. Press the keys that constitute your macro. As each key is pressed, a low beep indicates the key is recorded.
5. End macro recording by pressing (↑)+(Fn) (F?), where (F?) is any function key, regardless of whether or not a macro is assigned to it.
6. To enter an optional description or name for your macro, press (F2) from the System Macros application, then type your description in the Description text box.
7. Press (F10).

To create a system macro while displaying each key symbol:

1. Press **[&...]** **[M]** to open System Macros.
2. Arrow to the function key you want your macro assigned to.
3. Press **[F2]**.
4. Optional: type a name or description for your macro.
5. Tab to the Contents dialog box. This box contains symbols for the keys you want your macro to execute.
6. Press the text keys or generate the symbols for other keys in the order you want your macro to “press” them. To generate those symbols, press **[F6]**, then the key or key combination that normally would produce the operation you want your macro to perform. (If you know the symbol, you can type the operation rather than have **[F6]** generate it for you.) If you’re not sure if you need to use **[F6]** to generate the symbol (rather than press the key directly), use **[F6]**, since it always works. (For instance, pressing **[F6]** **[MENU]** displays **⌘MENU**.)
7. Press **[F10]**.

To create a system macro from another application:

1. From any application except System Macros and DOS, hold down **[⌘]** and **[Fn]**, and then press the function key you want your macro assigned to. A two-tone beep, the first low, the second high, indicates the start of macro recording.
2. Press the keys that constitute your macro. As each key is pressed, a low-tone beep indicates the key is recorded.
3. End macro recording by pressing **[⌘]+[Fn]** and a function key.
4. To enter an optional description or name for your macro, press **[&...]** **[M]**. Highlight the macro, then press **[F2]** and type your description in the Description text box. Then press **[F10]**.

To run a system macro:

You cannot run a system macro from within DOS or the System Macros application.

- Press **[Fn]** followed by the function key that the System Macro is assigned to.

To edit a system macro:

1. Press **[&...]** **[M]** to open System Macros.
2. Highlight the macro you want to edit.

3. Press **(F2)**.
4. Edit the description and contents of your macro. If you don't know a key symbol for a non-text key, press **(F6)**, then press the non-text key. The palmtop will enter the symbol for you.
5. To save your editing changes, press **(F10)**. **Do not press (ENTER)** to save changes because it is used as a text key in the Contents box.

Creating Macros That Execute Other Macros

You can chain macros together to overcome the 255 keystroke macro size limit. To do this, make the last step of your macro execute a second macro. The second macro could end by executing a third macro, and so on. Your only limit is the amount of RAM disk memory.

To instruct a macro to run another macro:

1. Within System Macros highlight a function key and press **(END)** **(M)** **(E)**.
2. Create or edit your macro.
3. At the end of the macro (press **(Fn)** END) press **(F7)** (Chain).
4. Select the macro to chain to.
5. Press **(F10)**.

Caution

If you chain to another file of macros, be sure the macro set you're chaining *from* is saved (press **(END)** **(F)** **(S)**). Otherwise, when you chain from an unsaved set of macros, they will be lost.

Note

When a macro chains to another macro in another file, that other file becomes the current file. Therefore, the macro represented by **(Fn)** **(F1)**, for example, is now a different macro.

Saving and Opening Sets of System Macros

The System Macro application will automatically save up to 10 macros. If you want to save more than 10, you need to save the first set of up to 10 in a file. Only RAM disk size limits the number of sets of macros you can save in files.

To save a set of macros:

1. In the System Macros application, press **CTRL** **F** **A**.
2. Type a file name. The file name extension .MAC is added automatically. The file will be saved in the C:_DAT directory.
3. Press **F10**.

If you add macros to a set that has already been saved, you can save this new version of the same set by pressing **CTRL** **F** **S**.

Use **CTRL** **F** **O** to open an existing file of macros.

Use **CTRL** **F** **N** to open a new blank set of macros.

Clearing (Deleting) System Macros

To clear a single system macro:

1. In the System Macros application, highlight the macro you want to delete.
2. Press **F7** **F10**.
3. If you have saved this macro set, save this new version (if you want) under the same name by pressing **CTRL** **F** **S**.

To delete a saved set of Saved macros, use the Filer to delete the file.

System Macros and Lotus 1-2-3

- You can write and run a System Macro while in the 1-2-3 application.
- You can cause a System Macro to execute a 1-2-3 macro.
- You *cannot* cause a 1-2-3 macro to execute a System Macro, since there is no 1-2-3 macro instruction for this action.

This first example below shows how to write a System Macro that starts a 1-2-3 macro.

System Macros Examples

Example: Writing a Macro that Starts a 1-2-3 Macro

You want to start 1-2-3 and execute a 1-2-3 macro from other applications. Assuming the 1-2-3 macro is assigned to **ALT+A**, you follow these steps to write this system macro.

1. Display the Topcard or open any application except System Macros or DOS.
2. Press **↑** **Fn** **F1** to start recording (assuming **F1** has no macro already assigned to it).
3. Press **Esc** **ALT** **A**.
4. Press **↑** **Fn** **F1** to stop recording.

Now, when you press **Fn** **F1** from another application, 1-2-3 will start and execute the **ALT+A** 1-2-3 macro.























Example: Printing Today's Appointments from the Appointment Book

At the start of each day you want to have a printed list of your appointments. You can execute this macro to print this list, provided these conditions exist:

- No Appointment Book record is open.
- Your printer is turned on.

Create this macro as follows:

1. Display the Topcard or open any application except System Macros or DOS.

2. Press  +   to start recording (assuming  has no macro already assigned to it).
3. Press        +   + 
 +   +  .
4. Press  +   to stop recording.

Managing Your Applications

This chapter tells you how to

- Add applications to your palmtop.
- Start, quit, and delete application programs.
- Manage memory in your palmtop.

Installing Applications

There are two types of applications you can add to your palmtop:

- A **DOS application** that runs under MS-DOS 5.0 on a computer equipped with a CGA monitor. “Installing DOS Applications” is found in chapter 25.
- A **System-Manager-compliant (SMC)** application that operates like one of the built-in applications—you can start it from any other application, and switch between it and other applications without closing it. These special applications are being developed by a number of vendors specifically for the HP 200LX. (System-Manager-compliant applications developed for the HP 100LX will also run in the HP 200LX.)

To install an HP 200LX-type (SMC) application:

1. Plug in or copy the program files:
 - If the application is on a memory card, turn off your palmtop and then insert the card into the plug-in slot (drive A).
 - If the application is on a floppy disk, use the Connectivity Pack to transfer the files from a desktop PC to your palmtop PC.
2. Add the program to the Application Manager to make it easy to run. (If a program is not part of the Application Manager, then you must start it by going into DOS and typing its full path name.)

To add a program to the Application Manager:

The Application Manager assigns a program a name, icon, and key that you can use to easily start any program or application from the **[&...]** (More Applications) screen.

1. Press **[&...]** **[F2]** (Add) to display this screen:

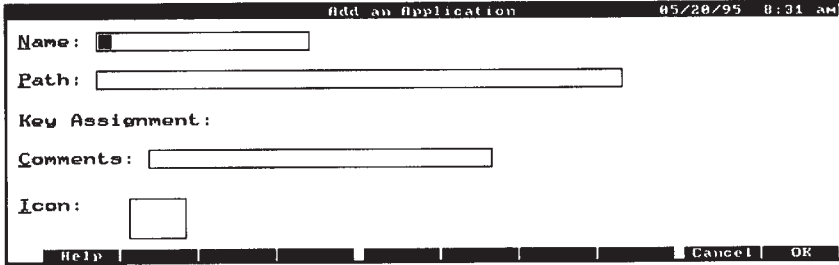

Add an Application Screen

2. **Name:** Type a name (up to 14 characters) for the application. The name will appear with an icon on the **[&...]** screen. Create an underlined character by preceding it in the Name field with an &. That character will appear underlined in the Icons View. The built-in applications already use some letters, leaving these for your use: G, J, K, V, X, Y, Z. You can also use numbers. For example, if the name of your program is "Data1" and you want **[1]** to start the program, type D&a&t &1. (If you use a number, it will always drop to the next line in the Icons View.)
3. **Path:** Type the complete path and file name of your application's executable file (63 characters maximum). Example: C:_DAT\CHESS.EXM. A System-Manager-compliant (SMC) program has a .EXM extension.
 - To specify the amount of memory to allocate for a DOS program (.EXE, .BAT, or .COM file) to run, append *ln* to the path name in the Path field, where *n* is the number of kilobytes to allocate. (The *l* character is generated by pressing **[↑]** **[↓]**.) Example: C:\Q.Q.EXE|256 allocates 256 KB whenever Q.EXE is run.
 - To allocate all available memory for a DOS program to run, append just *l* to the path name. Memory-wise, this is equivalent to starting a DOS program from the Filer (**[MENU]** Options DOS).
4. **Key Assignment:** You can start an SMC (*not* DOS) application with a shortcut key combination from any other application. To

assign this key combination, press **F4** and follow the instructions. (**F4** appears as **Set Key** if the path name you entered above ends with an **.EXM** extension.)

5. **Comments:** Optional.

- For a DOS communications program to run properly, this field must begin with “;” (**Fn** **!**). (This will also prevent switching to other applications.)
- To suppress the message “Press any key to exit DOS” at the end of a DOS program, begin this field with “?” (**Fn** **?**).

6. **Icon:** If your purchased application includes its own icon stored in a file with the extension **.ICN**, you’ll see this icon as you arrow through the choices. For an application that does not have its own icon, there are three built-in icons and a blank icon. The icon’s name will identify it.

7. Press **F10**.

Icons View and List View of Applications

To open the Application Manager, press **&...**. Each System-Manager-compliant and built-in application is represented in both the Icons View and List View shown below. To see all the icons or listings, use **▼** or **F10**.

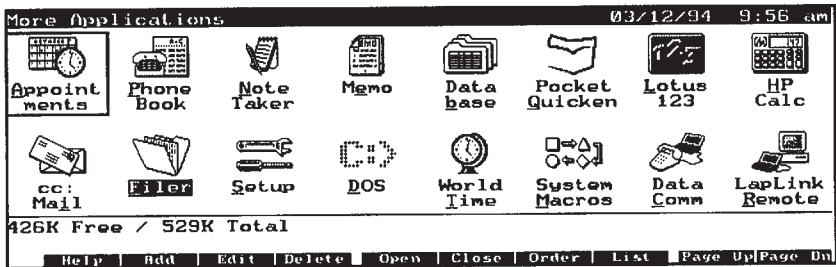

Icons View
(press **F8** from the List View)

More Applications: 426K Free / 529K Total 03/12/94 10:01 am				
Application	Status	Memory	Key	Comments
Appointments	Closed		Appt	
Phone Book	Closed		Phone	
Note Taker	Closed		Ctrl+Memo	
Memo	Closed		Memo	
Database	Closed		Ctrl+Phone	
PocketQuicken	Closed		Quicken	
Lotus 123	Closed		123	
HP Calc	Closed		Calc	
cc:Mail	Closed		Alt+123	
FileR	Asleep	58K	FileR	
Setup	Closed		Ctrl+FileR	
DOS			Ctrl+123	

List View

(press **F8** from the Icons View)

To edit the applications list:

Each application represented by an entry in the List View has a corresponding “Edit an Application” dialog box. For applications you’ve added, all text boxes in this dialog box can be edited. For built-in applications, only the “Comments” text box can be edited. You can also change the position of an application’s entry in this list.

- To edit an application’s listing, use **F3** (Edit).
- To change an application’s position in both the List and Icons Views, use **F7** (Order).

Starting, Quitting, and Deleting Applications

All built-in applications appear in the Application Manager (More Applications screen), as do supplemental applications that you have added to it (see the beginning of this chapter).

If an installed application is *not* in the More Applications screen, you must run it from the DOS prompt (chapter 25). Enter the path and name of the application’s executable file.

To start an application using the Application Manager:

- Press **&...**. This displays either the **Icons view** or the **List view** of the More Applications screen.
- **In Icons view:** Either press the letter-key for the letter underlined in the applications name, or highlight the icon and press **F5** or **ENTER**. (Press **▼** or **F10** to see more icons.)

- **In List view:** Highlight the name of the application and press **F5** or **ENTER**. Also, the Key column shows shortcut key sequences you can use to start the applications from any screen.

To quit an open application:

- For built-in applications, press **CTRL** **Q**.
- For added applications represented by an icon, arrow to the application's name in either the System Manager List or Icons View and press **F6** (Close).
- For added applications not represented by an icon, type at the DOS prompt the application's command that closes the application ("quit," "exit," or some similar command). See your application's instructions.

To delete an application you added:

1. From the List View in the Application Manager, highlight the application you want to delete.
2. Press **F4** **ENTER**.

Managing Memory

Types of Memory

There are three main types of internal palmtop memory:

- System RAM, commonly called RAM in a desktop or portable PC.
- RAM disk (drive C), analogous to a hard disk in a desktop PC.
- ROM (drive D), containing files that you cannot change. They may only be read and copied. The built-in applications are contained here.

Determining Memory Usage

- The bottom of the Icons View and the top of the List View in the Application Manager show the free and total memory in system RAM.
- In the List View of the Application Manager, the third column shows the system RAM being used by each open application. (The memory being used by 1-2-3 is flexible and depends on the total amount of available memory. The two numbers 1-2-3 shows are (1) the minimum memory required by the current worksheet and (2) the largest possible worksheet that could be created under the current conditions.)

Maximizing System RAM

Available system RAM can be increased by doing one or more of the following:

- Close all open applications.
- Close the System Manager.
- Change your AUTOEXEC.BAT file by *removing* commands for LapLink Remote Access and modem card support. (Type REM in front of the line to be removed.)

24

To check the amount of available memory:

- At the DOS prompt, type `CHKDSK` and press **ENTER**. The number of bytes free will be displayed.

To close all applications:

- From within the Application Manager (**Alt+M**), press **DEFU** **A** **L**.

If you want to close individual applications from the Application Manager, highlight an application in the List View and press **F6**.

If you want to access the DOS prompt when all applications are closed, press **CTRL**+**Alt**.

To close the System Manager:

After completing this procedure, built-in applications *will not* be available until you restart the System Manager. You will be able to run only DOS programs.

1. In the Application Manager, press **CTRL** **A** **T**.
2. Read carefully the displayed text.
3. Press **ENTER**.

To restart the System Manager:

- From the DOS prompt, type `Z00` and press **ENTER**.

To change AUTOEXEC.BAT to release system RAM:

You shouldn't attempt this procedure unless you are quite familiar with MS-DOS.

1. Use the Filer to copy AUTOEXEC.BAT and CONFIG.SYS from drive D to drive C.
2. Use the Memo Editor to edit the copy of AUTOEXEC.BAT on drive C:
 - a. Scan the file for comments describing commands that can be removed to save system RAM.
 - b. Read the descriptions of those commands to make sure you can give up the functionality they offer.
 - c. Remove (REM) the commands.
 - d. Save the edited copy on drive C.
3. Reboot the computer.

If you want to return to using the default AUTOEXEC.BAT and CONFIG.SYS, simply delete the copies on drive C and reboot the computer.

MS-DOS in Your Palmtop PC

Your palmtop contains a version of MS-DOS 5.0 in ROM that is optimized for a palmtop PC. Some of the external commands have been omitted, and some important utility commands have been added.

This chapter covers

- The various ways to access the DOS prompt.
- The palmtop System Manager program.
- DOS file and directory conventions.
- The palmtop DOS commands.
- Tips on installing and running DOS applications on the palmtop.
- Boot (startup) options.

If you want more information on the MS-DOS 5.0 operating system than is covered here, ask your local bookstore to recommend a book that meets your needs. There are many books written for readers of various levels of computer knowledge.

Many file and directory operations described in this chapter can also be performed in the Filer (chapter 22).

Accessing the DOS Prompt

You have three primary ways to access the C:\> DOS prompt. Each method gives a different amount of memory (and flexibility) to the DOS environment. If you plan to start a DOS program from the prompt, choose the way that's best for the situation.

- Press **CTRL**+**F2** (or **&... D**) to open DOS as a shell that acts as though it were an SMC (System-Manager compliant) application—one you can leave and then return to exactly where you left off. This method enables you to adjust the amount of

System RAM that DOS uses by taking memory from the Clipboard and other applications (see “Allocating Memory within System RAM” in chapter 21). However, you may not get enough memory this way to run a large application.

- From the Filer press **[F10]** **[O]** **[D]** to open DOS as a shell that also acts as an SMC program. This method automatically dedicates all available System RAM to DOS. This gives you a better chance of having enough memory to run a large application. However, you can't open a new SMC application unless you free up some memory by quitting DOS or closing other open SMC applications.
 - If you highlight in the Filer the name of an executable file and then press **[ENTER]**, you'll open the DOS shell and run the program all at once.
 - To get back out of DOS, type `exit`.
- Press **[Esc]** to open the Application Manager, then press **[Esc]** **[A]** **[T]** **[ENTER]** (Terminate All) to close all open files, applications, and the System Manager itself. This method gives you the maximum amount of memory to run an application. However, because the System Manager is not running, you can't access any built-in applications (which means no alarms or appointments) until you restart the System Manager by typing `Z00` at the DOS prompt and pressing **[ENTER]**.

25

About the System Manager Program. The System Manager opens automatically when you reboot because the last command in the AUTOEXEC.BAT file on drive D loads the System Manager program. It controls all built-in applications and all SMC (System-Manager compliant) programs you add.

You can leave a program or application operating under the control of the System Manager by starting another application, and then return to it later exactly where you left off.

Files and Directories

A name for a file or directory has from one to eight characters.

An *extension* to a file or directory name is one to three additional characters separated from the file name by a period. For example:

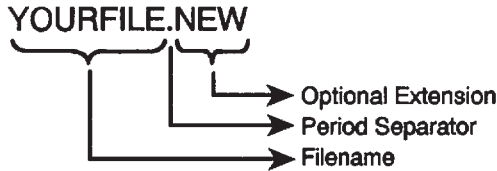

There is no distinction between uppercase and lowercase characters in file and directory names and extensions. Also, your palmtop implements the use of the standard DOS wildcard symbols (* and ?).

There is a limit of 64 files in a root directory. (A:\ is the root directory on drive A, for example.) To create more files, create subdirectories for them.

Valid Characters for File and Directory Names

Letters A through Z	Numbers 0 through 9	Underscore (_)
Caret (^)	Dollar sign (\$)	Tilde (~)
Exclamation point (!)	Number sign (#)	Percent sign (%)
Ampersand (&)	Hyphen (-)	Braces ({})
Parentheses ()	At sign (@)	Apostrophe (')
Grave accent (`)		

Avoid using the following file names. They are already used by the operating system:

Reserved File Names

AUX	CLOCK\$	COM1	COM2
COM3	COM4	CON	LPT1
LPT2	LPT3	NUL	PRN

The following extensions are reserved. You can use them if you're creating any of the indicated file types:

Reserved File Name Extensions

Extension	File Type
BAK	Backup files
BAT	DOS batch files
CHK	Assigned to files recovered by CHKDSK
COM, EXE	Program files
OVL	DOS uses this extension for overlay files
REC	DOS uses this extension for RECOVERed files
SYS	Used for device drivers
\$\$\$	DOS uses this extension for temporary files

The following extensions are used by certain types of files associated with the built-in applications.

Special Palmtop File Name Extensions

Extension	File Type
ADB	Appointment Book files
ATT	cc:Mail message attachment
BAK	1-2-3 backup worksheets
CAP	Datacomm capture files
CCM	cc:Mail inbox
CFL	Calculator cash flow lists
CTF	Character translation files for Datacomm
DCF	Datacomm configuration files
DOC	Memo Editor memo files and Quicken print files
DRV	cc:Mail communications driver
ENV	Holds application info between sessions
EQN	Solver equation files
EXM	System Manager compliant programs
FCF	Filer configuration files
FLD	cc:Mail folder
FON	MS Windows format files
GDB	Database files

Special Palmtop File Name Extensions (continued)

Extension	File Type
ICN	Added SMC application's icon file
IDX	cc:Mail address book index
INI	cc:Mail host (Post Office) config file
KIT	Keyboard Information files
LCF	Script (logon configuration) files for Datacomm
MAC	System Macros files (1-10 macros/file)
MDM	Modem control file for comm driver
MSG	cc:Mail messages
NDB	Note Taker note files
PCF	Printer configuration files
PCX	Graphics (Topcard) files
PDB	Phone Book files
PIC	1-2-3 graphs
PRN	1-2-3 print or text files
PDT	Pocket Quicken data files
STA	Calculator statistics lists
TMP	Temporary files
WDB	World Time files
WK1	1-2-3 worksheet files

DOS Commands in Your Palmtop

The palmtop's operating system contains two types of commands:

- Standard DOS commands, including CONFIG.SYS, MS-DOS, and Batch commands. (The external MS-DOS commands are located in D:\DOS.) These are described in the following tables.
- Utility commands created specifically for the palmtop. (The utility commands are located in D:\BIN.) These are described following the standard command tables.

You can display help information on any of the palmtop's standard DOS 5.0 commands by typing the command name followed with `/?` and pressing **ENTER**. For example, to display information on the MORE command, you type `MORE/?` and press **ENTER**.

Standard DOS Commands

DOS Command Syntax

Symbol	Meaning
COMMAND	Command name.
[]	Word or letter enclosed in brackets is optional.
	Indicates a choice must be made between two entries (ON OFF).
<i>drive:</i>	Drive designator.
<i>path</i>	List of directories that DOS must go through to get to a specific file or directory.
<i>filename</i>	Name of a file.
...	Indicates an entry may be repeated.

The standard MS-DOS 5.0 commands in the palmtop are listed in two tables. The first lists CONFIG.SYS commands, and the second lists MS-DOS and Batch commands.

CONFIG.SYS Commands Available in Your Palmtop

Command	Description
BUFFERS	Allocates memory at system start for a specified number of disk buffers.
DEVICE	Specifies the location and name of the device driver you want to load.
FCBS	Specifies the number of file control blocks that DOS can have open at the same time.
FILES	Sets the number of files that DOS can access at one time.
INSTALL	Loads a memory-resident program into memory when you start DOS.
LASTDRIVE	Specifies the maximum number of drives you can access.
SHELL	Specifies the location and name of the command interpreter used by DOS.
STACKS	Supports the dynamic use of data stacks to handle hardware interrupts.
SWITCHES	Forces an enhanced keyboard to behave like a conventional keyboard.

MS-DOS and Batch Commands Available in Your Palmtop

Command	Description
ASSIGN	Redirects requests for disk operations on one drive to a different drive.
ATTRIB	Displays or changes file attributes.
BREAK	Sets or clears extended CTRL+C checking.
CALL	Calls one batch program from another.
CHDIR or CD	Displays the name of or changes the current directory.
CHKDSK	Checks a disk and displays a status report.
CLS	Moves the cursor to the upper left corner and clears the screen.
COMMAND	Starts a new instance of the DOS command interpreter.
COPY	Copies one or more files to another location.
CTTY	Changes the terminal device used to control your system.
DATE	Displays or sets the date.
DEBUG	Runs Debug, a program testing and editing tool.
DEL or ERASE	Deletes one or more files.
DIR	Displays a list of files and subdirectories in a directory.
DOSKEY	Edits command lines, recalls DOS commands, and creates macros.
ECHO	Displays messages, or turns command-echoing on or off.
EXIT	Quits the COMMAND.COM program (command interpreter).
FOR	Runs a specified command for each file in a set of files.
FORMAT	Formats a disk for use with DOS.
GOTO	Directs DOS to a labelled line in a batch program.
IF	Performs conditional processing in batch programs.
MEM	Displays the amount of used and free system memory.
MKDIR or MD	Creates a directory.
MODE	Configures system devices.
MORE	Displays output one screen at a time.
PATH	Displays or sets a search path for executable files.
PAUSE	Suspends processing of a batch program and displays the message Press any key to continue
PROMPT	Changes the DOS command prompt.
REM	Records comments (remarks) in a batch file or in a CONFIG.SYS file.

MS-DOS and Batch Commands Available in Your Palmtop (continued)

Command	Description
RENAME or REN	Renames a file or files.
RMDIR or RD	Removes (deletes) a directory.
SET	Displays, sets, or removes DOS environment variables.
SHARE	Installs file-sharing and locking capabilities on your hard disk.
SHIFT	Changes the position of replaceable parameters in a batch file.
TIME	Displays or sets the system time.
TYPE	Displays the contents of a text file.
VER	Displays the DOS version.
VERIFY	Tells DOS whether to verify that your files are written correctly to a disk.
VOL	Displays the disk volume label and serial number, if they exist.
XCOPY	Copies files (except hidden and system files) and directory trees.

Special Utility Commands

25

CIC100 /GEN 1

Note

In this manual the command "CIC100 /GEN 1" is referred to as "CIC100." However, when you use the command, the /GEN 1 parameter should always be specified.

CIC100 (Card Installation Client) is a TSR (terminate and stay resident) program that performs recognition and configuration of PCMCIA modem cards. If CIC100 recognizes a given modem card, the modem and the plug-in slot will be configured as Com2. For more information see "Connecting to a Card Modem" in chapter 27.



FDISK 100

Performs a low-level initialization operation on an HP Flash Disk in drive A. It is not applicable to other memory cards. *See your HP Flash Disk Card manual before using this command.*

DISPCTL

DISPCTL [+C | -C] [+K | -K]

Enables or disables the +arrow key movement and/or the automatic cursor tracking while in the MS-DOS command processor.

- +C Enables cursor tracking.
- C Disables cursor tracking.
- +K Enables +arrow key movement.
- K Disables +arrow key movement.

Both options can be used together, but you must use at least one of them with the command.

SERCTL

SERCTL [/O | /W | /I]

Controls power to the infrared (IR) and wired serial ports. This command is for use when running programs from the DOS prompt; the built-in applications handle powering the ports automatically.

- /O Turns off power to the active port. Turning off the I/O ports while in the MS-DOS command processor results in significant power savings, thus extending battery life.
- /W Powers up and activates the wired serial port. Does not affect the baud setting.
- /I Powers up and activates the infrared (IR) port. Changes the baud setting to 2400.

KEYBEZ

KEYBEZ [*filename.kit*] [*kitfile option*]

- [*filename.kit*] Specifies the name of the .KIT file to be loaded.
- [*kitfile option*] Specifies one of the supported options available in the selected .KIT file.

This is a palmtop-specific NLS (National Language Support) utility command. With KEYBEZ you can change the country-specific defaults for displaying dates, times and currency. You can also use KEYBEZ to change character sort order, file name characters and uppercase/lowercase conversion information. KEYBEZ can also be used to load keyboard mapping support from one of the available KIT (Keyboard Information Table) files.

KEYBEZ includes NLS information as well as Extended Country Information and Code Page support. The language/country selection is determined by which KIT file is chosen and which option is selected from the available options in that particular KIT file.

KEYBEZ will enforce the selected Country defaults within System Manager applications if the System Manager is active. While KEYBEZ is loaded, the Options International dialog box in the Setup application is modified to display the defaults selected by KEYBEZ. The Country and DOS Code Page sections of the Setup International screen are deactivated since KEYBEZ controls these choices.

The first time executed, if given no arguments, KEYBEZ expands the default KEYBEZ.KIT file and the default KEYBEZ.FON file from D:\BIN. These files are placed in C:\ as HP100LX.KIT and HP100LX.FON. The next time KEYBEZ is executed with no arguments, it will refer to C:\HP100LX.KIT for options to display. The languages supported by these files are described in appendix D.

The .FON (font) file is a standard Microsoft Windows .FON format file containing 4 bit-mapped fonts in the sizes needed by the palmtop (6x8, 8x8, 10x11, and 16x12). The built-in .FON file provides additional characters to support Cyrillic, Greek and Turkish.

KEYBEZ replaces or enhances the functionality of the following MS-DOS Commands: COUNTRY, KEYB, MODE, and NLSFUNC.

KIT files built into the palmtop include:

- KEYBEZ.KIT with KEYBEZ.FON (South & East European Country Support. *See appendix D.*)
- COUNTRY.KIT (Selections with Default Code Page)
- ACOUNTRY.KIT (Selections with Alternate Code Page)
- LATIN.KIT (Selections with Default Code Page)
- ALATIN.KIT (Selections with Alternate Code Page)
- NORDIC.KIT (Selections with Default Code Page)
- ANORDIC.KIT (Selections with Alternate Code Page)

Supported Country NLS Defaults

Country	Code	Default Code Page	Alternate Code Page
For COUNTRY.KIT and AOUNTRY.KIT:			
Australia	au	437	850
Canada—English	ca	437	850
French	fr	850	437
Germany	gr	850	437
Italy	it	850	437
United Kingdom	uk	437	850
United States	us	437	850
For LATIN.KIT and ALATIN.KIT:			
Brazil	br	850	437
Latin America	la	850	437
Portugal	po	850	860
Spain	sp	850	437
For NORDIC.KIT and ANORDIC.KIT:			
Denmark	dk	850	865
Finland	su	850	437
Iceland	ic	850	n/a
Netherlands	nl	850	437
Norway	no	850	437
Sweden	sv	850	437

How To Use KEYBEZ

The general process is to expand the compressed .KIT file and place it on the C drive as HP100LX.KIT. This will give KEYBEZ access to all information in the .KIT file without needing to expand it each time before accessing it.

To expand a KIT file:

If, for example, you want to expand `d:\bin\nordic.kit` before loading the support for Denmark, do the following:

1. Use the compress/expand utility XINE to expand the .KIT file and install it onto the C drive.
2. To expand, type the following command at the DOS prompt:

```
XINE D:\BIN\NORDIC.KIT C:\HP100LX.KIT
```

To create a modified AUTOEXEC.BAT file:

The following assumes that you want to use the default NLS values for Denmark and that you have already expanded the .KIT file.

1. Use the Memo Editor to open your AUTOEXEC.BAT file (located in the root directory C:\ or D:\)
2. Add the line `KEYBEZ DK` just before the `200` line.
3. Save your new version of the AUTOEXEC.BAT file in the root directory C:\.
4. Ensure that your CONFIG.SYS file is in the root directory C:\. Copy it from D:\ if necessary.
5. Close all open applications in preparation to reboot.
6. Reboot by pressing **CTRL**+**ALT**+**DEL**.

This AUTOEXEC.BAT file will set up the following configuration:

- Danish conventions for date, time, currency, character sort order, and lowercase/uppercase.
- Default Code Page 850.

If you want to install the default NLS values for Denmark with the Alternate Code Page, expand the .KIT file by executing
`%1 D:\BIN\ANDORDIC.KIT C:\HP100LX.KIT`.

The modified AUTOEXEC.BAT file created above will now provide:

- Danish conventions for date, time, currency, character sort order, and valid file names.
- Alternate Code Page 865.

Notes

- Lotus 1-2-3 only supports code page 850. If `KEYBEZ` is used to configure any code page other than page 850, your printer must be configured for that other code page.
 - Files you create may become inaccessible when you use another code page. If you name a file when using one code page, then switch to another code page whose characters are not compatible, you may not be able to recover the file. To recover it, you may have to switch back to the code page you used when you named the file.
-

Notes:

- If KEYBEZ is active and Terminate-All is executed to quit the System Manager (**END**), restart the System Manager by pressing **CTRL+ALT+DEL** rather than by entering **200** at the DOS prompt. This will ensure that KEYBEZ is reconnected correctly to the System Manager.
- For more information on Eastern European language support, see appendix D.

KIT Country Options. You may see which countries are supported by a particular KIT file by typing KEYBEZ followed by the .KIT file name. (e.g. KEYBEZ D:\BIN\ACOUNTRY.KIT) This will replace any existing C:\HP100LX.KIT file with the expanded version of the .KIT file you specify.

KIT File Format. Documentation of the KIT file format is included in the KEYBEZ.KIT file which is built into your palmtop. You may view this file by executing `XINE D:\BIN\KEYBEZ.KIT C:\HP100LX.KIT` and then viewing the file `C:\HP100LX.KIT`.

Installing DOS Applications

To install a DOS application:

Probably the easiest way to install a DOS application involves using LapLink Remote Access, part of the Connectivity Pack. See the *Connectivity Pack User's Guide* and your application manual for specific information. You can install the application on either drive C or drive A (a memory card) in your palmtop.

The Application Manager enables you to assign to a program a name, icon, and shortcut key for starting the program from the **More Applications** screen. If a program is not System-Manager compliant, you must start it by going into DOS and typing the full path name or highlighting the file name in the Filer and pressing **ENTER**.

To add a DOS application to the Application Manager:

Press **[F10]** **[A]** and fill out the fields as explained in the beginning of chapter 24. You cannot make a key assignment, however.

- To specify the amount of memory to allocate for a DOS program (.EXE, .BAT, or .COM file) to run, append `ln` to the path name in the Path field, where `n` is the number of kilobytes to allocate. Example: `C:\Q.EXE1256` allocates 256 KB whenever Q.EXE is run.
- To allocate all available memory for the program to run, append just `l` to the path name. Memory-wise, this is equivalent to starting a DOS program from the Filer (**[F10]** Options DOS).
- To run a DOS communications program from the System Manager, the Comments field must start with “`!`” (**[Fn]** **[!]**).
- To omit the message “Press any key to exit DOS” at the end of a DOS program, the Comments field must start with “`;`” (**[Fn]** **[?]**).

Tips on Running DOS Applications

25

To execute **[F11]** and **[F12]** on the palmtop:

To execute:	Press:
[F11]	[Fn] [1]
[F12]	[Fn] [2]

To generate IBM Numeric Keypad Keys on the palmtop

While the palmtop has a numeric keypad, the keycodes associated with those keys correspond to the top-row number keys on an IBM-compatible PC keyboard. If your program asks you to press either an unshifted or shifted key on the number pad of an IBM-compatible PC keyboard, press instead the keys shown in the following table to get the same result.

How to Execute IBM Numeric Keypad Keys

To execute IBM key:	Press on palmtop:	To execute IBM key:	Press on palmtop:
0	+	←	
1	+	→	
⋮	⋮	Home	
9	+	↑	
.	+	PgUp	
DEL	+	+	
Ins	+	-	
End	+	*	
↓	+	/	
PgDn	+		

To load a TSR:

Do *not* load a TSR from a DOS prompt accessed from the Application Manager or from the Filer.

1. Make sure the System Manager is closed (press).
2. Run the TSR.
3. Open the System Manager (at the DOS prompt, type 200 and press).

If your TSR requires a keystroke sequence like + to become active, press + , then press again to turn off the shift.

To run a program from drive A:

Most programs run from drive A in the normal way. But some will not because they think it's a floppy drive. If you have trouble running your program from drive A, try running your program from drive E instead of drive A. (This makes use of a command in AUTOEXEC.BAT: `assign e:=a:.`)

If trouble persists, try reinstalling your program to drive E, and then run the program from drive E.

Controlling the Appearance of a DOS Display

You can control a DOS or DOS application screen in these ways:

- Change the position of the annunciators.
- Enlarge characters (ZOOM in on the display).
- Move around in an enlarged-character display by moving the cursor or by moving the window.
- Change black to white and white to black.
- Change shades of gray.

Details about these methods of control follow.

To change the position of the annunciators:

- Press **ON**+**=** to cycle through three states (left, right, off).

To zoom on a DOS display:

1. Press **Fn** ZOOM to see an enlarged portion of the original 80-character by 25 line display. If the cursor was at the lower-left corner, it is still at the lower-left corner after enlargement.
2. Press **Fn** ZOOM two more times to cycle through the zoom options and return to the original, unenlarged display.

- 25** ZOOM does not work on applications operating in graphics mode, but does work in text mode.

To view all parts of a zoomed display:

When characters are enlarged, you can view all parts of the screen in one of two ways:

- Move the cursor past the end of the window and watch the window move character by character.
- Use **Fn**+**▶**, **◀**, **▲**, and **▼** to move the entire window.

To invert DOS display colors:

You can invert a DOS or other text screens as well as graphic screens to make black white and white black.

1. Press **ON**+**/**.
2. To return to the original display, press **ON**+**/** again.

To change gray shades:

Applications that use a number of shades of gray to enhance their graphics can be run in the palmtop's DOS. However, your palmtop offers four shades of gray for such applications rather than the larger number provided by other PCs. Your palmtop allows you to choose between two sets of these four shades that might produce a more pleasing graphic image. (In general, however, it might be best to run such programs with their options set to either CGA mono, LCD, monochrome, or else change the color settings to make them easier to read.)

- Press **ON**+***** to toggle between two settings.

Customizing Your System

You might want to modify your AUTOEXEC.BAT and CONFIG.SYS files to customize the way your palmtop works. Your palmtop was shipped with those two files located in the root directory of drive D. You can modify copies of files on drive D using the Memo Editor, then save them on drive C or A.

If you save copies of AUTOEXEC.BAT and CONFIG.SYS on drive A or C, the next time you reboot your palmtop those files will be executed.

About the MS-DOS Startup Procedure

When you reboot your palmtop:

1. A search is made for the CONFIG.SYS file in the root directory of the palmtop's drives in this order: A, C, D. The CONFIG.SYS file in a new palmtop is on drive D.
2. As soon as the CONFIG.SYS file is found, the drive on which it was found is defined as the default drive. In a new palmtop, the default drive is defined as D.
3. The commands found in CONFIG.SYS are executed.
4. A search is made in the newly-defined default drive for an AUTOEXEC.BAT file.

5. If an AUTOEXEC.BAT file is found, the commands in that file are executed. If an AUTOEXEC.BAT file exists but is not found on the default drive, the commands in that file are *not* executed.

Boot (Reset) Options

When you reboot your palmtop, the message `Press ALT for Boot Options...` is displayed briefly, then disappears automatically as the boot process continues. If you press `ALT` during the brief time that message is displayed, you see the Select Default Drive Option screen:

***** Select Default Drive Option *****

Unless changed at this screen, the default drive will be the first of drives A, C, and D found to contain a `config.sys` file in the root directory. The options below allow control of default drive and startup file processing. This selection controls this reboot only.

1. Make A default drive; process startup files.
2. Make C default drive; process startup files.
3. Make D default drive; process startup files.
4. Make A default drive; do not process startup files.
5. Make C default drive; do not process startup files.
6. Make D default drive; do not process startup files.
7. Use normal default drive determination.

Enter selection [7]:

Why These Options Are Offered. It might help to give an example showing the usefulness of one of the options. Say you load on drive C a DOS application plus a special driver required by that application. You copy your startup files, `CONFIG.SYS` and `AUTOEXEC.BAT`, from drive D to C and modify the copies on C incorrectly in an attempt to satisfy the requirements of the special driver. When you boot, the system locks, since the first start-up files it found as it searched drives A, C, and D were on C. You try to boot again, but this time you press `ALT` to display the `*** Select Default Drive Option ***` screen. You select option 3, `Make D default drive; process startup files`. When you press `3`, the boot continues successfully, since the original startup files on drive D were

executed. Now you can inspect the modified copies of the startup files on drive C and attempt a fix.

To select a default drive option:

1. Press **CTRL+ALT+DEL** (reboot) or **CTRL+⏏+ON** (hard reset) and then press **ALT** immediately. The ***** Select Default Drive Option ***** screen appears.
2. Press the number key of the option you want. You need not press **ENTER**. To select the default option 7, press **ENTER**. After you select your option, the boot continues.

Part 6

External Communications



Datacomm

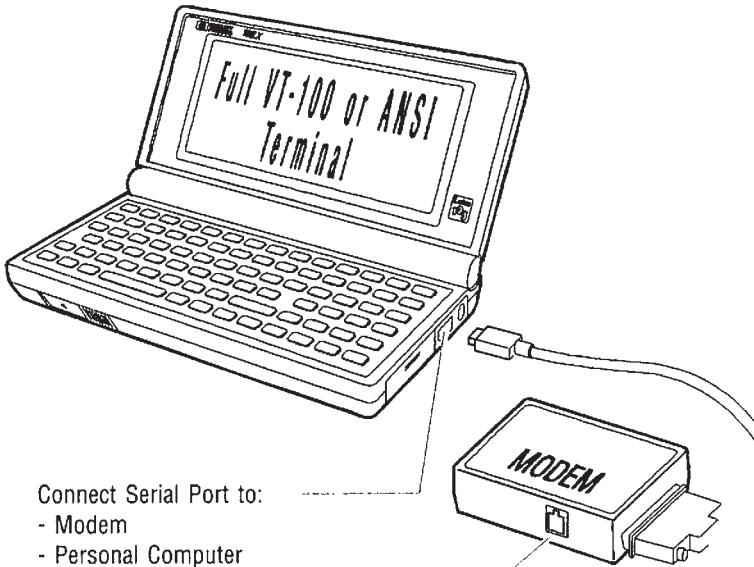

Connect Serial Port to:

- Modem
- Personal Computer

Telephone line to connect to:

- Compuserve, MCI, Dow Jones, GEnie (using built-in settings)
- Other remote networks or computers

The general procedure for using Datacomm to turn your palmtop into a terminal is to:

1. Configure your palmtop to match the requirements of the host system.
2. Prepare the hardware to physically connect to the host system (either directly or through a modem).
3. Make the connection and access the information you need.

These steps are covered in detail in the rest of this chapter. In addition you'll find related information on changing the number of characters in the display, capturing data in a file, automating procedures with script files, and translating characters between code pages.

To start Datacomm, press **[&...]** **[C]**.

Configuring for Datacomm

Determine the host configuration requirements and compare them with the palmtop default settings:

The Default Configuration Settings

Display	Setting	Choice/ Description
Settings dialog box	Baud	2400
	Interface	Com1
	Parity	None
	Data Bits	8
	Stop Bits	1
Advanced Settings dialog box	Emulation	VT100
	Backspace Key	Backspace
	Local Echo	Disabled
	Wrap Long Lines	Disabled
	Scroll	0 lines
	Flow	None
	Enq-Ack	Disabled
Phone dialog box	Type	Tone
	Timeout	30 seconds
	Automatic Redial	Disabled

26

To change the basic configuration settings:

1. In Datacomm, press **[F3]** **[C]** **[S]** to display the choices covered in the following table. Tab to cycle between the boxes or press **[ALT]** together with the underlined letter to reach a particular box. To display all choices in a box containing a **▼** symbol, press

▼ and ▲ several times. Pressing ALT+▼ will display several—but not necessarily all—choices.

- If you want to make more choices, follow one or more of the next two procedures. Otherwise, press F10 to complete your choices.

Choices in the Settings Dialog Box

Setting	Choices/Description
Baud rate	300, 1200, 2400, 4800, 9600, 19200, 38400, 57600, 115200
Interface	Com1, Com2, Alternate, Infrared
Parity	None, Odd, Even, Mark, Space
Data bits	7, 8
Stop bits	1, 2
Open	Displays the Open Configuration File dialog box.
Save as	Displays the Save Configuration File dialog box.
Advanced	Displays the Advanced Settings dialog box.
Phone	Displays Phone Settings dialog box.
Defaults	Return settings to their default values.

To change the phone configuration settings:

This is also where you add the phone number for a modem to dial.

- In the Datacomm Settings screen (press RETN, C, S), press F5 to display the choices covered in the following table.
- Specify your choices using TAB, arrow keys, spacebar, and typing.
- Press F10.

Choices in the Phone Settings Dialog Box

Setting	Choices/Description
Number	Phone number to be dialed.
Type	Tone, Pulse.
Timeout	Call ends in specified seconds if no answer.
Automatic Redial	Check to enable.

To change the advanced configuration settings:

1. In the Datacomm Settings screen (press **ESC**, **C**, **S**), press **F4** to display the choices covered in the following table.
2. Specify your choices using **TAB**, arrow keys, **spacebar**, and typing.
3. To display the Download Directory dialog box, press **F6**.
4. To display the Logon File dialog box, press **F7**.
5. To display the Remap File dialog box, press **F8**.
6. Press **F10** to make your choices effective.

Choices in the Advanced Settings Dialog Box

Setting	Choices/Description
Emulation	VT100, ANSI, TTY, MAP. (MAP emulates a "glass tty" terminal, except otherwise ignored control codes are mapped to displayable characters—control code 1 is displayed as ^A, control code 2 to ^B, and so on.)
Backspace key	Backspace, Delete. (Backspace backs up one character, while Delete backs up and deletes one character.)
Local Echo	When enabled, characters you transmit will display on your screen.
Wrap long lines	When enabled, long lines are wrapped that otherwise would disappear off the right edge of the screen.
Scroll	Defines the size of the scroll buffer that allows you to view up to 99 previously displayed lines.
Modem Init	Accepts a command line. For Hayes and Hayes-compatible modems, the command line starts with AT or at and ends with a carriage return. Many commands can be issued to your modem by making choices in the Settings, Advanced Settings, and Phone dialog boxes. Use the Modem Init text box to enter other commands.
Flow control:	
RTS-CTS	Request to send, clear to send. (hardware)
XON-XOFF	Transmission on, transmission off. (software)
None	No flow control
Enq-Ack	Enquire-Acknowledge.
Download	Displays the Download Directory dialog box.
Logon	Displays the Logon File dialog box.
Remap	Displays a Remap File dialog box.

Using Configuration Files

If you save configuration settings in a file, reconfiguring your palmtop for datacomm becomes as easy as opening a file.

To save the current configuration settings in a file:

1. In Datacomm, press **ENTER** **C** **S** **F8**.
2. Type a file name with no extension. The first character you type will erase .DCF and display that character. The extension .DCF will be added to your file name automatically. Your file will be in the C:_DAT directory unless you specify a different directory.
3. Press **F10** **F10** to save your settings in your new file and to return to Datacomm's opening display.

To choose an existing configuration file

1. In Datacomm, press **ENTER** **C** **S** **F7**.
2. If your file is saved in a directory other than C:_DAT, tab to the **Directories** list box, highlight the correct directory, and press **ENTER**.
3. Tab to the **Files** list box, highlight the correct file name, and press **ENTER**.
4. Press **F10**.

Built into your C:_DAT directory are configuration files for four commercial information services: CompuServe, MCI, Dow Jones News Retrieval, and GENie.

To choose the default configuration settings:

- In Datacomm, press **ENTER** **C** **S** **F6**. All configuration settings are returned to their default settings.

Preparing Your Hardware

You need the HP F1015A Serial Cable to connect either to a modem or directly to the host system.

- If you're using a modem, see chapter 27 for information on connecting a modem to your palmtop.
- If you're connecting directly to the host system, use the HP F1015A Serial Cable and the appropriate adapter from the HP F1023 Adapter Kit. Connect the 10-pin end of the cable to the Com1 port on the palmtop—*make sure the HP logo faces up when you insert it*—and connect the other end of the cable (possibly with an adapter) to the host serial port.

Note

Connecting cables and adapters to computers can be a tricky procedure because the required adapters can vary with different computers. If you need help with this process, contact a local electronics dealer or the manufacturer of the computer you're trying to connect.

Making Serial Connections

In most cases, the serial cable and 25-pin adapter provide the desired serial connection between the palmtop and the other PC. But if you're connecting the palmtop to a modem or to another type of serial connector, you will need to use different adapters. The following table shows several serial connections.

Serial Connections for the Palmtop

To connect to ...	Use ...
PC Serial Port (9-pin male)	Serial cable ¹
PC Serial Port (25-pin male)	25-pin ¹ ↔ Serial cable ¹ adapter
PC Serial Port (25-pin female)	Printer ² ↔ Serial cable ¹ adapter Gender ³ ↔ 25-pin ¹ ↔ Serial cable ¹ converter adapter
Modem (25-pin female)	Modem ² ↔ Serial cable ¹ adapter Null ³ ↔ Gender ³ ↔ 25-pin ¹ ↔ Serial ¹ modem converter adapter cable
¹ From Connectivity Pack or HP F1015A Serial Cable. ² From Connectivity Pack or HP F1023 Connector/Adapter Kit. ³ From electronics supply store or computer dealer.	

The following table and figure show the pin assignments and pin locations for the palmtop Com1 serial port and the 10-pin connector. This information is important if you need to get help connecting to a remote system or other device.

Pin Assignments for the palmtop Port and the 9-Pin Connector

Port Pin No.	Signal	Connector Pin No.	Port Pin No.	Signal	Connector Pin No.
1	Data carrier detect	1	6	Data set ready	4
2	Receive data	3	7	Request to send	8
3	Transmit data	2	8	Clear to send	7
4	Data terminal ready	6	9	Ring indicator	9
5	Signal ground	5	10	Shield	5

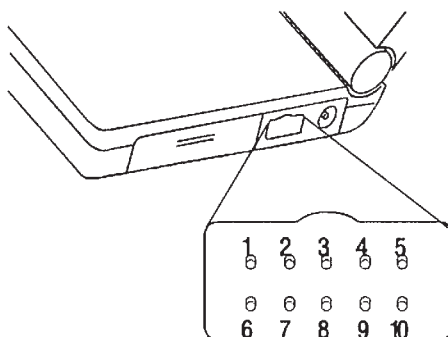

Pin Numbers

Pin assignments on the HP F1015A serial cable are for standard RS232 DB9 connectors.

Beginning and Ending a Communication Session

Once your palmtop is properly configured and connected to a modem or host system, you're ready to communicate.

To begin data communication:

- Press **(F10)** to initiate communication.

To end data communication:

1. If necessary, log off the remote system.
2. To close the data communication session:
 - If you're connected via modem or IR, press **(F10)**.
 - If you have a direct connection, just disconnect the cable.
3. To close the Datacomm application, press **(F10)** **(Q)**. The last configuration settings you used will be active when you return.

Hangup

The hangup command is executed *automatically* whenever you quit Datacomm (**(F10)** **(Q)**).

Example: Communicating with CompuServe. CompuServe is a popular bulletin board service used worldwide for communication, information, and software. Call (800) 848-8199 in the U.S. to get an identification number, password, and local phone number. Outside the U.S., call 1 (614) 457-0802.

1. Start Datacomm (**(F10)** **(C)**).
2. Select **(F10)** Connect Settings and press **(F7)** (Open). This displays a list of available configuration files. These files provide standard information to access the listed communication services.
3. Tab to the Files box to highlight COMPUSRV.DCF, the configuration file for CompuServe.
4. Press **(F10)** (OK).
5. Press **(F5)** (Phone) and type the local "node" CompuServe phone number. *It's best to omit hyphens and parentheses.* If necessary, use a comma to create a pause. Example: 9,15039672460 dials an outside line to call long-distance to (503) 967-2460.
6. Press **(F10)** **(F10)** (OK OK) to save this information in COMPUSRV.DCF.

7. Press **(F10)** (Connect). When the connection is made, you will see `CONNECT nnnn` (where `nnnn` is the baud rate).
8. Press **(ENTER)**. Enter `CIS` as host, then your ID number and password as requested.
9. When you're finished communicating, log off from CompuServe by typing `bye`. Then press **(F10)** (Hangup).

Customizing Your Display for Datacomm

To change between 64x18 and 80x25 displays:

- Press **(Fn)** ZOOM. The display toggles between 64x18 and 80x25 characters.

To move the 64x18 window around the 80x25 screen:

The 64x18 character display is a moveable window into the 80x25 screen.

Window Moving Keys

Keys	Description
(ALT) + (▲)	Move up one line.
(ALT) + (▼)	Move down one line.
(ALT) + (▶)	Move right one character.
(ALT) + (◀)	Move left one character.
(CTRL) + (▶)	Move right one screen.
(CTRL) + (◀)	Move left one screen.
(ALT) + (Fn) PGUP	Scroll up one screen.
(ALT) + (Fn) PGDN	Scroll down one screen.
(ALT) + (Fn) HOME	Return to the current cursor position.

To scroll up to 99 lines:

You can scroll text to see up to 99 previously displayed lines:

1. Select **EDIT** Connect Settings and press **F4** (Advance). Press **ALT+S** to move to the Scroll box.
2. Type a number from 0 to 99 to set the size of the scroll-back buffer.
3. Press **F10 F10** (OK OK).

Capturing Data in a File

To capture data in a file:

1. In Datacomm, press **F5** (Capture).
2. Type a file name with no extension. Your file will automatically be given the extension .CAP and will be in the C:_DAT directory (unless you specify another directory).
3. Tab to the Control code option box and arrow to highlight a filtering option: Omit, Map to letters, or Capture as is. See the table below.
4. Press **F10** (OK). All characters received on the serial port will be stored in the specified capture file.
5. Press **F5** (StopCap) to stop the capturing.

Capture File Filtering Options

Option	Description
Omit	ASCII control codes are filtered out, not captured.
Map	Control codes are mapped to displayable characters in the capture file. For example, control code 1 is written as ^A, 2 as ^B, 3 as ^C, and so on.
Capture	No filtering. No changes to control codes.

Automating Datacomm Procedures

A **script file** enables you to automate a logon procedure. When you include a script file name as part of your configuration, the script is executed when a remote connection is made. Here is a sample script file that would log L. Harrington on to his e-mail system:

```
Hello |
(Enter your login name: )
L. Harrington |
(Enter your password: )
Cougar |
```

Once you know the host system's requirements for logging on, use the Memo application to create a script file using these script characters:

Special Characters for Script Files

Character	Description
{ ... }	The left and right braces are used to enclose a string of characters that comes from the remote system. A string in braces instructs the palmtop to wait until an exact match of that string is received and then continue with the script. If a matching string is not received within 30 seconds, the script quits execution.
^	Indicates that the uppercase character following it is a control character. For example, ^A represents control-A. (If you want to represent the character ^, use ^^). If you want to represent control-^, use #1E.)
#	Interprets the two characters following it as the hex number to represent an 8-bit character. For example, #1E represents control-^. (If you want to represent the character #, use ##.)
	Represents a carriage return.
~	Causes a 1-second pause.
@e	Turns echo pacing on. (Echo pacing requires the remote system to "echo" back each sent character before another one is sent.)
@n	Turns echo pacing off.
@b	Sends a break signal for 1 second.
@@	Sends a single @ character.
@f[path]	Sends the file identified by the DOS path <i>as is</i> —no characters are translated, including control characters. You must include the square brackets around the path, which includes the file name.

The script starts *after* the modems have connected and the message `Connect nnnn` (where *nnnn* is the baud rate) appears.

Use the Memo Editor to create your ASCII script file (no special formatting), and save it in `C:_DAT` with a `.LCF` file extension.

To specify an existing script file for a logon procedure:

1. Select **MEMO** Connect Settings and press **F4** **F7** (Advance Logon).
2. Specify your `.LCF` file.
3. Press **F10** **F10** **F10** to return to Datacomm's opening display.

To use a script file while a Datacomm connection is active:

1. Complete your logon.
2. At the point in the connection process where you want your script file to take effect, press **MEMO** **C** **R** **TAB**, arrow to the script file you want, and press **F10**.
3. To cancel script file execution, press **CTRL**+**BREAK** (**CTRL**+**MEMO**).

Transferring Files

The easiest method for file transfer involves using the Connectivity Pack. However, the Datacomm application gives you other methods for file transfer using XMODEM, YMODEM, ZMODEM, or Kermit protocols.

- Start and end the communication session as described earlier in this chapter.
- Use the File Protocol command (**MEMO** **F** **P**) to select the file transfer protocol you want for send and receive operations.
- Use File Send, File Receive, and File Kermit-Get commands to send, receive, and get files.
- To put the palmtop in Kermit Server mode use the Connect Kermit-Commands command, select `Fut HF100LX` in server mode, and press **F10**. Putting the palmtop in Server mode is appropriate if you have previously initiated a Kermit send operation from the host.

- When you complete a Kermit transfer and the host has been put in Server mode, press **REMI** **C** **K** and select **Finish** with **Remote Server**. When you complete a Kermit transfer and the palmtop has been put in Server mode, press **CTRL****BREAK**.
- When X-, Y-, and ZMODEM transfer protocols are selected, Datacomm will automatically select 8 bits, no parity, and turn software flow control off. These settings may cause problems on some communication networks. Previous values for these configuration settings are restored when the transfer is completed. Also, 57600 and 115,200 baud are not recommended for X-, Y-, and ZMODEM transfers.
- XMODEM does not allow multiple-file transfers. YMODEM, ZMODEM, and Kermit do allow transferring more than one file at a time using wildcards.
- To send multiple files, enter wildcards when you use **File Send**, and then press **ALT**+**S** to enable **Send All**.
- You can change the default download directory for receiving files using **REMI** **C** **S** **F4** **F6**.
- Do not transfer multiple files using the Kermit protocol unless you move them to the default directory, C:_DAT. If you move multiple files to another directory, the first file moved will be placed in that other directory, and the remaining files will be transferred to the default directory, C:_DAT.

Character Translation between Code Pages

26

If a remote system sending you information doesn't use the code page that your palmtop application uses, you may need to translate some of the characters you receive. For instance, if the sending system transmitted character 150 on code page 860 (Ú) to your palmtop that was using code page 850, you probably would want to translate it into character 233 on code page 850 (Ú). A Character Translation Facility (CTF) file enables you to translate characters into meaningful characters the palmtop can display and print. The CTF is for displaying characters on the screen or for capturing characters from the screen into a file.

Note

CTF files do not translate characters when you use XMODEM, YMODEM, ZMODEM, or Kermit protocols or when you receive files as ASCII text.

To enable character translation:

- Create a CTF file and specify it in your configuration settings.

To create a CTF file:

1. Identify the characters causing the problem and determine their decimal or hexadecimal character numbers on both the palmtop and the remote system. (Appendix C contains the palmtop character sets.) Since the character sets on both the palmtop and remote system may not be the same, the receiving system may have to choose a character that is a close but not exact match.
2. Use the Memo Editor to create an ASCII file similar to the sample shown below. Use the formatting rules and the table of CTF commands on the next pages for reference. Save the file with a .CTF extension in the C:_DAT directory.

Sample CTF File.

```
# This is a partial code page 850 to 860 translation.
# Values from codes 128 to 143 that need translation
# will be performed
# Codes received will display exact character matches
RADIX 10
RCONV 132 198
RCONV 134 181
RCONV 137 210
RCONV 139 214
RCONV 140 226
RCONV 142 199
RCONV 143 182
# Codes transmitted are nearest equivalent characters
TCONV 132 160
TCONV 134 131
TCONV 137 136
TCONV 139 161
TCONV 140 161
# End of example Character Translation File
```

Formatting Rules Used in the Above Sample File

- You must start the file with the RADIX command.
- Each command must be on a line by itself. (Blank lines are ignored, so you can add them between commands to enhance readability.)
- At least one space is necessary between the command and each input. (Multiple blank spaces are ignored, so they can be used for additional readability.)
- Lines with just numbers assume the previous command.
- Lines starting with # are ignored and treated as comment lines.

The complete set of CTF commands is found on the next page.

To make a CTF file part of the current configuration:

Before the settings in a CTF file become active, the file must be made part of the current configuration.

1. In Datacomm, press **ESC** **C** **S** (Connect Settings), then **F4** **F8** (Advance, Remap).
2. Specify your .CTF file. If necessary, tab to the Directories list box and arrow to the correct directory, then tab to the Files list box and arrow to the .CTF file you want.
3. Press **F10** **F10** **F10** to return to Datacomm's opening display.

Descriptions of CTF File Commands

Command	Description
#	Indicates a comment line, which is ignored in the file.
RADIX	Indicates whether the numbers used as input for the rest of the commands are interpreted as decimal codes or hexadecimal codes. You must use either RADIX 10 (decimal) or RADIX 16 (hexadecimal). (The examples in this table assume RADIX 10.)
RCONV	Specifies that a character received by the palmtop is to be converted to another character. It takes two inputs: the first number is the character code that should be translated, and the second is the code to be substituted. For example, using code page 850, RCONV 36 156 causes character code 36 (\$) to be translated to 156 (£) when it's received.
TCONV	Specifies that a palmtop character is to be translated before it is transferred. It takes two inputs: the first number is the character code to be translated, and the second is the code to be substituted. For example, TCONV 124 132 causes the palmtop " " character (code 124 in code page 850) to be translated so that the receiving system gets code 132.
RTCONV	Combines related RCONV and TCONV commands by specifying both the receive and transmit conversions in a single command. It takes three inputs: the first number is the character code to translate when it's received by the palmtop; the second is the code to substitute for that character; and the third is the palmtop character to translate into the first number for transmission. For example, RCONV 131 140 and TCONV 140 131 can be combined into RTCONV 131 140 140 . This command causes character code 131 to be translated into code 140 whenever it's received by your palmtop; and whenever the palmtop code 140 is to be transmitted, it is first converted back to code 131 for the remote system.
MTCONV	Specifies that a keystroke is to be translated into multiple characters. It takes from 2 to 11 inputs, one key code to be translated and up to 10 codes of the characters into which the first key code is to be translated. Such a translation is used in special circumstances, such as mapping a single keystroke in the "erase field" sequence expected by an IBM protocol. Each of as many as 20 palmtop keystrokes may be translated into as many as 10 characters.

Example: Using MTCNV to Send Escape Sequences for IBM PROFS. The IBM PROFS electronic mail system can interpret escape codes from the palmtop to carry out functions not on the palmtop keyboard. For instance, a PROFS system might define the meaning of “ESC O p” as “Clear screen” and the meaning of “ESC =” as “PF12”.

The MTCNV command converts a specified palmtop character code to a specified escape sequence. This three-line example remaps the à on the palmtop (code 133 on code page 850) to ESC O p, which is codes 027 079 112. It also remaps the ß (code 225) to ESC = (codes 027 242).

Command	Description
RADIX 10	Interprets codes as decimal.
MTCNV 133 027 079 112	Maps à (Fn a) to mean “Clear screen.”
MTCNV 225 027 242	Maps ß (Fn s) to mean the key “PF12”.

Using a Modem with Your Palmtop PC

Equipment You Need

- Your palmtop.
- A modem, either serial or card.
- For a serial modem only:
 - The HP F1015A cable (see the figure below) . This cable is available separately or as part of the Connectivity Pack.
 - A serial modem adapter. This is available in the HP F1023 Connector/Adapter Kit and in the Connectivity Pack . The 25-pin modem adapter is *gray* and has a telephone symbol. The printer adapter is white and the 9-pin adapter is black.

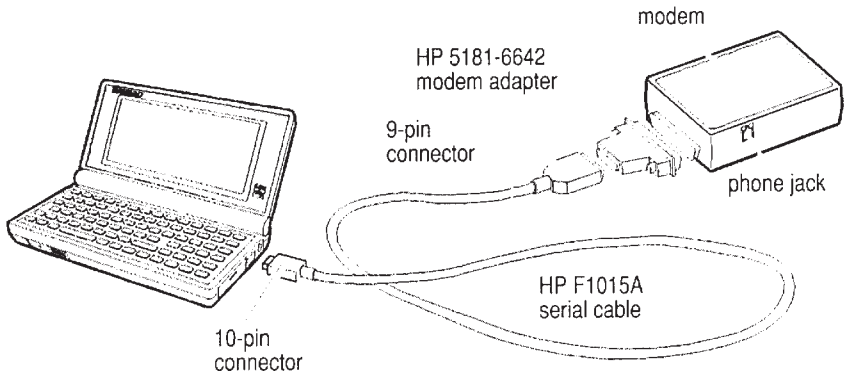

27

For information on the hardware needed for a modem connection, see page 26-6. For the pin assignments for the palmtop serial port and the pin numbers for the 10-pin connector on the serial cable, see page 26-7.

Connecting to a serial modem

1. Refer to your modem instructions to make the communications settings (baud rate, etc) on your modem agree with the settings in your palmtop communication application.
2. Connect the modem adapter to your modem.
3. Connect a phone line to your modem.
4. Connect power to your modem.
5. Connect the 9-pin end of the HP 1015A cable to the modem adapter.
6. Connect the 10-pin end of the HP 1015A cable to the serial connector on your palmtop. *Make sure the HP logo faces up when you insert it.*
7. Test your connection by typing at **[ENTER]**. The response should be OK.

Connecting to a card modem

Caution Attempts to use an incompatible modem card may result in data loss. Before attempting to use a specific modem card,

- **In the U.S.:** Call (970) 392-1001 for a current list of compatible modems.
- **In other countries:** Check with your HP dealer to ensure that a specific modem is compatible.

An important difference between a serial modem and a card modem used with the palmtop is the way the ports to which they connect receive their port definitions. A serial modem plugs into a port that is hard-wired as Com1. A card modem plugs into a port that normally serves as drive A. For this plug-in slot to serve as Com2, a special TSR (Terminate and Stay Resident) program, CIC100, configures the slot and the just-inserted card modem as Com2.

The CIC100 program is built in your palmtop, and it is installed by default as a TSR program.

Using a Card Modem in the Plug-In Slot

When insert a modem card into the plug-in slot, CIC100 will sense that a modem card has been inserted and will configure both card and slot as Com2. When the card modem is removed, CIC100 will sense that change also, and will redefine the slot for memory cards.

Be aware that if you're running your communication program from the DOS prompt, you'll need to reconfigure the card modem by restarting the communication program *whenever power turns off and then returns during a communication session*.

About Batteries and Card Modems

Card modems often have relatively high power requirements—even when they're plugged in but *not* in use—so using one when your palmtop is being powered by the batteries would likely drain the batteries very quickly.

- Try to use your AC adapter to power your palmtop whenever a card modem is plugged into your palmtop.
- Remove a modem card when not in use.

Using a Printer with Your Palmtop PC

Your palmtop has a built-in serial connector that enables you to connect and use a serial printer.

Equipment You Need

- Your palmtop and a serial printer.
- The HP F1015A serial cable for IBM and IBM-compatible computers. This cable is also available as part of the HP F1021 Connectivity Pack.
- A serial printer adapter. (Available in the HP F1021 Connectivity Pack and in the HP F1023 Connector/Adapter Kit—the printer adapter is the *white* adapter in the set. A serial-printer adapter may also come with your serial printer.)

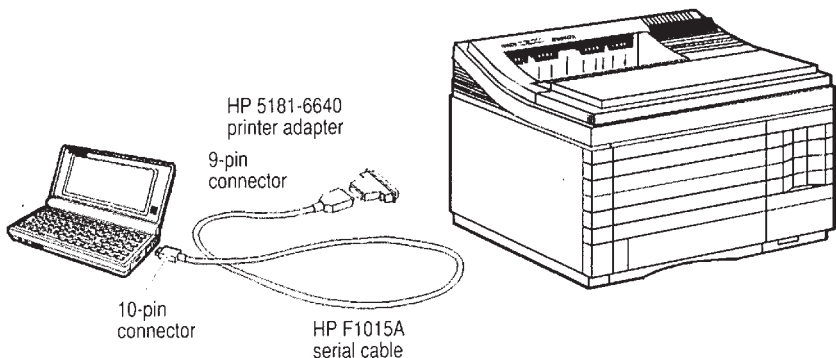

Preparing to Print Using Serial Connection

1. Set up your serial printer to be compatible with the Epson FX-80, HP LaserJet, or IBM Proprinter. You also may need to set switches on the printer to select 8-bit data length, 1 stop bit, no parity, and XON/XOFF software handshaking—see the printer manual for information.
2. On the palmtop press  **S** **MENU** **O** **P**
3. Select Baud Rate, Interface and your choice of printer.
4. Press **F10**.
5. Connect the serial cable to the palmtop's serial port. Make sure the HP logo faces up when you insert the 10-pin end.
6. Attach the HP 5181-6640 white printer adapter to the 9-pin connector of the cable and connect the adapter's other side to your printer.

After you set the configuration in step 3 above, you can optionally save that configuration in a file by pressing **F8** (Save As). Use **F7** (Open) to open a previously saved configuration file.

Preparing to Print Using Infrared

1. On the palmtop PC, press  **S** **MENU** **O** **P**.
2. Select baud rate that matches your infrared receiver device on the printer.
3. Select infrared interface.
4. Select the printer driver that matches your printer.
5. Press **F10**.
6. Point the HP 200LX infrared window towards the printer infrared port.

Printing

Once your printer and palmtop are properly configured and connected, you're ready to print.

- For Lotus 1-2-3, configure your printer set-up and print files from your palmtop just like you would print 1-2-3 files from your desktop PC.
- For the other built-in applications, you use the File Print command (press **MENU** **F** **P**). The printing interface varies a little between applications, but is usually self-explanatory. If you need help after pressing **MENU** **F** **P**, press **F1** (Help) to see a description of the print options and procedures.

Printing from PIM Applications

You can print PIM items (from Appointment Book, Phone Book, Database, World Time, and Note Taker) one at a time or in groups. There are two **styles** of print-out:

- **List Style:** a simple list of entries.
- **Custom Style:** all the fields (or the ones you choose) of each record. You can customize this using Smart Clip.

Name	Business	Home
Blascow, Stan	(812) 555-0987	(812) 555-6543
Bvett, Eric	700-1111	701-0000
Gilbert, Jean	800-1234	800-4321
Grouch, Oscar	(800) 123-4567	(800) 123-1234
Gryc, Andy	(416) 700-7634	(416) 555-7634
Harding, John W.	700-0811	710-0000
Johnson, Bill	700-2127	700-1272
Kaser, Everett	(206) 555-5676	(206) 555-0123
Megowan, Pat	(212) 555-8761	(212) 555-8866
Roy, Diana	555-0987	(311) 555-6543
Wechsler, Susan	800-5457	800-0000
Winter, Lynn	900-5538	900-0001

Phone Book Printed in List Style, All Items

To print items in a list (List Style):

The procedure varies for Appointment Book items.

1. Display the appropriate application and, if necessary, the appropriate file and subset. You can print from the currently displayed subset or list only.
2. Display the list of items (records) that you want to print or print from. Select the desired items (highlight, all of the items in the current application.
3. Press (File Print).
4. In the Print box, select Selected Items to print one or more records or All Items to print all records in the current list.
5. In the Style box, select List.
6. In the Print to box, select Printer.
7. Press .

Appointment date.

Title.

Today's date.

Appointments as of
Saturday January 15, 1994

Description: Meet with visiting editors

Start Date : 1/17/1994

Start Time : 11:00am

End Time : 12:00pm

Location :

[X] Alarm

Leadtime: 5

#Consecutive Days: 1

Repeat Status: None

[X] Shows in Week View

[X] Shows in Month View

Note:

Include lunch

Description: Help with computer lab

Start Date : 1/17/1994

Start Time : 2:30pm

End Time : 3:00pm

Location : Jefferson School

[X] Alarm

Leadtime: 20

#Consecutive Days: 1

Repeat Status: Weekly

[X] Shows in Week View

[X] Shows in Month View

Note:

Description: School play

Start Date : 1/17/1994

Start Time : 6:30pm

End Time : 7:30pm

Location : Highland View

[] Alarm

Leadtime:

#Consecutive Days: 1

Repeat Status: None

[X] Shows in Week View

[X] Shows in Month View

Note:

Help usher



28

Appointment Records Printed in Custom Style, All Fields

Symbols for Printed To-Do Lists

Printed Symbol	Equivalent Symbol	Meaning
#	✓	Completed item (checked off).
!	!	Item due today (and not yet checked off).
>	☀	Item new today (its first occurrence).
<	☾	Item past-due (and not yet checked off).
+	☐	Item includes Note.

To print records (details) of items (Custom Style):

1. Prepare to print as in the previous two procedures for items or appointments. Only the Style box will be different.
2. In the Style box, select (arrow to) Custom.
3. To print each record on its own page, tab to and check "1 item per page".
4. Tab to the list box to select the fields to print for each record. The choices are from the current Smart Clip list. Press  to scroll through the list. To print a complete record, select All Fields.
5. When done, press .

To add Custom field choices:

The Custom list box has one or more built-in field choices, such as All Fields and Business Phone in the Phone Book application. These are actually Smart Clip definitions. You can add more Custom field choices for printing by creating new Smart Clip definitions for a particular application. Refer to "Smart Clip: Copying Multiple Data Fields from Multiple Records," page 1-28.

Printing to a File (Creating an ASCII Data File)

Printing to a file ( File Print) creates an ASCII version of the palmtop PIM information and saves it in a file. (This does not apply to the Memo Editor.) The ASCII file can then be interpreted by other editing software besides the original application. You can insert this ASCII file into any other file, or transfer it to another computer for printing or editing.

28

Setting Up Printing Information (Setup)

Use  File Print Setup (   ) to specify:

- How much printing should appear on a page: Page Length, Top Margin, Bottom Margin.
- Starting and/or ending the print-out with special information in initialization and/or termination strings of up to 128 characters each. The exact codes and meanings of these printer-control sequences depend on the printer.

cc:Mail

About cc:Mail

cc:Mail is an electronic mail (e-mail) program that enables you to send and receive messages on an HP 200LX. The design of cc:Mail is based on a common metaphor—paper mail. Your “mail” can be text, graphics, files, or even facsimiles, and you can send it through your local “post office” to any cc:Mail user in the world.

What You Need to Make It Work

- An HP 200LX.
- A modem for your HP 200LX.
- A home post office maintained by your department or company. (Your Post Office is managed by your **Post Office Administrator**, who is your local cc:Mail expert.) To set up a cc:Mail Post Office, contact cc:Mail, below.

For information and technical support on the Post Office, contact:

cc:Mail, A Division of Lotus
2141 Landings Drive
Mountain View, CA 94043
Phone: 800-448-2500
FAX: 415/960-0840

For information and technical support on the cc:Mail software in the HP 200LX, contact Hewlett-Packard (see the inside back cover).

Starting cc:Mail the First Time

Before you use cc:Mail, you must fill out the Connect Settings dialog box. Press **[Alt]** **[I]** to start cc:Mail, and then press **[MENU]** **[C]** **[S]**.

Host:	cc:Mail	Modem File:	D:_DAT\HAYES.
Prefix:	CCMAIL	Modem Volume:	Medium
Post Office:	Silver-HQ	Phone Number:	555-1212
User Name:	?	Dial Mode:	Tone
Password:	?	Dial Timeout:	60 Seconds
Baud:	2400	Idle Timeout:	5 Minutes
Interface:	COM1	Manual Dial:	No
Flow Control:	Hardware	Max Msg Size:	0 Bytes

[Add Host] **[Delete]** **[Update]** **[Cancel]**

Help Add Delete Update Cancel

Connect Settings Dialog Box

Use **[TAB]** to move among the fields and type in the text boxes and use **[v]** in the scroll boxes. If you need help filling in the fields, press **[F1]** for help or see your Post Office Administrator.

With the correct Connect Settings, you have two types of connections to your Post Office:

- **Batch Transfer**, which is an intermittent connection to your Post Office that you control. All cc:Mail Post Offices allow this type of connection. Whenever you connect in this way, you automatically receive any messages waiting for you at your Post Office and send any messages you've written. As soon as the two-way transfer is complete, the connection is cut.
- **Interactive Connection**, which is a continuous connection to your Post Office that you can make if your Post Office meets certain conditions—ask your Post Office Administrator.

Most procedures in this chapter describe batch transfers. Interactive Connections are covered at the end of the chapter.

Receiving and Reading Messages

If you have messages waiting for you at the Post Office, connect a modem to your HP 200LX and you're ready to receive and read your messages.

To receive and read a message:

1. In cc:Mail, press **F10** to display the Connect dialog box. The Connect to Host scroll box shows cc:Mail, unless you've changed the default host name.

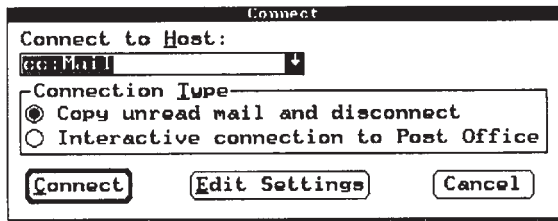

Connect Dialog Box

2. If it's not selected, tab to the Connection Type field and select Copy unread mail and disconnect for a batch transfer.
3. Press **ENTER**. At this point you automatically connect to the specified Post Office, send messages ready to be sent, receive messages waiting to be read, and then disconnect from the Post Office.
4. Press any key to display a summary of the messages received. An asterisk (*) tells you a message has not been read.
5. Highlight a message to read and press **ENTER**.
6. When you're finished, press **F8** or **F9** to read the previous or next message, or press **ESC** to return to the In Box.

Replying to Messages

To reply to a message:

1. Display the message you want to reply to (highlight it, press **ENTER**).
2. Press **F6** (Reply).
3. Fill out the Reply dialog box by checking/unchecking desired boxes. (Press **F1** if you need help.)
4. Press **F10**.
5. Tab to the message field and type your reply.
6. Press **F5**.
7. Fill out the Send Message dialog box and press **ENTER**.
8. Press **F10** and Connect to the host for a batch transfer (select Copy unread mail and disconnect).

You forward a message in a similar way. Use **F7** (Forward) when the message is displayed.

Creating and Sending Messages

To create and send a message:

1. From cc:Mail, press **F4** to display the Create Message form.
2. Address the message by typing the person's cc:Mail name. You can type more than one name by separating names by a comma. (Additional addressing options are described later in this chapter.)
3. Tab to the cc: and bcc: fields, if you want, and enter names in these fields.
4. Tab to **Subject:** and type an optional subject.
5. Tab to the first line of the message field and type your message. cc:Mail uses the same text editor as the Note Taker (see chapter 8).
6. Press **F5** to display the Send Message dialog box.
7. Press **ENTER** to accept both Save and Mail. A copy of your message will be saved in the Saved Message Folder and the original will be sent to your Outbox, waiting to be sent to your Post Office during a Batch Transfer.

8. Press **F10** to display the Connect dialog box. The Connection Type option box should have Copy unread mail and disconnect (Batch Transfer) selected.
9. Press **ENTER** to start sending your message. The Connection Summary box gives you progress reports.
10. When prompted, press any key to return to your Inbox.

About Folders

There are three different HP 200LX folders provided by cc:Mail: in which you can store messages.

- **Inbox:** This folder holds messages you've received from other cc:Mail users. Once you've read a message, you can leave it in the Inbox, move it to another folder, or delete it.
- **Outbox:** When you send a message, it's temporarily held in the Outbox folder until it's transmitted to your Post Office. Once the message is transmitted, you no longer have a copy unless you specified that a copy be saved in the Saved Message folder.
- **Saved Message:** This folder holds messages that you have chosen to save during the send message procedure.

You can also create additional folders for your own use.

To move a message to another folder:

1. Display the folder containing the message you want to move.
 - For the Inbox folder, press **MENU** **V** **I** (View Inbox).
 - For another folder, press **MENU** **V** **F** (View Folders).
Highlight the folder name and press **ENTER**.
2. Highlight the message to move and press **F3** (Move).
3. Highlight the name of the destination folder or tab to the New Folder field and type in a new folder name.
4. Press **F10**. Then press **MENU** **V** **F** (View Folders) to see the name of your new folder in the folder list.

About Address Books and Mailing Lists

Types of Address Books or Lists

You have three address books and one directory available for use when you address messages. The **Remote Directory**, maintained by your Administrator, lists all those names you can address directly from your Post Office.

In the following table, **Local** means it can be used without an Interactive Connection, and **Remote** means it can be used during an Interactive Connection.

Available Address Books

Type of Address Book	When Used		Where Located	Who Maintains
	Local	Remote		
Local	X	X	HP 200LX	You
Directory		X	Post Office	Administrator
Private		X	Post Office	You
Public		X	Post Office	Administrator

To add individual names to your Local Address Book:

1. Press **[MAIL]** **[M]** **[M]** (Mail Add/Modify-Names).

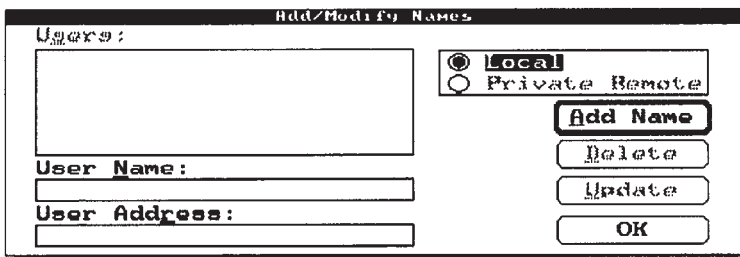

Add/Modify Names Dialog Box

2. Press **[ALT]+[N]** and type last name, first name.
3. If a mail address other than the name is needed, tab to **User Address** and type the address. Your Post Office Administrator can help you compose a correct address.

4. Press **ENTER** to copy the name to the Users list box.
5. You can enter another name and press **ENTER**.
6. Press **F10** when done adding names.

To capture a name from a piece of mail and add it to your Local Address Book:

1. Highlight a message to read and press **ENTER**.
2. Press **F2** (Capture).
3. Press **F6** (Add) to add the sender to your Local Address Book.

If the name contains the word “at”, the part before the “at” will be stored in the Name field and the entire address will be stored in the Address field in your Local Address Book.

To delete an individual’s name from your Local Address Book:

1. Press **DELU** **M** **M**.
2. Arrow to the name you want to delete in the Users list box.
3. Press **F7** **ENTER** to delete the name. If this name was also included in a mailing list, the mailing list will still contain the name.

To Automatically Update Your Local Address Book:

The cc:Mail Automatic Directory Exchange (ADE) utility enables you to update your Local Address Book using update files sent from your Post Office Administrator.

1. If you can, plug in your AC adaptor.
2. Quit cc:Mail (**DELU** **Q**).
3. Press **&...** **:** to start the ADE utility.
4. Follow the displayed instructions to either process all ADE update files in your Inbox or process a selected ADE file.

The time it takes to process an update file is directly related to the size of the update. Large updates could take several minutes to process; very large updates could conceivably take more than an hour. When you see the process-complete message, you can open cc:Mail and use your updated Local Address Book.

What is a User Address and a User Name?

When you first chose your User Name with the help of your Post Office Administrator, what you actually chose was your cc:Mail

address. This is the name your Post Office recognizes. When you complete the Add/Modify Names dialog box, you can leave the Address box blank as long as you enter User Names known by your Post Office.

When you enter a name in the User Name text box that is not known to your Post Office, you must then enter the person's official cc:Mail name in the User Address box in the Add/Modify Names dialog box. When you send your message to your Post Office, the Post Office fails to recognize the User Name, so it looks at the User Address. Since it recognizes that name, it accepts your message. If you use this method to make the User Name an "alias" for a longer address, addressing messages could be simplified.

Another use of the User Address text box is to enter a name that includes a cc:Mail Post Office name, for a person registered at another Post Office. Say that person's name is Betsey Harrington and her home Post Office name is LBCC. You would type in the User Address text box *Betsey Harrington at LBCC*. When your Post Office received a message addressed to her, it would not recognize Betsey Harrington, but it would recognize another cc:Mail Post Office name. So it would send the message to the LBCC Post Office. That Post Office would recognize Betsey Harrington as one of its own, and would accept the message.

To create mailing lists:

1. Press **NEW** **M** **L** (Mail Add/Modify-Lists).

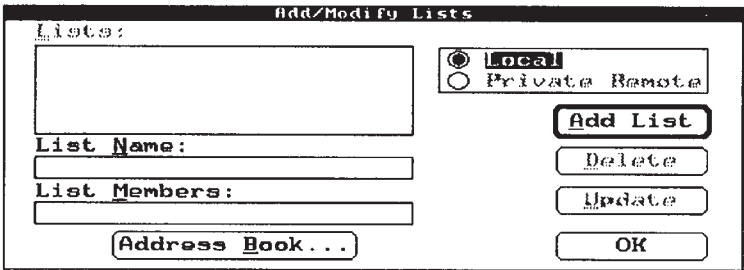

Add/Modify Lists Dialog Box

2. Select either “Local” (for your Local Address Book used for Batch Transfers) or “Private Remote” (for your Remote Address Book used during an Interactive Connection).
3. Tab to the List Name box and type a name as you would like it to appear in the list.
4. Tab to the List Members box and do one of the following:
 - Add new names to the list:
 - a. Type first names first.
 - b. Separate different members with commas.
 - c. Press **F6** (Add).
 - d. Press **F10** (OK) when done adding mailing lists.
 - Copy names from your address list:
 - a. Press **F5** (Address).
 - b. Highlight a name you want (a person or a mailing list) and press **F8** (Select).
 - c. Repeat for all names you want, then press **F10** (OK).
 - d. Press **F6** (Add).
 - e. Press **F10** (OK) when done adding mailing lists.

To delete a name from a mailing list:

- Use **DEL** carefully to delete only the characters of the name. (Use **F8** (Update) to change an existing list.)

To delete an entire mailing list:

1. In cc:Mail, press **ESC** **M** **L**.
2. Arrow to the name of the mailing list you want to delete.
3. Press **F7**.
4. Read the warning message, then either press **F9** to cancel the delete operation or press **ENTER** to delete the entire mailing list.
5. Press **F10**.

To find a name in a list (speed-locate):

- In a mailing list, just start typing a name. As each subsequent letter is typed, the highlight moves to the first matching name.

Addressing Options

When you address your message, you have two options:

- Address originals, copies (cc:), and blind copies (bcc:) of your message.
- Address your message to names of users and to mailing lists (distribution lists). When you address a message to a mailing list, the names of the individual users in that list are automatically added to your message address.

To address your message:

1. In cc:Mail:, press **CTRL** **M** **C** or press **F4** (Create).
2. In the To:, cc:, or bcc: box, do one of the following:
 - Type the cc:Mail name of a person or mailing list understood by your Post Office (a name that exists in the Post Office's Directory or in one of the three Address Books—Local, Private, or Public). Separate multiple names with commas.
 - Select an address as follows:
 - a. Press **F2**.
 - b. Press **ALT**+**letter**, where “letter” is “L”, “D”, “P”, or “U”, to select the list or directory you want.
 - c. Press **ALT**+**N**.
 - d. Highlight (use the arrow keys or just start typing) the name of the person or mailing list you want, and then press **ENTER**. Repeat to add additional names.
 - e. Press **F10**.
3. When finished addressing, you're ready to create the body of your message.

Managing Your Messages

To save a message you've just completed:

1. After completing your message, press **F5**.
2. Check the Save box and press **ENTER**. (If you check both the Save and Send boxes the message will be sent *and* saved.)

The message will be saved in your saved-messages folder. To view saved messages, press **F7** (Folders) from your Inbox.

To save a message in an MS-DOS file:

1. In either your Inbox or another folder, highlight the message you want to save.
2. Press **Alt** **F** **A**.
3. Select a path and file where your message will be saved. This can replace an existing file or create a new file.
4. Press **ENTER**.

Attachments are not saved; only the text of the message is saved in a text file format.

To copy an attached DOS file from a received message:

To copy an attached DOS file, the message to which the file is attached must be in a local folder (like your local Inbox).

1. Display the local message that contains an attached MS-DOS file. (If the message is in your Remote Inbox (Interactive Connection), move it to your Local Inbox, then display it.)
2. Press **F3**.
3. If the Attachments list box shows more than one attachment, arrow to highlight the one you want to detach.
4. Press **ENTER** or **F4** (Detach).
5. Specify a path and file name for the copy of the attached file.
6. Press **F10**.

To move or copy a message:

Note

When NOT using an Interactive Connection:

- You *cannot* move or copy a message *to* the Inbox.
 - You *cannot* copy a message *from* the Inbox, you can only move it.
-

Note

When USING an Interactive Connection:

- You *cannot* move or copy a message *to* the Inbox.
 - You can copy a message from the Inbox, *but only* to a folder within the HP 200LX.
-

1. Display a folder containing the message you want to copy or move.
2. Highlight the message you want to copy or move.
3. Press either **(F2)** (Copy) or **(F3)** (Move).
4. Do one of the following:
 - Highlight the folder to receive your message.
 - Tab to New Folder and type a name for your new folder.
5. Press **(F10)**.
6. Press **(ESC)** to display the list of folders.

To delete a message:

You can delete a message from any folder.

1. Display the folder containing the message you want to delete.
2. Highlight the message you want to delete. Press **(spacebar)** to select it and highlight another if you want to delete more than one.
3. Press **(DEL)**.

Printing in cc:Mail

See chapter 28 for information on connecting a printer.

To print a list of all the messages in a folder:

1. Display the folder with the message list you want to print.
2. Press **[Esc]** **[F]** **[P]**.
3. Highlight Print list of messages in this folder.
4. Press **[F10]**.

To print the text of selected messages in a folder:

1. Display the folder containing the messages you want to print.
2. Highlight the message you want to print. Press **[spacebar]** and highlight another if you want to print several messages at once.
3. Press **[Esc]** **[F]** **[P]**.
4. Highlight Print text of selected messages.
5. Press **[F10]**.

Importing and Attaching Files to a Message

You can **import** an MS-DOS text file to be a part of your message, or you can **attach** to your message one or more MS-DOS files of any type.

To insert (import) text files to your message:

1. Place the cursor at the point in your message text where you want the imported text file inserted.
2. Press **[F4]** (Import) and select the file to be imported.
3. Press **[F10]** (OK).

To attach MS-DOS files to your message:

You cannot attach a file to a message during an interactive connection.

1. When you have finished writing the text of your message, press **[F3]** (Attach). This shows a list of any previous attachments.
2. Press **[F3]** (Attach) to attach a new file to the message.
3. Select a file name and press **[F10]** (OK).
4. To attach another file, repeat step 2.

5. When you're finished attaching files, press **F10** (OK).

To detach an MS-DOS file from a message before sending:

If you attach a DOS file to a message, then decide you do not want to send that file with the message, follow this procedure to detach it.

1. Open the message.
2. Press **F3** (Attach).
3. Highlight the name of the file you want to detach.
4. Press **F4** (Detach) **F10** (Yes).
5. Press **F10** (OK) when done.

Changing Your Communication Settings

To change the directory that contains your mail messages:

You can change the default directory that contains your folder messages from C:_DAT\MAIL to another directory. If you change that directory, you cannot access the messages stored in C:_DAT\MAIL from the cc:Mail application. But you could access those messages by changing the directory back to C:_DAT\MAIL.

1. Press **Alt** **F** **L**.
2. Press **ENTER** to confirm your decision.
3. Type the path and directory where your new mail messages will be located.
4. Press **F10**.

To change your password:

1. Press **Alt** **C** **P**.
2. If the host you're using is not selected in the Select Host list box, arrow to the host you're using.
3. Tab to the Enter Old Password text box and type your old password. The characters will display as gray blocks.
4. Tab to the Reenter Old Password box and again type your old password.
5. Press **F10**. You'll be told that your old password was accepted.
6. Press **F10** again to display another Change Password dialog box.

7. Type your new password, press **(TAB)**, then reenter you new password.
8. Press **(F10)** to see New password accepted.
9. Press **(F10)**.

Understanding cc:Mail's Host

The group of settings identified by the host name in your Connect Settings dialog box initializes cc:Mail for your use. The default Host name is "cc:Mail." If you have several groups of settings, each group is identified by a different host name. You might want several different hosts if you use cc:Mail in different locations, requiring different Post Offices, passwords, phone numbers, etc.

Each host name and the settings each name represents are saved in the ASCII file C:_DAT\CCMAIL.INI. You can view the contents of that file from the Filer (highlight the file name, then press **(F8)**).

Understanding cc:Mail's Prefix

The name of your local Outbox is given by cc:Mail's Prefix. Your current Prefix is displayed when you press **(F8)** **(C)** **(S)** and, if necessary, select the host name you want. Your default Prefix (the name of your default Outbox) is "CCMAIL".

Your Outbox contains the messages to be transmitted to your local Post Office during a Batch Transfer. If you worked for some weeks in a location served by Post Office A and at other times worked in Post Office B's area, you would want two different Outboxes (two different Prefixes); call them A and B. When not using an Interactive Connection, you would want to send your messages to Outbox (Prefix) A when in Post Office's A area, and to Outbox B when in Post Office B's area. To avoid updating your Connect Settings each time you moved between A and B, you could define two different Hosts, one containing Prefix A, the other Prefix B. Before creating messages, you would specify Host A or B depending on your location (A or B). Then when the connection was made, messages in the specified outbox would be sent.

To modify your Host (your current set of Connect Settings):

1. Press **(F8)** **(C)** **(S)**.

2. Arrow to the name of the Host whose setting you want to change.
3. Press **F10**.
4. Change the settings as desired. **NOTE:** When entering a new file name for your Modem File, type the entire path and name, like `D:_DAT\HAYES.MDM`.
5. To save your new settings under the **present Host name**, press **ENTER**.

To create a new Host (a new set of Connect Settings):

1. Press **MENU** **C** **S**.
2. If possible, arrow to the name of the Host whose settings are closest to those of your new Host and press **F10**.
3. Type the new Host name in the Host text box.
4. Change any settings as desired. **NOTE:** When entering a new file name for your Modem File, type the entire path and name, like `D:_DAT\HAYES.MDM`.
5. To save your new settings under your **new Host name**, press **F6** (Add).

To delete a host:

1. Press **MENU** **C** **S**.
2. Arrow to the name of the Host you want to delete.
3. Press **F10**.
4. Press **F7**.
5. Press **ENTER**.

Creating Another Modem File

If your modem does not work satisfactorily using the supplied modem file (`D:_DAT\HAYES.MDM`), you can create a new modem file.

To create a new modem file:

This procedure shows you how to modify the supplied modem file and to specify that modified file in your Create Settings dialog box. Use your modem manual as a source of information. See also chapter 27, "Using a Modem with the HP 200LX."

1. In the Memo Editor (press **MEMO**), press **MEMO** **F** **O**.
2. Type `d:_dat\hayes.mdm` and press **F10** to display the contents of the default modem file.

3. Change the text following the first line `MODEM=` to the name of your modem.
4. Continue editing this file as necessary to show the commands required by your modem.
5. Press **ESC** **F** **A**.
6. Type a file name as `C:_DATA\filename.MEM`, where *filename* is a name you supply.
7. Press **F10** to save your new modem file.
8. Enter the name of your new modem file into the Connect Settings dialog box.

Except for backslash (\) and circumflex (^), the modem commands you enter are sent to the modem without change. The two exceptions are described as follows:

- **Backslash:** The \ character is used to specify an 8-bit value. The three characters immediately following \ must be characters between 0 and 7, and together they are treated as a 3-digit octal integer. For example, \015 is treated as octal 15, decimal 13, hex 0D, and is equivalent to the carriage return character.

There are two exceptions to the 4-character backslash sequence:

- The actual backslash character is represented by \\.
 - The actual circumflex character is represented by \^.

- **Circumflex:** The ^ character is used to specify commonly used values, such as ^M, which becomes the carriage return character.

Examples of \ and ^ in a Modem Command Line

Command	What's Sent	Comment
ATZ	ATZ	No special characters used.
AT\132	ATZ	132 is octal for Z.
AT\\Q3	AT\Q3	\\ is used for \.
AT\^B1	AT^B1	\^ is used for ^.
AT^M	AT	^M = carriage return.
AT\\N0\\Q3	AT\N0\Q3	\\ is used twice here.
AT\134N0\134Q3	AT\N0\Q3	\134 is used instead of \\.

Using an Interactive Connection to the Post Office

While connected interactively to your Post Office, you have direct access to your Post Office Inbox, the Public List of mailing lists, your Private List of mailing lists, and the Post Office's Directory of names (which contains the names of all users you can address directly).

Most cc:Mail procedures are the same whether you intend to connect to the Post Office via a batch transfer or an interactive connection. Here are some procedures specific to interactive connections.

To open an Interactive Connection:

1. With a modem connected to your HP 200LX and cc:Mail open, press **[CTRL]** **[C]** **[C]** or **[F10]**.
2. Press **[TAB]** and arrow to Interactive Connection to Post Office.
3. Press **[ENTER]** to initiate the connection. It will take some seconds to complete the connection.

Note

When an Interactive Connection is active, you can open and use other applications without breaking the cc:Mail connection, provided you do not attempt to make another connection from another application.

To close an Interactive Connection:

1. In cc:Mail, press **[CTRL]** **[C]** **[D]** or press **[F10]**.
2. Press **[ENTER]**.

To read a new message when using an Interactive Connection:

1. If your Remote Inbox is not displayed after you open an Interactive Connection, press **[F6]**. Then, if necessary, press **[F7]** (Inbox).
2. Arrow to the message you want to read and press **[ENTER]**. It will take some seconds for the message to display, depending on the length of the message and the baud rate.

To view selected messages during an Interactive Connection:

When you first use your HP 200LX during an Interactive Connection and view the contents of the Inbox or another folder using one of the **VIEW** choices, all the messages in that folder are displayed. This procedure allows you to restrict the messages you view in the Inbox to meet certain criteria.

1. In cc:Mail, press **RETURN** **C** **R**, then do one of the following:
 - To restrict a message list to only unread messages, select **Unread Messages**.
 - To restrict a message list to only messages with a particular subject, arrow to **Messages Re:**, then press **TAB** and type the subject. The subject you type is case insensitive.
 - To restrict a message list to those from a particular person, arrow to **Messages From:**, then press **TAB** and type the person's name.
 - To restrict a message list to those written during a certain date range, arrow to **Message Date:**, press **TAB** and type the first date in the current format (see the upper-right corner of your display), then press **TAB** and type the last date in the range. To receive only messages sent on a single date, make both dates the same.
 - To cancel all message list restrictions, arrow to **All Messages**.
2. Press **F10**.

Using LapLink Remote Access

LapLink® Remote Access provides a **redirector** connection between two computers. In a redirector connection, you access the disk drives on one computer (the **server**) through additional drive letters on another computer (the **client**). For example, drives E and F on your desktop PC (the client) could be mapped to drives A and C on your palmtop. This makes copying, merging, or otherwise manipulating files between your palmtop and another computer quick and easy.

What You Need to Make It Work

To use LapLink Remote Access in the palmtop, most users will need the Connectivity Pack running on their PCs. The Connectivity Pack contains the software, cable, adapters, and instructions for making it work.

However, LapLink Remote Access in the palmtop also works with HP OmniBook computers, which have LapLink Remote built in, and with any PC running the CommWorks™ LapLink Remote Access product from Traveling Software, Inc. To connect with those products, users need to use an infrared connection or a serial connection (requiring the HP 1015A Serial Interface Cable). See the manuals that come with those products for instructions.

Running LapLink Remote Access on Your Palmtop

Press **[&...]** **[R]** to start LapLink Remote Access on your palmtop. Here is the status screen you'll see:

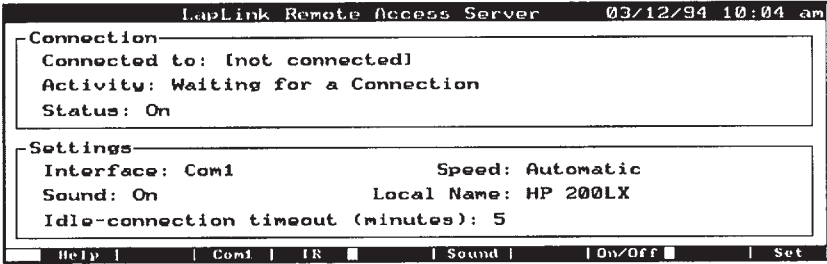

The default settings should work without modification for most PCs running the Connectivity Pack. See the Connectivity Pack user's guide for more setup instructions.

If you need to change settings not found on the function keys, use **[F10]** (Set). Use **[F1]** (Help) if you need descriptions of any fields.

About Server Mode. When you start LapLink Remote Access by pressing **[&...]** **[R]**, the palmtop can only be a *server*. This means that *all commands and file manipulations must be done from the other PC*.

30

The Connectivity Pack contains much more information on how to use LapLink Remote Access with your palmtop.

Part 7

Appendixes and Index

Warranty, Support, and Service

Limited One-Year Warranty

What Is Covered

Your HP palmtop PC (except for the batteries, or damage caused by the batteries) and accessories are warranted by Hewlett-Packard against defects in materials and workmanship for one year from the date of original purchase. If you sell your unit or give it as a gift, the warranty is automatically transferred to the new owner and remains in effect for the original one-year period. During the warranty period, we will repair or, at our option, replace at no charge a product that proves to be defective, provided you return the product, shipping prepaid, to a Hewlett-Packard service center. (Replacement may be made with a new or reconditioned product, or with a newer model of equal or better functionality.)

This warranty gives you specific legal rights, and you may also have other rights that vary from state to state, province to province, or country to country.

What Is Not Covered

Batteries, and damage caused by the batteries, are not covered by the Hewlett-Packard warranty. Check with the battery manufacturer about battery and battery leakage warranties.

This warranty does not apply if the product has been damaged by accident or misuse or as the result of service or modification by other than an authorized Hewlett-Packard service center.

No other express warranty is given. The repair or replacement of a product is your exclusive remedy. **ANY OTHER IMPLIED WARRANTY OF MERCHANTABILITY OR FITNESS**

IS LIMITED TO THE ONE-YEAR DURATION OF THIS WRITTEN WARRANTY. Some states, provinces, or countries do not allow limitations on how long an implied warranty lasts, so the above limitation may not apply to you. **IN NO EVENT SHALL HEWLETT-PACKARD COMPANY BE LIABLE FOR CONSEQUENTIAL DAMAGES.** Some states, provinces, or countries do not allow the exclusion or limitation of incidental or consequential damages, so the above limitation or exclusion may not apply to you.

Products are sold on the basis of specifications applicable at the time of manufacture. Hewlett-Packard shall have no obligation to modify or update products, once sold.

Consumer Transactions in Australia and the United Kingdom

The above disclaimers and limitations shall not apply to consumer transactions in Australia and the United Kingdom and shall not affect the statutory rights of consumers.

Customer support

If you have questions that this *User's Guide* doesn't answer (after checking the contents and index), you can contact Hewlett-Packard's Worldwide Support and Services for Handheld Products at the telephone numbers on the card, "Contacting Hewlett-Packard Worldwide", which is included in the product box.

If Your Palmtop Requires Service

Contact Hewlett-Packard for service information, shipping instructions, and out-of-warranty service charges *before* you send your unit in for repair.

For diagnostic instructions and other service information, contact one of the technical support numbers listed on the back of the card, "Contacting Hewlett-Packard Worldwide". *Do not ship the unit for service without first contacting a Hewlett-Packard office.* If your unit qualifies for in-warranty service, be ready to supply a dated proof of purchase.

In countries not listed on the card, contact your Hewlett-Packard authorized dealer or sales office.

HP Marketing Headquarters Outside the U.S.

Should you need to contact Hewlett-Packard, check your local telephone directory for the HP Sales and Service Office near you. If you cannot locate an HP office, contact one of the Worldwide HP Marketing Headquarters listed here.

ASIA

Far East Sales Region Hdqtrs
Hewlett-Packard Asia Ltd.
22nd Floor West Tower,
Bond Centre GPO Box 863
Hong Kong

LATIN AMERICA

Hewlett-Packard Latin Am.
Hdqtrs Monte Pelvoux 111
Lomas de Chapultepec 11000
Mexico D.F.

EUROPE

European Operations Hdqtrs
Hewlett-Packard S.A.
150, route du Nant-d'Avril
P.O. Box CH 1217 Meyrin 2
Geneva, Switzerland

OTHER AREAS

Intercon Operations Hdqtrs
Hewlett-Packard Company
3495 Deer Creek Road
P.O. Box 10495 Palo Alto,
CA 94303-0896 USA

Batteries and Environmental Limits

When to Replace Batteries

When you see a low-battery message in the display, *replace the indicated batteries as soon as possible*. If the display beeps and turns off immediately after you turn it on, replace the main batteries.

The backup battery, which prevents data loss when the main batteries are dead or out of the unit, should be changed a year after it's installed even if a low backup-battery message doesn't appear.

Battery Types and Battery Life

Main Battery Type. Any brand of 1.5-volt, size AA Alkaline batteries or Nickel-Cadmium rechargeable batteries.

Backup Battery Type. 3-volt CR2032 lithium coin cell. If fresh main batteries are maintained, the backup battery should last a year before you replace it.

The battery life you get with your palmtop depends on

- The type and quality of batteries you use.
- How you use your palmtop. (Things like IR and serial communications, modems, and flash-disk memory cards all require higher current and therefore drain your batteries faster.)
- Whether you use the AC adapter.

For typical use without the AC adapter, fresh Alkaline batteries should last from 2 to 8 weeks. Rechargeable batteries used without the AC adapter will get less life than Alkalines—how much less depends on the quality of the Nickel-Cadmium rechargeable batteries you use.

The best way to extend battery life is to use the AC adapter whenever possible.

Removing and Installing Batteries

Caution

Do not remove the main batteries if the backup battery is dead—complete memory loss will result. Replace the backup battery first in this case.

Warning

Do not mutilate, puncture, or dispose of batteries in fire. The batteries can burst or explode, releasing hazardous chemicals. Replace batteries with only the types recommended in this manual. Discard used batteries according to the manufacturer's instructions. The back-up (lithium) battery can explode if it is inserted incorrectly.

Varning

Explosionsfara vid felaktigt batteribyte. Använd samma batterityp eller en ekvivalent typ som rekommenderas av apparattillverkaren. Kassera använt batteri enligt fabrikantens instruktion.

Advarsel

Eksplosionsfare ved fejlagtig handling. Udskiftning må kun ske med batteri af samme fabrikat og type. Lever det brugte batteri tilbage til leverandoren.



Bij dit produkt zijn batterijen geleverd. Wanneer deze leeg zijn, moet u ze niet weggooien maar inleveren als KCA.

To change the main batteries:

1. Close all open applications before changing batteries.
2. **Important:** Turn your palmtop off and close the case.

B-2 Batteries and Environmental Limits

3. Remove the battery cover and old batteries.

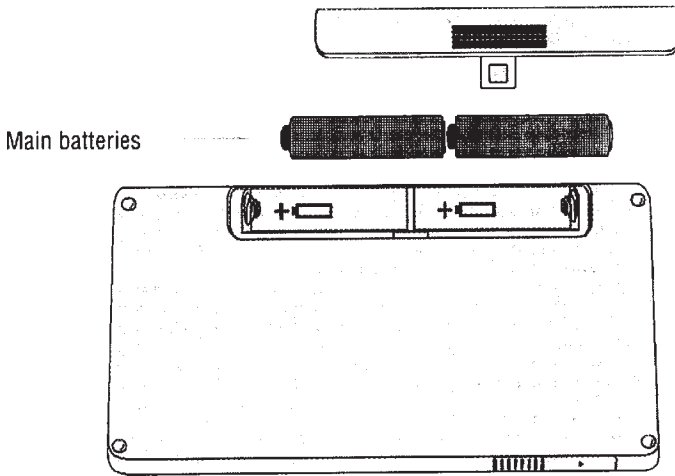

4. Install two fresh AA batteries, orienting them as shown by the symbols in the battery compartment.
5. Replace the cover and turn your palmtop on. If the palmtop won't turn on after you replace the batteries, go back over the procedure and check the orientation of the batteries as shown in step 3—you may have put the batteries in backwards.
6. If you replaced rechargeable batteries (either with Alkalines or another set of Nickel-Cadmium rechargeables) be sure to go into Setup and set or verify your battery type and charging setting. (Battery charging is automatically disabled whenever you remove rechargeable batteries.)

To change the backup battery:

Caution

Do not remove both the main batteries and the backup battery at the same time—complete memory loss will result.

1. **Important:** Turn the palmtop off.

2. Remove the backup-battery cover and pull out the battery tray.

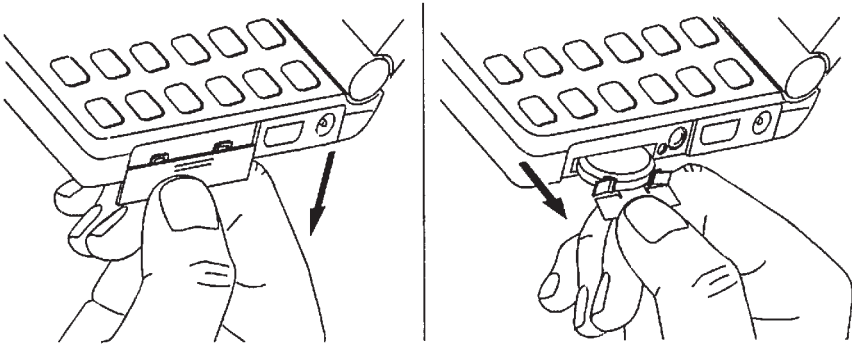

3. Remove the old battery from the tray and insert a fresh, 3-volt CR2032 coin cell. *Be sure the “+” on the battery is facing down in the tray.*
4. Insert the battery tray back into the palmtop and replace the cover.
5. Turn the palmtop on. If the battery-low message is still present in the display, go back over the procedure and check the battery orientation as shown in step 3—you may have put the battery in the tray upside down.

Rechargeable Batteries

If you use the HP F1011A adapter, you can recharge rechargeable batteries while they're inside the palmtop.

Warning

The palmtop recharging system was designed to operate only with Nickel-Cadmium rechargeable batteries. Because of potential hazards, we recommend that you do not recharge other types of rechargeable batteries in the palmtop.

B

To charge rechargeable batteries inside the palmtop:

1. Connect the HP F1011A adapter to the palmtop and a power outlet.
2. Press **[F10]** **[S]** to start the Setup utility.
3. Press **[MENU]** **[O]** **[B]** to select the Battery Type dialog box.
4. Use **[V]** to select the Nickel-Cadmium battery type.
5. Tab to the recharging field and press **[spacebar]** to select it.

Caution Charging should be enabled only for Nickel-Cadmium rechargeable batteries. If you select it when Alkaline batteries are installed, permanent damage to your palmtop could result.

6. Press **[F10]**. Now the batteries will be charged whenever the adapter is plugged in. **The palmtop display will stay on whenever it is recharging.**

If you take out your rechargeable batteries, battery charging is automatically disabled. *It's good practice to go into Setup and verify your battery type and charging setting whenever you change batteries.*

Most Nickel-Cadmium rechargeable batteries will recharge in about 8 to 12 hours. Here are the charging rates in the palmtop:

Continuous Charge Rates

Time	Rate of Charging
The first 6 hours	100 mA
After 6 hours	45 mA

AC Adapter Information

Because of special palmtop power requirements, you need to use the HP F1011A adapter. This adapter is a regulated AC to DC converter with these specifications:

DC Power Supply Output Specifications

Polarity:	Negative (center contact on adapter is ground, outer contact is positive)
Minimum voltage:	+9.6 V
Nominal voltage:	+12 V
Maximum voltage:	+14.4 V
Minimum current:	750 mA

Using this adapter whenever possible significantly extends battery life because the palmtop doesn't use battery power while the adapter is plugged in.

Also, the adapter can be used to recharge Nickel-Cadmium rechargeable batteries. See page B-4 for information, including the charge rate for the adapter.

Environmental Limits for Your Palmtop and Plug-In Cards

To maintain product reliability, avoid getting the equipment wet and observe the following temperature and humidity limits for the palmtop and Hewlett-Packard plug-in cards:

- Operating temperature: 0° to 50°C (32° to 122°F).
- Storage temperature with data retention: 0° to 60°C (32° to 140°F).
- Operating and storage humidity: 90% relative humidity at 40°C (104°F) maximum.

You will likely lose data below 0°C (32°F), but you can have storage temperatures down to -20°C (-4°F) without damaging the hardware.

B

Character Set

This appendix contains tables defining your palmtop character set as well as instructions for generating special characters.

Your palmtop supports code pages 850 and 437.

- The built-in applications (except 1-2-3) and System-Manager-compliant applications (see chapter 24 for a description) use code page 850.
- 1-2-3 uses LICS, the Lotus International Character Set. Most LICS characters are included in code page 850; the few that are not included will not display on the palmtop.
- Any DOS applications you load and run will by default use code page 437. If an application requires code page 850, you can select it using the Setup Utility (see chapter 21).

Character Set Tables

The following two pages contain the 437 and 850 code-page tables.

437 English

0	32	64 @	96 '	128 Ç	160 á	192 L	224 α
1 ☺	33	65 A	97 a	129 ū	161 í	193 ⊥	225 β
2 ●	34 "	66 B	98 b	130 é	162 ó	194 T	226 Γ
3 ♥	35 #	67 C	99 c	131 â	163 ú	195	227 Π
4 ♦	36 \$	68 D	100 d	132 ä	164 ñ	196 -	228 Σ
5 ♣	37 %	69 E	101 e	133 à	165 Ñ	197 +	229 σ
6 ♠	38 &	70 F	102 f	134 á	166 ¢	198	230 μ
7 •	39 '	71 G	103 g	135 ç	167 ¢	199	231 γ
8 ■	40 (72 H	104 h	136 ê	168 ĵ	200 ll	232 Φ
9 ◦	41)	73 I	105 i	137 ë	169 ▭	201 ▭	233 Θ
10 ■	42 *	74 J	106 j	138 è	170 ▭	202 ±	234 Ω
11 ♂	43 +	75 K	107 k	139 ĩ	171 1/2	203 ∓	235 δ
12 ♀	44 ,	76 L	108 l	140 í	172 1/4	204	236 ∞
13 ♪	45 -	77 M	109 m	141 ì	173	205 =	237 Ø
14 ♫	46 .	78 N	110 n	142 Ä	174 <	206 †	238 €
15 ✱	47 /	79 O	111 o	143 Å	175 >	207 ±	239 ∩
16 ►	48 0	80 P	112 p	144 É	176 ▨	208 ±	240 ≡
17 ◄	49 1	81 Q	113 q	145 æ	177 ▨	209 ∓	241 ±
18 ⇕	50 2	82 R	114 r	146 Æ	178 ■	210 ∓	242 ≥
19	51 3	83 S	115 s	147 ô	179	211 ll	243 ≤
20 ¶	52 4	84 T	116 t	148 õ	180	212 ll	244 ∫
21 §	53 5	85 U	117 u	149 ò	181	213 ∫	245 J
22 ≡	54 6	86 V	118 v	150 ù	182	214	246 +
23 ⇕	55 7	87 W	119 w	151 ù	183 ∓	215 †	247 ≈
24 ↑	56 8	88 X	120 x	152 ŷ	184 ∓	216 †	248 °
25 ↓	57 9	89 Y	121 y	153 Ö	185 ∓	217 J	249 .
26 →	58 :	90 Z	122 z	154 Ü	186	218 ∫	250 •
27 ←	59 ;	91 [123 {	155 ø	187 ∓	219 ■	251 √
28 ⊥	60 <	92 \	124	156 £	188 ∓	220 ■	252 π
29 ↔	61 =	93]	125 }	157 ¥	189 ∓	221 ■	253 ²
30 ▲	62 >	94 ^	126 ~	158 Pt	190 ∓	222 ■	254 ■
31 ▼	63 ?	95 _	127 □	159 f	191 ∓	223 ■	255

C

850 Multilingual (Latin I)

0	32	64 @	96	128 Ç	160 á	192 L	224 Ó
1 ☺	33	65 A	97 a	129 ū	161 í	193 l	225 ß
2 ●	34 "	66 B	98 b	130 é	162 ó	194 T	226 Ô
3 ♥	35 #	67 C	99 c	131 â	163 ú	195 †	227 Ò
4 ♦	36 \$	68 D	100 d	132 ä	164 ñ	196 -	228 õ
5 ♣	37 %	69 E	101 e	133 à	165 Ñ	197 +	229 Ö
6 ♠	38 &	70 F	102 f	134 á	166 ª	198 ã	230 m
7 •	39 '	71 G	103 g	135 ç	167 º	199 Ã	231 þ
8 ■	40 (72 H	104 h	136 ê	168 ç	200 L	232 Þ
9 ◦	41)	73 I	105 i	137 ë	169 ®	201 F	233 Ú
10 ■	42 *	74 J	106 j	138 è	170 ◡	202 ≡	234 Û
11 ♂	43 +	75 K	107 k	139 ï	171 1/2	203 ™	235 Ù
12 ♀	44 ,	76 L	108 l	140 î	172 1/4	204 †	236 ý
13 ♪	45 -	77 M	109 m	141 ï	173 j	205 =	237 Ý
14 ♫	46 .	78 N	110 n	142 Æ	174 «	206 †	238 -
15 ✱	47 /	79 O	111 o	143 Å	175 »	207 ☒	239 ´
16 ►	48 0	80 P	112 p	144 É	176	208 δ	240 -
17 ◄	49 1	81 Q	113 q	145 æ	177	209 Ð	241 ±
18 ⇕	50 2	82 R	114 r	146 Æ	178	210 Ê	242 =
19	51 3	83 S	115 s	147 ð	179	211 Ë	243 3/4
20 ¶	52 4	84 T	116 t	148 ð	180	212 È	244 ¶
21 §	53 5	85 U	117 u	149 ò	181 Á	213 i	245 §
22 ■	54 6	86 V	118 v	150 ò	182 Â	214 í	246 ÷
23 ⇕	55 7	87 W	119 w	151 ù	183 À	215 î	247 -
24 ↑	56 8	88 X	120 x	152 ý	184 ©	216 ĩ	248 °
25 ↓	57 9	89 Y	121 y	153 Ò	185 †	217 J	249 -
26 →	58 :	90 Z	122 z	154 Û	186	218 Γ	250 •
27 ←	59 ;	91 [123 {	155 ø	187 ¶	219 ■	251 i
28 L	60 <	92 \	124	156 £	188 ¶	220 ■	252 ³
29 ↔	61 =	93]	125 }	157 Ø	189 ¢	221 i	253 ²
30 ▲	62 >	94 ^	126 ~	158 ×	190 ¥	222 ì	254 ■
31 ▼	63 ?	95 _	127 ☐	159 f	191 ◡	223 ■	255

C

Generating Special Characters

There are two primary ways to generate special characters:

- By holding down **ALT**, then holding down **DE/101**, and then typing a character code. For example, in the code-page 850 table on the previous page you can see that the character code for the ® symbol is 169. So, to generate ® on your palmtop, you would press and hold down **ALT**, press and hold down **DE/101**, and then type 169.
- By pressing **Fn** and then another key. For example, pressing **Fn** **Q** generates £. Many, but not all special characters in the palmtop character set can be generated this way. Here is the keyboard with those available for code-page 850:

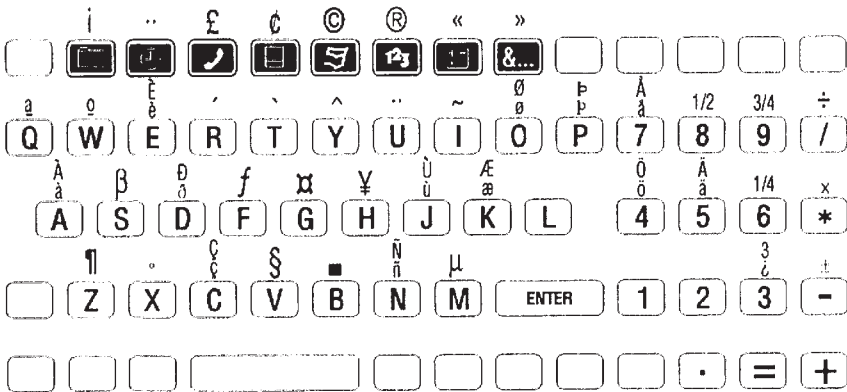

Note that a few keys have shifted **Fn** definitions in addition to regular **Fn** definitions. For example, pressing **Fn** **5** generates ä, while pressing **Fn** **5** generates Å.

Generating Accented Characters. The keys **R**, **T**, **Y**, **U**, and **I** represent accent marks when used with the **Fn** key. When you press one of these keys, it prepares the palmtop to generate an accented form of the next key you press. For example, pressing **Fn** **Y** followed by pressing **O** generates ö.

C

South and East European Language Support

How to Access Character Sets and Keyboard Layouts

The KEYBEZ program enables you to select a South East European language and load its corresponding character set, keyboard layout, and national settings. Here are the available languages:

Language	Code Page	Keyboard
Byelorussian (BL)	866	Cyrillic
Croatian (CR)	852	Slavic
Czech (CZ)	852	Slavic
Greek (GK)	437G	Greek
Hungarian (HU)	852	Hungarian
Polish (PL)	852	Polish
Romanian (RO)	852	Slavic
Russian (RU)	866	Cyrillic
Slovak (SL)	852	Slavic
Slovene (SV)	852	Slavic
Turkish (TK)	437T	Turkish
Ukrainian (UR)	866	Cyrillic

The various code pages and keyboard layouts are found at the end of this appendix.

Note

1-2-3 supports only CP 850. If another code page is loaded, you may have trouble displaying or printing certain characters within 1-2-3.

Running KEYBEZ

Modify your AUTOEXEC.BAT file to include the KEYBEZ command (with language option) on the line immediately preceding the 100 line.

SYNTAX: KEYBEZ [BL|CR|CZ|GK|HU|PL|RO|RU|SL|SV|TK|UR]

Example: Implementing Russian Language Support

1. Use the Memo Editor to open your AUTOEXEC.BAT file (located in the root directory of C:\ or D:\)
2. Add the line `KEYBEZ RU` just before the 100 line.
3. Save your new version of the AUTOEXEC.BAT file in the root directory C:\.
4. Ensure that your CONFIG.SYS file is in the root directory C:\. Copy it from D:\ if necessary.
5. Close all open applications in preparation to reboot.
6. Reboot by pressing **CTRL**+**ALT**+**DEL**.

When you see the Topcard screen, the Cyrillic Code Page (CP 866) and keyboard are ready to use. Press **CTRL** to toggle the keyboard back and forth between English and Cyrillic. For positions of the Cyrillic characters, see the Cyrillic overlay on page D-4.







Accessing the Characters. You access characters in one of two ways, depending on which keyboard layout is implemented.

- For the Cyrillic and Greek keyboards, the characters on the overlay *become* the primary keys, replacing the English key definitions. For example, when the Greek keyboard is implemented and you press **U**, you generate a θ .

However, you can switch back and forth between Cyrillic or Greek and English by pressing the **CTRL** key—press it once and you have the Cyrillic or Greek keys, press it again and you're back to English.

Note that while in Cyrillic mode, you may access numbers and punctuation symbols by using the **Fn** followed by the number or **Fn** **↵** followed by the desired punctuation. For example, to access the ',' character while in Cyrillic mode, press **Fn** **↵** **4**.

- For the other keyboards (Hungarian, Polish, Slavic, and Turkish), the special characters are an extension of the English keyboard and are accessed using the **Fn** key. For example, to generate Ö when the Hungarian keyboard is implemented, you press **Fn** **K**.

Some of the keys shown on the overlays for these keyboards show two characters above the primary key (see pages D-5 and D-6). In these cases the left character is the  key definition and the right character is the  key definition. For example, above  on the Slavic keyboard are the characters] and Ī. To generate] you press  , and to generate Ī you press  .

Printing Considerations

In order to print the character sets implemented by KEYBEZ, you must have a printer that supports the character set you want to print.

For example, before you can print a file containing CP 866 (Cyrillic) characters, you must first configure your printer to support this character set. See the documentation for your particular printer.

Keyboard Overlays & Code Page Tables

The following pages illustrate the keyboard overlays and code pages KEYBEZ implements. A set of all six overlays (HP Part No. B2539A) is available. Contact your Hewlett-Packard sales office or dealer, or Hewlett-Packard's South East European Sales headquarters (address below), for information on where to purchase this set of overlays.

Hewlett-Packard Ges.m.b.H.
Lieblgasse 1
A-1222 Vienna/Austria
Telephone: +43 1 2500-0
FAX: +43 1 2500-444

Note

If calling from the United States, dial
1 011 43 1 2500-0. For FAX's from the U.S. dial
1 011 43 1 2500-444.

Greek and Cyrillic Overlays

ESC	HELP	F1	F2	F3	F4	F5	F6	F7	F8	F9	F10	PG UP	OFF
←	!	@	^	&	()	SCRL	FR	INS	DEL	HOME	PG DN	END
⌂	!@	#\$	%&	'()*	+,-	ENTER	BRK	ENTER	+/	~	?	%
CTRL	Z	X	Y	R	STO	N	RCL	DATE	CAPS	PRY SC	CUT	COPY	PASTE
↩	√	1/x	Y	R	LAST	STO	DATE	ZOOM	⌨	BRK	ENTER	+/	⌨
↩	√	1/x	Y	R	LAST	STO	DATE	ZOOM	⌨	BRK	ENTER	+/	⌨
↩	√	1/x	Y	R	LAST	STO	DATE	ZOOM	⌨	BRK	ENTER	+/	⌨
↩	√	1/x	Y	R	LAST	STO	DATE	ZOOM	⌨	BRK	ENTER	+/	⌨

ESC	HELP	F1	F2	F3	F4	F5	F6	F7	F8	F9	F10	PG UP	OFF
←	!	@	^	&	()	SCRL	FR	INS	DEL	HOME	PG DN	END
⌂	!@	#\$	%&	'()*	+,-	ENTER	BRK	ENTER	+/	~	?	%
CTRL	Z	X	Y	R	STO	N	RCL	DATE	CAPS	PRY SC	CUT	COPY	PASTE
↩	√	1/x	Y	R	LAST	STO	DATE	ZOOM	⌨	BRK	ENTER	+/	⌨
↩	√	1/x	Y	R	LAST	STO	DATE	ZOOM	⌨	BRK	ENTER	+/	⌨
↩	√	1/x	Y	R	LAST	STO	DATE	ZOOM	⌨	BRK	ENTER	+/	⌨
↩	√	1/x	Y	R	LAST	STO	DATE	ZOOM	⌨	BRK	ENTER	+/	⌨

D

Hungarian and Polish Overlays

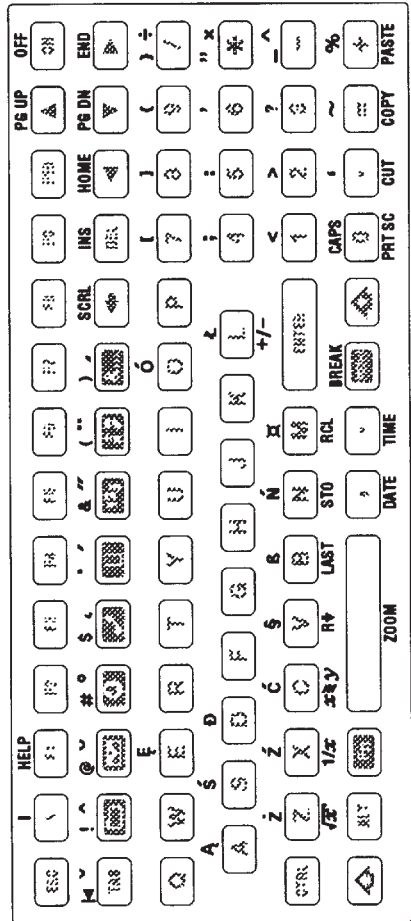
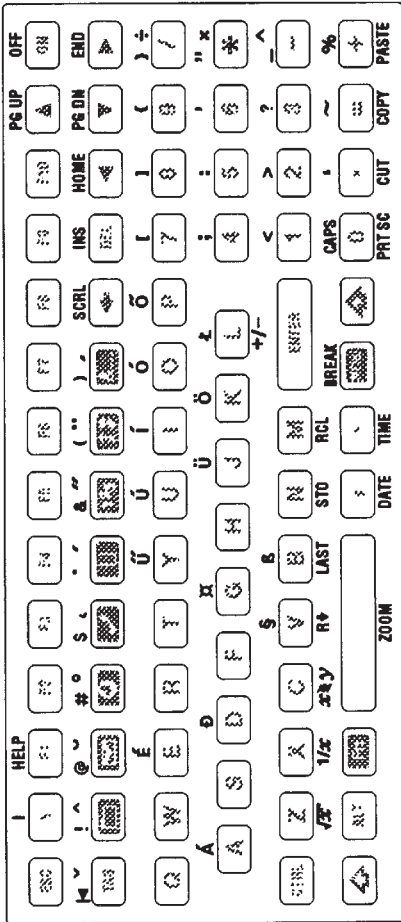

CP 437G (PC Latin/Greek)

A 128	P 144	ι 160	☐ 176	┌ 192	≡ 208	ω 224	≡ 240
B 129	Σ 145	κ 161	☒ 177	┐ 193	≡ 209	ά 225	± 241
Γ 130	Τ 146	λ 162	☒ 178	└ 194	≡ 210	έ 226	≥ 242
Δ 131	Υ 147	μ 163	┆ 179	┌ 195	≡ 211	ή 227	≤ 243
E 132	Φ 148	ν 164	┆ 180	— 196	≡ 212	ϊ 228	┆ 244
Z 133	X 149	ξ 165	≡ 181	⊕ 197	≡ 213	ί 229	┆ 245
H 134	Ψ 150	ο 166	≡ 182	≡ 198	≡ 214	ό 230	÷ 246
Θ 135	Ω 151	π 167	≡ 183	≡ 199	≡ 215	ύ 231	≈ 247
I 136	α 152	ρ 168	≡ 184	≡ 200	≡ 216	ϋ 232	° 248
K 137	β 153	σ 169	≡ 185	≡ 201	└ 217	ώ 233	• 249
Λ 138	γ 154	ς 170	≡ 186	≡ 202	┌ 218	Ω 234	· 250
M 139	δ 155	τ 171	≡ 187	≡ 203	■ 219	δ 235	√ 251
N 140	ε 156	υ 172	≡ 188	≡ 204	■ 220	∞ 236	η 252
Ξ 141	ζ 157	φ 173	≡ 189	≡ 205	■ 221	φ 237	² 253
O 142	η 158	χ 174	≡ 190	≡ 206	■ 222	ε 238	■ 254
Π 143	θ 159	ψ 175	└ 191	≡ 207	■ 223	∩ 239	255

D

CP 437T (PC Turkish)















































Ç	É	á	☐	┌	⌋	σ	≡
128	144	160	176	192	208	224	240
Ü	æ	í	☒	┐	⌋	β	±
129	145	161	177	193	209	225	241
é	Æ	ó	☒	└	⌋	Γ	≥
130	146	162	178	194	210	226	242
â	ô	ú		┌	┐	π	≤
131	147	163	179	195	211	227	243
ä	ö	ñ	└	—	┐	Σ	┌
132	148	164	180	196	212	228	244
à	ò	Ñ	≠	+	≡	σ	┐
133	149	165	181	197	213	229	245
ã	û	Ǧ	≡	≡	≡	μ	÷
134	150	166	182	198	214	230	246
ç	ù	ǧ	┐	┐	≡	τ	≈
135	151	167	183	199	215	231	247
ê	î	ı	≡	┐	≡	Φ	°
136	152	168	184	200	216	232	248
ë	Ö	┐	≡	≡	┐	Θ	·
137	153	169	185	201	217	233	249
è	Ü	┐	≡	≡	┐	Ω	·
138	154	170	186	202	218	234	250
ï	ç	½	┐	≡	■	δ	√
139	155	171	187	203	219	235	251
î	£	¼	┐	┐	■	∞	∞
140	156	172	188	204	220	236	252
ı	¥	ı	┐	≡	■	φ	²
141	157	173	189	205	221	237	253
Ä	Ş	«	┐	≡	■	ε	■
142	158	174	190	206	222	238	254
Å	ş	»	┐	≡	■	∩	
143	159	175	191	207	223	239	255

D

CP 852 (PC Latin-2)

Ç	É	á	⋮	Ł	đ	Ó	-
128	144	160	176	192	208	224	240
Ü	Ĺ	í	⊞	⊥	Đ	ß	˝
129	145	161	177	193	209	225	241
é	í	ó	⊞	⊥	Ď	Ô	˘
130	146	162	178	194	210	226	242
â	ô	ú		┌	Ě	Ň	˘
131	147	163	179	195	211	227	243
ä	ö	Ą	┌	—	d'	ń	˘
132	148	164	180	196	212	228	244
û	ĺ	ą	Á	+	Ń	ň	§
133	149	165	181	197	213	229	245
ć	ı	ž	Ă	Ă	ı	Š	÷
134	150	166	182	198	214	230	246
ç	ś	ž	Ě	ă	î	š	˘
135	151	167	183	199	215	231	247
ı	ś	Ę	Ş	Ł	ě	Ř	°
136	152	168	184	200	216	232	248
ë	Ö	ę	≡	≡	┘	Ú	˝
137	153	169	185	201	217	233	249
ő	Ü			≡	┘	ř	˘
138	154	170	186	202	218	234	250
ó	ř	ž	≡	≡	■	Ů	ů
139	155	171	187	203	219	235	251
î	ř	Č	≡	≡	■	ý	Ř
140	156	172	188	204	220	236	252
ž	ł	ş	Ž	=	Ṭ	Ý	ř
141	157	173	189	205	221	237	253
Ă	×	«	ž	≡	Ů	ṭ	■
142	158	174	190	206	222	238	254
Ć	č	»	┘	□	■	˘	
143	159	175	191	207	223	239	255

CP 866 (PC Cyrillic)

А 128	Р 144	а 160	 176	Л 192	 208	р 224	Ё 240
Б 129	С 145	б 161	 177	 193	 209	с 225	ё 241
В 130	Т 146	в 162	 178	 194	 210	т 226	Є 242
Г 131	У 147	г 163	 179	 195	 211	у 227	є 243
Д 132	Ф 148	д 164	 180	 196	 212	ф 228	İ 244
Е 133	Х 149	е 165	 181	 197	 213	х 229	ï 245
Ж 134	Ц 150	ж 166	 182	 198	 214	ц 230	ÿ 246
З 135	Ч 151	з 167	 183	 199	 215	ч 231	ÿ 247
И 136	Ш 152	и 168	 184	 200	 216	ш 232	° 248
Й 137	Щ 153	й 169	 185	 201	 217	щ 233	• 249
К 138	Ъ 154	к 170	 186	 202	 218	ъ 234	· 250
Л 139	Ы 155	л 171	 187	 203	 219	ы 235	√ 251
М 140	Ь 156	м 172	 188	 204	 220	ь 236	№ 252
Н 141	Э 157	н 173	 189	 205	 221	э 237	¤ 253
О 142	Ю 158	о 174	 190	 206	 222	ю 238	■ 254
П 143	Я 159	п 175	 191	 207	 223	я 239	 255

D

Regulatory Information

U.S.A.:

This PC generates and uses radio frequency energy and may interfere with radio and television reception. It complies with the limits for a Class B computing device as specified in Part 15 of FCC Rules. These limits are designed to provide reasonable protection against harmful interference in a residential area. Operation of this device is subject to the following two conditions: (1) It may not cause harmful interference, and (2) it must accept any interference received, including interference that may cause undesired operation. In the unlikely event that there is interference to radio or television reception (which can be determined by turning the palmtop off and on), try the following:

- Reorienting or relocating the receiving antenna (radio or television).
- Relocating the palmtop with respect to the receiver.

Any changes or modifications not expressly approved by the Hewlett-Packard Company could void the authority to operate this equipment.

For more information, consult your dealer, an experienced radio/television technician, or the following booklet, prepared by the Federal Communications Commission: *How to Identify and Resolve Radio-TV Interference Problems*. This booklet is available from the U.S. Government Printing Office, Washington, D.C. 20402, Stock Number 004-000-00345-4. At the first printing of this manual, the telephone number was (202) 783-3238.

The HP F1015A Serial Interface Cable must be used to connect the palmtop to printers, computers, and other peripheral devices to ensure compliance with the Class B emission limits for residential use.

Canada:

This PC apparatus does not exceed the Class B limits for radio noise emissions from digital apparatus as set out in the radio interference regulations of the Canadian Department of Communications.

Le présent appareil numérique n'émet pas de bruits radioélectriques dépassant les limites applicables aux appareils numériques de Classe B prescrites dans le règlement sur le brouillage radioélectrique édicté par le Ministère des Communications du Canada.

Europe:

Declaration of Conformity (according to ISO/IEC Guide 22 and EN 45014)

Manufacturer: Hewlett-Packard Company

Address: Hewlett-Packard Co. Hewlett-Packard Singapore (Private) Ltd
1000 NE Circle Blvd. 452 Alexandra Road
Corvallis, OR 97330 Singapore 119961.
U.S.A. Republic of Singapore.

declares that the following product

Product name: Palmtop Personal Computer

Model Number: HP 200LX

Options: All

conforms to the following product specifications

Safety: IEC 950:1986+A1,A2 / EN 60950 (1988)+A1,A2

EMC: CISPR 22:1985 / EN 55022 (1988): Class B (2)

IEC 801-2:1991 / prEN 55024-2 (1992): 3kV CD,
8kV AD

IEC 801-3:1984 / prEN 55024-3 (1991): 3V/m

IEC 801-4:1988 / prEN 55024-4 (1992): 0.5kV signal
lines, 1.0kV power lines

Supplementary Information:

The product herewith complies with the requirements of the Low Voltage Directive 73/23/EEC and the EMC Directive 89/336/EEC.

(1) The product was tested in a typical configuration with Hewlett-Packard personal computer peripherals.

Quality Department
Hewlett-Packard Company



Hewlett-Packard de México S.A. de C.V.
Montemorelos No. 299, Fracc. Loma Bonita
Guadalajara, Jalisco, México. 45060

Valid only in Mexico

Warranty sheet

Hewlett-Packard de México S.A. de C.V. with address located in:

MEXICO, D. F.

Prolongacion Reforma No. 470
Col. Lomas de Sta. Fe 01210
Delegacion Alvaro Obregon
Tel. 326 46 00

Guarantees this product during twelve months in all its parts and assembling against any manufacturing and operating failure since the purchase date of the final customer. Concerning products with teaching and training requirements on the operating system or on the installation, since the normal operating beginning of the product, after the installation of it at the final customer address.

Conditions:

1. Service Centers, Replacement Parts:

In the case that you need to use this warranty, you will only need to present this warranty sheet and the product to the dealer, or you can visit any of the service centers, where you will be able to buy replacement parts.

2. Covering:

The company has the compromise to repair or change the product as well as the faulty parts and components of it without any charge for the customer. The transportation costs originated by the execution of the above mentioned will be covered by Hewlett Packard de México, S.A. de C.V.

3. Repairing Period:

The repairing period for every product will be no more than thirty days since the reception of the product in any of the places assigned to cover the effectiveness of the warranty.

4. Limitations

This warranty will be invalid in the following events:

- a) When the product has been operated in abnormal conditions.
- b) When the product has not been operated according with the Spanish user's manual instructions provided to the customer.
- c) When the product has been repaired by non-accredited people from Hewlett-Packard de México, S.A. de C.V.

Product		Brand		Model	
Serial Number		Name of the dealer			
Address : (Street, Number, District)					
Z.C.		City	State		Phone
Purchase or installation date					

NOTES:

The customer will be able to demand the effectiveness of the warranty to the commercial house where he acquired the product. In the event of loss of this warranty sheet, the customer has show a dated purchase invoice in order that this warranty is valid, in whichever authorized service center.

E

Games

Your palmtop has two games built in for your entertainment. The games are:

- **Hearts & Bones**, where you try to capture hearts without stepping on bones.
- **Lair of Squid**, where you try to escape an underwater maze while being pursued by deadly squid.

Games can drain batteries at a higher than normal rate. So, to get your best battery life, use the AC adapter when you play.

To start Hearts & Bones:

1. Press **&** **+** to see the Hearts & Bones opening screen.
2. Press **F4** (Help) to see information on how to play the game. Use **▼** to move through the tutorial screens.
3. When you've finished the tutorial screens, press **F1** to start the game.
4. To quit the game, press **ESC**.

To start Lair of Squid:

1. Press **&** **U** to see the Lair of Squid opening screen.
2. Press **F1** (Help) to see information on how to play the game. Use **▼** to move through the tutorial screens.
3. When you've finished the tutorial screens, press **ESC** to exit the tutorial and then press **spacebar** to start the game.
4. To quit the game, press **ESC**.

Index

Special characters

1-2-3, 2-1

0, 3-8

●, 3-16, 28-5

✱, 3-16, 28-5

i, 24-3, 25-14

z, 24-3, 25-14

□, 3-8, 3-16, 4-3, 28-5

✖, 1-13

|, 1-13

▲, 1-13

☒, 1-13

◆, 1-21

✱, 5-2

A

ABS function key, 12-16

absolute value, 12-15

AC adapter, 1-9, B-6

charging rates, B-5

jack, 1-1

accented characters, C-1

accessing DOS, 25-1

account register, 9-9

accounts

Quicken, 9-1

transferring between, 9-15

types, 9-1

accounts in brackets, 9-15

ACCUM function key, 14-8

ACOS function key, 12-17

active application, 1-6

adapter, B-6

charging rates, B-5

adapters

connecting, 26-6

adapters (serial), 26-6

ADB file extension, 22-10, 25-4

Add function key, 4-30, 5-3,
8-2

adding a new category, 9-5

adding applications, 24-1

adding city records, 5-3

tips on, 5-4

adding database fields, 4-9

adding earlier transactions,
10-7

adding note records, 8-2

adding transactions, 9-12

address book

private, 29-6

public, 29-6

address books, 29-6

address book updates, 29-7

Add Transaction screen, 9-10

ADE Utility, 29-7

adjustable rate mortgage (ARM),
14-11

Adjust function key, 14-8

adjusting audio volume, 21-3

adjusting display contrast, 21-4

advanced settings (Datacomm)

configuration choices, 26-4

Alarm Clock, 6-1, 6-2

- Alarm field, 3-2
- alarm leadtime, 3-4
- alarms
 - changing settings, 3-21
 - Custom, 3-22
 - in Stopwatch, 6-2
 - programming, 3-23
 - snooze, 3-6
 - volume and sound, 3-22
 - without appointments, 6-2
- ALG annunciator, 12-3
- algebraic expression, 19-25
- All Cities list, 5-1
- All format, 20-1
- All function key, 5-1, 5-11
- allocating memory, 21-5
- ALT**-arrow keys, 25-9
- ALT interface (Datacomm), 26-3
- ALT**-keys (Datacomm), 26-10
- Amort function key, 14-2
- amortization, 14-7
 - ARM, 14-9, 14-11
 - Canadian mortgages, 14-17
 - data to 1-2-3, 14-13
 - function keys, 14-8
 - GPM, 14-12
 - mortgage, 14-10
 - negative, 14-13
 - printing, 14-13
 - procedure, 14-9
- angle conversions, 12-18
- ANGLE function key, 12-18
- angle mode, 12-17, 20-1
- annual percentage rate (APR), 14-20
- annunciators, 1-13, 12-2, 25-16
- application keys, 1-2, 1-9, 1-19, 24-2
- application lists, 1-11
- Application Manager, 24-2, 24-3
 - applications list, 24-4
 - Icons View, 24-4
 - List View, 24-4
- application records, 1-11, 1-12
- applications
 - adding, 24-1
 - DOS, 24-1, 24-4
 - file name extensions, 22-10
 - HP 100LX, 24-1
 - installing, 24-1
 - quitting, 1-9
 - run from drive A, 25-15
 - run from drive E, 25-15
 - SMC, 24-4
 - starting, 1-9
 - System-Manager-Compliant, 24-1
- application screen, 1-10
- application views, 1-11
- appointment alarms, 3-4
- Appointment Book, 3-1
 - configuring, 3-19, 3-20
 - daily greeting, 3-23
 - function keys, 3-23
 - new, 3-18
 - settings, 3-19
- Appointment Book files, 3-18
 - translating from HP 95LX, 3-19
- appointment duration, 3-21
- appointment lists, 3-8, 3-20
- appointment record, 3-1
- appointments
 - backing up, 3-14
 - changing date, 3-11
 - changing from repeating to one-time, 3-13
 - changing settings, 3-21
 - daily, 3-8

- deleting, 3-13, 3-14
 - displaying events only, 3-11
 - extracting, 3-14
 - monthly, 3-9
 - moving around, 3-10
 - next and previous, 3-10
 - printing, 28-3
 - repeat options, 3-2
 - running programs, 3-15
 - scheduling, 3-11
 - searching for text, 1-25
 - weekly, 3-9
 - without times, 3-11
 - appointment settings, 3-21
 - Appt function key, 3-23
 - Arabic numerals in outlining, 7-14
 - area conversions, 16-3
 - argument separators, 21-6
 - arrow annunciator, 1-13
 - arrow keys, 1-19
 - ASCII control codes
 - filtering, 26-11
 - map to characters., 26-11
 - ASCII files, 7-4
 - HP 95LX to HP 200LX transfer, 22-15
 - printing (PIM), 28-5
 - saving notes as, 8-3
 - viewing, 22-4
 - ASIN function key, 12-17
 - ATAN function key, 12-17
 - attaching file to mail, 29-13
 - ATT file extension, 22-10, 25-4
 - audio volume, 21-3
 - AUTOEXEC.BAT
 - editing, 25-17
 - Auto function key, 19-43
 - auto-lock mode, 1-4
 - automatic constant, 12-7
 - Automatic DST setting, 5-8
 - Automatic Redial (Datacomm), 26-3
 - automating Datacomm, 26-12
 - auto-saving memos, 7-5
 - available system memory, 24-6
- B**
- backing up appointments, 3-14
 - backing up data, 1-6
 - backing up files, 22-9
 - backing up memory, 22-2
 - backing up memos, 7-3
 - backslash (\), in modem command, 29-17
 - backsolving, 19-8
 - backspace in Calculator, 12-3
 - backup battery, B-3
 - BAK file extension, 22-10, 25-4
 - balances reports, 11-2
 - balancing accounts, 10-1
 - problems, 10-4
 - BAL function key, 14-8
 - bank accounts, 9-1
 - Batch Transfers, 29-2, 29-3
 - BAT file extension, 22-4, 24-2, 25-4
 - batteries, 22-2, B-1
 - backup, B-3
 - changing, B-2
 - charging, B-5
 - life, B-1
 - power level, 21-1
 - rechargeable, B-4
 - saving power, 1-9, 21-9
 - types, B-1
 - battery power, 21-9
 - baud rate, 26-3
 - for IR communication, 22-13
 - B/E function key, 14-2
 - boldface text, 7-6
 - Boolean operators (SSL), 4-27

- boot options, 25-18
 - bottom margin
 - print setup, 7-17
 - break (**CTRL**+**BREAK**), 1-21
 - breaking IR connection, 22-14
 - business expense reports, 11-3
 - business phone list, 4-22
- C**
- cable, HP F1015A (PC), 27-1, 28-1
 - cables, connecting, 26-6
 - cable, serial (PC), 27-1, 28-1
 - Calc function key, 19-7
 - calc line, 12-2
 - clearing, 12-3
 - editing, 12-3
 - recalling numbers, 12-8
 - Calculator
 - angle conversions, 12-18
 - angle mode, 12-17
 - Angle Mode, 20-1
 - automatic constant, 12-7
 - chain calculations, 12-5
 - clearing memory, 12-14
 - configuring, 20-1
 - Custom application, 20-2
 - customizing, 20-1
 - date calculations, 18-1
 - exponential functions, 12-16
 - full precision, 12-3
 - hour conversions, 12-18
 - keyboard, 12-3
 - List Stat, 17-1
 - logarithmic functions, 12-16
 - margin, 13-2
 - markup, 13-2
 - moving values to 1-2-3, 12-12
 - M register, 12-11
 - number formats, 20-1
 - Number of Digits, 20-1
 - Operation Mode, 20-1
 - percentages, 13-1
 - point and shoot, 12-12
 - polar/rectangular conversions, 12-18
 - probability functions, 12-20
 - registers, 12-10
 - RPN syntax, 12-14
 - Show Registers, 20-1
 - Show Stack, 20-1
 - startup application, 20-2
 - statistics, 17-1
 - storing numbers, 12-10
 - trigonometric functions, 12-17
 - ZOOM, 12-3
 - calendar
 - display, 3-20
 - six-month, 3-10
 - Calendr function key, 3-11
 - Canadian mortgages, 14-17
 - cancel, 1-21
 - canceling dialog boxes, 1-18
 - canceling editing changes (Memo), 7-8
 - CAP file extension, 22-10, 25-4
 - Caps lock annunciator, 1-13
 - CAPS lock key, 1-20
 - Caps Lock (Memo), 7-12
 - Capture function key, 29-7
 - capturing data, 26-11
 - card-eject switch, 1-1
 - card modems, 27-2
 - cards
 - plug-in memory, 22-8, 22-9
 - cards, plug-in, 1-7
 - car loan, 14-3
 - carry-forward setting
 - changing the default, 3-22
 - cases (TVM), 14-2
 - cash accounts, 9-1
 - cash flow calculations, 15-1

- examples, 15-3
- plotting, 15-8
- categories, 9-4
 - adding, 9-5
 - deleting, 9-6
 - demoting, 9-5
 - merging, 9-6
 - moving, 9-5
 - renaming, 9-5
- Category field, 4-21, 9-11
 - Database, 4-9
 - limits, 8-2
 - Note Taker, 8-2
 - World Time, 5-4
- Category field choices
 - limits, 4-22, 8-2
- category field, editing, 9-13
- category fields, 4-22
- category list, 9-5
- category list boxes, 4-22
- category reports, 11-3
- cc:MADE, 29-7
- cc:Mail, 29-1
 - address update, 29-7
 - ADE Utility, 29-7
 - Capture, 29-7
 - communication settings, 29-14
 - Connect Settings, 29-15
 - directories, 29-14
 - folders, 29-5
 - host, 29-15
 - Inbox folder, 29-5
 - modem file, 29-16
 - Outbox folder, 29-5
 - password, 29-14
 - remote directory, 29-6
 - Saved Message folder, 29-5
 - sending messages, 29-4
 - updating address books, 29-7
 - user address, 29-7
 - user name, 29-7
 - writing messages, 29-4
- cc:Mail administrator, 29-1
- CCMAIL.INI, 29-15
- cc:Mail Post Office, 29-1
- cc:Mail support, 29-1
- CCM file extension, 25-4
- C:_DAT directory, 1-6
- Center function key, 19-44
- Cents symbol, displaying, 21-6
- CFL file extension, 15-2, 22-10, 25-4
- chain calculations, 12-5
- chaining system macros, 23-3
- changing a Phone Book, 4-2
- changing appointments, 3-13
- changing argument separator, 21-6
- changing batteries, B-2
- changing category names, 9-5
- changing cc:Mail communication settings, 29-14
- changing cc:Mail password, 29-14
- changing current date in Appointment Book, 3-12
- changing directories, 22-8
- changing display size (Datacomm), 26-10
- changing entry preferences, 9-16
- changing memos, 7-7
- changing punctuation, 21-6
- changing the group title, 9-7
- changing thousands separator, 21-6
- changing typefaces, 7-6
- character codes, C-4
- character set, C-1
 - changing, 25-10
- character size
 - changing, 1-10

- changing in display, 7-11
- Character-Size command
 - (Memo), 7-12
- character size, enlarging, 25-16
- character translation, 26-14
- charging batteries, B-5
- charging rates, B-5
- check boxes, 1-15
 - adding to database, 4-10
 - in Smart Clips, 1-30
 - in subset definitions, 4-20
 - selecting, 1-16
 - testing for subset definitions, 4-27
- checking accounts, 9-1
- checking off to-do items, 3-18
- CHK file extension, 25-4
- choosing a Quicken file, 9-4
- CIC100 command, 25-8
- circumflex (^), in modem
 - command, 29-17
- cities
 - adding to World Time, 5-3
 - around the world, 5-1
 - list of, 5-1
 - viewing on a map, 5-6
- city lists
 - adding to, 5-3
 - creating a new, 5-5
 - Custom, 5-5
 - limitations, 5-10
 - searching, 5-2
 - subsets of, 5-9
- city, local, 5-2
- City Prefix field, 5-4
- city records
 - built-in, 5-5
 - copying to Custom list, 5-5
 - deleting, 5-5
 - editing, 5-5
 - maximum number, 5-10
 - opening, 5-2
 - removing from Custom list, 5-6
 - restoring deleted, 5-5
 - viewing, 5-2
- class group, 9-7
- Cleared Status field, 9-12
- clearing a note, 8-4
- clearing Calculator memory, 12-14
- clearing memory, 1-8
- clearing system macros, 23-4
- clearing the calc line, 12-3
- client, 22-13, 30-1
- client group, 9-7
- Clipboard, 1-26
 - memory allocation, 21-5
 - using in memos, 7-8
- Clip function key, 1-28, 4-31, 7-9
- clipping database information, 1-28
- clipping information to a memo, 7-9
- clipping memos
 - example, 7-9
- clock display (Appt Book), 3-20
- clock setting, 5-2, 21-3
- closing built-in applications, 1-9
- closing DOS applications, 24-5
- closing SMC applications, 24-5
- closing System Manager, 24-6
- code pages, 26-14
 - 437, C-1
 - 437G, D-8
 - 437T, D-9
 - 850, C-1
 - 852, D-10
 - 866, D-10
 - Cyrillic, D-10

- default, 21-6
 - Latin-2, D-10
 - Latin/Greek, D-8
 - Turkish, D-9
- code page selections (DOS), 25-10
- code page support, 25-9
- code page vs. file name, 25-12
- codes, printing, 7-17
- collating sequence for 1-2-3, 21-8
- collation sequence, 25-9
- Columns function key, 4-31, 8-7
- columns in data lists
 - rearranging, changing, deleting, 4-17
- Com1
 - closing and opening, 21-9
 - disabling and enabling, 21-9
- Com1 interface (Datacomm), 26-3
- Com1 port, 26-6
 - pin connections, 26-7
- Com2 interface (Datacomm), 26-3
- combinations, 12-20
- COM file extension, 22-4, 24-2, 25-4
- command buttons, 1-15, 1-17
- commands
 - DOS, 25-5, 25-7, 25-8
 - File overview, 1-23
 - Help, 1-31
 - menu, 1-13
 - unavailable (dimmed), 1-14
- communication port
 - power, 25-9
- communications. *See* Datacomm
- compounding interest, 14-15
- compounding periods, 14-16
- CompuServe, 26-10
- conditional expressions, 19-22
- CONFIG.SYS, editing, 25-17
- configuration
 - Appointment Book, 3-19
 - Datacomm defaults, 26-5
- configuration files, 26-3
 - choosing, 26-5
 - for information services, 26-10
 - saving, 26-5
 - script file name, 26-12
- configuring 1-2-3, 2-4
- configuring for Datacomm, 26-5
- configuring for IR
 - communication, 22-13
- configuring the Appt Book, 3-20
- configuring the Calculator, 20-1
- connecting adapters, 26-6
- connecting cables, 26-6
- connecting PC and palmtop, 26-6
- connecting to CompuServe, 26-10
- connecting to modems, 26-6, 27-1
- connecting to Post Office, 29-2
- Connectivity Pack, 2-1, 9-17, 27-1, 28-1
 - printing, 7-15
- Connector/Adapter Kit, 28-1
- Connect Settings (cc:Mail), 29-15
- constants (Solver), 19-14
- CONT function key, 14-15
- contrast of display, 21-4
- control characters in memos, 7-12
- control codes
 - filtering, 26-11
 - map to characters, 26-11

- typing, 7-17
- conversions
 - area, 16-3
 - coordinates, 12-18
 - currency, 16-1
 - interest rates, 14-15
 - length, 16-3
 - mass, 16-3
 - temperature, 16-3
 - volume, 16-3
- converter, B-6
- Convert function key, 5-7
- converting times
 - across time zones, 5-7
- Conv function key, 19-21
- coordinate conversions, 12-18
- COPY, 7-8
- copying attached mail file, 29-11
- copying city records to Custom list, 5-5
- copying database fields, 1-28
- copying databases, 4-15
- copying directories, 22-3
- copying directories (split screen), 22-11
- copying fields to a memo, 7-9
- copying files, 22-3
- copying files (split screen), 22-11
- copying files to a card, 22-9
- copying in memos, 7-8
- copying items in a list, 1-27
- copying items or text, 1-26
- copying mail, 29-12
- copying memos, 7-10
- copying note fields, 8-3
- copying note records, 8-3
- copying records, 1-28
- COPY key, 1-26
- COS function key, 12-17
- Countdown Timer, 6-1
- counter variable, 19-25
- counting to zero, 6-2
- countries, supported (NLS), 25-11
- COUNTRY command, 25-10
- country defaults, NLS, 25-9
- country settings, 21-6
- CP 437, C-1
- CP 437G, D-8
- CP 437T, D-9
- CP 850, C-1
- CP 852, D-10
- CP 866, D-10
- creating a picture display, 21-8
- creating a Topcard, 21-8
- creating CTF files, 26-15
- creating memos, 7-2
- creating new Appt Books, 3-18
- creating new Note Taker files, 8-6
- creating new Phone Books, 4-5
- creating system macros, 23-1
- credit card accounts, 9-1
- CTF file extension, 22-10, 25-4
- CTF files, 26-14
 - commands, 26-17
 - creating, 26-15
 - example, 26-15
 - formatting rules, 26-16
 - remap, 26-4
- CTRL+ALT+DEL**, 1-8
- Ctrl Characters command, 7-12
- currency conversions, 16-1
- currency exchange rates, 16-1
- currency settings
 - 1-2-3 vs. other applications, 21-7
- currency symbols, 21-6
- currency symbols, displaying, 21-6
- current date

Appointment Book, 3-12
 current directory, 22-15
 changing, 22-8
 current file, 1-6
 current position, 1-15
 cursor, 1-19
 cursor movement, 1-15
 cursor position (Memo), 7-12
 cursors, 1-13
 cursor tracking, 25-9
 curve fitting, 17-5
 Custom
 alarm sound, 3-22
 printing style, 28-5
 repeat option (Appt), 3-2
 Custom calculator application,
 20-2
 Custom Cities list, 5-5
 customer support, A-2
 Custom function key, 5-5, 5-11
 Customize Appointments View,
 3-20
 Customize ToDo List View,
 3-20
 customizing palmtop operation,
 25-17
 customizing the Calculator,
 20-1
 Custom List check box (World
 Time), 5-4
 custom style
 printing, 28-5
 CUT, 7-8
 CUT key, 1-26
 Cx,y function key, 12-20
 Cyrillic code page, D-10

D

daily appointment list, 3-1
 daily appointments, 3-8
 daily greeting, 3-23
 Daily repeat option (Appt), 3-2
 _DAT, 22-1
 data
 backing up, 1-6
 capturing (Datacomm), 26-11
 filtering (Datacomm), 26-11
 saving, 1-6
 sharing in Quicken, 9-17
 database
 defining new, 4-8
 definition, 4-6
 printing, 28-3
 searching, 4-4
 Database application, 4-7
 Database data card, 4-15
 database definition, 4-9
 creating, 4-8
 data card, 4-15
 example, 4-12
 modifying, 4-14
 naming, 4-11
 saving, 4-11
 database fields
 adding, 4-9
 changing size, 4-10
 clipping (copying), 1-28
 defining, 4-9
 deleting, 4-11
 editing, 4-11
 hidden, 4-10
 moving, 4-10
 redefining, 4-11
 renaming, 4-11
 shortcut keys for, 4-11
 types of, 4-9
 database lists
 limitations of, 4-30
 subsets of, 4-18
 database pages, 4-10
 database records
 maximum number, 4-30

- database structure
 - creating, 4-9
 - creating (example), 4-12
 - data card, 4-15
 - defining, 4-8
 - duplicating, 4-15
 - modifying, 4-14
 - naming, 4-11
 - saving, 4-11
- database subsets, 4-18
- data bits, 26-3
- data card, 4-4, 4-15, 8-4
- Datacomm, 26-1
 - advanced configuration
 - settings, 26-3
 - automating, 26-12
 - capturing data, 26-11
 - character translation, 26-14
 - configuration, 26-5
 - ending a session, 26-9
 - hardware connection, 26-6
 - starting a session, 26-9
- Data Edit screen, 17-1
- data fields, 4-7
- data lists, 1-11
- data records, 1-12
- DATE1 function key, 18-1
- DATE2 function key, 18-1
- date arithmetic, 18-1
- date calculations, 18-1
- date, default setting, 21-6
- Date field
 - appointment, 3-11
 - Database, 4-8
- date formats, 21-2
 - Calculator, 19-15
- date print fields (Memo), 7-7
- date setting, 21-2
- date stamping, 1-20, 7-3, 8-2
- Day Graph, 3-20
- Daylight Savings field (World Time), 5-4
- daylight savings time, 5-8
- daylight savings time schedules, 5-8
- day-long appointments, 3-11
- day of the week, 3-21
- DC adapter, B-6
 - charging rates, B-5
- DCF file extension, 22-10, 25-4, 26-5
- DDAYS function key, 18-1
- Decimal numeration in outlining, 7-14
- decimal point, changing symbol, 21-6
- default appointment settings
 - changing, 3-21
- default configuration settings (Datacomm), 26-2
- default country settings, 21-6
- default drive options, 25-19
- default to-do settings
 - changing, 3-22
- Define function key, 4-32
 - subset, 4-25
- Define New Database command, 4-7
- Define Subset screen, 4-24
 - compared with SSL, 4-28
- defining subsets
 - example, 4-24
- DEG function key, 12-18
- deleted directory, recovering, 22-3
- deleted file, recovering, 22-3
- deleted text in memos
 - restoring, 7-8
- Delete function key, 4-30, 4-32
- DELETE function key, 15-3, 17-2, 19-7

- delete line (Memo), 7-2
- deleting added applications, 24-5
- deleting appointments, 3-13, 3-14
- deleting categories, 9-6
- deleting city records, 5-5
- deleting city records from Custom list, 5-6
- deleting database fields, 4-11
- deleting directories, 22-3
- deleting files, 22-3
- deleting in memos, 7-8
- deleting items in a list, 1-22
- deleting items or text, 1-26
- deleting memos, 7-10
- deleting messages, 29-12
- deleting note records, 8-4
- deleting phone records, 4-3
- deleting Quicken accounts, 9-3
- deleting subset definitions, 4-25
- deleting system macros, 23-4
- deleting text, 1-27
- deleting transactions, 9-13
- delimiters
 - date and time, 3-11
 - time, 21-3
- Demote function key, 7-13, 7-14
- demoting categories, 9-5
- demoting outlined text, 7-14
- Description field
 - appointment, 3-2
- de-selecting items, 1-21
- detaching file from mail, 29-11
- detaching messages from mail, 29-14
- determining memory use, 24-6
- dialog boxes, 1-15
 - canceling, 1-18
 - completing, 1-18
 - exiting, 1-18
- fields, 1-16
 - specifying file name in, 1-23
- digitizing, 19-37
- digit separators, 21-6
 - changing symbol, 21-6
- dimmed commands, 1-14
- directories
 - changing, 22-8
 - copying, 22-3
 - copying (split screen), 22-11
 - deleting, 22-3
 - Directory Tree view, 22-6
 - displaying, 22-7, 22-8
 - File List view, 22-5
 - finding names, 22-8
 - higher-level, 22-8
 - lower-level, 22-8
 - mail, 29-14
 - moving, 22-3
 - moving (split screen), 22-11
 - names, finding, 22-8
 - recovering, 22-3
 - renaming, 22-4
 - selecting, 22-5
 - specifying, 1-24
 - subset, viewing, 22-7
 - Sync view, 22-6
 - transferring between
 - HP 200LXs, 22-13
 - transferring (HP 200LX to HP 95LX), 22-15
 - transferring (IR connection), 22-12
 - valid names, 25-3
 - viewing subset, 22-7
- directory
 - current, 22-15
- Directory Tree view, 22-6
- disconnecting IR connection, 22-14
- discounting cash flows, 15-1

- DISPCTL, 25-9
 - display
 - changing character size in, 7-11
 - changing spacing in (Memo), 7-12
 - split (two-window), 22-11
 - switching between local and remote, 22-14
 - switching between split and full, 22-11
 - display colors, 25-16
 - display contrast, 21-4
 - displaying complete directory, 22-7
 - displaying currency symbols, 21-6
 - displaying events only, 3-11
 - displaying your name, etc., 21-8
 - displays
 - canceling, 1-15
 - display size, 1-2
 - changing, 1-10
 - display size (Datacomm), 26-10
 - distribution lists, 29-10
 - dividing transactions, 9-14
 - division of memory, 21-1
 - DOC file extension, 25-4
 - \$\$\$ file extension, 25-4
 - DOS
 - accessing, 25-1
 - changing gray shades, 25-17
 - code pages, 21-6
 - code page selections, 25-10
 - commands, 25-5
 - command syntax, 25-6
 - FON files, 25-10
 - inverting display colors, 25-16
 - memory allocating, 21-5
 - memory allocation, 21-5
 - prompt, 25-5
 - quitting, 24-5
 - reserved file names, 25-3
 - saving power, 21-9
 - special file extensions, 25-4
 - valid directory names, 25-3
 - valid file names, 25-3
 - zooming the display, 25-16
 - DOS applications, 24-1
 - closing, 24-5
 - installing, 25-13
 - opening, 24-4
 - running, 24-2, 24-3, 25-14
 - starting, 25-1
 - DOS commands, 25-10
 - description, 25-7, 25-8
 - online help, 25-5
 - DOS communications
 - applications
 - running, 24-3, 25-14
 - DOS exit message, 24-3, 25-14
 - DOS & IR port power, 25-9
 - DOS memory
 - allocating, 24-2, 25-14
 - DOS prompt, 25-1
 - DOS vs. System Manager
 - applications, 21-6
 - download (Datacomm), 26-4
 - Draw function key, 19-43
 - drive A, 22-1, 22-9, 25-15
 - drive C, 22-1
 - drive D, 24-5
 - drive E, 25-15
 - drives
 - displaying, 22-8
 - drives, specifying, 1-24
 - DRV file extension, 22-10, 25-4
- E**
- echo, local (Datacomm), 26-4
 - Edit function key, 4-30
 - Calculator, 17-3, 19-7

- Subset, Smart Clip, 4-32
 - editing a Phone Book, 4-2
 - editing applications list, 24-4
 - editing appointments, 3-13
 - editing AUTOEXEC.BAT, 25-17
 - editing category field, 9-13
 - editing city records, 5-5
 - editing CONFIG.SYS, 25-17
 - editing database fields, 4-11
 - editing databases, 4-14
 - editing group field, 9-13
 - editing memos, 7-2, 7-7
 - editing note records, 8-3
 - editing Quicken accounts, 9-2
 - editing subset definitions, 4-25
 - editing system macros, 23-2
 - editing the calc line, 12-3
 - editing transactions, 9-13
 - Edit menu, 1-23
 - edits, canceling, 7-8
 - EduCALC, 12-14
 - effective interest rates, 14-15
 - EFF% function key, 14-15
 - electronic mail, 29-1
 - e-mail, 29-1
 - ending data communication, 26-9
 - ending value, 19-25
 - end-of-field cursor, 1-13
 - End Time field (Appt), 3-2
 - Engineering format, 20-1
 - Enq-Ack flow control, 26-4
 - entering system macros, 23-1
 - entering transactions, 9-10, 9-12
 - entry preferences, 9-16
 - ENV file extension, 22-10, 25-4
 - environmental limits, B-6
 - Epson FX-80 printer, 28-2
 - EQN file extension, 22-10, 25-4
 - equation list, 19-2
 - erasing
 - all notes, 8-4
 - the Note field, 8-4
 - erasing Calculator data, 12-14
 - escape key, 1-19
 - European DST setting, 5-8
 - even parity, 26-3
 - events, 3-6
 - displaying weekly, 3-11
 - examples
 - Appointment Book, 3-3
 - Filer, 22-2
 - exclamation point (to-dos), 3-17
 - executable file, 22-4, 24-2
 - executing files, 22-4
 - EXE file extension, 22-4, 24-2, 25-4
 - EX function key, 12-16
 - EXM file extension, 22-10, 24-2, 25-4
 - expense reporting, 9-8
 - expense reports
 - printing, 11-3
 - exponential functions, 12-16
 - exporting Quicken data, 9-17
 - extensions, file name, 22-10, 25-3
 - extracting file from mail, 29-11
 - extremum (Solver), 19-38
- F**
- F1**, 1-3
 - F1015 cable (PC), 27-1, 28-1
 - F1023 Connector/Adapter Kit, 27-1
 - F11**, 1-19, 25-14
 - F12**, 1-19, 25-14
 - factorial, 12-20
 - FCF file extension, 22-10, 25-4
 - field

- current, 1-15
- move to a, 1-16
- fields in dialog boxes, 1-15
- File commands, 4-7
- \$\$\$ file extension, 25-4
- file extensions, 22-10, 25-4
 - reserved, 25-3
- File Insert command (Memo), 7-10
- File List view, 22-5
- file management, 22-1
- File menu, 1-23
 - overview, 1-23
- file name extensions, 1-24, 25-3
 - changing (Memo), 7-5
- file names
 - extensions, 22-10
 - in dialog boxes, 1-23
 - specifying, 1-23
- file names vs. code page, 25-12
- File New command, 4-7
- file order, 22-7
- file passwords, 1-25
- Filer, 22-1
- files
 - attaching to mail, 29-13
 - backing up, 22-9
 - copying, 22-3
 - copying (split screen), 22-11
 - Datacomm configuration, 26-5
 - deleting, 22-3
 - executable, 22-4, 24-2
 - extracting from mail, 29-11
 - listing, 22-7
 - listing order, 22-7
 - managing, 1-23
 - merging in Quicken, 9-17
 - moving, 22-3
 - moving (split screen), 22-11
 - names, 25-3
 - number in root directory, 25-3
 - ordering, 22-7
 - protecting (backing up), 22-9
 - Quicken, 9-1
 - recovering, 22-3
 - renaming, 22-4
 - reserved names, 25-3
 - running, 22-4
 - searching for text, 22-4
 - selecting, 22-5
 - sorting, 22-7
 - transferring, 22-12
 - transferring between computers, 22-12
 - transferring between HP 200LXs, 22-13
 - transferring (HP 200LX to HP 95LX), 22-15
 - transferring (IR connection), 22-12
 - valid names, 25-3
- File Save-As command (Memo), 7-3, 7-4, 7-10
- file sorting, 22-7
- filtering received data, 26-11
- Find, 4-4
- Find function key, 1-25, 4-31, 7-11, 8-5, 19-7
- finding and replacing (Memo), 7-11
- finding a note, 8-5
- finding city in list, 5-2
- finding memory use, 24-6
- finding text in a memo, 7-11
- finding text in note records, 8-5
- finding text in PIM, 1-25
- FindNxt function key, 7-11
- Fin function key, 19-21
- Fixed point format, 20-1
- flash disks, 1-7

FLD file extension, 22-10, 25-4

flow control, 26-4

F11, C-4

Fn annunciator, 1-13

Fnd&Rep function key, 7-11

FN key, 1-20

folders

 creating, 29-5

 deleting mail in, 29-12

 printing mail in, 29-13

folders/, 29-5

FON file, 25-10

FON file extension, 22-10, 25-4,
25-10

footers, 7-6

forecasting, 17-5

Format commands, 7-14

formats

 date in Calculator, 19-15

 setting for date, 21-2

 setting for time, 21-3

formatted memo files, 7-4

formatting a memo, 7-1

formatting memory cards, 22-8

formatting memos, 7-6

FP function key, 12-16

fractional part, 12-15

Frcast function key, 17-6

free RAM, 24-6

full precision, 12-3

full vs. split screen, 22-11

function keys, 1-10, 1-13, 1-15,
1-19

 Appointment Book, 3-12,
3-23

 Database, 4-30

 defining databases, 4-30

 Memo Editor, 7-18

 Note Taker, 8-7

 Phone Book, 4-30

 Smart Clip, 4-32

 Subset, 4-32

 World Time, 5-11

function plotting, 19-36

 autoscaling, 19-44

 displaying coordinates, 19-37

 extremum, 19-38

 function keys, 19-43

 how it works, 19-42

 interactive graphics, 19-44

 plot conditions, 19-43

 zoom, 19-36

function shift key, 1-20

functions (Solver), 19-14, 19-15

FV function key, 14-2

G

games, F-1

GDB file extension, 22-10, 25-4

gender converter, 26-7

General function key, 4-25

GO function key, 14-8

Goto a record, 4-4

Goto city in list, 5-2

Goto function key (Appt Book),
3-23

Goto Line Number command,
7-11

Goto note in list, 8-5

GRAD annunciator, 12-3

graduated payment mortgage
(GPM), 14-12

Graph function key, 19-7

graphing

 models, 17-8

 Solver, 19-36

 statistics, 17-8

gray shades in DOS, 25-17

green keys, 1-2

Group box (Database), 4-8

 adding to database, 4-10

grouped cash flows, 15-5

- grouped standard deviation,
 - 17-5
- group field, editing, 9-13
- group options, 9-7
- groups, 9-4
 - adding, 9-7
 - changing the field title, 9-7
 - class, 9-7
 - client, 9-7
 - for expense reporting, 9-8
 - list, 9-7
 - project, 9-7
 - trip, 9-7
- G.STDEV function key, 17-3
- Guilder symbol, displaying,
 - 21-6
- H**
- hangup command (Datacomm),
 - 26-9
- hard reset, 1-8, 24-5
- hardware features, 1-2
- headers, 7-6
- Hearts & Bones, F-1
- help
 - availability, 1-3
 - for DOS, 25-5
 - menu, 1-31
- hierarchical numbering in
 - memos, 7-13
- higher-level directory, 22-8
- highlight bar, 1-19
 - moving between split windows,
 - 22-11
- highlighting text range, 1-26
- history stack, 12-8
 - clearing, 12-14
- HMS function key, 12-18
- home base, 9-2
- home up/down, 1-15
- Host, cc:Mail, 29-15
- hour conversions, 12-18
- hourglass annunciator, 1-13
- hour of the day, 3-21
- HP 100LX files, 3-19, 4-5
- HP100LX.FON, 25-10
- HP100LX.KIT, 25-10
- HP 95LX
 - applications, 24-1
 - translating files, 3-19, 4-5
- HP 95LX files in the HP 200LX,
 - 22-15
- HP F1015A cable (PC), 27-1,
 - 28-1
- HP F1023A Connector/Adapter Kit, 28-1
- HP F1023 Connector/Adapter Kit, 27-1
- HP LaserJet, 28-2
- HR, 12-18
- humidity limits, B-6
- I**
- IBM numeric keypad, 25-14
- IBM ProPrinter, 28-2
- ICN file extension, 24-3, 25-4
- icon, program, 24-2
- Icons View, 24-4
- Iconv function key, 14-2
- IDX file extension, 22-10, 25-4
- IF function (Solver), 19-22
- importing Quicken data, 9-17
- importing text file to mail,
 - 29-13
- Inbox folder, 29-5
- information services, 26-10
 - connecting to, 26-10
- infrared. *See* IR
- infrared port, 1-1
- INI file extension, 22-10, 25-4
- initialization string, 7-17
 - print setup, 7-17

- initialization strings, 28-5
 - Insert command (Memo), 7-10
 - INSERT function key, 15-3, 17-2, 19-7
 - Insert function key (Note Taker), 8-3
 - inserting a memo into a note, 8-3
 - inserting memos, 7-10
 - inserting text file in mail, 29-13
 - insert line (Memo), 7-2
 - Insert mode (Memo), 7-2, 7-12
 - insert/replace mode cursors, 1-13
 - installing applications, 24-1
 - installing DOS programs, 24-2, 25-14
 - installing SMC applications, 24-1
 - integer part, 12-15
 - Interactive Connection, 29-2
 - closing, 29-18
 - opening, 29-18
 - reading mail, 29-18
 - interactive graphics, 19-44
 - interest rates, 14-15
 - Internal Rate of Return (IRR%), 15-1
 - international
 - keyboard characters, C-4
 - International Prefix field (World Time), 5-4
 - INT function key, 14-8
 - inverting display colors, 25-16
 - I%PER function key, 14-15
 - IP function key, 12-16
 - IR
 - connection broken, 22-14, 22-16
 - IR communication
 - baud rate, 22-13
 - configuring for, 22-13
 - IR connection
 - positioning computers, 22-13
 - transferring files, 22-12
 - turning off, 22-14
 - IR & DOS port power, 25-9
 - IR interface (Datacomm), 26-3
 - IR port, 1-1
 - file/directory transfer, 22-15
 - file transfer, 22-13
 - IRR%/YR function key, 15-3
 - items
 - copying, 1-26, 1-27
 - deleting, 1-22, 1-26
 - moving, 1-26, 1-27
 - selecting, 1-21
 - I%/YR function key, 15-3
 - I%YR function key, 14-2, 14-15
 - I%YR ' function key, 14-8
- K**
- KEYB command, 25-10
 - KEYBEZ, 21-6, 25-9, D-1
 - how to use, 25-11
 - with 1-2-3, 25-12
 - KEYBEZ.FON, 25-10
 - KEYBEZ.KIT, 25-10
 - keyboard, 1-19
 - accented characters, C-4
 - Calculator, 12-3
 - international characters, C-4
 - special characters, C-4
 - Keyboard Information Table
 - file (KIT), 25-10
 - keyboard overlays (South East European), D-3
 - keyboard remapping, 25-9
 - keys
 - application, 1-9, 24-2
 - Datacomm window moving, 26-10

- meanings of, 1-19
- shortcut, 24-2
- KIT file extension, 22-10, 25-4, 25-9
- KIT (Keyboard Information Table File), 25-10
- L**
- Label field (Database), 4-8
- labels
 - function key, 1-13
- Lair of Squid, F-1
- LapLink, 30-1
- LaserJet printer, 28-2
- LAST**, 12-4
- Latin-2 code page, D-10
- Latin/Greek code page, D-8
- latitude and longitude of city, 5-4
- launching DOS, 25-1
- LCF file extension, 22-10, 25-4, 26-13
- leadtime for alarms, 3-4
- lease, 14-6
- leaving DOS applications, 24-5
- leaving SMC applications, 24-5
- length conversions, 16-3
- limits
 - Database, 4-30
 - humidity, B-6
 - Note Taker, 8-6
 - Phone Book, 4-30
 - temperature, B-6
 - World Time, 5-10
- line scrolling, 26-10
- line spacing in memos, 7-12
- line wrap (Datacomm), 26-4
- list boxes, 1-15
 - category, 4-22
 - open, 1-15, 1-17
 - scrolling in, 1-17
 - using, 1-17
- listing files, 22-7
- listing order of files, 22-7
- list of categories, 9-5
- list of directories, 22-6
- list of files, 22-5, 22-6
- list of groups, 9-7
- lists, 1-11
 - appointment, 3-8
 - note, 8-1
 - sorting, 4-16
- List Stat, 17-1
 - examples, 17-3
- list style, printing, 28-3
- List View, 24-4
- LN function key, 12-16
- Local Address Book
 - deleting names, 29-7
 - updating, 29-7
- Local City, 5-2
- local city, specifying, 5-2
- local echo, 26-4
- >Local function key , 5-2
- local window, 22-14
- Locate function key, 5-4
- Location field
 - appointment, 3-2
 - World Time, 5-4
- logarithmic functions, 12-16
- LOG function key, 12-16
- logon script files, 26-4, 26-12, 26-13
- Lotus 1-2-3, 2-1
- Lotus cc:Mail, 29-1
- low-battery message, B-1
- lower-level directory, 22-8
- M**
- M function key, 12-11
- MAC file extension, 22-10, 25-4
- macro record, 23-1

- mail
 - attaching DOS file, 29-13
- mailing lists, 29-10
- making transactions, 9-10, 9-12
- managing your applications, 24-1
- manual-lock mode, 1-4
- Map function key, 5-6
- map, locating cities, 5-4, 5-6
- margin, 13-2
- margins, 7-6
- marketing headquarters (outside U.S.), A-3
- marking directories, 22-5
- marking files, 22-5
- markup, 13-2
- mass conversions, 16-3
- mass storage cards, 1-7
- matching text in appointments, 1-26
- Math function key, 19-21
- MAX function key, 17-3
- maximizing RAM, 24-6
- MDM file extension, 22-10, 25-4
- MEAN function key, 17-3
- MEDIAN function key, 17-3
- Memo Editor, 7-1
 - compared to Note Taker, 8-1
- memo file
 - transferring, 7-4
- memory
 - allocation, 21-5
 - clearing, 1-8
 - clearing in Calculator, 12-14
 - management, 1-5
 - RAM disk, 24-5
 - ROM, 24-5
 - system RAM, 24-5
 - types, 24-5
 - usage, 24-6
 - used by 1-2-3, 24-6
- memory allocation, 21-5
 - DOS, 24-2, 25-14
 - specifying, 21-4
- memory cards, 1-7, 22-8, 22-12
 - copying to, 22-9
 - environmental limits, B-6
 - formatting, 22-8
- memory division, 21-1
- memory limitations
 - Database, 4-30
 - Note Taker, 8-6
 - Phone Book, 4-30
 - World Time, 5-10
- memos
 - backing up, 7-3
 - clipping from other
 - applications to, 7-9
 - copying, 7-10
 - creating, 7-2
 - deleting, 7-10
 - editing, 7-2, 7-7
 - formatting, 7-6
 - inserting, 7-10
 - inserting into notes, 8-3
 - moving around, 7-2
 - opening one of the last two, 7-7
 - outlining, 7-13
 - password protecting, 7-5
 - printing, 7-15
 - printing specifications for, 7-16
 - reading, 7-7
 - renaming, 7-10
 - saving, 7-3
 - searching for text in, 7-11
- menu bar, 1-10
- menu commands, 1-13, 1-14
 - dimmed, 1-14
 - standard PIM, 1-22
- menu key, 1-20, 1-22

- menus, 1-13
 - canceling, 1-15
 - pull-down, 1-13
 - scanning, 1-14
 - top-level, 1-23
 - using, 1-14
- merging Appt Book files, 3-18
- merging categories, 9-6
- merging equation lists, 19-7
- merging Note Taker files, 8-6
- merging Phone Book files, 4-5
- merging Quicken files, 9-17
- message directories, 29-14
- messages
 - Alarm Clock, 6-2
 - attaching DOS file, 29-13
 - copying, 29-12
 - Countdown Timer, 6-2
 - deleting, 29-12
 - detaching from mail, 29-14
 - extracting file from, 29-11
 - inserting text file, 29-13
 - moving, 29-5, 29-12
 - printing, 29-13
 - saving, 29-11
 - sending, 29-11
 - viewing, 29-19
- messages (cc:Mail)
 - reading, 29-3
 - receiving, 29-3
 - replying to, 29-4
 - sending, 29-4
 - writing, 29-4
- M+ function key, 12-11
- MIN function key, 17-3
- (minus) in Appt Book, 3-9
- (minus) in World Time, 5-2
- M- function key, 12-11
- MODE command, 25-10
- modem cards, 25-8
- modem commands
 - backslash (\), 29-17
 - circumflex (^), 29-17
- modem file (cc:Mail), 29-16
- modem init (Datacomm), 26-4
- modems, 25-8
 - connecting, 27-1
 - null adapter, 26-7
 - plug-in cards, 27-2
 - serial, 27-2
- Modify Database command, 4-7, 4-14
- modifying palmtop operation, 25-17
- month-at-a-glance, 3-2
- Month function key, 3-23
- monthly appointment lists
 - changing the default, 3-21
- monthly appointments, 3-9
- Monthly repeat option (Appt), 3-2
- MORE key, 1-2
- mortgage with balloon, 14-4
- moving categories, 9-5
- moving cursor to line number (Memo), 7-11
- moving database fields, 4-10
- moving directories, 22-3
- moving directories (split screen), 22-11
- moving files, 22-3
- moving files (split screen), 22-11
- moving items in a list, 1-27
- moving note fields, 8-3
- moving window in display (Datacomm), 26-10
- M register, 12-11
- MSG file extension, 22-10, 25-4
- MTCONV, 26-17
- multiple equation lists, 19-7

N

- naming databases, 4-11
- nDay+/- function keys, 3-12
- NDB file extension, 22-10, 25-4
- negative amortization, 14-13
- negative numbers, 12-3
- Net Future Value (NFV), 15-1
- Net Present Value (NPV), 15-1
- Net Uniform Series (NUS), 15-1
- NEW function key, 13-2
- Next Appointment, 3-20
- Next function key, 4-31, 8-7
- N! function key, 12-20
- N function key, 14-2
- NFV function key, 15-3
- Nickel-Cadmium batteries, B-4
- NLS
 - supported countries, 25-11
 - utility, 25-10
- NLSFUNC command, 25-10
- NLS (National Language Support), 25-9
- No DST setting, 5-8
- nominal interest rates, 14-15
- No Repeat option (Appt), 3-2
- Northern DST setting, 5-8
- Note fields
 - appointment, 3-2
 - clearing (Note Taker), 8-4
 - copying, 8-3
 - Database, 4-9
 - moving, 8-3
 - World Time, 5-4
- Note function key, 3-2, 4-31, 8-7
- note lists, 8-1
 - adding to, 8-2
 - limitations, 8-6
 - searching, 8-5
- note records
 - adding, 8-2
 - copying, 8-3
 - deleting, 8-4
 - editing, 8-3
 - maximum number, 8-6
 - opening, 8-1
 - saving, 8-2
 - saving as ASCII files, 8-3
 - searching for text in, 8-5
 - viewing, 8-1
- notes
 - Full Screen, 8-1
 - inserting memos, 8-3
 - length, 8-2
 - restoring deleted, 8-4
- Note Taker, 8-1
 - compared to Memo Editor, 8-1
 - data card, 8-4
 - erasing files, 8-4
 - files, 8-6
 - new, 8-6
 - printing, 28-3
 - subsets, 8-6
- NPV function key, 15-3
- null modem adapter, 26-7
- Number Consecutive Days field
 - appointment, 3-2
- Number field (Database), 4-8
- Number Format, 20-1
- Number of Digits, 20-1
- Number, phone (Datacomm), 26-3
- number precision, 12-3
- numeric keypad, 25-14
- NUM→ function key, 19-21
- NUS function key, 15-3

O

- odd parity, 26-3
- OFF key, 1-1
- OLD function key, 13-2

$1/x$, 12-4

1-2-3

- currency settings, 21-7
- KEYBEZ, 25-12
- memory use, 24-6
- punctuation settings, 21-7
- sort order, 21-8
- using Calculator data, 12-12

1-2-3 function key, 14-8, 19-7,
19-8

1-2-3 macros

- running from a System Macro,
23-5

1-Var annunciator, 12-3

1-Var function key, 17-4

online help, 1-31, 25-5

ON/OFF key, 1-1

open application, 1-6

Open function key, 4-31, 8-7

opening a memo file again (last
two), 7-7

opening DOS, 25-1

opening DOS applications, 24-4

opening note records, 8-1

opening SMC applications, 24-4

opening System Manager, 24-6

Operation Mode, 20-1

operator priority

- Solver, 19-14

option buttons, 1-15

- adding to database, 4-10
- in Smart Clips, 1-30
- in subset definitions, 4-20
- selecting, 1-16
- testing for subset definitions,
4-27

Option buttons (Database), 4-8

Options

- Group, 9-7
- Quickfill, 9-14

Options menu, 1-23

Appointment Book, 3-19

ordering files, 22-7

Other function key, 19-21

Outbox folder, 29-5

outbox, Prefix, 29-15

Outline command (Memo),
7-14

outlined text

- changing the level of, 7-14,
7-15

demoting, 7-14, 7-15

promoting, 7-14, 7-15

removing a number, 7-15

stopping, 7-15

without numbers, 7-14

outline indentation, 7-14

outline numeration, 7-14

outlining memos, 7-13

overlays (South East European),
D-3

OVL file extension, 25-4

P

page breaks, 7-6

page length

- print setup, 7-17

page numbers

- for memos, 7-7

pages of a database, 4-10

page up/down, 1-19

parity, 26-3

PART function key, 13-2

password, changing cc:Mail,
29-14

passwords

- auto-lock, 1-4

changing, 1-4

for files, 1-25

in Quicken, 1-25

manual-lock, 1-4

setting, 1-4

- passwords for files, 1-25
- PASTE, 7-8
- PASTE key, 1-26
- path name, 1-24
- PBK files, 4-6
- PC
 - connecting to palmtop, 26-6
- PCF file extension, 22-10, 25-4
- PCMCIA modem cards, 25-8
- PCMCIA standard, 1-7
- PCX file extension, 21-8, 22-10, 25-4
- PDB file extension, 22-10, 25-4
- PDB files, 4-6
- PDT file extension, 22-10, 25-4
- %, 12-6
- percentages, 13-1
- percent change, 13-2
- %CHG function key, 13-2
- percent of total, 13-2
- permutations, 12-20
- Personal Information Management, 1-11
 - menus for, 1-22
- personal phone list, 4-22
- Phone Book, 4-1
 - new, 4-5
 - printing, 28-3
 - searching, 4-4
- Phone Book data card, 4-4
- Phone Book field
 - adding or deleting, 4-3
- Phone Book files, 4-5
 - translating from HP 95LX, 4-5
- Phone Book structure
 - altering, 4-3
- phone configuration options (Datacomm), 26-3
- phone lists
 - limitations of, 4-30
- phone numbers
 - dialing with Datacomm, 26-10
- phone records, 4-1
 - maximum number, 4-30
- Phone Settings dialog box, 26-3
- PIC file extension, 22-10, 25-4
- picture display, 21-8
- PI function key, 12-17
- pin connections, 26-7
- pipe for DOS memory, 24-2, 25-14
- plot conditions, 19-43
- Plot function key, 15-3
- plotting
 - cash flows, 15-8
 - in Solver, 19-36
 - NPV vs. I%/YR, 15-8
 - statistics, 17-8
- plug-in cards
 - environmental limits, B-6
- plug-in card slot, 22-1
- + in World Time, 5-2
- +/-**, 12-4
- PMT function key, 14-2
- PMT' function key, 14-8
- Pocket Quicken. *See* Quicken
- point and shoot, 12-12
- polar/rectangular conversions, 12-18
- Popul annunciator, 12-3
- population standard deviation, 17-4
- Popul function key, 17-3
- ports
 - IR, 1-1
 - serial, 1-1
- positioning computers for IR
 - connection, 22-13
- Pound symbol, displaying, 21-6
- power adapter, B-6
 - charging rates, B-5

- power level of battery, 21-1
- power saving, 21-9
- power supply, B-6
- power to ports, 25-9
- precision, 12-3
- preferences
 - entry, 9-16
 - group, 9-7
 - Quickfill, 9-14
- Prefix outbox, 29-15
- Prev function key, 4-31, 8-7
- PRIN function key, 14-8
- printed symbols, 28-5
- printer configuration, 2-4
- printer connection
 - Epson FX-80, 28-2
 - HP LaserJet, 28-2
 - IBM ProPrinter, 28-2
- printer control sequences, 28-5
- printer, current type, 21-1
- printers
 - Epson FX-80, 28-2
 - HP LaserJet, 28-2
 - IBM ProPrinter, 28-2
 - using, 28-1
- printing, 28-3
 - account balances, 11-2
 - categories, 11-3
 - expense reports, 11-3
 - Quicken reports, 11-1
 - registers, 11-1
 - splits, 11-1
- printing amortization tables, 14-13
- printing codes (memos), 7-17
- printing date and time fields, 7-7
- printing from other computers, 7-15
- printing lists (PIM), 28-3
- printing mail, 29-13
- printing memos, 7-15
- printing page numbers (Memo), 7-7
- printing PIM files, 28-3
- printing records (PIM), 28-5
- printing setup
 - Memo, 7-16
 - PIM, 28-5
- printing specifications (memos), 7-16
- printing to-do items, 28-5
- printing to file, 7-15
- printing with Smart Clips, 28-5
- print parameters
 - Memo, 7-16
 - PIM, 28-5
- print to file (PIM), 28-5
- priority setting
 - changing the default, 3-22
- Private Address Book, 29-6
- PRN file extension, 22-10, 25-4
- PrntFld function key, 7-7, 7-18
- probability functions, 12-20
- Prob function key, 19-21
- program icon, 24-2
- programs
 - running by appointment, 3-15
 - running from drive A, 25-15
 - running from drive E, 25-15
 - starting in DOS, 25-1
- project group, 9-7
- Promote function key, 7-13, 7-14
- promoting outlined text, 7-14
- promoting subcategories, 9-5
- protecting (backing up) files, 22-9
- Public Address Book, 29-6
- punctuation setting, 21-6
- punctuation settings

1-2-3 vs. other applications,
21-7

PV function key, 14-2

Px,y function key, 12-20

P/YR function key, 14-2, 14-15,
15-3

Q

QIF files, 9-18

Quicken

accounts, 9-1

accounts in brackets, 9-15

adding categories, 9-5

adding earlier transactions,
10-7

adding groups, 9-7

balancing accounts, 10-1

balancing problems, 10-4

basics, 9-1

beeping preference, 9-16

categories, 9-4

category list, 9-5

changing category names,
9-5

choosing a file, 9-4

class, 9-7

client, 9-7

concepts, 9-1

data organization, 9-1

deleting accounts, 9-3

deleting categories, 9-6

demoting categories, 9-5

editing accounts, 9-2

entry preferences, 9-16

expense reporting, 9-8

exporting files, 9-17

fields, 9-11

files, 9-1

groups, 9-4, 9-6

group title, 9-7

home base, 9-2

importing files, 9-17

merging categories, 9-6

merging files, 9-17

moving categories, 9-5

password protection, 1-25

printing, 11-1

project, 9-7

promoting subcategories, 9-5

QIF files, 9-18

QuickFill, 9-14

QuickKeys, 9-14

reconciling accounts, 10-1

register, 9-9

selecting accounts, 9-2

setting up accounts, 9-1

setting up files, 9-3

sharing data, 9-17

splitting transactions, 9-14

subcategories, 9-5

subgroups, 9-7

transactions, 9-10

transferring between accounts,
9-15

trimming files, 9-3

trip, 9-7

QuickFill, 9-14

QuickKeys, 9-14

Quit command, 1-23

quitting applications, 1-9, 22-2

quitting Datacomm, 26-9

quitting data communication,
26-9

quitting dialog boxes, 1-18

quitting DOS, 24-5

quitting DOS applications, 24-5

quitting SMC applications, 24-5

quitting System Manager, 24-6

R

→RAD function key, 12-18

RAD annunciator, 12-3

- radio interference, E-1
- RADIUS function key, 12-18
- RADIX, 26-15, 26-17
- RAM, 21-4, 24-5
 - available, 24-6
 - disk, 1-5, 21-4, 24-5
 - disk, allocation, 21-4
 - division, 21-1
 - managing, 1-5
 - maximizing, 24-6
 - system, 1-5
 - total, 24-6
 - used by 1-2-3, 24-6
- random number generator, 12-20
- RAN# function key, 12-20
- ranges, deleting or copying, 1-26
- RCF file extension, 22-10
- (RCL)**, 12-4, 12-10
- RCL annunciator, 12-3
- RCONV, 26-15, 26-17
- reading mail
 - Interactive Connection, 29-18
- reading messages (cc:Mail), 29-3
- rebooting the system, 1-8, 24-5, 25-18
- reboot options, 25-18
- recalling numbers to calc line, 12-8
- receiving messages (cc:Mail), 29-3
- REC file extension, 25-4
- rechargeable batteries, B-4
- recharging rates, B-5
- reciprocal, 12-4
- Reconcile Problem screen, 10-4
- Reconcile Register screen, 10-3
- reconciling accounts, 10-1
 - problems, 10-4
- record fields, 1-16
- recording system macros, 23-1
- records, 1-11, 1-12, 3-1, 4-2
 - city, 5-2
 - printing, 28-5
 - selecting subsets of, 4-19, 4-23
- recovering deleted directories, 22-3
- recovering deleted files, 22-3
- redirector, 30-1
- register (Quicken), 9-9
- registers, 12-10
- regulatory information, E-1
- relational operators
 - SSL, 4-26
- remap (CTF file), 26-4
- remapping, keyboard, 25-9
- remote
 - connection broken, 22-14, 22-16
 - system, 26-6
 - window, 22-14
- removing city records from
 - Custom list, 5-6
- Rename function key, 4-32
- renaming directories, 22-4
- renaming files, 22-4
- repair, A-3
- Repeat function key, 3-2
- repeating appointments, 3-2, 3-4
 - changing to one-time, 3-13
- repeating events, 3-6
- Repeat options (Appt), 3-2
- repeat status, 3-6
- Replace function key, 7-11
- Replace mode (Memo), 7-2, 7-12
- replacing batteries, B-1
- replacing mail directory, 29-14

- replacing specified text, 7-11
 - replying to messages (cc:Mail), 29-4
 - reserved file names, 25-3
 - reset options, 25-18
 - resetting the system, 1-8, 24-5, 25-18
 - RES function key, 19-43
 - restarting System Manager, 24-7
 - restaurant database, 4-7
 - restoring a deleted note, 8-4
 - restoring deleted city records, 5-5
 - restoring deleted text in memos, 7-8
 - restoring deletions, 3-14, 4-3
 - Reverse Polish Notation, 12-14
 - RM function key, 12-11
 - RND function key, 12-16
 -  key, 12-4
 - ROM, 24-5
 - definition, 1-5
 - Roman numerals in outlining, 7-13
 - ROM cards, environmental limits, B-6
 - ROM city, 5-5
 - root directories
 - files in, 25-3
 - root directory, 22-1
 - RPN annunciator, 12-3
 - RPN syntax, 12-14
 - RTCONV, 26-17
 - Ruler command, 7-12
 - ruler (Memo), 7-12
 - rules for Solver equations, 19-13
 - running DOS, 25-1
 - running files, 22-4
 - running programs
 - by appointment, 3-15
 - from drive A, 25-15
 - from drive E, 25-15
 - running system macros, 23-2
- S**
- sad face (to-dos), 3-17
 - Sample annunciator, 12-3
 - Sample function key, 17-3
 - sample statistics, 17-4
 - Save As command, 7-3, 7-4, 7-10
 - Save As function key (Note Taker), 8-8
 - Saved Message folder, 29-5
 - Save function key, 7-8
 - saving accounts, 9-1
 - saving battery power, 21-9
 - saving cash-flow data, 15-2
 - saving data, 1-6
 - saving database definitions, 4-11
 - saving Datacomm configurations, 26-5
 - saving mail, 29-11
 - saving memos, 7-3
 - saving memos automatically, 7-5
 - saving received data (Datacomm), 26-11
 - savings account, 14-5
 - saving system macros, 23-4
 - scheduling appointments, 3-2
 - Scientific format, 20-1
 - screen
 - split (two-window), 22-11
 - switching between local and remote, 22-14
 - switching between split and full, 22-11
 - screen annunciators, 1-13
 - script files, 26-4, 26-12

- logon, 26-13
 - special characters, 26-13
 - use during connection, 26-13
- scrolling in boxes, 1-17
- scrolling lines, 26-10
- searching a database, 4-4
- searching a memo file, 7-11
- searching for text in files, 22-4
- searching for text in PIM, 1-25
- searching the note list, 8-5
- Search menu, 1-23
- seed, 12-20
- SEED function key, 12-20
- selecting directories, 22-5
- selecting files, 22-5
- selecting items, 1-21
- selecting Quicken accounts, 9-2
- selecting subsets of data, 4-19, 4-23
- selecting text in memos, 7-8
- selecting text range, 1-26
- sending mail, 29-11
- sending messages (cc:Mail), 29-4
- SERCTL, 25-9
- serial cable
 - adapters for, 26-6
 - connecting modem and palmtop, 26-6
 - connecting PC and palmtop, 26-6
 - pin connections, 26-7
- serial cable (PC), 27-1, 28-1
- serial interface (Datacomm), 26-3
- serial modems, 27-2
- serial port, 1-1
- server, 30-1
- service, A-3
- setting 1-2-3 sorting order, 21-8
- setting audio volume, 21-3
- setting currency symbol, 21-6
- setting display contrast, 21-4
- setting memory allocation, 21-4
- settings
 - Appointment Book, 3-19
 - country default, 21-6
- setting the date, 21-2
- setting the date format, 21-2
- setting the time, 21-3
- setting the time format, 21-3
- setting up Quicken accounts, 9-1
- setting up Quicken files, 9-3
- Setup
 - starting, 21-1
 - vs. KEYBEZ, 21-6
- Setup command (Memo), 7-5
- setup printing information
 - Memo, 7-16
 - PIM, 28-5
- S function (Solver), 19-23
- shared Solver variables, 19-6
- sharing Quicken data, 9-17
- shift annunciator, 1-13
- shift key, 1-2, 1-20
- shortcut keys, 1-14, 24-2
 - in databases, 4-11
- Show DataCard, 4-15, 8-4
- Show Registers, 20-1
- Show Stack, 20-1
- simple interest, 12-6
- SIN function key, 12-17
- 6 Month function key, 3-23
- Size function key, 4-30
- size of characters, 1-10
- size of display (Datacomm), 26-10
- sizing database fields, 4-10
- Smart Clip, 1-28, 7-9
 - definitions, 4-11
 - printing using, 28-5

- SMC applications, 24-1
 - closing, 24-5
 - installing, 24-1
 - leaving, 24-5
 - opening, 24-4
 - quitting, 24-5
- .SND file, 3-22
- snooze alarms, 3-6
- Solve Catalog, 19-1
 - function keys, 19-7
- solve cell, 19-8
- Solve function key, 19-45
- Solver
 - algebraic expression, 19-25
 - back-solving, 19-8
 - catalog, 19-1
 - clearing variables, 19-5
 - conditional expressions, 19-22
 - constants, 19-14
 - counter variable, 19-25
 - date formats, 19-15
 - deleting equations, 19-6
 - editing equations, 19-5
 - ending value, 19-25
 - entering equations, 19-2
 - entering guesses, 19-12
 - equation length, 19-13
 - equation list, 19-2
 - equation rules, 19-13
 - examples, 19-26
 - function plotting, 19-36
 - functions, 19-14, 19-15
 - functions listing, 19-15
 - graphing, 19-36
 - how it works, 19-11
 - in 1-2-3, 19-8
 - interactive graphics, 19-44
 - iterative search, 19-12
 - logical operators, 19-22
 - multiple equation lists, 19-7
 - multiple equations, 19-23
 - operator priority, 19-14
 - relational operators, 19-22
 - rules, 19-13
 - shared variables, 19-6
 - solve cell, 19-8
 - starting value, 19-25
 - step size, 19-25
 - summing function, 19-25
 - TVM functions, 19-24
 - variables, 19-5, 19-13
 - worksheet, 19-9
- Solver examples, 19-26
- Sort function key, 4-31, 8-7, 17-2
- sorting data lists, 4-16
- sorting files, 22-7
- sorting order in data lists
 - changing, 4-16
- sorting orders in data lists
 - examples, 4-16
- sort order, 25-9
 - setting for 1-2-3, 21-8
- sound file, 3-22
- Southern DST setting, 5-8
- spacing in memos, 7-12
- speaker volume, 21-3
- special characters, C-4
- specifying a picture display, 21-8
- specifying a Topcard, 21-8
- specifying audio volume, 21-3
- specifying display contrast, 21-4
- specifying memory allocation, 21-4
- speed-locate, 4-4
 - city list, 5-2
 - in list boxes, 1-17
 - note list, 8-5
- split screen, 22-11
 - file/directory transfer, 22-15
 - file transfer, 22-13

- switching from split to full, 22-11
- switching window between local and remote, 22-14
- splitting transactions, 9-14
- \sqrt{x} , 12-4
- square root, 12-4
- SSL, 4-25
 - compared with Define Subset screen, 4-28
- SSL operators, 4-26, 4-27
- SSL statements, 4-25
 - examples, 4-29
- stack, 12-8
 - clearing, 12-14
- STA file extension, 22-10, 25-4
- stamping date and time, 1-20
- standard deviation, 17-4
- Start Date field
 - appointment, 3-2
- starting DOS applications, 24-4
- starting Setup, 21-1
- starting SMC applications, 24-4
- starting System Manager, 24-7
- starting value (Solver), 19-25
- Start Time field, 3-2
- startup application, 20-2
- statistics, 17-1
 - calculating, 17-3
 - curve fitting, 17-5
 - data entry, 17-1
 - examples, 17-3
 - forecasting, 17-5
 - graphing, 17-8
 - models, 17-8
 - plotting, 17-8
 - summations, 17-8
- Stats function key, 17-3
- status bar (Memo), 7-12
- Status command, 7-12
- STDEV function key, 17-3
- step size, 19-25
- sticky shift key, 1-2
- STO**, 12-4, 12-10
- STO annunciator, 12-3
- stop bits, 26-3
- stopping data communication, 26-9
- Stopwatch, 6-1
- storage cards, 1-7
- storing numbers (Calc), 12-10
- structure of a database, 4-8
- subcategories, 9-5
 - promoting, 9-5
- subdirectories, 22-1, 25-3
- subgroups, 9-7
- subset
 - current directory, 22-7
- subset definitions, 4-18
 - comparing methods of, 4-28
 - deleting, 4-11, 4-25
 - editing, 4-25
 - examples, 4-24, 4-29
 - logical operators, 4-23
 - operators for, 4-26, 4-27
- subset definitions with multiple criteria, 4-23
- Subset function key, 4-18, 4-31, 5-9, 8-6
- subsets, 4-18, 4-25
 - defining, 4-19, 4-23, 4-25
 - defining database (example), 4-20
 - defining with operators, 4-23
 - of city list, 5-9
 - of note list, 8-6
 - viewing, 4-19
- summation statistics, 17-8
- summing function (Solver), 19-25
- Sums function key, 17-8
- support, A-2

- SwapVar function key, 17-2
- switching between local and remote windows, 22-14
- switching between split and full screen, 22-11
- Sync view, 22-6
- syntax symbols, 25-6
- SYS file extension, 25-4
- system date, 3-12
- system macro examples, 23-5
- system macros, 23-1
- System Manager
 - closing, 24-6
 - restarting, 24-7
- System Manager applications, 25-10
- System-Manager-compliant, 24-1
- System Manager vs. DOS applications, 21-6
- system RAM, 1-5, 21-4, 24-5, 24-6
- system reset, 1-8
- system time, 5-2
- System time
 - offset from (World Time), 5-4

T

- tab key, 1-20
- tabs, 7-6
- tagging files, 22-5
- TAN function key, 12-17
- TCONV, 26-15, 26-17
- temperature conversions, 16-3
- temperature limits, B-6
- 10^X function key, 12-16
- termination string, 7-17
 - print setup, 7-17
- termination strings, 28-5
- testing criteria for subsets, 4-24
- text
 - copying, 1-27
 - deleting, 1-27
 - moving, 1-27
 - searching for in files, 22-4
- text boxes, 1-15
- Text field (Database), 4-8
- text files
 - formatted and unformatted, 7-4
 - inserting in messages, 29-13
 - viewing, 22-4
- text range highlighting, 1-21, 1-26
- thousands separator, changing symbol, 21-6
- 360/5 function key, 14-15
- 360/365 method, 14-15
- 360/YR function key, 18-1
- 365/YR function key, 18-1
- time
 - around the world, 5-1
 - converting across time zones, 5-7
 - default setting, 21-6
 - delimiters, 21-3
 - interpreting (Appt Book), 3-21
 - intervals in appointments, 3-21
 - local, 5-2
 - setting, 21-3
 - setting format, 21-3
 - stamping, 1-20, 8-2
 - zones, 5-7
- time fields
 - appointment, 3-2, 3-11
 - Database, 4-8
- time intervals in appointments, 3-21
- timeline option, 3-21

- timelines, 3-11
- Time Offset From field (World Time), 5-4
- Timeout (Datacomm), 26-3
- time print fields (Memo), 7-7
- time stamping, 7-3
- title bar, 1-10
- Title field, 8-2
- TMP file extension, 25-4
- Today function key, 3-12
- TODAY function key, 18-1
- to-do daily greeting, 3-23
- ToDo Defaults, 3-22
- ToDo function key, 3-23
- to-do items
 - symbols for, 28-5
- to-do lists, 3-16
 - components, 3-20
- to-do record, 3-16
- to-dos
 - symbols for, 3-16
- to-do settings, 3-22
- Topcard, 21-8
- top margin, print setup, 7-17
- %TOTAL function key, 13-2
- TOTAL function key, 13-2
- total RAM, 24-6
- transaction reports, 11-1
- transactions, 9-10
 - adding, 9-12
 - deleting, 9-13
 - editing, 9-13
 - entering, 9-12
 - making, 9-12
 - splitting, 9-14
 - voiding, 9-13
- Transaction Type field, 9-12
- transferring between accounts, 9-15
- transferring directories between HP 200LXs, 22-13
- transferring directories
 - HP 200LX to HP 95LX, 22-15
- transferring directories (IR connection), 22-12
- transferring files, 22-12
 - HP 100LX to HP 200LX, 22-14
- transferring files between
 - HP 200LX and HP 95LX, 22-15
- transferring files between HP 200LXs, 22-13
- transferring files, HP 95LX to HP 200LX, 22-15
- transferring files (IR connection), 22-12
- transferring Quicken data, 9-17
- translating 100LX files, 4-5
- translating characters (Datacomm), 26-14
- translating HP 95LX Appt Books, 22-15
- translating HP 95LX files, 3-19, 4-5
- translating HP 95LX Phone Books, 22-15
- Tree View, 22-6
- Trig function key, 19-21
- trigonometric functions, 12-17
- trimming data files, 9-3
- Trip field, 9-12
- trip group, 9-7
- trout fishing, 3-6
- TSRs, 25-15
- Turkish code page, D-9
- TV interference, E-1
- TVM
 - amortization, 14-7
 - car loan, 14-3
 - cases, 14-2

- clearing data, 14-3
- discounted mortgage, 14-18
- erasing data, 14-3
- function keys, 14-1
- interest-only loan, 14-21
- interest rate conversions, 14-15
- lease, 14-6
- loan with fees, 14-20
- mortgage with balloon, 14-4
- procedure, 14-3
- savings account, 14-5
- screen, 14-1
- Solver functions, 19-24
- taxable retirement account, 14-24
- tax-free account, 14-22
- variables, 14-3
- 2-Var annunciator, 12-3
- 2-Var function key, 17-4
- two-window display, 22-11
- TXT file extension, 22-10
- typefaces, 7-6
- types of accounts, 9-1
- types of memory, 24-5

U

- undelete, 3-14, 4-3
- underlined text, 7-6
- undo, 1-21
- Undo command, 1-31, 4-14, 4-25
 - Clipboard, 1-26
- uneven cash flows, 15-1
 - examples, 15-3
 - plotting, 15-8
- unit conversions
 - area, 16-3
 - currency, 16-1
 - length, 16-3
 - mass, 16-3

- temperature, 16-3
- volume, 16-3
- Universal time, offset from, 5-4
- Unsync view, 22-6
- updating address books, 29-7
- use of memory, 24-6
- using printers, 28-1

V

- valid characters, file names, 25-3
- VALUE function key, 19-8
- values, moving between
 - Calculator and 1-2-3, 12-12
- variables (Solver), 19-5, 19-13
- viewing complete directory, 22-7
- viewing directory subset, 22-7
- viewing full precision, 12-3
- viewing messages, 29-19
- viewing note records, 8-1
- viewing zoomed display, 25-16
- View menu, 1-23
- Views field (Appt), 3-2
- views in PIM applications, 1-11
- voiding transactions, 9-13
- volume conversions, 16-3
- volume of sound, 21-3

W

- warranty, A-1
- WDB file extension, 22-10, 25-4
- week-at-a-glance, 3-2
- Week function key, 3-23
- weekly appointment lists
 - changing the default, 3-21
- weekly appointments, 3-9
- Weekly repeat option (Appt), 3-2
- weekly repeat options, 3-5

weighted mean, 17-5
wildcards, 1-24
window moving in display
 (Datacomm), 26-10
WK1 file extension, 22-10, 25-4
W.MEAN function key, 17-3
worksheets in Solver, 19-9
world map, 5-6
World Time, 5-1
 function keys, 5-11
 printing, 28-3
writing messages (cc:Mail), 29-4
writing system macros, 23-1

X

XCOORD function key, 12-18
 12-4
XINE utility, 25-11
XMAX function key, 19-43
XMIN function key, 19-43
XON-XOFF flow control, 26-4
XVALUE function key, 17-6
XVAR function key, 19-43
(X,Y) function key, 19-37, 19-45

Y

YCOORD function key, 12-18
Year+/- function keys, 3-12
Yearly repeat option (Appt),
 3-2
Yen symbol, displaying, 21-6
Yes DST setting, 5-8
YMAX function key, 19-43
YMIN function key, 19-43
YVALUE function key, 17-6

Z

Z-Box function key, 19-37,
 19-45
Z-In function key, 19-36, 19-44
ZOOM, 1-10, 1-20, 2-1
 Appointment Book, 3-11,
 3-21
 Calculator, 12-3
 in Datacomm, 26-10
 in DOS, 25-16
 in memos, 7-11
zooming in plotting, 19-36
Z-Out function key, 19-37,
 19-44

This regulation applies only to The Netherlands

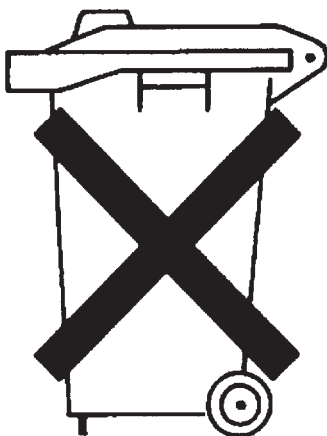

Batteries are delivered with this product, when empty do not throw them away but collect as small chemical waste.

Bij dit produkt zijn batterijen geleverd. Wanneer deze leeg zijn, moet u ze niet weggoien maar inleveren als KCA.

Contacting Hewlett-Packard Worldwide

For information on technical support and service for this product, refer to the card, "Contacting Hewlett-Packard Worldwide", which is included in the product box.

Part 1: Getting Started

Part 2: Personal Information Management

Part 3: Pocket Quicken

Part 4: The HP Financial Calculator

Part 5: System Management

Part 6: External Communications

Part 7: Appendixes and Index



Part Number F1216-90001 Edition 1

F1216-90001 (English)

Printed in Singapore 10/96

