



# Installing IBM **@**server pSeries 640 Model B80 into Racks



Abbas Farazdel  
Derrick Daines  
Martin Wells

[ibm.com/redbooks](http://ibm.com/redbooks)

**Redbooks**





International Technical Support Organization

**Installing IBM @server pSeries 640 Model B80 into Racks**

July 2001

**Take Note!** Before using this information and the product it supports, be sure to read the general information in “Special notices” on page 55.

### **First Edition (July 2001)**

This edition applies to IBM @server pSeries 640 Model B80.

Comments may be addressed to:  
IBM Corporation, International Technical Support Organization  
Dept. JN9B Building 003 Internal Zip 2834  
11400 Burnet Road  
Austin, Texas 78758-3493

When you send information to IBM, you grant IBM a non-exclusive right to use or distribute the information in any way it believes appropriate without incurring any obligation to you.

© Copyright International Business Machines Corporation 2001. All rights reserved.

Note to U.S Government Users – Documentation related to restricted rights – Use, duplication or disclosure is subject to restrictions set forth in GSA ADP Schedule Contract with IBM Corp.

# Contents

<b>Preface</b> .....	v
The team that wrote this .....	v
Special notice .....	vi
IBM trademarks .....	vi
Comments welcome .....	vi
<b>Chapter 1. Introduction</b> .....	1
1.1 Start here .....	2
<b>Chapter 2. Rack type considerations</b> .....	3
2.1 General advice .....	3
2.2 Rack positioning .....	3
2.3 T00 and T42 racks .....	4
2.4 S00 and R00 racks .....	6
2.5 9306 Netfinity racks .....	7
2.6 9308 Netfinity Enterprise racks .....	8
2.7 Non-IBM racks .....	9
2.7.1 Rack strength and stability .....	9
2.7.2 Rack dimensions .....	10
2.7.3 Mounting rail considerations .....	10
2.7.4 Cooling requirements .....	10
2.7.5 General safety .....	10
<b>Chapter 3. Installing the pSeries 640</b> .....	13
3.1 Preparation for installation .....	13
3.2 Positioning the unit .....	15
3.3 Mounting the Rails .....	23
3.4 Install system unit .....	31
3.5 Install the Cable Management Arm .....	41
<b>Appendix A. Specifications for a Non-pSeries rack/cabinet</b> .....	45
Purpose .....	46
Requirements specific to pSeries products .....	46
General safety requirements for an OEM rack/cabinet .....	48
<b>Special notices</b> .....	55



# Preface

This will help you install IBM eServer pSeries 640 Model B80 into an IBM or non-IBM rack.

## The team that wrote this

This was produced by a team of specialists from around the world working at the International Technical Support Organization, Austin Center.

**Abbas Farazdel** is an SP/Cluster System Strategist, Technical Consultant, and Senior Project Manager at the International Technical Support Organization, Austin Center. Before joining the ITSO in 1998, Dr. Farazdel worked in the Global Business Intelligence Solutions (GBIS) group at IBM Dallas as an Implementation Manager for Data Warehousing and Data Mining Solutions, and in the Scientific and Technical Systems and Solutions (STSS) group at the IBM Thomas J. Watson Research Center as a High Performance Computing Specialist. Dr. Farazdel holds a Ph.D. in Computational Quantum Chemistry and an M.Sc. in Computational Physics from the University of Massachusetts.

**Derrick Daines** is the RS/6000 specialist for the CE office in Bedfont, UK. He has 13 years of experience working on RS/6000 products. He has worked at IBM for 33 years. In the UK, he provides support to other engineers within the branch office, and also provides backup help to the country support center.

**Martin Wells** is a senior CE within the Bedfont UK office. He has worked for IBM for 13 years on midrange systems. He supports major UK customers on both RS/6000 and AS/400. He has been a member of the UK ITS Technical Council.

Thanks to the following people for their contributions to this project:

### **IBM Austin, TX**

Chuck Bryan, John Hilburn, Ernest A. Keenan, Bob Lowden, Jim Reidy, Ven Tenjarla, Jesus Villarreal

### **IBM Rochester, MN**

Jessica Berens, Aaron Hegrenes, Jason Lee, Brian Miller, Steve Mroz, Ron Neuman, Tushar Patel, Cheryl Peck, Timothy Rourk, Greg Smith, Phil Thompson, Scott Worden

**Dyadic Systems Ltd, UK**  
Trevor Knight

## Special notice

This publication is intended to help you install the IBM @server pSeries 640 Model B80 into racks.

## IBM trademarks

The following terms are trademarks of the International Business Machines Corporation in the United States and/or other countries:

e (logo)®  
IBM ®  
AS/400  
Netfinity

Redbooks  
Redbooks Logo   
Netfinity  
SP

## Comments welcome

Your comments are important to us!

We want our to be as helpful as possible. Send us your comments about this or other Redbooks in one of the following ways:

- ▶ Use the online **Contact us** review redbook form found at:  
[ibm.com/redbooks](http://ibm.com/redbooks)
- ▶ Send your comments in an Internet note to:  
[redbook@us.ibm.com](mailto:redbook@us.ibm.com)
- ▶ Mail your comments to the address on page ii.





# Introduction

This redpaper has been prepared to supplement the information received with the IBM @server pSeries 640 unit.

In the sections that follows, we will guide you through the process of securely and safely installing the pSeries 640 in its supporting rack. Guidance will be given for all supported IBM racks, but due to the diversity of manufacturers and models only general advice can be given on non-IBM racks.

# 1.1 Start here

Follow the flow chart in Figure 1-1 to find out what parts of this redpaper pertain to your rack.

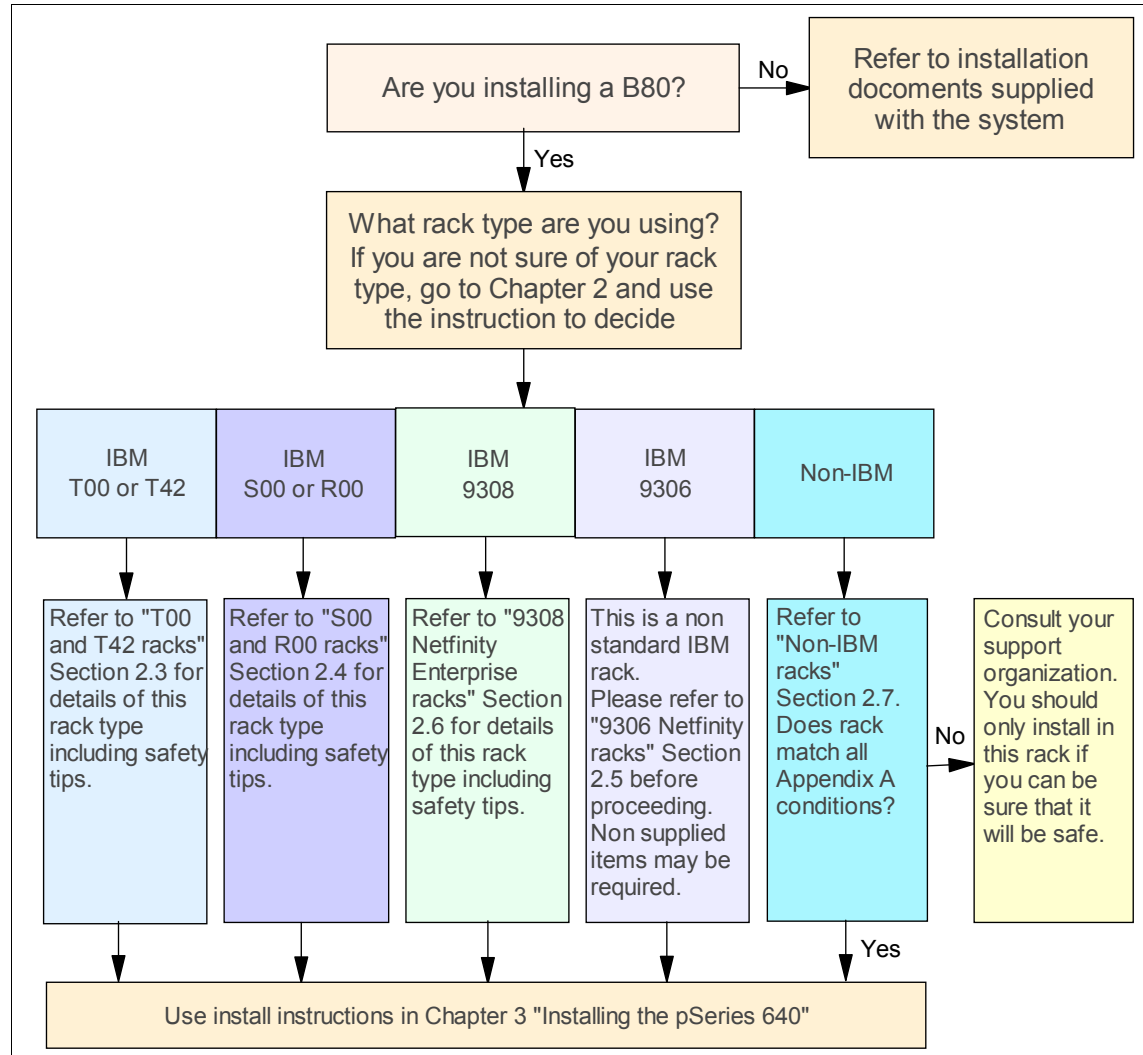

Figure 1-1 Start here



## Rack type considerations

This chapter will provide a brief description of the various IBM racks that the pSeries 640 can be located in. Section 2.7, “Non-IBM racks” on page 9 lists the main considerations if a non-IBM rack is to be used to house the pSeries 640.

### 2.1 General advice

If the rack you are about to work on is empty or only has a couple of units in it, then it is safer to fill any remaining spaces from the bottom of the rack upwards. By filling from the bottom upwards you will maintain the centre of gravity of the rack at its lowest point to avoid the rack toppling. Before you power on the rack for the first time, make sure that all stabilizers are fitted, all jacks have been lowered, and electrical safety has been checked by a qualified electrician.

### 2.2 Rack positioning

The rack should be placed such that all doors on the rack open fully and with enough room for a person to pass around the fully opened door. In the front of the rack there should be sufficient room for the pSeries 640 to be placed in the forward service position. Typically, to meet both conditions requires 914.4mm (36 inches) front and rear.

## 2.3 T00 and T42 racks



*Figure 2-1 T00 and T42 racks (doors and side panels are optional)*

The T00 and the T42 racks are similar in construction except that the T42 model is 6 EIA units taller. The extra 6 EIA units are gained by the addition of a raised section bolted onto the top of a T00 rack. This raised section can be removed to enable the rack to be manoeuvred through low areas.

The T00 rack can accommodate 36 EIA units, and the T42 can accommodate 42 EIA units. Either rack can have up to 4 Power Distribution Units (PDUs) bolted into the rear section with each PDU capable of supplying 6 accessible outlets. For both of these racks you may order a kit that allows multiple racks to be joined together.

**Attention:** Because of the combination of height of these racks and the added stress that some systems cause when placed into the service position, it is essential that both the front and rear stability plates are bolted in place and the leveling legs firmly in contact with the floor.

**WARNING:** Additionally, if a fully configured T42 rack is to be moved, even just across a room, it is essential that all equipment above EIA 32 is removed to prevent overbalancing.

## 2.4 S00 and R00 racks



*Figure 2-2 Partially populated R00 rack*

The R00 and S00 racks are similar in construction except that the S00 rack is black and has a door on the front. Each of these racks are 1.6 metres in height and have a 32 EIA unit capacity. In the rear of the rack it is possible to have 1 or 2 PDUs of various voltages and phase configurations depending upon country. Each PDU is capable of powering 6 accessible separate power inputs.

## 2.5 9306 Netfinity racks



*Figure 2-3 9306 Netfinity rack, with tray out (left) and empty (right)*

This rack is the only IBM manufactured rack that uses square holes to secure equipment into the rack. It therefore cannot be treated in the same way as other rack types such as the Model T42 or 9308.

Equipment being fixed into this sort of frame is secured using captive nuts which are not supplied in the pSeries 640 shipping group. Additionally, you will need to change the size of the locating studs on the Slide Mounting Plate and the rails.

As with all IBM racks this rack is fitted with a stability plate at the front, but also has additional stability plates that must be fitted on the side of the rack. These side plates must be used if the rack is not joined to another rack.

The power supplied to equipment in this rack is via individual power sockets in a single power plug block.

## 2.6 9308 Netfinity Enterprise racks



*Figure 2-4 9308 rack*

This is an Enterprise version of the Netfinity rack. It is similar in construction to the pSeries T00 and T42 rack. If this rack is to be used for pSeries 640, the front door should be permanently removed so that the internal temperature of the rack is maintained at 22 degrees C (72 Degrees F).



For more information on this rack, refer to the Section “T00 and T42 racks” on page 4

**Attention:** Because of the combination of height of these racks and the weight that some systems transfer external of the rack when placed into the service position, it is essential that both the front and rear stability plates are bolted in place and the jacks firmly in contact with the floor.

**WARNING: Additionally** if a fully configured 42 EIA rack is to be moved, even just across a room, then to prevent overbalancing during the move, it is essential that all equipment above EIA 32 is removed.

## 2.7 Non-IBM racks

Due to the number of non-IBM racks available on the market, it is not possible to give detailed information as to the suitability or installation of every rack type. However the following points are the most significant ones to check. If the rack you intend to use does not comply with these, then a safe installation cannot be guaranteed. For all of the checkpoints needed to be reviewed regarding a racks suitability see Appendix A, “Specifications for a Non-pSeries rack/cabinet” on page 45.

### 2.7.1 Rack strength and stability

Any rack used must be capable of supporting 35 lbs (15.9 kgs) per EIA unit (1.75 inch / 44.5mm of rack height). Additionally, the rack’s total weight must not exceed the rating for the floor. The rack should be fitted with stability plates or bolted to a concrete floor (see Appendix A for other alternatives) to prevent the rack from toppling when the pSeries 640 is fully extended forward out of the rack.

**Important:** The last point above is most important as serious injury could result from a toppling rack.

## 2.7.2 Rack dimensions

The pSeries 640 are designed to fit into racks conforming to EIA Standard EIA-310-D for 19 inch racks. This EIA standard is a set of dimensional rules that most reputable rack manufacturers adhere to worldwide. The dimensions of most interest are as follows:

- ▶ The front rack opening must be 451 mm wide  $\pm 0.75$  mm (17.75"  $\pm 0.03$ ").
- ▶ The rail mounting holes must be 465 mm  $\pm 0.8$  mm (18.3"  $\pm 0.03$ ") apart on center (horizontal width between vertical columns of holes on the two front mounting flanges and on the two rear mounting flanges).
- ▶ Rail mounting holes must be 7.1 mm  $\pm 0.1$  mm (0.28"  $\pm 0.004$ ") in diameter.
- ▶ The vertical distance between mounting holes must consist of sets of 3 holes spaced (from bottom to top) 15.9 mm (0.625"), 15.9 mm (0.625"), and 12.67 mm (0.5") on center (making each 3 hole set of vertical hole spacing 44.45 mm (1.75") apart on center).

## 2.7.3 Mounting rail considerations

The pSeries 640 is mounted into the rack on sliding rails. The alignment of these rails within the rack is vitally important because it not only ensures smooth movement within the rack, but also prevents damage to the rails. Damaged rails, either from incorrect installation or alignment, can under certain circumstances be safety hazards.

To ensure good rail alignment the rack must have mounting flanges that are at least 494mm (19.45 inches) apart across the width of the rack and 719mm (28.3 inches) between them front to rear. If the locating holes in the mounting flanges are square, then a "plug in hole" adapter may be required to prevent unnecessary rail movement.

## 2.7.4 Cooling requirements

Effective cooling is best achieved by not having any door on the front of the rack. If a door is fitted then it must provide sufficient passage of air into the rack to enable the internal temperature within the rack to remain at approximately 22 degrees C (72 degrees F).

## 2.7.5 General safety

As with all racks, it is essential that all stability plates are fitted in accordance with the rack manufacturer's instructions.

For additional information regarding electrical and other safety requirements, review Appendix A, “Specifications for a Non-pSeries rack/cabinet” on page 45.





## Installing the pSeries 640

Follow the procedures in this chapter to install the pSeries 640.

### 3.1 Preparation for installation

1. If this is a fresh installation into an empty rack, make sure that the rack is in the desired position and all stability plates are fitted in accordance with the rack manufacturer's documentation.
2. With the rack in position, remove any doors at the front of the rack. This will make it easier for you to lift the system unit into position.
3. If the rails are already installed in the rack, make sure the screws are only finger tight before proceeding.
4. Move boxes containing the system to be installed to a convenient position adjacent to the rack to be worked on.



Figure 3-1 Shipping group box contents

5. Open the box and locate the shipping group box shown above.

## 3.2 Positioning the unit

**Caution:**

Before continuing, check that all stabilizer plates are installed correctly as stated in the rack installation instruction.

Failure to do this may result in the rack becoming unstable and or tipping may occur when installing the system drawer.

**Parts required**

- ▶ Rack mounting template
- ▶ Slide mounting kit
- ▶ Latch bracket mounting kit.

## Instructions

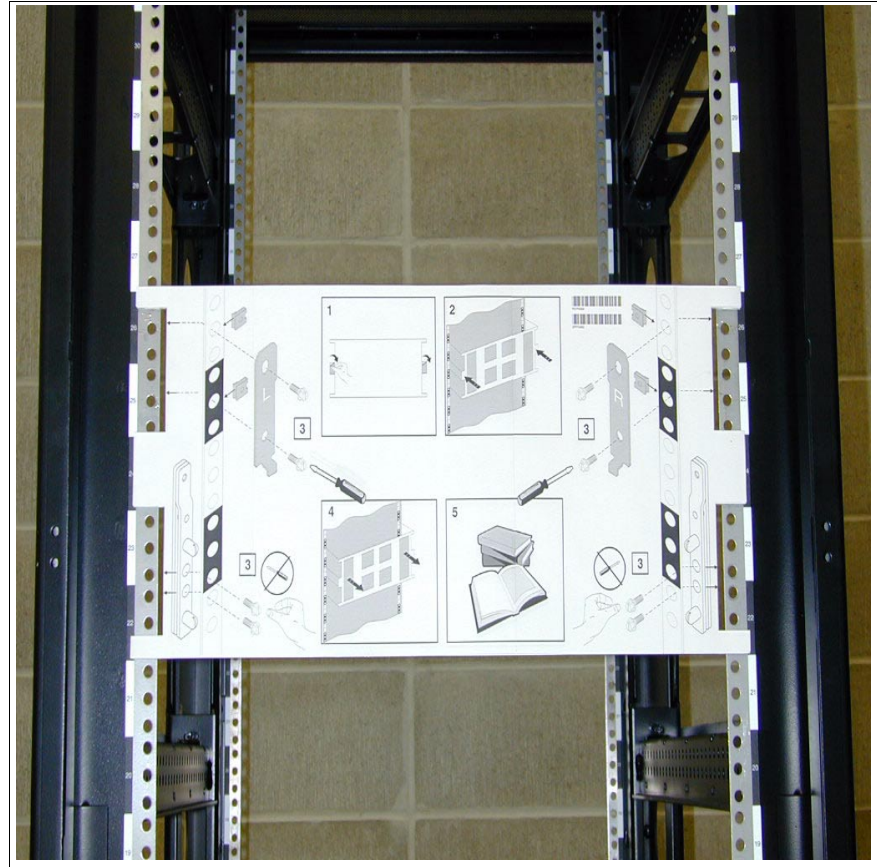

Figure 3-2 Template positioned on rack flange

1. Remove the rack mounting template from the packaging and, using the adhesive tab on the back, place the template at the point where the pSeries 640 is to be located. Make sure that the indicated screw positions align with the rack flange holes.





*Figure 3-3 Rack Mounting Kit*

2. Remove the Rack Mounting Kit from the shipping group box. This kit contains the packages of parts to be used to secure the pSeries 640 into the rack.



Figure 3-4 Rack Mounting Kit contents (Note each packets name)

3. Open the Rack Mounting Kit and put the contents to one side. Do not open any of the packages at this time.



*Figure 3-5 Alignment pins*

4. Open the packet marked Slide Mounting Kit. In this packet you will find these alignment pins either loose or in the Slide Mounting Plate.

**Note:** The size of the Alignment Pins which are fitted by default into the Slide Mounting Plate is 7.1mm (0.28 inch) in diameter. This is the size used for IBM racks.



*Figure 3-6 Slide mounting plate*

5. Change the alignment pins on both slide mounting plates if required to match the rack mounting holes.

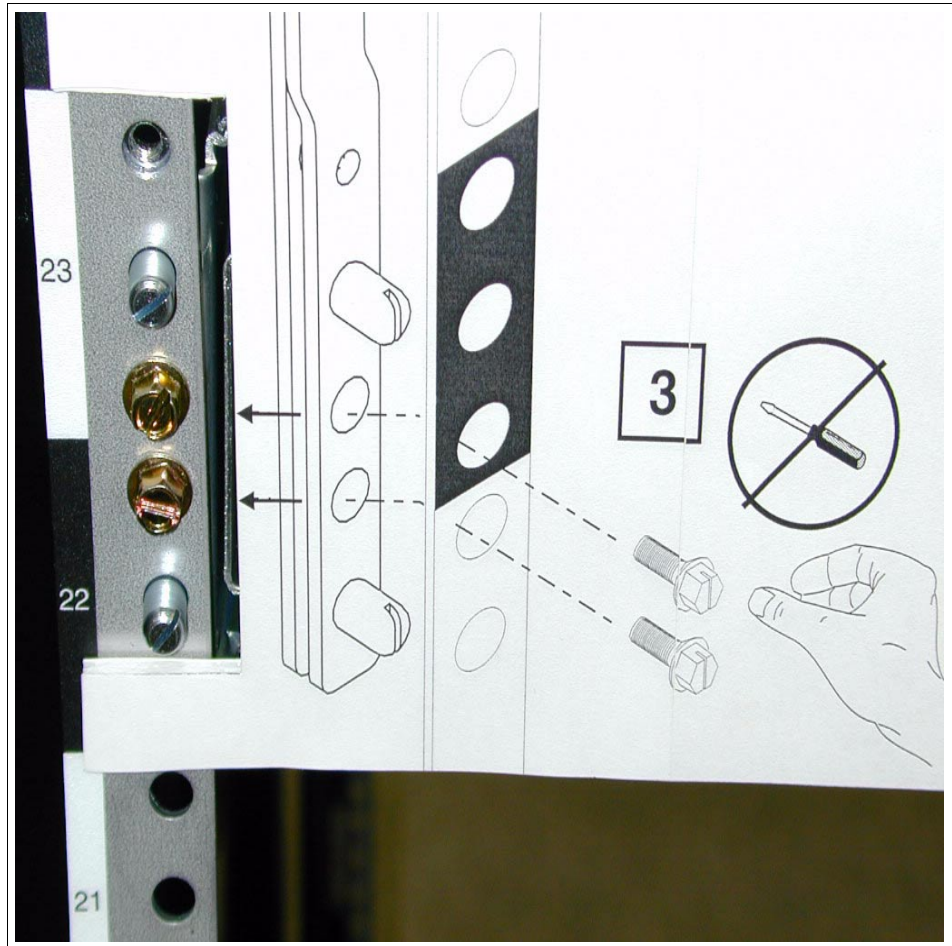

Figure 3-7 Slide mounting graphic (left side)

6. Now fit the components in the positions indicated by the template graphics. Put any components not used to one side for the moment.

**Important:** Do not tighten any of the screws securing the slide mounting brackets more than finger tight at this point.

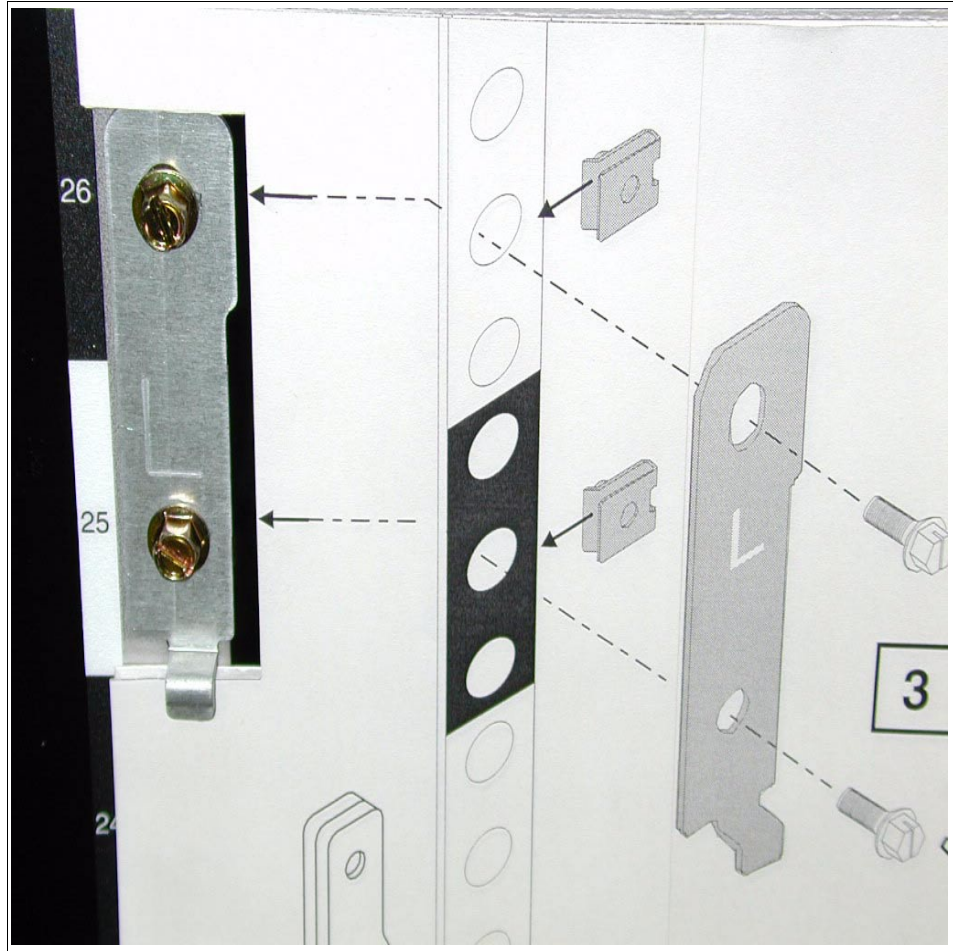

Figure 3-8 Left latch mounting graphic and hardware

7. Open the packet marked Latch Mounting Kit and place the components in the positions indicated by the template. The screws indicated on the template for the Latch Mounting Plates can be fully tightened into position.

**Note:** In Figure 3-8 the bracket shown on the figure needs to be black with a white "L" on it. The bracket shown is NOT what is shipped with the product.

## 3.3 Mounting the Rails

### Parts required

- ▶ Rack rails

The following procedure is written for racks having the EIA position marked on or by the rack flanges. For racks having no EIA unit markings, you will need to count fixing holes or measure the position of the lower front pin of the Slide Mounting Plate to establish the corresponding rear position.

## Instructions

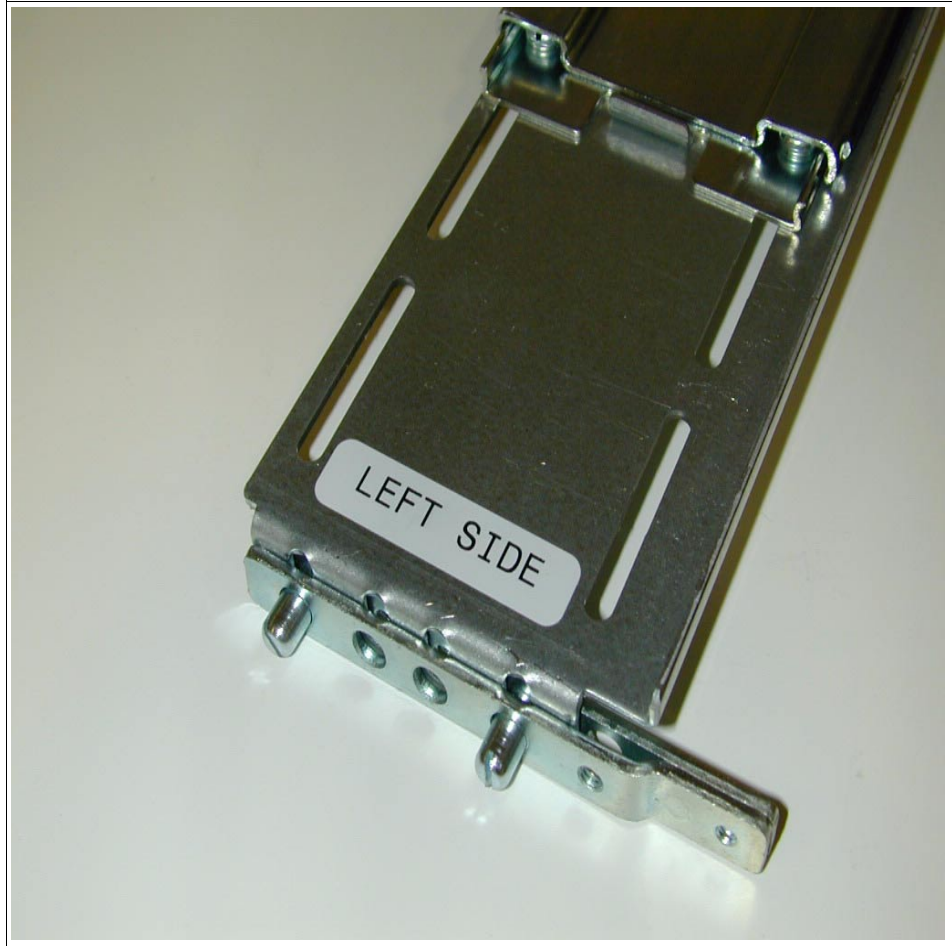

Figure 3-9 Alignment pins

**Note:** The size of the Alignment Pins which are fitted by default into the Slide Mounting Plate is 7.1mm (0.28 inch) in diameter. This is the size used for IBM racks.

1. You may need to change the alignment pins if rack flange holes are a different dimension.





*Figure 3-10 Alignment pins on rack rail*

2. Change the alignment pins on both rails if required.



Figure 3-11 Rail length adjustment screws

**Note:** Rails are preset to IBM rack dimensions.

3. If you need to adjust rail length, loosen the rail length adjustment screws, pull rail to the required length, and tighten the screws again.

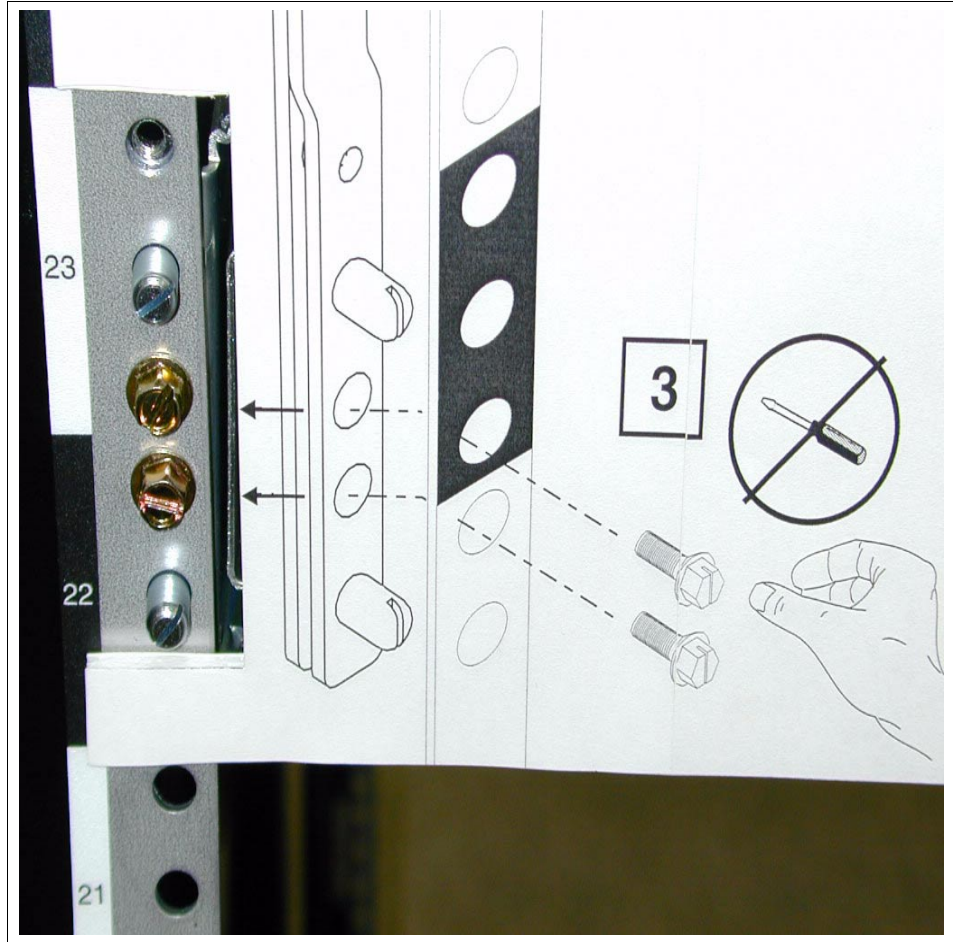

Figure 3-12 Slide mounting plate in position

4. Note the hole where the lower front pin of the slide mounting plate is located.



*Figure 3-13 Rear rail pin in noted hole location*

5. Orient the rail so that the open fingers are towards the front of the rack and the location pin assembly at the other end of the rail is towards the rear. Place the lower locating pin into the same EIA position hole of the rear Rack Flange as the lower pin on the front slide mounting plate occupies (as noted previously).





*Figure 3-14 Positioning front of rail into rack mounting plate*

6. With the rail positioned in the rear rack flange, press the open ended fingers of the rail into the slot of the front rack mounting plate.
7. Repeat the steps above for the other rail.

**Important:** Do not tighten any of the screws more than finger tight at this point.

Tightening of the screw securing the rails will prevent the rails from self aligning correctly when the system unit is inserted. If the rails do not self align, then there is a possibility of the system unit dropping out of the rails onto the floor or the unit below.



## 3.4 Install system unit

**Caution:**

System Units weigh between 32 kg (70.5 pounds) and 55 kg (121.1 pounds).

Three persons are required to safely move it. Using fewer than three persons may result in injury.

Before continuing, check that all stabilizer plates are installed correctly as stated in the rack installation instructions.

**Parts required**

- ▶ System drawer

## Instructions



*Figure 3-15 Rail in locked position*

1. Extend rails out of the rack to their locked position.
2. Try pushing the rails in to confirm they are locked.





*Figure 3-16 System drawer handle*

3. Lift the system drawer using the handles on each side.

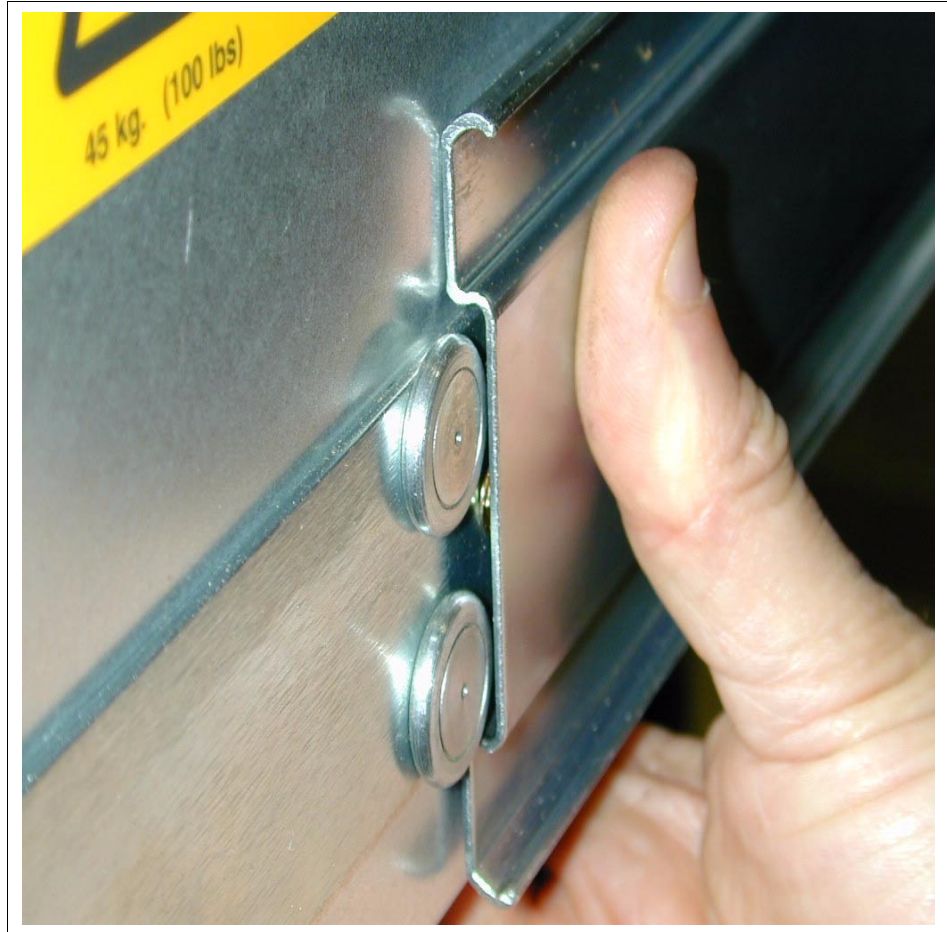

*Figure 3-17 Holding rail to help align system drawer wheels*

4. Align system drawer wheels in front of the rail track. Slide system drawer slowly into the rails ensuring all system drawer wheels slide inside the rail track. To help ensure that all wheels enter the rail correctly, apply pressure to each rail as shown above.
5. Continue sliding the system drawer until it stops against the release button.

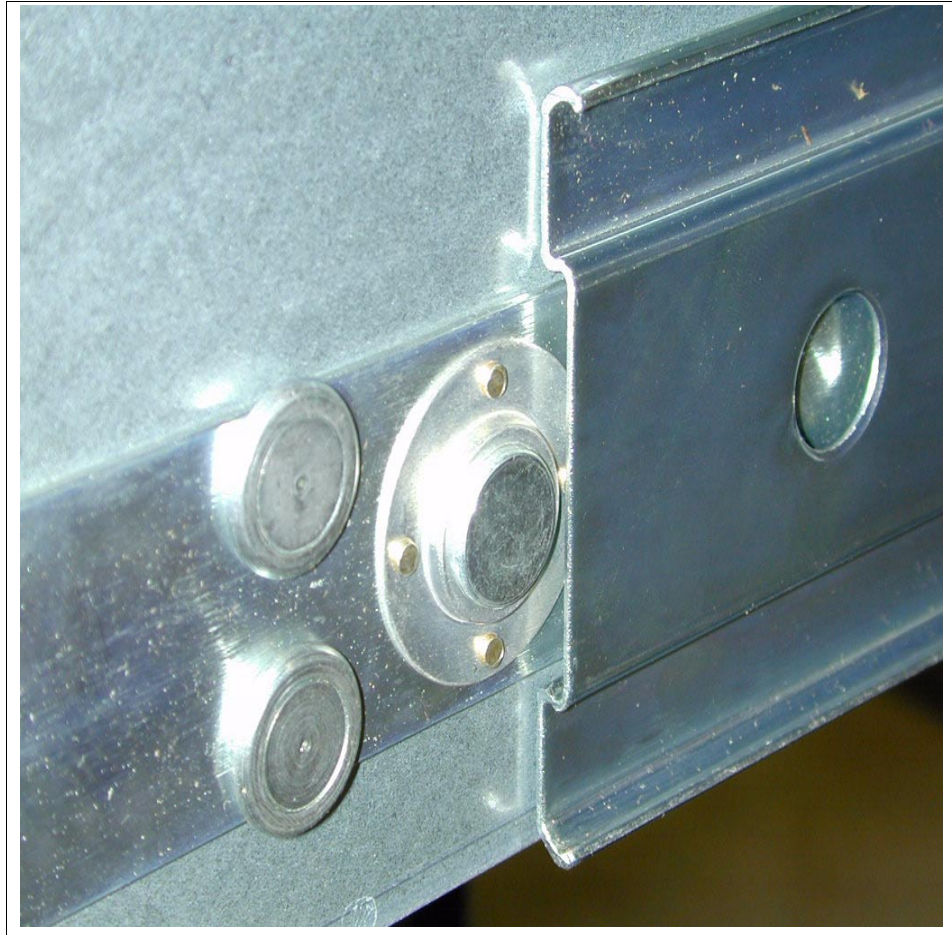

*Figure 3-18 Release button*

6. While supporting the system drawer, push both release buttons (one located on either side of the system drawer on the inner rail), which allows you to continue to slide in the system drawer.





*Figure 3-19 System drawer in service position*

7. Continue sliding the System Drawer until you hear a click and both Release Buttons engage in the holes in the Rails (service position).

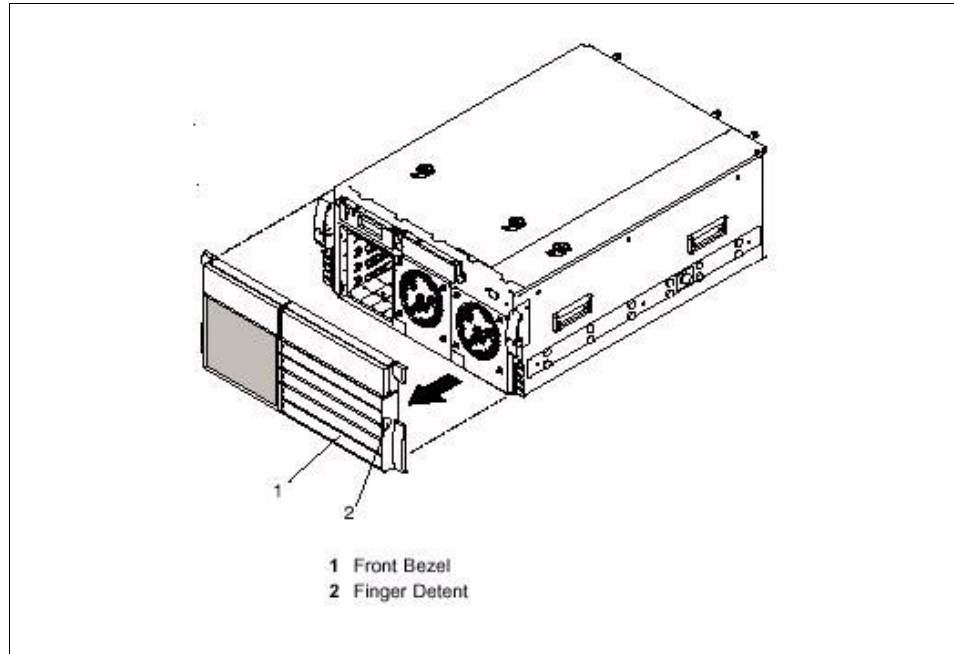

*Figure 3-20 Front bezel removal.*

8. Grasp the front bezel on each side and carefully pull it toward you. Use the finger detents, located on each side of the bezel, to aid you in pulling the bezel away from the system drawer.



*Figure 3-21 Release button*

9. Push both release buttons to continue sliding the system drawer to the operating position against the front rack flange, until both front latches on the system drawer engage into the latch brackets on the rack.



Figure 3-22 Lower section of release latch

**Important:** These steps align the rails in the rack so the system drawer can slide smoothly in and out of the rack to the service position.

The screws holding the rails and rack mounting plate should still be finger tight at this point. If they are not, the alignment will not be correct and damage to the rails will occur.

10. Now tighten all screws front and back to secure the rails into the aligned position.
11. Lift the lower section of both release latches.



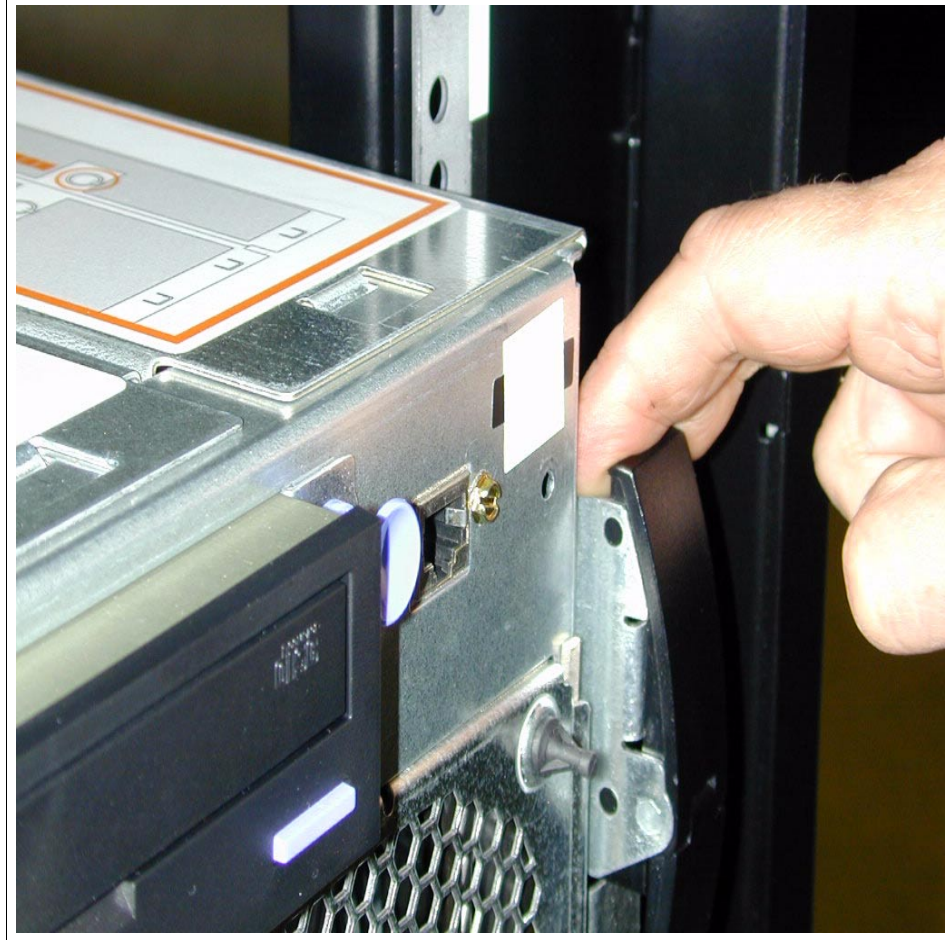

*Figure 3-23 Top of release latch*

12. Grasp the top of both latches and pull the system drawer in and out several times. The system drawer is installed correctly if it slides in and out smoothly. If not, loosen the screws that retain the rails at the front and rear of the rack (four screws per rail, eight in total, to finger tight). Repeat steps 9 to 12.
13. Replace the front bezel.



## 3.5 Install the Cable Management Arm

### Parts required

- ▶ Cable management arm
- ▶ Cable management arm mounting kit

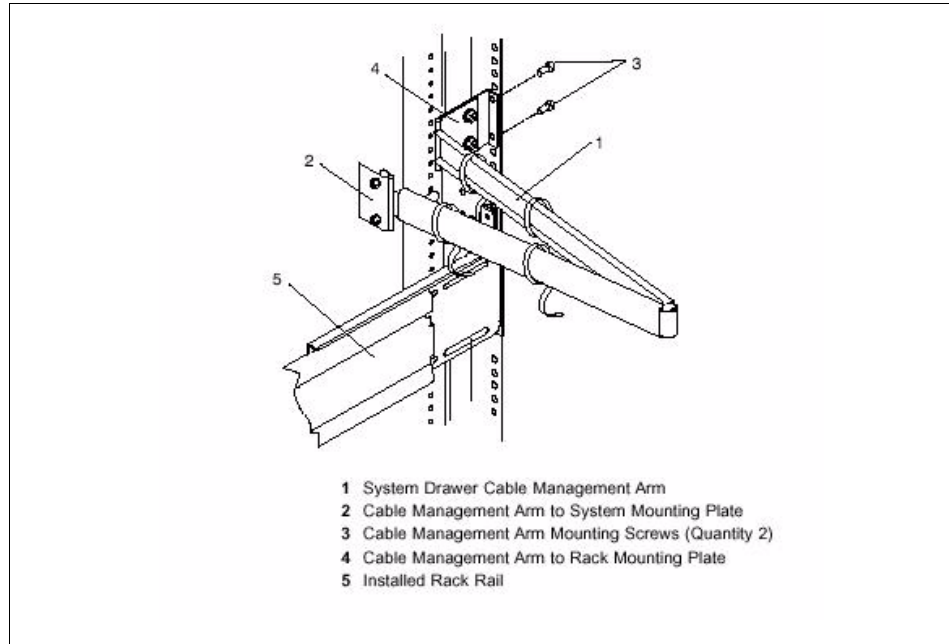
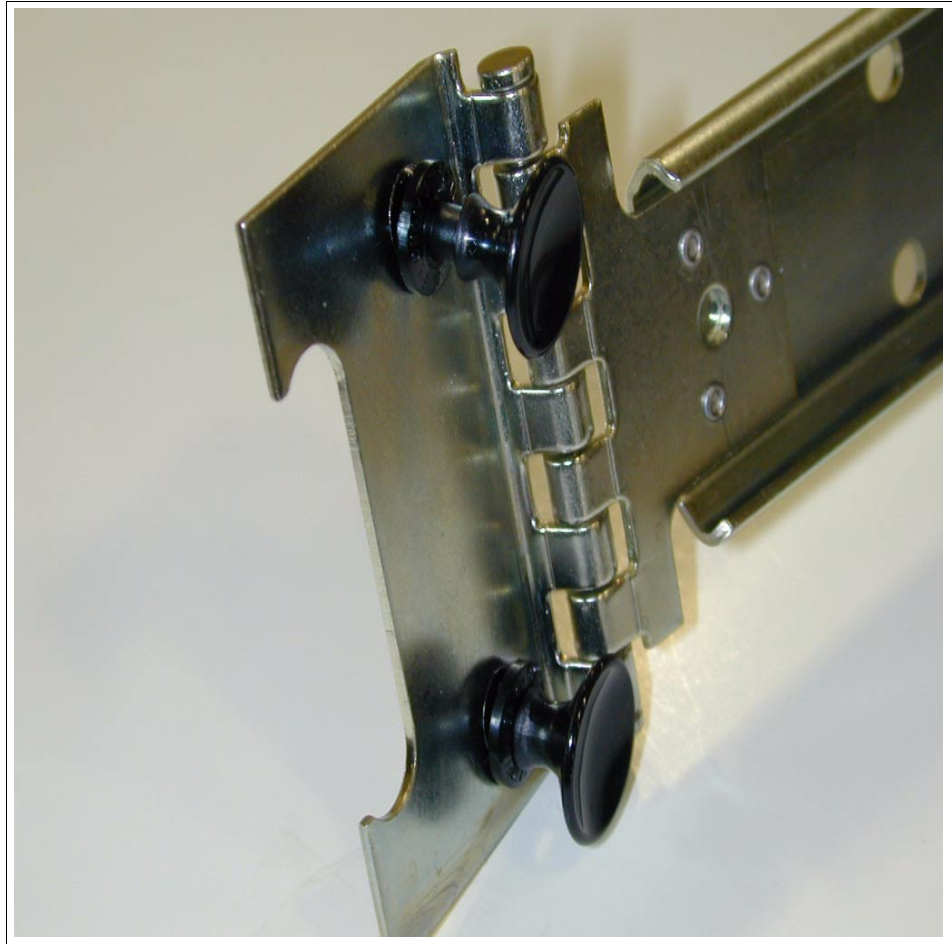

Figure 3-24 Cable management assembly in rack

## Instructions



*Figure 3-25 Cable management arm system mounting plate*

1. Pull out the two captive snap buttons on the system mounting plate.

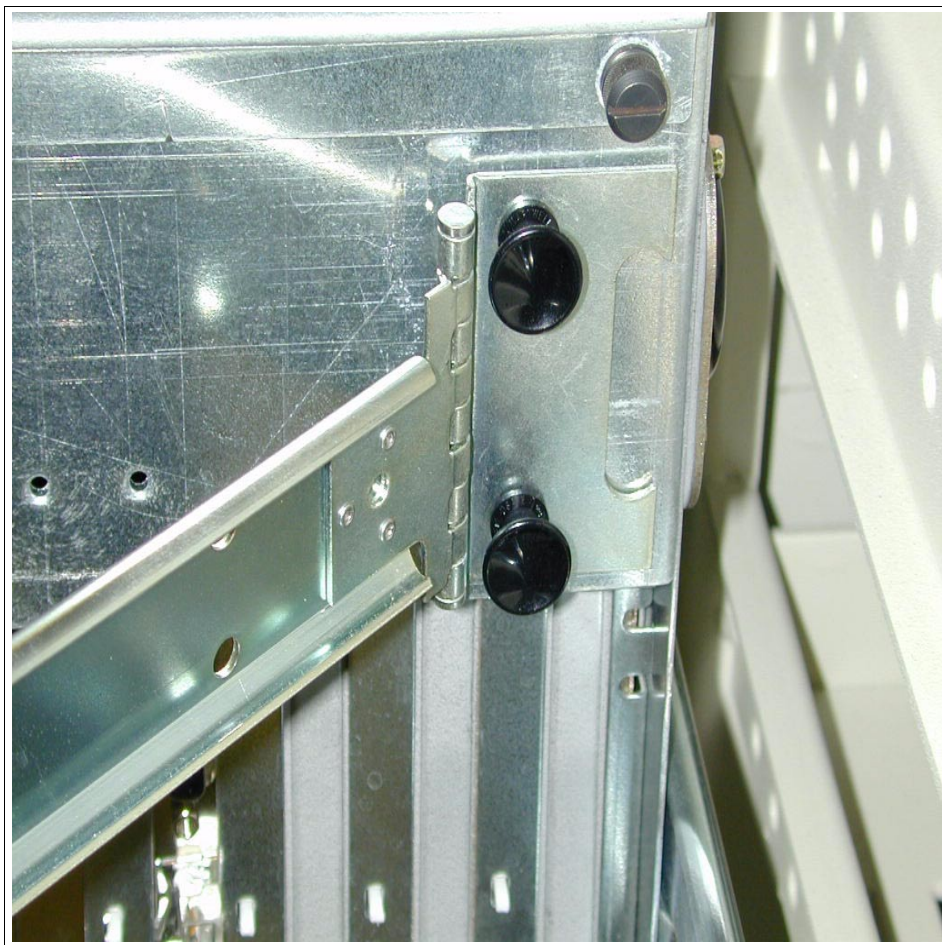

*Figure 3-26 Aligned Cable Management Arm System Mounting Plate*

2. Align cable management arm system mounting plate on the back of the system drawer. Insert the two captive snap buttons into the holes. Push on the heads to lock them into position.



Figure 3-27 Cable management arm rack mounting plate

3. Making sure that the cable management arm is level, align the threaded holes, located on the cable management arm rack mounting plate, with the holes in the rear rack flange.
4. Use the two screws from the cable management arm mounting kit to secure the cable management arm mounting plate to the rear rack flange.

**Note:** In Figure 3-27 regular rack screws are NOT shown. The plastic headed screws shown are for packing only.



**A**

# **Specifications for a Non-pSeries rack/cabinet**

Until these specifications are included in the Site Hardware and Planning Information, the latest level of this document can be found on the IBM ITS Environmental Affairs Web site, <http://wwas.raleigh.ibm.com/safety/>.

## Purpose

This requirements specification has been established to assist the customer to determine if their non-RS/pSeries racks/cabinets will meet the IBM RS/pSeries installation requirements. It is ultimately the customer's responsibility to ensure that the installation of the drawer in their preferred rack/cabinet results in a configuration that is stable, serviceable, safe, and compatible with the drawer requirements for power, cooling, cable management, weight, and rail securement.

To determine compliance to the following specifications, you may need to get rack specification and certification information from your rack manufacturer's representative. IBM's Site Hardware and Planning Information as well as specific product Installation Guides will contain more detailed product information. Your IBM Marketing Representative or Installation Planning Representative will have access to these documents. Additionally, your IBM Branch Office Specialist and/or your IBM Installation Planning Representative may be able to assist you, as needed, in verifying that your non-pSeries rack/cabinet complies with the requirements in this specification. Call 1-800-IBM-SERVE (1-800-426-7378).

**Important!** Failure to comply with the specifications in this document could result in the voiding of your IBM RS/pSeries product warranty and general maintenance agreement.

## Requirements specific to pSeries products

### 1. The rack/cabinet must meet the EIA Standard EIA-310-D for 19 inch racks.

The front rack opening must be 451 mm wide  $\pm 0.75$  mm (17.75"  $\pm 0.03$ "), and the rail mounting holes must be 465 mm  $\pm 0.8$  mm (18.3"  $\pm 0.03$ ") apart on center (horizontal width between vertical columns of holes on the two front mounting flanges and on the two rear mounting flanges). Rail mounting holes must be 7.1 mm  $\pm 0.1$  mm (0.28"  $\pm 0.004$ ") in diameter.

The vertical distance between mounting holes must consist of sets of 3 holes spaced (from bottom to top) 15.9 mm (0.625"), 15.9 mm (0.625"), and 12.67 mm (0.5") on center (making each 3 hole set of vertical hole spacing 44.45 mm (1.75") apart on center).

### 2. The rack/cabinet must be capable of supporting an average load of 15.9 kg (35 lbs.) of product weight per EIA unit.

(i.e. 4 EIA drawer = 63.6 kg (140 lb.) max. drawer weight)



- 3. Only AC power drawers are supported in the rack/cabinet. It is strongly recommended to use an IBM Power Distribution Unit (PDU) to supply power in the rack. If an IBM PDU is not used, then the rack/cabinet power distribution device(s) must meet the pSeries drawer power requirements as well as that of any additional products that will be connected to the same power distribution device.**

**Note:** Refer to the sales manual for the 7014 rack if you wish to use IBM power distribution units. The customer is responsible for ensuring the PDU is compatible with the rack/cabinet, and assumes responsibility for any/all agency certifications required.

The rack/cabinet power receptacle (PDU, UPS, or Multi-Outlet Strip) must have a compatible plug type for your RS/pSeries model.

(See *Site Hardware and Planning Information* for specific power and connector requirements.)

- 4. The rack/cabinet must be compatible with RS/pSeries mounting rails, including a secure and snug fit of the rail mounting pins and screws into the rack/cabinet rail support hole.** (If the rack/cabinet has square holes, a plug-in hole adapter may be required.)

The reason for this is that the RS/pSeries rails have been designed and tested by IBM to safely support the weight of your RS/pSeries model and to facilitate service access by allowing the drawer to be safely extended forwards, and, for some models, backwards. They also provide drawer specific anti-tip brackets, rear lock down brackets, and cable management guides that require clearance on the rear side of the rails.

The front and rear mounting flanges in the rack/cabinet must be 719 mm (28.3") apart and the internal width bounded by the mounting flanges at least 494 mm (19.45") (required for the IBM pSeries rails to fit in your rack/cabinet).

- 5. The rack/cabinet must have stabilization feet or brackets installed both in the front and rear of the rack, or have another means of preventing the rack/cabinet from tipping while the RS/pSeries is pulled into its extreme front or rear service position.**

Examples of some acceptable alternatives: The rack/cabinet may be securely bolted to the floor, ceiling, or walls, or to adjacent racks/cabinets in a long and heavy row of racks/cabinets. Refer to 7014 Rack Installation Guides and the individual drawer installation guides for additional information.

**6. There must be adequate front and rear service clearances (in and around the rack/cabinet).**

The rack/cabinet must have sufficient horizontal width clearance in the front and rear to allow the drawer to be fully slid into the front and, if applicable, the rear service access positions. (Typically this requires 914.4 mm (36") clearance in both the front and rear, see *Site Hardware and Planning Information* for more information.)

If present, front and rear doors must be able to open far enough to provide unrestrained access for service or be easily removable. If doors must be removed for service it is the customer's responsibility to remove them prior to service.

**7. The rack/cabinet must provide adequate clearance around the rack drawer.**

There must be adequate clearance around the drawer bezel so that it can be opened and closed, per the product specifications (Refer to the 7014 Rack Installation Guides and the individual drawer installation guides).

Front or rear doors must also maintain a minimum of 51 mm (2") front, 203 mm (8") rear, door to mounting flange clearance, and 494 mm (19.4") front, 571 mm (22.5") rear, side-to-side clearance for drawer bezels and cables.

**8. The rack/cabinet must provide adequate front to back ventilation.**

For optimum ventilation, it is recommended the rack/cabinet not have a front door. If the rack/cabinet has doors, the doors must be fully perforated such that there is proper front to back airflow to maintain the required drawer ambient inlet temperature between 10 °C and 40 °C (50 °F and 104 °F), with an ideal 22 °C (72 °F), inside the rack. The perforations must yield 34 % minimum open area per square inch.

## **General safety requirements for an OEM rack/cabinet**

**1. Any product or component that plugs into the Power Distribution Unit (PDU) or main power (has a power cord) or any voltage over 42 VAC or 60 VDC (considered to be hazardous voltage) must be Safety Certified by a Nationally Recognized Test Laboratory (NRTL) for the country(ies) in which it will be installed.**

Some of the items that require safety certification may include the rack/cabinet (if it contains electrical components integral to the rack/cabinet), fan trays, PDU, Uninterruptable Power Supplies (UPS), Multi-Outlet Strips, and any other products installed in the rack/cabinet that connect to hazardous voltage (whether they are serviced by IBM or not).



## NRTL Examples:

Some of the OSHA approved NRTLs for the USA: UL, ETL, CSA (with CSA NRTL or CSA US mark). Some of the Canadian approved NRTLs for Canada: UL (ULc mark), ETL (ETLc mark), CSA. The European Union requires a CE mark and a Manufacturer's Declaration of Conformity (DOC).

Certified products should have the NRTL logos or marks somewhere on the product or product label. However, proof of certification must be made available to IBM upon request. (Proof consists of such items as copies of the NRTL license or certificate, a CB Certificate, a Letter of Authorization to apply the NRTL mark, the first few pages of the NRTL certification report, Listing in an NRTL publication, or a copy of the UL Yellow Card. Proof should contain the Manufacturer's name, product type, and model, standard to which it was certified, the NRTL name or logo, the NRTL file number or license number, and a list of any Conditions of Acceptance or Deviations. A Manufacturer's Declaration is not proof of certification by an NRTL.)

### **2. The rack/cabinet must meet all electrical and mechanical safety legal requirements for the country in which it is installed.**

The rack/cabinet must be free of exposed hazards (voltages over 60 VDC or 42 VAC, energy over 240 VA, sharp edges, mechanical pinch points, hot surfaces, etc.).

### **3. There must be an accessible and unambiguous disconnect device for each product in the rack, including any PDU, IBM products, non-IBM products, etc.**

A disconnect device may consist of either the plug on the power cord (if the power cord is no longer than 6 feet long), the appliance inlet receptacle (if the power cord is of a detachable type), or a power on/off switch or Emergency Power Off switch on the rack, provided all power is removed from the rack or product by the disconnect device.

If the rack/cabinet has electrical components (such as fan trays or lights), then the rack must have an accessible and unambiguous disconnect device.

### **4. The rack/cabinet, PDU and Multi-Outlet Strips, and products installed in the rack/cabinet must all be properly grounded to the customer facility ground.**

There must be no more than 0.1 Ohms between the ground pin of the PDU or rack plug and any touchable metal or conductive surface on the rack and on the products installed in the rack. Grounding method must comply with applicable country 's electric code (NEC, CEC, etc.) Ground continuity can be verified by your IBM Service personnel once the installation is completed, and should be verified prior to the first service activity.

**5. The voltage rating of the PDU and Multi-Outlet Strips must be compatible with the IBM and non-IBM products plugged into them.**

The PDU or Multi-Outlet Strips current and power ratings must be at least 1.25 times the sum of the ratings of the products that will plug into it. The current rating of the PDU or Multi-Outlet strip must be less than 0.80 of the rating for the building supply circuit (as required by the NEC and CEC). Example: A PDU rating of 12A for a 15A wall breaker, and sum of product ratings does not exceed 9.6A.

If a UPS is installed, it must meet all the above electrical safety requirements as described for a PDU (including certification by an NRTL).

**6. The rack/cabinet, PDU, UPS, Multi-Outlet Strips and all IBM and non-IBM products in the rack/cabinet must be installed according to the manufacturer's instructions, and in accordance with all national, state or province, and local codes and laws.**

The rack/cabinet, PDU, UPS, Multi-Outlet Strips, and all IBM and non-IBM products in the rack/cabinet must used as intended by the manufacturer (per manufacturer's product documentation and marketing literature).

**7. All documentation for use and installation of the rack/cabinet, PDU, UPS, and all IBM and non-IBM products in the rack/cabinet, including safety information, must be available on-site.**

**8. If there is more than one source of power in the rack/cabinet, there must be clearly visible safety labels for "Multiple Power Source" (in the languages required for the country in which the product is installed).**

**9. If the rack/cabinet or any products installed in the cabinet had safety or weight labels applied by the manufacturer, they must be intact and translated into the languages required for the country in which the product is installed.**

**10. If the rack/cabinet has doors, the rack becomes a fire enclosure by definition and must meet the applicable flammability ratings (V-0 or better). Totally metal enclosures at least 1 mm (0.04") thick are considered to comply.**

Non-enclosure (decorative) materials must have a flammability rating of V-1 or better.

If glass is used (such as in rack doors) it must be safety glass.

If wood shelves are used in the rack/cabinet, they must be treated with a UL Listed flame retardant coating.

**11. The rack/cabinet configuration must comply with all IBM requirements for “safe to service”. (Contact your IBM Installation Planning Representative if in doubt.)**

There must be no unique maintenance procedures or tools required for service.

Elevated service installations, where the product(s) to be serviced are installed between 1.5 m and 3.7 m (5' and 12') above the floor, require the availability of an OSHA and CSA approved nonconductive step ladder. If a ladder is required for service, the customer must supply the OSHA and CSA approved nonconductive step ladder (unless other arrangements have been made with the local IBM Service Branch Office). Products installed over 2.9 m (12') above the floor require a Special Bid to be completed before they can be serviced by IBM Service personnel.

For IBM products not intended for rack-mounting and for non-IBM products to be serviced by IBM, products and parts which will be replaced as part of that service must not weigh over 11.4 kg (25 lbs.) (Contact your Installation Planning Representative if in doubt).

There must not be any special education or training required for safe servicing of any of the product(s) to be serviced by IBM (contact your Installation Planning Representative if in doubt).

**12. Any rack/cabinet must have stabilization feet or brackets installed, or have another means of preventing the rack/cabinet from tipping during product operation or service.**

Examples of some acceptable alternatives: The rack/cabinet may be securely bolted to the floor, ceiling or walls, or to adjacent racks/cabinets in a long and heavy row of racks/cabinets.

**13. It is strongly recommended to use the mounting rails that ship with the product to install it in the rack.**

The mounting rails that ship with IBM products have been designed and tested to safely support the product during operation and service activities.

The mounting rails used on products to be serviced by IBM must be certified for use with the products by an NRTL to UL 1950 or equivalent country applicable safety standard.

**Note:** UL 1950 requires that mounting rails must be able to support four times the maximum rated product weight in its worst case position (fully extended front and rear positions) for 1 full minute without catastrophic failure.

Until these specifications are included in the Site Hardware and Planning Information, the latest level of this document can be found on the IBM ITS Environmental Affairs Web site, <http://wwas.raleigh.ibm.com/safety/>.

## Reference drawing of Top View of non-pSeries Rack Spec Dimensions

Note: Rack spec reference numbers are shown in brackets, [xx].

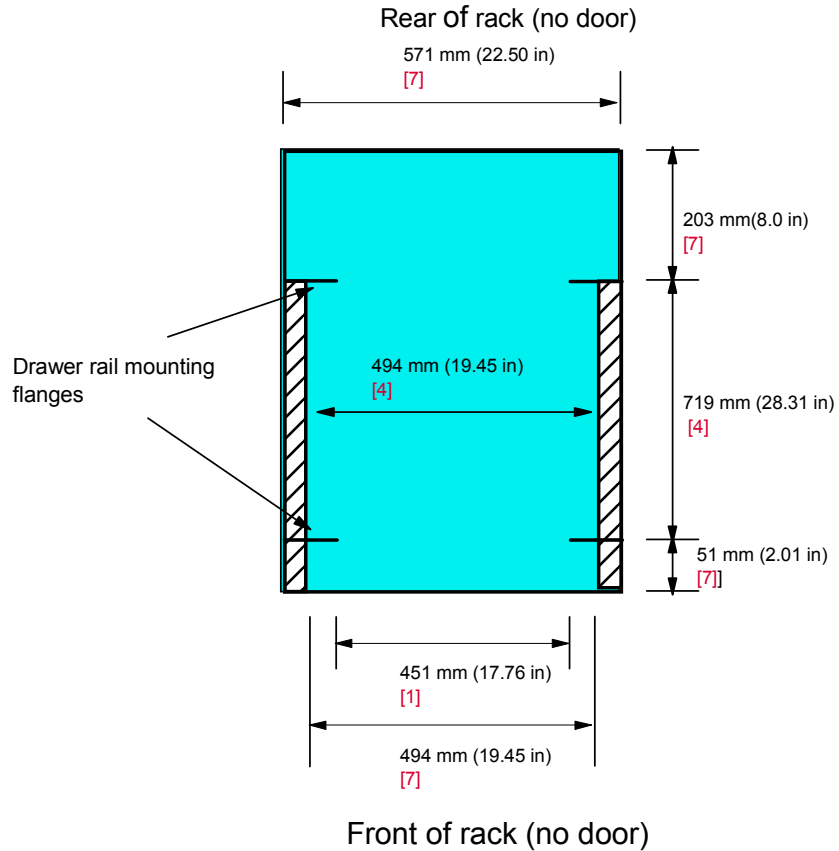

Figure 3-28 Reference drawing of non-pSeries rack dimensions

Reference drawing of non-pSeries Rack Spec Dimensions shown in Section 1

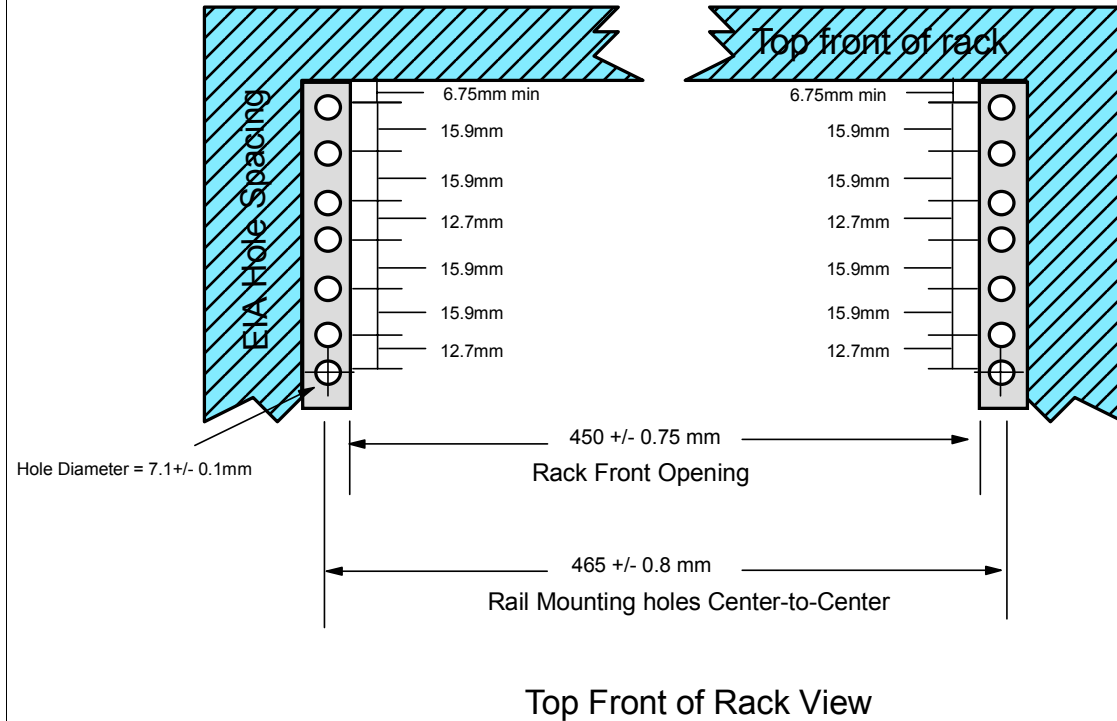

Figure 3-29 non-pSeries top front rack view

Reference drawing of non-pSeries Rack Spec Dimensions shown in Section 1

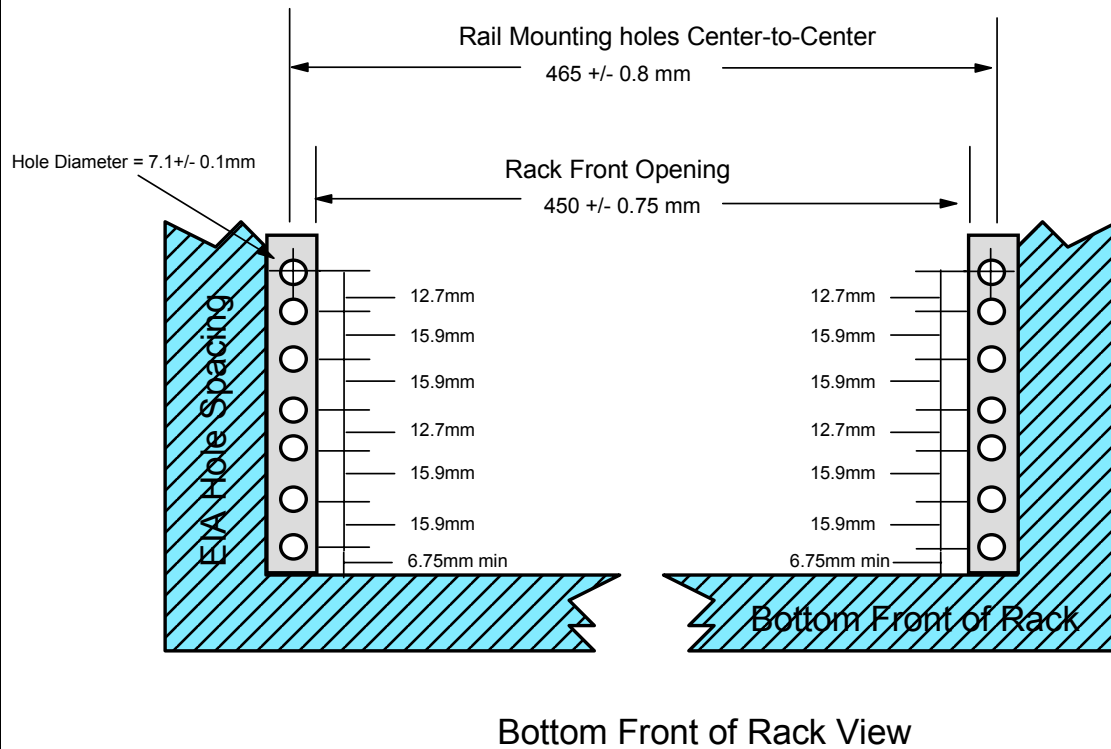

Figure 3-30 non-pSeries bottom front rack view

# Special notices

References in this publication to IBM products, programs or services do not imply that IBM intends to make these available in all countries in which IBM operates. Any reference to an IBM product, program, or service is not intended to state or imply that only IBM's product, program, or service may be used. Any functionally equivalent program that does not infringe any of IBM's intellectual property rights may be used instead of the IBM product, program or service.

Information in this book was developed in conjunction with use of the equipment specified, and is limited in application to those specific hardware and software products and levels.

IBM may have patents or pending patent applications covering subject matter in this document. The furnishing of this document does not give you any license to these patents. You can send license inquiries, in writing, to the IBM Director of Licensing, IBM Corporation, North Castle Drive, Armonk, NY 10504-1785.

Licensees of this program who wish to have information about it for the purpose of enabling: (i) the exchange of information between independently created programs and other programs (including this one) and (ii) the mutual use of the information which has been exchanged, should contact IBM Corporation, Dept. 600A, Mail Drop 1329, Somers, NY 10589 USA.

Such information may be available, subject to appropriate terms and conditions, including in some cases, payment of a fee.

The information contained in this document has not been submitted to any formal IBM test and is distributed AS IS. The use of this information or the implementation of any of these techniques is a customer responsibility and depends on the customer's ability to evaluate and integrate them into the customer's operational environment. While each item may have been reviewed by IBM for accuracy in a specific situation, there is no guarantee that the same or similar results will be obtained elsewhere. Customers attempting to adapt these techniques to their own environments do so at their own risk.

Any pointers in this publication to external Web sites are provided for convenience only and do not in any manner serve as an endorsement of these Web sites.

The following terms are trademarks of other companies:

Tivoli, Manage. Anything. Anywhere., The Power To Manage., Anything. Anywhere., TME, NetView, Cross-Site, Tivoli Ready, Tivoli Certified, Planet Tivoli, and Tivoli Enterprise are trademarks or registered trademarks of Tivoli Systems Inc., an IBM company, in the United States, other countries, or both. In Denmark, Tivoli is a trademark licensed from Kjøbenhavns Sommer - Tivoli A/S.

C-bus is a trademark of Corollary, Inc. in the United States and/or other countries.

Java and all Java-based trademarks and logos are trademarks or registered trademarks of Sun Microsystems, Inc. in the United States and/or other countries.

Microsoft, Windows, Windows NT, and the Windows logo are trademarks of Microsoft Corporation in the United States and/or other countries.

PC Direct is a trademark of Ziff Communications Company in the United States and/or other countries and is used by IBM Corporation under license.

ActionMedia, LANDesk, MMX, Pentium and ProShare are trademarks of Intel Corporation in the United States and/or other countries.

UNIX is a registered trademark in the United States and other countries licensed exclusively through The Open Group.

SET, SET Secure Electronic Transaction, and the SET Logo are trademarks owned by SET Secure Electronic Transaction LLC.

Other company, product, and service names may be trademarks or service marks of others.