

IBM

@server

pSeries 610 Model 6C1 and Model 6E1

User's Guide

SA38-0598-01





@server[®]

pSeries 610 Model 6C1 and Model 6E1
User's Guide

SA38-0598-01

Second Edition (February 2002)

Before using this information and the product it supports, read the information in "Safety Notices" on page xi, Appendix A, "Environmental Notices" on page 161, and Appendix B, "Notices" on page 163.

A reader's comment form is provided at the back of this publication. If the form has been removed, address comments to Information Development, Department H6DS-905-6C006, 11400 Burnet Road, Austin, Texas 78758-3493. To send comments electronically, use this commercial internet address: aix6kpub@austin.ibm.com. Any information that you supply may be used without incurring any obligation to you.

© **International Business Machines Corporation 2001, 2002. All rights reserved.** Note to U.S. Government Users -- Documentation related to restricted rights -- Use, duplication or disclosure is subject to restrictions set forth in GSA ADP Schedule Contract with IBM Corp.

Contents

Safety Notices	xi
Rack Safety Instructions	xi
Electrical Safety	xii
Laser Safety Information	xiii
Laser Compliance	xiii
Data Integrity and Verification	xv
About This Book	xvii
ISO 9000	xvii
Online Publications	xvii
Related Publications	xvii
Ergonomic Information	xviii
Trademarks	xviii
Chapter 1. Introducing the System	1
System Features	1
Bus Architecture	1
Processors	1
Memory	1
Media Drives	1
Other Drives	2
Power supply	2
Keyboard	2
Mouse	2
Operator Panel	2
Input/Output Ports	2
Security Features	2
Front View	3
Rear View	5
Operator Panel	7
Chapter 2. Using the System	9
Starting the System Unit	9
Stopping the System Unit	9
Reading the Operator Panel Display	9
Operator Panel	10
Attention LED and Lightpath LEDs	11
Operator Panel Display	11
Indicator Panel	12
Component LEDs	13
Reporting the Problem	14
Using the Keyboards	15
Using the Three-Button Mouse	16
Handling the Mouse Correctly	16
Caring for the Mouse	16
Cleaning the Mouse	17

Using the 3.5-Inch Diskette Drive	18
Write-Protecting 3.5-Inch Diskettes	18
Loading and Unloading the 3.5-Inch Diskette	19
Using the CD-ROM Drive	19
Front View of CD-ROM Drive	20
Understanding the Status Lights	20
Handling Compact Discs	21
Other Handling Considerations	21
Loading a Compact Disc	22
Opening the Tray Manually	22
Playing an Audio CD	22
Using the Service Processor and Service Director Features	23
Service Processor	23
Service Director	24
Chapter 3. Using the Service Processor.	25
Service Processor Menus	26
Service Processor Menu Inactivity	26
Accessing Service Processor Menus Locally	26
Accessing Service Processor Menus Remotely	26
Saving and Restoring Service Processor Settings	26
General User Menu	27
Privileged User Menus	29
Main Menu	29
Service Processor Setup Menu	30
Passwords	30
Serial Port Snoop Setup Menu	33
System Power Control Menu	34
System Information Menu	38
Language Selection Menu	41
Call-In/Call-Out Setup Menu	42
Modem Configuration Menu	43
Serial Port Selection Menu	43
Serial Port Speed Setup Menu	44
Telephone Number Setup Menu	44
Call-Out Policy Setup Menu	46
Customer Account Setup Menu	47
Call-Out Test	47
System Power-On Methods	48
Service Processor Call-In Security	49
Service Processor Reboot/Restart Recovery	49
Boot (IPL) Speed	49
Failure During Boot Process	49
Failure During Normal System Operation	49
Service Processor Reboot/Restart Policy Controls	50
Processor Boot-Time Deconfiguration (CPU Repeat Gard)	50
Memory Boot-Time Deconfiguration (Memory Repeat Gard)	50
Service Processor System Monitoring - Surveillance	51
System Firmware Surveillance.	51
Operating System Surveillance	51

Call Out	52
Console Mirroring	53
System Configuration for Console Mirroring	53
Service Processor Firmware Updates	54
Service Processor Error Log	54
Service Processor Operational Phases	55
Pre-Standby Phase	55
Standby Phase	55
Bring-Up Phase	56
Run-time Phase	56
Service Processor Procedures in Service Mode	57
Chapter 4. Using System Management Services	59
Graphical System Management Services	59
Config.	62
Multiboot	63
Utilities	65
Password	67
Spin Delay	71
Error Log.	72
RIPL	73
SCSI ID	78
Firmware Update	79
Firmware Recovery	79
Text-Based System Management Services	80
Select Language	81
Change Password Options	82
Set Privileged-Access Password	82
Unattended Start Mode	82
View Error Log	83
Setup Remote IPL (Initial Program Load)	84
Change SCSI Settings	87
Select Console	87
Select Boot Options	88
Select Boot Device	89
Configure Nth Boot Device	90
View System Configuration Components	91
System/Service Processor Firmware Update	92
Firmware Recovery	92
Chapter 5. Using the Standalone and Online Diagnostics	93
Standalone and Online Diagnostics Operating Considerations	93
Selecting a Console Display	93
Identifying the Terminal Type to the Diagnostics Programs	93
Undefined Terminal Types	94
Running Online Diagnostics from CD-ROM	94
Running Standalone Diagnostics from a Network Installation Management (NIM) Server	94
Running Online Diagnostics	98
Running the Diagnostics from a TTY Terminal	99

Online Diagnostics Mode of Operation	99
Running the Online Diagnostics in Service Mode (Service Mode IPL)	99
Running the Online Diagnostics in Concurrent Mode	100
Running the Online Diagnostics in Maintenance Mode	101
Standalone Diagnostic Operation	102
Running the Standalone Diagnostics	102
Chapter 6. Introducing Tasks and Service Aids	103
Tasks	103
Add Resource to Resource List	104
AIX Shell Prompt	105
Analyze Adapter Internal Log.	105
Backup and Restore Media	105
Certify Media	105
Change Hardware Vital Product Data	109
Configure Dials and LPF Keys	109
Configure ISA Adapter	109
Configure Reboot Policy	110
Configure Remote Maintenance Policy	111
Configure Ring Indicate Power On Policy.	113
Configure Surveillance Policy.	113
Create Customized Configuration Diskette	114
Delete Resource from Resource List	114
Disk Maintenance	114
Disk to Disk Copy	114
Display/Alter Sector	115
Display Configuration and Resource List	115
Display Firmware Device Node Information	115
Display Hardware Error Report	116
Display Hardware Vital Product Data	116
Display Machine Check Error Log	116
Display Microcode Level	116
Display or Change Bootlist	117
Display or Change Diagnostic Run-Time Options	117
Display Previous Diagnostic Results	118
Display Resource Attributes	118
Display Service Hints	118
Display Software Product Data	119
Display System Environmental Sensors	119
Examples	120
Display Test Patterns	121
Download Microcode	121
Download Microcode to PCI SCSI RAID Adapter	121
Download Microcode to Disk Drive Attached to a PCI SCSI RAID Adapter	121
Download Microcode to a PCI FC-AL Adapter	121
Download Microcode to DVD-RAM Attached to a PCI SCSI Adapter.	122
Download Microcode to Disk Attached to PCI SCSI Adapter	122
Download Microcode to Other Devices	122
Fibre Channel RAID Service Aids	123
Flash SK-NET FDDI Firmware	124

Format Media	124
Hardfile Attached to SCSI Adapter (non-RAID)	124
Hardfile Attached to PCI SCSI RAID Adapter	125
Optical Media	125
Diskette Format	126
Gather System Information	126
Generic Microcode Download	126
Hot Plug Task.	127
PCI Hot Plug Manager	127
SCSI Hot Swap Manager	129
RAID Hot Plug Devices	130
Local Area Network Analyzer.	130
Log Repair Action	130
Periodic Diagnostics	131
PCI RAID Physical Disk Identify.	131
Process Supplemental Media	131
Run Diagnostics	132
Run Error Log Analysis	132
Run Exercisers	132
Exerciser Commands (CMD).	133
Abbreviations	133
Memory Exerciser	133
Tape Exerciser	134
Diskette Exerciser	134
CD-ROM Exerciser	134
Save or Restore Hardware Management Policies	134
SCSI BUS Analyzer.	135
SCSI Tape Drive Service Aid.	136
Spare Sector Availability	137
SSA Service Aid	137
System Fault Indicator	137
System Identify Indicator	138
Update Disk-Based Diagnostics.	138
Update System or Service Processor Flash	139
7135 RAIDiant Array Service Aid	140
Adapter Microcode Download	140
Physical Disk Microcode Download.	141
Physical Disk Format	141
Physical Disk Certify	141
Physical Disk Identify	141
7318 Serial Communications Network Server Service Aid	141
Chapter 7. Using the System Verification Procedure	143
Step 1. Considerations before Running This Procedure	143
Step 2. Loading the Diagnostics.	143
Step 3. Running System Verification	144
Step 4. Additional System Verification	144
Step 5. Stopping the Diagnostics	145
Chapter 8. Hardware Problem Determination	147

Problem Determination Using the Standalone or Online Diagnostics	147
Step 2.	147
Problem Determination When Unable to Load Diagnostics	154
Chapter 9. Repair Action	159
Appendix A. Environmental Notices.	161
Product Recycling and Disposal.	161
Environmental Design	161
Acoustical Noise Emissions	161
Declared Acoustical Noise Emissions	161
Appendix B. Notices	163
Appendix C. General Attributes Required When Using a TTY Terminal	165
Additional Communication Attributes	166
Additional Keyboard Attributes	167
Additional Printer Attributes	168
Appendix D. Firmware Updates	169
Checking the Current Firmware Levels	169
Updating System Firmware	169
Appendix E. Service Processor Setup and Test	171
Service Processor Setup Checklist	171
Testing the Setup	172
Testing Call-In	172
Testing Call-Out	172
Serial Port Configuration	173
Appendix F. Modem Configurations	175
Sample Modem Configuration Files	175
Generic Modem Configuration Files	175
Specific Modem Configuration Files	175
Configuration File Selection	176
Examples for Using the Generic Sample Modem Configuration Files	178
Customizing the Modem Configuration Files.	178
IBM 7852-400 DIP Switch Settings.	179
Xon/Xoff Modems	179
Ring Detection	179
Terminal Emulators	180
Recovery Procedures	180
Transfer of a Modem Session	180
Recovery Strategy	181
Prevention Strategy.	182
Modem Configuration Sample Files	183
Sample File modem_m0.cfg	183
Sample File modem_m1.cfg	185
Sample File modem_z.cfg.	187

Sample File modem_z0.cfg	189
Sample File modem_f.cfg	191
Sample File modem_f0.cfg	194
Sample File modem_f1.cfg	197
Index	201

Safety Notices

A *danger* notice indicates the presence of a hazard that has the potential of causing death or serious personal injury. Danger notices appear on the following pages:

- xii

A *caution* notice indicates the presence of a hazard that has the potential of causing moderate or minor personal injury. Caution notices appear on the following pages:

- xii
- xiii
- 19

Note: For a translation of these notices, see *System Unit Safety Information*, order number SA23-2652.

Rack Safety Instructions

- Do not install this unit in a rack where the internal rack ambient temperatures will exceed 40 degrees C.
- Do not install this unit in a rack where the air flow is compromised. Any side, front or back of the unit used for air flow through the unit must not be in direct contact with the rack.
- Care should be taken to ensure that a hazardous condition is not created due to uneven mechanical loading when installing this unit in a rack. If the rack has a stabilizer it must be firmly attached before installing or removing this unit.
- Consideration should be given to the connection of the equipment to the supply circuit so that overloading of circuits does not compromise the supply wiring or overcurrent protection. To provide the correct power connection to the rack, refer to the rating labels located on the equipment in the rack to determine the total power requirement for the supply circuit.
- An electrical outlet that is not correctly wired could place hazardous voltage on the metal parts of the system or the devices that attach to the system. It is the responsibility of the customer to ensure that the outlet is correctly wired and grounded to prevent an electrical shock.

Electrical Safety

Observe the following safety instructions any time you are connecting or disconnecting devices attached to the workstation.

DANGER

An electrical outlet that is not correctly wired could place hazardous voltage on metal parts of the system or the devices that attach to the system. It is the responsibility of the customer to ensure that the outlet is correctly wired and grounded to prevent an electrical shock.

Before installing or removing signal cables, ensure that the power cables for the system unit and all attached devices are unplugged.

When adding or removing any additional devices to or from the system, ensure that the power cables for those devices are unplugged before the signal cables are connected. If possible, disconnect all power cables from the existing system before you add a device.

Use one hand, when possible, to connect or disconnect signal cables to prevent a possible shock from touching two surfaces with different electrical potentials.

During an electrical storm, do not connect cables for display stations, printers, telephones, or station protectors for communications lines.

CAUTION:

This product is equipped with a three-wire power cable and plug for the user's safety. Use this power cable with a properly grounded electrical outlet to avoid electrical shock.

DANGER

To prevent electrical shock hazard, disconnect all power cables from the electrical outlet before relocating the system.

Laser Safety Information

CAUTION:

This product may contain a CD-ROM which is a class 1 laser product.

Laser Compliance

All lasers are certified in the U.S. to conform to the requirements of DHHS 21 CFR Subchapter J for class 1 laser products. Outside the U.S., they are certified to be in compliance with the IEC 825 (first edition 1984) as a class 1 laser product. Consult the label on each part for laser certification numbers and approval information.

CAUTION:

All IBM laser modules are designed so that there is never any human access to laser radiation above a class 1 level during normal operation, user maintenance, or prescribed service conditions. Data processing environments can contain equipment transmitting on system links with laser modules that operate at greater than class 1 power levels. For this reason, never look into the end of an optical fiber cable or open receptacle. Only trained service personnel should perform the inspection or repair of optical fiber cable assemblies and receptacles.

Data Integrity and Verification

IBM computer systems contain mechanisms designed to reduce the possibility of undetected data corruption or loss. This risk, however, cannot be eliminated. Users who experience unplanned outages, system failures, power fluctuations or outages, or component failures must verify the accuracy of operations performed and data saved or transmitted by the system at or near the time of the outage or failure. In addition, users must establish procedures to ensure that there is independent data verification before relying on such data in sensitive or critical operations. Users should periodically check the IBM support websites for updated information and fixes applicable to the system and related software.

About This Book

This book provides information about the @server pSeries 610 Model 6C1 and Model 6E1, specifically how to use the system, use diagnostics and service aids, and verify system operation. In this book, the @server pSeries 610 Model 6C1 and Model 6E1 are hereafter referred to as the "system."

ISO 9000

ISO 9000 registered quality systems were used in the development and manufacturing of this product.

Online Publications

IBM @server pSeries publications are available online. To access the online books, visit our Web site at: http://www.ibm.com/servers/eserver/pseries/library/hardware_docs/

Related Publications

The following publications provide additional information about your system unit:

- The *@server pSeries 610 Model 6C1 and Model 6E1 Installation Guide*, order number SA38-0597, contains information on how to set up and cable the system, install and remove options, and verify system operation.
- The *@server pSeries 610 Model 6C1 and Model 6E1 Service Guide*, order number SA38-0599, contains reference information, maintenance analysis procedures (MAPs), error codes, removal and replacement procedures, and a parts catalog.
- The *RS/6000 @server pSeries Diagnostic Information for Multiple Bus Systems*, order number SA38-0509, contains diagnostic information, service request numbers (SRNs), and failing function codes (FFCs).
- The *RS/6000 @server pSeries Adapters, Devices, and Cable Information for Multiple Bus Systems*, order number SA38-0516, contains information about adapters, devices, and cables for your system. This manual is intended to supplement the service information found in the *RS/6000 @server pSeries Diagnostic Information for Multiple Bus Systems*.
- The *Site and Hardware Planning Guide*, order number SA38-0508, contains information to help you plan your installation.
- The *System Unit Safety Information*, order number SA23-2652, contains translations of safety information used throughout this book.
- The *PCI Adapter Placement Reference*, order number SA38-0538, contains information regarding slot restrictions for adapters that can be used in this system.

Ergonomic Information

After you have set up your system, we encourage you to visit the Healthy Computing Web site. Good ergonomic practice is important to get the most from your workstation and to avoid discomfort. This means that the equipment and the workplace should be arranged to suit your individual needs and the kind of work you do.

The Healthy Computing Web site gives ergonomic guidelines to help you understand the ergonomic considerations that you should know when working at a computer workstation. The address is: <http://www.us.pc.ibm.com/healthycomputing>

Trademarks

The following terms are trademarks of International Business Machines Corporation in the United States, other countries, or both:

- AIX
- IBM
- PowerPC
- pSeries
- e (logo)

Other company, product, and service names may be trademarks or service marks of others.

Chapter 1. Introducing the System

This chapter provides information on the system features of the @server pSeries 610 Model 6C1 and Model 6E1. The Model 6E1 is a deskside system and the Model 6C1 is a rack mount system.

System Features

Bus Architecture

Five PCI slots are available:

- Two 64-bit PCI full-size slots at 50 MHz (can also run at 33MHz), 3.3 volts
- One 64-bit PCI full-size slots at 33 MHz, 5 volts
- Two 32-bit PCI full-size slots at 33 MHz, 5 volts

Processors

One or two one-way processor cards

333 MHz with 4 MB L2 cache

OR

375 MHz with 4 MB L2 cache

OR

450 MHz with 8 MB L2 cache

Memory

- 512 MB (minimum) - 8 GB (maximum) with other processors.
Up to sixteen dual inline memory modules to support 256 MB or 512 MB (must be installed in matched pairs)

Media Drives

- 3.5-inch, 1.44 MB Diskette Drive (standard)
- Three media bays available
 - Disk drive (behind operator panel), optional on some systems
 - Optional media bay
 - CD-ROM bay
- Six hot plug disk drives (optional on some systems)
- 40x speed CD-ROM drive with sliding tray

Other Drives

Media bays can accommodate 5.25-inch or 3.5-inch drives such as CD-ROM drives, tape drives, or other removable media drives.

Power supply

- Up to three 250-watt; third power supply is for redundant power.

Keyboard

- Standard: 101-key enhanced keyboard
- 101/102 or 106-key enhanced keyboard

Mouse

- Three-button

Operator Panel

- 32-character LED diagnostics display
- Power and Reset buttons

Input/Output Ports

- 25-pin Parallel
- 9-pin Serial (3)
- Keyboard
- Mouse
- Ultra3 160 SCSI
- Integrated Drive Electronics (IDE)
- 10BaseT5 and 100BaseTX Ethernet

Security Features

- Power-on password
- Privileged-access password
- Security bolt (optional)
- Key lock
- Unattended start mode

Front View

Model 6E1

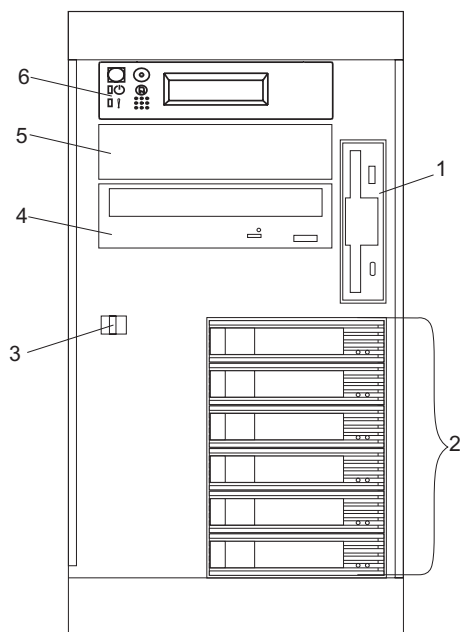

- | | | | |
|---|---------------------|---|---|
| 1 | Diskette drive | 2 | Hot-swap disk drives (optional on some systems) |
| 3 | Cover release lever | 4 | CD-ROM drive |
| 5 | Media bay | 6 | Operator panel |

Model 6C1

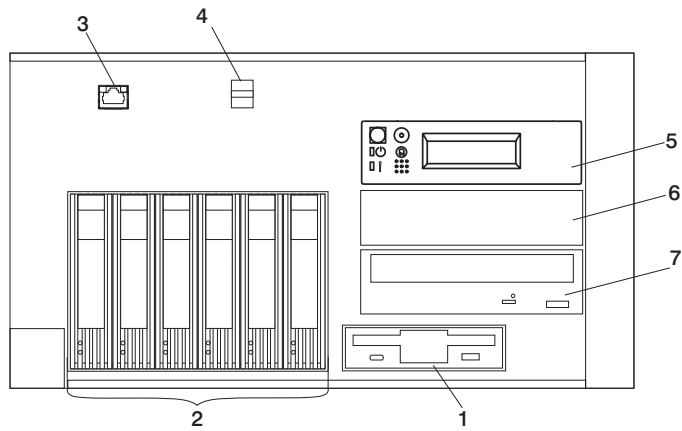

- | | | | |
|---|-----------------------|---|---|
| 1 | Diskette drive | 2 | Hot-swap disk drives (optional on some systems) |
| 3 | Serial port connector | 4 | Cover release lever |
| 5 | Operator panel | 6 | Media bay |
| 7 | CD-ROM drive | | |

Rear View

Model 6E1

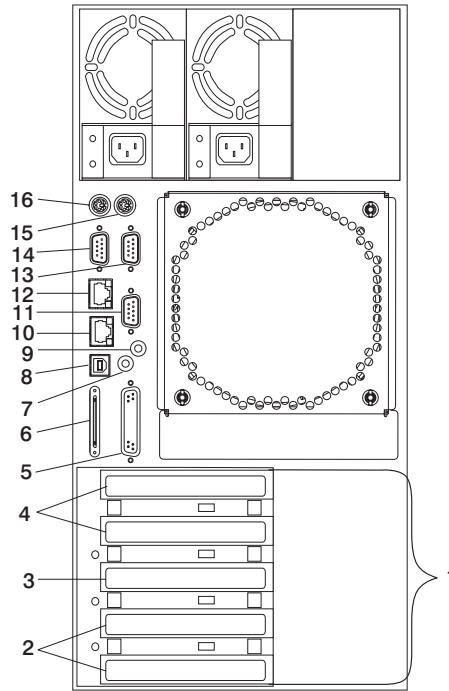

- | | | | |
|----|-------------------------|----|------------------------------|
| 1 | PCI slots 1-5 | 2 | PCI slots 1-2
64-bit/3.3V |
| 3 | PCI slot 3
64-bit/5V | 4 | PCI slots 4-5
32-bit/3.3V |
| 5 | Parallel connector | 6 | SCSI connector |
| 7 | Attention LED | 8 | Rack indicator connector |
| 9 | Power LED | 10 | Ethernet connector 2 |
| 11 | Serial connector 1 | 12 | Ethernet connector 1 |
| 13 | Serial connector 3 | 14 | Serial connector 2 |
| 15 | Mouse connector | 16 | Keyboard connector |

Model 6C1

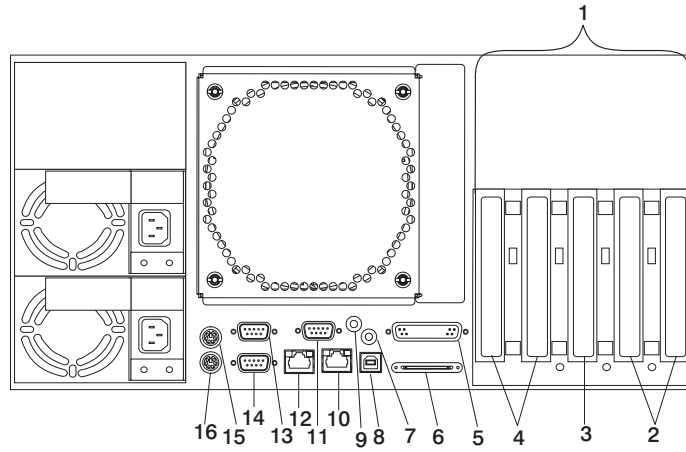

- | | | | |
|----|-------------------------|----|------------------------------|
| 1 | PCI slots 1-5 | 2 | PCI slots 1-2
64-bit/3.3V |
| 3 | PCI slot 3
64-bit/5V | 4 | PCI slots 4-5
32-bit/3.3V |
| 5 | Parallel connector | 6 | SCSI connector |
| 7 | Attention LED | 8 | Rack indicator connector |
| 9 | Power LED | 10 | Ethernet connector 2 |
| 11 | Serial connector 1 | 12 | Ethernet connector 1 |
| 13 | Serial connector 3 | 14 | Serial connector 2 |
| 15 | Mouse connector | 16 | Keyboard connector |

Operator Panel

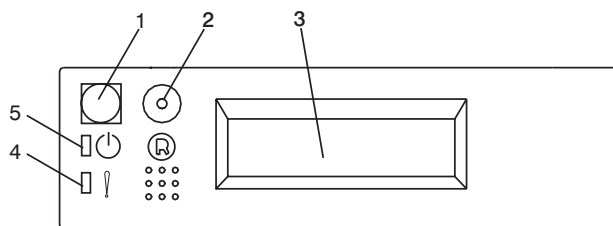

1	Power-On Switch
2	Reset Switch
3	Display
4	Attention LED
5	Power-On LED

Chapter 2. Using the System

This chapter provides information on how to start and use the system.

Starting the System Unit

1. Set the power switches of the attached devices to On.

Note: When the system is plugged in but not powered on, the Power-On LED flashes slowly.

2. If the LED is not flashing and 0K is not displayed, ensure that the power cord, located at the back of the system unit, is plugged into a grounded electrical outlet.
3. If this does not solve the problem, go to Chapter 8, “Hardware Problem Determination” on page 147.
4. Press the Power-On switch.

When you press the Power-On switch, the Power-On LED comes on, and the system starts a POST (power-on self-test).

During POST, progress codes display in the operator panel display.

5. If the Power-On LED does not come on and there is no indication of power when you press the Power-On switch, go to Chapter 8, “Hardware Problem Determination” on page 147.

Stopping the System Unit

Attention: When you use the shutdown procedure for your system, follow the correct shutdown procedure before you stop the system. Failure to do so can result in the loss of data. The system is powered down by the shutdown procedure.

1. At a command line, type shutdown to stop the operating system.
2. After you shut down the operating system, set the power switches of any attached devices to Off.
3. If you will be servicing the system, unplug the system-unit power cable from the electrical outlet.

Reading the Operator Panel Display

The operator panel display is used to:

- Track the progress of the system unit self-tests and configuration program
- Display codes when the operating system comes to an abnormal end
- Display system messages

Operator Panel

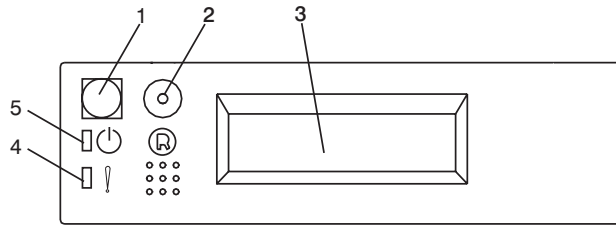

Number	Component Name	Component Description
1	Power-On Switch	Turns the system drawer's power on and off.
2	Reset Switch	Function depends upon the operating system.
3	Power-On LED	Glows green when the system is powered on and blinks slowly when the system is in standby mode.
4	System Attention LED (System Fault/System Identify Indicator)	Glows amber when the system is in the following states: <ul style="list-style-type: none"> • Normal State - LED is off • Fault State - LED is on solid • Identify State - LED is blinking
5	Operator Panel Display	Displays current status of system drawer startup, or diagnostic information in the event of a hardware problem.

Attention LED and Lightpath LEDs

The Attention and Lightpath LEDs provide a means to identify failing components in your server.

Operator Panel Display

When a failing component is detected in your server, the Attention LED is turned on. To further help you identify the failing component, go to the indicator panel (see “Indicator Panel” on page 12) inside the server and check which LEDs are on. If either of the following conditions exist:

- No LEDs lit on the indicator panel
- PCI LED is the only LED lit on the indicator panel

Go to Step 3 in “Problem Determination Using the Standalone or Online Diagnostics” on page 147. Otherwise, continue with this procedure.

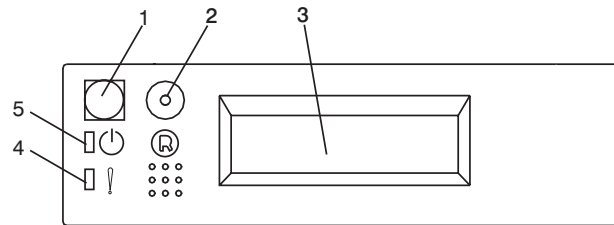

1	Power-On Switch
2	Reset Switch
3	Display
4	Attention LED
5	Power-On LED

Indicator Panel

You can access the indicator panel without any tools. The panel provides enough information to identify the area that needs attention. The panel contains a group of amber LEDs that indicate which functional area of the system is experiencing the fault (such as Power, CPUs, Memory, Fans). If one of these LEDs is on, the user or service representative is directed to the physical area of the server where they will find an additional LED on, indicating that the component is responsible for the current fault.

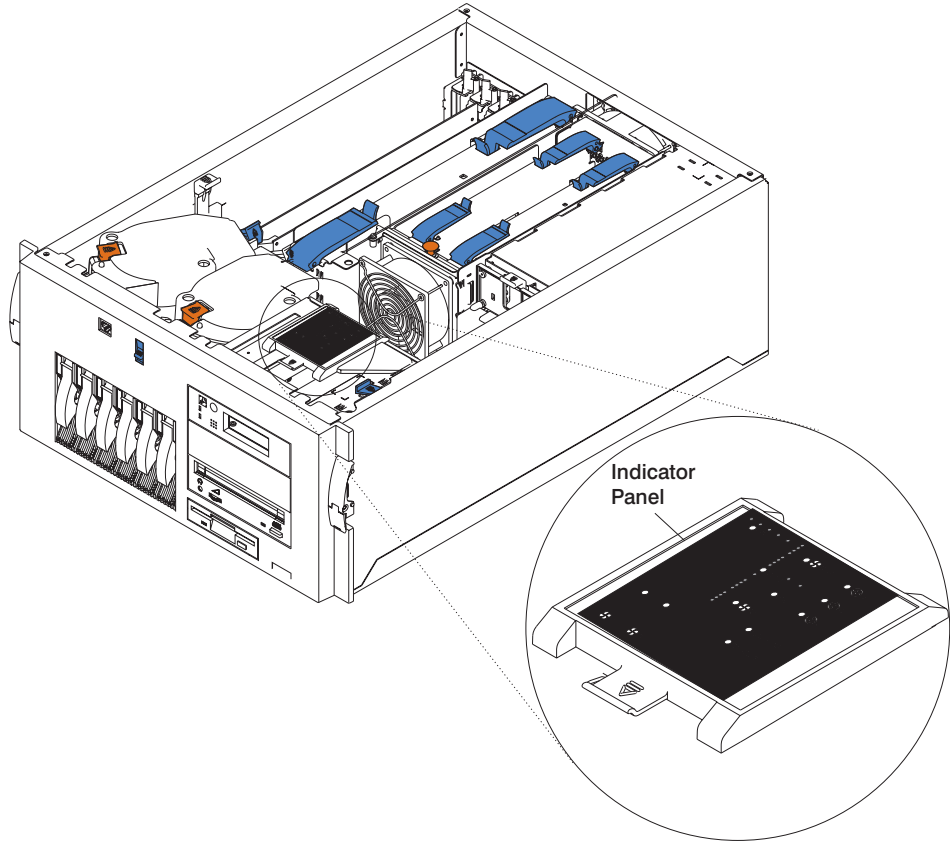

The following illustration shows the LEDs on the indicator panel, located inside the server.

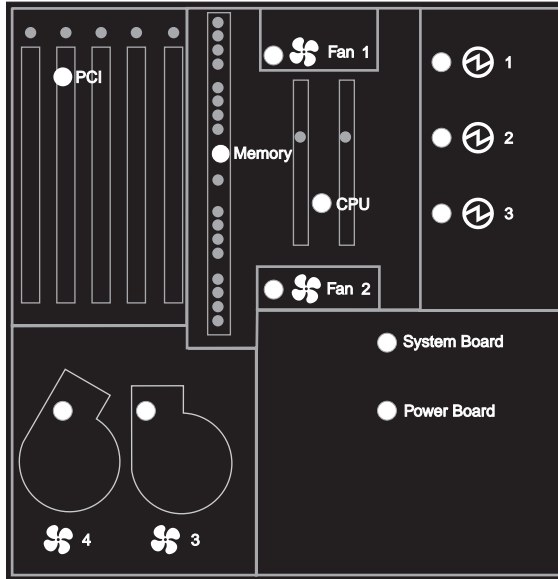

Component LEDs

In addition to the indicator panel or display, individual LEDs are located on or near the failing components. The LEDs are either on the component itself or on the carrier of the component (memory card, fan, memory module, CPU).

The LEDs are amber, except for the power supplies. For the power supplies, two green LEDs (AC Power Good and DC Power Good) indicate the fault condition for the power supply.

Reporting the Problem

After you have determined which component is failing, report the problem.

1. Record the following information before calling for service:
 - Machine type and model
 - Server serial number
 - Any error codes that appear in the operator panel display or console
 - Any LEDs lit on the indicator panel
2. Call for service. You will be given the choice to replace the failing component yourself or have a service representative replace it. If you are replacing the failing component, go to Chapter 9, "Repair Action" on page 159 for instructions.

Using the Keyboards

There are several keyboards available for the system. The keyboards have various keys that enter data and control the cursor location. The keyboards can be engraved for the languages of various countries.

The functions of each keyboard depend on the software used. The character sets for the keyboards are contained and explained in the documentation for your operating system.

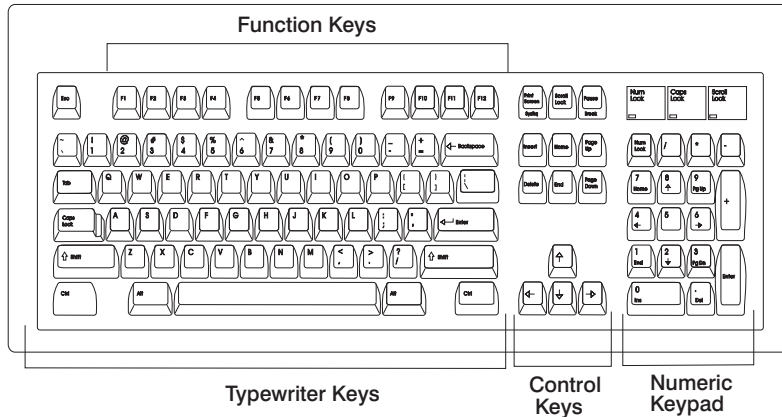

The keyboard is divided into four sections:

- *Function keys* are multipurpose keys and their function is controlled by the operating system.
- *Typewriter keys* are similar to a standard typewriter. Their function is controlled by the software.
- *Control keys* move the cursor on the screen and do programmed control functions. The movement and functions depend upon the application used.
- *Numeric keypad* is arranged like a calculator to help when typing numbers.

On all of the keyboards, you can adjust the tilt position for typing comfort. To tilt the keyboard, pull out on the keyboard legs. The legs snap into position. To decrease the tilt of the keyboard, rotate the keyboard legs until they snap into the bottom of the keyboard case.

The keyboard cable plugs into the keyboard connector at the rear of the system.

Using the Three-Button Mouse

The mouse is a hand-operated locating device. A three-button mouse is available for use with the system. Consult your application publication for the exact use of the three-button mouse.

You can use the mouse to perform such functions as positioning a cursor, selecting items from a menu, or moving around in your document much easier and faster than if you used only the keyboard. The cursor moves exactly as you move the mouse on a flat surface, such as a desktop.

With the mouse buttons, you can perform functions such as selecting and deselecting options, extending your selection, or choosing a command. The precise function of your mouse depends on the software you are using.

The mouse cable plugs into the mouse connector at the rear of the system.

Handling the Mouse Correctly

For best operation, handle the mouse with care. Incorrect handling can damage the mouse.

Do not:

- Operate the mouse on cloth, unfinished wood, newspaper, or carpet.
- Drop or hit the mouse.
- Carry the mouse by holding onto the cable.
- Expose the mouse to extreme temperatures or direct sunlight.
- Place the mouse in liquid spills.

Caring for the Mouse

The operating surface for the mouse should be smooth, clean, and flat. For example, you can operate the mouse on the following surfaces:

- Finished wood
- Glass
- Enamel
- Plastic
- Paper (except newspaper)
- Metal

Rough surfaces collect contaminants that can be transferred to the interior of the mouse by the ball. Rough surfaces can also cause the pads located on the bottom of the mouse to prematurely wear. A deeply pitted surface could cause erratic operation of the mouse. The surface you use should be free from spills, dirt, dust, lint, wax, eraser dust, and other foreign matter.

To care for the mouse:

- Inspect the work surface for spills or other contaminants.
- Dust the work surface.
- If you are using a paper pad, inspect it for wear and replace it if necessary.

Cleaning the Mouse

Use the following steps to clean the mouse:

1. Remove the retaining ring by turning it counterclockwise, in the direction of the arrow, as shown in the illustration.

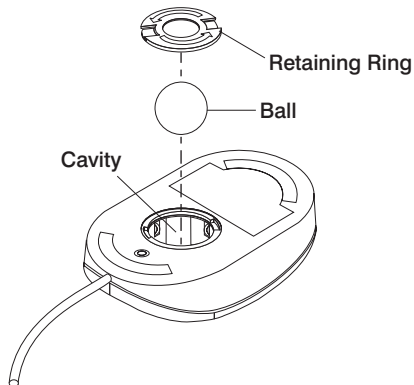

2. Remove the ball.
3. Inspect the ball for contaminants. Wipe it clean with a dry, lint-free cloth.
4. If the ball is dirty, wash it in warm, soapy water. Rinse and wipe the ball with a lint-free cloth until dry.
5. Inspect the ball cavity in the mouse for foreign materials. If there are any foreign materials, remove them.
6. Replace the ball.
7. Replace the retaining ring on the mouse and align it with the open slots in the ball cavity.
8. Turn the retaining ring clockwise until the open slots are covered and you hear the ring snap into place.

Using the 3.5-Inch Diskette Drive

The system unit has a 1.44 MB diskette drive installed vertically in the front.

The 1.44 MB diskette drive can format, read, and write diskettes compatible with the following diskette drives:

- 1.0 MB diskettes with 720 KB formatted data capacity
- 2.0 MB diskettes with 1.44 MB formatted data capacity (High Density)

Format the diskette according to its specified capacity.

Write-Protecting 3.5-Inch Diskettes

Write-protecting diskettes is necessary so that important information is not accidentally lost. When diskettes are write-protected, you can read information from the diskettes, but you cannot write information to them.

There is a write-protect tab on the 3.5-inch diskette. To locate the write-protect tab, turn the diskette over with the label facing down.

To prevent writing onto a diskette, slide the write-protect tab to open the protect slot, as shown in the illustration.

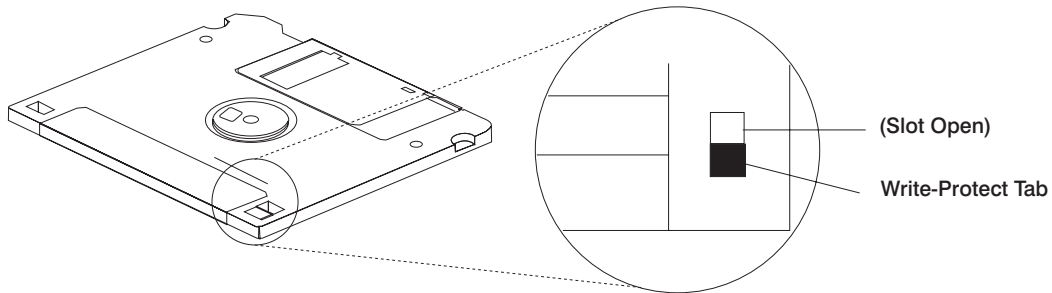

To allow writing onto a diskette, slide the write-protect tab to cover the protect slot, as shown in the illustration.

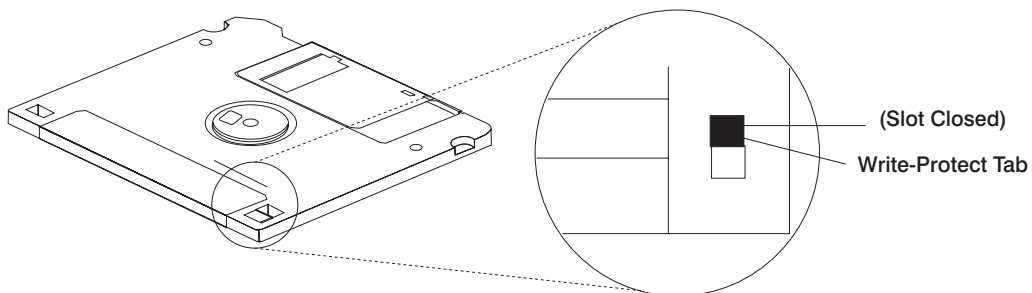

Loading and Unloading the 3.5-Inch Diskette

To load a diskette into the drive, insert the diskette in the diskette drive with the labeled metal shutter first. Push the diskette into the drive until you hear a click. The click indicates that the diskette is securely in position in the drive.

To unload the diskette, push the diskette-unload button. The diskette unloads partially from the drive. Remove the diskette.

Using the CD-ROM Drive

CAUTION:

A class 1 laser is contained in the device. Do not attempt to operate the drive while it is disassembled. Do not attempt to open the covers of the drive as it is not serviceable and is replaced as a unit.

This section describes the features of the 40X SCSI-2 CD-ROM drive and provides instructions for handling the drive and CD-ROM discs. The CD-ROM is a half-high, 5.25", 8-bit, single-ended, tray-loading drive. Its features include the following:

- SCSI-2 interface supports both synchronous and asynchronous data transfer
- High-speed data transfer rate of 2100 KB per second (14X) at inner diameter and 4800 KB per second (32X) at outer diameter due to constant RPM spin rate
- High-speed synchronous burst rate of 10 MB per second
- Average random access time of 90 ms
- Loading tray accommodates both 8 cm discs (in the horizontal orientation only) and 12 cm discs
- Reads multi-session discs
- Reads CD-recordable discs
- Reads CD-RW discs
- Supports all major CD-ROM formats: Mode 1, Mode 2, XA, CDDA, and audio
- Headphone output and line output for audio

Front View of CD-ROM Drive

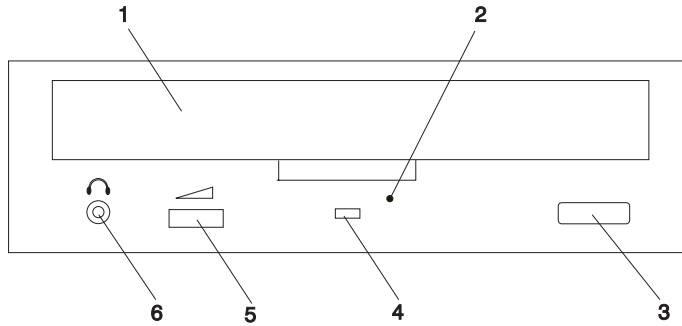

- 1 Compact Disc Tray
- 2 Emergency Eject Hole
- 3 Load/Unload Button
- 4 Status Light
- 5 Volume Control
- 6 Headphone Jack

Understanding the Status Lights

The status lights indicate the operational status of the drive. The various conditions are as follows:

If light is:	Condition is:
Off	Drive is in standby mode with or without a disc loaded.
Blinking (green)	Any of the following: <ul style="list-style-type: none">• Drive tray is inserted. The light blinks while the drive completes the initialization checkout.• Drive is reading data. The light blinks while data is being read.• Drive is in Play Audio Mode. The light blinks while the audio is playing.
On (amber)	Hardware error condition found during initialization. Note: If this occurs, contact your service representative.

Handling Compact Discs

Compact discs are high-density media that must be handled with care and kept clean to ensure that they remain readable. Use the following precautions to ensure reliability:

- Hold the compact disc by the edges. Do not touch the surface of the compact disc.
- To remove dust or fingerprints, wipe the compact disc from the center to the outside of the compact disc as shown, using a lint-free cloth.

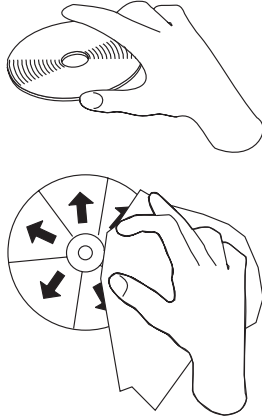

Attention: Wiping the compact disc in a circular direction can cause loss of data.

- Do not write on the surface.
- Do not store or place the compact disc in direct sunlight.
- Do not use benzene, thinners, or other cleaners to clean the compact disc.
- Do not bend the compact disc.

Other Handling Considerations

Be sure to take the following additional precautions when you use the CD-ROM drive:

- Remove compact discs from the tray before you move the drive anywhere.
- Do not place the drive where any of the following conditions exist:
 - High temperature
 - High humidity
 - Excessive dust
 - Excessive vibration or sudden shock
 - Inclined surface
 - Direct sunlight
- Do not insert foreign objects into the drive.
- Do not remove the drive covers or attempt to service the drive yourself.

Loading a Compact Disc

To load a compact disc into the drive, do the following:

1. Press the Load/Unload button to open the tray. The tray slides out of the drive.
2. Place the compact disc in the tray with the label facing up.
3. Press the Load/Unload button, or gently push in the tray, to close the tray.

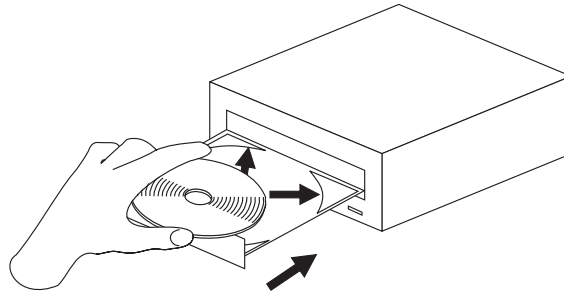

Note: Be sure that none of the vertical retaining tabs are extended when you use the drive in the horizontal position.

Opening the Tray Manually

The compact disc tray automatically opens when you press the Load/Unload button. If it does not automatically open, follow these steps to force it open manually:

1. Shut down and turn off the power to your system.
2. Insert the straightened end of a paper clip into the emergency eject hole until you feel some resistance. See “Front View of CD-ROM Drive” on page 20 if you are not sure where the emergency eject hole is located.
3. Continue to push in the paper clip while you pull out the tray with your fingernail.
4. Pull the tray completely open and remove the disc. It is normal for the tray to make a clicking sound while you are pulling it open.

Playing an Audio CD

To play an audio CD, you must have headphones connected to the headphone jack located on the front of the drive, or connected to the line-out connector located on the back of the system. You must also have an audio software application installed.

The headphone jack provides the connection for headphones using a 3.5-mm (1/8") stereo mini-plug. The volume control adjusts the audio output level for the headphones.

Using the Service Processor and Service Director Features

The service processor and service director features protect users against unnecessary system downtime by keeping support personnel (both internal and external) aware of any unexpected changes in the system environment. In combination, the two features provide a flexible solution to automated system maintenance.

Service Processor

The service processor runs on its own power boundary and continually monitors hardware attributes, the AIX operating system, and the environmental conditions within the system. Any system failure which prevents the system from returning to an operational state (a fully functional AIX operating system) is reported by the service processor. The service processor is controlled by firmware and does not require the AIX operating system to be operational to perform its tasks. If any system failures are detected, the service processor has the ability to take predetermined corrective actions. The methods of corrective actions are:

- Surveillance
- Call Home
- AIX operating system monitoring

Surveillance is a function in which the service processor monitors the system through heartbeat communication with the system firmware. The *heartbeat* is a periodic signal that the firmware can monitor. During system startup, the firmware surveillance monitor is automatically enabled to check for heartbeats from the firmware. If a heartbeat is not detected within a default period, the service processor cycles the system power and attempts to restart until the system either restarts successfully, or a predetermined retry threshold is reached. In the event the service processor is unsuccessful in bringing the system online (or in the event that the user asked to be alerted to any service processor-assisted restarts), the system can call home to report the error.

The call home function can be initialized to call either a service center telephone number, a customer administration center, or a digital pager telephone number. The service processor can be configured to stop at the first successful call to any of the numbers listed, or can be configured to call every number provided. If connected to the service center, the service processor transmits the relevant system information (the system's serial number and model type) and service request number (SRN). If connected to a digital pager service, the service processor inputs a customer voice telephone number defined by the customer. An established sequence of digits or the telephone number to a phone near the failed system could be used to signal a system administrator to a potential system failure.

During normal operations, the service processor can also be configured to monitor the AIX operating system. If AIX does not respond to the service processor heartbeat, the service processor assumes the operating system is hung. The service processor can automatically initiate a restart and, if enabled, initiate the call home function to alert the appropriate parties to the system hang. Enabling operating system surveillance also affords AIX the means to detect any service processor failures and report those failures to the service director application.

Unlike the service director, the service processor cannot be configured in a client/server environment where one system can be used to manage all dial-out functionality for a set of systems.

Prior to installing the service director feature, ensure that you have the latest levels of service processor microcode and system firmware. You also need a properly configured modem. For more information on configuring a modem, see “Call-In/Call-Out Setup Menu” on page 42.

Service Director

The Service Director is a software extension to the AIX operating system that monitors the system while the AIX operating system is running. The Service Director monitors and analyzes all recoverable system failures, and, if needed, can automatically place a service call to a service center (without user intervention).

The service center receives the machine type/serial number, host name, SRN, and a problem description. The service center analyzes the problem report and, if warranted, dispatches a service person to the customer site. The service center also determines if any hardware components need to be ordered prior to the service person’s arrival.

The Service Director code also gives the user the option to establish a single system as the problem reporting server. A single system, accessible over the user network, can be used as the central server for all the other systems on the local area network (LAN) that are running the Service Director application. If the Service Director application on a remote client decides a service request needs to be placed, the client forwards the information to the Service Director server, which dials the service center telephone number from its locally attached modem. In this scenario, the user only needs to maintain a single analog line for providing call-out capabilities for a large set of servers.

When used in a scalable parallel (SP) environment, a client/server type implementation is configured. The Service Director client code runs on each of the scalable parallel (SP) nodes. The server component runs on the control workstation. In the event of any system failures, the relevant information is transmitted to the control workstation through the integrated Ethernet. After it has been alerted to the system failure, the control workstation initiates actions to prepare and send the service request.

A modem is required for enabling automated problem reporting to the service center. Configuration files for several types of modems are included as part of the Service Director package. Refer to “Call-In/Call-Out Setup Menu” on page 42 for more information on configuring your modem.

Chapter 3. Using the Service Processor

The service processor menus enable you to configure service processor options and to enable and disable functions.

Service processor menus are available using an ASCII terminal when the server is turned off and the service processor is operating with standby power. Service processor menus are also available when server power is on and the service processor has detected a server problem (such as surveillance failure).

During the first power-on (that is, the power cord is plugged into the outlet), service processor menus are not available for 45 seconds while the service processor is running self-tests and initializing the server. If the server powers off, service processor menus become available after 15 seconds.

Service Processor Menus

The service processor menus are divided into the following groups:

- General user menus - the user must know the general-access password.
- Privileged user menus - the user must know the privileged-access password.

This section describes these menus, how to access them, and the functions associated with each option within the menus.

When the system is powered off, the service processor menus can be accessed locally or remotely.

Service Processor Menu Inactivity

To prevent loss of control in unstable power environments, the service processor leaves the menu mode after five minutes of inactivity. Return to the menus by pressing any key on the local or remote terminal.

Accessing Service Processor Menus Locally

Service processor menus can be accessed locally by connecting an ASCII terminal to either serial port 1 (S1) or serial port 2 (S2). The service processor menus cannot be accessed on serial port 3 (S3). Because the presence of the ASCII terminal cannot be confirmed by the service processor, you must press a key on the ASCII terminal to confirm its presence. After OK displays on the operator panel, the service processor prompts you for a password (if set), and when verified, displays the service processor menus.

Accessing Service Processor Menus Remotely

Service processor menus can be accessed remotely by connecting a modem to serial port 1 or serial port 2, as follows:

1. Turn off the system, unplug the power cord, and press the Power button to drain capacitance while power is disconnected.
2. Connect the modem to the appropriate serial port and turn on the modem.
3. Plug in the system.

Notes:

1. If your modem has not been configured, go to “Call-In/Call-Out Setup Menu” on page 42. With a terminal or terminal emulator, call the system’s modem.
2. The service processor prompts you for a password (if set), and when verified, displays the service processor menus.

Saving and Restoring Service Processor Settings

All the settings you make (except language) from the service processor menus can be backed up either for recovering from a fault that may corrupt these settings, or for replicating these settings to other servers that include a service processor.

The AIX service aid, Save or Restore Hardware Management Policies, can be used to save your settings after initial setup or whenever the settings must be changed for system operation purposes.

It is strongly recommended that you use this AIX service aid for backing up service processor settings to protect the usefulness of the service processor and the availability of the server.

General User Menu

The menu options presented to the general user are a subset of the options available to the privileged user. The user must know the general-access password, if set, to access these menus.

```
GENERAL USER MENU

1. Power-On System
2. Read VPD Image from Last System Boot
3. Read Progress Indicators from Last System Boot
4. Read Service Processor Error Logs
5. Read System POST Errors
6. View System Environmental Conditions
99. Exit from Menu

1>
```

Note: The service processor prompt displays either 1> or 2> to indicate which serial port on the system is being used to communicate with the service processor.

- **Power-On System**

Allows the user to power-on the system.

- **Read VPD Image from Last System Boot**

Displays manufacturer vital product data, such as serial numbers, part numbers, and so on, that were stored from the system boot prior to the one in progress now.

- **Read Progress Indicators from Last System Boot**

Displays the boot progress indicators (checkpoints), up to a maximum of 100, from the system boot prior to the one in progress. This historical information can be useful to help diagnose system faults.

The progress indicators are displayed in two sections. Above the dashed line are the progress indicators (latest) from the boot that produced the current sessions. Below the dashed line are progress indicators (oldest) from the boot preceding the one that produced the current sessions.

The progress indicator codes are listed from top (latest) to bottom (oldest). The dashed line represents the point where the latest boot started.

If the <-- arrow occurs, use the 4-digit checkpoint or 8-digit error code being pointed to as the starting point for your service actions.

- **Read Service Processor Error Logs**

Displays the service processor error logs.

The time stamp in this error log is coordinated universal time (UTC), also known as Greenwich mean time (GMT). AIX error logs have additional information available and are able to time stamp the errors with local time. See “Service Processor Error Log” on page 54 for an example of the error log.

- **Read System POST Errors**

This option should only be used by service personnel to display additional error log information.

- **View System Environmental Conditions**

With this menu option, the service processor reads all environmental sensors and reports the results to the user. This option can be useful when surveillance fails, because it allows the user to determine the environmental conditions that may be related to the failure.

Privileged User Menus

The following menus are available to privileged users only. The user must know the privileged-access password, if set, to access these menus.

Main Menu

At the top of the Main Menu is a listing containing:

- Your service processor's current firmware version
- The firmware copyright notice
- The system name given to your system during setup (optional)

You need the firmware version for reference when you either update or repair the functions of your service processor.

System Name, an optional field, is the name that your system reports in problem messages. This name helps your support team (for example, your system administrator, network administrator, or service representative) to more quickly identify the location, configuration, and history of your system. The system name is set from the Main Menu using option 6.

Note: The information under the Service Processor Firmware heading in the following Main Menu illustration is example information only.

```
Service Processor Firmware
Firmware Level: ct010717
Copyright 2001, IBM Corporation
SYSTEM NAME

MAIN MENU

1. Service Processor Setup Menu
2. System Power Control Menu
3. System Information Menu
4. Language Selection Menu
5. Call-In/Call-Out Setup Menu
6. Set System Name
99. Exit from Menu

1>
```

Service Processor Setup Menu

The Service Processor Setup menu is accessed from the Main Menu:

```
SERVICE PROCESSOR SETUP MENU

1. Change Privileged-access Password
2. Change General-Access Password
3. Enable/Disable Console Mirroring:
   Currently Disabled

4. Start Talk Mode
5. OS Surveillance Setup Menu
6. Reset Service Processor
7. Reprogram Service Processor Flash EPROM
8. Serial Port Snoop Setup Menu
98. Return to Previous Menu
99. Exit from Menus

1>
```

Note: Unless otherwise stated in the menu responses, settings become effective when a menu is exited using option 98 or 99.

Passwords

Passwords can be any combination of up to eight alphanumeric characters. You can enter longer passwords, but the entries are truncated to include only the first eight characters. Passwords can be set from the Service Processor menu or from the System Management Services menus.

For security purposes, the service processor counts the number of attempts to enter correct passwords. The results of not recognizing a correct password within this error threshold are different, depending on whether the attempts are being made locally (at the system) or remotely (through a modem). The error threshold is three attempts.

If the error threshold is reached by someone entering passwords at the system, the service processor exits the menus. This action is taken based on the assumption that the system is in an adequately secure location with only authorized users having access. Such users must still successfully enter a login password to access AIX.

If the error threshold is reached by someone entering passwords remotely, the service processor disconnects the modem to prevent potential security attacks on the server by unauthorized remote users.

The following table illustrates what you can access with the privileged-access password and the general-access password.

Privileged-Access Password	General-Access Password	Resulting Menu
None	None	MAIN MENU displays
None	Set	MAIN MENU displays
Set	None	Users with password see the MAIN MENU.
Set	Set	Users see menus associated with the entered password

- **Change Privileged-access Password**

Set or change the privileged-access password. It provides the user with the capability to access all service processor functions. This password is usually used by the system administrator or root user.

- **Change General-Access Password**

Set or change the general-access password. It provides limited access to service processor menus and is usually available to all users who are allowed to power on the system.

- **Enable/Disable Console Mirroring**

When console mirroring is enabled, the service processor sends information to both serial ports. This capability, which can be enabled by local or remote users, provides local users with the capability to monitor remote sessions. Console mirroring can be enabled for the current session only. For more information, see “Console Mirroring” on page 53.

- **Start Talk Mode**

In a console-mirroring session, it is useful for those who are monitoring the session to be able to communicate with each other. Selecting this menu item activates the keyboards and displays for such communications while console mirroring is established. This is a full duplex link, so message interference is possible. Alternating messages between users works best.

- **OS Surveillance Setup Menu**

This menu can be used to set up operating system (OS) surveillance.

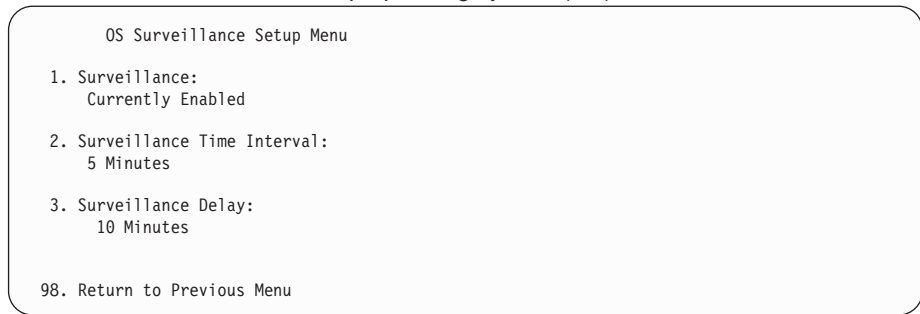

- **Surveillance**

Can be set to enabled or disabled.

- **Surveillance Time Interval**

Can be set to any number from 1 to 255 minutes. The default value is 5 minutes.

- **Surveillance Delay**

Can be set to any number from 0 to 255 minutes. The default value of 10 minutes is the recommended minimum.

Surveillance Time Interval and Surveillance Delay can only be changed after surveillance is enabled. Refer to “Service Processor System Monitoring - Surveillance” on page 51 for more information about surveillance.

- **Reset Service Processor**

Allows the user to reinitialize the service processor.

- **Reprogram Service Processor Flash EPROM**

Attention: Only the service processor firmware can be updated from the service processor menus; the system firmware cannot be updated from the service processor menus. A service processor firmware update always requires a companion system firmware update, which must be applied first. For this reason, updating only the service processor firmware using the service processor menus is not recommended. See the Web site at <http://www.rs6000.ibm.com/support/micro> to download the latest firmware levels and update instructions.

The service processor firmware update image must be written onto a DOS-formatted diskette. The update image can be obtained from the Web site at <http://www.rs6000.ibm.com/support/micro>.

After the update diskette has been made, from the service processor main menu, select **Service Processor Setup**. Then select **Reprogram Service Processor Flash EPROM**. The program requests the update diskette(s) as they are needed. The service processor will automatically reboot after the firmware update is complete.

Serial Port Snoop Setup Menu

This menu can be used to set up serial port snooping, in which the user can configure serial port 1 as a "catch-all" reset device.

From the main service processor menu, select option 1, Service Processor Setup Menu, then select option 8 (Serial Port Snoop Setup Menu).

```
SERIAL PORT SNOOP SETUP MENU

1. System reset string:
   Currently Unassigned

2. Snoop Serial Port:
   Currently Unassigned

98. Return to Previous Menu

1>
```

Use the System reset string option to enter the system reset string, which resets the machine when it is detected on the main console on serial port 1.

Use the Snoop Serial Port option to select the serial port to snoop.

Note: Only serial port 1 is supported.

After serial port snooping is correctly configured, at any point after the system is booted to AIX, whenever the reset string is typed on the main console, the system uses the service processor reboot policy to restart. This action causes an early power off warning (EPOW) to be logged, and also an AIX dump to be created if the machine is at an AIX prompt, with AIX in such a state that it can respond. If AIX cannot respond, the EPOW record is created, rather than the AIX dump.

Pressing Enter after the reset string is not required, so make sure that the string is not common or trivial. A mixed-case string is recommended.

System Power Control Menu

The menu is used to set power control options.

```
SYSTEM POWER CONTROL MENU

1. Enable/Disable Unattended Start Mode:
   Currently Disabled
2. Ring Indicate Power-On Menu
3. Reboot/Restart Policy Setup Menu
4. Power-On System
5. Power-Off System
6. Enable/Disable Fast System Boot:
   Currently Disabled
7. Boot Mode Menu
98. Return to Previous Menu
99. Exit from Menus

1>
```

- **Enable/Disable Unattended Start Mode**

Use this option to instruct the service processor to immediately power-on the server after a power failure, bypassing power-on password verification. Unattended start mode can be used on systems that require automatic power-on after a power failure. Unattended start mode can also be set using SMS menus.

- **Ring Indicate Power-On Menu**

Ring indicate power-on is an alternate method of dialing in without establishing a service processor session. If the system is powered off and ring indicate power-on is enabled, the system is powered on at the predetermined number of rings. If the system is already on, no action is taken. In either case, the telephone call is not answered. The caller receives no feedback that the system is powered on. The **Ring Indicate Power-On Menu** and defaults are as follows:

```
Ring Indicate Power-On Menu

1. Ring indicate power-on:
   Currently Disabled

2. Number of rings:
   Currently 6

98. Return to Previous Menu
```

The number of rings can be set to any number greater than zero. The default value is six rings.

- **Reboot/Restart Policy Setup Menu**

Reboot describes bringing the system hardware back up from scratch, for example, from a system reset or power-on. The reboot process ends when control passes to the operating system loading (or initialization) process.

Restart describes activating the operating system after the system hardware reinitialized. Restart must follow a successful reboot.

```
Reboot/Restart Policy Setup Menu

1. Number of reboot attempts:
   Currently 3

2. Use OS-Defined restart policy?
   Currently Yes

3. Enable supplemental restart policy?
   Currently No

4. Call-Out before restart:
   Currently Disabled

98. Return to Previous Menu

1>
```

- **Number of reboot attempts** If the system fails to successfully complete the boot process, it attempts to reboot the number of times specified. Values equal to or greater than 0 are valid. Only successive failed reboot attempts count, not reboots that occur after a restart attempt. At restart, the counter is set to 0.
- **Use OS-Defined restart policy** lets the service processor react in the same way as the operating system to major system faults by reading the setting of the operating system parameter **Automatically Restart/Reboot After a System Crash**. This parameter may or may not be defined, depending on the operating system or its version and level. If the operating system automatic restart setting is defined, then it can be set to respond to a major fault by restarting or by not restarting. See your operating system documentation for details on setting up operating system automatic restarts. The default value is yes.
- **Enable supplemental restart policy** - The default setting is no. If set to yes, the service processor restarts the system when the system loses control as detected by the service processor surveillance, and either:
 - The **Use OS-Defined restart policy** is set to no
 - OR
 - The **Use OS-Defined restart policy** is set to yes, and the operating system has NO automatic restart policy.Refer to “Service Processor Reboot/Restart Recovery” on page 49.
- **Call-out before restart** If a restart is necessary due to a system fault, you can enable the service processor to call out and report the event. This option can be valuable if the number of these events becomes excessive, signalling a bigger problem.

The following table describes the relationship among the operating system and service processor restart controls:

OS Automatic Reboot/Restart AfterCrash Setting	Service Processor to Use OS-Defined Restart Policy?	Service Processor Enable Supplemental Restart Policy?	System Response
None	No	No ¹	
None	No	Yes	Restarts
None	Yes ¹	No ¹	
None	Yes ¹	Yes	Restarts
False ²	No	No ¹	
False ²	No	Yes	Restarts
False ²	Yes ¹	No ¹	
False ²	Yes ¹	Yes	
True	No	No ¹	
True	No	Yes	Restarts
True	Yes ¹	No ¹	Restarts
True	Yes ¹	Yes	Restarts

¹ Service processor default

² AIX default

- **Power-On System**

Allows immediate power-on of the system. For other power-on methods, see “System Power-On Methods” on page 48.

- **Power-Off System**

Allows the user to power-off the server following a surveillance failure.

- **Enable/Disable Fast System Boot**

Allows the user to select a fast system boot.

Attention: Enabling fast system boot results in several diagnostic tests being skipped and a shorter memory test being run.

- **Boot Mode Menu**

Allows users to set the system to automatically start a specific function on the next system start. This setting applies to the next boot only and is reset to the default state of being disabled following a successful boot attempt.

```
BOOT MODE MENU

1. Boot to SMS Menu:
   Currently Disabled

2. Service Mode Boot from Saved List:
   Currently Disabled

3. Service Mode Boot from Default List:
   Currently Disabled

4. Boot to Open Firmware Prompt:
   Currently Disabled

98. Return to Previous Menu

1>
```

- **Enabling the Boot to SMS Menu option**

Causes the system to automatically stop at the System Management Services menu during the boot process. Enabling this option is equivalent to pressing 1 on the attached ASCII terminal (or F1 on a graphics terminal) while the system initialization indicators display on screen.

- **Enabling the Service Mode Boot from Saved list option**

This selection causes the system to perform a service mode boot using the service mode boot list saved in NVRAM. If the system boots AIX from the disk drive and AIX diagnostics are loaded on the disk drive, AIX boots in service mode to the diagnostics menu.

Using this option to boot the system is the preferred way to run online diagnostics.

- **Enabling the Service Mode Boot from Default List option**

This selection is similar to “Service Mode Boot from Saved List”, except the system boots using the default boot list that is stored in the system firmware. This is normally used to try to boot customer diagnostics from the CD-ROM drive.

Using this option to boot the system is the preferred way to run standalone diagnostics.

- **Enabling the Boot to Open Firmware Prompt option**

Causes the system to automatically enter open firmware prompt (also called the OK prompt). This option should only be used by service personnel to obtain additional debug information.

If more than one option is enabled, the system recognizes only the option corresponding to the smallest menu number. For example, if options 4 and 2 were enabled, the system recognizes only Option 2: **Service Mode Boot from Saved List**. After a boot attempt, all enabled options are disabled. In effect, the system discards any menu options that are enabled after the option with the highest priority (the option with the smallest menu number) is executed.

The user can also override the choices in the Boot Mode Menu while the system initialization indicators display on the screen. For example, if the user had enabled the system to enter the SMS menus (option 1) but pressed the 8 key while the system initialization indicators displayed on the screen, the system enters the open firmware prompt and disregards the settings in the Boot Mode Menu.

System Information Menu

Use this menu to view the processor configuration information, error logs, system resources, and processor configuration.

```
SYSTEM INFORMATION MENU

1. Read VPD Image From Last System Boot
2. Read Progress Indicators From Last System Boot
3. Read Service Processor Error Logs
4. Read System POST Errors
5. Read NVRAM
6. Read Service Processor Configuration
7. View System Environmental Conditions
8. Processor Configuration/Deconfiguration Menu
9. Memory Configuration/Deconfiguration Menu
10. Enable/Disable CPU Repeat Gard
    Currently Enabled

11. Enable/Disable MEM Repeat Gard
    Currently Enabled
12. Query/Modify Attention Indicator

98. Return to Previous Menu
99. Exit from Menus

1>
```

- **Read VPD Image From Last System Boot**

Displays manufacturer's vital product data (VPD), such as serial numbers, part numbers, and so on, that were stored from the system boot prior to the one in progress now.

- **Read Progress Indicators from Last System Boot**

Displays the boot progress indicators (checkpoints), up to a maximum of 100, from the system boot prior to the one in progress. This historical information can help to diagnose system faults.

The progress indicators are displayed in two sections. Above the dashed line are the progress indicators (latest) from the boot that produced the current sessions. Below the dashed line are progress indicators (oldest) from the boot preceding the one that produced the current sessions.

The progress indicator codes are listed from top (latest) to bottom (oldest). If the <--- arrow occurs, use the 4-digit checkpoint or 8-character error code being pointed to as the beginning of your service actions.

- **Read Service Processor Error Logs**

Displays error conditions detected by the service processor.

The time stamp in this error log is coordinated universal time (UTC), also known as Greenwich mean time (GMT). AIX error logs have additional information available and are able to time stamp the errors with the local time. See “Service Processor Error Log” on page 54 for an example of the error log.

- **Read System POST Errors**

This option should only be used by service personnel to display additional error log information.

- **Read NVRAM**

Displays 320 bytes of nonvolatile random access memory (NVRAM) contents.

- **Read Service Processor Configuration**

Displays all service processor settings that can be changed by the user.

- **View System Environmental Conditions**

The service processor reads all environmental sensors and reports the results to the user. Use this option when surveillance fails, because it allows the user to determine the environmental conditions that may be related to the failure.

- **Processor Configuration/Deconfiguration Menu**

Use this option to view the processor configuration.

The following is an example of the Processor Configuration/Deconfiguration Menu:

```
Processor Configuration/Deconfiguration Menu

Processor number
0. Configured by system (0x0)
2. Configured by system (0x0)

98. Return to Previous Menu

To change the configuration, select the processor number
1>
```

The processor can be in one of the following states:

- **Configured by system:** The system processor is present, and has not exceeded the failure threshold.
- **Deconfigured by system:** The system processor has been taken offline by the service processor due to an unrecoverable error, or recoverable errors exceeding the failure threshold.

Note: A status of (0x0) indicates that the processor card has not had any errors logged against it by the service processor.

Attention: If the system processor in slot 1 (P1-C1) has been deconfigured by the system, the service processor will prevent the system from booting.

- **Memory Configuration/Deconfiguration Menu:**

Use this menu to view and modify the dual inline memory module (DIMM) configuration. If it is necessary to take one of the memory DIMMs offline, this menu allows you to deconfigure a DIMM and then reconfigure the DIMM at a later time.

The configuration process takes place during system power-on. Therefore, the configuration displayed by this menu in standby mode reflects the configuration during the last boot.

The following is an example of the Memory Configuration/Deconfiguration Menu.

```
Memory Configuration/Deconfiguration Menu

DIMMs on memory card number 0:

1. Configured by system (0x0)      2. Configured by system (0x0)
3. Configured by system (0x0)      4. Configured by system (0x0)

98. Return to Previous Menu

Enter card number and DIMM number separated by a space
1>
```

In this system, the memory card number is 0 by default.

When the user selects a DIMM, its state toggles between configured and deconfigured. Memory DIMMs that are not present are not shown.

Each memory DIMM can be in one of following states:

- **Configured by system:** The memory DIMM is present, and has not exceeded the failure threshold. It has been configured by the system and is available.
- **Deconfigured by system:** The memory DIMM is present, but has exceeded the failure threshold. It has been deconfigured by the system and is currently unavailable.
- **Manually configured:** The memory DIMM is present and available. It has been configured by the user through this menu.
- **Manually deconfigured:** The memory DIMM is present, but unavailable. It has been deconfigured by the user through this menu.

Note: A status of (0x0) indicates that the memory DIMM has not had any errors logged against it by the service processor.

- **Enable/Disable CPU Repeat Gard Menu**

Use this option to enable or disable CPU repeat gard.

- **Enable/Disable Memory Repeat Gard Menu**

Use this option to enable or disable memory repeat gard.

- **Query/Modify Attention Indicator:** (amber colored LED located on the operator panel)

This option allows the user to query and modify the system fault/system identify LED. This LED displays the state of the attention indicator sensors.

If this option is chosen, the following screen is displayed:

```
Do you wish to:
1. Make the rack/system indicator blink/reset the state
2. Clear all lightpath LEDs
98. Return to Previous Menu

1>>
```

If option 1 is chosen, the rack indicator/system attention LED can be set or reset (turned on or off).

If option 2 is chosen, the LEDs on the lightpath LED panel can be cleared (turned off).

Note: The system fault/system identify LED can also be set and reset using tasks in the AIX Service Aids.

Language Selection Menu

The service processor menus and messages are available in different languages. This menu allows selecting languages in which service processor and system firmware menus and messages display.

```
LANGUAGE SELECTION MENU

1. English
2. Francais
3. Deutsch
4. Italiano
5. Espanol
6. Svenska
98. Return to Previous Menu
99. Exit from Menus

1>
```

Note: Your ASCII terminal must support the ISO-8859 character set to correctly display languages other than English.

Call-In/Call-Out Setup Menu

This menu is used to configure a modem for the service processor to use to support the system.

```
CALL-IN/CALL-OUT SETUP MENU

1. Modem Configuration Menu
2. Serial Port Selection Menu
3. Serial Port Speed Setup Menu
4. Telephone Number Setup Menu
5. Call-Out Policy Setup Menu
6. Customer Account Setup Menu
7. Call-Out Test
8. Ring Indicate Power-On Menu
98. Return to Previous Menu
99. Exit from Menus

1>
```

- **Modem Configuration Menu**, see “Modem Configuration Menu” on page 43.
- **Serial Port Selection Menu**, see “Serial Port Selection Menu” on page 43.
- **Serial Port Speed Setup Menu**, see “Serial Port Selection Menu” on page 43.
- **Telephone Number Setup Menu**, see “Telephone Number Setup Menu” on page 44.
- **Call-Out Policy Setup Menu**, see “Call-Out Policy Setup Menu” on page 46.
- **Customer Account Setup Menu**, see “Customer Account Setup Menu” on page 47.
- **Call-out Test**, see “Call-Out Policy Setup Menu” on page 46.
- **Ring Indicate Power-On Menu**, see page 34.

Modem Configuration Menu

Entries at the top of the Modem Configuration Menu display the status of the current selections. Selections are made in the sections, labeled Modem Ports and Modem Configuration File Name. Select the serial port that you want to activate and then select the modem configuration file for the modem on the port. To set up both serial ports with modems, make your selections one port at a time.

For information on choosing a modem configuration file, see “Sample Modem Configuration Files” on page 175 and “Transfer of a Modem Session” on page 180.

```
Modem Configuration Menu

Port 1 Modem Configuration File Name:
Port 2 Modem Configuration File Name:

To make changes, First select the port and then the configuration file
name

Modem Ports:
 1. Serial port 1
 2. Serial port 2

Modem Configuration File Name:
 3. none                9. modem_m0_sp
 4. modem_f_sp          10. modem_m1_sp
 5. modem_f0_sp
 6. modem_f1_sp
 7. modem_z_sp
 8. modem_z0_sp

30. Save configuration to NVRAM and Configure modem
98. Return to Previous Menu
```

Serial Port Selection Menu

This menu allows you to enable and/or disable the call-in functions of each serial port in any combination.

```
Serial Port Selection Menu

1. Serial Port 1 Call-Out:
   Currently Disabled

2. Serial Port 2 Call-Out:
   Currently Disabled

3. Serial Port 1 Call-In:
   Currently Disabled

4. Serial Port 2 Call-In:
   Currently Disabled

98. Return to Previous Menu
```

Serial Port Speed Setup Menu

This menu allows you to set serial port speed to enhance terminal performance or to accommodate modem capabilities.

```
Serial Port Speed Setup Menu

1. Serial port 1 speed:
   Currently 9600

2. Serial port 2 speed:
   Currently 9600

98. Return to Previous Menu
```

A speed of 9600 baud or higher is recommended. Valid serial port speeds are as follows:

50	600	4800
75	1200	7200
110	2000	9600
134	2400	19200
150	2400	57600
300	3600	115200

Telephone Number Setup Menu

Use this menu to set or change the telephone numbers for reporting a system failure.

```
Telephone Number Setup Menu

1. Service Center Telephone Number:
   Currently Unassigned

2. Customer Administration Center Telephone Number:
   Currently Unassigned

3. Digital Pager Telephone Number:
   Currently Unassigned

4. Customer Voice Telephone Number:
   Currently Unassigned

5. Customer System Telephone Number:
   Currently Unassigned

98. Return to Previous Menu

1>
```

- **Service Center Telephone Number** is the number of the service center computer. The service center usually includes a computer that takes calls from systems with call-out capability. This computer is referred to as the *catcher*. The catcher expects messages in a specific format to which the service processor conforms. Contact your service provider for the correct service center telephone number to enter here. For

more information about the format and catcher computers, refer to the README file in the AIX `/usr/samples/syscatch` directory.

- **Customer Administration Center Telephone Number** is the number of the system administration center computer (catcher) that receives problem calls from systems. Contact your system administrator for the correct telephone number to enter here.
- **Digital Pager Telephone Number** is the number for a pager carried by someone who responds to problem calls from your system. Contact your administration center representative for the correct telephone number to enter here. For test purposes, use a test number, which you can change later.

Notes:

1. At least one of the preceding three telephone numbers must be assigned in order for the call-out test to execute successfully.
2. Some modems, such as IBM 7857-017, are not designed for the paging function. Although they can be used for paging, they return an error message when they do not get the expected response from another modem. Therefore, even though the paging was successful, the error message causes the service processor to retry, continuing to place pager calls for the number of retries specified in the Call-Out policy Setup Menu. These retries result in redundant pages.

For digital pagers that require a personal identification number (PIN) for access, include the PIN in this field as shown in the following example:

```
18001234567, ,, ,87654
```

The commas create pauses for the voice response system, and the 87654 represents the PIN. The length of these pauses is set in modem register S8. The default is usually 1 or 2 seconds each.

- **Customer Voice Telephone Number** is the telephone number of a phone near the server or answered by someone responsible for the system. This is the telephone number left on the pager for callback. For test purposes, use a test number, which you can change later.
- **Customer System Telephone Number** is the telephone number to which your system's modem is connected. The service or administration center representatives need this number to make direct contact with your system for problem investigation. This is also referred to as the *call-in* phone number.

Call-Out Policy Setup Menu

This menu allows you to set call-out policy.

```
Call-Out Policy Setup Menu

1. Call-Out policy (First/All):
   Currently First

2. Remote timeout, (in seconds):
   Currently 120

3. Remote latency, (in seconds):
   Currently 2

4. Number of retries:
   Currently 2

98. Return to Previous Menu

1>
```

- **Call-Out Policy**

Can be set to 'First' or 'All'. If call-out policy is set to 'first', the service processor stops at the **first successful** call out to one of the following numbers:

- Service center
- Customer administration center
- Pager

If call-out policy is set to 'all', the service processor attempts a call out to the following numbers in the order listed:

1. Service center
2. Customer administration center
3. Pager

- **Remote timeout** and **Remote latency** are functions of your service provider's catcher computer. Either use the defaults or contact your service provider for recommended settings. The default values are as follows:

Remote timeout 120 seconds

Remote latency 2 seconds

- **Number of retries** is the number of times you want the server to retry calls that resulted in busy signals or in other error messages.

Customer Account Setup Menu

This menu allows users to enter information that is specific to their account.

```
Customer Account Setup Menu

1. Customer account number:
   Currently Unassigned

2. Customer RETAIN login userid:
   Currently Unassigned

3. Customer RETAIN login password:
   Currently Unassigned

98. Return to Previous Menu

1>
```

- **Customer account number** is assigned by your service provider for record-keeping and billing. If you have an account number, enter it. Otherwise, leave this field blank.
- **Customer RETAIN login userid** and **Customer RETAIN login password** apply to a service function to which your service provider may or may not have access. Leave these fields blank if your service provider does not use RETAIN.

Call-Out Test

The call-out test verifies if the call-out function is working properly. Before the test, call-out must be enabled and the system configured properly for call-out.

During the setup, the user should have entered the phone numbers for the digital pager and customer voice for test purposes. These numbers are used to determine whether call-out is working during the call-out test.

The call-out test should cause the user's phone to ring. If the test is successful, call-out is working properly. The user should now change the test digital pager and customers voice number to the correct numbers.

System Power-On Methods

This section discusses the following system power-on methods:

- Power-on switch
- Remote power-on by ring-indicate signal

The server automatically powers on when it detects a "ring indicate" signal from a modem attached to one of the integrated serial ports.

A remote user can call the server to activate ring detection by the modem. Listen for a few more rings than the threshold number for starting the system and then hang up. The default threshold is six rings.

Wait 5 minutes for the server to initialize and then call again using an ASCII terminal. The server responds by requesting a password, if set, or presenting the service processor menus. The remote user now has control of the server.

Note: For security, if the system is powered on by the remote power-on by ring indicate signal and the service processor detects a battery failure, the service processor causes the system to power off. See "Service Processor Call-In Security" on page 49 for more information.

- Unattended start mode - refer to **Enable/Disable Unattended Start Mode** on page 34.

The service processor can be enabled to recover from the loss of ac power (see Enable/Disable Unattended Power-On Mode in the "System Power Control Menu" on page 34). When ac power is restored, the system returns to the power state at the time ac loss occurred. For example, if the system was powered-on when ac loss occurred, it reboots/restarts when power is restored. If the system was powered-off when ac loss occurred, it remains off when power is restored.

- Timed power-on - refer to the **shutdown -t** command on servers using AIX.

Working in conjunction with AIX, the service processor in your server can operate a timer, much like the wake-up timer on your clock radio. You can set the timer so that your server powers on at a certain time after shutting down. The timer is battery operated, so power interruptions occurring while the server is off do not affect its accuracy. Refer to the AIX **shutdown -t** command for details on setting the timer.

Note: If an ac power loss is in progress when the timed power-on attempt occurs, the server cannot power on when ac power is restored.

- Follow-up to a failed boot attempt

The service processor initiates a power-on sequence if a failed boot attempt is detected (due to a hardware or software failure).

- Fast/Slow Boot (IPL) Capabilities

Using the service processor menus, you can select the IPL type, mode, and speed of your system. For more information, refer to "System Power Control Menu" on page 34.

Attention: Selecting fast IPL results in several diagnostic tests being skipped, and a shorter memory test being run.

Service Processor Call-In Security

If the service processor detects bad battery-powered storage (indicating that the battery on the system board has failed or has been removed), it maintains server security by disabling the call-in capability to both serial ports.

When call-in is disabled, the system can still be powered on by using the ring-indicator signal, but the service processor then causes the system to power down, preventing access to any system facilities or to AIX.

After battery power is restored, the password(s) must be reset and the call-in function(s) enabled. Both of these operations can be performed from service processor menus. See “Serial Port Selection Menu” on page 43.

Service Processor Reboot/Restart Recovery

Reboot describes bringing the system hardware back up; for example, from a system reset or power-on. The reboot process ends when control passes to the operating system loading (or initialization) process.

Restart describes activating the operating system after the system hardware is reinitialized. Restart must follow a successful reboot.

Boot (IPL) Speed

When the server enters reboot recovery, slow IPL is automatically started, which gives the POST an opportunity to locate and report any problems.

Failure During Boot Process

During the boot process, either initially after system power-on or upon reboot after a system failure, the service processor monitors the boot progress. If progress stops, the service processor can reinitiate the boot process (reboot) if enabled to do so. The service processor can re-attempt this process according to the number of retries entered in the Reboot/Restart Policy Setup Menu.

Failure During Normal System Operation

When the boot process completes and control transfers to the operating system (OS), the service processor can monitor operating system activity (see the Set Surveillance Parameters option in the “Service Processor Setup Menu” on page 30). If OS activity stops due to a hardware- or software-induced failure, the service processor can initiate a reboot/restart process based on the settings in the Service Processor Reboot/Restart Policy Setup Menu and the OS automatic restart settings (see the operating system documentation).

If you are using the AIX operating system, the menu item under SMIT for setting the restart policy is Automatically Reboot After Crash (True/False). The default is False. When the setting is True, and if the service processor parameter “Use OS-Defined Restart Policy” is Yes (the default), the service processor takes over for AIX to reboot/restart after a hardware or surveillance failure.

Service Processor Reboot/Restart Policy Controls

The operating system's automatic restart policy (see operating system documentation) defines the operating system's response to a system crash. The service processor can be instructed to refer to that policy by the Use OS-Defined Restart Policy setup menu.

Processor Boot-Time Deconfiguration (CPU Repeat Gard)

Processor boot time deconfiguration allows for the removal of processors from the system configuration at boot time. The objective is to minimize system failure or data integrity exposure due to a faulty processor.

This function uses processor hardware built-in self-test (BIST) and firmware power-on self-test (POST) to discover and isolate processor hardware failures during boot time. It also uses the hardware error detection logic in the processor to capture run-time recoverable and irrecoverable error indications. The firmware uses the error signatures in the hardware to analyze and isolate the error to a specific processor.

The processors that are deconfigured remain offline for subsequent reboots until the faulty processor hardware is replaced.

This function allows users to manually deconfigure or re-enable a previously deconfigured processor through the service processor menu. The user can also enable or disable this function through the service processor.

Memory Boot-Time Deconfiguration (Memory Repeat Gard)

Memory boot-time deconfiguration allows for the removal of a memory segment or DIMM from the system configuration at boot time. The objective is to minimize system failures or data integrity exposure due to faulty memory hardware. The hardware resource(s) to be removed are the ones that experienced the following failures:

- A boot-time test failure
- Run-time recoverable errors over the error threshold prior to the current boot phase
- Run-time irrecoverable errors prior to the current boot phase

This function uses firmware power-on self-test (POST) to discover and isolate memory hardware failures during boot time. It also uses the hardware error detection logic in the memory controller to capture run-time recoverable and irrecoverable errors. The firmware uses the error signatures in the hardware to analyze and isolate the error to the specific memory segment or DIMM.

The memory segment or DIMM that is deconfigured remains offline during subsequent reboots until the faulty memory hardware is replaced.

The function allows users to manually deconfigure or re-enable a previously deconfigured memory segment/DIMM through the service processor menu. The user can also enable or disable this function through the service processor menu.

Service Processor System Monitoring - Surveillance

Surveillance is a function in which the service processor monitors the system, and the system monitors the service processor. This monitoring is accomplished by periodic samplings called *heartbeats*.

Surveillance is available during two phases:

- System firmware startup (automatic)
- Operating system run time (optional)

System Firmware Surveillance

System firmware surveillance provides the service processor with a means to detect boot failures while the system firmware is running.

System firmware surveillance is automatically enabled during system power-on. It cannot be disabled by the user, and the surveillance interval and surveillance delay cannot be changed by the user.

If the service processor detects no heartbeats during system boot (for a set period of time), it cycles the system power to attempt a reboot. The maximum number of retries is set from the service processor menus. If the failure condition repeats, the service processor leaves the machine powered on, logs an error, and displays menus to the user. If call-out is enabled, the service processor calls to report the failure and displays the operating-system surveillance failure code on the operator panel.

Operating System Surveillance

The operating system surveillance provides the service processor with a means to detect hang conditions, as well as hardware or software failures, while the operating system is running. It also provides the operating system with a means to detect service processor failure caused by the lack of a return heartbeat.

Operating system surveillance is enabled by default, allowing the user to run operating systems that do not support this service processor option.

You can also use service processor menus and AIX service aid to enable or disable operating system surveillance.

For operating system surveillance to work correctly, you must set the following parameters:

- Surveillance enable/disable
- Surveillance interval

The maximum time (in minutes) the service processor will wait between heartbeats from the operating system before reporting a surveillance failure.

- Surveillance delay

The maximum time (in minutes) for the service processor will wait for the first heartbeat from the operating system after the operating system has been started, before reporting a surveillance failure.

Surveillance takes effect immediately after the parameters are set from the service processor menus.

If operating system surveillance is enabled (and system firmware has passed control to the operating system), and the service processor does not detect any heartbeats from the operating system within the surveillance delay period, the service processor assumes the system is hung. The machine is left powered on and the service processor enters standby phase, displaying the operating system surveillance failure code on the operator panel. If call-out is enabled, the service processor calls to report the failure.

Call Out

The service processor can call out when it detects one of the following conditions:

- System firmware surveillance failure
- Operating system surveillance failure (if supported by the operating system)
- Critical environmental failures
- Restarts

To enable the call-out feature, do the following:

1. Have a modem connected to serial port 1 or 2.
2. Set up the following using the service processor menus or diagnostic service aids:
 - Enable call out for the serial port where the modem is connected.
 - Set the serial port line speed.
 - Enter the modem configuration filename.
 - Set up site-specific parameters (such as phone numbers for call-in and call-out policy).
 - To call out before restart, set **Call-Out before restart** to Enabled from the Reboot/Restart Policy Setup menu.

Note: Some modems, such as IBM 7857-017, are not designed for the paging function. Although they can be used for paging, they return an error message when they do not get the expected response from another modem. Therefore, even though the paging was successful, the error message causes the service processor to retry, continuing to place pager calls for the number of retries specified in the Call-Out policy Setup Menu. These retries result in redundant pages.

Console Mirroring

Console mirroring allows a user on a local ASCII terminal to monitor the service processor activities of a remote user. Console mirroring ends when the service processor releases control of the serial ports to the system firmware.

System Configuration for Console Mirroring

The following describes the system configuration for console mirroring:

- Modem connected to one serial port and enabled for incoming calls
- Local ASCII terminal connected to the other serial port. This local terminal can be connected directly to your server or connected through another modem.

Remote console mirroring can be invoked in two ways:

- Remote session first, then local session added:
 1. Remote session already in progress.
 2. Remote user uses the service processor menus to enable console mirroring, allowing both consoles to be active.
- Local session first, then remote session added:
 1. Local session is already in progress.
 2. The service processor receives a call from the remote user.
 3. The local user selects the option to enable console mirroring. The service processor immediately begins mirroring service processor menus.

Note: To disconnect quickly, press Ctrl+D on either console, and both sessions will exit the service processor menus.

Service Processor Firmware Updates

Attention: Only the service processor firmware can be updated from the service processor menus; the system firmware cannot be updated from the service processor menus. A service processor firmware update always requires a companion system firmware update, which must be applied first. For this reason, updating only the service processor firmware using the service processor menus is not recommended. See the Web site at <http://www.rs6000.ibm.com/support/micro> to download the latest firmware levels and update instructions.

The service processor firmware update image must be written onto a DOS-formatted diskette. The update image can be obtained from the following Web site:
<http://www.rs6000.ibm.com/support/micro>.

After the update diskette has been made, from the service processor main menu, select **Service Processor Setup**. Then select **Reprogram Service Processor Flash EPROM**. The program requests the update diskette(s) as they are needed. The service processor will automatically reboot after the firmware update is complete.

Service Processor Error Log

The service processor error log contains information about errors reported by the service processor.

```
                                Error Log
19991118165344 1. 4B276851 CPU BIST fail detected
FRUs to replace: P1-C1

Press "C" to clear error log, any other key to continue. >
```

The time stamp in this error log is coordinated universal time (UTC), also known as Greenwich mean time (GMT). AIX error logs have more information available and are able to time stamp with local time.

Service Processor Operational Phases

This section provides a high-level flow of the phases of the service processor.

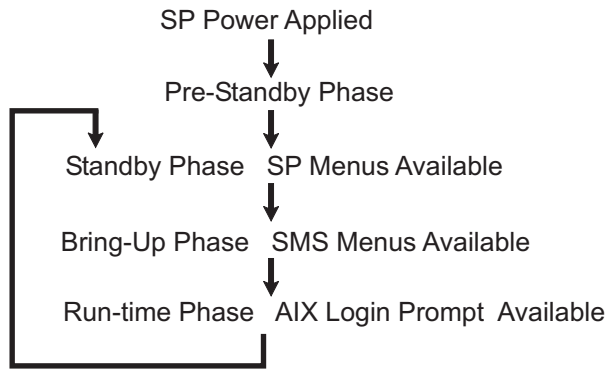

Pre-Standby Phase

This phase is entered when the server is connected to a power source. The server may or may not be fully powered on. This phase is exited when the power-on self-tests (POST) and configuration tasks are completed.

The pre-standby phase components are:

- Service processor initialization - Performs any necessary hardware and software initializations.
- Service processor POST - Conducts power-on self-tests on its various work and code areas.
- Service processor unattended start mode checks - To assist fault recovery. If unattended start mode is set, the service processor automatically reboots the server. The service processor does not wait for user input or power-on command, but moves through the phase and into the bring-up phase. Access SMS menus or service processor menus to reset the unattended start mode.

Standby Phase

The standby phase can be reached in either of two ways:

- With the server off and power connected (the normal path), recognized by OK in the LCD display

OR

- With the server on after an operating system fault, recognized by STBY or an 8-digit code in the LCD display.

In the standby phase, the service processor handles some automatic duties and is available for menu operation. The service processor remains in the standby phase until a power-on request is detected.

The standby phase components are as follows:

- Modem configuration

The service processor configures the modem (if installed) so that incoming calls can be received or outgoing calls can be placed.

- Dial In

Monitor incoming phone line to answer calls, prompt for a password, verify the password, and remotely display the standby menu. The remote session can be mirrored on the local ASCII console if the server is so equipped and the user enables this function.

- Menus

The service processor menus are password-protected. Before you can access them, you need either the general-access password (GAP) or privileged-access password (PAP).

Bring-Up Phase

This phase is entered upon power-on, and exited upon loading of the operating system.

The bring-up phase components are:

- Retry Request Check

The service processor checks to see if the previous boot attempt failed. If two consecutive failures are detected, the service processor displays an error code and places an outgoing call to notify an external party if the user has enabled this option.

- Dial Out

The service processor can dial a preprogrammed telephone number in the event of an IPL failure. The service processor issues an error report with the last reported IPL status indicated and any other available error information.

- Update Operator Panel

The service processor displays operator panel data on the ASCII terminal if a terminal is connected either locally or remotely.

- Environmental Monitoring

The service processor provides expanded error recording and reporting.

- System Firmware Surveillance (Heartbeat Monitoring)

The service processor monitors and times the interval between system firmware heartbeats.

- Responding to system processor commands

The service processor responds to any command issued by the system processor.

Run-time Phase

This phase includes the tasks that the service processor performs during steady-state execution of the operating system.

- Environmental Monitoring

The service processor monitors voltages, temperatures, and fan speeds (on some servers).

- Responding to System Processor Commands

The service processor responds to any command issued by the system processor.

- Run-Time Surveillance (Heartbeat Monitoring)

If the device driver is installed and surveillance enabled, the service processor monitors the system heartbeat. If the heartbeat times out, the service processor places an outgoing call. This is different from the bring-up phase scenario where two reboot attempts are made before placing an outgoing call.

Service Processor Procedures in Service Mode

When the system is in service mode, the following service processor parameters are suspended:

- Unattended start mode
- Reboot/restart policy
- Call-Out
- Surveillance

When service mode is exited, the service processor parameters revert to the customer settings.

Chapter 4. Using System Management Services

Use the System Management Services menus to view information about your computer and to perform such tasks as setting passwords and changing device configurations.

If you have chosen a graphical display as your system console, you can use the graphical System Management Services described below. If you are using an ASCII display as your system console, see “Text-Based System Management Services” on page 80.

Graphical System Management Services

To start the graphical System Management Services, turn on or restart the computer.

The firmware version installed in your system unit is displayed at the bottom right corner of the initial logo screen. Note the version number; processor upgrades may require a specific version of firmware to be installed in your system unit. (**Update System Firmware** is an option under the Utilities menu in the System Management Services.)

After the logo is displayed, initialization icons display across the bottom of the screen.

To enter the graphical System Management Services, you must press the F1 key *after the keyboard icon displays* during startup and before the tone.

If you have pressed the F1 key, the System Management Services menu displays after the initialization and power-on self-test (POST) are complete.

Note: If you have installed a privileged-access password, you are prompted for this password before you gain access to the System Management Services menu.

After the System Management Services starts, the following screen displays.



You can also press F8 here to enter the open firmware **OK>** prompt. This should only be done by service personnel to obtain additional debug information.

The System Management Services screen contains the following choices.



Config: Enables you to view your system configuration. Go to “Config” on page 62.



Multiboot: Enables you to set and view the default operating system, modify the boot sequence, access the open firmware command prompt, and work with other options. Go to “Multiboot” on page 63.



Utilities: Enables you to set and remove passwords, enable the unattended start mode, set and view the addresses of your system’s SCSI controllers, select the active console, view or clear the firmware error log, and update your system unit’s firmware. Go to “Utilities” on page 65.



Exit: Returns you to the previous screen.

To select an icon, move the cursor with the arrow keys to choose which icon is highlighted, then press the Enter key. You can also select an icon by clicking on it with your left mouse button. To leave the current screen, either press the Esc key or select the **Exit** icon.

Config



By selecting this icon, you can view information about the setup of your system unit. A list similar to the following appears when you select the **Config** icon.

Device Name
PowerPC, POWER3 375 MHz
L2-Cache, 4096K

PowerPC, POWER3 375 MHz
L2-Cache, 4096K



Memory
Memory Card slot 1, Module Slot =1 size=512MB
Memory Card slot 1, Module Slot =2 size=512MB
Memory Card slot 1, Module Slot =3 size=512MB
Memory Card slot 1, Module Slot =4 size=512MB

Service Processor
Tablet Port
LPT addr=3F8
Com addr=3F8
Com addr=2F8

Keyboard
Mouse

Integrated Ethernet
addr=9999FF111R

SCSI controller id= 7



Exit

If more than one screen of information is available, a blue arrow displays in the top right corner of the screen. Use the page up and page down keys to scroll through the pages.

Multiboot



The options available from this screen allow you to view and set various options regarding the operating system and boot devices.

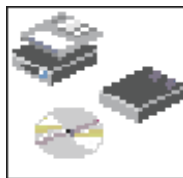
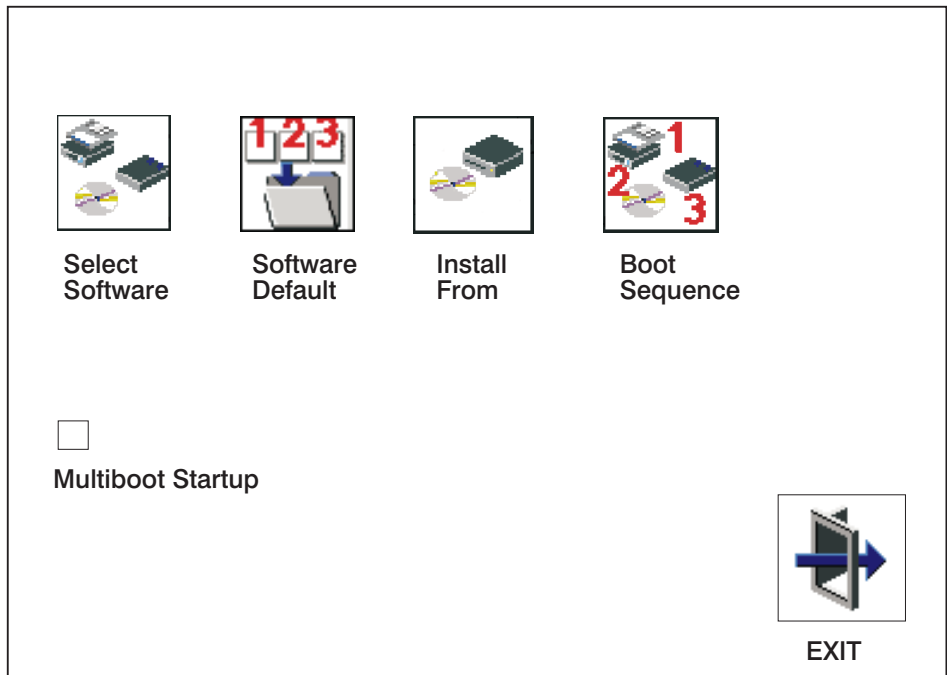

The following describes the choices available on this screen.

Select Software: This option, if supported by the operating system, allows you to choose which operating system to use. Choosing an operating system causes the system to start. This option is supported by AIX. However, not all operating systems support this option.

If you receive an informational message saying that no operating system is installed, then the system information in nonvolatile storage may have been lost. This situation can occur if the battery has been removed. To correct this situation, refer to the **bootlist** command in your AIX operating system documentation.



Software Default: This option, if supported by the operating system, enables you to select a default operating system for your system unit.

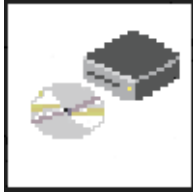

Install From: Enables you to select a media drive from which to install an operating system. Selection of a device is done using the spacebar.

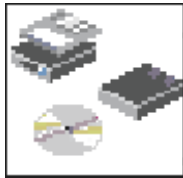

Boot Sequence: Enables you to view and change the custom boot list (the sequence in which devices are searched for operating system code). You may choose from 1 to 5 devices for the custom boot list.

The default boot sequence is:

1. Diskette drive
2. CD-ROM drive
3. Tape drive
4. Hard disk drive
5. Network adapter

To change the custom boot list, enter a new order in the **New** column, then click on the **Save** icon. The list of boot devices is updated to reflect the new order.

Attention: To change the custom boot list back to the default values, click on **Default**. If you change your startup sequence, you must be extremely careful when performing *write* operations (for example, copying, saving, or formatting). You can accidentally overwrite data or programs if you select the wrong drive.

Multiboot Startup: Clicking on this button toggles whether the Multiboot menu displays automatically at startup.

Utilities

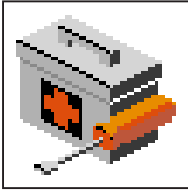

Selecting this icon enables you to perform various tasks and view additional information about your system unit.

The following describes the choices available on this screen.

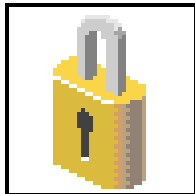
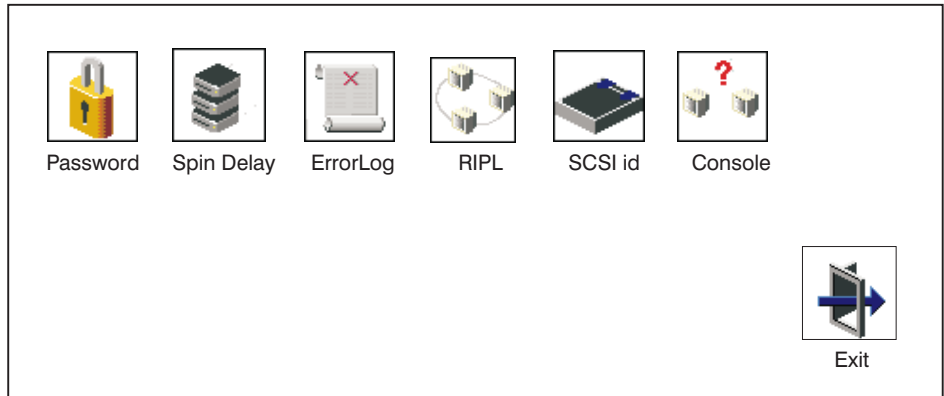

Password: Enables you to set password protection for turning on the system unit and for using system administration tools. Go to “Password” on page 67.

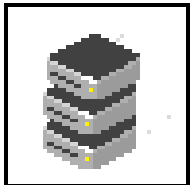

Spin Delay: Enables you to change the spin-up delay for SCSI hard disk drives attached to your system. Go to “Spin Delay” on page 71.

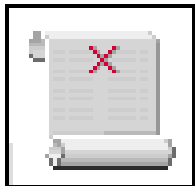

Error Log: Enables you to view and clear the firmware error log for your system unit. Go to “Error Log” on page 72.

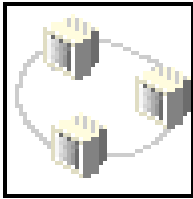

RIPL (Remote Initial Program Load): Enables you to select a remote system from which to load programs through a network adapter when your system unit is first turned on. This option also allows you to configure network adapters, which is required for RIPL. Go to “RIPL” on page 73.

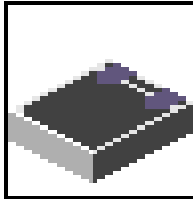

SCSI ID: Allows you to view and change the addresses (IDs) of the SCSI controllers attached to your system unit. Go to “SCSI ID” on page 78.



Console: Allows the user to select which console to use to display the SMS menus. This selection is only for the SMS menus. It does not affect the display used by the AIX operating system.

Follow the instructions that display on the screen. Pressing the number 1 key after the keyboard icon appears and before the tone returns you to SMS.

Password

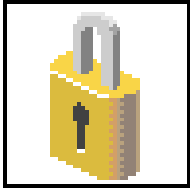

Select this icon to perform password-related tasks.

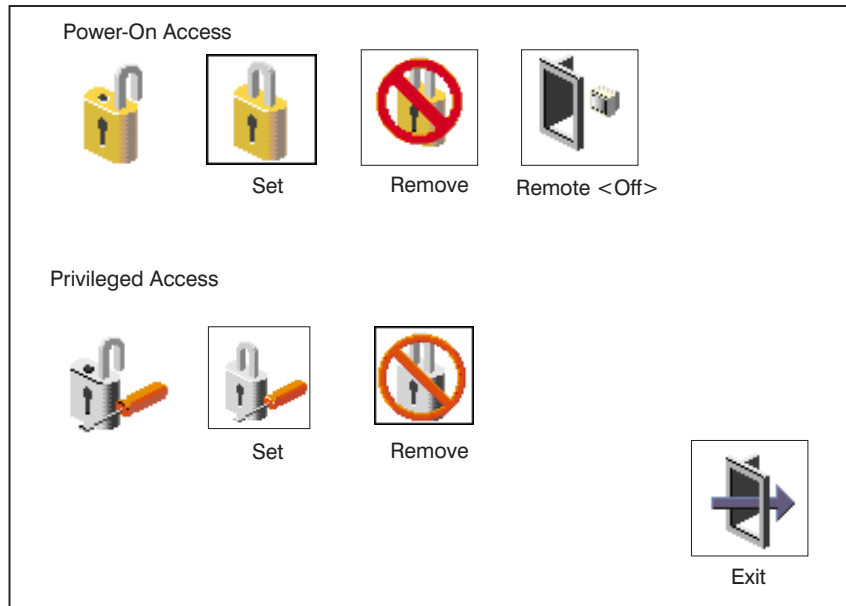



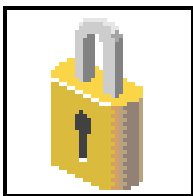

Power-On Access Password



Setting a **Power-On Access** password helps protect information stored in your system unit. If a power-on access password is set for your system unit, the power-on access status icon is shown in the locked position. If a power-on access password is not set, then the power-on access status icon is shown in the unlocked position (as shown in the preceding screen).

When you select the **Set** icon, a screen with eight empty boxes displays. Type your password in these boxes. You can use any combination of up to eight characters (A–Z, a–z, and 0–9) for your password. As you type a character, a key displays in the box.

Enter Password

							
---	---	---	---	--	--	--	--

Press Enter when you are finished; you must type the password again for verification.

Verify Password

--	--	--	--	--	--	--	--

If you type the password incorrectly, press the Esc key and start again.

If the two password entries do not match, an error icon appears with the error code 20E00000.

Note: After you have entered and verified the password, the power-on access password icon flashes and changes to the locked position to indicate that your system unit now requires the password you just entered during the power-on process.

If you previously had set a power-on-access password and want to remove it, select the **Remove** icon.

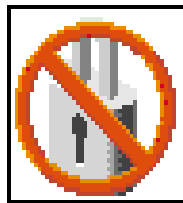

After you have selected the remove icon, the power-on-access status icon flashes and changes to the unlocked position to indicate that the power-on-access password is not set.

Note: If you *forget* the power-on access password, you can erase the password by shutting down the system unit and removing the battery for at least 30 seconds. The system unit power cable *must* be disconnected before removing the battery.

A password becomes effective only after the system is turned off and back on again.

Attention: If no user-defined bootlist exists and the power-on-access password has been enabled, you are asked for the power-on-access password at startup every time you boot your system.

Remote Mode

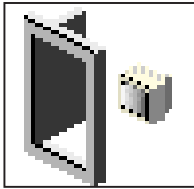

Remote Mode: The remote mode, when enabled, allows the system to start from the defined boot device. This mode is ideal for network servers and other system units that operate unattended. When the remote mode is set, the icon label changes to **Remote <On>**

Note: To use the remote mode feature for booting unattended devices, you must enable the unattended start mode. See the “System Power Control Menu” on page 34 for instructions on enabling the unattended start mode, which allows the system unit to turn on whenever ac power is applied to the system (instead of having the system unit wait for the power button to be pushed).

Privileged-Access Password

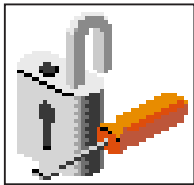



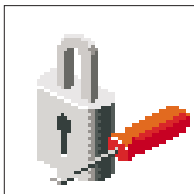

The privileged-access password protects against the unauthorized starting of the system programs. Select the **Set** icon to set and verify the privileged-access password.



When you select the **Set** icon, a screen with eight empty boxes displays. Type your password in these boxes. You can use any combination of up to eight characters (A-Z, a-z, and 0-9) for your password. As you type a character, a key displays in the box.

Enter Password

							
---	---	---	---	--	--	--	--

Press Enter when you are finished; you must type the password again for verification.

Verify Password

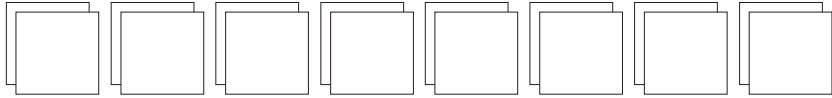

If you type the password incorrectly, press the Esc key and start again.

If the two password entries do not match, an error icon displays with the error code 20E00001.

Note: After you have entered and verified the password, the privileged-access password icon flashes and changes to the locked position to indicate that your system now requires the password you just entered before running system programs.

If you previously had set a privileged-access password and want to remove it, select the **Remove** icon.

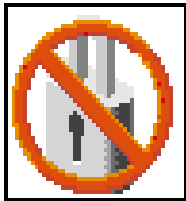

After you have selected the **Remove** icon, the privileged-access status icon flashes and changes to the unlocked position to indicate that the privileged-access password is not set.

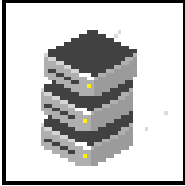

Attention: If no user-defined bootlist exists and the privileged-access password has been enabled, you are asked for the privileged-access password at startup every time you boot your system.

Spin Delay



Select this icon to change the spin-up delay for SCSI hard disk drives attached to your system. Spin-up delay values can be entered manually or you can use a default setting. All values are measured in seconds. The default is two seconds. After you have entered the new spin-up delay values, use the arrow keys to highlight the **Save** icon and press Enter.

<Hard Disk Spinup Delay>
Current Spin Up Value - 2
Enter New Value (>1) (SEC)

		
Save	Default	Exit

Error Log

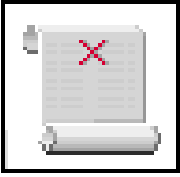

Selecting this icon displays the log of errors that your system has recorded during operations.

System Error Log

Date	Time	Error Code	Location
1. 00/04/13	00:51:32	25C38005	P1-M1.10
2. No entry			



Clear



Exit

Selecting the **Clear** icon erases the entries in this log.

This error log only shows the first and last errors.

Note: The time stamp in this error log is coordinated universal time (UTC), which is also referred to as Greenwich mean time (GMT). AIX error logs have more information available and can time stamp with your local time.

RIPL

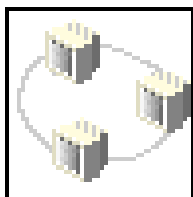

Selecting the **Remote Initial Program Load (RIPL)** icon gives you access to the following selections.

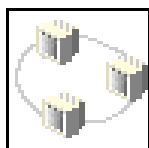

Set Address

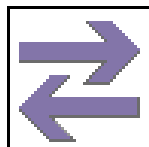

Ping

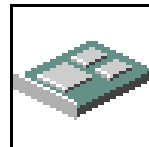

Config

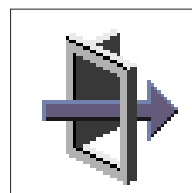

Exit

Set Address

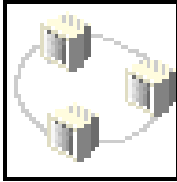

The **Set Address** icon allows you to define addresses from which your system unit can receive RIPL code.

Remote IPL Setup

Client Addr	000.000.000.000
Server Addr	000.000.000.000
Gateway Addr	000.000.000.000
Subnet Mask	255.255.255.000

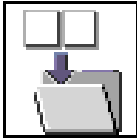

Save



Exit

If any of the addresses is incomplete or contains a number other than 0 to 255, an error message displays when you select the **Save** icon. To clear this error, correct the address and select **Save** again.

Attention: If the client system and the server are on the same subnet, set the gateway IP address to [0.0.0.0].

To change an address, press the backspace key on the highlighted address until the old address is completely deleted. Then type the new address.

Ping

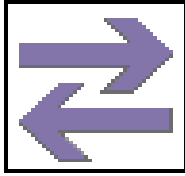

The **Ping** icon allows you to confirm that a specified address is valid by sending a test transmission to that address.

Ping Setup

Client Addr	000.000.000.000
Server Addr	000.000.000.000
Gateway Addr	000.000.000.000
Subnet Mask	255.255.255.000

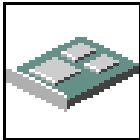

Adapter



Exit

To change an address, press the backspace key on the highlighted address until the old address is completely deleted. Then type the new address.

Selecting the **Ping** icon displays a screen in which you select the communications (token-ring or Ethernet) to be used to send test transmissions.

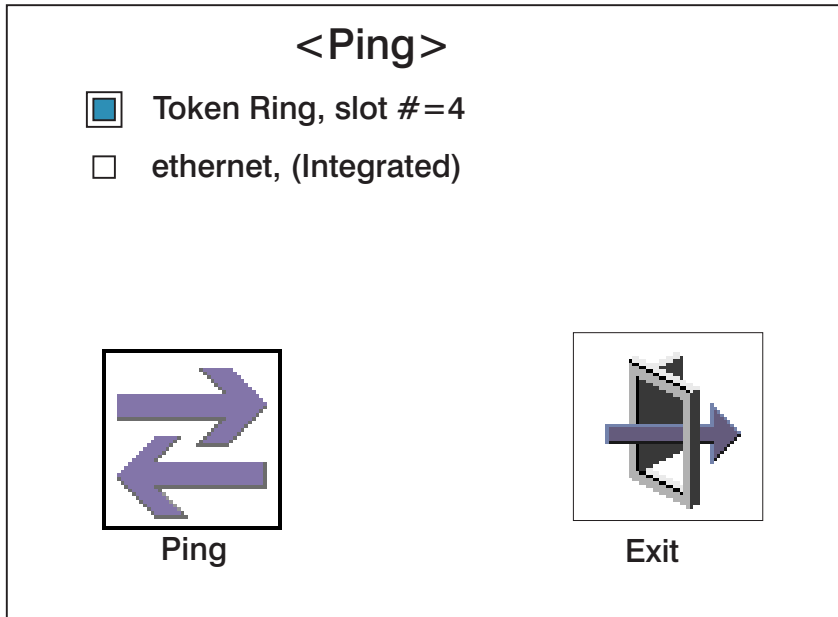

To use this screen, do the following:

1. Use the arrow keys or mouse to highlight an adapter to configure.

Note: Clicking with the mouse sends the ping. If you use the arrow keys, you must press the space bar, then use the **Ping** icon.

2. Press the spacebar to select the adapter.
3. Highlight the **Ping** icon and press Enter to send the test transmission.

Config

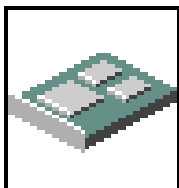

The **Config** icon allows you to configure network adapters that require setup.

Selecting the **Config** icon causes a list of the adapters requiring configuration to display.

To use this screen, do the following:

1. Use the arrow keys or mouse to highlight an adapter to configure.
2. Press the spacebar to select the adapter.
3. Highlight the **OK** icon and press Enter.

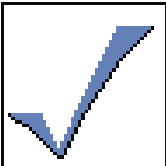
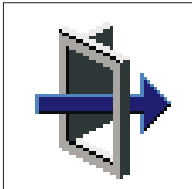
Data Rate		
<input checked="" type="checkbox"/> 10 Mbps	<input type="checkbox"/> 100 Mbps	<input type="checkbox"/> Auto
Full Duplex		
<input type="checkbox"/> Yes	<input type="checkbox"/> No	<input type="checkbox"/> Auto
		
Save	Exit	

SCSI ID

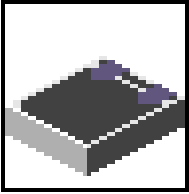



Select this icon to view and change the addresses (IDs) of the SCSI controllers attached to your system unit.

To change a SCSI controller ID, highlight the entry by moving the up or down arrow keys, then use the spacebar to scroll through available IDs. After you have entered the new address, use the left or right arrow keys or mouse to highlight the **Save** icon and press Enter.

At any time in this process, you can select the **Default** icon to change the SCSI IDs to the default value of 7.

Change SCSI ID

Type	Slot	Id	Max Id
Ultra	0	7	15
Fast/Wide	0	7	15

Save **Default** **Exit**

Firmware Update

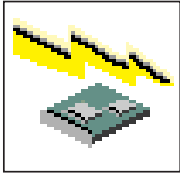

Attention: The SMS firmware update utility does not support the combined image update process. It is recommended only for those systems that cannot boot AIX. Detailed instructions on using the SMS utilities to update system and service processor firmware can be obtained from the following Web site:

<http://www.rs6000.ibm.com/support/micro>

If you are not able to obtain firmware update images or instructions from this Web site, contact your service representative.

If the firmware update image is available on your network from another system, see Appendix D, “Firmware Updates” on page 169 for instructions on updating the system and service processor firmware using a combined image from the AIX command line.

Firmware Recovery

If a troubleshooting procedure has indicated that the system firmware unit has been damaged, it may be possible to recover it. For example, if the system hangs during startup with E1EA displayed on the operator panel, the system firmware has been damaged but may be recovered.

To recover damaged system firmware, do the following:

1. Create a firmware recovery diskette. This must be a 3.5" high-density (1.44 MB) diskette that has been formatted for DOS.
2. Obtain the system firmware update image file from one of the following sources:
 - a. From the Web address: <http://www.rs6000.ibm.com/support/micro>
 - b. From a service representative if you cannot access the Web address.
3. Copy the system firmware update image file to the recovery diskette, naming it PRECOVER.IMG. The file must be written in DOS format.
4. When the system stops booting, for example at E1EA, insert the recovery diskette. If the diskette drive LED does not light up, power the system unit off, then back on again.
5. If the recovery procedure is successful, the system will continue starting and will display checkpoints of the form E1XX.
6. Enter the System Management Services menu. When the keyboard indicator displays, press the 1 key if the system console is an ASCII terminal. If the system console is a graphics display and directly attached keyboard, press the F1 key.
7. When the main menu displays, choose Utilities, then perform an update of the system firmware by following the prompts that are displayed.

Attention: A companion service processor firmware update may be required. See the Web site at <http://www.rs6000.ibm.com/support/micro> to get additional information on companion levels and detailed update instructions.

Text-Based System Management Services

The text-based System Management Services are available if an ASCII terminal is attached to your system. The text-based System Management Services makes it possible for you to view information about your system and to perform such tasks as setting passwords and changing device configurations.

To start the text-based System Management Services, press the number **1** key on the ASCII terminal after the word "keyboard" appears and before the word "speaker" appears. After the text-based System Management Services starts, the following screen displays.

Note: The version of firmware currently installed in your system is displayed at the top of each screen in the text-based System Management Services. Note the version number. Processor and other device upgrades may require a specific version of firmware to be installed in your system. Update System Firmware is an option under the Main Menu.

On all menus except the Main Menu, there are several navigator keys:

- M** Return to the main menu.
- ESC** Return to the previous menu.
- X** Exit the System Management Services and start the operating system.
If X is entered, you are asked to confirm your choice to exit the SMS menus and start the operating system.

When there is more than one page of information to display, there are two additional navigator keys:

- N** Display the next page of the list.
- P** Display the previous page of the list.

Note: The lower-case navigator key has the same effect as the upper-case key that is shown on the screen. For example, "m" or "M" takes you back to the main menu.

On each menu screen, you are given the option of choosing a menu item and pressing enter (if applicable), or selecting a navigator key.

Main Menu

- 1 Select Language
- 2 Change Password Options
- 3 View Error Log
- 4 Setup Remote IPL (Initial Program Load)
- 5 Change SCSI Settings
- 6 Select Console
- 7 Select Boot Options
- 8 View System Configuration Components
- 9 System/Service Processor Firmware Update

Navigator keys:

X = eXit System Management Services

Type the number of the menu item and press Enter or Select a Navigator key: _

Select Language

Note: Your TTY must support the ISO-8859 character set to properly display languages other than English.

This option allows you to change the language used by the text-based System Management Services screens.

SELECT LANGUAGE

1. English
2. Francais
3. Deutsch
4. Italiano
5. Espanol

Navigator keys:

M = return to main menu

ESC key = return to previous screen

X = eXit System Management Services

Type the number of the menu item and press Enter or Select a Navigator key: _

Change Password Options

The Change Password Options screen enables you to select from password utilities.

Password Utilities

- 1 Set Privileged-Access Password
- 2 Remove Privileged-Access Password
- 3 Unattended Start Mode <OFF>

Navigator keys:

M = return to main menu

ESC key = return to previous screen

X = eXit System Management Services

Type the number of the menu item and press Enter or Select a Navigator key: _

Set Privileged-Access Password

The privileged-access password protects against the unauthorized starting of the system programs.

Attention: If the privileged-access password has been enabled, you are asked for the privileged-access password at startup every time you boot your system.

If you previously had set a privileged-access password and want to remove it, select **Remove Privileged-Access Password**.

Unattended Start Mode

Use this option to instruct the service processor to immediately power-on the server after a power failure, bypassing power-on password verification. Unattended start mode can also be enabled or disabled using service processor menus. Unattended start mode can be used on servers that require automatic power-on after a power failure.

Note: Unlike other systems, unattended start mode is not automatically disabled when the power-on access password is removed.

View Error Log

Use this option to view or clear your system's error log. A screen similar to the following displays when you select this option.

```
Error Log

      Date      Time      Error Code      Location
Entry 1. 01/04/96 12:13:22 25A80011      00-00
Entry 2. no error logged

1. Clear error log

-----
Navigator keys:
M = return to main menu
ESC key = return to previous screen                X = eXit System Management Services
-----
Type the number of the menu item and press Enter or Select a Navigator key: _
```

Note: The time stamp in his error log is coordinated universal time (UTC), which is also referred to as Greenwich mean time (GMT). AIX error logs have more information available and can time stamp with your local time.

Setup Remote IPL (Initial Program Load)

This option allows you to enable and set up the remote startup capability of your system unit. You must first specify the network parameters.

Network Parameters

1. IP Parameters
2. Adapter Parameters
3. Ping

Navigator keys:

M = return to main menu

ESC key = return to previous screen

X = eXit System Management Services

Type the number of the menu item and press Enter or Select a Navigator key: _

Selecting the IP (Internet Protocol) Parameters option displays the following screen.

IP Parameters

1. Client IP Address [000.000.000.000]
2. Server IP Address [000.000.000.000]
3. Gateway IP Address [000.000.000.000]
4. Subnet Mask [255.255.255.000]

Navigator keys:

M = return to main menu

ESC key = return to previous screen

X = eXit System Management Services

Type the number of the menu item and press Enter or Select a Navigator key: _

To change IP parameters, type the number of the parameters for which you want to change the value.

Attention: If the client system and the server are on the same subnet, set the gateway IP address to [0.0.0.0].

Selecting the **Adapter Parameters** option allows you to view an adapter's hardware address, as well as configure network adapters that require setup. A screen similar to the following displays.

Device	Slot	Hardware Address
1. ethernet	3	0004AC5E08D2
2. token-ring	5	0020357A0530
3. ethernet	Integrated	0004ACE4020B

Navigator keys:
M = return to main menu
ESC key = return to previous screen
X = eXit System Management Services

Type the number of the menu item and press Enter or Select a Navigator key: _

Selecting an adapter on this screen displays configuration menus for that adapter:

10/100 Ethernet TP PCI Adapter	
1. Data Rate	(Currently Auto)
2. Full Duplex	(Currently Yes)

Navigator keys:
M = return to main menu
ESC key = return to previous screen
X = eXit System Management Services

Type the number of the menu item and press Enter or Select a Navigator key: _

Selecting the **Data Rate** option allows you the change the media employed by the Ethernet adapter:

Select Data Rate

1. 10 Mbps
2. 100 Mbps
3. Auto

Navigator keys:
M = return to main menu
ESC key = return to previous screen
X = eXit System Management Services

Type the number of the menu item and press Enter or Select a Navigator key: _

Selecting the **Full Duplex** option allows you to change how the Ethernet adapter communicates with the network:

Select Full Duplex Mode

1. Yes
2. No
3. Auto

Navigator keys:
M = return to main menu
ESC key = return to previous screen
X = eXit System Management Services

Type the number of the menu item and press Enter or Select a Navigator key: _

Select **Ping**, from the Network Parameters Menu, to test a connection to a remote system unit. After selecting the **Ping** option, you must choose which adapter communicates with the remote system.

Adapter Parameters

Device	Slot	Hardware Address
1. 100/10 Ethernet	5:P1-I5/E1	0060940d5151
2. fddi	4:P1-I4/Q1	00005a4263cd
3. 100/10 Ethernet	Integrated: P1/E1	000000000000

Navigator keys:
M = return to main menu
ESC key = return to previous screen
X = eXit System Management Services

Type the number of the menu item and press Enter or Select a Navigator key: _

After choosing which adapter to use to ping the remote system, you must provide the addresses needed to communicate with the remote system.

Ping IP Address

1. Client IP Address [129.132.4.20]
2. Server IP Address [129.132.4.10]
3. Gateway IP Address [129.132.4.30]
4. Subnet Mask [255.255.255.0]
5. Execute Ping

Navigator keys:

M = return to main menu

ESC key = return to previous screen

X = eXit System Management Services

Type the number of the menu item and press Enter or Select a Navigator key: _

Change SCSI Settings

This option allow you to view and change the addresses of the SCSI controllers attached to your system.

SCSI Utilities

1. Change Hardware Spin Up Delay
2. Change SCSI Id

Navigator keys:

M = return to main menu

ESC key = return to previous screen

X = eXit System Management Services

Type the number of the menu item and press Enter or Select a Navigator key: _

Select Console

The Select Console Utility allows the user to select which console the user would like to use to display the SMS menus. This selection is only for the SMS menus and does not affect the display used by the AIX operating system.

Follow the instructions that display on the screen. To return to the SMS menu, press the number **1** key after the word **keyboard** displays and before the tone sounds.

Select Boot Options

Use this screen to view and set various options regarding the operating system and boot sequence.

```
Multiboot Menu
1 Select Software
2 Software Default
3 Select Install Device
4 Select Boot Device
5 Multiboot Startup <currently OFF>

-----
Navigator keys:
M = return to main menu
ESC key = return to previous screen
X = eXit System Management Services
-----
Type the number of the menu item and press Enter or Select a Navigator key: _
```

Select Software: If this option is supported by the operating system, it shows the name of the operating system installed. This option may not be supported by all operating systems.

If you are running on AIX and you receive the following message:

```
No Operating System Installed
```

this indicates that information in nonvolatile storage could have been lost, as would happen if the battery had been removed. To re-create this value, run the **bootlist** command under AIX with the appropriate parameters as to the location of the operating system in a particular hard disk. See the **bootlist** command in your AIX documentation. The AIX Documentation library is available at the following Web address: <http://www.ibm.com/servers/aix/library/>. Select **Technical Publications**. AIX documentation is also contained on the AIX Documentation CD. The documentation is made accessible by loading the documentation CD onto the hard disk or by mounting the CD in the CD-ROM drive.

Software Default: If supported by the operating system, lets you select the default operating system to start the system. This option may not be supported by all operating systems.

Select Install Device: Produces a list of devices, for example the CD-ROM, from which the operating system is installed. Select a device and the system searches the device for an operating system to install and if supported by the operating system in that device, the name of the operating system displays.

Select Boot Device: Provides a list of devices that can be selected to be stored in the boot list. Up to five devices are supported.

OK Prompt: Provides access to the open firmware command prompt. This option should only be used by service personnel to obtain additional debug information.

Multiboot Startup: Toggles between OFF and ON and selects whether the Multiboot menu invokes automatically on startup.

Select Boot Device

Select this option to view and change the custom boot list, which is the sequence of devices read at startup.

```
Select Boot Devices

1 Display Current Settings
2 Restore Default Settings
3 Configure 1st Boot Device
4 Configure 2nd Boot Device
5 Configure 3rd Boot Device
6 Configure 4th Boot Device
7 Configure 5th Boot Device

-----
Navigator keys:
M = return to main menu
ESC key = return to previous screen
X = eXit System Management Services
-----
Type the number of the menu item and press Enter or Select a Navigator key: _
```

Display Current Settings: Lists the current order of devices in the boot list. The following screen shows an example of this display.

```
Current Boot Device

1. SCSI 9100 MB Harddisk (loc = P1-I6/Z1-A8)
2. SCSI CD-ROM (loc = P1/Z1-A1)
3. SCSI Tape (loc = P1/Z1-A0)
4. Ethernet (loc = P1-I5/E10)
5. None

-----
Navigator keys:
M = return to main menu
ESC key = return to previous screen
X = eXit System Management Services
-----
Type the number of the menu item and press Enter or Select a Navigator key: _
```

Restore Default Settings: Restores the boot list to the default device of:

1. Primary diskette drive
2. CD-ROM drive
3. Tape drive (if installed)
4. Hard disk drive
5. Network adapter

Attention: To change the custom boot list back to the default values, select the **Default**. If you change your startup sequence, you must be extremely careful when performing *write* operations (for example, copying, saving, or formatting). You can accidentally overwrite data or programs if you select the wrong drive.

Configure Nth Boot Device

In the description below, **Nth** can be **1st, 2nd, 3rd**, and so on, depending on your choice on the previous menu.

Options display a screen similar to the following:

Device Number	Current Position	Device Name
1	1	Diskette
2	2	Port E2 - 100/10 Ethernet Adapter (Integrated)
3		Port E1 - 100/10 Ethernet Adapter Integrated)
4	3	IDE CD-ROM
5	4	SCSI 36.4 MB Hard Disk id=@0,0 (Integrated)
6	-	

Navigator keys:
M = return to main menu
ESC key = return to previous screen
X = eXit System Management Services

Type the number of the menu item and press Enter or Select a Navigator key: _

Type the device number of the device name that you want to select as the **Nth** boot device. For example, if you entered this menu by selecting 4 on the previous menu (configure 2nd Boot Device), then enter the number 3 based on the list shown above. You are thus selecting the SCSI CD-ROM device to be the 2nd (**Nth**) device in the boot sequence.

View System Configuration Components

This option provides information about the setup of your system unit. A screen similar to the following displays.

```
Device Name
Power PC, POWER3 375 MHz
L2-Cache 4096K
Power PC, POWER3 375 MHz
L2-Cache 4096K
Memory
  Memory card slot=1, module slot=1 size=512MB
  Memory card slot=1, module slot=2 size=512MB
  Memory card slot=1, module slot=3 size=512MB
  Memory card slot=1, module slot=4 size=512MB

Service Processor
Tablet Port

LPT   addr=378

COM   addr=3F8

COM   addr=2F8

Keyboard
Mouse
Diskette addr=3F0

SCSI controller id=7 (P1/Z1)

-----
Navigator keys:
M = return to main menu           N = next page of list           P = previous page of list
ESC key = return to previous screen X = eXit System Management Services
-----
Type the number of the menu item and press Enter or Select a Navigator key: _
```

System/Service Processor Firmware Update

Firmware Update Menu

1. System Firmware
2. Service Processor Firmware

Navigator keys:

M = return to main menu

ESC key = return to previous screen

X = eXit System Management Services

Type the number of the menu item and press Enter or Select a Navigator key: _

Attention: The SMS firmware update utility does not support the combined image update process. It is recommended only for those systems that cannot boot AIX. Detailed instructions on using the SMS utilities to update system and service processor firmware can be obtained from the following Web site:

<http://www.rs6000.ibm.com/support/micro>

If you are not able to obtain firmware update images or instructions from this Web site, contact your service representative.

If the firmware update image is available on your network from another system, see Appendix D, "Firmware Updates" on page 169 for instructions on updating the system and service processor firmware using a combined image from the AIX command line.

Firmware Recovery

For instructions on firmware recovery, go to "Firmware Recovery" on page 79.

Chapter 5. Using the Standalone and Online Diagnostics

The diagnostics consist of Standalone Diagnostics and Online Diagnostics. The Standalone Diagnostics must be booted before they are run. If booted, they have no access to the AIX Error Log or the AIX Configuration Data.

Online Diagnostics, when installed, are resident with AIX on the disk or server. They can be booted in single user mode (called *service mode*), run in maintenance mode (called *maintenance mode*), or run concurrently (called *concurrent mode*) with other applications. They have access to the AIX Error Log and the AIX Configuration Data.

Attention: If this system unit is attached to another system, be sure you isolate this system unit before stopping the operating system or running diagnostic programs. Some system-cabling changes (such as installing wrap plugs or removing a device from the configuration) may require action by the operator of the attached system before making the cabling changes on this system.

Standalone and Online Diagnostics Operating Considerations

Consider the following before using the diagnostics:

- Run Online Diagnostics in Service Mode when possible, unless otherwise directed. The Online Diagnostics perform additional functions, compared to Standalone Diagnostics. The AIX error log and certain SMIT functions are only available when diagnostics are run from the disk drive.
- When running Online Diagnostics, device support for some devices may not have been installed. If this is the case, that device does not appear in the resource list.
- When running Standalone Diagnostics, device support for some devices may be contained on supplemental diagnostic media. If this is the case, the device does not appear in the resource list when running diagnostics unless the supplemental media has been processed.
- Support for some TTY terminals is optionally installed. If you attach a TTY terminal to a system to run diagnostics, it might not work correctly because the AIX support for the terminal might not be installed.

Selecting a Console Display

When you run Standalone Diagnostics (and under some conditions Online Diagnostics), you must select the console display. The diagnostics display instructions on any graphics display and the terminal attached to the S1 serial port.

Identifying the Terminal Type to the Diagnostics Programs

Note: This is a different function from selecting a console display.

When you run diagnostics, you must identify what type of terminal you are using. If the terminal type is not known when the FUNCTION SELECTION menu is displayed, the diagnostics do not allow you to continue until a terminal is selected from the DEFINE TERMINAL option menu. Select **lft** for adapter-attached displays.

Undefined Terminal Types

If you specify an undefined terminal type from the DEFINE TERMINAL option menu, the menu prompts you to enter a valid terminal type. The menu redispays until either a valid type is entered or the user exits the DEFINE TERMINAL option.

Resetting the Terminal

If you enter a terminal type that is valid (according to the DEFINE TERMINAL option menu) but is not the correct type for the ASCII terminal being used, you may be unable to read the screen, use the function keys, or use the Enter key. Bypass these difficulties by pressing Ctrl-C to reset the terminal. The screen display which results from this resetting action depends on the mode in which the system is being run:

- Online Normal or Maintenance Mode - The command prompt displays.
- Standalone Mode or Online Service Mode - The terminal type is reset to dumb, the Diagnostic Operating Instruction panel displays, and you are required to go through the DEFINE TERMINAL process again.

Running Online Diagnostics from CD-ROM

Consider the following when you run the Online Diagnostics from a server or a disk:

- The diagnostic CD-ROM disc must remain in the CD-ROM drive for the entire time that diagnostics are running.
- The diagnostic CD-ROM disc cannot be ejected from the CD-ROM drive once the diagnostic programs load. The diagnostic CD-ROM disc can only be ejected after the system has been powered off and then powered on (Standalone mode), or after the diagnostics program has terminated (Online concurrent mode). The diagnostic CD-ROM disc must be ejected before attempts to load the diagnostic programs again.
- The CD-ROM drive from which diagnostics were loaded cannot be tested.
- The SCSI adapter (or circuitry) controlling the CD-ROM drive from which diagnostics were loaded cannot be tested.

Running Standalone Diagnostics from a Network Installation Management (NIM) Server

A *client* system connected to a network with a Network Installation Management (NIM) server, is capable of booting Standalone Diagnostics from the NIM server if the client system is registered on the NIM server, and the NIM boot settings on both the NIM server and the client system are correct.

Notes:

1. For NIM clients that have adapters which would normally require that supplemental media be loaded when standalone diagnostics are run from CD-ROM, the support code for these adapters needs to be loaded into the directory pointed to by the NIM SPOT from which you wish to boot that client. Before running standalone diagnostics on these clients from the NIM server, the NIM server system administrator must ensure that any needed support for these devices is loaded on the server.
2. The amount of system memory required to run Standalone Diagnostics from a NIM server using the **bos.diag.rte** fileset at level 4.3.3.25, is 64 MB.

To determine the fileset level, run the following AIX command at the NIM server (you must have root authority):

```
nim -o showres SPOTNAME | grep bos.diag.rte
```

(Where SPOTNAME is the name of the SPOT from which you want to do a NIM boot (example, SPOT433)).

Use one of the following methods to determine the amount of available system memory:

- Run the Display Resource Attributes task for resource.
- Use the **Config** option under System Management Services (see the system unit service guide).
- Use the following AIX command:

```
lsattr -E -l mem0
```

3. All operations to configure the NIM server require root authority.
4. If you replace the network adapter in the client, the network adapter hardware address for the client must be updated on the NIM server.
5. The Control state (Cstate) for standalone clients on the NIM server should be kept in the Diagnostic Boot has been Enabled state.
6. On the client system, the NIM server network adapter should be put in the bootlist after the boot disk drive. This allows the system to boot up in Standalone Diagnostics from the NIM server should there be a problem booting from the disk drive. Refer to the "Multiboot" section under SMS chapter in the service guide for the client system to obtain information about setting the bootlist.

NIM Server Configuration

Refer to the *Network Installation Management Guide and Reference* for information on doing the following:

- Register a client on the NIM server.
- Enable a client to run diagnostics from the NIM server.

To verify that the client system is registered on the NIM server and *diagnostic boot* is enabled; from the command line on the NIM server, run the following command:

```
lsnim -a Cstate -Z ClientName
```

Refer to the following table for system responses.

Note: The ClientName is the name of the system on which you are wanting to run the Standalone Diagnostics.

System Response	Client Status
#name:Cstate: ClientName: diagnostic boot has been enabled:	The client system is registered on the NIM server and enabled to run diagnostics from the NIM server.

System Response	Client Status
#name:Cstate: ClientName:ready for a NIM operation: or #name:Cstate: ClientName:BOS installation has been enabled:	The client system is registered on the NIM server but not enabled to run standalone diagnostics from the NIM server. Note: If the client system is registered on the NIM server but Cstate has not been enabled, no data will be returned.
0042-053 lsnim: there is no NIM object named "ClientName"	The client is not registered on the NIM server.

Client Configuration and Booting Standalone Diagnostics from the NIM Server

To run Standalone Diagnostics on a client system from the NIM server, do the following:

1. Remove all removable media (tape or CD-ROM disc).
2. Stop all programs, including the AIX operating system (get help if needed).
3. Turn off the system unit power.
4. Turn on the system unit power.
5. When the keyboard indicator displays (the word **keyboard** on an ASCII terminal or the Keyboard icon on a graphical display), press the number 1 key on the keyboard to display the SMS menu.
6. Enter any requested passwords.
7. Select **Utilities**.
8. Depending on the console type, select **RIPL** or **Remote Initial Program Load Setup**.
9. Depending on the console type, select **Set Address** or **IP Parameters**.
10. Enter the client address, server address, gateway address (if applicable), and subnet mask into the Remote Initial Program Load (RIPL). If there is no gateway between the NIM server and the client, set the gateway address to 0.0.0.0. To determine if there is a gateway, either ask the system network administrator or compare the first 3 octets of the NIM server address and the client address. If they are the same, (for example, if the NIM server address is 9.3.126.16 and the client address is 9.3.126.42, the first 3 octets (9.3.126) are the same), then set the gateway address in the RIPL field to 0.0.0.0.

Note: RIPL is located under the Utility menu in System Management Services (SMS) and should be referred to for information on setting these parameters.

11. If the NIM server is setup to allow the pinging of the client system, use the **ping** option in the RIPL utility to verify that the client system can ping the NIM server. Under the Ping utility, choose the network adapter that provides the attachment to the NIM server to do the ping operation. If the ping comes back with an *OK* prompt, the client is prepared to boot from the NIM server. If ping returns with a *FAILED* prompt, the client does not proceed with the boot.

Note: If the ping fails, refer to "Boot Problems/Concerns" in the service guide for the system unit. Then follow the steps for network boot problems.

Use the following procedure to temporarily changes the system bootlist so that the network adapter attached to the NIM server network, is first in the bootlist:

1. Exit to the SMS Main screen.
2. Depending on the console type, select **Multiboot** or **Select Boot Devices**.
3. Depending on the console type, select **Boot Sequence** or **Select Boot Devices**.
4. Record the current bootlist settings. (You will have to set the bootlist back to the original settings after running diagnostics from the NIM server.)
5. Change the bootlist so the network adapter attached to the NIM server is first in the bootlist.
6. Exit completely from SMS. The system should start loading packets while doing a bootp from the network.

Follow the instructions on the screen to select the system console.

If Diagnostics Operating Instructions Version x.x.x is displays, Standalone Diagnostics has loaded successfully. If the AIX login prompt displays, Standalone Diagnostics did not load. Check the following items:

- The bootlist on the client might be incorrect.
- Cstate on the NIM server might be incorrect.
- There might be network problems preventing you from connecting to the NIM server.

Verify the settings and the status of the network. If you continue to have problems, refer to "Boot Problems/Concerns" in the service guide for the system unit. Then follow the steps for network boot problems.

After running diagnostics, reboot the system and use SMS to change the bootlist sequence back to the original settings.

Locking and Unlocking the Electronic Service Agent

If the system is setup with a Electronic Service Agent, you must lock out the Electronic Service Agent before running diagnostics. This prevents the Electronic Service Agent from using the diagnostics while you are running them. Use the following commands to lock out the Electronic Service Agent:

```
cd /usr/lpp/servdir
ls /usr/lpp/servdir/servdir.lck
```

If a file named **servdir.lck** is listed, the Electronic Service Agent is already locked out. If it is not listed, use the following command to create the file:

```
/usr/lpp/servdir/servdir.lck
```

Use the following command to check that the **servdir.lck** file was created (if the file is present the Electronic Service Agent is locked out):

```
/usr/lpp/servdir/servdir.lck
```

Use the following commands to unlock the Electronic Service Agent:

```
/usr/lpp/servdir/servdir.analyze reset  
rm /usr/lpp/servdir/servdir.lck
```

Use the following command to check that the **servdir.lck** file was deleted (the file should not be present):

```
ls /usr/lpp/servdir/servdir.lck
```

If the file is listed, the Electronic Service Agent is still locked out.

Locking and Unlocking the Service Agent

If the system is setup with a service agent, you must lock out the service agent before running diagnostics.

Note: The system does not report problems while the service agent is locked out. When you complete your service action, be sure to unlock the service agent to allow it to report problems.

Use the following procedure to lock out the service agent:

1. Click the **Administration** folder.
2. Select the **Lockout Machines** option.
3. In the Detail screen, select the system you want to lock out, then click **Lock**.
4. To verify that the system is locked out, click the **Network** folder.
5. Click the Padlock icon to display the lockout status. The system you locked out should have a red X displayed, indicating it is locked out.

Use the following procedure to unlock the service agent:

1. Click the **Administration** folder.
2. Select the **Lockout Machines** option.
3. In the Detail screen, select the system you want to unlock, and click **Unlock**.
4. To verify that the system is unlocked, click the **Network** folder.
5. Click the Padlock icon to display the lockout status. The system you unlocked should not have a red X displayed.

Running Online Diagnostics

Consider the following when you run the Online Diagnostics from a server or a disk:

- The diagnostics cannot be loaded and run from a disk until the AIX operating system has been installed and configured. After the installation of the AIX operating system, all three modes of operation are available.
- The diagnostics cannot be loaded on a system (client) from a server if that system is not set up to IPL from a server over a network, or the server has not been setup to send a service mode IPL of the diagnostics. When the system is set up to IPL from a server, the diagnostics are executed in the same manner as they are from disk.

- If the diagnostics were loaded from disk or a server, you must shut down the AIX operating system before powering off the system unit to prevent possible damage to disk data. This is done in one of two ways:
 - If the diagnostic programs were loaded in Standalone mode, press the F3 key until DIAGNOSTIC OPERATING INSTRUCTIONS displays; then follow the displayed instructions to shut down the AIX operating system.
 - If the diagnostic programs were loaded in maintenance or concurrent mode, enter the **shutdown -F** command.
- Under some conditions the system may stop, with instructions displayed on attached displays and terminals. Follow the instructions to select a console display.

Running the Diagnostics from a TTY Terminal

Consider the following when you run diagnostics using a TTY-type terminal as the console display:

- See the operator manual for your type of TTY terminal to find the key sequences you need to respond to the diagnostics. For the 3151, refer to the *3151 ASCII Display Station Guide to Operations*, form number GA18-2633. For the 3164, refer to the *3164 ASCII Color Display Station Description*, form number GA18-2617.
- When the diagnostics present display information through the S1 serial port, certain attributes are used. These attributes are set as if the diagnostics were using a 3161 display terminal. Refer to the tables in Appendix C, “General Attributes Required When Using a TTY Terminal” on page 165 for a list of attributes for the 3161 ASCII Display Terminal and for two other ASCII display terminals commonly used with the system.
- If you have a TTY terminal other than a 3151, 3161 or 3164 attached to the S1 serial port, your terminal may have different names for the attributes. Refer to the tables in Appendix C, “General Attributes Required When Using a TTY Terminal” on page 165, and use the attribute descriptions to determine the settings for your terminal.

Online Diagnostics Mode of Operation

The Online diagnostics can be run in three modes:

- *Service Mode* allows checking of most system resources.
- *Concurrent Mode* allows the normal system functions to continue while selected resources are being checked.
- *Maintenance Mode* allows checking of most system resources

Running the Online Diagnostics in Service Mode (Service Mode IPL)

Service mode provides the most complete checkout of the system resources. This mode also requires that no other programs be running on the system. All supported system resources except the SCSI adapter, and the disk drives used for paging can be tested. However, the system memory and the processor are only tested during power-on self-test (POST).

Error log analysis is done in service mode when you select the **Problem Determination** option on the DIAGNOSTIC MODE SELECTION menu.

To run the Online diagnostics in service mode, use the following steps:

1. Stop all programs including the AIX operating system (get help if needed).
2. Remove all tapes, diskettes, and CD-ROM discs.
3. Turn off the system unit power.
4. Turn on the system unit power.
5. After the first POST indicator appears on the system unit's console, press F6 on the directly-attached keyboard or 6 on the TTY keyboard to indicate that diagnostics are to load.

Note: The term *POST indicator* refers to the icons (graphic display) or device mnemonics (ASCII terminal) that are displayed while the POST is running.
6. Enter any requested password.
7. Follow any instructions to select a console.
8. After the diagnostic controller loads, DIAGNOSTIC OPERATING INSTRUCTIONS appear on the console display.
9. Follow the displayed instructions to test the desired resources.
10. When testing is complete; use the F3 key to return to the DIAGNOSTIC OPERATING INSTRUCTIONS.
11. Press the F3 key (from a defined terminal) or press 99 (for an undefined terminal) to shut down the diagnostics before turning off the system unit.

Note: Pressing the F3 key (from a defined terminal) produces a Confirm Exit menu which offers two options: continuing with the shut down by pressing F3; or returning to diagnostics by pressing Enter.

For undefined terminals, pressing 99 produces a full screen menu which offers two options: continuing with the shutdown by pressing 99 and then Enter; or returning to diagnostics by pressing Enter.

Running the Online Diagnostics in Concurrent Mode

Use Concurrent mode to run Online diagnostics on some of the system resources while the system is running normal system activity.

Because the system is running in normal operation, the following resources cannot be tested in concurrent mode:

- SCSI adapters connected to paging devices
- Disk drive used for paging
- Any graphics-related device running X, CDE, or windowing environment
- Memory
- Processor.

Three levels of testing exist in concurrent mode:

- The **share-test level** tests a resource while the resource is being shared by programs running in the normal operation. This testing is mostly limited to normal commands that test for the presence of a device or adapter.

- The **sub-test level** tests a portion of a resource while the remaining part of the resource is being used in normal operation. For example, this test could test one port of a multiport device while the other ports are being used in normal operation.
- The **full-test level** requires the device not be assigned to or used by any other operation. This level of testing on a disk drive might require the use of the **varyoff** command. The diagnostics display menus to allow you to vary off the needed resource.

Error log analysis is done in concurrent mode when you select the **Problem Determination** option on the DIAGNOSTIC MODE SELECTION menu.

To run the Online diagnostics in concurrent mode you must be logged onto the AIX operating system and have proper authority to issue the commands (if needed, get help).

The **diag** command loads the diagnostic controller and displays the Online diagnostic menus.

To run Online diagnostics in concurrent mode, use the following steps:

- Log on to the AIX operating system as root or use CE login.
- Enter the **diag** command.
- When the DIAGNOSTIC OPERATING INSTRUCTIONS display, follow the instructions to test the desired resources.
- When testing is complete, use the F3 key to return to the DIAGNOSTIC OPERATING INSTRUCTIONS. Press the F3 key again to return to the operating system prompt. Be sure to vary on any resource you had varied to off.
- Press the Ctrl-D key sequence to log off from root or superuser.

Running the Online Diagnostics in Maintenance Mode

Maintenance mode runs the Online diagnostics using the customer's version of the AIX operating system. This mode requires that all activity on the operating system be stopped so the Online diagnostics have most of the resources available to check. All of the system resources except the SCSI adapters, memory, processor, and the disk drive used for paging can be checked.

Error log analysis is done in maintenance mode when you select the **Problem Determination** option on the DIAGNOSTIC MODE SELECTION menu.

The **shutdown -m** command is used to stop all activity on the AIX operating system and put the operating system into maintenance mode. The **diag** command is then used to invoke the diagnostic controller so you can run the diagnostics. After the diagnostic controller is loaded, follow the normal diagnostic instructions.

To run the Online diagnostics in maintenance mode, you must be logged in to the customer's version of the AIX operating system as *root* or *superuser* and use the **shutdown -m** and **diag** commands. Use the following steps to run the Online diagnostics in maintenance mode:

1. Stop all programs except the AIX operating system (get help if needed).
2. Log in to the AIX operating system as root or superuser.
3. Enter the **shutdown -m** command.
4. When a message indicates the system is in maintenance mode, enter the **diag** command.

Note: It may be necessary to set *TERM* type again.

5. When DIAGNOSTIC OPERATING INSTRUCTIONS display, follow the displayed instructions to test the desired resources.
6. When testing is complete, use the F3 key to return to DIAGNOSTIC OPERATING INSTRUCTIONS. Then press the F3 key again to return to the AIX operating system prompt.
7. Press Ctrl-D to log off from root or superuser.

Standalone Diagnostic Operation

Use Standalone Diagnostics to test the system when the Online Diagnostics are not installed and as a method of testing the disk drives and other resources that can not be tested by the Online Diagnostics.

Note: Error Log Analysis is not done by the Standalone Diagnostics. If running from the diagnostic CD-ROM disc, the CD-ROM drive and the SCSI controller that controls it cannot be tested by the Standalone Diagnostics.

Running the Standalone Diagnostics

To run Standalone Diagnostics in service mode, use the following steps:

1. Stop all programs including the AIX operating system (get help if needed).
2. Remove all tapes, diskettes, and CD-ROMs.
3. Turn off the system unit power.
4. Turn on the system unit power.
5. Insert the diagnostic media.
6. When the keyboard POST indicator appears, press the F5 key on the directly attached keyboard, or the number 5 key on the TTY keyboard.
7. Enter any requested passwords.
8. Follow any instructions to select the console.
9. After the diagnostic controller loads, DIAGNOSTIC OPERATING INSTRUCTIONS appear on the console display.
10. Follow the displayed instructions to test the desired resources.
11. When testing is complete, use the F3 key to return to the DIAGNOSTIC OPERATING INSTRUCTIONS.

Chapter 6. Introducing Tasks and Service Aids

The AIX Diagnostic Package contains programs that are called Tasks. *Tasks* can be thought of as performing a specific function on a resource; for example, running diagnostics or performing a service aid on a resource. This chapter describes the tasks available in AIX Diagnostics Version 4.2 and later.

Note: Many of these programs work on all system model architectures. Some programs are only accessible from online diagnostics in service or concurrent mode, while others may be accessible only from Standalone Diagnostics. Still other programs may only be supported on a particular system architecture, such as CHRP (Common Hardware Reference Platform), or RSPC (PowerPC Reference Platform). The @server pSeries 610 Model 6C1 and Model 6E1 is a CHRP architecture system.

Use the FUNCTION SELECTION menu to perform tasks.

After a task is selected, a resource menu may be presented showing all resources supported by the task.

You can use a fast path method to perform a task by using the **diag** command and the **-T** flag. The fast-path tasks are as follows:

- Certify – certifies media
- Chkspares – checks for the availability of spare sectors
- Download – downloads microcode to an adapter or device
- Disp_mcode – displays current level of microcode
- Format – formats media
- Identify – identifies the PCI RAID physical disks

To run these tasks directly from the command line, specify the resource and other task-unique flags. Use the descriptions in this chapter to understand which flags are needed for a given task.

Tasks

The following tasks are described in this chapter:

- Add Resource to Resource List
- AIX Shell Prompt
- Analyze Adapter Internal Log
- Backup and Restore Media
- Certify Media
- Change Hardware Vital Product Data
- Configure Dials and LPFKeys
- Configure ISA Adapters
- Configure Reboot Policy
- Configure Remote Maintenance Policy
- Configure Ring Indicate Power On
- Configure Ring Indicate Power On Policy

- Configure Service Processor
- Configure Surveillance Policy
- Create Customized Configuration Diskette
- Delete Resource from Resource List
- Disk Maintenance
- Display Configuration and Resource List
- Display Firmware Device Node Information
- Display Hardware Error Report
- Display Hardware Vital Product Data
- Display Machine Check Error Log
- Display Microcode Level
- Display or Change Bootlist
- Display or Change Diagnostic Run Time Options
- Display Previous Diagnostic Results
- Display Resource Attributes
- Display Service Hints
- Display Software Product Data
- Display System Environmental Sensors
- Display Test Patterns
- Download Microcode
- Fibre Channel RAID Service Aids
- Flash SK-NET FDDI Firmware
- Format Media
- Generic Microcode Download
- Local Area Network Analyzer
- Log Repair Action
- Periodic Diagnostics
- PCI RAID Physical Disk Identify
- Process Supplemental Media
- Run Diagnostics
- Run Error Log Analysis
- Run Exercisers
- Save or Restore Hardware Management Policies
- Save or Restore Service Processor Configuration
- SCSI Bus Analyzer
- SCSI Device Identification and Removal
- SCSD Tape Drive Service Aid
- Spare Sector Availability
- SSA Service Aid
- Update Disk Based Diagnostics
- Update System or Service Processor Flash
- Update System Flash
- 7135 RAIDiant Array Service Aids
- 7318 Serial Communication Network Server

Add Resource to Resource List

Use this task to add resources back to the resource list.

Note: Only resources that were previously detected by the diagnostics and deleted from the Diagnostic Test List are listed. If no resources are available to be added, then none are listed.

AIX Shell Prompt

Note: Use this service aid in Online Service Mode only.

This service aid allows access to the AIX command line. To use this service aid, the user must know the root password (when a root password has been established).

Note: Do not use this task to install code or to change the configuration of the system. This task is intended to view files, configuration records, and data. Using this service aid to change the system configuration or install code might result in unexplained system problems after exiting the diagnostics.

Analyze Adapter Internal Log

The PCI RAID adapter has an internal log that logs information about the adapter and the disk drives attached to the adapter. Whenever data is logged in the internal log, the device driver copies the entries to the AIX system error log and clears the internal log.

The Analyze Adapter Internal Log service aid analyzes these entries in the AIX system error log. The service aid displays the errors and the associated service actions. Entries that do not require any service actions are ignored.

Backup and Restore Media

This service aid allows verification of backup media and devices. It presents a menu of tape and diskette devices available for testing and prompts for selecting the desired device. It then presents a menu of available backup formats and prompts for the desired format. The supported formats are **tar**, **backup**, and **cpio**. After the device and format are selected, the service aid backs up a known file to the selected device, restores that file to **/tmp**, and compares the original file to the restored file. The restored file remains in **/tmp** to allow for visual comparison. All errors are reported.

Certify Media

This task allows the selection of diskette, DVD-RAM media or hard files to be certified. Normally, this is done for the following two conditions:

- To determine the condition of the drive and media.
- To verify that the media is error free after a Format Service Aid has been run on the media.

Normally, one would run certify if after running diagnostics on a drive and its media, no problem is found, but one still suspects that a problem still does exist.

Hard files can be connected either to a SCSI adapter (non-RAID) or a PCI SCSI RAID adapter. The usage and criteria for a hard file connected to a non-RAID SCSI adapter are different from those for a hard file connected to a PCI SCSI RAID adapter.

Certify may be used in the following ways:

- **Certify Diskette**

This selection enables you to verify the data written on a diskette. When you select this service aid, a menu asks you to select the type of diskette being verified. The program then reads all of the ID and data fields on the diskette one time and displays the total number of bad sectors found.

- **Certify DVD-RAM media**

This selection reads all of the ID and data fields. It checks for bad data and counts all errors encountered. If an unrecovered error occurs, or recovered errors exceed the threshold value, the data on the media should be transferred to other media and the original media should be discarded.

The Certify service aid will display the following information:

- Capacity in bytes
- Number of Data Errors Not Recovered
- Number of Equipment Check Errors
- Number of Recovered Errors

If the drive is reset during a certify operation, the operation is restarted.

If the drive is reset again, the certify operation is terminated and the user is asked to run diagnostics on the drive.

This task can be run directly from the AIX command line. See the following command syntax: `diag -c -d -T certify`

Flag	Description
-c	No console mode
-d	Specifies a device
-T	Specifies the certify task

- **Certify Hardfile Attached to a Non-RAID SCSI Adapter**

This selection reads all of the ID and data fields. It checks for bad data and counts all errors encountered. If there are unrecovered data errors that do not exceed the threshold value, then the hard file needs to be formatted and certified. If the unrecovered data errors, recovered data errors, recovered and unrecovered equipment errors exceed the threshold values, the disk needs to be replaced.

It also makes 2000 random seeks after the read certify of the surface completes. If a disk timeouts before finishing the random seeks, then the disk needs to be replaced. The random seeks also count all errors encountered.

The Certify service aid will display the following information:

- Drive capacity in megabytes.
- Number of Data Errors Recovered.
- Number of Data Errors Not Recovered.
- Number of Equipment Checks Recovered.

- Number of Equipment Checks Not Recovered.

This task can be run directly from the AIX command line. See the following command syntax: `diag -c -d deviceName -T "certify"`

Flag	Description
-c	No console mode
-d	Specifies a device
-T	Specifies the certify task

- Format and/or Erase Hardfile Attached to a Non-RAID SCSI Adapter

Warning: The following commands WILL change the content of the hardfile. Be sure to backup data prior to running the command, and take care in choosing the hardfile upon which you run this task.

- Hardfile Format

Writes all of the disk. The pattern written on the disk is device-dependant; for example, some drives may write all 0s, while some may write the hexadecimal number 5F. No bad block reassignment occurs.

- Hardfile Format and Certify

Performs the same function as Hardfile Format. After the format is completed, Certify is run. Certify then reassigns all bad blocks encountered.

- Hardfile Erase Disk

This option can be used to overwrite (remove) all data currently stored in user-accessible blocks of the disk. The Erase Disk option writes one or more patterns to the disk. An additional option allows data in a selectable block to be read and displayed on the system console.

To use the Erase Disk option, specify the number (0-3) of patterns to be written. The patterns are written serially; that is, the first pattern is written to all blocks. Then the next pattern is written to all blocks, overlaying the previous pattern. A random pattern is written by selecting the Write Random Pattern option.

Note: The Erase Disk service aid has not been certified as meeting the Department of Defense or any other organization's security guidelines.

Use the following steps to overwrite the data on the drive:

1. Use the Erase Disk selection to overwrite the data on the drive.
2. Do a format without certify.
3. Run a second pass of the Erase Disk selection.

For a newly installed drive, you can ensure that all blocks on the drive are overwritten with your pattern if you use the following procedure:

1. Format the drive.
2. Check the defect MAP by running the Erase Disk selection.

Note: If you use Format and Certify option, there may be some blocks which get placed into the grown defect MAP.

3. If there are bad blocks in the defect MAP, record the information presented and ensure that this information is kept with the drive. This data is used later when the drive is to be overwritten.
4. Use you drive as you would normally.
5. When the drive is no longer needed and is to be erased, run the same version of the Erase Disk selection which was used in step 2.

Note: Using the same version of the service aid is only critical if any bad blocks were found in step 3.

6. Compare the bad blocks which were recorded for the drive in step 3 with those that now appear in the grown defect MAP.

Note: If there are differences between the saved data and the newly obtained data, then all sectors on this drive cannot be overwritten. The new bad blocks are not overwritten.

7. If the bad block list is the same, continue running the service aid to overwrite the disk with the chosen pattern(s).

This task can be run directly from the AIX command line. See the command syntax: `diag -c -d deviceName -T "format [-s* fmtcert | erase -a {read | write}] [-F]*`

Flag	Description
fmtcert	Formats and certifies the disk.
erase	Overwrites the data on the disk.
*	Available in no-console mode only.
-F	Force the disk erasure even if all blocks cannot be erased due to errors accessing the grown defect map.

Note: The Erase Disk option in command line mode uses default values. To selectively read or write, use the **diag** command in console mode.

- Certify Hardfile attached to a PCI SCSI RAID Adapter

This selection is used to certify physical disks attached to a PCI SCSI RAID adapter. Certify reads the entire disk and checks for recovered errors, unrecovered errors, and reassigned errors. If these errors exceed the threshold values, the user is prompted to replace the physical disk.

This task can be run directly from the AIX command line. See the following command syntax: `diag -c -d RAIDadapterName -T "certify {-l chID | -A}"`

Flag	Description
-c	No console mode
-d	Specifies the RAID adapter to which the disk is attached
-T	Specifies the certify task and its parameters
-l	Specifies physical Disk channel/ID (example: -l 27)
-A	All disks

Change Hardware Vital Product Data

Use this service aid to display the Display/Alter VPD Selection Menu. The menu lists all resources installed on the system. When a resource is selected, a menu displays that lists all the VPD for that resource.

Note: The user cannot alter the VPD for a specific resource unless it is not machine readable.

Configure Dials and LPF Keys

Note: The Dials and LPF Keys service aid is not supported in standalone mode (CD-ROM and NIM) on systems with 32 MB or less memory. If you have problems in standalone mode, use the hardfile-based diagnostics.

This service aid provides a tool for configuring and removing dials and LPF keys to the asynchronous serial ports.

This selection invokes the SMIT utility to allow Dials and LPF keys configuration. A TTY must be in the available state on the async port before the Dials and LPF keys can be configured on the port. The task allows an async adapter to be configured, then a TTY port defined on the adapter. Dials and LPF keys can then be defined on the port.

Before configuring Dials or LPF keys on a serial port, you must remove all defined TTYs. To determine if there are any defined TTYs, select **List All Defined TTYs**. Once all defined TTYs have been removed, then add a new TTY and configure the Dials or LPF keys.

Configure ISA Adapter

This task uses SMIT to identify and configure ISA adapters on systems that have an ISA bus and adapters.

Diagnostic support for ISA adapters not shown in the list may be supported from a supplemental diskette. You can use the Process Supplemental Media task to add ISA adapter support from a supplemental diskette.

Whenever an ISA adapter is installed, this service aid must be run and the adapter configured before the adapter can be tested. You must also run this service aid to remove an ISA adapter from the system whenever an ISA adapter is physically removed from the system.

If diagnostics are run on an ISA adapter that has been removed from the system, the diagnostics fail because the system cannot detect the ISA adapter.

Configure Reboot Policy

This service aid controls how the system tries to recover from a system crash. Use this service aid to display and change the following settings for the Reboot Policy.

Note: Some of the following settings might not be displayed by this service aid.

- Maximum Number of Reboot Attempts
Enter a number that is 0 or greater.

Note: A value of 0 indicates 'do not attempt to reboot' to a crashed system.

This number is the maximum number of consecutive attempts to reboot the system. The term *reboot*, in the context of this service aid, is used to describe bringing system hardware back up from scratch, for example from a system reset or power on.

When the reboot process completes successfully, the reboot attempts count is reset to 0, and a *restart* begins. The term *restart*, in the context of this service aid, is used to describe the operating system activation process. Restart always follows a successful reboot.

When a restart fails, and a restart policy is enabled, the system attempts to reboot for the maximum number of attempts.

- Use the O/S Defined Restart Policy (1=Yes, 0=No)

When 'Use the O/S Defined Restart Policy' is set to Yes, the system attempts to reboot from a crash if the operating system has an enabled Defined Restart or Reboot Policy.

When 'Use the O/S Defined Restart Policy' is set to No, or the operating system restart policy is undefined, then the restart policy is determined by the 'Supplemental Restart Policy'.

- Enable Supplemental Restart Policy (1=Yes, 0=No)

The 'Supplemental Restart Policy', if enabled, is used when the O/S Defined Restart Policy is undefined, or is set to False.

When surveillance detects operating system inactivity during restart, an enabled 'Supplemental Restart Policy' causes a system reset and the reboot process begins.

- Call-Out Before Restart(on/off)

When enabled, Call-Out Before Restart allows the system to call out (on a serial port that is enabled for call out) when an operating system restart is initiated. Such calls can be valuable if the number of these events becomes excessive, thus signalling bigger problems.

- Enable Unattended Start Mode (1=Yes, 0=No)

When enabled, 'Unattended Start Mode' allows the system to recover from the loss of ac power.

If the system was powered on when the ac loss occurred, the system reboots when power is restored. If the system was powered off when the ac loss occurred, the system remains off when power is restored.

You can access this service aid directly from the AIX command line by typing:
`/usr/lpp/diagnostics/bin/uspchrp -b`

Configure Remote Maintenance Policy

The Remote Maintenance Policy includes modem configurations and phone numbers to use for remote maintenance support. Use this service aid to display and change the following settings for the Remote Maintenance Policy.

Note: Some of the following settings may not be displayed by this service aid.

- Configuration File for Modem on S1 Configuration File for Modem on S2
Enter the name of a modem configuration file to load on either serial port 1 (S1) or serial port 2 (S2). The modem configuration files are located in the directory **/usr/share/modems**. If a modem file is already loaded, a Modem file currently Loaded message displays.

- Modem file currently loaded on S1 Modem file currently loaded on S2
This is the name of the file that is currently loaded on serial port 1 or serial port 2.

Note: These settings are only shown when a modem file is loaded for a serial port.

- Call In Authorized on S1 (on/off) Call In Authorized on S2 (on/off)
Call In allows the Service Processor to receive a call from a remote terminal.
- Call Out Authorized on S1 (on/off) Call Out Authorized on S2 (on/off)
Call Out allows the Service Processor to place calls for maintenance.
- S1 Line Speed S2 Line Speed
A list of line speeds is available by using 'List' on the screen.
- Service Center Phone Number
Telephone number of the service center computer. The service center usually includes a computer that takes calls from systems with call-out capability. This computer is referred to as the *catcher*. The catcher expects messages in a specific format to which the Service Processor conforms. For more information about the format and catcher computers, refer to the README file in the AIX **/usr/samples/syscatch** directory. Contact the service provider for the correct telephone number to enter here.
- Customer Administration Center Phone Number
Telephone number of the System Administration Center computer (catcher) that receives problem calls from systems. Contact the system administrator for the correct telephone number to enter here.
- Digital Pager Phone Number In Event of Emergency
Number for a pager carried by someone who responds to problem calls from your system.
- Customer Voice Phone Number
Telephone number for a telephone near the system, or answered by someone responsible for the system. This is the telephone number left on the pager for callback.

- Customer System Phone Number
Telephone number to which your system's modem is connected. The service or administration center representatives need this number to make direct contact with your system for problem investigation. This is also referred to as the *Call-in phone number*.
 - Customer Account Number
This number is available for service providers to use for record keeping and billing.
 - Call Out Policy-Numbers to call if failure
This is set to either first or all. If the call-out policy is set to first, call out stops at the first successful call to one of the following numbers in the order listed:
 1. Service Center
 2. Customer Administration Center
 3. Pager

If Call Out Policy is set to all, call-out attempts to call all of the following numbers in the order listed:

 1. Service Center
 2. Customer Administration Center
 3. Pager
 - Customer RETAIN Login ID Customer RETAIN Login Password
These settings apply to the RETAIN service function.
 - Remote Timeout, in seconds Remote Latency, in seconds
These settings are functions of the service provider's catcher computer.
 - Number of Retries While Busy
This is the number of times the system should retry calls that resulted in busy signals.
 - System Name (System Administrator Aid)
Name given to the system and is used when reporting problem messages.
- Note:** If you provide the system name, your support team can quickly identify the location, configuration, and history of your system.

You can access this service aid directly from the AIX command line by typing:

```
/usr/lpp/diagnostics/bin/uspchrp -m
```

Configure Ring Indicate Power On Policy

Note: This service aid runs on CHRP system units only.

This service aid allows the user to power-on a system by telephone from a remote location. If the system is powered off, and Ring Indicate Power On is enabled, the system powers on at a predetermined number of rings. If the system is already on, no action is taken. In either case, the telephone call is not answered, and the caller receives no feedback that the system has powered on.

Use this service aid to display and change the following settings for the Ring Indicate Power On Policy.

Note: Some of the following settings may not be displayed by this service aid.

- Power On Via Ring Indicate (on/off)
- Number of Rings until Power On

You can access this service aid directly from the AIX command line by typing:
`/usr/lpp/diagnostics/bin/uspchrp -r`

Configure Surveillance Policy

This service aid monitors the system for hang conditions; that is, hardware or software failures that cause operating system inactivity. When enabled, and surveillance detects operating system inactivity, a call is placed to report the failure.

Use this service aid to display and change the following settings for the Surveillance Policy.

Note: Some of the following settings may not be displayed by this service aid.

- Surveillance (on/off)
- Surveillance Time Interval
Maximum time between heartbeats from the operating system.
- Surveillance Time Delay
Time to delay between when the operating system is in control and when to begin operating system surveillance.
- Changes are to take effect immediately
Set this to Yes if the changes made to the settings in this menu are to take place immediately. Otherwise, the changes take effect beginning with the next system boot.

You can access this service aid directly from the AIX command line by entering:
`/usr/lpp/diagnostics/bin/uspchrp -s`

Create Customized Configuration Diskette

This selection invokes the Diagnostic Package Utility Service Aid, which allows the user to create a Standalone diagnostic package configuration diskette.

The Standalone Diagnostic Package Configuration Diskette allows the following to be changed from the console:

- Default refresh rate for an LFT (Limited Function Terminal)
The refresh rate used by the Standalone diagnostic package is 60Hz. If the display's refresh rate is 77Hz, set the refresh rate to 77.

- Different async terminal console

Use this service aid to create a console configuration file that allows a terminal attached to any RS232 or RS422 adapter to be selected as a console device. The default device is RS232 TTY attached to the first standard serial port (S1).

Delete Resource from Resource List

Use this task to delete resources from the resource list.

Note: Only resources that were previously detected by the diagnostics and have not been deleted from the Diagnostic Test List are listed. If no resources are available to be deleted, then none are listed.

Disk Maintenance

This service aid provides the following options for the fixed-disk maintenance:

- Disk to Disk Copy
- Display/Alter Sector

Disk to Disk Copy

Notes:

1. This service aid cannot be used to update to a different size drive. The service aid only supports copying from a SCSI drive to another SCSI drive of similar size.
2. Use the **migratepv** command when copying the contents to other disk drive types. This command also works when copying SCSI disk drives or when copying to a different size SCSI disk drive. Refer to *System Management Guide: Operating System and Devices* for a procedure on migrating the contents of a physical volume.

This publication is located on the *AIX Documentation* CD. The documentation information is made accessible by loading the documentation CD onto the hard disk or by mounting the CD in the CD-ROM drive.

This selection allows you to recover data from an old drive when replacing it with a new drive. The service aid recovers all logical volume manager (LVM) software reassigned blocks. To prevent corrupted data from being copied to the new drive, the service aid

stops if an unrecoverable read error is detected. To help prevent possible problems with the new drive, the service aid stops if the number of bad blocks being reassigned reaches a threshold.

To use this service aid, both the old and new disks must be installed in or attached to the system with unique SCSI addresses. This requires that the new disk drive SCSI address must be set to an address that is not currently in use and the drive be installed in an empty location. If there are no empty locations, then one of the other drives must be removed. When the copy is complete, only one drive can remain installed. Either remove the target drive to return to the original configuration, or perform the following procedure to complete the replacement of the old drive with the new drive:

1. Remove both drives.
2. Set the SCSI address of the new drive to the SCSI address of the old drive.
3. Install the new drive in the old drive's location.
4. Install any other drives (that were removed) into their original location.

To prevent problems that can occur when running this service aid from disk, it is suggested that this service aid be run, when possible, from the diagnostics that are loaded from removable media.

Display/Alter Sector

Note: Use caution when you use this service aid because inappropriate modification to some disk sectors can result in the total loss of all data on the disk.

This selection allows the user to display and alter information on a disk sector. Sectors are addressed by their decimal sector number. Data is displayed both in hex and in ASCII. To prevent corrupted data from being incorrectly corrected, the service aid does not display information that cannot be read correctly.

Display Configuration and Resource List

If a device is not included in the Test List or if you think a Diagnostic Package for a device is not loaded, check by using the Display Configuration and Resource List task. If the device you want to test has a plus (+) sign or a minus (-) sign preceding its name, the Diagnostic Package is loaded. If the device has an asterisk (*) preceding its name, the Diagnostic Package for the device is not loaded or is not available.

This service aid displays the item header only for all installed resources. Use this service aid when there is no need to see the vital product data (VPD). (No VPD is displayed.)

Display Firmware Device Node Information

This task displays the firmware device node information that appears on CHRP platforms. This service aid is intended to gather more information about individual or particular devices on the system. The format of the output data may differ depending on which level of the AIX operating system is installed.

Display Hardware Error Report

This service aid uses the **errpt** command to view the hardware error log.

The Display Error Summary and Display Error Detail selection provide the same type of report as the **errpt** command. The Display Error Analysis Summary and Display Error Analysis Detail selection provide additional analysis.

Display Hardware Vital Product Data

This service aid displays all installed resources, along with any VPD (Vital Product Data) for those resources. Use this service aid when you want to look at the VPD for a specific resource.

Display Machine Check Error Log

Note: The Machine Check Error Log Service Aid is available only on Standalone Diagnostics.

When a machine check occurs, information is collected and logged in an NVRAM error log before the system unit shuts down. This information is logged in the AIX error log and cleared from NVRAM when the system is rebooted from the hard disk, LAN, or Standalone media. When booting from Standalone Diagnostics, this service aid can convert the logged information into a readable format that can help to isolate the problem. When booting from the hard disk or LAN, the information can be viewed from the AIX error log, using the Hardware Error Report Service Aid. In either case, the information is analyzed when running the **sysplanar0** diagnostics in Problem Determination Mode.

Display Microcode Level

This task is used to display the microcode or firmware levels of currently installed resources. When the **sys0** resource is selected, the task displays the levels of both the system firmware and service processor firmware. **sys0** may not be available in all cases.

You can display the current level of the microcode on an adapter, the system, or a device by using the AIX **diag** command. See the following command syntax: `diag -c -d device -T "disp_mcode"`

Flag	Description
-c	No console mode.
-d	Used to specify a device.
-T	Use the <code>disp_mcode</code> option to display microcode.

Display or Change Bootlist

This service aid allows the bootlist to be displayed, altered, or erased.

The system attempts to perform an IPL from the first device in the list. If the device is not a valid IPL device or if the IPL fails, the system proceeds in turn to the other listed devices to attempt an IPL.

Display or Change Diagnostic Run-Time Options

The Display or Change Diagnostic Run-Time Options task allows the diagnostic run-time options to be set.

Note: The run-time options are used only when selecting the Run Diagnostic task.

The run-time options are:

- Display Diagnostic Mode Selection Menus
This option allows the user to enable displaying THE DIAGNOSTIC MODE SELECTION MNU (the default is off).
- Run Tests Multiple Times
This option allows the user to enable running the diagnostic in loop mode (the default is off).

Note: This option is only displayed when you run Online Diagnostics in Service Mode.
- Include Advanced Diagnostics
This option allows the user to enable including the Advanced Diagnostics (the default is off).
- Include Error Log Analysis
This option allows the user to enable including the Error Log Analysis (ELA) (the default is off).
- Number of Days Used to Search Error Log
This option allows the user to select the number of days to search the AIX error log for errors when running the Error Log Analysis. The default is 7 days, but it can be changed from 1 to 60 days.
- Display Progress Indicators
This option allows the user to enable the progress indicators when running the Diagnostic Applications. The progress indicators display at the bottom of the screen, which indicate that the test being run (the default is on).
- Diagnostic Event Logging
This option allows the user to enable logging information to the Diagnostic Event Log (the default is on).
- Diagnostic Event Log File Size

This option allows the user to select the maximum size of the Diagnostic Event Log. The default size for the Diagnostic Event Log is 100 KB. The size can be increased in 100 KB increments to a maximum of 1 MB.

Display Previous Diagnostic Results

Note: This service aid is not available when you load the diagnostics from a source other than a hard disk drive or a network.

This service aid allows a service representative to display results from a previous diagnostic session. When the Display Previous Diagnostic Results option is selected, the user can view up to 25 no trouble found (NTF) and service request number (SRN) results.

This service aid displays Diagnostic Event Log information, which can be displayed in either short or long version. The information is displayed in reverse chronological order.

This information is not from the AIX operating system error log. This information is stored in the **/var/adm/ras** directory.

You can run the command from the AIX command line by typing:

```
/usr/lpp/diagnostics/bin/diagrpt [[-o] | [-smmddy mmddy] | [-a] | [-r]]
```

Flag	Description
-o	Displays the last diagnostic results file stored in the /etc/lpp/diagnostics/data directory
-s mmddy	Displays all diagnostic result files logged since the date specified
-a	Displays the long version of the Diagnostic Event Log
-r	Displays the short version of the Diagnostic Event Log

Display Resource Attributes

This task displays the Customized Device Attributes associated with a selected resource. This task is similar to running the **lsattr -E -I resource** command.

Display Service Hints

This service aid reads and displays the information in the CEREADE file from the diagnostics media. This file contains information that is not contained in the publications for this version of the diagnostics. The file also contains information about using this particular version of diagnostics.

Use the arrow keys to scroll through the information in the file.

Display Software Product Data

This task uses SMIT to display information about the installed software and provides the following functions:

- List Installed Software
- List Applied but Not Committed Software Updates
- Show Software Installation History
- Show Fix (APAR) Installation Status
- List Fileset Requisites
- List Fileset Dependents
- List Files Included in a Fileset
- List File Owner by Fileset

Display System Environmental Sensors

This service aid displays the environmental sensors implemented on a CHRP system. The information displayed is the sensor name, physical location code, literal value of the sensor status, and the literal value of the sensor reading.

The sensor status can be any one of the following:

- **Normal** – The sensor reading is within the normal operating range.
- **Critical High** – The sensor reading indicates a serious problem with the device. Run diagnostics on sysplanar0 to determine what repair action is needed.
- **Critical Low** – The sensor reading indicates a serious problem with the device. Run diagnostics on sysplanar0 to determine what repair action is needed.
- **Hardware Busy** – The system has repeatedly returned a busy indication, and a reading is not available. Try the service aid again. If the problem continues, run diagnostics on sysplanar0 in problem determination mode to determine what repair action is needed.
- **Hardware Error** - The sensor could not be read because of a hardware error. Run diagnostics on sysplanar0 in problem determination mode to determine what repair action is needed.
- **Warning High** – The sensor reading indicates a problem with the device. This could become a critical problem if action is not taken. Run diagnostics on sysplanar0 to determine what repair action is needed.
- **Warning Low** – The sensor reading indicates a problem with the device. This could become a critical problem if action is not taken. Run diagnostics on sysplanar0 to determine what repair action is needed.

This service aid can also be run as a command. Use the command to list the sensors and their values in a text format, list the sensors and their values in numerical format, or a specific sensor can be queried to return either the sensor status or sensor value.

Run the command by entering one of the following:

Note: These commands work only when the flags are entered one at a time (such as those shown in Examples 1 and 2).

```
/usr/lpp/diagnostics/bin/uesensor -l | -a /usr/lpp/diagnostics/bin/uesensor -t  
token -i index [-v]
```

Flag	Description
------	-------------

-l	List the sensors and their values in a text format.
----	---

-a	List the sensors and their values in a numerical format. For each sensor, the following numerical values are displayed as:
----	--

```
token index status measured value  
location code
```

-t token	Specifies the sensor token to query.
----------	--------------------------------------

-i index	Specifies the sensor index to query.
----------	--------------------------------------

-v	Indicates to return the sensor measured value. The sensor status is returned by default.
----	--

Examples

1. Display a list of the environmental sensors:

```
/usr/lpp/diagnostics/bin/uesensor -l
```

Following is the result of running the example command only:

```
Sensor = Fan Speed  
Status = Normal  
Value = 2436 RPM  
Location Code = F1  
Sensor = Power Supply  
Status = Normal  
Value = Present and operational  
Location Code = V1  
Sensor = Power Supply  
Status = Critical low  
Value = Present and not operational  
Location Code = V2
```

2. Display a list of the environmental sensors in a numerical list:

```
/usr/lpp/diagnostics/bin/uesensor -a
```

Following is the result of running the example command only:

```
3 0 11 87 P1  
9001 0 11 2345 F1  
9004 0 11 2 V1  
9004 1 9 2 V2
```

3. Return the status of sensor 9004, index 1:

```
/usr/lpp/diagnostics/bin/uesensor -t 9004 -i 1
```

Following is the result of running the example command only:

```
9
```

- Return the value of sensor 9004, index 1:

```
/usr/lpp/diagnostics/bin/uesensor -t 9004 -i 1 -v
```

Following is the result of running the example command only:
2

Display Test Patterns

This service aid provides a means of adjusting system display units by providing displayable test patterns. You can select the display type and test pattern. After you make the selections, the test pattern displays.

Download Microcode

This service aid provides a way to copy microcode to an adapter or device. The service aid presents a list of adapters and devices that use microcode. After the adapter or device is selected, the service aid provides menus to guide you in checking the current level and downloading the needed microcode.

This task can be run directly from the AIX command line. See the following sections for instructions on downloading to a particular type adapter or device.

Download Microcode to PCI SCSI RAID Adapter

See the following command syntax for a PCI SCSI RAID Adapter:

```
diag -c -d RAIDadapterName -T "download [-B] [-D] [-P]"
```

Flag	Description
-B	Download boot block microcode (default to functional microcode)
-D	Microcode is on diskette (default to /etc/microcode directory)
-P	Download the previous level of microcode (default to latest level)

Download Microcode to Disk Drive Attached to a PCI SCSI RAID Adapter

See the following command syntax for a disk drive attached to a PCI SCSI RAID Adapter:

```
diag -c -d RAIDadapterName -T "download {-l chID | -A} [-D] [-P]"
```

Flag	Description
-A	All disk drives
-D	Microcode is on diskette (default to /etc/microcode directory)
-I	RAID disk drive-physical disk channel/ID (example 27)
-P	Download the previous level of microcode (default to latest level)

Download Microcode to a PCI FC-AL Adapter

Microcode installation occurs while the adapter and attached drives are available for use. It is recommended that a current backup be available and the installation be scheduled during a non-peak production time period.

Note: If the source is diskette, the diskette must be in a backup format and the image stored in the **/etc/microcode** directory.

See the following command syntax for a PCI FC-AL Adapter.

```
diag -c -d device_name -T "download [-s {/etc/microcode|diskette}] [-l {latest|previous}] [-f]"
```

Flag	Description
-c	No console mode. Run without user interaction.
-d	Device name is the name of the adapter.
-T	Use the download option to download microcode.
-s	Source of the new microcode image. Default is <code>/etc/microcode</code> .
-l	Level of microcode to install. The default is latest.
-f	Force the installation even if the current level of microcode is not on the source.

Download Microcode to DVD-RAM Attached to a PCI SCSI Adapter

See the following command syntax for a DVD-RAM attached to a PCI SCSI Adapter:

```
diag [-c] -d cdX -T "download [-s {/etc/microcode|diskette}] [-l {latest|previous}] [-f]"
```

Flag	Description
-c	No console mode. Run without user interaction
cdX	Device selected, for example, cd0.
-s	Source of the new microcode. The default is <code>/etc/microcode</code> .
-l	Level of microcode image to be installed. Latest in default
-f	Install the microcode on the device even if the current level is unavailable on the source.

Download Microcode to Disk Attached to PCI SCSI Adapter

See following command syntax for a disk drive attached to a PCI SCSI adapter:

```
diag [-c] -d hdiskX -T "download [-s {/etc/microcode|diskette}] [-l {latest|previous}] [-f]"
```

Flag	Description
-c	No console mode. Run without user interaction
-d <i>hdiskX</i>	Selected device, for example, hdisk0.
-T <i>download</i>	Download microcode task.
-s	Source of the new microcode. The default is <code>/etc/microcode</code> .
-l	Level of microcode image to be installed. Latest in default
-f	Install the microcode on the device even if the current level is unavailable on the source.

Download Microcode to Other Devices

See the following command syntax:

```
diag -c -d device_name -T "download [-s diskette] [-l previous] [-F]"
```

Flag	Description
-F	Force the download microcode even if the current level is unavailable on the source.
-l	Microcode level. Latest is default.

- s Source of the new microcode. The default is **/etc/microcode**. Default source device is disk.

Fibre Channel RAID Service Aids

The Fibre Channel RAID (Redundant Array Independent Disk) service aids contain the following functions:

Certify LUN

This selection reads and checks each block of data in the LUN (Logical Unit Number). If excessive errors are encountered the user is notified.

You can run this task from the AIX command line. The syntax of the fastpath command is as follows: `diag -T "certify"`

Certify Spare Physical Disk

This selection allows the user to certify (check integrity of the data) on drives that are designated as spares.

You can run this task from the AIX command line. The syntax of the fastpath command is as follows: `diag -T "certify"`

Format Physical Disk

This selection formats a selected disk drive.

You can run this task from the AIX command line. The syntax of the fastpath command is as follows: `diag -T "format"`

Array Controller Microcode Download

This selection allows the microcode on the Fibre Channel RAID controller to be updated when required.

You can run this task from the AIX command line. The syntax of the fastpath command is as follows: `diag -T "download"`

Physical Disk Microcode Download

This selection is used to update the microcode on any of the disk drives in the array.

You can run this task from the AIX command line. The syntax of the fastpath command is as follows: `diag -T "download"`

Update EEPROM

This selection is used to update the contents of the EEPROM (Electrically Erasable Programmable Read Only Memory) on a selected controller.

Replace Controller

Use this selection when it is necessary to replace a controller in the array.

Flash SK-NET FDDI Firmware

This task allows the Flash firmware on the SysKconnect SK-NET FDDI adapter to be updated.

Format Media

This task allows the selection of diskettes, hardfiles, or optical media to be formatted. Each selection is described below.

Hardfile Attached to SCSI Adapter (non-RAID)

- **Hardfile Format**
Writes all of the disk. The pattern written on the disk is device-dependent; for example some drives may write all 0s, while some may write the hexadecimal number 5F. No bad block reassignment occurs
- **Hardfile Format and Certify**
Performs the same function as Hardfile Format. After the format is completed, Certify is run. Certify then reassigns all bad blocks encountered.
- **Hardfile Erase Disk**
This option can be used to overwrite (remove) all data currently stored in user-accessible blocks of the disk. The **Erase Disk** option writes one or more patterns to the disk. An additional option allows data in a selectable block to be read and displayed on the system console.

To use the **Erase Disk** option, specify the number (0-3) of patterns to be written. The patterns are written serially; that is, the first pattern is written to all blocks. Then the next pattern is written to all blocks, overlaying the previous pattern. A random pattern is written by selecting the **Write Random Pattern?** option.

Note: The Erase Disk service aid has not been certified as meeting the Department of Defense or any other organization's security guidelines.

Use the following steps to overwrite the data on the drive:

1. Use the **Erase Disk** selection to overwrite the data on the drive.
2. Do a format without certify.
3. Run a second pass of the **Erase Disk** selection.

For a newly installed drive, you can ensure that all blocks on the drive are overwritten with your pattern if you use the following procedure:

1. Format the drive.
2. Check the defect MAP by running the **Erase Disk** selection.

Note: If you use the **Format and Certify** option, there may be some blocks which get placed into the grown defect MAP.

3. If there are bad blocks in the defect MAP, record the information presented and ensure that this information is kept with the drive. This data is used later when the drive is to be overwritten.
4. Use the drive as you would normally.

- When the drive is no longer needed and is to be erased, run the same version of the **Erase Disk** selection which was used in step 2.

Note: Using the same version of the service aid is only critical if any bad blocks were found in step 3.

- Compare the bad blocks which were recorded for the drive in step 3 with those that now appear in the grown defect MAP.

Note: If there are differences between the saved data and the newly obtained data, then all sectors on this drive cannot be overwritten. The new bad blocks are not overwritten.

- If the bad block list is the same, continue running the service aid to overwrite the disk with the chosen pattern(s).

This task can be run directly from the AIX command line. See the command syntax:
`diag -c -d deviceName -T "format [-s* fmtcert | erase -a {read | write}] [-F]"`

Flag	Description
------	-------------

fmtcert	Formats and certifies the disk.
----------------	---------------------------------

*	Available in no-console mode only.
---	------------------------------------

-F	Force the disk erasure even if all blocks cannot be erased due to errors accessing grown defect map.
-----------	--

Note: The Erase Disk option in command line mode uses default values. To selectively read or write, use the **diag** command in console mode.

Hardfile Attached to PCI SCSI RAID Adapter

This function formats the physical disks attached to a PCI SCSI RAID adapter. This task can be run directly from the AIX command line. The syntax of the command is as follows: `diag -c -d RAID adapterName -T "format {-l chId | -A }"`

Flag	Description
------	-------------

-l	Physical disk channel/ID (An example of physical disk channel/ID is 27, where the channel is 2 and the ID is 7.)
-----------	--

-A	All disks
-----------	-----------

Optical Media

This function formats the media with or without certifying.

- Optical Media Initialize

Formats the media without certifying. This function does not reassign the defective blocks or erase the data on the media. It provides a quick way of formatting the media and cleaning the disk.

Note: It takes approximately one minute to format the media.

- Optical Media Format and Certify

Formats and certifies the media. This function reassigns the defective blocks and erases all data on the media.

This task can be run directly from the AIX command line. The following usage statement describes the syntax of the command: `diag -c -d deviceName -T "format [-s {initialize | fmtcert}]"`

Option	Description
initialize	Formats media without certifying
fmtcert	Formats and certifies the media

Diskette Format

This selection formats a diskette by writing patterns to it.

Gather System Information

This service aid uses the AIX `snap` command to collect configuration information on networks, filesystems, security, the kernel, the ODM, and other system components. You can also choose to collect SSA adapter and disk drive configuration data, or AIX trace information for software debugging.

The output of the SNAP service aid can be used by field service personnel or it can be put on removable media and transferred to remote locations for more extensive analysis.

To use the SNAP task, select Gather System Information from the task list. You can select which components you want to collect information for, and where to store the data (hard disk or removable media).

Generic Microcode Download

This service aid provides a means of executing a generic script from a diskette. The intended purpose for this generic script is to load microcode to a supported resource. This script can run whatever program is required to download the microcode onto the adapter or device.

This service aid is supported in both concurrent and Standalone modes from disk, LAN, or loadable media.

On entry, the service aid displays information about what it does. It then asks for a Genucode diskette to be inserted into the diskette drive. The diskette must be in tar format. The service aid restores the script file **genucode** to the **/tmp** directory. Then the script is executed. The script must at that point then pull any other needed files from the diskette. The script should then execute whatever program is necessary in order to perform its function. On completion, a status code is returned, and the user is returned to the service aid.

The **genucode** script should have a `#! /usr/bin/ksh` line at the beginning of the file. Return status of 0 should be returned if the program was successful, else a non-zero status should be returned.

Hot Plug Task

The Hot Plug Task provides software function for those devices that support hot-plug or hot-swap capability. This includes PCI adapters, SCSI devices, and some RAID devices. This task was previously known as "SCSI Device Identification and Removal" or "Identify and Remove Resource."

The Hot Plug Task has a restriction when running in Standalone or Online Service mode; new devices may not be added to the system unless there is already a device with the same FRU part number installed in the system. This restriction is in place because the device software package for the new device cannot be installed in Standalone or Online Service mode.

Depending on the environment and the software packages installed, selecting this task displays the following three subtasks:

- PCI Hot Plug Manager
- SCSI Hot Swap Manager
- RAID Hot Plug Devices

To run the Hot Plug Task directly from the command line, type the following: `diag -T"identifyRemove"`

If you are running the diagnostics in Online Concurrent mode, run the Missing Options Resolution Procedure immediately after adding, removing or replacing any device. Start the Missing Options Resolution Procedure is by running the **diag -a** command.

If the Missing Options Resolution Procedure runs with no menus or prompts, then device configuration is complete. Otherwise, work through each menu to complete device configuration.

PCI Hot Plug Manager

The PCI Hot Plug Manager task is a SMIT menu that allows you to identify, add, remove, or replace PCI adapters that are hot-pluggable. The following functions are available under this task:

- List PCI Hot Plug Slots
- Add a PCI Hot Plug Adapter
- Replace/Remove a PCI Hot Plug Adapter
- Identify a PCI Hot Plug Slot
- Unconfigure Devices
- Configure Devices
- Install/Configure Devices Added After IPL

The **List PCI Hot Plug Slots** function lists all PCI hot-plug slots. Empty slots and populated slots are listed. Populated slot information includes the connected logical device. The slot name consists of the physical location code and the description of the physical characteristics for the slot.

The **Add a PCI Hot Plug Adapter** function is used to prepare a slot for the addition of a new adapter. The function lists all the empty slots that support hot plug. When a slot

is selected, the visual indicator for the slot blinks at the Identify rate. After the slot location is confirmed, the visual indicator for the specified PCI slot is set to the Action state. This means the power for the PCI slot is off and the new adapter can be plugged in.

The **Replace/Remove a PCI Hot Plug Adapter** function is used to prepare a slot for adapter exchange. The function lists all the PCI slots that support hot plug and are occupied. The list includes the slot's physical location code and the device name of the resource installed in the slot. The adapter must be in the Defined state before it can be prepared for hot-plug removal. When a slot is selected, the visual indicator for the slot is set to the Identify state. After the slot location is confirmed, the visual indicator for the specified PCI slot is set to the Action state. This means the power for the PCI slot, is off and the adapter can be removed or replaced.

The **Identify a PCI Hot Plug Slot** function is used to help identify the location of a PCI hot-plug adapter. The function lists all the PCI slots that are occupied or empty and support hot plug. When a slot is selected for identification, the visual indicator for the slot is set to the Identify state.

The **Unconfigure Devices** function attempts to put the selected device, in the PCI hot-plug slot, into the Defined state. This action must be done before any attempted hot-plug function. If the unconfigure function fails, it is possible that the device is still in use by another application. In this case, the customer or system administrator must be notified to quiesce the device.

The **Configure Devices** function allows a newly added adapter to be configured into the system for use. This function should also be done when a new adapter is added to the system.

The **Install/Configure Devices Added After IPL** function attempts to install the necessary software packages for any newly added devices. The software installation media or packages are required for this function.

Standalone Diagnostics has restrictions on using the PCI Hot-Plug Manager. For example:

- Adapters that are replaced must be exactly the same FRU part number as the adapter being replaced.
- New adapters cannot be added unless a device of the same FRU part number already exists in the system, because the configuration information for the new adapter is not known after the Standalone Diagnostics are booted.
- The following functions are not available from the Standalone Diagnostics and will not display in the list:
 - Add a PCI Hot Plug Adapter
 - Configure Devices
 - Install/Configure Devices Added After IPL

You can run this task directly from the command line by typing the following command:
`diag -d device -T"identifyRemove"`

However, note that some devices support both the PCI Hot-Plug task and the RAID Hot-Plug Devices task. If this is the case for the *device* specified, then the Hot Plug Task displays instead of the PCI Hot Plug Manager menu.

More detailed information concerning PCI Hot-Plug Manager can be found in the AIX Operating System, System Management Guide.

SCSI Hot Swap Manager

This task was known as "SCSI Device Identification and Removal" or "Identify and Remove Resources" in previous releases. This task allows the user to identify, add, remove, and replace a SCSI device in a system unit that uses a SCSI Enclosure Services (SES) device. The following functions are available:

- List the SES Devices
- Identify a Device Attached to an SES Device
- Attach a Device to an SES Device
- Replace/Remove a Device Attached to an SES Device
- Configure Added/Replaced Devices

The **List the SES Devices** function lists all the SCSI hot-swap slots and their contents. Status information about each slot is also available. The status information available includes the slot number, device name, whether the slot is populated and configured, and location.

The **Identify a Device Attached to an SES Device** function is used to help identify the location of a device attached to a SES device. This function lists all the slots that support hot swap that are occupied or empty. When a slot is selected for identification, the visual indicator for the slot is set to the Identify state.

The **Attach a Device to an SES Device** function lists all empty hot-swap slots that are available for the insertion of a new device. After a slot is selected, the power is removed. If available, the visual indicator for the selected slot is set to the Remove state. After the device is added, the visual indicator for the selected slot is set to the Normal state, and power is restored.

The **Replace/Remove a Device Attached to an SES Device** function lists all populated hot-swap slots that are available for removal or replacement of the devices. After a slot is selected, the device populating that slot is Unconfigured; then the power is removed from that slot. If the Unconfigure operation fails, it is possible that the device is in use by another application. In this case, the customer or system administrator must be notified to quiesce the device. If the Unconfigure operation is successful, the visual indicator for the selected slot is set to the Remove state. After the device is removed or replaced, the visual indicator, if available for the selected slot, is set to the Normal state, and power is restored.

Note: Be sure that no other host is using the device before you remove it.

The **Configure Added/Replaced Devices** function runs the configuration manager on the parent adapters that had child devices added or removed. This function ensures that the devices in the configuration database are configured correctly.

Standalone Diagnostics has restrictions on using the SCSI Hot Plug Manager. For example:

- Devices being used as replacement devices must be exactly the same type of device as the device being replaced.
- New devices may not be added unless a device of the same FRU part number already exists in the system, because the configuration information for the new device is not known after the Standalone Diagnostics are booted.

You can run this task directly from the command line. See the following command syntax:

```
diag -d device-T"identifyRemove"  
OR  
diag [-c] -d device -T"identifyRemove -a [identify|remove]"
```

Flag	Description
------	-------------

- | | |
|----|--|
| -a | Specifies the option under the task. |
| -c | Run the task without displaying menus. Only command line prompts are used. This flag is only applicable when running an option such as identify or remove. |
| -d | Indicates the SCSI device. |
| -T | Specifies the task to run. |

RAID Hot Plug Devices

This selection starts the PCI SCSI-2 F/W RAID Adapter Service Aid.

Local Area Network Analyzer

This selection is used to exercise the LAN communications adapters (Token-Ring, Ethernet, and (FDDI) Fiber Distributed Data Interface). The following services are available:

- Connectivity testing between these two network stations. Data is transferred between the two stations, requiring the user to input the Web addresses of both stations.
- Monitoring ring (Token-Ring only). The ring is monitored for a specified period of time. Soft and hard errors are analyzed.

Log Repair Action

The Log Repair Action task logs a repair action in the AIX Error Log. A Repair Action log indicates that a FRU has been replaced, and error log analysis should not be done for any errors logged before the repair action. The Log Repair Action task lists all resources. Replaced resources can be selected from the list, and when **commit** (F7 key) is selected, a repair action is logged for each selected resource.

Periodic Diagnostics

This selection provides a tool for configuring periodic diagnostics and automatic error log analysis. You can select a hardware resource to be tested once a day, at a user-specified time. If the resource cannot be tested because it is busy, error log analysis is performed. Hardware errors logged against a resource can also be monitored by enabling Automatic Error Log Analysis. This allows error log analysis to be performed every time a hardware error is put into the error log. If a problem is detected, a message is posted to the system console and a mail message sent to the users belonging to the system group with information about the failure such as service request number.

The service aid provides the following functions:

- Add or delete a resource to the periodic test list
- Modify the time to test a resource
- Display the periodic test list
- Modify the error notification mailing list
- Disable or enable Automatic Error Log Analysis

PCI RAID Physical Disk Identify

This selection identifies physical disks connected to a PCI SCSI-2 F/W RAID adapter.

This task can be run directly from the AIX command line. The syntax of the command is as follows:

```
diag -c -d pci RAID adapter -T identify
```

Process Supplemental Media

Diagnostic Supplemental Media contains all the necessary diagnostic programs and files required to test a particular resource. The supplemental media is normally released and shipped with the resource as indicated on the diskette label. Diagnostic Supplemental Media must be used when the device support has not been incorporated into the latest diagnostic CD-ROM.

This task processes the Diagnostic Supplemental Media. Insert the supplemental media when you are prompted; then press Enter. After processing has completed, go to the Resource Selection list to find the resource to test.

Notes:

1. This task is supported in Standalone Diagnostics only.
2. Process and test one resource at a time. Run diagnostics after each supplemental media is processed. (for example; If you need to process two supplemental media you need to run diagnostic twice. Once after each supplement media is processed.)

Run Diagnostics

The Run Diagnostics task invokes the Resource Selection List menu. When the commit key is pressed, diagnostics are run on all selected resources.

The procedures for running the diagnostics depend on the state of the diagnostics run-time options. See “Display or Change Diagnostic Run-Time Options” on page 117.

Run Error Log Analysis

The Run Error Log Analysis task invokes the Resource Selection List menu. When the commit key is pressed, Error Log Analysis is run on all selected resources.

Run Exercisers

The Run Exercisers task provides a tool to troubleshoot intermittent system problems in AIX 4.3.2 or later, to test hardware, and to verify replacement parts. When AIX error logging is enabled, the Run Error Log Analysis task can be used to analyze errors after the exerciser completes. Hardware errors are logged in the AIX Error Log. Miscompares and recoverable errors are not reported, however, they may be logged in the AIX Error Log when logging thresholds are exceeded.

The diagnostic supervisor typically sets up temporary work files in **/tmp** to log messages and device statistics. These files are deleted before an exerciser session begins. In addition to individual exerciser requirements, the following requirements pertain to all exercisers:

- Only supported on CHRP platforms
- Only supported in concurrent or service modes
- Not supported from standalone diagnostics
- System performance will be degraded while running the exerciser, so it is recommended that customer applications be shut down before it is run.
- At least 1 MB of free storage in **/tmp** is available

From the TASK SELECTION LIST menu select **Run Exercisers** then the RESOURCES SELECTION LIST menu displays. From this menu choose the resources you want to exercise and then select **commit** to start the **Run Exerciser** task. An intermediate popup may appear stating system performance will be degraded. (The popup does not appear if the task had previously been selected). Press **Enter** and the EXERCISER OPTIONS menu prompts for the type of test to run.

The EXERCISER OPTIONS menu displays two options (1) **Short Exercise** and (2) **Extended Exercise**. The **Short Exercise** option exercises the resources within a relatively short time and exits. The **Extended Exercise** option allows greater flexibility and control over resources and test duration.

After choosing the **Short Exercise** option, additional menus, popups and prompts may appear for each resource. Please read any text and carefully fill out any prompts before committing. Next, the exercisers start, and the **Device Status Screen** displays. The exercisers runs 5 to 10 minutes depending on the number of processors, processor

speed, memory size, and I/O configuration. After choosing the **Extended Exercise** option, additional menus, popups and prompts may appear for each resource. Please read any text and carefully fill out any prompts before committing. Following, the **System Exerciser Main Menu** displays. From this menu the exercisers can be activated through option 1 where they will continuously run until halted (option 2) or exited (option x). See also the help text for information on how to use other available options.

When the task completes any errors that were encountered are displayed for review. Finally, an **Exerciser Complete** popup displays. To continue, press the **Enter** key. Following, you will be taken back to the TASK SELECTION LIST menu. If miscompare errors were encountered, run diagnostics on the resource. If the problem is not reported then contact your service support structure. If any other errors were encountered, select and run the Error Log Analysis task. If Error Log Analysis does not report a problem then contact your service support structure.

Exerciser Commands (CMD)

Use the following commands as needed in the exerciser menus and reports. Not all commands are available in each menu or report.

CMD	Description
a	Acknowledge an error
b	Back one page
c	Toggle between cycle count and last error
e	View the AIX error log
f	Page forward one page
q	Return to Main Menu
r	Refresh screen
s	Enable or disable beep on error
x	Exit system exerciser

Abbreviations

The following list describes abbreviations used in the exerciser reports.

Acronym	Description
COE	Continue on error (use number to select).
CP	Device has run the specified number of cycles and is not running.
DD	The exerciser has been terminated by a signal.
ER	Device has stopped with an error.
HG	The device is hung.
HOE	Halt on error (use number to select).
RN	Device is running.
ST	Device is stopped.

Memory Exerciser

The memory exercisers are labeled memx, where x is a number for the exerciser. Multiple exercisers can be active.

The memory exerciser requests as many memory buffers as possible from AIX. The exerciser then fills the memory buffers with specified bit patterns, then reads and compares the memory buffers to the specified bit patterns.

On systems with multiple processors, a process is started for each processor. The free memory space is split evenly between the available processors, thus reducing the time required to exercise all of the memory.

The following items must be available to run this service aid:

- Online diagnostics loaded in maintenance mode
- 128 KB of free space in **/etc/lpp/diagnostics/data**
- The following commands must be available:
 - **bootinfo**
 - **lsps**
 - **vmstat**

Tape Exerciser

The tape exerciser is labeled `rmt.x`, where `x` is the number of a specific device. The exerciser performs read, write, and compare operations using known data patterns. A tape device and Test Diagnostic Cartridge are required to run this exerciser. The actual Test Diagnostics Cartridge depends upon the specific tape device being tested. The exerciser automatically rewinds the tape. Test Requirements are:

- Tape device
- Test Diagnostic Cartridge; (P/N depends upon tape device)

Diskette Exerciser

The diskette exerciser is labeled `fdx`, where `x` is the number of a specific device. The exerciser performs read, write, and compare operations using known data patterns. A scratch diskette is required to run this exerciser, data on the scratch diskette is destroyed. Test requirements are:

- Diskette device
- Scratch diskette (data on diskette is destroyed)

CD-ROM Exerciser

The CD-ROM exerciser is labeled `cdx`, where `x` is the number of a specific device. The exerciser performs read and compare operations using known data patterns. A CD-ROM device and a Test Disc is required to run this exerciser. Test requirements are:

- CD-ROM device
- Test Disc P/N 81F8902

Save or Restore Hardware Management Policies

Use this service aid to save or restore the settings from Ring Indicate Power On Policy, Surveillance Policy, Remote Maintenance Policy and Reboot Policy.

- Save Hardware Management Policies

This selection writes all of the settings for the hardware management policies to the **/etc/lpp/diagnostics/data/hmpolicies** file:

- Restore Hardware Management Policies

This selection restores all of the settings for the hardware management policies from the contents of the `/etc/lpp/diagnostics/data/hmpolicies` file:

You can access this service aid directly from the AIX command line by entering:
`/usr/lpp/diagnostics/bin/uspchrp -a`

SCSI BUS Analyzer

This service aid enables you to diagnose a SCSI Bus problem in a free-lance mode.

To use this service aid, the user should understand how a SCSI bus works. Use this service aid when the diagnostics cannot communicate with anything on the SCSI bus and cannot isolate the problem. Normally the procedure for finding a problem on the SCSI bus with this service aid is to start with a single device attached, ensure that it is working, then start adding additional devices and cables to the bus, ensuring that each one works. This service aid works with any valid SCSI bus configuration.

The SCSI Bus Analyzer Service Aid transmits a SCSI Inquiry command to a selectable SCSI Address. The service aid then waits for a response. If no response is received within a defined amount of time, the service aid displays a timeout message. If an error occurs or a response is received, the service aid then displays one of the following messages:

- The exerciser transmitted a SCSI Inquiry command and received a valid response back without any errors being detected.
- The exerciser transmitted a SCSI Inquiry command and did not receive any response or error status back. Check that the address is valid, then retry.
- The exerciser transmitted a SCSI Inquiry command and the adapter indicated a SCSI bus error.
- The exerciser transmitted a SCSI Inquiry command and an adapter error occurred.
- The exerciser transmitted a SCSI Inquiry command and an unrecoverable I/O error occurred.

When the SCSI Bus Service Aid is started, a description of the service aid displays.

Press the Enter key to display the Adapter Selection menu. Use this menu to enter which address to transmit the SCSI Inquiry Command.

When the adapter is selected, the SCSI Bus Address Selection menu displays. Use this menu to enter which address to transmit the SCSI Inquiry Command.

After the address is selected, the SCSI Bus Test Run menu displays. Use this menu to transmit the SCSI Inquiry Command by pressing the Enter key. The service aid then indicates the status of the transmission. When the transmission is completed, the results of the transmission display.

Notes:

1. A Check Condition can be returned when the bus or device is working properly.

2. AIX does not allow the command to be sent if the device is in use by another process.

SCSI Tape Drive Service Aid

This service aid enables you to obtain the status or maintenance information from a SCSI tape drive. Only some models of SCSI tape drive are supported.

The service aid provides the following options:

- Display time since a tape drive was last cleaned.

The time since the drive was last cleaned displays on the screen. In addition, a message indicating whether the drive is recommended to be cleaned is also displayed.

- Copy a tape drive's trace table.

The trace table of the tape drive is written to diskettes or a file. The diskettes must be formatted for DOS. Writing the trace table may require several diskettes, but the actual number of diskettes is determined by the size of the trace table. Label the diskettes as follows:

'TRACE x DAT'

(where *x* is a sequential diskette number). The complete trace table consists of the sequential concatenation of all the diskette data files.

When the trace table is written to a disk file, the service aid prompts for a file name. The default name is: '/tmp/TRACE x ', where *x* is the AIX name of the SCSI tape drive being tested.

- Display or copy a tape drive's log sense information.

The service aid provides options to display the log sense information to the screen, to copy it to a DOS formatted diskette or to copy it to a file. The file name LOGSENSE.DAT is used when the log sense data is written on the diskette. The service aid prompts for a file name when the log sense data is to be copied to a file.

This service aid can be run directly from the AIX command line. The syntax of the command is as follows (path is /usr/lpp/diagnostics/bin/utape):

```
utape [-h | -?] [-d device] [-n | -l | -t]
```

OR

```
utape -c -d device [-v] {-n | {-l | -t} { -D | -f [filename]}}
```

Flag	Description
------	-------------

- | | |
|----|--|
| -c | Run the service aid without displaying menus. The return code indicates success or failure. The output is suppressed except for the usage statement and the numeric value for hours since cleaned (if -n and -D flags are used). |
| -D | Copy data to diskette. |
| -f | Copy data to the filename given after this flag or to a default filename if no name is specified. |

- h, -?** Display a usage statement and/or return code. If the **-c** flag is present, only the return code displays to indicate the service aid did not run. If the **-c** is not used, a usage statement displays and the service aid exits.
- l** Display or copy log sense information.
- n** Display time since drive was last cleaned.
- t** Copy trace table.
- v** Verbose mode. If the **-c** flag is present, the information displays on the screen. If the **-n** flag is present, the information about tape-head cleaning is printed.

Spare Sector Availability

This selection checks the number of spare sectors available on the optical disk. The spare sectors are used to reassign when defective sectors are encountered during normal usage or during a format and certify operation. Low availability of spare sectors indicates that the disk needs to be backed up and replaced. Formatting the disk does not improve the availability of spare sectors.

This task can be run directly from the AIX command line. The syntax of the command is as follows:

```
diag -c -d deviceName -T chkspares
```

SSA Service Aid

This service aid provides tools for diagnosing and resolving problems on SSA-attached devices. The following tools are provided:

- Set Service Mode
- Link Verification
- Configuration Verification
- Format and Certify Disk

System Fault Indicator

This task is used to display or reset the system fault indicator on systems that support this function. This task is also used to set the system fault indicator for testing purposes, but the system fault indicator is set back to Normal when you exit this task.

The system fault indicator is used to identify a fault with the system. This indicator is set automatically by hardware firmware, or diagnostics when a fault is detected in the system.

The system fault indicator is turned off when a Log Repair Action is performed. After a serviceable event is complete, do a System Verification to verify the fix. At this time, also do a Log Repair Action if the test on the resource was good and that resource had an entry in the error log.

If the serviceable event was not the result of an error log entry, use the Log Repair Action task to turn off the system fault indicator.

Refer to the system unit service guide for additional information concerning the use of this indicator.

Note: The AIX command does not allow you to set the system fault indicator to the Fault state.

Use the following example to run this task directly from the AIX command line:

```
/usr/lpp/diagnostics/bin/usysfault [-s normal]
```

Flag	Description
-------------	--------------------

-s	Normal, sets the system fault indicator to the Normal state.
-----------	--

When this command is used without the -s flag, the current state of the indicator displays.

System Identify Indicator

This task is used to display or set the system identify indicator on systems that support this function.

The system identify indicator is used to help physically identify a particular system in group of systems. Refer to the system unit service guide for additional information concerning the use of this indicator.

Use the following example to run this task directly from the AIX command line:

```
/usr/lpp/diagnostics/bin/usysident [-s {normal | identify}]
```

Flag	Description
-------------	--------------------

-s {normal identify}	Sets the state of the System Identify Indicator to either Normal or Identify.
-------------------------------	---

When this command is used without the -s flag, the current state of the indicator displays.

Update Disk-Based Diagnostics

This service aid allows fixes (APARs) to be applied.

This task invokes the SMIT Update Software by Fix (APAR) task. The task allows the input device and APARs to be selected. Any APAR can be installed using this task.

Update System or Service Processor Flash

Attention: If the system is running in LPAR mode, ask the customer or system administrator if a service partition has been designated.

- If it has, ask the customer or system administrator to shut down all of the partitions except the one with service authority. The firmware update can then be done using the service aid or the AIX command line in that partition.
- If a service partition has not been designated, the system must be shut down. If the firmware update image is available on backup diskettes, the firmware update can then be done from the service processor menus as a privileged user. If the firmware update image is in a file on the system, the system should be rebooted in SMP mode and the normal firmware update procedures outlined below followed.

If the system is already in SMP mode, the normal firmware update procedures outlined below can be followed.

Note: This service aid runs on CHRP system units only.

This selection updates the system or service processor flash for CHRP system units.

Look for additional update and recovery instructions with the update kit. You need to know the fully qualified path and file name of the flash update image file provided in the kit. If the update image file is on a diskette, the service aid can list the files on the diskette for selection. The diskette must be a valid backup format diskette.

Refer to the update instructions with the kit, or the service guide for the system unit to determine the current level of the system unit or service processor flash memory.

When this service aid is run from online diagnostics, the flash update image file is copied to the **/var** file system. If there is not enough space in the **/var** file system for the new flash update image file, an error is reported. If this error occurs, exit the service aid, increase the size of the **/var** file system, and retry the service aid. After the file is copied, a screen requests confirmation before continuing with the flash update. When you continue the update flash, the system reboots using the **shutdown -u** command. The system does not return to the diagnostics, and the current flash image is not saved. After the reboot, you can remove the **/var/update_flash_image** file.

When this service aid is run from standalone diagnostics, the flash update image file is copied to the file system from diskette. The user must provide the image on a backup format diskette because the user does not have access to remote file systems or any other files that are on the system. If not enough space is available, an error is reported, stating additional system memory is needed. After the file is copied, a screen requests confirmation before continuing with the flash update. When you continue with the update, the system reboots using the **reboot -u** command. You may receive a **Caution: some process(es) wouldn't die** message during the reboot process, you can ignore this message. The current flash image is not saved.

You can use the **update_flash** command in place of this service aid. The command is located in the `/usr/lpp/diagnostics/bin` directory. The command syntax is as follows:

```
update_flash [-q] -f file_name
update_flash [-q] -D device_name -f file_name
update_flash [-q] -D update_flash [-q] -D device_name -l
```

Flag	Description
-D	Specifies that the flash update image file is on diskette. The <i>device_name</i> variable specifies the diskette drive. The default <i>device_name</i> is <code>/dev/fd0</code> .
-f	Flash update image file source. The <i>file_name</i> variable specifies the fully qualified path of the flash update image file.
-l	Lists the files on a diskette, from which the user can choose a flash update image file.
-q	Forces the update_flash command to update the flash EPROM and reboot the system without asking for confirmation.

Attention: The **update_flash** command reboots the entire system. Do not use this command if more than one user is logged on to the system.

7135 RAIDiant Array Service Aid

The 7135 RAIDiant Array service aids contain the following functions:

- Certify LUN
Reads and checks each block of data in the LUN. If excessive errors are encountered, the user is notified.
- Certify Spare Physical Disk
Allows the user to certify (check the integrity of the data) on drives designated as spares.
- Format Physical Disk
Used to format a selected disk drive.
- Array Controller Microcode Download
Allows the microcode on the 7135 controller to be updated when required.
- Physical Disk Microcode Download
Used to update the microcode on any of the disk drives in the array.
- Update EEPROM
Used to update the contents of the EEPROM on a selected controller.
- Replace Controller
Used when it is necessary to replace a controller in the array.

Adapter Microcode Download

Usage: `diag -c -d deviceName -T "download [-B] [-D] [-P]"`

Flag	Description
-B	Download boot block microcode (default to functional microcode)

- D Microcode is on diskette (default to **/etc/microcode** directory)
- P Download the previous level of microcode (default to latest level)

Physical Disk Microcode Download

Usage: `diag -c -d deviceName -T "download -l ChId [-D] [-P]"`

- | Flag | Description |
|------|---|
| -l | Physical disk channel/ID (for example, 27) |
| -D | Microcode is on diskette (default to /etc/microcode directory) |
| -P | Download the previous level of microcode (default to latest level) |

Physical Disk Format

Usage: `diag -c -d deviceName -T "format -l ChId"`

- | Flag | Description |
|------|--|
| -l | Physical disk channel/ID (for example, 27) |

Physical Disk Certify

Usage: `diag -c -d deviceName -T "certify -l ChId"`

- | Flag | Description |
|------|--|
| -l | Physical disk channel/ID (for example, 23) |

Physical Disk Identify

Usage: `diag -c -d deviceName -T "identify"`

7318 Serial Communications Network Server Service Aid

This service aid provides a tool for diagnosing terminal server problems.

Chapter 7. Using the System Verification Procedure

Use the system verification procedure to check the system for correct operation.

If you are analyzing a hardware problem, see Chapter 8, “Hardware Problem Determination” on page 147.

Step 1. Considerations before Running This Procedure

Notes:

1. If this system unit is directly attached to another system unit or attached to a network, make sure that communications with the other system unit are stopped.
2. This procedure requires the use of all system resources. No other activity can be running on the system while you are doing this procedure.

Read the following before using this procedure:

- This procedure requires a display connected to the video port or an ASCII terminal attached to the S1 port.
- Before starting this procedure, stop all programs and the operating system.
- This procedure runs the online diagnostics in service mode or standalone diagnostics. If the online diagnostics are installed, run them. See the operator manual for your type of ASCII terminal to find the key sequences you need in order to respond to the diagnostics.
- For additional information about diagnostics, see Chapter 5, “Using the Standalone and Online Diagnostics” on page 93.
- You must select a console display before running the diagnostics. The instructions for selecting a console display are displayed on all of the graphic displays and any terminal attached to the S1 port. Follow the displayed instructions to select a console display.
- Go to “Step 2. Loading the Diagnostics”.

Step 2. Loading the Diagnostics

To run the online diagnostics in service mode from the boot hard disk, do the following:

1. Stop all application programs running on the operating system.
2. Stop the operating system.
3. Turn off the power.
4. If you are loading the standalone diagnostics and running them from an ASCII terminal, do the following:
 - The attributes for the terminal must be set to match the defaults of the diagnostics.

- If you need to change any settings, record the normal settings, and make sure that the terminal attributes are set to work with the diagnostics. If needed, see Appendix C, “General Attributes Required When Using a TTY Terminal” on page 165.
 - Return to substep 5 when you finish checking the attributes.
5. Turn on the power.
 - a. When the **keyboard** indicator displays, press the numeric 5 key on the keyboard to load the standalone diagnostics or the numeric 6 key on the keyboard to load the online diagnostics.
 - b. Enter requested passwords.
 - c. Follow any instructions to select a console.
 6. When the diagnostic operating instructions display, go to “Step 3. Running System Verification”. If you are unable to load the diagnostics, go to “Problem Determination When Unable to Load Diagnostics” on page 154.

Step 3. Running System Verification

When the Diagnostic Operating Instructions display, do the following to run system verification:

1. Press Enter.
2. If the terminal type has not been defined, you must use the **Initialize Terminal** option on the Function Selection menu to initialize the operating system environment before you can continue with the diagnostics.
3. To do a general checkout with minimal operator action, select the **Diagnostic Routines** option on the Function Selection menu.
To do a more complete checkout including the use of wrap plugs, select the **Advanced Diagnostics** option on the Function Selection menu. The advanced diagnostics are primarily for the service representative; they may instruct you to install wrap plugs to better isolate a problem.
4. Select the **System Verification** option on the Diagnostic Mode Selection menu.
5. To run a general checkout of all installed resources, select the **All Resource** option on the Diagnostic Mode Selection menu.
To check one particular resource, select that resource on the Diagnostic Mode Selection menu.
6. Go to “Step 4. Additional System Verification”.

Step 4. Additional System Verification

The checkout programs end with either the Testing Complete menu and a message stating No trouble was found, or the A Problem Was Detected On (Time Stamp) menu with a service request number (SRN).

To perform additional system verification, do the following:

1. Press Enter to return to the Diagnostic Mode Selection menu.

2. To check other resources, select the resource. When you have checked all of the resources you need to check, go to “Step 5. Stopping the Diagnostics”.

Step 5. Stopping the Diagnostics

To stop the diagnostics, do the following:

1. Press the F3 key repeatedly until you get to the diagnostic operating instructions, then follow the displayed instructions.
2. Press the F3 key once, then follow the displayed instructions to shut down the system.

If you changed any attributes on your virtual terminal window to run the diagnostics, change the settings back to normal.

This completes the system verification. If you received an SRN, report it to the service organization. To do a normal boot, turn off the system unit and wait 30 seconds. Then set the power switch of the system unit to On.

Chapter 8. Hardware Problem Determination

This chapter provides information on using standalone or online diagnostics to help you solve hardware problems.

Problem Determination Using the Standalone or Online Diagnostics

Use this procedure to obtain a service request number (SRN) when you are able to load the Standalone or Online Diagnostics. If you are unable to load the Standalone or Online Diagnostics, go to “Problem Determination When Unable to Load Diagnostics” on page 154. The service organization uses the SRN to determine which field replaceable units (FRUs) are needed to restore the system to correct operation.

Step 1. Considerations before Running This Procedure

Note: See the operator manual for your ASCII terminal to find the key sequences you need to respond to the diagnostic programs.

- The diagnostics can use a display connected to the video port or an ASCII terminal attached to a serial port.
- This procedure asks you to select the type of diagnostics you want to run. If you need more information about the types, see Chapter 5, “Using the Standalone and Online Diagnostics” on page 93.
- Go to “Step 2.”

Step 2.

Is the Attention LED on?

NO Go to “Step 3”.

YES Go to “Attention LED and Lightpath LEDs” on page 11.

Step 3

Are the Online Diagnostics installed on this system?

NO Go to “Step 16” on page 153.

YES Go to “Step 4” on page 148.

Step 4

Determine if the operating system is accepting commands.

Is the operating system accepting commands?

- NO** The system must be turned off in order to run diagnostics.
Verify with the system administrator and users that the system may be turned off. If so, then turn off the system unit and go to “Step 7” on page 149.
- YES** Go to “Step 5”.

Step 5

Diagnostic tests can be run on many resources while the operating system is running. However, you can obtain more extensive problem isolation by running Online Diagnostics in Service mode.

Do you want to run the Online Diagnostics in Service mode?

- NO** Go to “Step 6”.
- YES** Do the following to shut down your system:
1. At the system prompt, stop the operating system using the appropriate command for your operating system.
 2. After the operating system is stopped, turn off the system unit.
 3. 3. Go to “Step 7” on page 149.

Step 6

This step invokes the Online Diagnostics in concurrent mode.

1. Log in as root user.
2. Enter the **diag** command.
3. Wait until the Diagnostic Operating Instructions are displayed, or wait for three minutes.

Are the Diagnostic Operating Instructions displayed without any obvious console display problems?

- NO** Do the following to shut down your system:
1. At the system prompt, stop the operating system using the appropriate command for your operating system.
 2. After the operating system is stopped, turn off the system unit.
 3. 3. Go to “Step 7” on page 149.
- YES** Go to “Step 10” on page 150.

Step 7

This step loads Online Diagnostics in service mode. If you are unable to load the diagnostics, go to “Step 8”.

1. Turn on the power.
2. When the keyboard indicator (icon or text) appears, press F6 on the directly attached keyboard, or 6 on the ASCII terminal keyboard, to indicate that diagnostics are to be loaded.
3. Enter any requested passwords.
4. Follow any instructions to select a console.

Did the Diagnostics Operating Instructions display without any obvious display problem?

- NO** Go to “Step 8”.
- YES** Go to “Step 10” on page 150.

Step 8

Starting at the top of the following table, find your symptom and follow the instructions given in the Action column.

Symptom	Action
Display problem	Go to “Step 9”.
All other symptoms	Go to “Problem Determination When Unable to Load Diagnostics” on page 154

Step 9

Find your type of console display in the following table. Then follow the instructions given in the Action column.

Console Display	Action
Display Device	Go to the display documentation for problem determination.
ASCII terminal	Go to the problem-determination documentation for this type of terminal.

Step 10

The diagnostics loaded correctly.

Press the Enter key.

Is the Function Selection menu displayed?

NO Go to "Step 11".

YES Go to "Step 12" on page 151.

Step 11

There is a problem with the keyboard.

Find the type of keyboard you are using in the following table. Then follow the instructions given in the Action column.

Keyboard Type	Action
101-key keyboard. Identify by the type of Enter key used. The Enter key is within one horizontal row of keys.	Record error code MOKBD001 and report the problem to the service organization.
102-key keyboard. Identify by the type of Enter key used. The Enter key extends into two horizontal rows of keys.	Record error code MOKBD002 and report the problem to the service organization.
Kanji keyboard. Identify by the Japanese characters.	Record error code MOKBD003 and report the problem to the service organization.
ASCII-terminal keyboard. This applies to all attached terminals.	Go to the problem-determination documentation for this type of terminal.

Step 12

1. If the terminal type has not been defined, use the **Initialize Terminal** option on the Function Selection menu to initialize the operating system environment before you can continue with the diagnostics. This is a separate and different operation from selecting the console display.
2. Select **Diagnostic** Routines.
3. Press the Enter key.
4. In the following table, find the menu or system response you received when you selected **Diagnostics**. Follow the instructions given in the Action column.

System Response	Action
The Diagnostic Mode Selection menu is displayed.	Select Problem Determination and go to "Step 13" on page 152.
The Missing Resource menu is displayed.	<p>Follow the displayed instructions until either the Diagnostic Mode Selection menu or an SRN is displayed.</p> <p>If the Diagnostic Mode Selection menu is displayed, select Problem Determination and go to "Step 13" on page 152.</p> <p>If you get an SRN, record it, and go to "Step 15" on page 152.</p>
The New Resource menu is displayed.	<p>Follow the displayed instructions.</p> <p>Note: Devices attached to serial ports S1 or S2 do not appear on the New Resource menu. Also, ISA adapters do not appear unless they have been identified and configured.</p> <p>If the Diagnostic Mode Selection menu is displayed, select Problem Determination and go to "Step 13" on page 152.</p> <p>If you get an SRN, record it, and go to "Step 15" on page 152.</p> <p>If you do not get an SRN, go to "Step 18" on page 153.</p>
The system does not respond to selecting diagnostics .	Go to "Step 11" on page 150.

Step 13

Did the Diagnostic Selection Menu display?

- NO** If **Problem Determination** was selected from the Diagnostic Mode Selection menu, and if a recent error has been logged in the error log, the diagnostics automatically begin testing the resource. Follow the displayed instructions.
- If the **No Trouble Found** screen is displayed, press Enter.
 - If another resource is tested, repeat this step.
 - If the **Diagnostic Selection** menu is displayed, go to “Step 14”.
 - If an SRN is displayed, record it, and go to “Step 15”.
- YES** Go to “Step 14”.

Step 14

The **All Resources** option checks most of the configured adapters and devices.

Select and run the diagnostic tests on the resources you are having problems with or select the **All Resources** option to check all of the configured resources. Find the response in the following table and follow the instructions given in the Action column.

Diagnostic Response	Action
An SRN is displayed.	Go to “Step 15”.
The system hangs.	Report SRN 109-200.
The Testing Complete menu and the No trouble was found message displays and you have not tested all of the resources.	Press Enter and continue with the testing.
The Testing Complete menu and the No trouble was found message displays and you have tested all of the resources.	Go to “Step 18” on page 153.

Step 15

The diagnostics produced an SRN for this problem. Do the following:

1. Record the SRN and other numbers read out.
2. Report the SRN to the service organization.
3. **STOP.** You have completed these procedures.

Step 16

When you are loading the Standalone Diagnostics, the attributes for the terminal must be set to match the defaults of the diagnostic programs. The ASCII terminal must be attached to serial port 1 on the system unit.

Are you going to load Standalone Diagnostics and run them from a ASCII terminal?

- NO** Go to "Step 17".
- YES** Go to "Running the Diagnostics from a TTY Terminal" on page 99 and be sure your terminal attributes are set to work with the diagnostic programs.
- Return to "Step 17" when you finish checking the attributes. Record any settings that are changed.

Step 17

This step loads the Standalone Diagnostics. If you are unable to load the diagnostics, go to "Step 8" on page 149.

1. Turn on the power.
2. Insert the diagnostic CD-ROM into the CD-ROM drive.
3. When the keyboard indicator displays, press F5 on the directly attached keyboard, or 5 on the ASCII keyboard, to indicate that diagnostics are to be loaded.
4. Enter any requested passwords.
5. Follow any instructions to select a console.

Did the Diagnostics Operating Instructions display without any obvious display problem?

- NO** Go to "Step 8" on page 149.
- YES** Go to "Step 10" on page 150.

Step 18

The diagnostics did not find a hardware problem. If you still have a problem, contact your software support center.

Problem Determination When Unable to Load Diagnostics

Use this procedure to obtain an error code. The service organization uses the error code to determine which field replaceable units (FRUs) are needed to restore the system to correct operation.

Step 1. Considerations before Running This Procedure

- The diagnostics can use a display connected to the video port or an ASCII terminal attached to a serial port.
- Go to “Step 2”.

Step 2

Are the Online Diagnostics installed on this system?

NO Go to “Step 4” on page 155.

YES Go to “Step 3”.

Step 3

This step attempts to load Online Diagnostics in service mode.

1. Turn off the power.
2. Turn on the power.
3. If the keyboard indicator displays, press F6 on the directly attached keyboard, or 6 on the ASCII keyboard, to indicate that diagnostics are to be loaded.
4. Enter any requested passwords.
5. Follow any instructions to select a console.
6. Wait until the diagnostics load or the system appears to stop.

Did the diagnostics load?

NO Go to “Step 5” on page 155.

YES Go to “Step 6” on page 158.

Step 4

This step attempts to load the Standalone diagnostics.

1. Turn off the power.
2. Turn on the power.
3. Insert the diagnostic CD-ROM into the CD-ROM drive.
4. If the keyboard indicator displays, press F5 on the directly attached keyboard, or 5 on the ASCII keyboard, to indicate that diagnostics are to be loaded.
5. Enter any requested passwords.
6. Follow any instructions to select a console.
7. Wait until the diagnostics load or the system appears to stop.

Did the diagnostics load?

- NO** Go to "Step 5".
- YES** Go to "Step 6" on page 158.

Step 5

Starting at the top of the following table, find your symptom and follow the instructions given in the Action column.

Symptom	Action
The power LED does not come on, or comes on and does not stay on.	Check the power cable to the outlet. Check the circuit breakers and check for power at the outlet. Ensure that the room temperature is within 60 - 90°F. If you do not find a problem, record error code M0PS0000 and report the problem to the service organization.
The system appears to be stopped and NO beep was heard from the system unit.	Processor POST failure. Report error code M0CPU000.
The system appears to be stopped and NO beep was heard from the system unit. E122, E123, or E124 is displayed on the operator panel display.	No good memory could be found. Report error code M0MEM000.
The system appears to be stopped. A beep was heard from the system unit.	No good memory could be found. Report error code M0MEM001.
The diagnostics are loaded and there was NO beep heard from the system unit during the IPL sequence.	Record error code M0SPK001.
The system stops with the Diagnostic Operating Instructions displayed.	Go to "Step 6" on page 158.
The diskette LED is blinking rapidly, or E1EA or E1EB is displayed on the operator panel.	The flash EPROM data is corrupted. Run the recovery procedure for the flash EPROM.

Symptom	Action
The system stops with a prompt to enter a password.	Enter the password. You are not allowed to continue until a correct password has been entered. When you have entered a valid password, wait for one of the other conditions to occur.
The system stops with an eight-digit error code(s) displayed on the console.	Record the error code(s) and report the problem to the service organization.
The system login prompt is displayed.	<p>You may not have pressed the correct key, or you may not have pressed the key soon enough when you were to indicate a Service Mode boot of diagnostic programs. If this was the case, start over at the beginning of this step.</p> <p>If you are sure that you pressed the correct key in a timely manner, go to Step 7.</p>
The system does not respond when the password is entered.	Go to Step 7.
The system stopped and an indicator is displayed on the system console and an eight-digit error code is not displayed.	<p>If the indicator (text or icon) represents:</p> <ul style="list-style-type: none"> • A keyboard, record error code M0KBD000 and report the problem to the service organization. • Memory, record error code M0MEM002 and report the problem to the service organization. • SCSI, record error code M0CON000 and report the problem to the service organization. • Network, record error code M0NET000 and report the problem to the service organization. • Speaker/Audio, record error code M0BT0000 and report the problem to the service organization.

Symptom	Action
The System Management Services menu is displayed.	<p>The device or media that you are attempting to boot from might be faulty.</p> <ol style="list-style-type: none"> 1. Check the SMS error log for any errors. To check the error log: <ul style="list-style-type: none"> • Select tools • Select error log • If an error is logged, check the time stamp. • If the error was logged during the current boot attempt, record it and report it to your service representative. • If no recent error is logged in the error log, continue to the next step below. 2. If you are attempting to load the Online Diagnostics, try loading the Standalone Diagnostics. Otherwise, record error code M0SCSI01 and report the problem to the service organization.
The system appears to be stopped, the disk activity light is on continuously, and a beep was heard from the system unit.	Record error code MOMEM001 and report the problem to the service organization.
The system stops with the message STARTING SOFTWARE PLEASE WAIT displayed.	Report error code M0BT0000.
The message The system will continue the boot process is displayed continuously on the system unit's console.	Report error code M0SCSI01.

Step 6

The diagnostics loaded correctly.

Go to “Problem Determination Using the Standalone or Online Diagnostics” on page 147.

Step 7

There is a problem with the keyboard.

Find the type of keyboard you are using in the following table. Then follow the instructions given in the Action column.

Keyboard Type	Action
101-key keyboard. Identify by the type of Enter key used. The Enter key is within one horizontal row of keys.	Record error code M0KBD001 and report the problem to the service organization.
102-key keyboard. Identify by the type of Enter key used. The Enter key extends into two horizontal rows of keys.	Record error code M0KBD002 and report the problem to the service organization.
Kanji keyboard. Identify by the Japanese characters.	Record error code M0KBD003 and report the problem to the service organization.
ASCII-terminal keyboard. This applies to all attached terminals.	Go to the problem-determination documentation for this type of terminal.

Chapter 9. Repair Action

This chapter describes the steps to replace a failing component and reset the LEDs on the indicator panel..

1. Replace the failing component with the new component. Refer to Chapter 3 of the *@server pSeries 610 Model 6C1 and Model 6E1 Installation Guide* for instructions.
2. Log in as root user.
3. At the command line, type `diag`.
4. Select **Task Selection**.
5. Select **Log Repair Action**.
6. Select the device that was repaired. (If the device is not listed, select `sysplanar0`)

If the Attention LED remains on after you have completed the repair action and reset the LEDs, call for service.

Appendix A. Environmental Notices

Product Recycling and Disposal

This unit contains materials such as circuit boards, cables, electromagnetic compatibility gaskets and connectors which may contain lead and copper/beryllium alloys that require special handling and disposal at end of life. Before this unit is disposed of, these materials must be removed and recycled or discarded according to applicable regulations. IBM offers product return programs in several countries, for country specific instructions please refer to the following web site:
<http://www.ibm.com/ibm/environment/products/prp.phtml>

This product may contain a sealed lead acid battery(s) or nickel-cadmium battery(s). The battery(s) must be recycled or disposed of properly. Recycling facilities may not be available in your area. In the United States, IBM has established a collection process for reuse, recycling, or proper disposal of used sealed lead acid, nickel cadmium and nickel metal hydride batteries and battery packs from IBM equipment. For information on proper disposal of the batteries in this product, please contact IBM at 1-800-426-4333. For information on disposal of sealed lead acid or nickel cadmium batteries outside the United States, contact your local waste disposal or recycling facility.

Environmental Design

The environmental efforts that have gone into the design of this system signify IBM's commitment to improve the quality of its products and processes. Some of these accomplishments include the elimination of the use of Class 1 ozone-depleting chemicals in the manufacturing process and reductions in manufacturing wastes. For more information, contact an IBM account representative.

Acoustical Noise Emissions

The equivalent continuous A-weighted sound pressure level at workstations (emission sound pressure level at the 1-meter bystander positions) does not exceed 70 dB(A).

Der Geräuschpegel der Einheit ist kleiner oder gleich 70 db(A).

Declared Acoustical Noise Emissions

Product Configuration	Declared A-Weighted Sound Power Level, <i>LWAd</i> (B)		Declared A-Weighted Sound Pressure Level, <LpAm>(dB) at 1 meter Bystander Position	
	Operating	Idling	Operating	Idling
7028-6E1	6.1	6.1	44	43
7028-6C1	6.2	5.9	46	44

Notes:

1. L_{WA}^d is the declared (upper limit) sound power level for a random sample of machines. (1B = 10dB)
2. L_{pA}^m is the mean value of the A-weighted sound pressure level at the 1-meter bystander positions for a random sample of machines.
3. All measurements made in conformance with ISO 7779 and declared in conformance with ISO 9296.
4. System Configurations
 - 7028-6E1: 1 processor, 2 hard files
 - 7028-6C1: 2 processors, 7 hard files, 3 power supplies

Appendix B. Notices

This information was developed for products and services offered in the U.S.A.

The manufacturer may not offer the products, services, or features discussed in this document in other countries. Consult the manufacturer's representative for information on the products and services currently available in your area. Any reference to the manufacturer's product, program, or service is not intended to state or imply that only that product, program, or service may be used. Any functionally equivalent product, program, or service that does not infringe any intellectual property right of the manufacturer may be used instead. However, it is the user's responsibility to evaluate and verify the operation of any product, program, or service.

The manufacturer may have patents or pending patent applications covering subject matter described in this document. The furnishing of this document does not give you any license to these patents. You can send license inquiries, in writing, to the manufacturer.

The following paragraph does not apply to the United Kingdom or any country where such provisions are inconsistent with local law: THIS MANUAL IS PROVIDED "AS IS" WITHOUT WARRANTY OF ANY KIND, EITHER EXPRESSED OR IMPLIED, INCLUDING, BUT NOT LIMITED TO, THE IMPLIED WARRANTIES OF NON-INFRINGEMENT, MERCHANTABILITY OR FITNESS FOR A PARTICULAR PURPOSE. Some states do not allow disclaimer of express or implied warranties in certain transactions; therefore, this statement may not apply to you.

This information could include technical inaccuracies or typographical errors. Changes are periodically made to the information herein; these changes will be incorporated in new editions of the publication. The manufacturer may make improvements and/or changes in the product(s) and/or the program(s) described in this publication at any time without notice.

Information concerning products made by other than the manufacturer was obtained from the suppliers of those products, their published announcements, or other publicly available sources. The manufacturer has not tested those products and cannot confirm the accuracy of performance, compatibility or any other claims related to products made by other than the manufacturer. Questions on the capabilities of products made by other than the manufacturer should be addressed to the suppliers of those products.

Appendix C. General Attributes Required When Using a TTY Terminal

The following general attributes are the default settings for the diagnostic programs. Be sure your terminal is set to these attributes.

Note: Set these attributes before the diagnostic programs are loaded.

General Setup Attributes	3151 /11/31/41 Settings	3151 /51/61 Settings	3161 /3164 Settings	Description
Machine mode	3151	3151 PC	3161 or 3164	The diagnostic programs are set to emulate use of the 3161 ASCII Display Terminal. If your terminal can emulate a 5085, 3161 or 3164 terminal, use these attribute settings. Otherwise, refer to your operator's manual, compare the attribute descriptions with those of your terminal, and set your attributes accordingly.
Generated Code Set		ASCII		
Screen	Normal	Normal		Uses the EIA-232 interface protocol.
Row and Column	24 x 80	24 x 80		Uses the EIA-232 interface protocol.
Scroll	Jump	Jump	Jump	When the last character on the bottom line is entered, the screen moves down one line.
Auto LF	Off	Off	Off	For the "On" setting, pressing the Return key moves the cursor to the first character position of the next line. For the "Off" setting, pressing the Return key moves the cursor to the first character position of the current line. The CR and LF characters are generated by the New line setting.
CRT saver	Off	Off	10	The "10" setting causes the display screen to go blank if there is no activity for 10 minutes. When the system unit sends data or a key is pressed, the screen contents display again.

General Setup Attributes	3151 /11/31/41 Settings	3151 /51/61 Settings	3161 /3164 Settings	Description
Line wrap	On	On	On	The cursor moves to the first character position of the next line in the page after it reaches the last character position of the current line in the page.
Forcing insert	Off	Off		
Tab	Field	Field	Field	The column tab stops are ignored, and the tab operation depends on the field attribute character positions.
Trace			All	Both inbound data (data to the system unit) and outbound data (data from the system unit) to and from the main port can be transferred to the auxiliary port without disturbing communications with the system unit when the Trace key is pressed.

Additional Communication Attributes

The following communication attributes are for the 3151, 3161, and 3164 terminals.

Communication Setup Attributes	3151/11 /31/41) Settings	3151 /51/61, Settings	3161 /3164 Settings	Description
Operating mode	Echo	Echo	Echo	Data entered from the keyboard on the terminal is sent to the system unit for translation and then sent back to the display screen. Sometimes called <i>conversational mode</i> .
Line speed	9600 bps	9600 bps	9600 bps	Uses the 9600 bps (bits per second) line speed to communicate with the system unit.
Word length (bits)	8	8	8	Selects eight bits as a data word length (byte).
Parity	No	No	No	Does not add a parity bit and is used together with the word length attribute to form the 8-bit data word (byte).
Stop bit	1	1	1	Places a bit after a data word (byte).

Communication Setup Attributes	3151/11 /31/41) Settings	3151 /51/61, Settings	3161 /3164 Settings	Description
Turnaround character	CR	CR	CR	Selects the carriage return (CR) character as the line turnaround character.
Interface	EIA-232	EIA-232	EIA-232	Uses the EIA-232 interface protocol.
Line control	IPRTS	IPRTS	IPRTS	Uses the 'permanent request to send' (IPRTS) signal to communicate with system unit.
Break signal (ms)	500	500	500	The terminal sends a break signal to the system unit within 500 ms after the Break key is pressed.
Send null suppress	On	On		Trailing null characters are not sent to the system unit.
Send null			On	Trailing null characters are sent to the system unit.
Response delay (ms)	100	100	100	The terminal waits for 100 ms for the system unit to respond.

Additional Keyboard Attributes

The following keyboard attributes are for the keyboard attached to the 3151, 3161, and 3164 terminals.

Keyboard Setup Attributes	3151/11 /31/41 Settings	3151 /51/61 Settings	3161 /3164 Settings	Description
Enter	Return	Return	Return	The Enter key functions as the Return key.
Return	New line	New line	New line	The cursor moves to the next line when the Return key is pressed.
New line	CR	CR	CR	The Return key generates the carriage return (CR) and the line feed (LF) characters. The line turnaround occurs after the CR and LF characters are generated.
Send	Page	Page	Page	The contents of the current page are sent to the system unit when the Send key is pressed.
Insert character	Space	Space	Space	A blank character is inserted when the Insert key is pressed.

Additional Printer Attributes

The following printer attributes are for a printer attached to the 3151, 3161, and 3164 terminals.

Printer Setup Attributes	3151/11 /31/41 Settings	3151 /51/61 Settings	3161 /3164 Settings	Description
Line speed	9600	9600	9600	Uses 19200 or 9600 bps (bits per second) line speed to communicate with the system unit.
Word length (bits)	8	8	8	Selects eight bits as a data word length (byte).
Parity	Even	Even	No	
Stop bit	1	1	1	Places a bit after a data word (byte).
Characters	ALL	ALL		
Line end			CR-LF	
Print			View port	
Print EOL			Off	
Print null			Off	

Appendix D. Firmware Updates

This section provides information and instruction for updating firmware. You may need to perform these steps if you are installing an option or if your support representative has instructed you to update your firmware.

Checking the Current Firmware Levels

To check the current levels that are installed on the system, do the following:

1. Log in as root user.
2. Enter the following command:
lscfg -vp | grep alterable
3. Press enter. A report will be produced similar to the following:
ROM Level.(alterable).....ct010507 <=== service processor F/W level
ROM Level.(alterable).....CLT01198 <=== system F/W level

Notes:

1. In the preceding example, if the current version of service processor firmware is ct010507, the last six characters of the ROM level represent a date in a yymmdd format, where yy is the last two digits of the year, mm is the month and dd is the day of the firmware (Julian date).
2. Also in the preceding example, if the current version of system firmware is CLT01198, the last five characters of the ROM level represent a date in a yyddd format, where yy is the last two digits of the year and ddd is the Gregorian date of the firmware.

Check the Web site at <http://www.rs6000.ibm.com/support/micro> for the latest level of downloadable firmware. If the version of system firmware installed on your system is older than (has an earlier date than) the system firmware shown on the web site, you should consider downloading and applying the update. If the version of service processor firmware installed on your system is older than (has an earlier date than) the service processor firmware shown on the Web site, consider downloading and applying the update.

Updating System Firmware

To update the system firmware, perform the following steps:

1. Log in as root user.
2. If the directory **/tmp/fwupdate** does not exist, create it by issuing the following command: `mkdir /tmp/fwupdate`
3. The firmware update file must be written into the **/tmp/fwupdate** directory on the server. This can be done by using the **ftp** command to get the image from an ftp server, NFS-mounting the directory on the host server, or downloading it from Web site at <http://www.rs6000.ibm.com/support/micro>.

After the firmware update file has been written into the **/tmp/fwupdate** directory, verify its existence by entering the following command:

```
ls /tmp/fwupdate/cc*.img
```

The update file name will have the format *ccyyddd.img*. The *cc* indicates that this is a combined image for the server, *yy* is the last two digits of the year, and *ddd* is the Julian date of the update file.

4. After the update file has been written to the **/tmp/fwupdate** directory, enter the following commands:

```
cd /usr/lpp/diagnostics/bin
```

```
then
```

```
./update_flash -f /tmp/fwupdate/ccyyddd.img
```

Notes:

- a. *ccyyddd.img* is the file you identified in the previous step.
- b. Make sure that you include the periods (.) in the commands shown above.
- c. AIX commands are case-sensitive. Type them exactly as shown.

You are asked by the system for confirmation to proceed with the firmware update and the required reboot. If you confirm, the system applies the new firmware, reboots, and returns to the AIX prompt. This may take up to ten minutes, depending on the configuration of the system.

Attention: On some systems, the message *Wait for rebooting before stopping* may appear on the system display. *Do not* turn off the system unit until the system has fully rebooted to the AIX login prompt. If a shutdown is necessary at that time, log in as root user and issue the **shutdown** command. While the update is in progress, you will see *Rebooting...* on the display for as long as three minutes.

The firmware update is complete.

Appendix E. Service Processor Setup and Test

For your convenience, an example of a basic service processor setup checklist is included here. Your setup may include more or fewer of the available features, so you can adjust this checklist for your own application so that it is helpful to you.

Service Processor Setup Checklist

1. Unplug the power cord from the server.
2. Attach a local terminal for this setup procedure.
3. Plug in the system and power on the local terminal.
Attention: Make sure that system power remains off.
4. Start the service processor menus. See “Service Processor Menus” on page 26.
5. Set the system name. See “Privileged User Menus” on page 29.
6. Enable surveillance. See OS Surveillance Setup Menu on page 32.
7. Configure Call-In/Call-Out. See “Call-In/Call-Out Setup Menu” on page 42.
8. Exit the service processor menus.
9. Unplug the power cord from the system.
10. Attach modems (if needed). See “Accessing Service Processor Menus Locally” on page 26.
11. Plug in the system.
Attention: Make sure that the system power remains off.
12. Test both of the following:
 - Call-In, see “Testing Call-In” on page 172
 - Call-Out, see “Testing Call-Out” on page 172

Your service processor is now ready for use.

Testing the Setup

This section contains sample testing procedures to help ensure that your setup is working.

These tests include communicating with the server operating system. Before you start, ensure that the necessary serial port(s) is configured. If you need assistance, refer to “Serial Port Configuration” on page 173.

The server should be powered off as a result of the “Service Processor Setup Checklist” on page 171.

Testing Call-In

1. At your remote terminal, call in to your server. Your server answers and offers you the Service Processor Main Menu after requesting your privileged access password.
2. Select **System Power Control**.
3. Select **Power-On System**.
When you are asked if you wish to continue powering on the system, type **Y**.
4. After the system firmware and operating system have initialized the server, the login prompt displays at your remote terminal if you set up Seamless Modem Transfer (refer to “Transfer of a Modem Session” on page 180 for more information). This may take several minutes. When the login prompt displays, you have successfully called the service processor.
5. Type `logout` to disconnect from the operating system. The message `No Carrier` displays on your remote terminal.
6. Call your server again. The operating system answers and offers you the login prompt. If these tests are successful, call-in is working.
7. Log in and type `shutdown` to shut down your server.
8. The message `No Carrier` displays on your remote terminal.

Testing Call-Out

During the setup, you entered your phone numbers for the pager (on page 45) and customer voice (on page 45). These numbers are used for this test.

1. Your remote terminal is disconnected as a result of the Call-In test.
2. Call your server again.
3. At the service processor main menu, select **Call-In/Call-Out Setup** menu, then select **Call-Out** test. This action causes a simulated error condition for the purposes of this test.
4. After a few moments, a message displays, regarding an illegal entry. Press `Enter` to clear the message and return to the main menu.
5. When your telephone rings, answer the call. You should hear the sound of a telephone being dialed. Your computer is trying to page you.

If this test is successful, call-out is working correctly.

Return to the “Telephone Number Setup Menu” on page 44 to enter the actual telephone numbers your server will use for reporting problems.

Serial Port Configuration

To configure the serial port on an AIX system, run the following from an AIX console:

1. Log in as root user.
2. To determine if you have any serial ports already configured, type:

```
lsdev -Cc tty
```

If no serial ports are configured, none are listed. If you want to configure serial ports that are not listed, continue with the remaining steps.

3. Identify the serial port(s) with the modem(s).
4. Type `smit tty`
5. Select **add tty**
6. Select **RS232**
7. Select **Baud rate 9600** or higher.
8. Select **login enable** and set the flow control to RTS.
9. Commit the selections and set up any other needed serial ports.
10. Exit SMIT.

Appendix F. Modem Configurations

The service processor is designed to place little demand on an attached modem, thereby increasing the setup and connection success rates.

Sample Modem Configuration Files

This appendix contains information about several sample modem configuration files that either work directly with your modem or provide a good starting point for a custom setup.

The sample modem configuration files are located in your service processor firmware in the **/usr/share/modems** subdirectory (if your server is using AIX) with the following names. A listing of each specific file is included in this appendix.

Generic Modem Configuration Files

AIX File Name	Service Processor Firmware File Name
modem_z.cfg	modem_z_sp
modem_z0.cfg	modem_z0_sp
modem_f.cfg	modem_f_sp
modem_f0.cfg	modem_f0_sp
modem_f1.cfg	modem_f1_sp

Specific Modem Configuration Files

AIX File Name	Service Processor Firmware File Name
modem_m0.cfg	modem_m0_sp
modem_m1.cfg	modem_m1_sp

Use the following selection procedures and your modem manual to determine which of the configuration files is suitable for your use.

Configuration File Selection

Use the following steps to select a configuration file:

1. Is your modem an IBM 7852-400?

If Yes, use modem configuration file **modem_m0.cfg** and go to step 7 on page 177.

Note: The IBM 7852-400 modem has DIP switches on the right side of the unit. See “IBM 7852-400 DIP Switch Settings” on page 179 for the correct switch settings.

If No, continue with step 2.

2. Is your modem an IBM 7857-017?

If Yes, use modem configuration file **modem_m1.cfg** and go to step 7 on page 177.

Note: The IBM 7857-017 modem has two telephone line connections on the back of the unit. One is marked **LL** (for Leased Line), and the other is marked **PTSN** (for Public Telephone Switched Network). The service processor expects to use the modem on the public network, so the telephone line should attach to the PTSN connector.

If No, continue with step 3.

3. Does your modem respond to the extended command set (prefixed with &)?

If Yes, go to step 5.

If No, continue with step 4.

4. Does your modem respond to:

- ATZ reset command

or

- ATZ n reset commands, where n can be 0, 1, and so on?

If ATZ, configuration file **modem_z.cfg** is recommended.

If ATZ n , configuration file **modem_z0.cfg** is recommended.

Go to step 7 on page 177.

5. Does your modem command set include a test for V.42 error correction at the remote modem (often called “Auto-Reliable Mode”)?

If Yes, disable this test. You can use sample configuration files

/usr/share/modem_m0.cfg or **/usr/share/modem_m1.cfg** as models to help you create a file for your particular modem. See “Customizing the Modem Configuration Files” on page 178 for more information. Go to step 7 on page 177.

If No, go to step 6.

6. Does your modem respond to:

- AT&F reset command

or

- AT&F n reset commands, where n can be 0, 1, and so on?

If AT&F, configuration file **modem_f.cfg** is recommended.

If AT&Fn, configuration file **modem_f0.cfg** or **modem_f1.cfg** is recommended, depending on which provides the hardware flow control profile.

7. You have completed selection of the configuration file.

If your modem configuration selection is not available in the Service Processor Modem Configuration Menu, you must access it through the Configure Remote Maintenance Policy Service Aid.

If you find it necessary to adjust any of these configuration files, use the manual provided with your modem to accomplish that task. It is recommended you select settings that enable hardware flow control and respond to DTR.

Note: Some older modems do not respond to the **X0** or **&R1** commands. Edit out these commands from the modem configuration file if yours is such a modem. See your modem manual for more information.

Some modems, such as the IBM 7857-017, are not designed for the paging function. Although they can be used for paging, they return an error message when they do not get the expected response from another modem. Therefore, even though the paging was successful, the error message causes the service processor to retry, continuing to place pager calls for the number of retries specified in the Call-Out Policy Setup Menu. These retries result in redundant pages.

Examples for Using the Generic Sample Modem Configuration Files

The following table contains information to help you determine which modem configuration file to use with various modems.

Modem	Setup Z	Setup Z0 (Rare)	Setup F	Setup F0	Setup F1
AT&T DataPort 2001 (Ring interrupt only on first ring)				X	
Bocamodem 1440E			X		
Hayes Smart Modem 300	X				
IBM 5841	X				
IBM 5843	X				
IBM 7851				X	
IBM 7852-10				X	
IBM 7855					X
USRobotics 36.6K Sportster					X
Zoom V.32			X		

Customizing the Modem Configuration Files

You can create your own modem configuration files or modify the samples provided. After you customize your modem configuration files, you *must* access them through the Configure Remote Maintenance Policy Service Aid rather than from the service processor menus.

Note: If you have already set up your serial ports, line speeds, authorizations, and telephone numbers from the service processor menus, use the service aid to specify your customized modem configuration files.

If you have not already set up your serial ports, line speeds, authorizations, and telephone numbers from the service processor menus, use the service aids to set them while you specify your customized modem configuration files.

To disable Auto-Reliable Mode testing of the remote modem, use the sample modem configuration file `/usr/share/modems/modem_f.cfg` as a model that you can modify, as follows:

1. Find the necessary command in your modem manual.
2. Copy the `/usr/share/modems/modem_f.cfg` file to a new file with a different name (for example, `modem_fx.cfg`).
3. In the new file (`modem_fx.cfg`), change the line `Send "ATE0T\r"` to `Send "ATcccE0T\r"` where `ccc` is the added command as specified in your modem manual, as follows:

Change the third line of each of the following stanzas:

- `condout`

- condin
 - ripo
4. Save the changes.

IBM 7852-400 DIP Switch Settings

If you are using a 7852-400 modem to enable service processor communications, for proper operation, the dual inline package (DIP) switches must be set according to the following table:

Switch	Position	Function
1	Up	Force DTR
2	Up	Flow Control &E4
3	Down	Result Codes Enabled
4	Down	Modem Emulation Disabled
5	Up	Auto Answer Enabled
6	Up	Maximum Throughput Enabled
7	Up	RTS Normal Functions
8	Down	Enable Command Mode
9	Down	Remote Digital Loopback Test Enabled
10	Up	Dial-Up Line Enabled
11	*Up	AT Responses Enabled (Extended Responses Disabled)
12	*Down	Asynchronous Operation
13	Up	28.8KB Line Speed
14	Up	
15	Up	CD and DSR Normal Functions
16	Up	2-Wire Leased Line Enabled

* Only switches 11 and 12 are changed from the factory default settings.

Xon/Xoff Modems

Some early modems assume software flow control (Xon/Xoff) between the computer and the modem. Modems with this design send extra characters during and after the transmitted data. The service processor cannot accept these extra characters. If your configuration includes such a modem, your functional results may be unpredictable.

The sample modem configuration files included in this appendix do not support these modems, so custom configuration files are necessary. Anchor Automation 2400E is an example of such a modem.

If you experience unexplainable performance problems that may be due to Xon/Xoff characters, it is recommended that you upgrade your modem.

Ring Detection

Most modems produce an interrupt request each time they detect a ring signal. Some modems generate an interrupt only on the first ring signal that they receive. AT&T DataPort 2001 is an example of such a modem.

The service processor uses the ring interrupt request to count the number of rings when Ring Indicate Power-On (RIPO) is enabled. If your modem produces an interrupt on only the first ring, set Ring Indicate Power-On to start on the first ring. Otherwise, you can choose to start Ring Indicate Power-On on any ring count.

Terminal Emulators

The service processor is compatible with simple ASCII terminals, and therefore compatible with most emulators. When a remote session is handed off from the service processor to the operating system, agreement between terminal emulators becomes important.

The server's operating system will have some built-in terminal emulators. You may also have a commercially available terminal emulation. It is important that the local and host computers select the same or compatible terminal emulators so that the key assignments and responses match, ensuring successful communications and control.

For best formatting, choose line wrap in your terminal emulator setup.

Recovery Procedures

Situations such as line noises and power surges can sometimes cause your modem to enter an undefined state. When it is being used for dial-in, dial-out or ring indicate power-on, your modem is initialized each time one of these actions is expected. If one of these environmental conditions occur after your modem has been initialized, it might be necessary to recover your modem to a known state.

If your modem communicates correctly with remote users, it is probably in control. It may be wise to occasionally change some of the functional settings and then change them back, just for the sense of security that the modem is communicating, and to ensure it has been initialized recently.

If your system is particularly difficult to access physically, another strategy is to protect it with an Uninterruptible Power Source (UPS) and a phone-line surge protector.

In case recovery becomes necessary, shut down your system using established procedures. Disconnect the power cable and press the power button to drain capacitance while power is disconnected. Disconnect and reconnect modem power, and then reconnect system power to completely reinitialize your system.

Transfer of a Modem Session

Because many modem command variations exist, the sample modem configuration files located at the end of this appendix have been written to capture the largest number of workable modem settings.

The modem command **&Dn** (where *n* is a number) generally sets the modem response to the Data Terminal Ready (DTR) signal from the server's serial port. The desired response is that the modem will hold a connection while DTR is enabled, and drop the connection when DTR is released. Using this mechanism, the server hangs up on a connection under normal conditions.

Consult your modem manual for its specific response scheme for the **&Dn** command.

Two strategies are available for dealing with the modem's response to DTR:

- Recovery
- Prevention

Before you use one of these strategies, determine if your server's modem is set up correctly to respond to DTR.

With the remote terminal connected to serial port 1 and defined as the Primary Console Device, there are two tests you can perform:

1. Will the modem drop the connection after the System initialization complete message displays at the remote terminal?

If Yes, the modem is set up correctly.

If No, try another **&Dn** setting for your server's modem. See your modem manual for this information. The **&Dn** command appears in three places each in three of the sample modem configuration files, as follows:

2. Will the server's modem disconnect when the power drops? You can make this observation at the remote terminal by commanding your server to shut down and power off. (Use the AIX command **shutdown -F**.) Watch for the message NO CARRIER on your remote terminal.

If Yes, this is the correct response. The modem is set up correctly.

If No, try another **&Dn** setting for your server's modem. See your model manual for this information. The **&Dn** command appears in three places each in three of the sample modem configuration files. Only the following sample modem configuration files contain the **&Dn** command (in three places each):

- modem_f.cfg
- modem_f0.cfg
- modem_f1.cfg

If you are using modem_z.cfg or modem_z0.cfg, you cannot control DTR response. If your remote terminal does not disconnect after logging off, you must command the remote terminal emulator to hang up. This then breaks the connection.

Recovery Strategy

The recovery strategy consists of making two calls to establish a remote session. This solution is the easiest to implement and allows more freedom for configuring your server's serial ports.

To set up a remote terminal session, dial into the service processor and start the system. After the operating system is loaded and initialized, the connection will be dropped. At this point, call the server back and the operating system will answer and offer you the login prompt.

Prevention Strategy

The disconnect is caused by the operating system when it initializes the Primary Console. The tests listed in “Transfer of a Modem Session” on page 180 are conducted with the remote terminal selected as the primary console to manifest the modem’s response to DTR transitions.

- If a local ASCII terminal or a graphics console is to be a permanent part of your server, then make one of them the primary console. Your remote terminal will no longer experience the connection loss.
- If a local console is not a permanent part of your server, you can still assign either the unused graphics console or the unused serial port as the primary console. This gives you the desired seamless connection at your remote terminal.
- If you choose to use the unused serial port as the primary console, some initialization traffic will be sent to any serial device attached to that port. As a result, that serial device’s connection and function could be affected. These impacts may make that port unattractive for devices other than a temporary local ASCII terminal.

Modem Configuration Sample Files

Sample File modem_m0.cfg

```
#
# COMPONENT_NAME: (ESPSETUP) ENTRY SERVICE PROCESSOR SETUP: modem_m0
#
# FUNCTIONS: Modem configuration file specifically for IBM 7852-400
# modem with Auto-Reliable feature. This feature must be turned off
# for Catcher calls. This example uses the AT&F reset command to
# choose the factory defaults.
#
# (C) COPYRIGHT International Business Machines Corp. 1996
# All Rights Reserved
# Licensed Materials - Property of IBM
#
# US Government Users Restricted Rights - Use, duplication or
# disclosure restricted by GSA ADP Schedule Contract with IBM Corp.
#
#
# The modem has configuration switches. They should be set to the
# factory default settings, except switches 11 and 12. These must be
# to UP ("AT" responses) and DOWN (Asynchronous operation), respectively.

ICDelay 1
DefaultTO 10
CallDelay 120
#
# %N Call-Out phone number %R Return phone number
#
#
# PROGRAMMING NOTE: No blanks between double quote marks (").

condout: send "AT&F&E2E0T\r" # Reset to factory defaults
# Reliable mode
# Echo off
ignore "0\r" or "OK\r\n" timeout 2 # Ignore modem response.
send "AT&E12&E14\r" # Disable pacing
# Disable data compression
expect "0\r" or "OK\r\n" timeout 2 # Confirm commands successful.
send "AT&SF1&S0S9=1\r" # DSR independent of CD
# Force DSR on.
# CD respond time=100ms
expect "0\r" or "OK\r\n" timeout 2 # Confirm commands successful.
send "ATV0S0=0\r" # Numeric response code
# Auto-Answer off
expect "0\r" or "OK\r\n" timeout 2 # Confirm commands successful.
done

connect: send "ATDT%N\r" # Tone dialing command.
# %N from Call Home setup.
# Expect a connection response.
expect "33\r" or "31\r" or "28\r" or "26\r" or "24\r" or "21\r" or
"19\r" or "13\r" or "12\r" or "1\r" busy "7\r"
timeout 60
done

retry: send "A/" # Repeat the previous command.
# Expect a connection response.
expect "33\r" or "31\r" or "28\r" or "26\r" or "24\r" or "21\r" or
"19\r" or "13\r" or "12\r" or "1\r" busy "7\r"
timeout 60
done

disconnect:
delay 2 # Separate from previous data.
```

```

send "+++"  

delay 2  

send "ATH0T\r"

ignore "0\r" or "OK\r" timeout 2  

send "ATE0Q1\r"

ignore "0\r" timeout 1  

done

conдин: send "AT&F&E2E0T\r"

ignore "0\r" or "OK\r\n" timeout 2  

send "AT&E12&E14\r"

expect "0\r" or "OK\r\n" timeout 2  

send "AT&SF1&S0S9=1\r"

expect "0\r" or "OK\r\n" timeout 2  

send "ATV0S0=2\r"

expect "0\r" timeout 2  

done

waitcall: ignore "2\r" timeout 1  

expect "2\r" timeout 10

expect "33\r" or "31\r" or "28\r" or "26\r" or "24\r" or "21\r" or  

"19\r" or "13\r" or "12\r" or "1\r" busy "7\r"  

timeout 60  

done

page: send "ATDT%N,,,%R;\r"

expect "0\r" timeout 60  

delay 2  

send "ATH0\r"
expect "0\r" timeout 2  

done

riпо: send "AT&F&E2E0T\r"

ignore "0\r" or "OK\r\n" timeout 2  

send "AT&E12&E14\r"

expect "0\r" or "OK\r\n" timeout 2  

send "AT&SF1&S0S9=1\r"

expect "0\r" or "OK\r\n" timeout 2  

send "ATV0S0=0\r"

expect "0\r" timeout 2  

done

error:

expect "8\r" or "7\r" or "6\r" or "4\r" or "3\r"  

delay 2  

done

```

Sample File modem_m1.cfg

```
#
# COMPONENT_NAME: (ESPSETUP) ENTRY SERVICE PROCESSOR SETUP modem_m1
#
# FUNCTIONS: Modem configuration file specifically for IBM 7857-017 modem with
# Auto-Reliable feature. This feature must be turned off for Catcher calls.
# This example uses the AT&F reset command to choose the factory defaults.
#
# To allow dial commands for digital pagers, it is necessary to reduce
# the number of characters in the dial command. Each comma (delay) has
# been set to 6 seconds (S8=6) for that reason.
#
#
# (C) COPYRIGHT International Business Machines Corp. 1996
# All Rights Reserved
# Licensed Materials - Property of IBM
#
# US Government Users Restricted Rights - Use, duplication or
# disclosure restricted by GSA ADP Schedule Contract with IBM Corp.
#

ICDelay 1
DefaultTO 10
CallDelay 120
#
# %N Call-Out phone number %R Return phone number
#
#
# PROGRAMMING NOTE: No blanks between double quote marks (").

connect: send "AT&F*E0E0\r" # Reset to factory defaults.
# *E0=data compression disabled
# E0=echo disabled
ignore "0\r" or "OK\r\n" timeout 2 # Ignore modem response.
send "AT#F0*Q2S8=6\r" # Trellis modulation disabled
# Retrain with adaptive rate
# Set ,=6second
expect "0\r" or "OK\r\n" timeout 2 # Confirm commands successful
send "ATV0X0S0=0\r" # Numeric response code
# AT compatible messages
# Auto-Answer disabled
expect "0\r" or "OK\r\n" timeout 2 # Confirm commands successful.
done

connect: send "ATDT%N\r" # Tone dialing command.
# %N from Call Home setup.
expect "1\r" busy "7\r" timeout 60 # Expect a connection response.
done

retry: send "A/" # Repeat the previous command.
expect "1\r" busy "7\r" timeout 60 # Expect a connection response.
done

disconnect:
delay 2 # Separate from previous data.
send "+++" # Assure command mode.
delay 2 # Allow mode switching delay.
send "ATH0\r" # Set modem switch-hook down
# (i.e., hang up).
ignore "0\r" or "OK\r" timeout 2 # Ignore modem response.
send "ATE0Q1\r" # Initialize modem: Echo OFF,
# Disable responses.
ignore "0\r" timeout 1
done

condin: send "AT&F*E0E0\r" # Reset to factory defaults.
```

```

# *E0=data compression disabled
# E0=echo disabled
ignore "0\r" or "OK\r\n" timeout 2 # Ignore modem response.
send "AT#F0*Q2\r" # Trellis modulation disabled
# Retrain with adaptive rate
expect "0\r" or "OK\r\n" timeout 2 # Confirm commands successful
send "ATV0X0S0=2\r" # Numeric response code
# AT compatible messages
# Answer on 2nd ring
# Confirm commands successful.

expect "0\r" timeout 2
done

waitcall: ignore "2\r" timeout 1 # Ignore first ring.
expect "2\r" timeout 10 # Pick up second ring
# or timeout.
# Expect a connection response.

expect "1\r" timeout 60
done

page: send "ATD%N,%R\r" # %N = pager call center number
# commas=6sec wait time to
# enter paging number.
# %R = return number
expect "0\r" or "3\r" timeout 30 # Confirm successful command.
delay 2 # Wait before hanging up.
send "+++" # Assure command mode.
delay 2 # Allow mode switching delay.
send "ATH0\r" # Hang up.
expect "0\r" timeout 2 # Confirm successful command.
done

ribo: send "AT&F*E0E0\r" # Reset to factory defaults.
# *E0=data compression disabled
# E0=echo disabled
ignore "0\r" or "OK\r\n" timeout 2 # Ignore modem response.
send "AT#F0*Q2\r" # Trellis modulation disabled
# Retrain with adaptive rate
expect "0\r" or "OK\r\n" timeout 2 # Confirm successful command.
send "ATV0X0S0=0\r" # Numeric response code
# AT compatible messages
# Auto-Answer disabled
# Confirm commands successful.
#

error: # Handle unexpected modem
# responses.

expect "8\r" or "7\r" or "4\r" or "3\r"
delay 2
done

```

Sample File modem_z.cfg

```
#
# COMPONENT_NAME: (ESPSETUP) ENTRY SERVICE PROCESSOR SETUP Z
#
# FUNCTIONS: Modem configuration file for many early Hayes* compatible modems.
# This example uses the ATZ reset command to choose the factory defaults.
# This setup will work for many modems, but it is required for early vintage
# modems which respond to neither the ATZ0 reset command nor the extended (&)
# commands. Refer to your modem manual.
#
# * Trademark of Hayes Microcomputer Products, Inc.
#
# (C) COPYRIGHT International Business Machines Corp. 1996
# All Rights Reserved
# Licensed Materials - Property of IBM
#
# US Government Users Restricted Rights - Use, duplication or
# disclosure restricted by GSA ADP Schedule Contract with IBM Corp.
#
#
# If the modem has configuration switches, they should be set to the
# factory default settings.

ICDelay 1
DefaultT0 10
CallDelay 120
# AT Attention Code           , Inserts delay in dialing commands
# Z Reset to factory defaults Q0 Turn on responses
# E0 Turn echo off           Q1 Turn off responses
# V0 Use numeric responses    S0=0 Automatic answer inhibit
# +++ Escape to command mode S0=2 Answer on second ring
# H0 Hang-up                 T = Tone mode. When used as T\r, it is a
#                             no op to maintain program synchronization
#                             when modem may/will echo the commands.
#
# %N Call-Out phone number   %P Paging phone number
# %S Modem speed (available to users)
#
# Following are common responses from a wide range of modems:
# 16, 15, 12, 10, 5 and 1 are connection responses. Add others as required.
# 7=busy; 6=no dial tone; 4=error; 3=no carrier; 2=ring; 0=OK
#
# PROGRAMMING NOTE: No blanks between double quote marks (").

condout:  send "ATZQ0T\r"           # Reset to factory defaults.
          ignore "0\r" or "OK\r\n" timeout 2 # Ignore modem response.
          send "ATE0T\r"           # Initialize modem: Echo OFF,
          expect "0\r" or "OK\r\n" timeout 2 # Enable responses (Numeric),
          send "ATQ0V0T\r"         # Limit response codes.
          expect "0\r" timeout 2    # Confirm commands successful.
          send "ATS0=0\r"          # Set AutoAnswer OFF
          expect "0\r" timeout 2    # Confirm command successful.
          done

connect:  send "ATDT%N\r"          # Tone dialing command.
          # %N from Call Home setup.

          # Expect a connection response.
          expect "16\r" or "15\r" or "14\r" or "12\r" or "10\r" or "5\r" or "1\r" busy "7\r"
          timeout 60
          done

retry:    send "A/"               # Repeat the previous command.

          # Expect a connection response.
          expect "16\r" or "15\r" or "14\r" or "12\r" or "10\r" or "5\r" or "1\r" busy "7\r"
```

```

timeout 60
done

disconnect:
delay 2 # Separate from previous data.
send "+++\" # Assure command mode.
delay 2 # Allow mode switching delay.
send "ATH0T\r\" # Set modem switch-hook down
# (i.e., hang up).

ignore "0\r\" or "OK\r\" timeout 2 # Ignore modem response.
send "ATE0Q1\r\" # Initialize modem: Echo OFF,
# Disable responses.

ignore "0\r\" timeout 1
done

condin: send "ATZ00T\r\" # Reset to factory defaults.
ignore "0\r\" or "OK\r\n\" timeout 2 # Ignore modem response.
send "ATE0T\r\" # Initialize modem: Echo OFF,
expect "0\r\" or "OK\r\n\" timeout 2 # Enable responses (Numeric),
send "ATQ0V0T\r\" # Limit response codes.
expect "0\r\" timeout 2 # Confirm commands successful.
send "ATS0=2\r\" # Set AutoAnswer ON
expect "0\r\" timeout 2 # Confirm command successful.
done

waitcall: ignore "2\r\" timeout 1 # Ignore first ring.
expect "2\r\" timeout 10 # Pick up second ring
# or timeout.
# Expect a connection response.

expect "16\r\" or "15\r\" or "14\r\" or "12\r\" or "10\r\" or "5\r\" or "1\r\"
timeout 60
done

page: send "ATDT%N,,,%R;\r\" # %N = pager call center number
# Add enough commas to wait for
# time to enter paging number.
# %R = paging number

# Confirm successful command.

expect "0\r\" timeout 60
delay 2 # Wait before hanging up.
send "ATH0T\r\" # Hang up.
expect "0\r\" timeout 2 # Confirm successful command.
done

ripo: send "ATZ00T\r\" # Reset to factory defaults.
ignore "0\r\" or "OK\r\n\" timeout 2 # Ignore modem response.
send "ATE0T\r\" # Initialize modem: Echo OFF,
expect "0\r\" or "OK\r\n\" timeout 2 # Enable responses (Numeric),
send "ATQ0V0T\r\" # Limit response codes.
expect "0\r\" timeout 2 # Confirm commands successful.
send "ATS0=0\r\" # Set AutoAnswer OFF
expect "0\r\" timeout 2 # Confirm command successful.
done

error: # Handle unexpected modem
# responses.

expect "8\r\" or "7\r\" or "6\r\" or "4\r\" or "3\r\"
delay 2
done

```

Sample File modem_z0.cfg

```
#
# COMPONENT_NAME: (ESPSETUP) ENTRY SERVICE PROCESSOR SETUP Z0
#
# FUNCTIONS: Modem configuration file for some early Hayes* compatible modems.
# This example uses the ATZ0 reset command to choose the factory defaults.
# This setup is recommended for modems that will respond to the ATZ0 command
# and which do not respond to the extended (&) commands. Refer to your modem
# manual.
#
# * Trademark of Hayes Microcomputer Products, Inc.
#
# (C) COPYRIGHT International Business Machines Corp. 1996
# All Rights Reserved
# Licensed Materials - Property of IBM
#
# US Government Users Restricted Rights - Use, duplication or
# disclosure restricted by GSA ADP Schedule Contract with IBM Corp.
#
#
# If the modem has configuration switches, they should be set to the
# factory default settings.

ICDelay 1
DefaultT0 10
CallDelay 120
# AT Attention Code           , Inserts delay in dialing commands
# Z0 Reset. Restore Profile 0 Q0 Turn on responses
# E0 Turn echo off           Q1 Turn off responses
# V0 Use numeric responses    S0=0 Automatic answer inhibit
# +++ Escape to command mode S0=2 Answer on second ring
# H0 Hang-up                 X0=0 Limit modem response codes
#                               T = Tone mode. When used as T\r, it is a
#                               no op to maintain program synchronization
#                               when modem may/will echo the commands.
#
#
# %N Call-Out phone number    %P Paging phone number
# %S Modem speed (available to users)
#
# Following are common responses from a wide range of modems:
# 16, 15, 12, 10, 5 and 1 are connection responses. Add others as required.
# 7=busy; 6=no dial tone; 4=error; 3=no carrier; 2=ring; 0=OK
#
# PROGRAMMING NOTE: No blanks between double quote marks (").

condout:  send "ATZ0Q0T\r"           # Reset modem. Select profile 0
          ignore "0\r" or "OK\r\n" timeout 2 # Ignore modem response.
          send "ATE0T\r"           # Initialize modem: Echo OFF,
          expect "0\r" or "OK\r\n" timeout 2 # Enable responses (Numeric),
          send "ATQ0V0X0T\r"       # Limit response codes.
          expect "0\r" timeout 2    # Confirm commands successful.
          send "ATS0=0\r"          # Set AutoAnswer OFF
          expect "0\r" timeout 2    # Confirm command successful.
          done

connect:  send "ATDT%N\r"           # Tone dialing command.
          # %N from Call Home setup.

          # Expect a connection response.
          expect "16\r" or "15\r" or "14\r" or "12\r" or "10\r" or "5\r" or "1\r" busy "7\r"
          timeout 60
          done

retry:    send "A/"                # Repeat the previous command.
          # Expect a connection response.
```

```

expect "16\r" or "15\r" or "14\r" or "12\r" or "10\r" or "5\r" or "1\r" busy "7\r"
timeout 60
done

disconnect:
delay 2 # Separate from previous data.
send "+++" # Assure command mode.
delay 2 # Allow mode switching delay.
send "ATH0T\r" # Set modem switch-hook down
# (i.e., hang up).
ignore "0\r" or "OK\r" timeout 2 # Ignore modem response.
send "ATE0Q1\r" # Initialize modem: Echo OFF,
# Disable responses.

ignore "0\r" timeout 1
done

conadin:
send "ATZ0Q0T\r" # Reset modem. Select profile 0
ignore "0\r" or "OK\r\n" timeout 2 # Ignore modem response.
send "ATE0T\r" # Initialize modem: Echo OFF,
expect "0\r" or "OK\r\n" timeout 2 # Enable responses (Numeric),
send "ATQ0V0X0T\r" # Limit response codes.
expect "0\r" timeout 2 # Confirm commands successful.
send "ATS0=2\r" # Set AutoAnswer ON
expect "0\r" timeout 2 # Confirm command successful.
done

waitcall:
ignore "2\r" timeout 1 # Ignore first ring.
expect "2\r" timeout 10 # Pick up second ring
# or timeout.
# Expect a connection response.

expect "16\r" or "15\r" or "14\r" or "12\r" or "10\r" or "5\r" or "1\r"
timeout 60
done

page:
send "ATDT%N,,,,%R;\r" # %N = pager call center number
# Add enough commas to wait for
# time to enter paging number.
# %R = paging number

# Confirm successful command.

expect "0\r" timeout 60
delay 2 # Wait before hanging up.
send "ATH0T\r" # Hang up.
expect "0\r" timeout 2 # Confirm successful command.
done

ripo:
send "ATZ0Q0T\r" # Reset modem. Select profile 0
ignore "0\r" or "OK\r\n" timeout 2 # Ignore modem response.
send "ATE0T\r" # Initialize modem: Echo OFF,
expect "0\r" or "OK\r\n" timeout 2 # Enable responses (Numeric),
send "ATQ0V0X0T\r" # Limit response codes.
expect "0\r" timeout 2 # Confirm commands successful.
send "ATS0=0\r" # Set AutoAnswer OFF
expect "0\r" timeout 2 # Confirm command successful.
done # RI Power On enabled.

error:
# Handle unexpected modem
# responses.
expect "8\r" or "7\r" or "6\r" or "4\r" or "3\r"
delay 2
done

```

Sample File modem_f.cfg

```
#
# COMPONENT_NAME: (ESPSETUP) ENTRY SERVICE PROCESSOR SETUP F
#
# FUNCTIONS: Modem configuration file for many recent Hayes* compatible modems.
# This example uses the AT&F reset command to choose the factory defaults.
# This set up is preferred for modems with extended (&) commands. For early
# vintage modems, setup Z or Z0 is recommended. If your modem responds to
# the extended (&) commands and to factory default choices (&Fn), setup file
# F0 or F1 is recommended.
#
# * Trademark of Hayes Microcomputer Products, Inc.
#
# (C) COPYRIGHT International Business Machines Corp. 1996
# All Rights Reserved
# Licensed Materials - Property of IBM
#
# US Government Users Restricted Rights - Use, duplication or
# disclosure restricted by GSA ADP Schedule Contract with IBM Corp.
#
#
# If the modem has configuration switches, they should be set to the
# factory default settings.

ICDelay 1
DefaultTO 10
CallDelay 120
# AT Attention Code , Inserts delay in dialing commands
# &F Reset to default profile Q0 Turn on responses
# E0 Turn echo off Q1 Turn off responses
# V0 Use numeric responses S0=0 Automatic answer inhibit
# +++ Escape to command mode S0=2 Answer on second ring
# H0 Hang-up X0=0 Limit modem response codes
# T = Tone mode. When used as T\r, it is a
# no op to maintain program synchronization
# when modem may/will echo the commands.
#
# &C1 Detect CD &D2 Respond to DTR (often the default)
#
# %N Call-Out phone number %P Paging phone number
# %S Modem speed (available to users)
#
# Following are common responses from a wide range of modems:
# 16, 15, 12, 10, 5 and 1 are connection responses. Add others as required.
# 7=busy; 6=no dial tone; 4=error; 3=no carrier; 2=ring; 0=OK
#
# PROGRAMMING NOTE: No blanks between double quote marks (").

conduit: send "AT&FQ0T\r" # Reset to factory defaults.
         ignore "0\r" or "OK\r\n" timeout 2 # Ignore modem response.
         send "ATE0T\r" # Initialize modem: Echo OFF,
         expect "0\r" or "OK\r\n" timeout 2 # Enable responses (Numeric),
         send "ATQ0V0X0T\r" # Limit response codes.
         expect "0\r" timeout 2 # Confirm commands successful.
         send "ATS0=0\r" # Set AutoAnswer OFF
         expect "0\r" timeout 2 # Confirm command successful.
         send "AT&C1&D2\r" # Detect carrier and DTR.
         expect "0\r" timeout 2 # Confirm command successful.
         done

connect: send "ATDT%N\r" # Tone dialing command.
         # %N from Call Home setup.

         # Expect a connection response.
         expect "16\r" or "15\r" or "14\r" or "12\r" or "10\r" or "5\r" or "1\r" busy "7\r"
         timeout 60
```

```

done
retry:    send "A/"                                # Repeat the previous command.
                                                # Expect a connection response.
expect "16\r" or "15\r" or "14\r" or "12\r" or "10\r" or "5\r" or "1\r" busy "7\r"
timeout 60
done
disconnect:
delay 2                                       # Separate from previous data.
send "+++"                                   # Assure command mode.
delay 2                                       # Allow mode switching delay.
send "ATH0T\r"                               # Set modem switch-hook down
                                                # (i.e., hang up).
ignore "0\r" or "OK\r" timeout 2            # Ignore modem response.
send "ATE0Q1\r"                             # Initialize modem: Echo OFF,
                                                # Disable responses.
ignore "0\r" timeout 1
done
condin:   send "AT&FQ0T\r"                    # Reset to factory defaults.
ignore "0\r" or "OK\r\n" timeout 2          # Ignore modem response.
send "ATE0T\r"                              # Initialize modem: Echo OFF,
expect "0\r" or "OK\r\n" timeout 2          # Enable responses (Numeric),
send "ATQ0V0X0T\r"                          # Limit response codes.
expect "0\r" timeout 2                      # Confirm commands successful.
send "ATS0=2\r"                             # Set AutoAnswer ON
expect "0\r" timeout 2                      # Confirm command successful.
send "AT&C1&D2\r"                          # Detect carrier and DTR.
expect "0\r" timeout 2                      # Confirm command successful.
done
waitcall: ignore "2\r" timeout 1              # Ignore first ring.
          expect "2\r" timeout 10            # Pick up second ring
                                                # or timeout.
expect "16\r" or "15\r" or "14\r" or "12\r" or "10\r" or "5\r" or "1\r"
timeout 60
done
page:     send "ATDT%N,,,,%R;\r"             # %N = pager call center number
                                                # Add enough commas to wait for
                                                # time to enter paging number.
                                                # %R = paging number
                                                # Confirm successful command.
          expect "0\r" timeout 60
          delay 2                             # Wait before hanging up.
          send "ATH0T\r"                     # Hang up.
          expect "0\r" timeout 2             # Confirm successful command.
          done
ripo:     send "AT&FQ0T\r"                    # Reset to factory defaults.
ignore "0\r" or "OK\r\n" timeout 2          # Ignore modem response.
send "ATE0T\r"                              # Initialize modem: Echo OFF,
expect "0\r" or "OK\r\n" timeout 2          # Enable responses (Numeric),
send "ATQ0V0X0T\r"                          # Limit response codes.
expect "0\r" timeout 2                      # Confirm commands successful.
send "ATS0=0\r"                             # Set AutoAnswer OFF
expect "0\r" timeout 2                      # Confirm command successful.
send "AT&C1&D2\r"                          # Detect carrier and DTR.
expect "0\r" timeout 2                      # Confirm command successful.
done                                          # RI Power On enabled.
error:    # Handle unexpected modem

```

```
expect "8\r" or "7\r" or "6\r" or "4\r" or "3\r"  
delay 2  
done
```

Sample File modem_f0.cfg

```
#
# COMPONENT_NAME: (ESPSETUP) ENTRY SERVICE PROCESSOR SETUP F0
#
# FUNCTIONS: Modem configuration file for many recent Hayes* compatible modems.
# This example uses the AT&F0 reset command to choose the factory defaults.
# This set up is preferred for modems with extended (&) commands. For early
# vintage modems, setup Z or Z0 is recommended. If your modem responds to
# the extended (&) commands and to factory default choices (&Fn), but doesn't
# work properly with this setup file, setup F1 is recommended.
#
# * Trademark of Hayes Microcomputer Products, Inc.
#
# (C) COPYRIGHT International Business Machines Corp. 1996
# All Rights Reserved
# Licensed Materials - Property of IBM
#
# US Government Users Restricted Rights - Use, duplication or
# disclosure restricted by GSA ADP Schedule Contract with IBM Corp.
#
#
# If the modem has configuration switches, they should be set to the
# factory default settings.

ICDelay 1
DefaultT0 10
CallDelay 120
# AT Attention Code , Inserts delay in dialing commands
# &F0 Reset. Restore profile 0 Q0 Turn on responses
# E0 Turn echo off Q1 Turn off responses
# V0 Use numeric responses S0=0 Automatic answer inhibit
# +++ Escape to command mode S0=2 Answer on second ring
# H0 Hang-up X0=0 Limit modem response codes
# T = Tone mode. When used as T\r, it is a
# no op to maintain program synchronization
# when modem may/will echo the commands.
#
# &C1 Detect CD &D2 Respond to DTR (often the default)
# &R1 Ignore RTS (CTS)
#
# %N Call-Out phone number %P Paging phone number
# %S Modem speed (available to users)
#
# Following are common responses from a wide range of modems:
# 16, 15, 12, 10, 5 and 1 are connection responses. Add others as required.
# 7=busy; 6=no dial tone; 4=error; 3=no carrier; 2=ring; 0=OK
#
# PROGRAMMING NOTE: No blanks between double quote marks (").

connect: send "AT&F0Q0T\r" # Reset modem. Select profile 0
          ignore "0\r" or "OK\r\n" timeout 2 # Ignore modem response.
          send "ATE0T\r" # Initialize modem: Echo OFF,
          expect "0\r" or "OK\r\n" timeout 2 # Enable responses (Numeric),
          send "ATQ0V0X0T\r" # Limit response codes.
          expect "0\r" timeout 2 # Confirm commands successful.
          send "ATS0=0\r" # Set AutoAnswer OFF
          expect "0\r" timeout 2 # Confirm command successful.
          send "AT&C1&D2&R1\r" # Detect carrier and DTR,
          # Ignore RTS.
          expect "0\r" timeout 2 # Confirm command successful.
          done

connect: send "ATDT%N\r" # Tone dialing command.
          # %N from Call Home setup.

          # Expect a connection response.
```

```

expect "16\r" or "15\r" or "14\r" or "12\r" or "10\r" or "5\r" or "1\r" busy "7\r"
timeout 60
done

retry:      send "A/"                                # Repeat the previous command.

                                                    # Expect a connection response.
expect "16\r" or "15\r" or "14\r" or "12\r" or "10\r" or "5\r" or "1\r" busy "7\r"
timeout 60
done

disconnect:
delay 2                                           # Separate from previous data.
send "+++"                                       # Assure command mode.
delay 2                                           # Allow mode switching delay.
send "ATH0T\r"                                   # Set modem switch-hook down
                                                    # (i.e., hang up).
ignore "0\r" or "OK\r" timeout 2                # Ignore modem response.
send "ATE0Q1\r"                                  # Initialize modem: Echo OFF,
                                                    # Disable responses.

ignore "0\r" timeout 1
done

condin:     send "AT&F0Q0T\r"                     # Reset modem. Select profile 0
ignore "0\r" or "OK\r\n" timeout 2              # Ignore modem response.
send "ATE0T\r"                                   # Initialize modem: Echo OFF,
expect "0\r" or "OK\r\n" timeout 2              # Enable responses (Numeric),
send "ATQ0V0X0T\r"                              # Limit response codes.
expect "0\r" timeout 2                          # Confirm commands successful.
send "ATS0=2\r"                                  # Set AutoAnswer ON
expect "0\r" timeout 2                          # Confirm command successful.
send "AT&C1&D2&R1\r"                            # Detect carrier and DTR,
                                                    # Ignore RTS.
                                                    # Confirm command successful.

expect "0\r" timeout 2
done

waitcall:  ignore "2\r" timeout 1                 # Ignore first ring.
            expect "2\r" timeout 10              # Pick up second ring
                                                    # or timeout.
                                                    # Expect a connection response.
expect "16\r" or "15\r" or "14\r" or "12\r" or "10\r" or "5\r" or "1\r"
timeout 60
done

page:      send "ATDT%N,,,%R;\r"                 # %N = pager call center number
                                                    # Add enough commas to wait for
                                                    # time to enter paging number.
                                                    # %R = paging number

                                                    # Confirm successful command.

            expect "0\r" timeout 60
            delay 2                               # Wait before hanging up.
            send "ATH0T\r"                       # Hang up.
            expect "0\r" timeout 2              # Confirm successful command.
done

ripos:     send "AT&F0Q0T\r"                     # Reset modem. Select profile 0
ignore "0\r" or "OK\r\n" timeout 2              # Ignore modem response.
send "ATE0T\r"                                   # Initialize modem: Echo OFF,
expect "0\r" or "OK\r\n" timeout 2              # Enable responses (Numeric),
send "ATQ0V0X0T\r"                              # Limit response codes.
expect "0\r" timeout 2                          # Confirm commands successful.
send "ATS0=0\r"                                  # Set AutoAnswer OFF
expect "0\r" timeout 2                          # Confirm command successful.
send "AT&C1&D2&R1\r"                            # Detect carrier and DTR,
                                                    # Ignore RTS.
                                                    # Confirm command successful.

expect "0\r" timeout 2

```

```
done                                # RI Power On enabled.
error:                               # Handle unexpected modem
                                     # responses.
expect "8\r" or "7\r" or "6\r" or "4\r" or "3\r"
delay 2
done
```

Sample File modem_f1.cfg

```
#
# COMPONENT_NAME: (ESPSETUP) ENTRY SERVICE PROCESSOR SETUP F1
#
# FUNCTIONS: Modem configuration file for many recent Hayes* compatible modems.
# This example uses the AT&F1 reset command to choose the factory defaults.
# This set up is for modems with extended (&) commands and which do not work
# properly with setup F0. For early vintage modems, setup Z or Z0 is
# recommended.
#
# * Trademark of Hayes Microcomputer Products, Inc.
#
# (C) COPYRIGHT International Business Machines Corp. 1996
# All Rights Reserved
# Licensed Materials - Property of IBM
#
# US Government Users Restricted Rights - Use, duplication or
# disclosure restricted by GSA ADP Schedule Contract with IBM Corp.
#
# If the modem has configuration switches, they should be set to the
# factory default settings.

ICDelay 1
DefaultT0 10
CallDelay 120
# AT Attention Code , Inserts delay in dialing commands
# &F1 Reset. Restore profile 1 Q0 Turn on responses
# E0 Turn echo off Q1 Turn off responses
# V0 Use numeric responses S0=0 Automatic answer inhibit
# +++ Escape to command mode S0=2 Answer on second ring
# H0 Hang-up X0=0 Limit modem response codes
# T = Tone mode. When used as T\r, it is a
# no op to maintain program synchronization
# when modem may/will echo the commands.
#
# &C1 Detect CD &D2 Respond to DTR (often the default)
# &R1 Ignore RTS (CTS)
#
# %N Call-Out phone number %P Paging phone number
# %S Modem speed (available to users)
#
# Following are common responses from a wide range of modems:
# 16, 15, 12, 10, 5 and 1 are connection responses. Add others as required.
# 7=busy; 6=no dial tone; 4=error; 3=no carrier; 2=ring; 0=OK
#
# PROGRAMMING NOTE: No blanks between double quote marks (").

conduit: send "AT&F1Q0T\r" # Reset modem. Select profile 1
         ignore "\0\r" or "OK\r\n" timeout 2 # Ignore modem response.
         send "ATE0T\r" # Initialize modem: Echo OFF,
         expect "\0\r" or "OK\r\n" timeout 2 # Enable responses (Numeric),
         send "ATQ0V0X0T\r" # Limit response codes.
         expect "\0\r" timeout 2 # Confirm commands successful.
         send "ATS0=0\r" # Set AutoAnswer OFF
         expect "\0\r" timeout 2 # Confirm command successful.
         send "AT&C1&D2&R1\r" # Detect carrier and DTR,
         # Ignore RTS.
         expect "\0\r" timeout 2 # Confirm command successful.
         done

connect: send "ATDT%N\r" # Tone dialing command.
         # %N from Call Home setup.

         # Expect a connection response.
         expect "16\r" or "15\r" or "14\r" or "12\r" or "10\r" or "5\r" or "1\r" busy "7\r"
```

```

timeout 60
done

retry:    send "A/"                                # Repeat the previous command.

                                                # Expect a connection response.
expect "16\r" or "15\r" or "14\r" or "12\r" or "10\r" or "5\r" or "1\r" busy "7\r"
timeout 60
done

disconnect:
delay 2                                        # Separate from previous data.
send "+++"                                    # Assure command mode.
delay 2                                        # Allow mode switching delay.
send "ATH0T\r"                                # Set modem switch-hook down
                                                # (i.e., hang up).
ignore "0\r" or "OK\r" timeout 2             # Ignore modem response.
send "ATE0Q1\r"                               # Initialize modem: Echo OFF,
                                                # Disable responses.

ignore "0\r" timeout 1
done

condin:   send "AT&F1Q0T\r"                    # Reset modem. Select profile 1
ignore "0\r" or "OK\r\n" timeout 2          # Ignore modem response.
send "ATE0T\r"                               # Initialize modem: Echo OFF,
expect "0\r" or "OK\r\n" timeout 2          # Enable responses (Numeric),
send "ATQ0V0X0T\r"                          # Limit response codes.
expect "0\r" timeout 2                      # Confirm commands successful.
send "ATS0=2\r"                              # Set AutoAnswer ON
expect "0\r" timeout 2                      # Confirm command successful.
send "AT&C1&D2&R1\r"                        # Detect carrier and DTR,
                                                # Ignore RTS.

expect "0\r" timeout 2                      # Confirm command successful.
done

waitcall: ignore "2\r" timeout 1              # Ignore first ring.
expect "2\r" timeout 10                     # Pick up second ring
                                                # or timeout.
                                                # Expect a connection response.
expect "16\r" or "15\r" or "14\r" or "12\r" or "10\r" or "5\r" or "1\r"
timeout 60
done

page:     send "ATDT%N,,,%R;\r"              # %N = pager call center number
                                                # Add enough commas to wait for
                                                # time to enter paging number.
                                                # %R = paging number

                                                # Confirm successful command.
expect "0\r" timeout 60
delay 2                                        # Wait before hanging up.
send "ATH0T\r"                                # Hang up.
expect "0\r" timeout 2                      # Confirm successful command.
done

ripo:    send "AT&F1Q0T\r"                    # Reset modem. Select profile 1
ignore "0\r" or "OK\r\n" timeout 2          # Ignore modem response.
send "ATE0T\r"                               # Initialize modem: Echo OFF,
expect "0\r" or "OK\r\n" timeout 2          # Enable responses (Numeric),
send "ATQ0V0X0T\r"                          # Limit response codes.
expect "0\r" timeout 2                      # Confirm commands successful.
send "ATS0=0\r"                              # Set AutoAnswer OFF
expect "0\r" timeout 2                      # Confirm command successful.
send "AT&C1&D2&R1\r"                        # Detect carrier and DTR,
                                                # Ignore RTS.

expect "0\r" timeout 2                      # Confirm command successful.
done                                          # RI Power On enabled.

```

```
error:                                     # Handle unexpected modem
                                           # responses.
expect "8\r" or "7\r" or "6\r" or "4\r" or "3\r"
delay 2
done
```

Index

Numerics

- 3.5-inch diskette drive
 - using 18
- 7135 RAIDiant array 140
- 7318 server service aid 141

A

- account number 47
- AIX operating system documentation 88
- alter/display bootlist 117
- attention and lightpath LEDs 11
- attributes required for TTY terminal 165

B

- battery
 - disposal, recycling 161

C

- call-in
 - security 49
 - testing 172
- call-out
 - policy 47
 - testing 172
- CD-ROM drive
 - using 19
- check points 27, 38
- component LEDs 13
- console mirroring
 - enable/disable 31
 - quick disconnect 53
 - system configuration 53
- customer administration center 45

D

- diagnostics 93
 - loading 143
 - NIM standalone diagnostics 94
 - online 93
 - online diagnostics modes of operation 99
 - online diagnostics service mode 99
 - operating considerations 93
 - standalone 93
 - standalone diagnostics 102
- display/alter bootlist 117
- documentation, AIX 63

E

- electrical safety xi
 - laser compliance statement xiii
- EPROM
 - updates 32, 54

- ergonomic information xviii

F

- fibre channel RAID service aids 123
- firmware updates 169
- flash SK-NET FDDI firmware 124

G

- general access password, changing 31
- general user menus 27
- graphic system management services 59

H

- hardware problem determination 147
- heartbeat 51

I

- indicator panel 12

K

- keyboards
 - using 15

L

- language selection 41
- laser compliance statement xiii
- laser safety information xiii
- LEDs
 - component 13
- local area network service aid 130
- log repair action service aid 130

M

- menus
 - general user 27
 - privileged user 29
 - service processor 26
 - service processor call-in/call-out setup 42
 - service processor call-out policy setup 46
 - service processor customer account setup 47
 - service processor language selection 41
 - service processor reboot policy setup 35
 - service processor serial port selection 43
 - service processor serial port snoop setup 33
 - service processor serial port speed setup 44
 - service processor setup 30
 - service processor system information 38
 - service processor system power control 34
 - service processor telephone setup 44

modem

- configuration file selection 176
- configurations 175
- transfer 180

modem_f.cfg, sample file 191
modem_f0.cfg, sample file 194
modem_f1.cfg, sample file 197
modem_m0.cfg, sample file 183
modem_m1.cfg, sample file 185
modem_z.cfg, sample file 187
modem_z0.cfg, sample file 189
mouse
 using 16

N

network service aid 130
NIM standalone diagnostics 94
noise emissions 161

O

online diagnostics 93
online publications xvii
operating system documentation, AIX 88
operational phases, service processor
 standby 55
operator panel 7, 9, 10
operator panel display 11

P

pager 45
panel
 indicator 12
passwords
 changing General-Access password 31
 changing privileged-access password 31
 overview 30
POST errors
 read 27
power-on methods 48
primary console 182
privileged user menus 29
privileged-access password, changing 31
problem determination
 using the standalone or online diagnostics 147, 154
 when unable to load diagnostics 154
product disposal 161
progress indicators 27, 38
publications, online xvii

R

read system, POST errors 27, 39
reading the operator panel display 9
reboot recovery 35, 49
recycling 161
related publications xvii
remote latency 46
remote timeout 46
repair action 159
repair log service aid 130
reporting problem 14

reset service processor 32
restart recovery 35, 49
RETAIN 47
retries 46
ring indicator power-on 34
run exercisers 132

S

safety notices xi
SCSI 135
 bus analyzer 135
security, call-in 49
service aids 103, 104
 7135 RAIDiant array 140
 7318 service aid 141
 add resource 104
 AIX shell prompt 105
 analyze adapter internal log 105
 backup/restore media 105
 certify media 105
 change hardware VPD 109
 configure dials and LPF Keys 109
 configure ISA adapter 109
 configure reboot policy 110
 configure remote maintenance policy 111
 configure surveillance policy 113
 create customized configuration diskette 114
 delete resource 114
 disk based diagnostic 138
 disk to disk copy 114
 display configuration and resource list 115
 display firmware device node information 115
 display hardware error report 116
 display hardware VPD 116
 display microcode level 121
 display or change diagnostic run-time options 117
 display previous diagnostic results 118
 display resource attributes 118
 display service hints 118
 display software product data 119
 display system environmental sensors 119
 display test patterns 121
 display/alter bootlist 117
 display/alter sector 115
 download microcode 121
 fibre channel RAID service aids 123
 flash SK-NET FDDI firmware 124
 format media 124
 generic microcode download 126
 local area network 130
 log repair action 130
 machine check error log 116
 PCI RAID physical disk identify 131
 periodic diagnostics 131
 process supplemental media 131

- service aids (*continued*)
 - ring indicate power on policy 113
 - run diagnostics 132
 - run error log analysis 132
 - run exercisers 132
 - save or restore hardware management policies 134
 - SCSI bus analyzer 135
 - SCSI tape drive 136
 - spare sector availability 137
 - SSA service aids 137
 - update system or service processor flash 139
 - service center 44
 - service director feature
 - using 23
 - service mode
 - service processor procedures 57
 - service processor 26, 55
 - checklist 171
 - operational phases 55
 - setup 171
 - setup checklist 171
 - test 171
 - service processor call-in security 49
 - service processor feature
 - using 23
 - service processor menu inactivity 26
 - service processor menus
 - accessing locally 26
 - accessing remotely 26
 - call-in/call-out 42
 - call-out policy 46
 - customer account 47
 - general user 27
 - language selection 41
 - menu inactivity 26
 - privileged user 29
 - reboot policy 35
 - restart policy 35
 - serial port selection 43
 - Serial Port Snoop Setup Menu 33
 - serial port speed setup 44
 - setup menu 30
 - system information 38
 - system power control 34
 - telephone number 44
 - service processor procedures in service mode 57
 - service provider 44
 - SSA service aids 137
 - standalone diagnostics 93
 - start talk mode 31
 - starting the system unit 9
 - STBY 55
 - stopping the system unit 9
 - surveillance
 - failure 51
 - surveillance (*continued*)
 - operating system 51
 - set parameters 32
 - system firmware 51
 - system administrator 45
 - system features 1
 - system firmware updates 169
 - system information menu 38
 - system management services 59
 - graphical system management services 59
 - config 62
 - firmware update 79
 - multiboot 63
 - utilities 65
 - text-based system management services 80
 - display configuration 91
 - multiboot menu 88
 - select language 81
 - utilities 82
 - system phone number 45
 - system POST errors
 - read 27
 - system power-on methods 48
 - system unit
 - starting 9
 - stopping 9
 - system verification procedure 143
- ## T
- tasks and service aids 103
 - testing the setup
 - call-in 172
 - call-out 172
 - text-based system management services 80
 - trademarks xviii
 - transfer of a modem session 180
 - TTY terminal attributes
 - general 165
 - TTY terminal attributes required for diagnostics 165
- ## U
- unattended start mode, enable/disable 34
- ## V
- voice phone number 45
- ## W
- web sites
 - AIX library 88
 - ergonomic information xviii

Readers' Comments — We'd Like to Hear from You

pSeries 610 Model 6C1 and Model 6E1
User's Guide

Publication No. SA38-0598-01

Overall, how satisfied are you with the information in this book?

	Very Satisfied	Satisfied	Neutral	Dissatisfied	Very Dissatisfied
Overall satisfaction	<input type="checkbox"/>	<input type="checkbox"/>	<input type="checkbox"/>	<input type="checkbox"/>	<input type="checkbox"/>

How satisfied are you that the information in this book is:

	Very Satisfied	Satisfied	Neutral	Dissatisfied	Very Dissatisfied
Accurate	<input type="checkbox"/>	<input type="checkbox"/>	<input type="checkbox"/>	<input type="checkbox"/>	<input type="checkbox"/>
Complete	<input type="checkbox"/>	<input type="checkbox"/>	<input type="checkbox"/>	<input type="checkbox"/>	<input type="checkbox"/>
Easy to find	<input type="checkbox"/>	<input type="checkbox"/>	<input type="checkbox"/>	<input type="checkbox"/>	<input type="checkbox"/>
Easy to understand	<input type="checkbox"/>	<input type="checkbox"/>	<input type="checkbox"/>	<input type="checkbox"/>	<input type="checkbox"/>
Well organized	<input type="checkbox"/>	<input type="checkbox"/>	<input type="checkbox"/>	<input type="checkbox"/>	<input type="checkbox"/>
Applicable to your tasks	<input type="checkbox"/>	<input type="checkbox"/>	<input type="checkbox"/>	<input type="checkbox"/>	<input type="checkbox"/>

Please tell us how we can improve this book:

Thank you for your responses. May we contact you? Yes No

When you send comments to IBM, you grant IBM a nonexclusive right to use or distribute your comments in any way it believes appropriate without incurring any obligation to you.

Name

Address

Company or Organization

Phone No.



Cut or Fold
Along Line

Fold and Tape

Please do not staple

Fold and Tape



NO POSTAGE
NECESSARY
IF MAILED IN THE
UNITED STATES

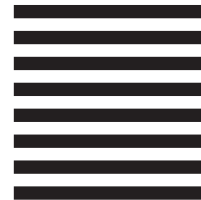

BUSINESS REPLY MAIL

FIRST-CLASS MAIL PERMIT NO. 40 ARMONK, NEW YORK

POSTAGE WILL BE PAID BY ADDRESSEE

Information Development
Department H6DS-905-6C006
11400 Burnet Road
Austin, TX 78758-3493



Fold and Tape

Please do not staple

Fold and Tape

Cut or Fold
Along Line



Printed in the United States of America
on recycled paper containing 10%
recovered post-consumer fiber.

February 2002

SA38-0598-01



Spine information:



pSeries 610 Model 6C1 and
Model 6E1
User's Guide

SA38-0598-01