

RS/6000 44P Series Model 270



# User's Guide

### **Third Edition (September 2001)**

Before using this information and the product it supports, read the information in "Safety Notices" on page xi, "Appendix A. Environmental Notices" on page 159, and "Appendix B. Notices" on page 161.

A reader's comment form is provided at the back of this publication. If the form has been removed, address comments to Publications Department, Internal Zip 9561, 11400 Burnet Road, Austin, Texas 78758-3493. To send comments electronically, use this commercial internet address: [aix6kpub@austin.ibm.com](mailto:aix6kpub@austin.ibm.com). Any information that you supply may be used without incurring any obligation to you.

© **International Business Machines Corporation, 1999, 2001. All rights reserved.**

Note to U.S. Government Users -- Documentation related to restricted rights -- Use, duplication or disclosure is subject to restrictions set forth in GSA ADP Schedule Contract with IBM Corp.

---

# Contents

<b>Safety Notices</b> . . . . .	xi
Electrical Safety . . . . .	xi
Unit Emissions . . . . .	xii
Laser Safety Information . . . . .	xii
<b>Data Integrity and Verification</b> . . . . .	xiii
<b>About This Book</b> . . . . .	xv
ISO 9000 . . . . .	xv
Updating Microcode Levels . . . . .	xv
Online Publications . . . . .	xv
Related Publications . . . . .	xv
Trademarks . . . . .	xvi
<b>Chapter 1. Introducing the 44P Series Model 270</b> . . . . .	1
System Features . . . . .	1
Bus Architecture . . . . .	1
Microprocessor . . . . .	1
Memory . . . . .	1
Media Drives . . . . .	1
Other Drives . . . . .	1
Power Supply . . . . .	1
Keyboard . . . . .	2
Mouse . . . . .	2
Operator Panel . . . . .	2
Input/Output Ports . . . . .	2
Security Features . . . . .	2
Front View . . . . .	3
Operator Panel . . . . .	4
Rear View . . . . .	5
<b>Chapter 2. Using the 44P Series Model 270</b> . . . . .	7
Starting the System Unit . . . . .	7
Stopping the System Unit . . . . .	7
Reading the Operator Panel Display . . . . .	8
Operator Panel . . . . .	8
Using the Keyboards . . . . .	9
Using the Three-Button Mouse . . . . .	10
Handling the Mouse Correctly . . . . .	10
Caring for the Mouse . . . . .	10
Cleaning the Mouse . . . . .	11
Using the 3.5-Inch Diskette Drive . . . . .	12
Write-Protecting 3.5-Inch Diskettes . . . . .	13
Loading and Unloading the 3.5-Inch Diskette . . . . .	14
Using the CD-ROM Drive . . . . .	14
Front View of CD-ROM Drive . . . . .	15
Understanding the Status Lights . . . . .	15

Handling Compact Discs . . . . .	16
Other Handling Considerations . . . . .	16
Loading a Compact Disc . . . . .	17
Opening the Tray Manually . . . . .	18
Playing an Audio CD . . . . .	18
General Information for the 8mm Tape Drive . . . . .	18
Front View of the 8mm Tape Drive . . . . .	19
Operating Recommendations . . . . .	20
8 mm Tape Cartridge Types . . . . .	20
Tape Cartridge Compatibility . . . . .	21
Setting the Write-Protect Tab on 8 mm Tape Cartridges . . . . .	21
Environmental Considerations for 8 mm Data Cartridges . . . . .	22
Operating the 8mm Tape Drive in Harsh Environments . . . . .	22
Erasing 8 mm Data Cartridge . . . . .	22
Using the 8mm Tape Drive . . . . .	23
Status Lights . . . . .	23
Liquid Crystal Display . . . . .	24
Changing the Display Language . . . . .	24
Loading the 8 mm Tape Cartridge . . . . .	25
Unloading the 8 mm Tape Cartridge . . . . .	26
Cleaning the Tape Drive . . . . .	27
Obtaining Additional Tape Cartridges . . . . .	29
General information for the 12/24GB 4mm Tape Drive . . . . .	29
Front View of the 12/24GB 4mm Tape Drive . . . . .	30
Using the 12/24GB 4mm Tape Drive. . . . .	30
Operating Recommendations . . . . .	30
12/24 GB 4 mm Tape Cartridge Types . . . . .	31
Tape Cartridge Compatibility . . . . .	31
4 mm Tape Write Density Setting. . . . .	31
Setting the Write-Protect Tab on 12/24 GB 4 mm Tape Cartridges . . . . .	32
Erasing 12/24 GB 4 mm Data Cartridge . . . . .	32
Environmental Considerations for 12/24 GB 4 mm Data Cartridges . . . . .	32
Operating the 12/24GB 4mm Tape Drive in Harsh Environments . . . . .	33
Status Lights . . . . .	33
Loading the 12/24 GB 4 mm Tape Cartridge . . . . .	35
Unloading the 12/24 GB 4 mm Tape Cartridge . . . . .	36
Cleaning the Tape Path on the 12/24GB 4mm Tape Drive . . . . .	37
Obtaining Additional Tape Cartridges . . . . .	38
Using the Service Processor and Service Director Features . . . . .	38
Service Processor. . . . .	38
Service Director . . . . .	39
<b>Chapter 3. Using the Service Processor.</b> . . . . .	<b>41</b>
Service Processor Menus . . . . .	42
Service Processor Menu Inactivity . . . . .	42
Accessing Service Processor Menus Locally . . . . .	42
Accessing Service Processor Menus Remotely . . . . .	42
General User Menu . . . . .	43
Privileged User Menus . . . . .	44
Main Menu . . . . .	44

Service Processor Setup Menu . . . . .	45
Passwords . . . . .	45
Serial Port Snoop Setup Menu . . . . .	47
System Power Control Menu . . . . .	48
System Information Menu . . . . .	50
Language Selection Menu . . . . .	53
Call-In/Call-Out Setup Menu . . . . .	54
Modem Configuration Menu . . . . .	54
Serial Port Selection Menu . . . . .	55
Serial Port Speed Setup Menu . . . . .	55
Telephone Number Setup Menu . . . . .	56
Call-Out Policy Setup Menu . . . . .	57
Customer Account Setup Menu . . . . .	58
Reboot/Restart Policy Setup Menu . . . . .	58
Service Processor Functions . . . . .	60
System Power-On Methods . . . . .	61
Service Processor Call-In Security . . . . .	62
Service Processor Reboot/Restart Recovery . . . . .	63
Boot (IPL) Speed . . . . .	63
Failure During Boot Process . . . . .	63
Failure During Normal System Operation . . . . .	63
Service Processor Reboot/Restart Policy Controls . . . . .	63
Processor Boot-Time Deconfiguration (CPU Repeat-Gard) . . . . .	63
Processor Run-Time Deconfiguration (CPU-Gard) . . . . .	64
Memory Boot-Time Deconfiguration (Memory Repeat-Gard) . . . . .	64
Service Processor System Monitoring - Surveillance . . . . .	65
System Firmware Surveillance. . . . .	65
Operating System Surveillance . . . . .	65
Call Out . . . . .	66
Console Mirroring . . . . .	67
Service Processor Firmware Updates . . . . .	67
Service Processor Error Log . . . . .	68
System POST Errors . . . . .	69
Service Processor Operational Phases . . . . .	69
Pre-Standby Phase . . . . .	69
Standby Phase. . . . .	70
Bring-Up Phase . . . . .	70
Run-time Phase . . . . .	71
Service Processor Procedures in Service Mode . . . . .	71
<b>Chapter 4. System Management Services . . . . .</b>	<b>73</b>
Graphical System Management Services . . . . .	73
Config. . . . .	75
Multiboot . . . . .	76
Utilities . . . . .	79
Password . . . . .	80
Power-On Password . . . . .	81
Privileged-Access Password . . . . .	83
ErrorLog . . . . .	85
RIPL . . . . .	86

Set Address . . . . .	87
Ping . . . . .	88
Config. . . . .	90
SCSI ID . . . . .	91
Firmware Update . . . . .	92
Firmware Recovery . . . . .	93
Text-Based System Management Services . . . . .	94
Display Configuration. . . . .	94
Multiboot Menu. . . . .	95
Select Boot Device . . . . .	96
Configure Nth Boot Device . . . . .	97
Utilities . . . . .	98
Set Password and Unattended Start Mode . . . . .	99
SCSI Spin Up. . . . .	100
Display Error Log . . . . .	100
Remote Initial Program Load Setup . . . . .	100
Change SCSI ID. . . . .	103
Update System or Service Processor Firmware . . . . .	103
Firmware Recovery . . . . .	104
Select Console . . . . .	104
Select Language. . . . .	104
Open Firmware . . . . .	105
<b>Chapter 5. Using the Standalone and Online Diagnostics . . . . .</b>	<b>107</b>
Standalone and Online Diagnostics Operating Considerations . . . . .	107
Selecting a Console Display . . . . .	107
Identifying the Terminal Type to the Diagnostics Programs . . . . .	107
Undefined Terminal Types. . . . .	108
Resetting the Terminal . . . . .	108
Running Standalone Diagnostics . . . . .	108
Running Online Diagnostics . . . . .	108
Running Diagnostics from a TTY Terminal . . . . .	109
Online Diagnostics Modes . . . . .	109
Service Mode. . . . .	109
Concurrent Mode. . . . .	110
Running the Online Diagnostics in Concurrent Mode . . . . .	111
Maintenance Mode . . . . .	111
Running the Online Diagnostics in Maintenance Mode . . . . .	111
Standalone Diagnostic Operation . . . . .	112
Running the Standalone Diagnostics . . . . .	112
<b>Chapter 6. Introducing Tasks and Service Aids . . . . .</b>	<b>113</b>
Tasks . . . . .	113
Add Resource to Resource List . . . . .	114
AIX Shell Prompt. . . . .	115
Analyze Adapter Internal Log. . . . .	115
Backup and Restore Media . . . . .	115
Certify Media . . . . .	115
Change Hardware Vital Product Data . . . . .	116
Configure Dials and LPFKeys . . . . .	116

Configure ISA Adapter . . . . .	117
Configure Reboot Policy . . . . .	117
Configure Remote Maintenance Policy . . . . .	118
Configure Ring Indicate Power On Policy. . . . .	120
Configure Ring Indicate Power On . . . . .	120
Configure Service Processor . . . . .	120
Surveillance Setup . . . . .	121
Modem Configuration . . . . .	121
Call In/Out Setup . . . . .	121
Site-Specific Call In/Out Setup . . . . .	121
Reboot/Restart Policy Setup . . . . .	122
Configure Surveillance Policy . . . . .	123
Create Customized Configuration Diskette . . . . .	123
Delete Resource from Resource List . . . . .	123
Disk Maintenance . . . . .	124
Disk to Disk Copy . . . . .	124
Display/Alter Sector . . . . .	125
Display Configuration and Resource List . . . . .	125
Display Firmware Device Node Information . . . . .	125
Display Hardware Error Report . . . . .	125
Display Hardware Vital Product Data . . . . .	125
Display Machine Check Error Log . . . . .	125
Display Microcode Level . . . . .	126
Display or Change Bootlist . . . . .	126
Display or Change Diagnostic Run-Time Options . . . . .	126
Display Previous Diagnostic Results . . . . .	127
Display Resource Attributes . . . . .	127
Display Service Hints . . . . .	128
Display Software Product Data . . . . .	128
Display System Environmental Sensors . . . . .	128
Examples . . . . .	129
Display Test Patterns . . . . .	130
Download Microcode . . . . .	130
Download Microcode to PCI SCSI RAID Adapter . . . . .	130
Download Microcode to Disk Drive Attached to a PCI SCSI RAID Adapter . . . . .	130
Download Microcode to a PCI FC-AL Adapter . . . . .	130
Download Microcode to Other Devices . . . . .	131
Fiber Channel RAID Service Aids . . . . .	131
Flash SK-NET FDDI Firmware . . . . .	132
Format Media . . . . .	132
Hardfile Attached to SCSI Adapter (non-RAID) . . . . .	132
Hardfile Attached to PCI SCSI RAID Adapter . . . . .	133
Optical Media . . . . .	134
Diskette Format . . . . .	134
Generic Microcode Download . . . . .	134
Local Area Network Analyzer. . . . .	135
Log Repair Action . . . . .	135
Periodic Diagnostics . . . . .	135
PCI RAID Physical Disk Identify. . . . .	136
Process Supplemental Media . . . . .	136

Run Diagnostics . . . . .	136
Run Error Log Analysis . . . . .	136
Run Exercisers . . . . .	136
Exerciser Commands (Cmd) . . . . .	136
Acronyms . . . . .	137
Memory Exerciser . . . . .	137
Save or Restore Hardware Management Policies . . . . .	138
Save or Restore Service Processor Configuration . . . . .	138
SCSI BUS Analyzer . . . . .	138
SCSI Device Identification and Removal . . . . .	139
SCSI Tape Drive Service Aid . . . . .	139
Spare Sector Availability . . . . .	141
SSA Service Aid . . . . .	141
Update Disk-Based Diagnostics . . . . .	141
Update System or Service Processor Flash . . . . .	141
Update System Flash . . . . .	142
7135 RAIDiant Array Service Aid . . . . .	142
7318 Serial Communications Network Server Service Aid . . . . .	143
<b>Chapter 7. Using the System Verification Procedure . . . . .</b>	<b>145</b>
Step 1. Considerations before Running This Procedure . . . . .	145
Step 2. Loading the Diagnostics. . . . .	145
Step 3. Running System Verification . . . . .	146
Step 4. Additional System Verification . . . . .	146
Step 5. Stopping the Diagnostics . . . . .	147
<b>Chapter 8. Hardware Problem Determination . . . . .</b>	<b>149</b>
Problem Determination Using the Standalone or Online Diagnostics . . . . .	149
Step 1. Considerations before Running This Procedure . . . . .	149
Step 2 . . . . .	149
Step 3 . . . . .	149
Step 4 . . . . .	150
Step 5 . . . . .	150
Step 6 . . . . .	150
Step 7 . . . . .	151
Step 8 . . . . .	151
Step 9 . . . . .	151
Step 10. . . . .	151
Step 11. . . . .	152
Step 12. . . . .	153
Step 13. . . . .	153
Step 14. . . . .	153
Step 15. . . . .	153
Step 16. . . . .	154
Step 17. . . . .	154
Problem Determination When Unable to Load Diagnostics . . . . .	154
Step 1. Considerations before Running This Procedure . . . . .	154
Step 2 . . . . .	154
Step 3 . . . . .	155
Step 4 . . . . .	155



Step 5 . . . . .	155
Step 6 . . . . .	158
Step 7 . . . . .	158
<b>Appendix A. Environmental Notices.</b> . . . . .	159
Product Recycling and Disposal. . . . .	159
Battery Return Program . . . . .	159
Environmental Design . . . . .	159
Unit Emissions . . . . .	159
<b>Appendix B. Notices</b> . . . . .	161
<b>Appendix C. Checking the Current Firmware Levels</b> . . . . .	163
<b>Appendix D. General Attributes Required When Using a TTY Terminal</b> . . . . .	165
Additional Communication Attributes . . . . .	166
Additional Keyboard Attributes . . . . .	167
Additional Printer Attributes . . . . .	168
<b>Appendix E. Modem Configurations.</b> . . . . .	169
Sample Modem Configuration Files . . . . .	169
Configuration File Selection . . . . .	169
Examples for Using the Generic Sample Modem Configuration Files . . . . .	171
Customizing the Modem Configuration Files. . . . .	171
IBM 7852-400 DIP Switch Settings. . . . .	172
Xon/Xoff Modems . . . . .	172
Ring Detection . . . . .	173
Terminal Emulators . . . . .	173
Recovery Procedures . . . . .	173
Transfer of a Modem Session . . . . .	173
Recovery Strategy . . . . .	174
Prevention Strategy . . . . .	175
Modem Configuration Samples . . . . .	175
<b>Index</b> . . . . .	189



---

## Safety Notices

A *danger* notice indicates the presence of a hazard that has the potential of causing death or serious personal injury. *Danger* notices appear on the following pages:

- xi
- xii

A *caution* notice indicates the presence of a hazard that has the potential of causing moderate or minor personal injury. *Caution* notices appear on the following pages:

- xii
- xii
- 14

For a translation of the safety notices contained in this book, see the *System Unit Safety Information Manual*, order number SA23–2652.

---

## Electrical Safety

Observe the following safety instructions any time you are connecting or disconnecting devices attached to the workstation.

### **DANGER**

**An electrical outlet that is not correctly wired could place hazardous voltage on metal parts of the system or the devices that attach to the system. It is the responsibility of the customer to ensure that the outlet is correctly wired and grounded to prevent an electrical shock.**

**Before installing or removing signal cables, ensure that the power cables for the system unit and all attached devices are unplugged.**

**When adding or removing any additional devices to or from the system, ensure that the power cables for those devices are unplugged before the signal cables are connected. If possible, disconnect all power cables from the existing system before you add a device.**

**Use one hand, when possible, to connect or disconnect signal cables to prevent a possible shock from touching two surfaces with different electrical potentials.**

**During an electrical storm, do not connect cables for display stations, printers, telephones, or station protectors for communication lines.**

**CAUTION:**

**This product is equipped with a three-wire power cable and plug for the user's safety. Use this power cable with a properly grounded electrical outlet to avoid electrical shock.**

**DANGER**

**To prevent electrical shock hazard, disconnect the power cable**

---

## Unit Emissions

The unit-related emission value is equal to or lower than 70dB(A).

Der Geräuschpegel der Einheit ist kleiner oder gleich 70 db(A).

---

## Laser Safety Information

The optical drive in this system unit is a laser product. The optical drive has a label that identifies its classification. The label, located on the drive, is shown below.

CLASS 1 LASER PRODUCT  
LASER KLASSE 1  
LUOKAN 1 LASERLAITE  
APPAREIL À LASER DE CLASSE 1  
IEC 825:1984 CENELEC EN 60 825:1991

The optical drive in this system unit is certified in the U.S. to conform to the requirements of the Department of Health and Human Services 21 Code of Federal Regulations (DHHS 21 CFR) Subchapter J for Class 1 laser products. Elsewhere, the drive is certified to conform to the requirements of the International Electrotechnical Commission (IEC) 825 (1st edition 1984) and CENELEC EN 60 825:1991 for Class 1 laser products.



**CAUTION:**

**A class 3 laser is contained in the device. Do not attempt to operate the drive while it is disassembled. Do not attempt to open the covers of the drive as it is not serviceable and is to be replaced as a unit.**

Class 1 laser products are not considered to be hazardous. The optical drive contains internally a Class 3B gallium-arsenide laser that is nominally 30 milliwatts at 830 nanometers. The design incorporates a combination of enclosures, electronics, and redundant interlocks such that there is no exposure to laser radiation above a Class 1 level during normal operation, user maintenance, or servicing conditions.

---

## Data Integrity and Verification

IBM computer systems contain mechanisms designed to reduce the possibility of undetected data corruption or loss. This risk, however, cannot be eliminated. Users who experience unplanned outages, system failures, power fluctuations or outages, or component failures must verify the accuracy of operations performed and data saved or transmitted by the system at or near the time of the outage or failure. In addition, users must establish procedures to ensure that there is independent data verification before relying on such data in sensitive or critical operations. Users should periodically check the IBM support websites for updated information and fixes applicable to the system and related software.



---

## About This Book

This book provides information on how to use the system, use diagnostics, use service aids, and verify system operation. This book also provides information to help you solve some of the simpler problems that might occur.

---

## ISO 9000

ISO 9000 registered quality systems were used in the development and manufacturing of this product.

---

## Updating Microcode Levels

This device contains microcode that you can update. Contact your service representative for instructions on how to get the latest microcode levels for your device. To install the microcode, follow the instructions contained in the README file.

---

## Online Publications

RS/6000 publications are available online. To access the online books, visit our Web site at: [http://www.rs6000.ibm.com/resource/hardware\\_docs/](http://www.rs6000.ibm.com/resource/hardware_docs/)

---

## Related Publications

The following publications provide additional information about your system unit:

- The *System Unit Safety Information Guide*, order number SA23–2652, contains translations of safety information used throughout this book.
- The *RS/6000 44P Series Model 270 Service Guide*, order number SA38-0572, contains reference information, maintenance analysis procedures (MAPs), error codes, removal and replacement procedures, and a parts catalog.
- The *Diagnostic Information for Multiple Bus Systems*, order number SA38-0509, contains diagnostic information, service request numbers (SRNs), and failing function codes (FFCs).
- The *Adapter, Device, and Cable Information for Multiple Bus Systems*, order number SA38-0516, contains information about adapters, devices, and cables for your system. This manual is intended to supplement the service information found in the *Diagnostic Information for Multiple Bus Systems*.
- The *Site and Hardware Planning Guide*, order number SA38-0508, contains information to help you plan your installation.

---

## Trademarks

The following terms are trademarks of International Business Machines Corporation in the United States, other countries, or both:

- AIX
- IBM
- PowerPC Reference Platform
- RS/6000



---

# Chapter 1. Introducing the 44P Series Model 270

This chapter provides information on the system features of the 44P Series Model 270.

---

## System Features

### Bus Architecture

Five PCI slots are available:

- Two 64-bit PCI full-sized slots, running at 50 MHz (which can also run at 33 MHz), 5 volts, one of which is double-wide
- Three 32-bit PCI full-sized slots, running at 33 MHz, 3.3 volts

### Microprocessor

The 44P Series Model 270 can have one to four processors, running at a minimum of 375 MHz. Higher processor speeds are available.

### Memory

- 256 MB (minimum) to 16 GB (maximum)
- Up to two memory cards with 16 DIMMs (each DIMM must be installed in matched pairs)

### Media Drives

- Standard 3.5-inch, 1.44 MB diskette drive
- 32x speed CD-ROM drive with sliding tray (no caddy required)
- Two bays for internal hard disk drives:
  - 9.1 GB Ultra SCSI Drive
  - 18 GB Ultra SCSI Drive

### Other Drives

- One additional drive bay can accommodate one 5.25-inch or one 3.5-inch drive, such as a hard-disk drive, CD-ROM drive, or tape drive.

### Power Supply

- 640-watt, usable with 100-127 v ac (low voltage) or 200-240 v ac (high voltage)

## **Keyboard**

- Standard: 101-key Enhanced Keyboard
- Optional: 101/102 or 106 key Enhanced Keyboard

## **Mouse**

- 3-button

## **Operator Panel**

- 32-character LED diagnostics display
- Power and Reset buttons

## **Input/Output Ports**

- 25-pin Parallel
- 9-pin Serial (2)
- 8-pin Tablet
- Keyboard
- Mouse
- Ultra2 SCSI LVD
- 10Base5 Ethernet
- 10/100BaseTX Ethernet
- Audio Line-in
- Audio Line-out
- Microphone
- Headphone

## **Security Features**

- General-access password
- Privileged-access password

## Front View

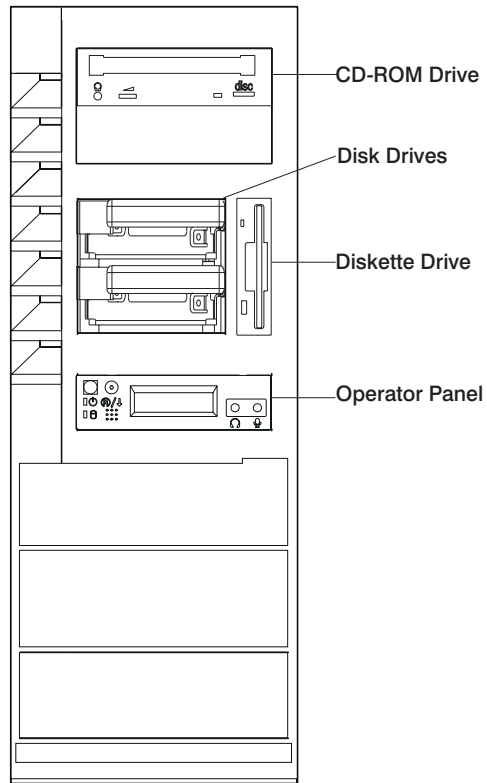

## Operator Panel

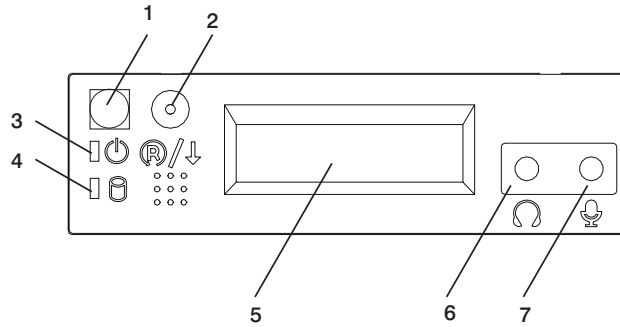

**1 Power-On Switch:** Turns system unit power on and off.

**2 Reset Switch:** Function depends upon the operating system.

**3 Power-On LED:** Glows when system unit is on.

**4 Hard Disk Drive Status LED:** Glows when system unit is reading from or writing to the disk drive.

**5 Operator Panel Display:** Displays current status of system unit startup, or diagnostic information in the event of a hardware problem.

**6 Headphone Jack:** For connecting audio headphones.

**7 Microphone Receptacle:** For connecting audio microphone.

## Rear View

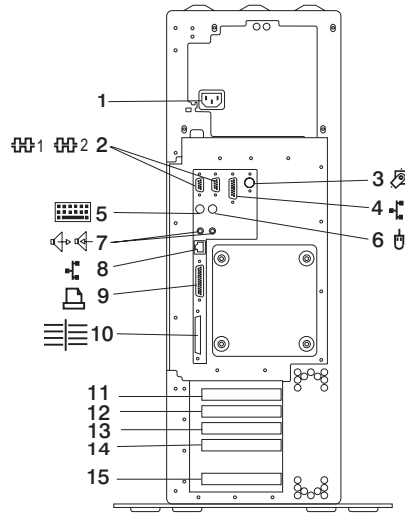

**1 Power Connector:** For connecting the power cable.

**2 9-Pin Serial Ports:** For a TTY terminal, modem, or other serial device.

**3 Tablet Port:** For attaching a digitizing tablet to your computer.

**4 10Base5 Ethernet Port:** For attaching your computer to an Ethernet thick connection (or Ethernet thin connection, using an optional transceiver) through a 10base5 connector.

**5 Keyboard Port:** For keyboard connection.

**6 Mouse Port:** For mouse connection.

**7 Audio Ports:** Audio line out, Audio line in

**8 10/100 BaseT Ethernet Port:** For attaching your computer to an Ethernet/Twisted pair connection through a 10baseT connector.

**9 Parallel Port :** For connecting a parallel printer or other parallel devices.

**10 External SCSI Port:** For connecting external SCSI devices.

**11-15 Expansion Slots:** For adding PCI adapters.

**11 Expansion Slot 5**

**12 Expansion Slot 4**

**13 Expansion Slot 3**

**14 Expansion Slot 2**

**15 Expansion Slot 1**



---

## Chapter 2. Using the 44P Series Model 270

This chapter provides information on how to start and use the system unit.

---

### Starting the System Unit

1. Set the power switches of the attached devices to On.

**Note:** When the system is plugged in but not powered on, the Power-On LED flashes slowly.

2. If the LED is not flashing and 0K is not displayed, ensure that the power cord, located at the back of the system unit, is plugged into a grounded electrical outlet.
3. If this does not solve the problem, go to “Chapter 8. Hardware Problem Determination” on page 149.
4. Press the Power-On switch (1).

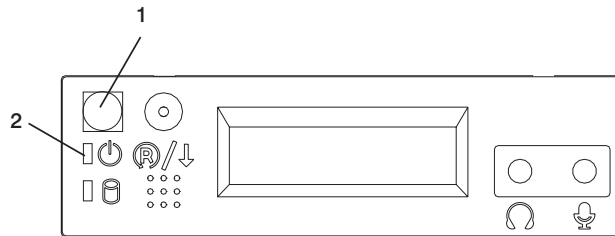

When you press the Power-On switch (1), the Power-On LED (2) comes on, and the system starts a POST (power-on self test).

During POST, progress codes display in the operator panel display.

5. If the Power-On LED does not come on and there is no indication of power when you press the Power-On switch, go to “Chapter 8. Hardware Problem Determination” on page 149.

---

### Stopping the System Unit

**Attention:** When you use the shutdown procedure for your system, follow the correct shutdown procedure before you stop the system unit. Failure to do so can result in the loss of data. The System unit is powered down by the shutdown procedure.

1. At a command line, type shutdown to stop the operating system.
2. After you shut down the operating system, set the power switches of any attached devices to Off.
3. If you will be servicing the system unit, unplug the system-unit power cable from the electrical outlet.

---

## Reading the Operator Panel Display

The operator panel display is used to:

- Track the progress of the system unit self-tests and configuration program
- Display codes when the operating system comes to an abnormal end
- Display system messages

## Operator Panel

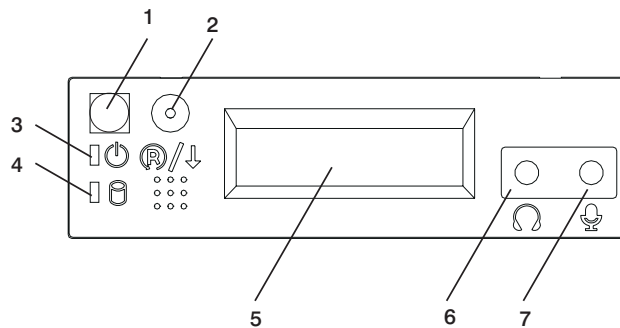

- 1 Power On Switch:** Turns system unit power on and off.
- 2 Reset Switch:** Function depends upon the operating system.
- 3 Power-On LED:** Glows when system unit is on.
- 4 Hard Disk Drive Status LED:** Glows when system unit is reading from or writing to the disk drive.
- 5 Operator Panel Display:** Displays current status of system unit startup, or diagnostic information in the event of a hardware problem.
- 6 Headphone Jack:** For connecting audio headphones.
- 7 Microphone Receptacle:** For connecting audio microphone.



---

## Using the Keyboards

There are several keyboards available for the system unit. The keyboards have various keys that enter data and control the cursor location. The keyboards can be engraved for the languages of various countries.

The functions of each keyboard depend on the software used. The character sets for the keyboards are explained in the documentation for your operating system.

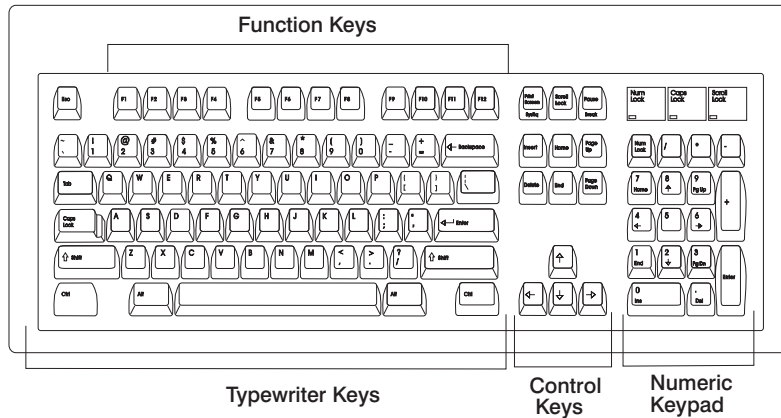

The keyboard is divided into four sections:

- *Function keys* are multipurpose keys and their function is controlled by the operating system.
- *Typewriter keys* are similar to a standard typewriter. Their function is controlled by the software.
- *Control keys* move the cursor on the screen and do programmed control functions. The movement and functions depend upon the application used.
- *Numeric keypad* is arranged like a calculator to help when typing numbers.

On all of the keyboards, you can adjust the tilt position for typing comfort. To tilt the keyboard, pull out on the keyboard legs. The legs snap into position. To decrease the tilt of the keyboard, rotate the keyboard legs until they snap into the bottom of the keyboard case.

The keyboard cable plugs into the keyboard connector at the rear of the system unit.

---

## Using the Three-Button Mouse

The mouse is a hand-operated locating device. A three-button mouse is available for use with the system unit. Consult your application publication for the exact use of the three-button mouse.

You can use the mouse to perform such functions as positioning a cursor, selecting items from a menu, or moving around in your document much easier and faster than if you used only the keyboard. The cursor moves exactly as you move the mouse on a flat surface, such as a desktop.

With the mouse buttons, you can perform functions such as selecting and deselecting options, extending your selection, or choosing a command. The precise function of your mouse depends on the software you are using.

The mouse has a cable that plugs into the mouse connector at the rear of the system unit.

## Handling the Mouse Correctly

For best operation, handle the mouse with care. Incorrect handling can damage the mouse.

Do not:

- Operate the mouse on cloth, unfinished wood, newspaper, or carpet.
- Drop or hit the mouse.
- Carry the mouse by holding onto the cable.
- Expose the mouse to extreme temperatures or direct sunlight.
- Place the mouse in liquid spills.

## Caring for the Mouse

The operating surface for the mouse should be smooth, clean, and flat. For example, you can operate the mouse on the following surfaces:

- Finished wood
- Glass
- Enamel
- Plastic
- Paper (except newspaper)
- Metal

Rough surfaces collect contaminants that can be transferred to the interior of the mouse by the ball.

Rough surfaces can also cause the pads on the bottom of the mouse to prematurely wear. A deeply pitted surface could cause erratic operation of the mouse.

The surface you use should be free from spills, dirt, dust, lint, wax, eraser dust, and other foreign matter.

To care for the mouse:

- Inspect the work surface for spills or other contaminants.
- Dust the work surface.
- If you are using a paper pad, inspect it for wear and replace it if necessary.

## Cleaning the Mouse

Use the following steps to clean the mouse:

1. Remove the retaining ring by turning it counterclockwise, in the direction of the arrow, as shown in the illustration.

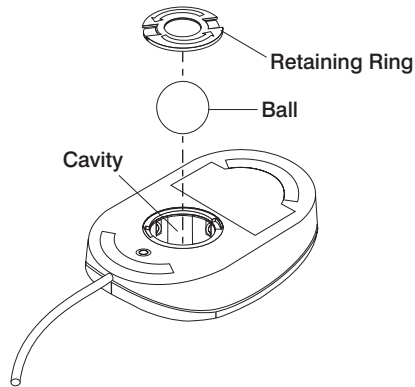

2. Remove the ball.
3. Inspect the ball for contaminants. Wipe it clean with a dry, lint-free cloth.
4. If the ball is dirty, wash it in warm, soapy water. Rinse and wipe the ball with a lint-free cloth until dry.
5. Inspect the ball cavity in the mouse for foreign materials. If there are any foreign materials, remove them.
6. Replace the ball.

7. Replace the retaining ring on the mouse and align it with the open slots in the ball cavity.
8. Turn the retaining ring clockwise until the open slots are covered and you hear the ring snap into place.

---

## Using the 3.5-Inch Diskette Drive

The system unit has a 1.44 MB diskette drive installed vertically in the front.

The 1.44 MB diskette drive can format, read, and write diskettes compatible with the following diskette drives:

- 1.0 MB diskettes with 720 KB formatted data capacity
- 2.0 MB diskettes with 1.44 MB formatted data capacity (HD)

Format the diskette according to its specified capacity.

## Write-Protecting 3.5-Inch Diskettes

Write-protecting diskettes is necessary so that important information is not accidentally lost. When diskettes are write-protected, you can read information from the diskettes, but you cannot write information to them.

There is a write-protect tab on the 3.5-inch diskette. To locate the write-protect tab, turn the diskette over with the label facing down.

To prevent writing onto a diskette, slide the write-protect tab to open the protect slot, as shown in the illustration.

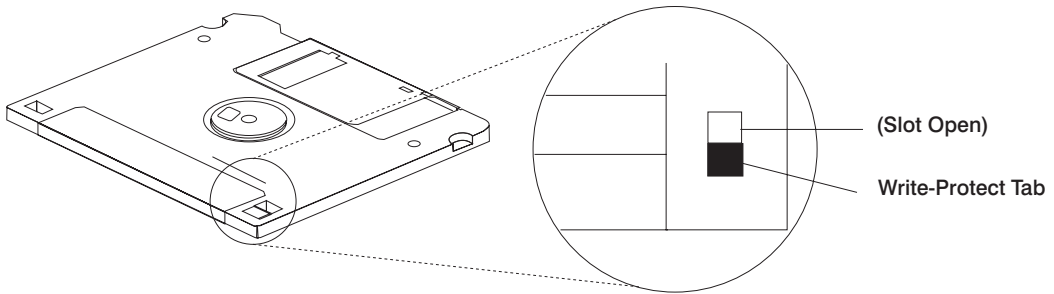

To allow writing onto a diskette, slide the write-protect tab to cover the protect slot, as shown in the illustration.

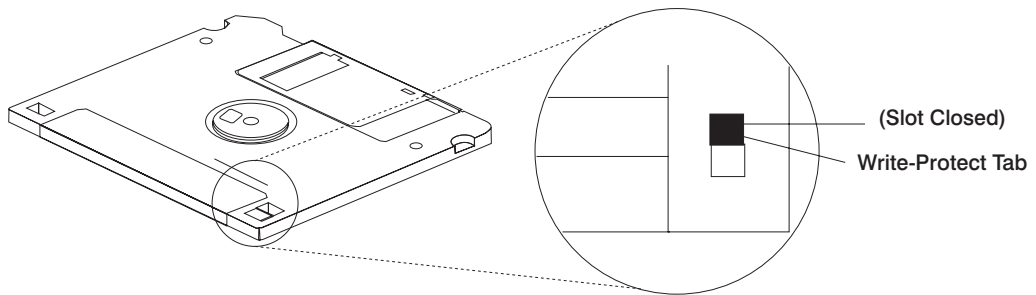

## Loading and Unloading the 3.5-Inch Diskette

To load a diskette into the drive, insert the diskette in the diskette drive with the labeled metal shutter first. Push the diskette into the drive until you hear a click. The click indicates that the diskette is securely in position in the drive.

To unload the diskette, push the diskette-unload button. The diskette unloads partially from the drive. Remove the diskette.

---

## Using the CD-ROM Drive

### **CAUTION:**

**A Class 1 laser is contained in the device. Do not attempt to operate the device while it is disassembled. Do not attempt to open the covers of the device, as it is not serviceable and is to be replaced as a unit.**

This section describes the features of the 32X SCSI-2 CD-ROM Drive and provides instructions for handling the drive and CD-ROM discs. The CD-ROM is a half-high, 5.25", 8-bit, single-ended, tray-loading drive. Its features include the following:

- SCSI-2 interface supports both synchronous and asynchronous data transfer
- High-speed data transfer rate of 2100 KB per second (14X) at inner diameter and 4800 KB per second (32X) at outer diameter due to constant RPM spin rate
- High-speed synchronous burst rate of 10 MB per second
- Average random access time of 90 ms
- Loading tray accommodates both 8 cm discs (in the horizontal orientation only) and 12 cm discs
- Reads multi-session discs
- Reads CD-recordable discs
- Reads CD-RW discs
- Supports all major CD-ROM formats: Mode 1, Mode 2, XA, CDDA, and audio
- Contains headphone output and line output for audio

## Front View of CD-ROM Drive

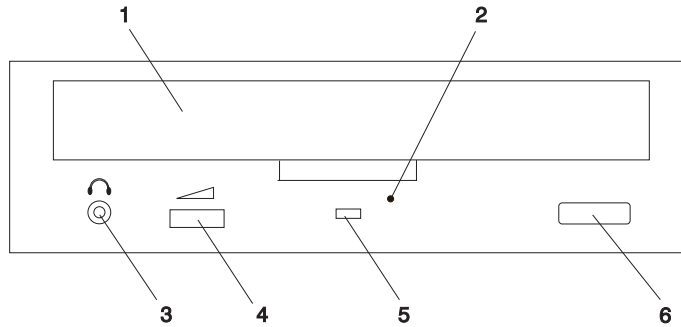

- 1 Compact Disc Tray
- 2 Emergency Eject Hole
- 3 Headphone Jack
- 4 Volume Control
- 5 Status Light
- 6 Load/Unload Button

## Understanding the Status Lights

The status lights indicate the operational status of the drive. The various conditions are explained below.

If light is:	Condition is:
Off	Drive is in standby mode with or without a disc loaded.
Blinking (green)	Any of the following: <ul style="list-style-type: none"> <li>• Drive tray is inserted. The light blinks while the drive completes the initialization checkout.</li> <li>• Drive is reading data. The light blinks while data is being read.</li> <li>• Drive is in Play Audio Mode. The light blinks while the audio is playing.</li> </ul>
On (amber)	Hardware error condition found during initialization. <b>Note:</b> If this occurs, contact your service representative.

## Handling Compact Discs

Compact discs are high-density media that must be handled with care and kept clean to ensure that they remain readable. Use the following precautions to ensure reliability:

- Hold the compact disc by the edges. Do not touch the surface of the compact disc.
- To remove dust or fingerprints, wipe the compact disc from the center to the outside of the compact disc as shown, using a lint-free cloth.

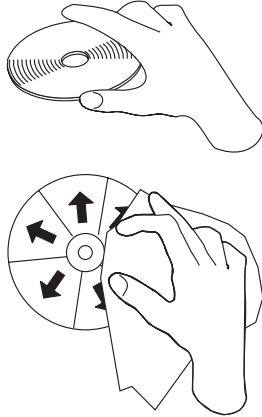

**Attention:** Wiping the compact disc in a circular direction can cause loss of data.

- Do not write on the surface.
- Do not store or place the compact disc in direct sunlight.
- Do not use benzene, thinners, or other cleaners to clean the compact disc.
- Do not bend the compact disc.

## Other Handling Considerations

Be sure to take the following additional precautions when you use the 32X SCSI-2 CD-ROM Drive:

- Remove compact discs from the tray before you move the drive anywhere.
- Do not place the drive where any of the following conditions exist:
  - High temperature
  - High humidity
  - Excessive dust
  - Excessive vibration or sudden shock
  - Inclined surface
  - Direct sunlight
- Do not insert foreign objects into the drive.
- Do not remove the drive covers or attempt to service the drive yourself.



## Loading a Compact Disc

To load a compact disc into the drive, do the following:

1. Press the Load/Unload button to open the tray. The tray slides out of the drive.
2. Place the compact disc in the tray with the label facing up.
3. Press the Load/Unload button, or gently push in the tray, to close the tray.

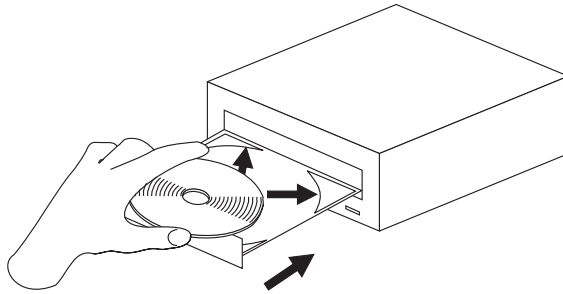

**Note:** Be sure that none of the vertical retaining tabs are extended when you use the drive in the horizontal position.

## Opening the Tray Manually

The compact disc tray automatically opens when you press the Load/Unload button. If it does not automatically open, follow these steps to force it open manually:

1. Shut down and turn off the power to your system unit.
2. Insert the straightened end of a paper clip into the emergency eject hole until you feel some resistance. See "Front View of CD-ROM Drive" on page 15 if you are not sure where the emergency eject hole is located.
3. Continue to push in the paper clip while you pull out the tray with your fingernail.
4. Pull the tray completely open and remove the disc. It is normal for the tray to make a clicking sound while you are pulling it open.

## Playing an Audio CD

To play an audio CD, you must have headphones connected to the headphone jack located on the front of the drive, or connected to the line-out connector located on the back of the system. You must also have an audio software application installed.

The headphone jack provides the connection for headphones using a 3.5 mm (1/8") stereo mini-plug. The volume control adjusts the audio output level for the headphones.

---

## General Information for the 8mm Tape Drive

The 8mm Tape Drive is an internal streaming tape drive that provides medium to high-capacity backup and archival capability, as well as a high data-transfer rate. The 8mm Tape Drive uses wide bus architecture. Communications on the SCSI bus can be either asynchronous or synchronous. The 8mm Tape Drive is read only compatible with existing 2.3 GB, 5.0 GB, and 7.0 GB 8 mm tape drives. The 8mm Tape Drive is a boot device.

The tape drive is used primarily for:

- Saving and restoring system data files
- Archiving important records
- Distributing operating system software upgrades

The drive conforms to the American National Standards Institute (ANSI) SCSI-2 standard.

Features of the 8mm Tape Drive include:

- Use of 8 mm data cartridges.
- Compression capability, effectively doubling the native capacity and data rate. The actual capacity per cartridge varies depending on the application and the type of data cartridge being used.

**Note:** The factory default setting is *Activated*. Data compression is usually controlled by the application software.

- A half-high 5.25-inch form-factor.
- An LCD display that provides operating and error messages.
- Status lights that indicate:
  - When it is time to clean the tape drive
  - When the tape is in motion
  - When the drive is ready to accept tape motion commands

## Front View of the 8mm Tape Drive

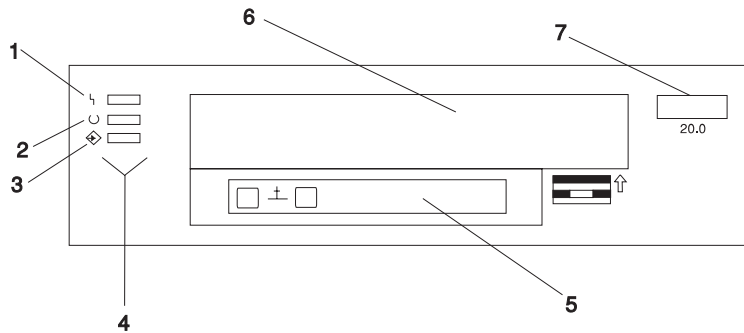

- |   |                     |
|---|---------------------|
| 1 | Disturbance (amber) |
| 2 | Ready (green)       |
| 3 | Activity (green)    |
| 4 | Status lights       |
| 5 | LCD display         |
| 6 | Tape drive door     |
| 7 | Unload button       |

## Operating Recommendations

- Handle the drive carefully and by its external metal chassis. Keep your hands away from the printed circuit boards, components, and printed circuit (flex) cables.
- If possible, work on a cushioned surface, and do not drop the tape drive onto the work surface.
- If you move the tape drive to an environment that is colder or warmer than its previous environment, keep the drive in its package and allow the package to reach the current room temperature. This prevents potential data loss or damage to the tape drive. Allow one hour of acclimation for each 10 degrees C (18 degrees F) difference between the shipping and/or storage temperature and the room temperature.
- Use only high-quality data grade 8 mm tape cartridges recommended by the manufacturer (see “Obtaining Additional Tape Cartridges” on page 29).
- Remove the tape cartridge from the tape drive when it is not in use, and store the cartridge in the cartridge case.
- Do not open the door on the data tape cartridge. This door covers and protects the magnetic tape material from dirt, dust, and damage.
- Avoid touching the tape, as doing so can cause loss of data.
- Back up any tape cartridge that repeatedly produces error messages, then discard the old tape cartridge. Error information is saved in the system error log.
- Clean the tape path regularly according to the cleaning procedure described in “Cleaning the Tape Drive” on page 27. Use only recommended cleaning cartridges. Other cleaning cartridges can permanently damage the tape drive.

## 8 mm Tape Cartridge Types

There are different types of 8 mm tape cartridges that you can use for the following purposes:

Type	Purpose
Test Tape Cartridge	Checks the operation of the drive or to run diagnostics. Do not use it to save programs or data. This cartridge, which is specially labeled, is included with the 8mm Tape Drive.
Data Tape Cartridge	Saves your programs or data. This cartridge is included with the 8mm Tape Drive.
Cleaning Tape Cartridge	Cleans the 8 mm tape drive. See “Cleaning the Tape Drive” on page 27. This cartridge is included with the 8mm Tape Drive.

## Tape Cartridge Compatibility

The 8mm Tape Drive is compatible with existing 8 mm tape subsystems that comply to the American National Standard (ANSI) X3B5-89-136, Rev. 6, Helical-scan Digital Computer Tape Cartridge, 8 mm for Information Exchange. Refer to the following table for information about specific tape compatibility.

Format Modes (C=compression mode)								
8mm Tape Drive	2.3GB	2.3 GB (C)	5.0 GB	5.0 GB (C)	7.0 GB	7.0 GB (C)	20.0 GB	20.0 GB (C)
2.3 GB	Read / Write	-	-	-	-	-	-	-
5.0 GB	Read / Write	Read / Write	Read / Write	Read / Write	-	-	-	-
7.0 GB	Read / Write	Read / Write	Read / Write	Read / Write	Read / Write	Read / Write	-	-
20.0 GB	Read Only	-	Read Only	Read Only	Read Only	Read Only	Read / Write	Read / Write

## Setting the Write-Protect Tab on 8 mm Tape Cartridges

Set the write-protect tab on a tape cartridge so that you do not accidentally lose information. The window on the tape cartridge controls write-protection. When the window on a tape cartridge is closed, write-protection is set and information can be read from the tape, but not written to it. When the window on a tape cartridge is open, write-protection is not set and information can be read from the tape and written to it.

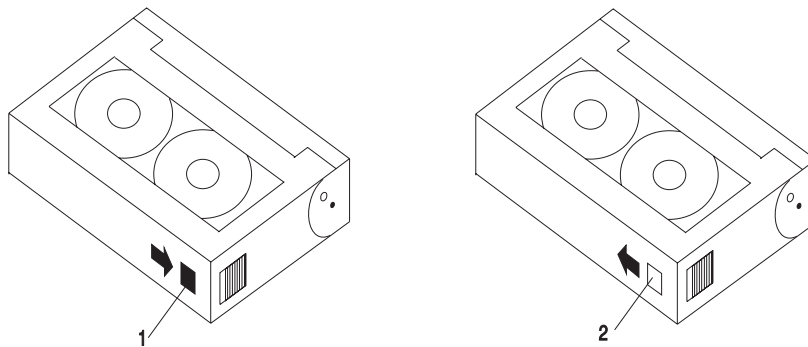

- 1 Window open: Write-protect tab not set
- 2 Window closed: Write-protect tab set

## Environmental Considerations for 8 mm Data Cartridges

This section describes operating and storage conditions for data cartridges, including temperature, relative humidity, and maximum wet bulb data.

**Attention:** The manufacturer specifies a set of temperature and humidity ranges in which the 8 mm data cartridge can operate with ease. Only regular cleaning procedures are required when operating the cartridge within this range. The risk of possible data loss is increased if 8 mm tape cartridges are operated, stored, or shipped outside the temperature or humidity ranges shown in the following table.

Condition	Operating Ranges	Storage	Shipping
Temperature	60°F-90°F (16°C-32°C)	41°F-90°F (5°C-32°C)	-40°F-126°F (-40°C-52°C)
Relative Humidity (non-condensing)	20%-80%	20%-80%	20%-80%
Maximum Wet Bulb	73°F (23°C)	79°F (26°C)	79°F (26°C)

Always let a cartridge acclimate to the operating environment before you use it. Acclimation is necessary for any data cartridge that has been exposed to a different humidity environment or to a temperature change of 11°C or 20°F or more. Place the cartridge, with its container, in the operating environment for as long as it has been away from the operating environment or for 24 hours, whichever is less.

## Operating the 8mm Tape Drive in Harsh Environments

The 8mm Tape Drive is ideally suited to streaming operations rather than tape movement operations involving multiple stops and starts as well as random searches. You should use streaming movement whenever possible.

Do not use for archiving any tape that was previously used outside the ranges specified in "Environmental Considerations for 8 mm Data Cartridges" for an extended period of time. Exposure to the new environment deteriorates the magnetic and physical strength of the tape. Do not store important data on a tape that was used outside the specified ranges. For reliable archiving, transfer the data to a new tape.

## Erasing 8 mm Data Cartridge

Most bulk eraser devices cannot erase 8 mm data cartridges. To erase an 8 mm data cartridge with a bulk eraser device, the erasure rating must be at least 1500 oersted.

---

## Using the 8mm Tape Drive

This section provides information about operating, using, and maintaining your 8mm Tape Drive.

### Status Lights

The 8mm Tape Drive has two green status lights and one amber status light. The on and off combinations of the status lights indicate the current condition of the tape drive.

Each of the International Organization for Standards (IOS) symbols located next to a status light indicates a specific condition of the tape drive as follows:

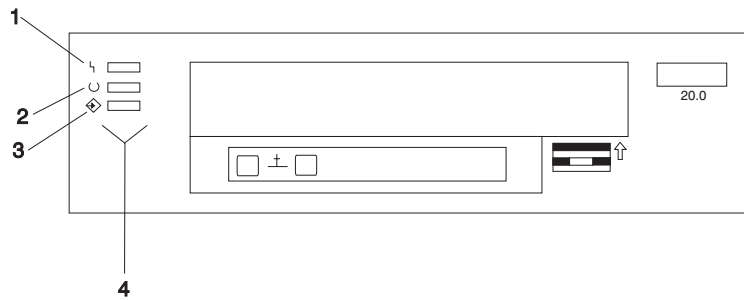

- 1 Disturbance (amber)
- 2 Ready (green)
- 3 Activity (green)
- 4 Status lights

Status	Disturbance (amber)	Ready (green)	Activity (green)
The power-on self-test (POST) is running or the system has issued a Reset to the drive.	On	On	On
One of the following has occurred: <ul style="list-style-type: none"> <li>The power is off.</li> <li>The POST has completed successfully, but no tape cartridge has been inserted.</li> </ul> See note 2.	Off/On	Off	Off
A tape cartridge has been inserted, and the 8mm Tape Drive is ready to receive commands from the system. See note 2.	Off/On	On	Off
A tape cartridge has been inserted, and the 8mm Tape Drive is performing a tape load or unload operation. See note 2.	Off/On	Off	Flashing
The tape is in motion, and the 8mm Tape Drive is busy running a device operation. See note 2.	Off/On	On	Flashing
The 8mm Tape Drive has detected an internal fault that requires corrective action. See note 1.	Flashing	Off	Off
The tape path requires cleaning. Refer to "Cleaning the Tape Drive" on page 27.	On	Off or On	Off or Flashing

**Notes:**

1. If a fault or an error condition occurs, press the unload button for approximately 15 seconds to reset the drive. If the disturbance light still flashes after the reset, contact your service representative for assistance.
2. If the disturbance light is on, cleaning is required. See "Cleaning the Tape Drive" on page 27.

## Liquid Crystal Display

The 8mm Tape Drive features a liquid crystal display (LCD), which is located on the front panel. The LCD displays operating and error messages.

## Changing the Display Language

The text on the 8mm Tape Drive LCD is available in several languages. To change the language do the following:

1. Press and hold the unload button after you turn the power on to the 8mm Tape Drive or, if your system unit is already running, press and hold the unload button for approximately 15 seconds until the LCD displays RESET. Release the unload button for approximately one second, then press and hold the unload button again.
2. After the LCD cycles through all the reset messages, it cycles through the available languages. When the desired language displays, release the unload button.



## Loading the 8 mm Tape Cartridge

Before loading the tape cartridge, make sure the system unit power is on and that the write-protect tab on the tape cartridge is set correctly. Refer to “Setting the Write-Protect Tab on 8 mm Tape Cartridges” on page 21. The tape drive loads the tape from the cartridge and prepares it for reading and writing.

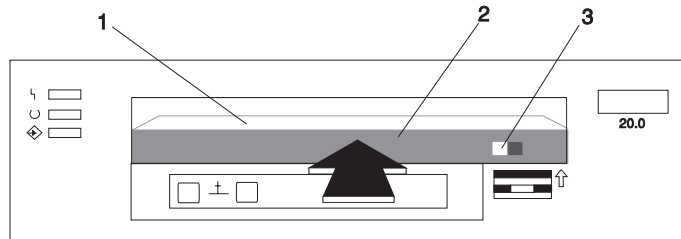

- 1 Window side of tape cartridge
- 2 8 mm tape cartridge
- 3 Write-protect tab

To load the 8 mm tape cartridge, do the following:

1. Grasp the edges of the 8 mm tape cartridge with the write-protect tab toward you and the window side of the cartridge facing up.
2. Slide the tape cartridge into the opening on the front of the 8 mm tape drive until the loading mechanism pulls the cartridge into the drive and the drive door closes. The ready status light (green) comes on if the load operation was successful.

The tape drive is ready for data operations when the tape cartridge is inserted. After the cartridge is inserted into the tape drive, the tape takes about 25 seconds to load.

Commands can be entered while the tape is loading. Any commands to the tape drive start running after the tape has finished loading. Commands not requiring the tape cartridge are run immediately.

## Unloading the 8 mm Tape Cartridge

Before you perform the unload operation, make sure the power to the system unit is on.

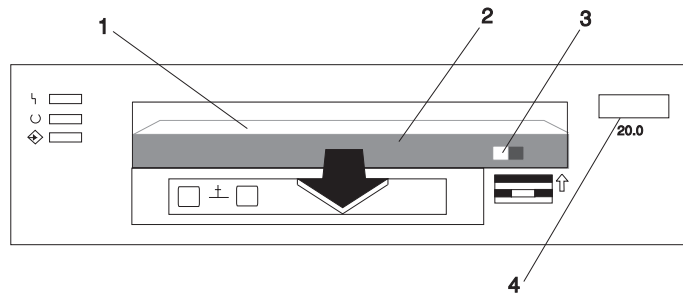

- 1 Window side of tape cartridge
- 2 8 mm tape cartridge
- 3 Write-protect tab
- 4 Unload button

To unload and eject the tape cartridge, press the unload button. The tape drive rewinds the tape, then ejects the tape cartridge from the tape drive. After you press the unload button, the following actions occur:

- The ready status light goes off.
- The read/write status light flashes during the unload operation.
- The read/write status light goes off when the cartridge is ejected from the tape drive.

The time required for a tape to rewind and unload is between 18 seconds and 3 minutes, depending on the position of the tape when you push the unload button.

If a fault or an error condition occurs and you cannot eject the tape, press the unload button for approximately 15 seconds to reset the drive. If the tape cartridge cannot unload and has to be removed manually from the drive, contact your service representative.

## Cleaning the Tape Drive

**Attention:** Do not use video-cleaning cartridges in the 8mm Tape Drive. Video-cleaning cartridges can damage the system drive.

Clean the tape drive:

- After you use a metal particle (MP) tape and before you use an advanced metal evaporative (AME) tape
- When error rates exceed an acceptable level as indicated by the LED and message
- Every 72 hours of tape motion as indicated by the LED and message

The 8mm Tape Drive counts the number of hours of tape motion. When it is time to clean the tape path, it displays the message \* \* CLEAN S00N and turns on the top status light.

You must clean the tape after using metal particle (MP) media and before using advanced metal evaporative (AME) tapes. If you use MP media, the LCD prompts you to clean the tape path by displaying the message MUST CLEAN.

More frequent cleaning may be required if you operate the drive in a dusty environment or in humid conditions. If you allow dust to accumulate, the drive has to perform more reads and writes. This can damage the drive or cause data loss, which can be prevented by regular cleaning.

The cleaning cartridge cleans the 8mm Tape Drive 18 times before you must discard it. If you attempt to use an 8 mm cleaning cartridge more than 18 times, the tape drive automatically detects the error, ejects the cleaning cartridge with the amber disturbance status light remaining on, and displays the message DEPLETED.

Before you load the cleaning cartridge, make sure the power to the tape drive is on.

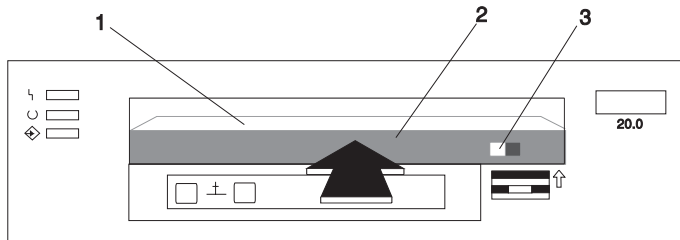

- 1 Window side of tape cartridge
- 2 8 mm cleaning cartridge
- 3 Write-protect tab

To clean the tape path, do the following:

1. Grasp the edges of the 8 mm cleaning cartridge with the window side of the cartridge facing up. Slide the cartridge into the opening on the front of the 8mm Tape Drive until the loading mechanism pulls it into the drive.
2. After you fully insert the 8 mm cleaning cartridge into the 8mm Tape Drive, the following cleaning operations are automatically performed:
  - The cleaning tape loads into the tape path. The message `CLEANING...` displays. The cleaning cycles take approximately two minutes.
  - The tape unloads and the cleaning cartridge ejects from the tape drive upon completion of the cleaning operation.
  - The amber disturbance status light goes off if the cleaning operation was successful.
3. Record the use of the cleaning cartridge on the cartridge.

## Obtaining Additional Tape Cartridges

Use only tape cartridges recommended by the manufacturer in the 8mm Tape Drive. Contact your customer service representative or the place of purchase to obtain the recommended tape cartridges.

---

## General information for the 12/24GB 4mm Tape Drive

The 12/24GB 4mm Tape Drive is an internal streaming tape drive that provides medium to high-capacity backup and archival capability as well as high data-transfer rate. The 12/24GB 4mm Tape Drive uses NARROW bus (8-bit) architecture. Communications on the SCSI bus can be either asynchronous or synchronous. The 12/24GB 4mm Tape Drive is compatible with existing 2.0 GB and 4.0 GB 4 mm tape drives. The 12/24GB 4mm Tape Drive can be used as a boot device.

The tape drive is used primarily for:

- Saving and restoring system data files
- Archiving important records
- Distributing operating system software upgrades.

The drive conforms to the American National Standards Institute (ANSI) SCSI-2 standard.

Features of the 12/24GB 4mm Tape Drive include:

- Use of 12/24 GB 4 mm data cartridges.
- Data rate of 1.1 MB/second.
- Capacity of 12 GB.
- Compression capability, which effectively doubles the native capacity of 12 GB and the effective data rate. The actual capacity per cartridge varies depending on the application and the type of data cartridge being used. The default is compressed. Use SMIT to change the default.

**Note:** The factory default setting is *Activated*. Data compression is usually controlled by the application software.

- A half-high 5.25-inch form-factor.
- Status lights that indicate:
  - When it is time to clean the tape drive
  - When the tape is in motion
  - When the drive is ready to accept tape motion commands.

## Front View of the 12/24GB 4mm Tape Drive

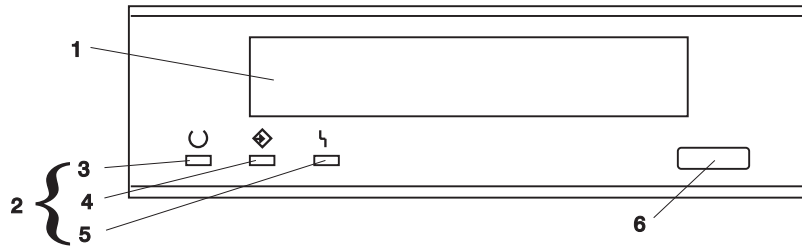

- |   |                     |
|---|---------------------|
| 1 | Tape Drive Door     |
| 2 | Status lights       |
| 3 | Ready (green)       |
| 4 | Tape Motion (green) |
| 5 | Disturbance (amber) |
| 6 | Unload/Reset button |

---

## Using the 12/24GB 4mm Tape Drive

This chapter provides information about operating, using, and maintaining your 12/24GB 4mm Tape Drive.

### Operating Recommendations

**Attention:** For optimum performance, always follow the recommendations listed below:

- Use only high-quality data- grade 12/24 GB 4 mm tape cartridges recommended by the manufacturer (see “Obtaining Additional Tape Cartridges” on page 38). Tape cartridges that do not carry the proper DDS symbol cannot be written to, and their use causes the 12/24GB 4mm Tape Drive to report an error.
- Remove the tape cartridge from the tape drive when it is not in use, and store the cartridge in the cartridge case.
- Do not open the door on the data tape cartridge. This door covers and protects the magnetic tape material from dirt, dust, and damage.
- Avoid touching the tape, as doing so can cause loss of data.
- Back up any tape cartridge that repeatedly produces error messages, then discard the old tape cartridge. Error information is saved in the system error log.
- Clean the tape path regularly according to the cleaning procedure described in “Cleaning the Tape Path on the 12/24GB 4mm Tape Drive” on page 37. Use only recommended cleaning cartridges. Other cleaning cartridges can permanently damage the tape drive.

## 12/24 GB 4 mm Tape Cartridge Types

The following types of 12/24 GB 4 mm tape cartridges can be used:

Type	Purpose
Test Tape Cartridge	Checks the operation of the drive or to run diagnostics. Do not use it to save programs or data. This cartridge, which is specially labeled, is included with the 12/24GB 4mm Tape Drive.
Data Tape Cartridge	Saves your programs or data. This cartridge is included with the 12/24GB 4mm Tape Drive.
Cleaning Tape Cartridge	Cleans the 12/24GB 4mm Tape Drive. See "Cleaning the Tape Path on the 12/24GB 4mm Tape Drive" on page 37. This cartridge is included with the 12/24GB 4mm Tape Drive.

## Tape Cartridge Compatibility

The tape drive is compatible with existing 12/24 GB 4 mm tape subsystems that are designed to operate with Digital Data Storage approved media (DDS-1, DDS|||, DDS-2, or DDS-3), which meet the following European Computer Manufacturers Association (ECMA) standards:

- ECMA-139 "3.81 Wide Magnetic Tape Cartridge for Information Interchange" – Helical Scan Recording – DDS Format.
- ECMA-139 "3.81 Wide Magnetic Tape Cartridge for Information Interchange" – Helical Scan Recording – DDS-2 Format.
- ECMA-139 "3.81 Wide Magnetic Tape Cartridge for Information Interchange" – Helical Scan Recording – DDS-3 Format.

## 4 mm Tape Write Density Setting

When reading a tape, the drive automatically determines which format is written on the tape.

When writing to a tape, use SMIT (System Management Interface Tool) to change the density setting of the tape drive to correspond to the type of media installed. Refer to the following table for information about the specific density setting:

Density Settings for 4 mm Media		
Media Type	Device Compatibility	SMIT Density Setting
DDS1	Read Only	N/A
DDS	Read / Write (2.0 GB Mode Only)	19
DDS2	Read / Write (4.0 GB Mode Only)	36
DDS3	Read / Write (12.0 GB Mode Only)	37

## Setting the Write-Protect Tab on 12/24 GB 4 mm Tape Cartridges

Set the write-protect tab on a tape cartridge so that you do not accidentally lose information. The write-protect tab on the tape cartridge controls write-protection. When the write-protect tab on a tape cartridge is closed, information can be read from the tape and written to it. When the write-protect tab on a tape cartridge is open, information can be read from the tape, but not written to it.

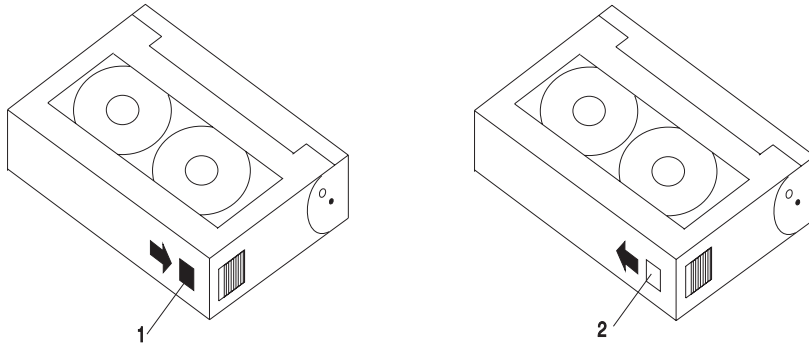

1 Write-protect tab closed: Write enabled

2 Write-protect tab open: Write disabled

## Erasing 12/24 GB 4 mm Data Cartridge

Most bulk eraser devices cannot erase 12/24 GB 4 mm data cartridges. To properly erase an 12/24 GB 4 mm data cartridge with a bulk eraser device, the erasure rating must be at least 3900 oersted.

## Environmental Considerations for 12/24 GB 4 mm Data Cartridges

This section describes operating and storage conditions for data cartridges, including temperature, relative humidity, and maximum wet bulb data.

**Attention:** The manufacturer specifies a set of temperature and humidity ranges in which the 12/24 GB 4 mm data cartridge can operate with ease. Only regular cleaning procedures are required when operating the cartridge within this range. The risk of possible data loss is increased if 12/24 GB 4 mm tape cartridges are operated, stored, or shipped outside the temperature or humidity ranges shown in the following table.

Condition	Operating Ranges	Storage	Shipping
Temperature	60°F-90°F (16°C-32°C)	41°F-90°F (5°C-32°C)	-40°F-126°F (-40°C-52°C)
Relative Humidity (non-condensing)	20%-80%	20%-80%	20%-80%
Maximum Wet Bulb	79°F (26°C)	79°F (26°C)	79°F (26°C)



Always let a cartridge acclimate to the operating environment before you use it. Acclimation is necessary for any data cartridge that has been exposed to a different humidity environment or to a temperature change of 11°C (20°F) or more. Place the cartridge, with its container, in the operating environment for as long as it has been away from the operating environment or for 24 hours, whichever is less.

## Operating the 12/24GB 4mm Tape Drive in Harsh Environments

The tape drive is ideally suited to streaming operations rather than tape movement operations involving multiple stops and starts and random searches. Use streaming movement whenever possible.

Do not use for archiving any tape that was previously used outside the ranges specified in "Environmental Considerations for 12/24 GB 4 mm Data Cartridges" on page 32 for an extended period of time. Exposure to the new environment deteriorates the magnetic and physical strength of the tape. Do not store important data on a tape that was used outside the specified ranges. For reliable archiving, transfer the data to a new tape.

## Status Lights

The 12/24GB 4mm Tape Drive has two green status lights and one amber status light. The on and off combinations of the status lights indicate the conditions of the 12/24GB 4mm Tape Drive.

Each of the International Organization for Standards (ISO) symbols located above a status light indicates a specific condition of the tape drive as follows:

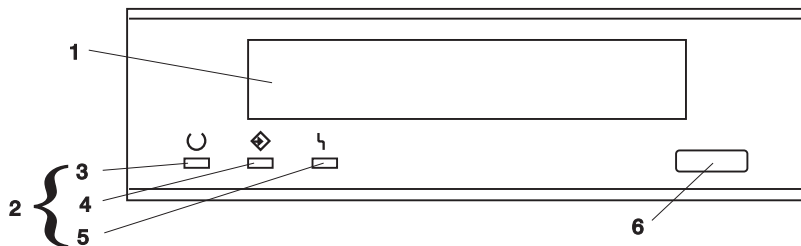

- 1 Tape Drive Door
- 2 Status lights
- 3 Ready (green)
- 4 Tape Motion (green)
- 5 Disturbance (amber)
- 6 Unload/Reset button

The following tables explain the meaning of the green and amber status lights.

Status	Ready (green)	Tape Motion (green)	Disturbance (amber)
Off	No cartridge installed or error condition	No cartridge or no activity	No error condition
Steady	Cartridge installed or loading/unloading		Cleaning required or worn media
Flashing	Power-on self-test in progress	Cartridge activity	Error condition

Status Lights on the 12/24GB 4mm Tape Drive				
Status	Ready (green)	Tape Motion (green)	Disturbance (amber)	
LED test	On 2 seconds at power on	On 2 seconds at power on	On 2 seconds at power on	
The power-on self-test (POST) is running or the diagnostic cartridge is running.	Flashing	Off	Off	
One of the following has occurred: <ul style="list-style-type: none"> <li>The power is off.</li> <li>The POST has completed successfully, but no tape cartridge has been loaded.</li> </ul> (See note 2 below.)	Off	Off	Off/On	
A tape cartridge has been inserted and the 12/24GB 4mm Tape Drive is ready to receive commands from the system. (See note 2 below.)	On	Off	Off/On	
The tape is in motion and the 12/24GB 4mm Tape Drive is running a device operation or cleaning. (See note 2 below.)	On	Flashing	Off/On	
The 12/24GB 4mm Tape Drive has detected an internal error that requires corrective action such as tape cartridge failure, high humidity. (See note 1 below.)	Off	Off	Flashing	
The tape path requires cleaning, or a poor quality tape cartridge is being used. See "Cleaning the Tape Path on the 12/24GB 4mm Tape Drive" on page 37.	Off or On	Off or Flashing	On	

**Notes:**

1. If a fault or an error condition occurs, press the unload button for approximately 15 seconds to reset the drive. If the disturbance light still flashes after the reset, contact your service representative for assistance.
2. If the disturbance light is on, cleaning is required. See "Cleaning the Tape Path on the 12/24GB 4mm Tape Drive" on page 37.

## Loading the 12/24 GB 4 mm Tape Cartridge

Before you load the tape cartridge, make sure the power is on and the write-protect tab on the tape cartridge is set correctly. Refer to “Setting the Write-Protect Tab on 12/24 GB 4 mm Tape Cartridges” on page 32. The tape drive loads the tape from the cartridge and prepares it for reading and writing.

To load the 12/24 GB 4 mm tape cartridge, do the following:

1. Grasp the edges of the 12/24 GB 4 mm tape cartridge with the write-protect tab towards you and the window side of the cartridge facing up.
2. Slide the tape cartridge into the opening on the front of the 12/24 GB 4 mm tape drive until the loading mechanism pulls the cartridge into the drive and the drive door closes. The ready status light (green) comes on if the load operation was successful.

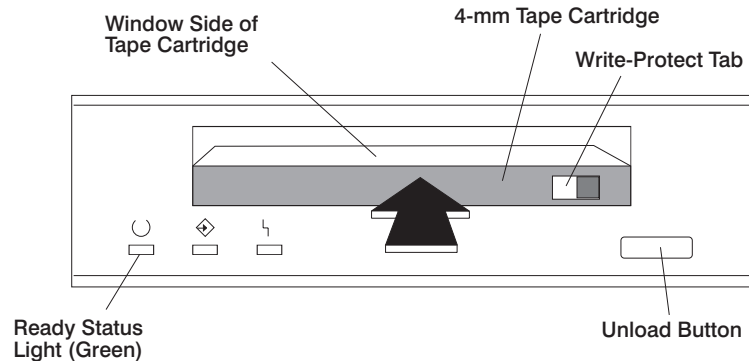

The 12/24GB 4mm Tape Drive is ready for data operations when the tape cartridge is inserted. After the cartridge is inserted into the tape drive, the tape takes about 15 seconds to load.

## Unloading the 12/24 GB 4 mm Tape Cartridge

Before performing the unload operation, make sure the power to the system unit is on.

To unload and eject the tape cartridge, press the unload button. The 12/24GB 4mm Tape Drive rewinds the tape and then ejects the tape cartridge from the tape drive.

After you press the unload button, the following occurs:

1. The Ready status light turns off.
2. The Tape Motion status light flashes during the unload operation.
3. The Tape Motion status light turns off when the cartridge is ejected from the tape drive.

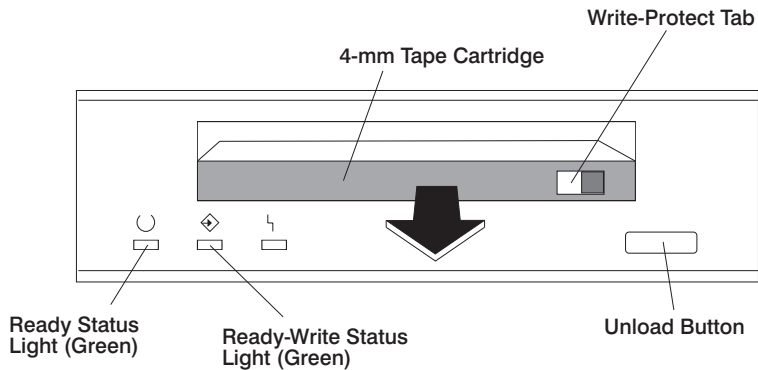

The time required for a tape to rewind and unload is between 10 seconds and 1.5 minutes, depending on the position of the tape when the unload button is pushed.

If a fault or an error condition occurs and you cannot eject the tape, press the unload button for approximately 15 seconds to reset the drive.

If the tape cartridge cannot unload and has to be removed manually from the drive, contact your service representative.

## Cleaning the Tape Path on the 12/24GB 4mm Tape Drive

Clean the 12/24 GB 4 mm tape path either approximately every 30 hours of tape motion or once a month, whichever occurs first. The 12/24 GB 4 mm tape drive monitors the recording quality of the tape cartridge and indicates that the tape path requires cleaning when the disturbance status light (amber) is on.

More frequent cleaning may be required if the drive is operated in a dusty environment or in humid conditions. If the dust is allowed to accumulate, the drive has to perform more reads and writes. This can cause data loss, and can be prevented by regularly scheduled cleaning of the drive. The amber disturbance status light also comes on automatically after 30 hours of tape motion without cleaning.

If you attempt to use a 12/24 GB 4 mm cleaning cartridge beyond 20 cleanings, the tape drive automatically detects an error and ejects the cleaning cartridge with the disturbance status light (amber) remaining on.

Before you load the cleaning cartridge, make sure the power to the system unit is on.

To load the 12/24 GB 4 mm cleaning cartridge, do the following:

1. Grasp the edges of the 12/24 GB 4 mm cleaning cartridge with the window side of the cartridge facing up.
2. Slide the cleaning cartridge into the opening on the front of the 12/24 GB 4 mm tape drive until the loading mechanism pulls the cartridge into the drive.

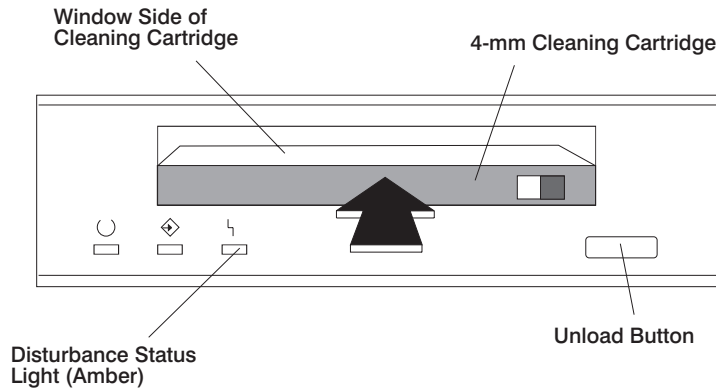

After the 12/24 GB 4 mm cleaning cartridge has been fully inserted into the 12/24GB 4mm Tape Drive, the following cleaning operations are performed automatically:

1. The cleaning tape is loaded into the tape path. The cleaning cycle lasts approximately 30 seconds.
2. The tape is unloaded and the cleaning cartridge is ejected from the tape drive when the cleaning operation is complete.

3. A successful cleaning operation is indicated when the disturbance status light (amber) goes off (if it was activated before the cleaning operation).

## Obtaining Additional Tape Cartridges

The following table lists the tape cartridges that you can order for the 12/24GB 4mm Tape Drive. Contact your customer service representative or the place of purchase to obtain the recommended tape cartridges.

Tape Cartridges for the 12/24 GB 4 mm Tape Drive		
Part Number	Type of Cartridge	Length
59H3465	12/24 GB 4 mm Data Cartridge	160 m (525 ft)
59H3466	12/24 GB 4 mm Test Cartridge	11.5 m (37.7 ft)
59H3090	12/24 GB 4 mm Cleaning Cartridge	N/A

---

## Using the Service Processor and Service Director Features

The Service Processor and Service Director features protect users against unnecessary system downtime by keeping support personnel (both internal and external) aware of any unexpected changes in the system environment. In combination, the two features provide a flexible solution to automated system maintenance.

### Service Processor

The Service Processor runs on its own power boundary and continually monitors hardware attributes, the AIX Operating System, and the environmental conditions within the system. Any system failure which prevents the system from returning to an operational state (a fully functional AIX Operating System) is reported by the Service Processor. The Service Processor is controlled by firmware and does not require the AIX Operating System to be operational to perform its tasks. If any system failures are detected, the Service Processor has the ability to take predetermined corrective actions. The methods of corrective actions are:

- Surveillance
- Call Home
- AIX Operating System Monitoring

Surveillance is a function in which the Service Processor monitors the system through heartbeat communication with the system firmware. The *heartbeat* is a periodic signal that the firmware can monitor. During system startup, the firmware surveillance monitor is automatically enabled to check for heartbeats from the firmware. If a heartbeat is not detected within a default period, the Service Processor cycles the system power and attempts to restart until the system either restarts successfully, or a predetermined retry threshold is reached. In the event the Service Processor is unsuccessful in bringing the system online (or in the event that the user asked to be alerted to any Service Processor assisted restarts), the system can call home to report the error.

The Call Home function can be initialized to call either a service center telephone number, a customer administration center, or a digital pager telephone number. The Service Processor can be configured to stop at the first successful call to any of the numbers listed, or can be configured to call every number provided. If connected to the service center, the Service Processor transmits the relevant system information (the system's serial number and model type) and Service Request Number (SRN). If connected to a digital pager service, the Service Processor inputs a Customer Voice Telephone Number defined by the customer. An established sequence of digits or the telephone number to a phone near the failed system could be used to signal a system administrator to a potential system failure.

During normal operations, the Service Processor can also be configured to monitor the AIX Operating System. If AIX does not respond to the Service Processor heartbeat, the Service Processor assumes the Operating System is hung. The Service Processor can automatically initiate a restart and, if enabled, initiate the call home function to alert the appropriate parties to the system hang. Enabling Operating System Surveillance also affords AIX the means to detect any Service Processor failures and report those failures to the Service Director application.

Unlike the Service Director, the Service Processor cannot be configured in a client/server environment where one system can be used to manage all dial-out functionality for a set of systems.

Prior to installing the Service Processor feature, ensure that you have the latest levels of Service Processor microcode and system firmware. You also need a properly configured modem. For more information on configuring a modem, see "Modem Configuration Menu" on page 54.

## **Service Director**

The Service Director is a software extension to the AIX Operating System that monitors the system while the AIX Operating System is running. The Service Director monitors and analyzes all recoverable system failures, and, if needed, can automatically place a service call to a service center (without user intervention).

The service center receives the machine type/serial number, host name, SRN, and a problem description. The service center analyzes the problem report and, if warranted, dispatches a service person to the customer site. The service center also determines if any hardware components need to be ordered prior to the service person's arrival.

The Service Director code also gives the user the option to establish a single system as the problem reporting server. A single system, accessible over the user network, can be used as the central server for all the other systems on the Local Area Network (LAN) who are running the Service Director application. If the Service Director application on a remote client decides a service request needs to be placed, the client forwards the information to the Service Director server, which dials the service center telephone number from its locally attached modem. In this scenario, the user only needs to maintain a single analog line for providing call-out capabilities for a large set of servers.

When used in a Scalable Parallel (SP) environment, a client/server type implementation is configured. The Service Director client code runs on each of the Scalable Parallel (SP) nodes. The server component runs on the Control Workstation. In the event of any system failures, the relevant information is transmitted to the Control Workstation through the integrated Ethernet. After it has been alerted to the system failure, the Control Workstation initiates actions to prepare and send the service request.

A modem is required for enabling automated problem reporting to the service center. Configuration files for several types of modems are included as part of the Service Director package. Refer to "Modem Configuration Menu" on page 54 for more information on configuring your modem.



## Chapter 3. Using the Service Processor

The service processor menus enable you to configure service processor options and to enable and disable functions.

Service processor menus are available using an ASCII terminal when the server is turned off and the service processor is operating with standby power. Service processor menus are also available when server power is on and the service processor has detected a server problem (such as loss of surveillance).

During the first power-up (that is, the power cord is plugged into the outlet), service processor menus are not available for 45 seconds while the service processor is running self-tests and initializing the server. If the server powers down, service processor menus become available after 15 seconds.

For a summary of the service processor functions and the methods for invoking them, see the table below.

Service Processor Functions	Service Processor Menus (ASCII terminals)	AIX Service Aids (ASCII or graphics terminals)	SMS (ASCII or graphics terminals)
View System Environmental Conditions	Y <sup>3</sup>		
Read System POST Errors	Y <sup>3</sup>		
Read Service Processor Error Logs	Y <sup>3</sup>		
View Progress Indicators from last Boot	Y <sup>3</sup>		
Power-on System	Y <sup>3</sup>		
Power-off System	Y <sup>2</sup>		
Read NVRAM	Y <sup>2</sup>		
Reset Service Processor	Y <sup>2</sup>		
Setup Reboot/Restart Policy	Y <sup>2</sup>		
Start Talk Mode	Y <sup>2</sup>		
Enable/Disable Console Mirroring	Y <sup>2</sup>	Y <sup>1</sup>	
Select Modem Line Speed	Y <sup>2</sup>	Y <sup>1</sup>	
Enable/Disable Modem	Y <sup>2</sup>	Y <sup>1</sup>	
Setup Modem Configuration	Y <sup>2</sup>	Y <sup>1</sup>	
Setup Ring Indicate Power-On	Y <sup>2</sup>	Y <sup>1</sup>	
Setup Dial-out Phone Numbers	Y <sup>2</sup>	Y <sup>1</sup>	
Setup Surveillance	Y <sup>2</sup>	Y <sup>1</sup>	
Update Service Processor Flash EPROM	Y <sup>2</sup>	Y <sup>1</sup>	Y <sup>2</sup>
Change General-Access Password	Y <sup>2</sup>		Y <sup>2</sup>
Change Privileged-Access Password	Y <sup>2</sup>		Y <sup>2</sup>

Service Processor Functions	Service Processor Menus (ASCII terminals)	AIX Service Aids (ASCII or graphics terminals)	SMS (ASCII or graphics terminals)
Select Language	Y <sup>2</sup>		Y <sup>2</sup>
Enable/Disable Unattended Start Mode	Y <sup>2</sup>		Y <sup>2</sup>

<sup>1</sup> Operating system root password <sup>2</sup> Privileged-access password <sup>3</sup> General-access password

---

## Service Processor Menus

The service processor menus are divided into two groups:

- General user menus - the user must know the general-access password.
- Privileged user menus - the user must know the privileged-access password.

The following section describes these two groups of menus, how to access them, and the functions associated with each option.

When the server is powered down, the service processor menus can be accessed locally or remotely.

### Service Processor Menu Inactivity

To prevent loss of control in unstable power environments, the service processor leaves the menu mode after five minutes of inactivity. Return to the menus by pressing any key on the terminal, local or remote.

### Accessing Service Processor Menus Locally

Service processor menus can be accessed locally by connecting an ASCII terminal to either serial port. Because the presence of the ASCII terminal cannot be confirmed by the service processor, you must press a key on the ASCII terminal to confirm its presence. The service processor then prompts you for a password (if set), and when verified, displays the service processor menus.

**Note:** The system initialization indicators are described in “Open Firmware” on page 105. The user can tell also by the initialization indicators that appear on the operator panel; watch for the code E1F1.

### Accessing Service Processor Menus Remotely

Service processor menus can be accessed remotely by connecting a modem to serial port 1 or serial port 2, as follows:

1. Turn off the server, unplug the power cord, and press the Power button to drain capacitance while power is disconnected.
2. Connect the modem to the appropriate serial port and turn on the modem.
3. Plug in the server.

**Note:**

If your modem has not been configured, go to “Call-In/Call-Out Setup Menu” on page 54 and configure the modem, then using a terminal or terminal emulator, call the server’s modem.

The service processor prompts you for a password (if set), and when verified, displays the service processor menus.

---

## General User Menu

The menu options presented to the general user are a subset of the options available to the privileged user. The user must know the general-access password, if set, to access these menus.

```
GENERAL USER MENU

1. Power-On System
2. Read VPD Image from Last System Boot
3. Read Progress Indicators from Last System Boot
4. Read Service Processor Error Logs
5. Read System POST Errors
6. View System Environmental Conditions
99. Exit from Menu

1>
```

**Note:** The service processor prompt reads either 1> or 2> to indicate which serial port on the system unit is being used to communicate with the service processor.

- **Power-On System**  
Allows the user to power-on the system.
- **Read VPD Image from last System Boot**  
Displays manufacturer vital product data, such as serial numbers, part numbers, and so on, that were stored from the system boot prior to the one in progress now.
- **Read Progress Indicators from Last System Boot**  
Displays the boot progress indicators (checkpoints), up to a maximum of 100, from the system boot prior to the one in progress. This historical information can be useful to help diagnose system faults.  
  
The progress indicators are displayed in two sections. Above the dashed line are the progress indicators (latest) from the boot that produced the current sessions. Below the dashed line are progress indicators (oldest) from the boot preceding the one that produced the current sessions.  
  
The progress indicator codes are listed from top (latest) to bottom (oldest). The dashed line represents the point where the latest boot started.  
  
If the <-- arrow occurs, use the posted code.
- **Read Service Processor Error Logs**  
Displays the service processor error logs.

The time stamp in this error log is Coordinated Universal Time (CUT), also known as Greenwich Mean Time (GMT). AIX error logs have additional information available and are able to time stamp the errors with local time. See page 68 for an example of the error log.

- **Read System POST Errors**

Select this item to review the results of the POST (Power-On Self-Test). Your server may be able to start in the presence of POST errors if there are sufficient working system resources. If POST errors occur during startup, this error log, when used with the diagnostics, helps to isolate faults. See page “System POST Errors” on page 69 for an example of the POST error screen.

- **View System Environmental Conditions**

With this menu option, the service processor reads all environmental sensors and reports the results to the user. This option can be useful when surveillance fails, because it allows the user to determine the environmental conditions that may be related to the failure. See page 50 for an example of the System Environmental Conditions screen.

---

## Privileged User Menus

The following menus are available to privileged users only. The user must know the privileged access password, if set, to access these menus.

## Main Menu

At the top of the Main Menu is a listing containing:

- Your Service Processor’s current firmware version
- The firmware copyright notice
- The System Name given to your server during setup (optional)

You need the firmware version for reference when you either update or repair the functions of your service processor.

The System Name, an optional field, is the name that your server reports in problem messages. This name helps your support team (for example, your system administrator, network administrator, or service representative) to more quickly identify the location, configuration, and history of your server. The System Name is set from the Main Menu using option 6.

**Note:** The information under the Service Processor Firmware heading in the following Main Menu illustration is example information only.

```
Service Processor Firmware
Firmware Level: sh991029
Copyright 1997, IBM Corporation
SYSTEM NAME

MAIN MENU

1. Service Processor Setup Menu
2. System Power Control Menu
3. System Information Menu
4. Language Selection Menu
5. Call-In/Call-Out Setup Menu
6. Set System Name
99. Exit from Menus

1>
```

### Service Processor Setup Menu

The Service Processor Setup menu shown below is accessed from the Main Menu:

```
SERVICE PROCESSOR SETUP MENU

1. Change Privileged Access Password
2. Change General-Access Password
3. Enable/Disable Console Mirroring:
   Currently Disabled

4. Start Talk Mode
5. OS Surveillance Setup Menu
6. Reset Service Processor
7. Reprogram Service Processor Flash EPROM
8. Serial Port Snoop Setup Menu
98. Return to Previous Menu
99. Exit from Menus

1>
```

**Note:** Unless otherwise stated in the menu responses, settings become effective when a menu is exited using option 98 or 99.

### Passwords

Passwords can be any combination of up to eight alphanumeric characters. You can enter longer passwords, but the entries are truncated to include only the first eight characters. Passwords can be set from the service processor menu or from the System Management Services menus.

For security purposes, the service processor counts the number of attempts to enter correct passwords. The results of not recognizing a correct password within this error threshold are different, depending on whether the attempts are being made locally (at the server) or remotely (through a modem). The error threshold is three attempts.

If the error threshold is reached by someone entering passwords at the server, the service processor exits the menus. This action is taken based on the assumption that the server is in an adequately secure location with only authorized users having access. Such users must still successfully enter a login password to access AIX.

If the error threshold is reached by someone entering passwords remotely, the service processor disconnects the modem to prevent potential security attacks on the server by unauthorized remote users.

The following table illustrates what you can access with the privileged-access password and the general-access password.

Privileged Access Password	General Access Password	Resulting Menu
None	None	MAIN MENU displays
None	Set	MAIN MENU displays
Set	None	Users with password, see the MAIN MENU displays Other users, the GENERAL USER MENU displays
Set	Set	Users see menus associated with the entered password

- **Change Privileged-Access Password**

Set or change the privileged access password. It provides the user with the capability to access all service processor functions. This password is usually used by the system administrator or root user.

- **Change General-Access Password**

Set or change the general-access password. It provides limited access to service processor menus and is usually available to all users who are allowed to power on the server.

- **Enable/Disable Console Mirroring**

When Console Mirroring is enabled, the service processor sends information to both serial ports. This capability, which can be enabled by local or remote users, provides local users with the capability to monitor remote sessions. Console mirroring can be enabled for the current session only. For more information, see “Console Mirroring” on page 67.

- **Start Talk Mode**

In a console-mirroring session, it is useful for those who are monitoring the session to be able to communicate with each other. Selecting this menu item activates the keyboards and displays for such communications while console mirroring is established. This is a full duplex link, so message interference is possible. Alternating messages between users works best.

- **OS Surveillance Setup Menu**

This menu can be used to set up operating system (OS) surveillance.

```
OS Surveillance Setup Menu

1. Surveillance:
   Currently Enabled

2. Surveillance Time Interval:
   Currently 5 or Not Applicable

3. Surveillance Delay:
   Currently 10 or Not Applicable

98. Return to Previous Menu
```

- **Surveillance**  
Can be set to Enabled or Disabled.
- **Surveillance Time Interval**  
Can be set to any number from 1 to 255 minutes.
- **Surveillance Delay**  
Can be set to any number from 0 to 255 minutes.

Surveillance Time Interval and Surveillance Delay can only be changed after surveillance is enabled.

Refer to “Service Processor System Monitoring - Surveillance” on page 65 for more information about surveillance.

- **Reset Service Processor**  
Allows the user to reinitialize the service processor.
- **Reprogram Service Processor Flash EPROM**  
This is an automatic process.

### Serial Port Snoop Setup Menu

This menu can be used to set up Serial Port Snooping, in which the user can configure serial port 1 as a “catch-all” reset device.

From the main Service Processor menu, select option 1, Service Processor setup, then select option 8 (Serial Port Snoop Setup Menu).

```
SERIAL PORT SNOOP SETUP MENU

1. System reset string:
   Currently Unassigned

2. Snoop Serial Port:
   Currently Unassigned

98. Return to Previous Menu

1>
```

Use the system reset string option to enter the system reset string, which resets the machine when it is detected on the main console on Serial Port 1.

Use the Snoop Serial Port option to select the Serial Port to Snoop.

**Note:** Only Serial Port 1 is supported.

After Serial Port Snooping is correctly configured, at any point after the system unit is booted to AIX, whenever the reset string is typed on the main console, the system unit uses the Service Processor reboot policy to restart. This action causes an EPOW (Early Power Off Warning) to be logged, and also an AIX dump to be created if the machine is at an AIX prompt, with AIX in such a state that it can respond. If AIX cannot respond, the EPOW record is created, rather than the AIX dump.

Pressing Enter after the reset string is not required, so make sure that the string is not common or trivial. A mixed-case string is recommended.

## System Power Control Menu

The menu is used to set power control options.

```
SYSTEM POWER CONTROL MENU

1. Enable/Disable Unattended Start Mode:
   Currently Disabled
2. Ring Indicate Power-On Menu
3. Reboot/Restart Policy Setup Menu
4. Power-On System
5. Power-Off System
6. Enable/Disable Fast System Boot:
   Currently Disabled
7. Boot Mode Menu
98. Return to Previous Menu
99. Exit from Menus

1>
```

### Enable/Disable Unattended Start Mode

Use this option to instruct the service processor to immediately power-on the server after a power failure, bypassing power-on password verification. Unattended Start Mode can also be set using SMS menus. Unattended Start Mode can be used on servers that require automatic power-on after a power failure.

### Boot Mode Menu

Allows users to configure the system to automatically start a specific function on the next system start. This configuration applies to the next boot only and is reset to the default state of being disabled following a successful boot attempt.



```
BOOT MODE MENU

1. Boot to SMS Menu:
   Currently Disabled

2. Service Mode Boot from Saved List:
   Currently Disabled

3. Service Mode Boot from Default List:
   Currently Disabled

4. Boot to Open Firmware Prompt:
   Currently Disabled

98. Return to Previous Menu

1>
```

- **Enabling the Boot to SMS Menu option**

Causes the system to automatically enter the System Management Services menu during the boot process. Enabling this option is equivalent to pressing 1 on the attached ASCII terminal (or F1 on a graphics terminal) while the system initialization indicators display on the screen.

- **Enabling the Service Mode Boot from Saved list option**

Causes the system to automatically enter the Stand-alone diagnostics (see “Standalone Diagnostic Operation” on page 112 for more on Stand-alone diagnostics). Enabling this option is equivalent to pressing 5 on the attached ASCII terminal (or F5 on a graphics terminal) while the system initialization indicators display on screen.

- **Enabling the Service Mode Boot from Default List option**

Causes the system to automatically enter the Online Diagnostics in Service Mode (see “Online Diagnostics Modes” on page 109 for more Online Diagnostics). Enabling this option is equivalent to pressing ‘6’ on the attached ASCII terminal (or F6 on a graphics terminal) while the system initialization indicators display on screen.

- **Enabling the Boot to Open Firmware Prompt option**

Causes the system to automatically enter Open Firmware prompt (also called the OK prompt). Enabling this option is equivalent to pressing 8 on the attached ASCII terminal (or F8 on a graphics terminal) while the system initialization indicators display on screen (see “Open Firmware” on page 105 for more information about Open Firmware prompt).

If more than one option is enabled, the system recognizes only the option corresponding to the smallest menu number. For example, If options 4 and 2 were enabled, the system recognizes only Option 2: Service Mode Boot from Saved List. After a boot attempt, all enabled options are disabled. In effect, the system throws away any menu options that are enabled after the option with the highest priority (the option with the smallest menu number) is executed.

The user can also override the choices in the Boot Mode Menu while the system initialization indicators display on the screen. For example, if the user had enabled the system to enter the SMS menus (option 1) but pressed the 8 key while the

system initialization indicators displayed on the screen, the system would enter the Open Firmware prompt and disregards the settings in the Boot Mode Menu.

**Note:** After the logo screen displays, the initialization indicators display across the bottom of the screen. The system initialization indicators are described in “Open Firmware” on page 105. The user can tell also by the initialization indicators that appear on the operator panel; watch for the code E1F1.

- **Ring Indicate Power-On Menu**

Ring Indicate Power-On is an alternate method of dialing in, without establishing a service processor session. If the system is powered off and Ring Indicate Power-On is enabled, the server is powered on at the predetermined number of rings. If the server is already on, no action is taken. In either case, the telephone call is not answered. The caller receives no feedback that the server is powered on. The Ring Indicate Power-On Menu and defaults are shown below:

```
Ring Indicate Power-On Menu

1. Ring indicate power-on:
   Currently Disabled

2. Number of rings:
   Currently 6

98. Return to Previous Menu
```

The number of rings can be set to any number greater than zero.

- **Reboot/Restart Policy Setup Menu**, see “Reboot/Restart Policy Setup Menu” on page 58.
- **Power-On System**  
Allows immediate power-on of the system. For other power-on methods, see “System Power-On Methods” on page 61.
- **Power-Off System**  
Allows the user to power-off the server following a surveillance failure.

## System Information Menu

This menu provides access to system configuration information, error logs, system resources, and processor configuration.

#### SYSTEM INFORMATION MENU

1. Read Progress Indicators from Last System Boot
2. Read Service Processor Error Logs
3. Read System POST Errors
4. Read NVRAM
5. Read Service Processor Configuration
6. View System Environmental Conditions
7. Processor configuration/deconfiguration Menu
10. Enable/Disable CPU Guard Menu  
Currently Enable
11. Enable/Disable MEM Guard  
Currently Enable
98. Return to Previous Menu
99. Exit from Menus

1>

- **Read Progress Indicators from Last System Boot**

Displays the boot progress indicators (checkpoints), up to a maximum of 100, from the system boot prior to the one in progress. This historical information can help to diagnose system faults.

The progress indicators are displayed in two sections. Above the dashed line are the progress indicators (latest) from the boot that produced the current sessions. Below the dashed line are progress indicators (oldest) from the boot preceding the one that produced the current sessions.

The progress indicator codes are listed from top (latest) to bottom (oldest). The dashed line represents the point where the latest boot started.

- **Read Service Processor Error Logs**

Displays error conditions detected by the service processor.

The time stamp in this error log is Coordinated Universal Time (CUT), also known as Greenwich Mean Time (GMT). AIX error logs have additional information available and are able to time stamp the errors with the local time. See page 68 for an example of the error log.

- **Read System POST Errors**

Select this option to review the results of the POST (Power-On Self-Test). Your system unit may be able to start in the presence of POST errors if there is sufficient working system resources. If POST errors occur during start up, this error log, when used with the diagnostics, helps to isolate faults. See page “System POST Errors” on page 69 for an example of the POST error screen.

- **Read NVRAM**

Displays nonvolatile random access memory (NVRAM) contents.

- **Read Service Processor Configuration**

Displays current service processor configuration.

- **View System Environmental Conditions**

The service processor reads all environmental sensors and reports the results to the user. Use this option when surveillance fails, because it allows the user to determine the environmental conditions that may be related to the failure.

The following is an example of the System Environmental Conditions screen:

```
System Environmental Conditions
(System Power is currently off.)

Fan 0: A stopped fan detected
Fan 1: A stopped fan detected
Fan 2: A stopped fan detected
Fan 3: A stopped fan detected
MEM Temperature is operating within normal tolerances
I/O Temperature is operating within normal tolerances
CPU Temperature is operating within normal tolerances
5.0 Volts: A low 5.0 Voltage reading detected
3.3 Volts: A low 3.3 Voltage reading detected
5.0 Standby Volts: is operating within normal tolerance
+12.0 Volts: A low +12.0 voltage reading detected
-12.0 Volts: A high -12.0 voltage reading detected
(Press Return to Continue)
```

- **Processor Configuration/Deconfiguration Menu**

Use this option to view and modify processor configuration.

The following is an example of the Processor Configuration/Deconfiguration Menu:

```
Processor Configuration/Deconfiguration Menu

Processor number
0. Configured by system (0x0)
1. Configured by system (0x0)
2. Configured by system (0x0)
3. Configured by system (0x0)
98. Return to Previous Menu

To change the configuration, select the processor number
1>
```

The user can manually configure or deconfigure any processor, regardless of failure status, through this Service Processor menu. The configuration process takes place during the system power-up. Therefore, the configuration displayed in STANDBY mode reflects the configuration during the last boot.

To view the current configuration, access the Service Processor menu after the system starts. When the user selects a processor, its state toggles between configured and deconfigured. Processors that are not present are not listed. A processor can be in any of the following four states:

- **Configured by system:** The processor is present, and has not exceeded the number of failure threshold. It is configured by the system and is available.
- **Deconfigured by system:** The processor is present, but has exceeded the number of failure threshold. It is deconfigured by the system and is currently unavailable.
- **Manually configured:** The processor is present and available. It is configured by the user through the service processor menus.
- **Manually deconfigured:** The processor is present, but unavailable. It has been deconfigured by the user through the service processor menus.

- The following is an example of the Memory Configuration/Deconfiguration Menu:

```
Memory Configuration/Deconfiguration Menu

DIMMs on memory card number 0:

DIMMs on memory card number 1:
  1. Configured by system (0x0)
  2. Configured by system (0x0)

98. Return to Previous Menu

Enter card number _and_ DIMM number separated by a space
1>
```

The user can manually configure or deconfigure any memory DIMM (Dual Inline Memory Module), regardless of failure status, through this Service Processor menu. The configuration process takes place during the system power-up. Therefore, the configuration displayed in STANDBY mode reflects the configuration during the last boot.

To view the current configuration, access the Service Processor menu after the system starts. When the user selects a memory DIMM, its state will toggle between configured and deconfigured. Memory DIMMs that are not present are not listed. A memory DIMM can be in any of the following four states:

- **Configured by system:** The memory DIMM is present, and has not exceeded the number of failure threshold. It is configured by the system and is available.
- **Deconfigured by system:** The memory DIMM is present, but has exceeded the number of failure threshold. It is deconfigured by the system and is currently unavailable.
- **Manually configured:** The memory DIMM is present and available. It is configured by the user through the service processor menus.
- **Manually deconfigured:** The memory DIMM is present, but unavailable. It has been deconfigured by the user through the service processor menus.

## Language Selection Menu

The service processor menus and messages are available in various languages. This menu allows selecting languages into which Service Processor and system firmware menus and messages are displayed.

```
LANGUAGE SELECTION MENU

 1. English
 2. France
 3. Deutsch
 4. Italian
 5. Espanol
 6. Svenska
98. Return to Previous Menu
99. Exit from Menu

1>
```

**Note:** Your ASCII terminal must support the ISO-8859 character set to correctly display languages other than English.

## Call-In/Call-Out Setup Menu

This menu is used to configure a modem for the service processor to use to support the system.

```
CALL-IN/CALL-OUT SETUP MENU

1. Modem Configuration Menu
2. Serial Port Selection Menu
3. Serial Port Speed Setup Menu
4. Telephone Number Setup Menu
5. Call-Out Policy Setup Menu
6. Customer Account Setup Menu
7. Call-Out Test
8. Ring Indicate Power-On Menu
98. Return to Previous Menu
99. Exit from Menus

1>
```

- **Modem Configuration Menu**, see “Modem Configuration Menu”.
- **Serial Port Selection Menu**, see “Serial Port Selection Menu” on page 55.
- **Serial Port Speed Setup Menu**, see “Serial Port Selection Menu” on page 55.
- **Telephone Number Setup Menu**, see “Telephone Number Setup Menu” on page 56.
- **Call-Out Policy Setup Menu**, see “Call-Out Policy Setup Menu” on page 57.
- **Customer Account Setup Menu**, see “Customer Account Setup Menu” on page 58.
- **Call-out Test**, see “Call-Out Policy Setup Menu” on page 57.
- **Ring Indicate Power-On Menu**, see “Ring Indicate Power-On Menu” on page 50.

## Modem Configuration Menu

Two entries at the top of the Modem Configuration Menu display the status of the current selections. Selections are made in the two sections labeled Modem Ports and Modem Configuration File Name. Select the serial port that you want to activate and then select the modem configuration file for the modem on the port. To set up both serial ports with modems, make your selections one port at a time.

For information on choosing a modem configuration file, see “Sample Modem Configuration Files” on page 169 and “Transfer of a Modem Session” on page 173.

#### Modem Configuration Menu

Port 1 Modem Configuration File Name:  
Port 2 Modem Configuration File Name:

To make changes, First select the port and then the configuration file name

#### Modem Ports:

1. Serial port 1
2. Serial port 2

#### Modem Configuration File Name:

3. none
4. modem\_f\_sp
5. modem\_f0\_sp
6. modem\_f1\_sp
7. modem\_z\_sp
8. modem\_z0\_sp
9. modem\_m0\_sp
10. modem\_m1\_sp
30. Save configuration to NVRAM and Configure modem
98. Return to Previous Menu

## Serial Port Selection Menu

This menu allows you to enable and/or disable the call-in functions of each serial port in any combination.

#### Serial Port Selection Menu

1. Serial Port 1 Call-Out:  
Currently Disabled
2. Serial Port 2 Call-Out:  
Currently Disabled
3. Serial Port 1 Call-In:  
Currently Disabled
4. Serial Port 2 Call-In:  
Currently Disabled
98. Return to Previous Menu

## Serial Port Speed Setup Menu

This menu allows you to set serial port speed to enhance terminal performance or to accommodate modem capabilities.

#### Serial Port Speed Setup Menu

1. Serial port 1 speed:  
Currently 9600
2. Serial port 2 speed:  
Currently 9600
98. Return to Previous Menu

A speed of 9600 baud or higher is recommended. Valid serial port speeds are shown below:

50	600	4800
75	1200	7200
110	2000	9600
134	2400	19200
150	2400	57600
300	3600	115200

## Telephone Number Setup Menu

Use the menu to set or change the telephone numbers for reporting a system failure.

```
Telephone Number Setup Menu

1. Service Center Telephone Number:
   Currently Unassigned

2. Customer Administration Center Telephone Number:
   Currently Unassigned

3. Digital Pager Telephone Number:
   Currently Unassigned

4. Customer Voice Telephone Number:
   Currently Unassigned

5. Customer System Telephone Number:
   Currently Unassigned

98. Return to Previous Menu

1>
```

- **Service Center Telephone Number** is the number of the service center computer. The service center usually includes a computer that takes calls from servers with call-out capability. This computer is referred to as the *catcher*. The catcher expects messages in a specific format to which the service processor conforms. Contact your service provider for the correct service center telephone number to enter here. For more information about the format and catcher computers, refer to the README file in the AIX /usr/samples/syscatch directory.
- **Customer Administration Center Telephone Number** is the number of the System Administration Center computer (catcher) that receives problem calls from servers. Contact your system administrator for the correct telephone number to enter here.
- **Digital Pager Telephone Number** is the number for a pager carried by someone who responds to problem calls from your server. Contact your administration center representative for the correct telephone number to enter here. For test purposes, use a test number, which you can change later.

**Note:** Some modems, such as IBM 7857-017, are not designed for the paging function. Although they can be used for paging, they return an error message when they do not get the expected response from another modem. Therefore, even though the paging was successful, the error message causes the service



processor to retry, continuing to place pager calls for the number of retries specified in the Call-Out policy Setup Menu. These retries result in redundant pages.

For digital pagers that require a personal identification number (PIN) for access, include the PIN in this field as shown in the following example:

```
18001234567,,,,87654
```

The commas create pauses for the voice response system, and the 87654 represents the PIN. The length of these pauses is set in modem register S8. The default is usually 1 or 2 seconds each.

- **Customer Voice Telephone Number** is the telephone number of a phone near the server or answered by someone responsible for the server. This is the telephone number left on the pager for callback. For test purposes, use a test number, which you can change later.
- **Customer System Telephone Number** is the telephone number to which your server's modem is connected. The service or administration center representatives need this number to make direct contact with your server for problem investigation. This is also referred to as the *call-in* phone number.

## Call-Out Policy Setup Menu

This menu allows you to set call-out policy.

```
Call-Out Policy Setup Menu

1. Call-Out policy (First/All):
   Currently First

2. Remote timeout, (in seconds):
   Currently 120

3. Remote latency, (in seconds):
   Currently 2

4. Number of retries:
   Currently 2

98. Return to Previous Menu

1>
```

- **Call-Out Test**

The Call-Out Test verifies if the Call-Out function is working properly. Before the Test, call-out must be enabled and the system configured properly for call-out.

During the setup, the user should have entered the phone numbers for the Digital Pager and Customer Voice for test purposes. These numbers are used to determine whether call-out is working during the Call-Out Test.

The Call-Out Test should cause the user's phone to ring. If the test is successful, call-out is working properly. The user should now change the test Digital pager and Customers Voice number to the correct numbers.

Call-Out policy can be set to First or All. If call-out policy is set to First, the service processor stops at the first successful call out to one of the following numbers in the order listed:

1. Service Center
2. Customer Administration Center
3. Pager

If call-out policy is set to All, the service processor attempts a call out to the following numbers in the order listed:

1. Service Center
  2. Customer Administration Center
  3. Pager
- **Remote timeout** and **Remote latency** are functions of your service provider's catcher computer. Either use the defaults or contact your service provider for recommended settings.
  - **Number of retries** is the number of times you want the server to retry calls that resulted in busy signals or in other error messages.

## Customer Account Setup Menu

This menu allows users to enter information that is specific to their account.

Customer Account Setup Menu

1. Customer account number:  
Currently Unassigned
2. Customer RETAIN login userid:  
Currently Unassigned
3. Customer RETAIN login password:  
Currently Unassigned
98. Return to Previous Menu

1>

- **Customer account number** is assigned by your service provider for record-keeping and billing. If you have an account number, enter it. Otherwise, leave this field blank.
- **Customer RETAIN login userid** and **Customer RETAIN login password** apply to a service function to which your service provider may or may not have access. Leave these fields blank if your service provider does not use RETAIN.

## Reboot/Restart Policy Setup Menu

*Reboot* describes bringing the system hardware back up from scratch, for example, from a system reset or power-on. The boot process ends when control passes to the operating system process.

*Restart* describes activating the operating system after the system hardware reinitialized. Restart must follow a successful reboot.

```

Reboot/Restart Policy Setup Menu

1. Number of reboot attempts:
   Currently 3

2. Use OS-Defined restart policy?
   Currently Yes

3. Enable supplemental restart policy?
   Currently No

4. Call-Out before restart:
   Currently Disabled

98. Return to Previous Menu

1>

```

- **Number of reboot attempts** If the server fails to successfully complete the boot process, it attempts to reboot the number of times specified. Entry values equal to or greater than 0 are valid. Only successive failed reboot attempts count, not reboots that occur after a restart attempt. At restart, the counter is set to 0.
  - **Use OS-Defined restart policy** lets the service processor react or not react the same as the operating system to major system faults, by reading the setting of the operating system parameter **Automatically Restart/Reboot After a System Crash**. This parameter may or may not be defined, depending on the operating system or its version and level. If the operating system automatic restart setting is defined, then it can be set to respond to a major fault by restarting or by not restarting. See your operating system documentation for details on setting up operating system automatic restarts. The default value is Yes.
  - **Enable supplemental restart policy** - The default setting is No. If set to Yes, the service processor restarts the system when the system loses control as detected by the service processor surveillance, and either:
    - The **Use OS-Defined restart policy** is set to No.
- OR**
- The **Use OS-Defined restart policy** is set to Yes, and the operating system has no automatic restart policy.  
Refer to “Service Processor Reboot/Restart Recovery” on page 63.
  - **Call-Out before restart** If a restart is necessary due to a system fault, you can enable the service processor to call out and report the event. This option can be valuable if the number of these events becomes excessive, signalling a bigger problem.

The following table describes the relationship among the operating system and service processor restart controls:

OS Automatic reboot/restart after crash setting	Service processor to use OS-Defined restart policy?	Service Processor Enable supplemental restart policy?	System response
None	No	No <sup>1</sup>	
None	No	Yes	Restarts

OS Automatic reboot/restart after crash setting	Service processor to use OS-Defined restart policy?	Service Processor Enable supplemental restart policy?	System response
None	Yes <sup>1</sup>	No <sup>1</sup>	
None	Yes <sup>1</sup>	Yes	Restarts
False <sup>2</sup>	No	No <sup>1</sup>	
False <sup>2</sup>	No	Yes	Restarts
False <sup>2</sup>	Yes <sup>1</sup>	No <sup>1</sup>	
False <sup>2</sup>	Yes <sup>1</sup>	Yes	
True	No	No <sup>1</sup>	
True	No	Yes	Restarts
True	Yes <sup>1</sup>	No <sup>1</sup>	Restarts
True	Yes <sup>1</sup>	Yes	Restarts

<sup>1</sup> Service Processor default

<sup>2</sup> AIX default

---

## Service Processor Functions

This section provides detailed information about the service processor functions.

The 44P Model 270 supports the functions listed in the following table:

Built-in Functions	Initialization and Test	Service Processor Basic Instructions Test (BIST)
		JTAG System Chip Initialization
	Error Data Collection	BIST/POST errors and status
		Checkstop FIR data logout
		Machine check logout
	Configuration	CPU Complex validation
		VPD Collection
	System Management	Reset and Reboot on System Firmware fail
		Reboot on system failure

Local User Function	User Interface	Local async console
		Text based menus with NLS
		Operator Panel messages
	Power and Miscellaneous	Power On/Off
		Configurable Reboot Policy
	Status and Data Access	VPD
		Error data (Service Processor)
		Error data (system)
		Environmental data
	Service Processor Setup Utilities	Passwords
		Phone numbers
		Language (NLS) selection
		Call In/Call Out enable/disable
Flash (Gold/Recovery block) Update		
Flash (Composite block) Update		
System Name		
Modem Configuration		
Remote User Functions	Call Out (Call Home) Reporting	Boot failure
		OS Termination
		Surveillance failure
		Critical EPOW reporting
		Checkstop
		Machine check
	Identify system by name	Call In
		Power-on via ring-indicate
		Password/security check
		Console mirroring/Quick disconnect

---

## System Power-On Methods

This section discusses the following system power-on methods:

- Power-on Switch
- Remote Power-on via Ring-Indicate Signal

The server automatically powers on when it detects a "ring indicate" signal from a modem attached to one of the integrated serial ports.

A remote user can call the server to activate ring detection by the modem. Listen for a few more rings than the threshold number for starting the system and then hang up. The default threshold is one ring.

Wait 5 minutes for the server to initialize and then call again using an ASCII terminal. The server responds by requesting a password, if set, or presenting the service processor menus. The remote user now has control of the server.

**Note:** For security, if the system is powered on by the remote power-on via ring indicate signal and the service processor detects an operator panel battery failure, the service processor causes the system to power off. See “Service Processor Call-In Security” for more information.

- Unattended start mode - refer to **Enable/Disable Unattended Start Mode** on page 48.

The Service Processor can be enabled to recover from the loss of ac power (see Enable/Disable Unattended Power-On Mode in the SYSTEM POWER CONTROL MENU). When ac power is restored, the system returns to the state at the time ac loss occurred. For example, if the system was powered-on when ac loss occurred, it reboots/restarts when power is restored. If the system was powered-off when ac loss occurred, it remains off when power is restored.

- Timed power-on - refer to the **shutdown -t** command on servers using AIX. Working in conjunction with AIX, the Service Processor in your server can operate a timer, much like the wake-up timer on your clock radio. You can set the timer so that your server powers on at a certain time after shutting down. The timer is battery operated, so power interruptions occurring while the server is off do not affect its accuracy. Refer to the AIX **shutdown -t** command for details on setting the timer.

**Note:** If an ac power loss is in progress when the Timed Power-On attempt occurs, the server is not able to power on when ac power is restored.

- Follow-up to a Failed Boot Attempt

The service processor initiates a power-on sequence if a failed boot attempt is detected (due to a hardware or software failure).

- Fast/Slow Boot (IPL) Capabilities

Using the Service Processors menus, you can select the IPL type, mode, and speed of your boot capabilities. For more information, refer to operator panel functions 01 and 02.

**Attention:** Selecting fast IPL results in several diagnostic tests being skipped.

---

## Service Processor Call-In Security

If the service processor detects bad battery-powered storage (indicating that the battery in the operator panel has failed or is disconnected), it maintains server security by disabling the call-in capability to both serial ports.

When call-in is disabled, the system can still be powered on by using the ring-indicator signal, but the service processor then causes the system to power down, preventing access to any system facilities or to AIX.

After battery power is restored, the password(s) must be reset and the call-in function(s) enabled. Both of these operations can be performed from Service Processor menus. See “Serial Port Selection Menu” on page 55.

---

## Service Processor Reboot/Restart Recovery

*Reboot* describes bringing the system hardware back up; for example, from a system reset or power-on. The boot process ends when control passes to the operating system process.

*Restart* describes activating the operating system after the system hardware is reinitialized. Restart must follow a successful reboot.

### Boot (IPL) Speed

When the server enters reboot recovery, slow IPL is automatically started, which gives the POST an opportunity to locate and report any problems that may otherwise be untested.

### Failure During Boot Process

During the boot process, either initially after system power-on or upon reboot after a system failure, the Service Processor monitors the boot progress. If progress stops, the Service Processor can reinitiate the boot process (reboot) if enabled to do so. The Service Processor can reattempt this process according to the number of retries selected in the Reboot/Restart Policy Setup Menu.

### Failure During Normal System Operation

When the boot process completes and control transfers to the operating system (OS), the service processor can monitor operating system activity (see the Set Surveillance Parameters option in the SERVICE PROCESSOR SETUP MENU). If OS activity stops due to a hardware-or software-induced failure, the service processor can initiate a reboot/restart process based on the settings in the Service Processor Reboot/Restart Policy Setup Menu and the OS automatic restart settings (see the operating system documentation).

If you are using the AIX operating system, the menu item under SMIT for setting the restart policy is Automatically Reboot After Crash (True/False). The default is False. When the setting is True, and if the service processor parameter "Use OS-Defined Restart Policy" is Yes (the default), Service Processor takes over for AIX to reboot/restart after a hardware or surveillance failure.

### Service Processor Reboot/Restart Policy Controls

The operating system's automatic restart policy (see operating system documentation) indicates the operating system response to a system crash. The service processor can be instructed to refer to that policy by the Use OS-Defined Restart Policy setup menu.

### Processor Boot-Time Deconfiguration (CPU Repeat-Gard)

Processor boot time deconfiguration allows for the removal of processors from the system configuration at boot time. The objective is to minimize system failure or data integrity exposure due to a faulty processor.

This function uses processor hardware Built-In Self-Test (BIST) and firmware Power-On Self-Test (POST) to discover and isolate processor hardware failures during boot time.

It also uses the hardware error detection logic in the processor to capture run-time recoverable and irrecoverable error indications. The firmware uses the error signatures in the hardware to analyze and isolate the error to a specific processor.

The processors that are deconfigured remain off-line for subsequent reboots until the faulty processor hardware is replaced.

This function allows users to manually deconfigure or re-enable a previously deconfigured processor through the Service Processor menu. The user can also enable or disable this function through the Service Processor.

## **Processor Run-Time Deconfiguration (CPU-Gard)**

Processor run-time deconfiguration allows for the dynamic removal of CPUs from the system configuration. The objective is to minimize system failures or data integrity exposures due to a faulty processor. The processor to be removed is the one that has experienced repeated run-time recoverable internal errors (over a predefined threshold).

The function uses the hardware error detection logic in the processor to capture run-time recoverable error indications. The firmware uses the error signatures in the hardware to analyze and isolate the error to a specific CPU. The firmware also maintains error-threshold information.

When an internal recoverable error for a processor reaches a predefined threshold, the firmware notifies the AIX operating system. The AIX operating system migrates all software processes and interrupts to another processor and puts the faulty processor in stop state.

CPUs that are deconfigured at run time remain off-line for subsequent reboots through the CPU Boot Time Deconfiguration function, until the faulty CPU hardware is replaced. The user can also enable or disable this function through the AIX system management function.

## **Memory Boot-Time Deconfiguration (Memory Repeat-Gard)**

Memory boot time deconfiguration allows for the removal of a memory segment or DIMM from the system configuration at boot time. The objective is to minimize system failures or data integrity exposure due to faulty memory hardware. The hardware resource(s) to be removed are the ones that experienced the following failures:

- A boot-time test failure.
- Run-time recoverable errors over threshold prior to the current boot phase.
- Run-time irrecoverable errors prior to the current boot phase.

This function uses firmware Power-On Self-Test (POST) to discover and isolate memory hardware failures during boot time. It also uses the hardware error detection logic in the memory controller to capture run-time recoverable and irrecoverable error indications. The firmware uses the error signatures in the hardware to analyze and isolate the error to the specific memory segment or DIMM.



The memory segment or DIMM that is deconfigured remains off-line for subsequent reboots until the faulty memory hardware is replaced.

The function allows users to manually deconfigure or re-enable a previously deconfigured memory segment/DIMM through the Service Processor menu. The user can also enable or disable this function through the Service Processor menu.

---

## Service Processor System Monitoring - Surveillance

Surveillance is a function in which the service processor monitors the system, and the system monitors the service processor. This monitoring is accomplished by periodic samplings called *heartbeats*

Surveillance is available during two phases:

- System firmware bring-up (automatic)
- Operating system run time (optional)

### System Firmware Surveillance

System firmware surveillance provides the service processor with a means to detect boot failures while the system firmware is running.

System firmware surveillance is automatically enabled during system power-on. It cannot be disabled by the user.

If the service processor detects no heartbeats during system boot (for 7 minutes), it cycles the system power to attempt a reboot. The maximum number of retries is set from the service processor menus. If the fail condition repeats, the service processor leaves the machine powered on, logs an error, and displays menus to the user. If Call-out is enabled, the service processor calls to report the failure and displays the operating-system surveillance failure code on the operator panel.

### Operating System Surveillance

The operating system surveillance provides the service processor with a means to detect hang conditions, as well as hardware or software failures, while the operating system is running. It also provides the operating system with a means to detect service processor failure caused by the lack of a return heartbeat.

Operating system surveillance is enabled by default, allowing the user to run operating systems that do not support this service processor option.

You can also use Service Processor Menus and AIX Service Aids to enable or disable operating system surveillance.

For operating system surveillance to work correctly, you must set the following parameters:

- Surveillance enable/disable
- Surveillance interval

This is the maximum time (in minutes) the service processor should wait for a heartbeat from the operating system before timeout.

- Surveillance delay

This is the length of time (in minutes) for the service processor to wait from when the operating system is started to when the first heartbeat is expected.

Surveillance takes effect immediately after the parameters are set from the service processor menus.

If operating system surveillance is enabled (and system firmware has passed control to the operating system), and the service processor does not detect any heartbeats from the operating system, the service processor assumes the system is hung. The machine is left powered on and the service processor enters standby phase, displaying the operating system surveillance failure code on the operator panel. If Call-out is enabled, the service processor calls to report the failure.

## Call Out

The service processor can call out when it detects one of the following conditions:

- System firmware surveillance failure
- Operating system surveillance failure (if supported by the operating system)
- Critical environmental failures
- Restarts

To enable the call-out feature, do the following:

1. Have a modem connected to serial port 1 or 2
2. Set up the following using the service processor Menus or Diagnostic Service Aids:
  - Enable call out for the serial port where the modem is connected.
  - Set up serial port line speed.
  - Enter the modem configuration filename.
  - Set up site-specific parameters (such as phone numbers for call out and call out policy).
  - To call out before restart, set **Call-Out before restart** to ENABLED from the Reboot/Restart Policy Setup menu.

**Note:** Some modems, such as IBM 7857-017, are not designed for the paging function. Although they can be used for paging, they return an error message when they do not get the expected response from another modem. Therefore, even though the paging was successful, the error message causes the service processor to retry, continuing to place pager calls for the number of retries specified in the Call-Out policy Setup Menu. These retries result in redundant pages.

---

## Console Mirroring

Console mirroring allows a user on a local ASCII terminal to monitor the service processor activities of a remote user. Console mirroring ends when the service processor releases control of the serial ports to the system firmware.

Using this option, the user can set the modem connection, remote sessions, and console mirroring.

- Service Processor
- Modem connected to one serial port and enabled for incoming calls
- Local ASCII terminal connected to the other serial port. This local terminal can be connected directly to your server or connected through another modem.

Remote console mirroring can be invoked in three ways:

1. Remote session first, then local session added
2. Remote session already in progress.
3. Remote user uses the service processor menus to enable console mirroring, allowing both consoles to be active.

Local console mirroring can be invoked in three ways:

1. Local session first, then remote session added
2. Local session is already in progress.
3. The service processor receives a call from the remote user.
4. The local user selects the option to enable console mirroring. The service processor immediately begins mirroring service processor menus.

**Note:** To disconnect quickly, press Ctrl+D on either console, and both sessions will exit the service processor menus.

---

## Service Processor Firmware Updates

**Attention:** Only the service processor firmware can be updated from the service processor menus; the system firmware cannot be updated from the service processor menus. A service processor firmware update always requires a companion system firmware update, which must be applied first. For this reason, updating only the service processor firmware using the service processor menus is not recommended. Go to the RS/6000 support web site at <http://www.rs6000.ibm.com/support/micro> to download the latest firmware levels and update instructions.

The service processor firmware update image must be written onto a DOS-formatted diskette. The update image can be obtained from the RS/6000 support web site: <http://www.rs6000.ibm.com/support/micro>.

After the update diskette has been made, from the Service Processor Main Menu, select **Service Processor Setup**. Then select **Reprogram Service Processor Flash**

**EPROM.** The program requests the update diskette(s) as they are needed. The service processor will automatically reboot after the firmware update is complete.

---

## Service Processor Error Log

The service processor error logs contain error conditions detected by the service processor.

```
                Error Log

19991118165344  1. 4B276851 CPU BIST fail detected
FRUs to replace: P1-C1

Press "C" to clear error log, any other key to continue.>
```

The time stamp in this error log is Coordinated Universal Time (CUT), also known as Greenwich Mean Time (GMT). AIX error logs have more information available and are able to time stamp with local time.

---

## System POST Errors

If POST (Power-On Self-Test) errors occur during startup, this error log helps isolate faults when used with the diagnostics.

```
Read System POST Errors

Version : 0
Severity : 0
Disposition : 0
Initiator : 0
Event being reported : 0

Extended Error Log Data:
0xC2 0x00 0x84 0x09 0x00 0x00 0x00 0x00
0x20 0x00 0x00 0x00 0x00 0x00 0x72 0x74
0x63 0x00 0x00 0x00 0x00 0x00 0x00 0x00
0x00 0x00 0x28 0x03 0x00 0x05 0x00 0x01
0x00 0x00 0x00 0x00 0x00 0x00 0x00 0x00
0x49 0x42 0x4D 0x00 0x55 0x30 0x2E 0x31
0x2D 0x50 0x31 0x2D 0x58 0x31 0x00

(Press Return to Continue)
```

---

## Service Processor Operational Phases

This section provides a high-level flow of the phases of the service processor.

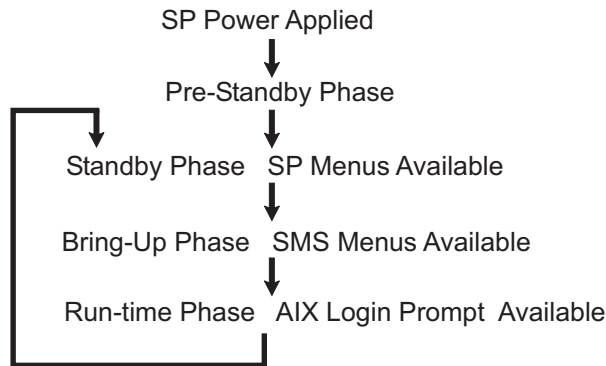

### Pre-Standby Phase

This phase is entered when the server is connected to a power source. The server may or may not be fully powered on. This phase is exited when the Power-On Self-Tests (POST) and configuration tasks are completed.

The Pre-Standby phase components are as follows:

- Service Processor Initialization - Performs any necessary hardware and software initializations.

- Service Processor POST - Conducts Power-On Self-Tests on its various work and code areas.
- Service Processor Unattended Start Mode Checks - To assist fault recovery. If unattended start mode is set, the service processor automatically reboots the server. service processor does not wait for user input or power-on command, but moves through the phase and into the Bring-up Phase. Access SMS menus or &sp menus to reset the unattended start mode.

## Standby Phase

The standby phase can be reached in either of two ways:

- With the server off and power connected (the normal path), recognized by 0K in the LCD display.
- OR
- With the server on after an operating system fault, recognized by STBY or an 8-digit code in the LCD display.

In the Standby phase, the service processor takes care of some automatic duties and is available for menu operation. The service processor remains in the standby phase until a power-on request is detected.

The Standby phase components are as follows:

- Modem Configuration  
Service processor configures the modem (if installed) so that incoming calls can be received or outgoing calls can be placed.
- Dial In  
Monitor incoming phone line to answer calls, prompt for a password, verify the password, and remotely display the standby menu. The remote session can be mirrored on the local ASCII console if the server is so equipped and the user enables this function.
- Menus  
The service processor menus are password-protected. Before you can access them, you need either the general-user (general-access password or GAP) or privileged-user (privileged-access password or PAP).

## Bring-Up Phase

This phase is entered upon power-on, and exited upon loading of the operating system.

The Bring-Up phase components are as follows:

- Retry Request Check  
The service processor checks to see if the previous boot attempt failed. If two consecutive failures are detected, the service processor displays an error code and places an outgoing call to notify an external party if the user has enabled this option.
- Dial Out

The service processor can dial a preprogrammed telephone number in the event of an IPL failure. The SP issues an error report with the last reported IPL status indicated and any other available error information.

- Update Operator Panel

The service processor displays Operator Panel data on the ASCII terminal if a remote connection is active.

- Environmental Monitoring

The Service Processor provides expanded error recording and reporting.

- System Firmware Surveillance (Heartbeat Monitoring)

The service processor monitors and times the interval between system firmware heartbeats.

- Responding to System Processor Commands

The service processor responds to any command issued by the system processor.

## Run-time Phase

This phase includes the tasks that the service processor performs during steady-state execution of the operating system.

- Environmental Monitoring

The Service Processor monitors voltages, temperatures, and fan speeds (on some servers).

- Responding to System Processor Commands

The service processor responds to any command issued by the system processor.

- Run-Time Surveillance (Heartbeat Monitoring)

If the device driver is installed and surveillance enabled, the service processor monitors the system heartbeat. If the heartbeat times out, the service processor places an outgoing call. This is different from the Bring-up Phase scenario where two reboot attempts are made before placing an outgoing call.

---

## Service Processor Procedures in Service Mode

When the system is in service mode, the following service processor parameters are suspended:

- Unattended Start Mode
- Reboot/Restart Policy
- Call-Out
- Surveillance

When service mode is exited, the service processor parameters revert to the customer settings.





---

## Chapter 4. System Management Services

Use the System Management Services menus to view information about your computer and to perform such tasks as setting passwords and changing device configurations.

If you have chosen a graphical display as your system console, you can use the graphical System Management Services described below. If you are using an ASCII display as your system console, see “Text-Based System Management Services” on page 94.

---

### Graphical System Management Services

To start the Graphical System Management Services, turn on or restart the computer.

The firmware version installed in your system unit is displayed at the bottom right corner of the initial logo screen. Note the version number; processor upgrades may require a specified version of firmware to be installed in your system unit. (Update System Firmware is an option under the Utilities menu in the System Management Services.)

After the logo is displayed, initialization icons display across the bottom of the screen.

To enter the Graphical System Management Services, you must press the F1 key *after the keyboard icon displays* during startup and before the tone.

If you have pressed the F1 key, the System Management Services menu displays after the initialization and power-on self-test (POST) are complete.

**Note:** If you have installed a privileged-access password, you are prompted for this password before you gain access to the System Management Services menu.

After the System Management Services starts, the following screen displays.

# System Management Services



Config



Multiboot



Utilities



Exit

You can also press F8 here to enter the open firmware 0K> prompt.

The System Management Services screen contains the following choices.

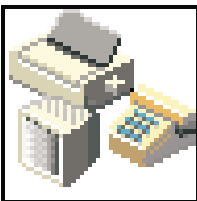

**Config:** Enables you to view your system setup. Go to "Config" on page 75.



**Multiboot:** Enables you to set and view the default operating system, modify the boot sequence, access the Open Firmware command prompt, and work with other options. Go to "Multiboot" on page 76.

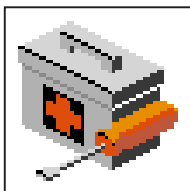

**Utilities:** Enables you to set and remove passwords, enable the unattended start mode, set and view the addresses of your system's SCSI controllers, select the active console, view or clear the firmware error log, and update your system unit's firmware program. Go to "Utilities" on page 79.

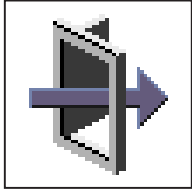

**Exit:** Returns you to the previous screen.

To select an icon, move the cursor with the arrow keys to choose which icon is highlighted, then press the Enter key. You can also select an icon by clicking on it with your left mouse button. To leave the current screen, either press the Esc key or select the **Exit** icon.

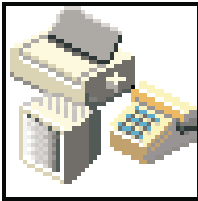

---

## Config



By selecting this icon, you can view information about the setup of your system unit. A list similar to the following displays when you select the **Config** icon.

Device Name  
 PowerPC, POWER3 375 MHz  
 L2-Cache, 4096K  
 PowerPC, POWER3 375 MHz  
 L2-Cache, 4096K  
 Memory  
     Memory Card slot 1, Module Slot =1 size=128MB  
     Memory Card slot 1, Module Slot =2 size=128MB  
 Service Processor  
 Tablet Port  
 LPT  addr=378  
 Com  addr=3F8  
 Com  addr=2F8  
 Audio  
 Keyboard  
 Mouse  
  
**Integrated Ethernet**  
     addr=9999FF111R  
 SCSI controller id= 7

If more than one screen of information is available, a blue arrow displays in the top right corner of the screen. Use the Page Up and Page Down keys to scroll through the pages.

---

## Multiboot



The options available from this screen allow you to view and set various options regarding the operating system and boot devices.

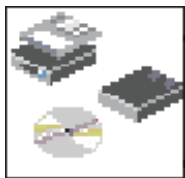
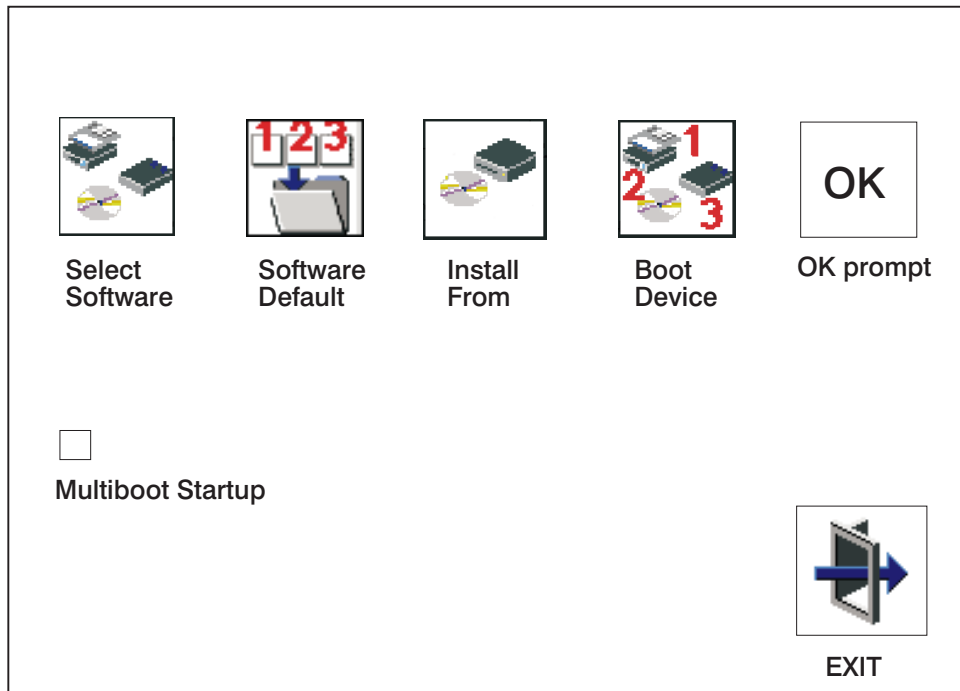

The following describes the choices available on this screen.

**Select Software:** This option, if supported by the operating system, allows you to choose which operating system to use. Choosing an operating system causes the system to start. This option is supported by AIX. However, not all operating systems support this option.

If you receive an informational message saying that no operating system is installed, then the system information in nonvolatile storage may have been lost. This situation can occur if the battery has been removed. To correct this situation, refer to the **bootlist** reference in your AIX operating system documentation.



**Software Default:** This option, if supported by the operating system, enables you to select a default operating system for your system unit.

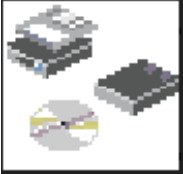
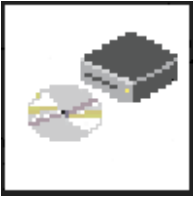

**Install From:** Enables you to select a media drive from which to install an operating system. Selection of a device is done using the spacebar.

**Boot Sequence:** Enables you to view and change the custom boot list (the sequence in which devices are searched for operating system code). You may choose from 1 to 5 devices for the custom boot list.

The default boot sequence is:

1. Primary diskette drive
2. CD-ROM drive
3. Tape drive
4. Hard disk drive
5. Network device

To change the custom boot list, enter a new order in the **New** column, then click on the **Save** icon. The list of boot devices is updated to reflect the new order.

**Attention:** To change the custom boot list back to the default values, click on **Default**. If you change your startup sequence, you must be extremely careful when performing *write* operations (for example, copying, saving, or formatting). You can accidentally overwrite data or programs if you select the wrong drive.

**OK Prompt:** Enables you to go directly to the Open Firmware command prompt. The Open Firmware command prompt is used for debugging and device driver development. For more information about the operation of the Open Firmware command prompt, refer to IEEE Standard 1275.

**Note:** This is for debugging and device development only. Do not invoke this feature if you are not familiar with Open Firmware. To exit from the command prompt, restart your system.

**Multiboot Startup:** Clicking on this button toggles whether the Multiboot menu displays automatically at startup.

## Utilities



Selecting this icon enables you to perform various tasks and view additional information about your system unit.

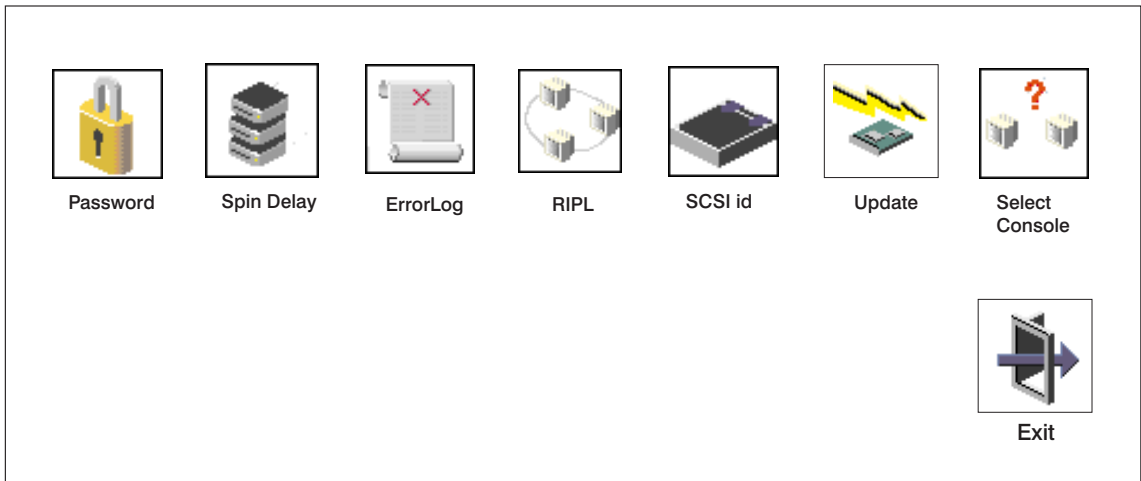

The following describes the choices available on this screen.

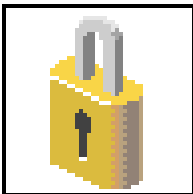

**Password:** Enables you to set password protection for turning on the system unit and for using system administration tools. Go to “Password” on page 80.

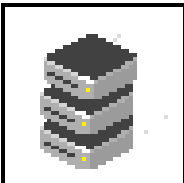

**Spin Delay:** Enables you to change the spin-up delay for SCSI hard disk drives attached to your system. Go to “Spin Delay” on page 84.

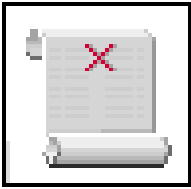

**Error Log:** Enables you to view and clear the firmware error log information for your system unit. Go to “ErrorLog” on page 85.

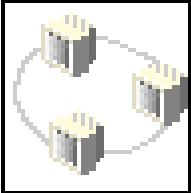

**RIPL (Remote Initial Program Load):** Enables you to select a remote system from which to load programs through a network adapter when your system unit is first turned on. This option also allows you to configure network adapters that are required for RIPL. Go to “RIPL” on page 86.

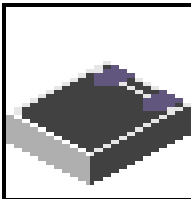

**SCSI ID:** Allows you to view and change the addresses (IDs) of the SCSI controllers attached to your system unit. Go to “SCSI ID” on page 91.

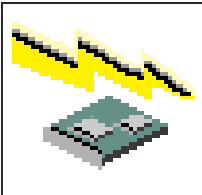

**Firmware Update:** Allows you to update the system firmware program. Go to “Firmware Update” on page 92.



**Select Console:** Allows the user to select which console the user would like to use to display the SMS Menus. This selection is only for the SMS Menus and does not affect the display used by the AIX operating system.

Follow the instructions that display on the screen, select the console from the screen. Press F1 the system will start the boot to AIX. Go to “Select Console” on page 104.

---

## Password

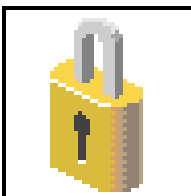



Select this icon to perform password-related tasks.

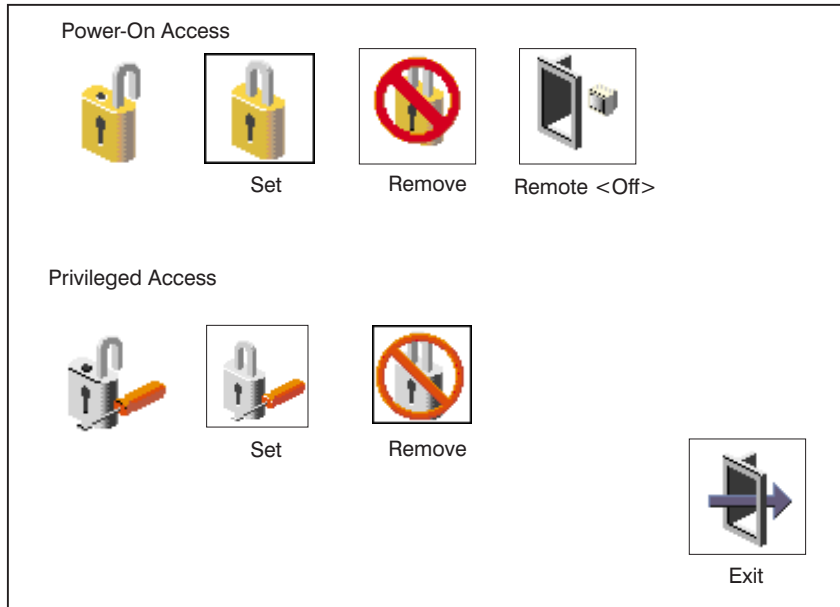

## Power-On Password

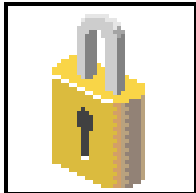

Setting a **Power-On Access** password helps protect information stored in your system unit. If a Power-On Access password is set for your system unit, the Power-On Access status icon is shown in the locked position. If a Power-On Access password is not set, then the Power-On Access status icon is shown in the unlocked position (as shown in the screen above).

When you select the **Set** icon, a screen with eight empty boxes displays. Type your password in these boxes. You can use any combination of up to eight characters (A–Z, a–z, and 0–9) for your password. As you type a character, a key displays in the box.

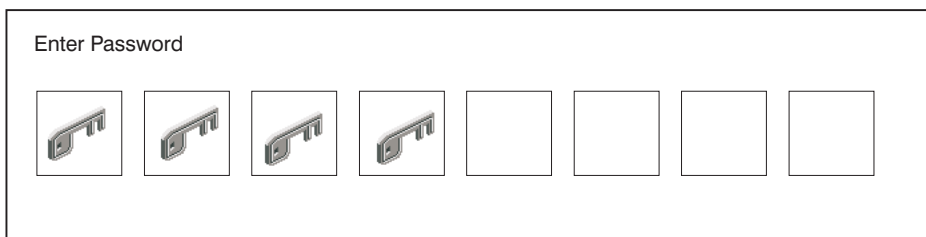

Press Enter when you are finished; you must type the password again for verification.

Verify Password

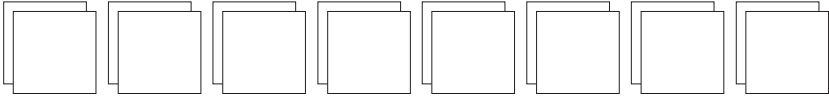

If the two password entries do not match, an error icon displays with a message: Password was attempted to be set and an error code Power-On Access: 20E00000 displays.

**Note:** If you *forget* the Power-On Access password, you can erase the password by shutting down the system unit and removing the battery for at least 30 seconds.

A password becomes effective only after the system is turned off and back on again.

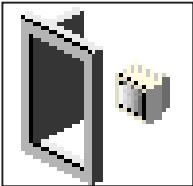

**Remote Mode:** The remote mode, when enabled, allows the system to start from the defined boot device. This mode is ideal for network servers and other system units that operate unattended. When the remote mode is set, the icon label changes to **Remote <On>**.

**Note:** To use the remote mode feature for booting unattended devices, you must enable the unattended start mode. See the “System Power Control Menu” on page 48 for instructions on enabling the unattended start mode, which allows the system unit to turn on whenever ac power is applied to the system (instead of having the system unit wait for the power button to be pushed).

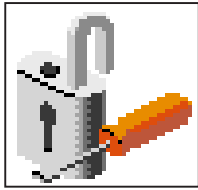



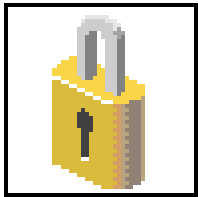

## Privileged-Access Password

The privileged-access password protects against the unauthorized starting of the system programs. Select the **Set** icon to set and verify the privileged-access password.



When you select the **Set** icon, a screen with 8 empty boxes displays. Type your password in these boxes. You can use any combination of up to eight characters (A–Z, a–z, and 0–9) for your password. As you type a character, a key displays in the box.

Enter Password

							
---	---	---	---	--	--	--	--

Press Enter when you are finished; you must type the password again for verification.

Verify Password

--	--	--	--	--	--	--	--

If you type the password incorrectly, press the Esc key and start again.

If the two password entries do not match, an error icon displays with a message: Password was attempted to be set and an error code Privileged Access: 20E00001 displays.

If you previously had set a privileged-access password and want to remove it, select the **Remove** icon.

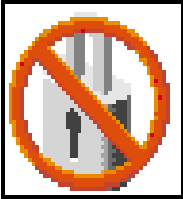

After you have selected the remove icon. The privileged-access status icon flashes and changes to the unlock position to indicate that the privileged-access not set.

**Note:** After you have entered and verified the password, the privileged-access password icon flashes and changes to the locked position to indicate that your system unit now requires the password that you just entered before running system programs.

**Attention:** If no user-defined bootlist exists and the privileged-access password has been enabled, you are asked for the privileged-access password at startup every time you boot your system.

## Spin Delay

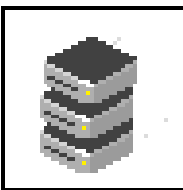

Select this icon to change the spin-up delay for SCSI hard disk drives attached to your system. Spin-up delay values can be entered manually or you can use a default setting. All values are measured in seconds. The default is two seconds. After you have entered the new Spin-up delay values, use the arrow keys to highlight the **Save** icon and press Enter.

<Hard Disk Spinup Delay>

Current Spin Up Value - 2

Enter New Value (>1)  (SEC)



Save

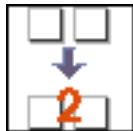

Default



Exit

---

## ErrorLog

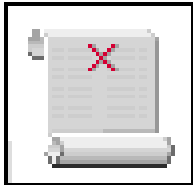

Selecting this icon displays the log of errors that your system unit has encountered during operations.

System Error Log

Date	Time	Error Code	Location
1. 00/04/13	00:51:32	25C38005	P1-M1.10
2. No entry			



Clear



Exit

Selecting the **Clear** icon erases the entries in this log.

This error log only shows the first and last errors.

---

## RIPL

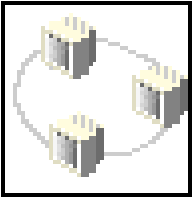

Selecting the Remote Initial Program Load (RIPL) icon gives you access to the following selections.

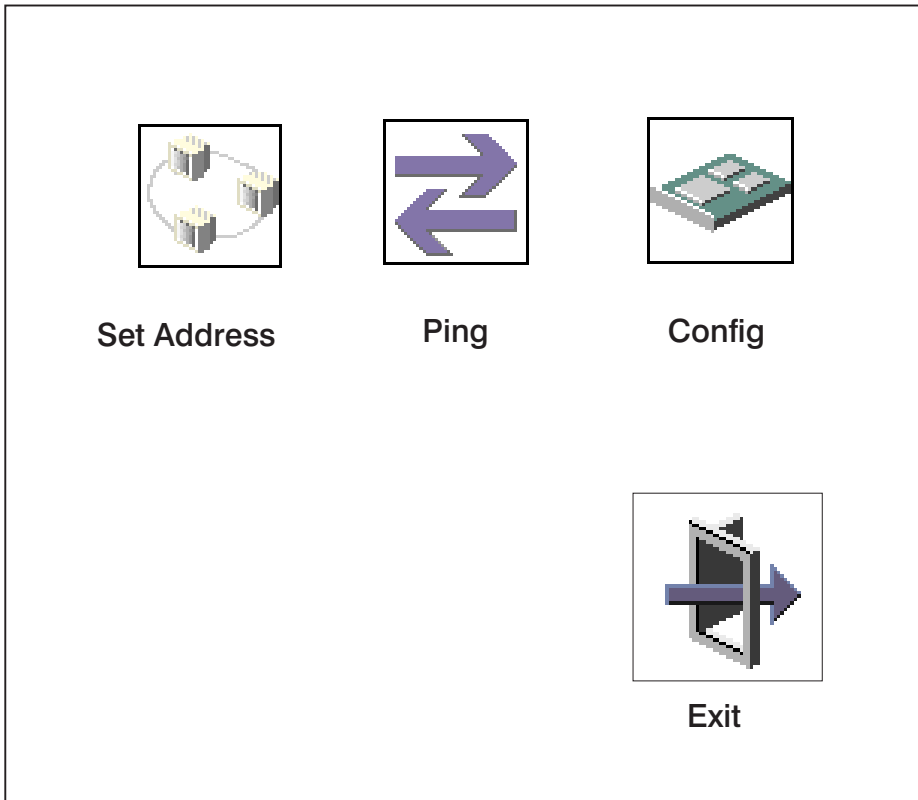

## Set Address

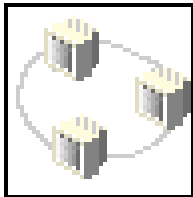

The **Set Address** icon allows you to define addresses from which your system unit can receive RIPL code.

## Remote IPL Setup

Client Addr	000.000.000.000
Server Addr	000.000.000.000
Gateway Addr	000.000.000.000
Subnet Mask	255.255.255.000

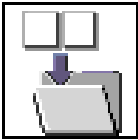

**Save**



**Exit**

If any of the addresses is incomplete or contains a number other than 0 to 255, an error message displays when you select the **Save** icon. To clear this error, correct the address and select **Save** again.

**Attention:** If the client system and the server are on the same subnet, set the gateway IP address to [0.0.0.0].

To change an address, press the backspace key on the highlighted address until the old address is completely deleted. Then enter the new address.

## Ping

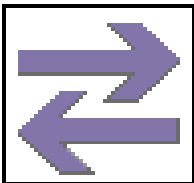

The **Ping** icon allows you to confirm that a specified address is valid by sending a test transmission to that address.



## Ping Setup

Client Addr	000.000.000.000
Server Addr	000.000.000.000
Gateway Addr	000.000.000.000
Subnet Mask	255.255.255.000

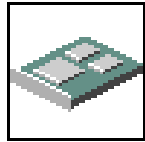

Adapter



Exit

To change an address, press the backspace key on the highlighted address until the old address is completely deleted. Then enter the new address.

Selecting the **Ping** icon displays a screen in which you select the communications (token-Ring or Ethernet) to be used to send test transmissions.

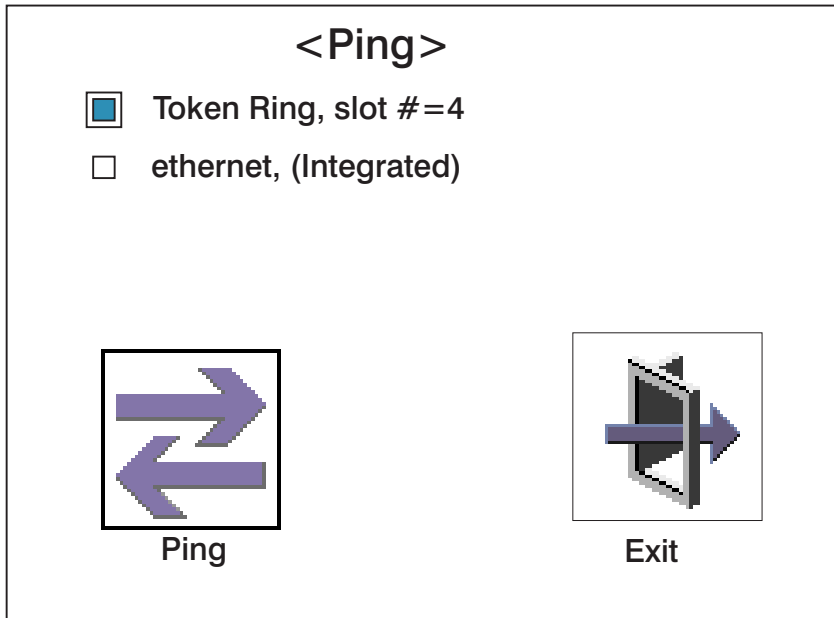

To send the test, do the following:

1. Use the arrow keys or mouse to highlight an adapter to configure.
2. Press the spacebar to select the adapter.
3. Highlight the **Ping** icon and press Enter to send the test transmission.

## Config

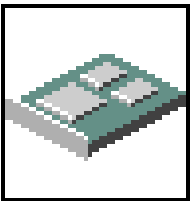

The **Config** icon allows you to configure network adapters which require setup.

Selecting the **Config** icon causes a list of the adapters requiring configuration to display.

To use this screen, do the following:

1. Use the arrow keys or mouse to highlight an adapter to configure.
2. Press the spacebar to select the adapter.
3. Highlight the **OK** icon and press Enter.

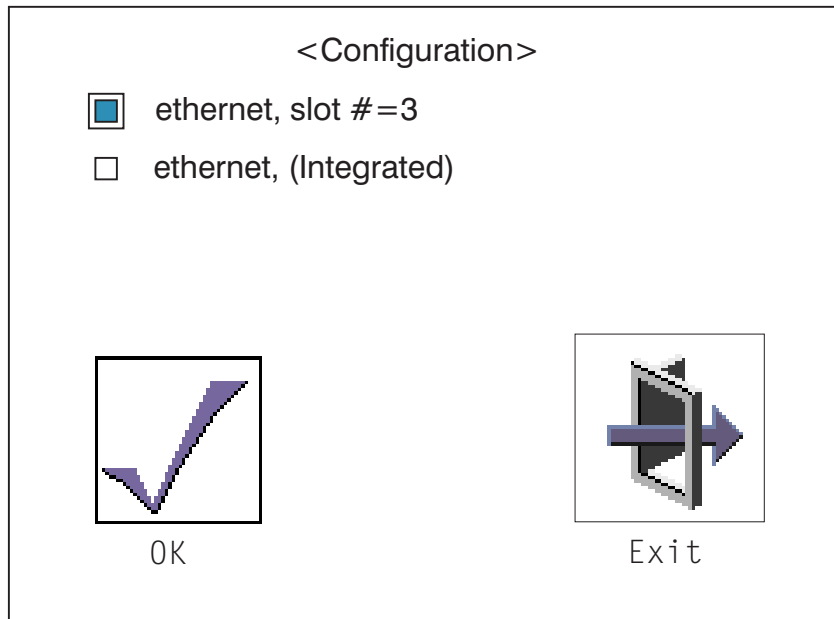

---

## SCSI ID

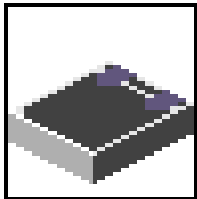

Select this icon to view and change the addresses (IDs) of the SCSI controllers attached to your system unit. To change a SCSI controller ID, highlight the entry by moving the up or down arrow keys, then use the spacebar to scroll through available IDs. After you have entered the new address, use the left or right arrow keys or mouse to highlight the **Save** icon and press Enter.

At any time in this process, you can select the **Default** icon to change the SCSI IDs to the default value of 7.

## Change SCSI ID

Type	Slot	Id	Max Id
Ultra	0	7	15
Fast/Wide	0	7	15



Save



Default



Exit

---

## Firmware Update

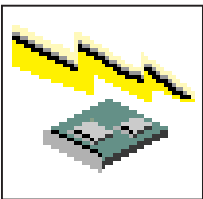

Select this icon to update the system or service processor firmware in your system unit from an image on a 3.5 inch diskette.

To update system and service processor firmware, use the Diagnostics Service Aid under AIX. To obtain firmware updates, as well as update instructions, see the following Web address: <http://www.rs6000.ibm.com/support/micro>

If you are not able to obtain firmware updates or instructions from this Web address, contact your service representative for assistance.

Only use the Firmware Update utility described here if instructed by an authorized representative, or by instructions from the Web address listed above, or during the recovery of damaged firmware.

When you are prompted, insert the firmware update diskette containing the new firmware image.

**Attention:** While the new firmware image is being copied into your system unit, you must *not* turn off the system unit. Turning off the system unit during the update process may render your system unit inoperable.

After the firmware update is complete, shut down and restart the system unit.

If the firmware update does not complete successfully or the system unit does not restart after the firmware update, contact your authorized reseller or marketing representative.

## Firmware Recovery

If a troubleshooting procedure has indicated that the system firmware unit has been damaged, it may be possible to recover it. For example, if the system hangs during startup with E1EA displayed on the operator panel, the system firmware has been damaged but may be recovered.

To recover from a damaged system firmware, do the following:

1. Create a firmware recovery diskette. This must be a 3.5" high-density (1.44 MB) diskette that has been formatted for DOS.
2. Obtain the system firmware update image file from one of the following sources:
  - a. From the Web address: <http://www.rs6000.ibm.com/support/micro>
  - b. From a service representative if you cannot access the Web address.
3. Copy the system firmware update image file to the recovery diskette, naming it PRECOVER.IMG. The file must be written in DOS format.
4. When the system stops booting, for example at E1EA, insert the recovery diskette. If the diskette drive LED does not light up, power the system unit off, then back on again.
5. If the recovery procedure is successful, the system will continue starting up and display checkpoints of the form E1XX.
6. Enter the System Management Services menu. When the keyboard indicator displays, press the 1 key if the system console is an ASCII terminal. If the system console is a graphics display and directly attached keyboard, press the F1 key.
7. When the main menu displays, choose **Utilities**, then perform a firmware update of the system firmware as described on page "Firmware Update" on page 92.

---

## Text-Based System Management Services

The text-based Open Firmware command line and System Management Services are available if an ASCII terminal is attached to your system unit. The text-based Open Firmware command line allows you to configure some adapters, and the System Management Services makes it possible for you to view information about your system unit and to perform such tasks as setting passwords and changing device configurations.

To start the text-based System Management Services instead of the Open Firmware command line, press the number **1** key on the ASCII terminal keyboard when the keyboard text symbol displays during startup. After the text-based System Management Services starts, the following screen displays.

**Note:** The version of firmware currently installed in your system unit is displayed at the top of each screen in the text-based System Management Services. Note the version number. Processor and other device upgrades may require the specified version of firmware to be installed in your system unit. Update System Firmware is an option under the Utilities menu.

```
System Management Services
```

```
1  Display Configuration
2  Multiboot
3  Utilities
4  Select Language
```

```
  |X=Exit|
  |-----|
```

```
====>
```

After you have finished using the text-based System Management Services, type **x** (for exit) to start your system unit. The **x** takes you back to the prior screen.

---

## Display Configuration

This option provides information about the setup of your system unit. A screen similar to the following is displayed.

```
Device Name
Power PC, POWER3 375 MHz
L2-Cache 4096K
Power PC, POWER3 375 MHz
L2-Cache 4096K
Memory
  Memory card slot=1, module slot=1 size=128MB
  Memory card slot=1, module slot=2 size=128MB
Service Processor
Tablet Port
LPT
  addr=378
COM
  addr=3F8
COM
  addr=2F8
Audio
Keyboard
Mouse
Diskette Drive
  addr=3F0
SCSI controller id=7
```

```
|P=prev-page| |N=next-page|
```

```
|X=Exit|
```

---

## Multiboot Menu

Use this screen to view and set various options regarding the operating system and boot sequence.

```
Multiboot Menu
1 Select Software
2 Software Default
3 Select Install Device
4 Select Boot Device
5 OK Prompt
6 Multiboot Startup
```

```
|X=Exit|
```

```
===>
```

**Select Software:** If this option is supported by the operating system, shows the name of the operating system installed. This option may not be supported by all operating systems.

If you are running on AIX and you receive the following message:

```
No Operating System Installed
```

this indicates that information in nonvolatile storage could have been lost, as would happen if the battery had been removed. To re-create this value, run the **bootlist** command under AIX with the appropriate parameters as to the location of the operating system in a particular hard disk. See the **bootlist** command in your AIX documentation.

**Software Default:** If supported by the operating system, lets you select the default operating system to start the system. This option may not be supported by all operating systems.

**Select Install Device:** Produces a list of devices, for example the CD-ROM, from which the operating system is installed. Select a device and the system searches the device for an operating system to install and if supported by the operating system in that device, the name of the operating system displays.

**Boot Device:** Provides a list of devices that can be selected to be stored on the boot list. Up to five devices are supported.

**OK Prompt:** Provides access to the Open Firmware command prompt.

**Multiboot Startup:** Toggles between OFF and ON and selects whether the Multiboot menu invokes automatically on startup.

## Select Boot Device

Select this option to view and change the custom boot list, which is the sequence of devices read at startup time.

```
Select Boot Devices
```

```
1 Display Current Settings
2 Restore Default Settings
3 Configure 1st Boot Device
4 Configure 2nd Boot Device
5 Configure 3rd Boot Device
6 Configure 4th Boot Device
7 Configure 5th Boot Device
```

```
|X=Exit|
```

```
====>
```



**Display Current Settings:** Lists the current order of devices in the boot list. The following screen shows an example of this display.

Current Boot Device

1. Diskette
2. Ethernet (Integrated)
3. SCSI CD-ROM id=3 (slot=1)
4. SCSI 4.5 GB Hard Disk id=6 (slot=1)
5. SCSI 4.5 GB Hard Disk id=5 (slot=5)

[X=Exit]

**Restore Default Settings:** Restores the boot list to the default device of:

1. Primary diskette drive
2. CD-ROM drive
3. Tape drive
4. Hard disk drive
5. Network device.

**Attention:** To change the custom boot list back to the default values, select the **Default**. If you change your startup sequence, you must be extremely careful when performing *write* operations (for example, copying, saving, or formatting). You can accidentally overwrite data or programs if you select the wrong drive.

## Configure Nth Boot Device

In the description below, **Nth** can be **1st**, **2nd**, **3rd**, etc. depending on your choice on the previous menu.

Options display a screen similar to the following:

### Configure Nth Boot Device

Device Number	Current Position	Device Name
1	1	Diskette
2	2	Ethernet
3	3	SCSI CD-ROM
4	4	SCSI 4.5GB Hard Disk
5	-	

|X=Exit|

====>

Type the device number of the device name that you want to select as the **Nth** boot device. For example, if you entered this menu by selecting 4 on the previous menu (configure 2nd Boot Device), then enter the number 3 based on the list shown above. You are thus selecting the SCSI CD-ROM device to be the 2nd (**Nth**) device in the boot sequence.

---

## Utilities

The Utilities screen enables you to select from the following system management tools.

### Utilities

- 1 Set Passwords and Unattended Start Mode
- 2 SCSI Spin up
- 3 Display Error Log
- 4 Remote Initial Program Load Setup
- 5 Change SCSI id
- 6 Update System Firmware
- 7 Update Service Processor Firmware
- 8 Select Console

|X=Exit|

====>

## Set Password and Unattended Start Mode

Entering this selection permits access to the following options:

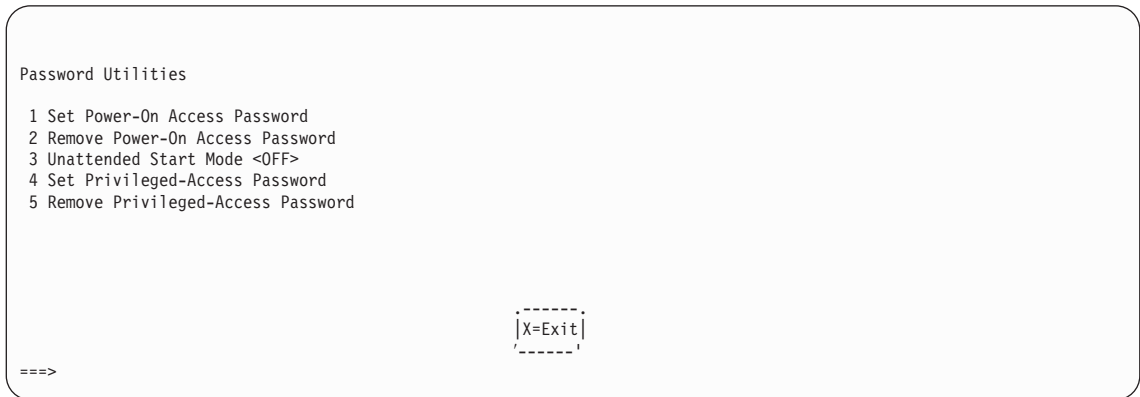

### Set Power-On Access Password

Setting a Power-On Access password helps protect information stored in your computer. You can use any combination of up to eight characters (A–Z, a–z, and 0–9) for your password. The password you type is not displayed on the screen. Press Enter when you are finished; you must type the password again for verification. Passwords are not case-sensitive upon entry.

If you previously had set a Power-On Access password and want to remove it, select **Remove Power-On Access Password**.

**Note:** If you forget the Power-On Access password, the battery must be removed for longer than 30 seconds to reset the NVRAM. The system unit power cable must be disconnected before removing the battery.

A password becomes effective only after the system is turned off and back on again.

### Unattended Start Mode:

**Note:** Unlike other systems, unattended start mode is not automatically disabled when the Power-On Access password is removed.

### Set Privileged-Access Password

The privileged-access password protects against the unauthorized starting of the system programs.

**Attention:** If the privileged-access password has been enabled, you are asked for the privileged-access password at startup every time you boot your system.

If you previously had set a privileged-access password and want to remove it, select **Remove Privileged-Access Password**.

## SCSI Spin Up

Selecting this utility allows you to adjust the hard disk spin-up delay in your system unit.

## Display Error Log

Use this option to view or clear your system unit's error log. A screen similar to the following displays when you select this option.

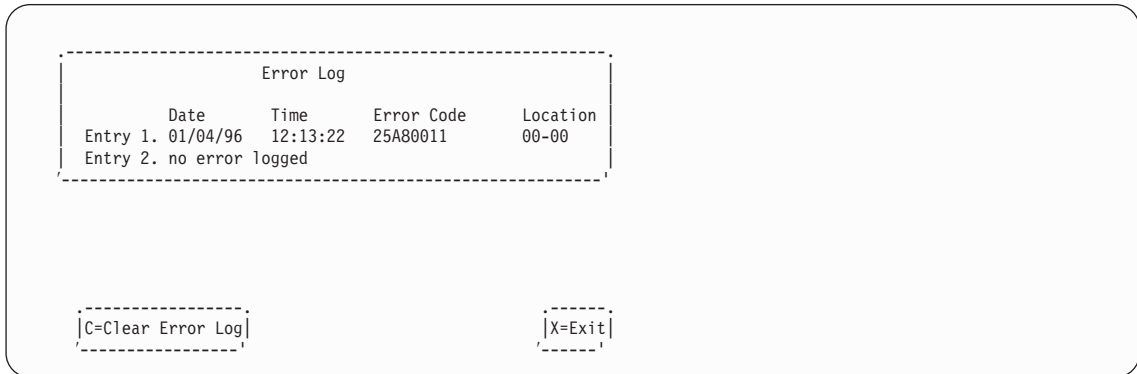

**Note:** The time stamp in his error log is Coordinated Universal Time (CUT), which is also referred to as Greenwich Mean Time (GMT). AIX error logs have more information available and can time stamp with your local time.

## Remote Initial Program Load Setup

This option allows you to enable and set up the remote startup capability of your system unit. You must first specify the network parameters.

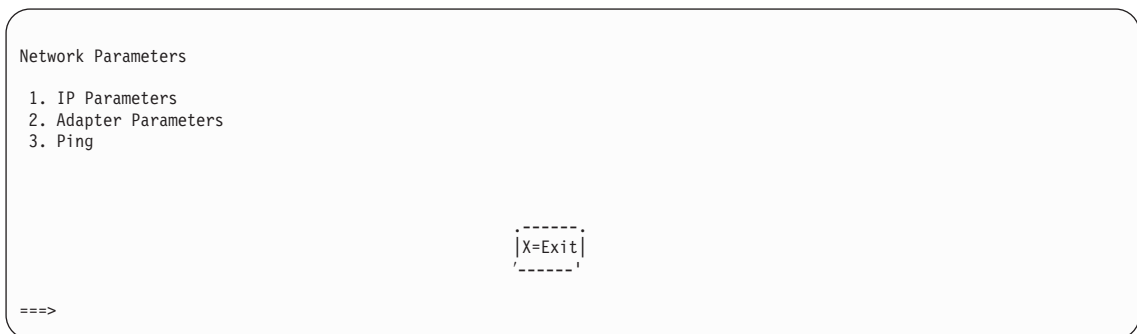

Selecting the IP (Internet Protocol) Parameters option displays the following screen.

IP Parameters

- 1. Client IP Address [000.000.000.000]
- 2. Server IP Address [000.000.000.000]
- 3. Gateway IP Address [000.000.000.000]
- 4. Subnet Mask [255.255.255.000]

|X=Exit|

===>

To change IP Parameters, type the number of the parameters for which you want to change the value.

**Attention:** If the client system and the server are on the same subnet, set the gateway IP address to [0.0.0.0].

Selecting the Adapter Parameters option allows you to view an adapter's hardware address, as well as configure network adapters that require setup. A screen similar to the following displays.

Device	Slot	Hardware Address
1. ethernet	3	0004AC5E08D2
2. token-ring	5	0020357A0530
3. ethernet	Integrated	0004ACE4020B

|X=Exit|

(Press enter after making selection)

===>

Selecting an adapter on this screen displays configuration menus for that adapter:

10/10c ethernet TP PCI Adapter

- 1. Data Rate [Auto]
- 2. Full Duplex [Auto]

[X=Exit]

Selecting the **Data Rate** option allows you to change the media employed by the Ethernet adapter:

DATA RATE  
1. 10 Mbps  
2. 100 Mbps  
3. Auto

====>

Selecting the **Full Duplex** option allows you to change how the Ethernet adapter communicates with the network:

Full Duplex  
1. Yes  
2. No  
3. Auto

====>

Select **Ping**, from the Network Parameters Menu, to test a connection to a remote system unit. After selecting the Ping Option, you must choose which adapter communicates with the remote system.

```

Device                Slot      Hardware Address
1. ethernet           3       0004AC5E08D2
2. token-ring         5       0020357A0530
3. ethernet Integrated      0004ACE4020B

                                |X=Exit|
                                -----

(Press enter after making selection)          ==>

```

After choosing which adapter to use to ping the remote system, you must provide the addresses needed to communicate with the remote system.

```

Ping IP Address
1. Client IP Address  [129.132.4.20]
2. Server IP Address  [129.132.4.10]
3. Gateway IP Address [129.132.4.30]
4. Subnet Mask        [255.255.255.0]

                                |E=Execute|
                                -----
                                |X=Exit|
                                -----

====>

```

## Change SCSI ID

This option allow you to view and change the addresses of the SCSI controllers attached to your system unit.

## Update System or Service Processor Firmware

These options allow you to update your system or service processor firmware from an image on a 3.5 inch diskette. Note that you must insert a diskette containing the firmware update image after you see a confirmation screen.

To update system and service processor firmware, use the Diagnostic Service Aid under AIX. To obtain firmware updates, as well as update instructions, see the following Web address: <http://www.rs6000.ibm.com/support/micro>.

If you are not able to obtain firmware updates or instructions from this Web address, contact your Service representative for assistance.

Only use the Firmware Update utility described here if instructed by an authorized representative or by instructions from the Web address posted above, or during the recovery of damaged firmware.

When you are prompted, insert the firmware update diskette containing the new firmware image.

This selection will update your system firmware. Do you want to continue? Press Y(Yes) N(No).

**Attention:** While the new firmware image is being copied into your system unit, *do not* turn off the system unit. Turning off the system unit during the update process can render your system unit inoperable.

After the firmware update is complete, shut down and restart the system unit.

If the firmware update does not complete successfully or the system unit does not restart after the firmware update, contact your authorized reseller or marketing representative.

## Firmware Recovery

For instructions on firmware recovery, go to “Firmware Recovery” on page 93.

## Select Console

The Select Console Utility allows the user to select which console the user would like to use to display the SMS Menus. This selection is only for the SMS Menus and does not affect the display used by the AIX operating system.

Follow the instructions that display on the screen, select the console from the screen. Press 1 and the system will start the boot to AIX.

---

## Select Language

This option allows you to change the language used by the text-based System Management Services screens.



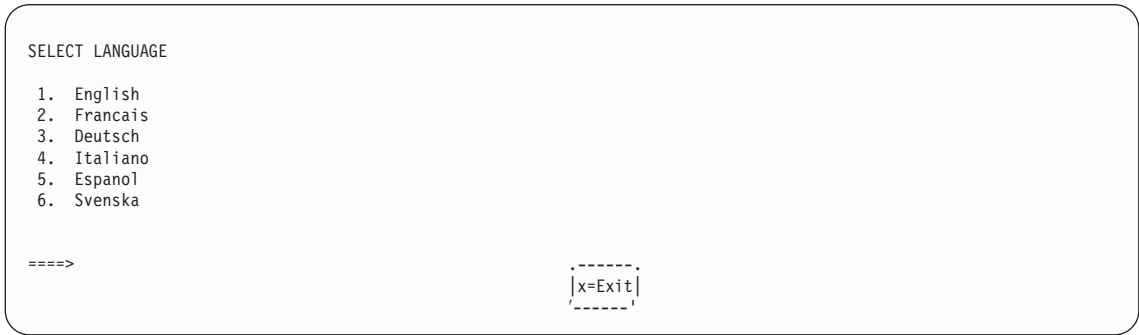

---

## Open Firmware

To enter the Open Firmware command line, press the number 8 key *after* the keyboard text symbol displays during startup. If you have pressed the number 8 key, the Open Firmware command line (an OK prompt) displays after the initialization and power-on self tests (POST) are complete. The Open Firmware command line can be used to set up adapters that are not configurable with the System Management Services. Your adapter documentation directs you to use this option if it is needed.

**Note:** Your TTY must support the ISO-8859 character set to properly display languages other than English.

To enter the Open Firmware command line, you must press the F8 key *after* the keyboard icon displays during startup.

If you have pressed the F8 key, the Open Firmware command line (an OK prompt) displays after the initialization and power-on self test (POST) are complete.

**Note:** If you have installed a privileged-access password, you are prompted for this password before you gain access to the Open Firmware command line.

The Open Firmware command line can be used to set up adapters that are not configurable with the System Management Services. Your adapter documentation directs you to use this option if it is needed.



---

## Chapter 5. Using the Standalone and Online Diagnostics

The diagnostics consist of Standalone Diagnostics and Online Diagnostics. Standalone Diagnostics are packaged on removable media and must be booted before they can be run. If booted, they have no access to the AIX error log or the AIX configuration data.

Online Diagnostics, when installed, reside with AIX on the disk or server. They can be run in any of the following ways:

- Booted in single user mode (called *service mode*)
- Run in maintenance mode (called *maintenance mode*)
- Concurrently (called *concurrent mode*) with other applications.

The online diagnostics have access to the AIX error log and the AIX configuration data.

---

### Standalone and Online Diagnostics Operating Considerations

Consider the following before using the diagnostics:

- Run Online Diagnostics in Service Mode when possible, unless otherwise directed. The Online Diagnostics perform additional functions, compared to Standalone Diagnostics. This ensures that the error state of the system is captured in NVRAM for your use in fixing the problem. The AIX error log and certain SMIT functions are only available when diagnostics are run from the disk drive.
- When you run Online Diagnostics, device support for some devices might not have been installed. If this is the case, that device does not appear in the resource list.
- When you run Standalone Diagnostics, device support for some devices might be contained on supplemental diagnostic media. If this is the case, the device does not appear in the resource list when running diagnostics unless the supplemental media has been processed.
- Support for some TTY terminals is optionally installed. If you attach a TTY terminal to a system to run diagnostics, it might not work correctly because the AIX support for the terminal may not be installed.

### Selecting a Console Display

When you run Standalone Diagnostics (and under some conditions Online Diagnostics), you must select the console display. The diagnostics display instructions on any graphics display and the terminal attached to the S1 serial port.

### Identifying the Terminal Type to the Diagnostics Programs

**Note:** This is a different function from selecting a console display.

When you run diagnostics, you must identify what type of terminal you are using. If the terminal type is not known when the FUNCTION SELECTION menu is displayed, the diagnostics do not allow you to continue until a terminal is selected from the DEFINE TERMINAL option menu. Select **lft** for adapter-attached displays.

## Undefined Terminal Types

If you specify an undefined terminal type from the DEFINE TERMINAL option menu, the menu prompts you to enter a valid terminal type. The menu redisplay until either a valid type is entered or the user exits the DEFINE TERMINAL option.

## Resetting the Terminal

If you enter a terminal type that is valid (according to the DEFINE TERMINAL option menu) but is not the correct type for the ASCII terminal being used, you may be unable to read the screen, use the function keys, or use the Enter key. Bypass these difficulties by pressing Ctrl-C to reset the terminal. The screen display which results from this resetting action depends on the mode in which the system is being run:

- Online Normal or Maintenance Mode - The command prompt displays.
- Standalone Mode or Online Service Mode - The terminal type is reset to dumb, the Diagnostic Operating Instruction panel displays, and you are required to go through the DEFINE TERMINAL process again.

## Running Standalone Diagnostics

Consider the following when you run Standalone Diagnostics:

- The diagnostic disc must remain in the CD-ROM drive for the entire time that the diagnostics are running.
- The diagnostic disc cannot be ejected from the CD-ROM drive after the diagnostic programs have loaded. The disc can only be ejected after the system has been turned off and then turned on (Standalone mode) or after the diagnostics program has terminated (Online concurrent mode). The disc must be ejected before the system attempts to load the diagnostic programs again.
- The CD-ROM drive from which diagnostics were loaded cannot be tested.
- The SCSI adapter (or circuitry) controlling the CD-ROM drive from which diagnostics were loaded cannot be tested.

## Running Online Diagnostics

Consider the following when you run the Online Diagnostics from a server or a disk:

- The diagnostics cannot be loaded and run from a disk until the AIX operating system has been installed and configured. After the AIX operating system has been installed, all three modes of operation are available.
- The diagnostics cannot be loaded on a system (client) from a server if that system is not set up to IPL from a server over a network, or the server has not been set up to send a service mode IPL of the diagnostics. When the system is set up to IPL from a server, the diagnostics are run in the same manner as they are from disk.
- If the diagnostics were loaded from disk or a server, you must shut down the AIX operating system before turning off the system unit to prevent possible damage to disk data. This is done in one of two ways:
  - If the diagnostic programs were loaded in Stand-Alone mode, press the F3 key until DIAGNOSTIC OPERATING INSTRUCTIONS displays. Then follow the displayed instructions to shut down the AIX operating system.
  - If the diagnostic programs were loaded in maintenance or concurrent mode, enter the shutdown -F command.

- Under some conditions the system may stop, with instructions displayed on attached displays and terminals. Follow the instructions to select a console display.

## Running Diagnostics from a TTY Terminal

Consider the following when you run diagnostics using a TTY-type terminal as the console display:

- See the operator manual for your type of TTY terminal to find the key sequences you need to respond to the diagnostics. For the 3151, refer to the *3151 ASCII Display Station Guide to Operations*, form number GA18-2633. For the 3164, refer to the *3164 ASCII Color Display Station Description*, form number GA18-2617.
- When the diagnostics present display information through the S1 port, certain attributes are used. These attributes are set as if the diagnostics were using a 3161 display terminal. Refer to the tables in “Appendix D. General Attributes Required When Using a TTY Terminal” on page 165 for a list of attributes for the 3161 ASCII Display Terminal and for two other ASCII display terminals commonly used with the system.
- If you have a TTY terminal other than a 3151, 3161, or 3164 attached to the S1 port, your terminal may have different names for the attributes. Refer to the tables in “Appendix D. General Attributes Required When Using a TTY Terminal” on page 165. Use the attribute descriptions listed there to determine the settings for your terminal.

---

## Online Diagnostics Modes

The Online diagnostics can be run in three modes:

- Service Mode allows checking of most system resources.
- Concurrent Mode allows the normal system functions to continue while selected resources are being checked.
- Maintenance Mode allows checking of most system resources.

## Service Mode

Service mode provides the most complete checkout of the system resources. This mode also requires that no other programs be running on the system. All system resources except the SCSI adapter and the disk drives used for paging can be tested. However, note that system memory and the processor are only tested during POST.

Error log analysis is done in service mode when you select the Problem Determination option on the DIAGNOSTIC MODE SELECTION menu.

To run Online diagnostics in service mode, use the following steps:

1. Stop all programs, including the AIX operating system.
2. Remove all tapes, diskettes, and CD-ROM discs.
3. Turn off the system unit's power.
4. Turn on the system unit's power.
5. After the first POST indicator displays on the system unit's console, press F6 on the directly attached keyboard or 6 on the TTY keyboard to indicate that diagnostics are to be loaded.

**Note:** The term *POST indicator* refers to the Icons (graphic display) or device mnemonics (ASCII terminal) that are displayed while the POST is executing.

6. Enter any requested password.
7. Follow any instructions to select a console.
8. After the diagnostic controller loads, DIAGNOSTIC OPERATING INSTRUCTIONS appear on the console display.
9. Follow the displayed instructions to check out the desired resources.
10. When testing is complete, use the F3 key to return to the DIAGNOSTIC OPERATING INSTRUCTIONS.
11. Press the F3 key (from a defined terminal) or press 99 (for an undefined terminal) to shut down the diagnostics before turning off the system unit.

**Note:** Pressing the F3 key (from a defined terminal) produces a Confirm Exit menu containing two options:

- Continue with the shutdown by pressing F3.
- Return to diagnostics by pressing Enter.

For undefined terminals, pressing 99 produces a menu containing two options:

- Continue with the shutdown by pressing 99, then Enter
- Return to diagnostics by pressing Enter.

## Concurrent Mode

Concurrent mode provides a way to run Online diagnostics on some of the system resources while the system is running normal activity.

Because the system is running in normal operation, some of the resources cannot be tested. The following resources cannot be tested in concurrent mode:

- SCSI adapters connected to paging devices
- Disk drive used for paging
- Any graphics-related device if running X, CDE, or windowing environment.
- Memory
- Processor

Three levels of testing are available in concurrent mode:

- The **share-test level** tests a resource while the resource is being shared by programs running in the normal operation. This testing is mostly limited to normal commands that test for the presence of a device or adapter.
- The **sub-test level** tests a portion of a resource while the remaining part of the resource is being used in normal operation. For example, this test could test one port of a multiport device while the other ports are being used in normal operation.
- The **full-test level** requires the device not be assigned to or used by any other operation. This level of testing on a disk drive might require the use of the **varyoff** command. The diagnostics display menus allow you to vary off the needed resource.

Error-log analysis is done in concurrent mode when you select the **Problem Determination** option on the DIAGNOSTIC MODE SELECTION menu.

To run the Online diagnostics in concurrent mode, you must be logged in to the AIX operating system and have the appropriate proper authority to issue the commands.

The **diag** command loads the diagnostic controller and displays the Online diagnostic menus.

## Running the Online Diagnostics in Concurrent Mode

To run Online diagnostics in concurrent mode, use the following steps:

1. Log in to the AIX operating system as root user.
2. Enter the **diag** command.
3. When the DIAGNOSTIC OPERATING INSTRUCTIONS displays, follow the instructions to check out the desired resources.
4. When testing is complete, use the F3 key to return to the DIAGNOSTIC OPERATING INSTRUCTIONS. Then press the F3 key again to return to the AIX operating system prompt. Be sure to vary on any resource you had varied to off.
5. Press the Ctrl-D key sequence to log off from root user.

## Maintenance Mode

Maintenance mode runs the Online diagnostics using the customer's version of the AIX operating system. This mode requires that all activity on the AIX operating system be stopped so the Online diagnostics have most of the resources available to check. All of the system resources except the SCSI adapters, memory, processor, and the disk drive used for paging can be checked.

Error-log analysis is done in maintenance mode when you select the Problem Determination option on the DIAGNOSTIC MODE SELECTION menu.

The **shutdown -m** command is used to stop all activity on the AIX operating system and put the AIX operating system into maintenance mode. The **diag** command is used to invoke the diagnostic controller so you can run the diagnostics. After the diagnostic controller is then loaded, follow the normal diagnostic instructions.

## Running the Online Diagnostics in Maintenance Mode

To run the Online diagnostics in maintenance mode, you must be logged in to the customer's version of the AIX operating system as root user and use the **shutdown -m** and **diag** commands. Use the following steps to run the Online diagnostics in maintenance mode:

1. Stop all programs except the AIX operating system.
2. Log in to the AIX operating system as root user.
3. Enter the **shutdown -m** command.
4. When a message indicates system is in single-user mode, enter the **diag** command.

**Note:** It may be necessary to set *TERM* type again.

5. When DIAGNOSTIC OPERATING INSTRUCTIONS is displayed, follow the displayed instructions to check out the desired resources.
6. When testing is complete, use the F3 key to return to DIAGNOSTIC OPERATING INSTRUCTIONS. Then press the F3 key again to return to the AIX operating system prompt.
7. Press Ctrl-D to log off from root user.

---

## Standalone Diagnostic Operation

Standalone Diagnostics provide a method to test the system when the Online Diagnostics are not installed and as a method of testing the disk drives and other resources that cannot be tested by the Online Diagnostics.

No Error Log Analysis is done by the Stand-Alone Diagnostics.

If running from CD-ROM, the CD-ROM drive and the SCSI controller that controls it cannot be tested by the Standalone Diagnostics.

## Running the Standalone Diagnostics

To run Standalone Diagnostics in service mode, use the following steps:

1. Stop all programs, including the AIX operating system.
2. Remove all tapes, diskettes, and CD-ROMs.
3. Turn off the system unit's power.
4. Set the key mode switch to the service position.
5. Turn on the system unit's power.
6. Insert the diagnostic media drive.
7. When the keyboard POST indicator displays, press the F5 key on the directly attached keyboard, or the number 5 key on the TTY keyboard.
8. Enter any requested passwords.
9. Follow any instruction to select the console.
10. After the diagnostic controller loads, DIAGNOSTIC OPERATING INSTRUCTIONS appear on the console display.
11. Follow the displayed instructions to check out the desired resources.
12. When testing is complete, use the F3 key to return to the DIAGNOSTIC OPERATING INSTRUCTIONS.



---

## Chapter 6. Introducing Tasks and Service Aids

The AIX Diagnostic Package contains programs that are called Tasks. Tasks can be thought of as performing a specific function on a resource; for example, running diagnostics or performing a service aid on a resource. This chapter describes the tasks available in AIX Diagnostics Version 4.2 and later.

**Note:** Many of these programs work on all system model architectures. Some programs are only accessible from online diagnostics in service or concurrent mode, while others may be accessible only from Standalone Diagnostics. Still other programs may only be supported on a particular system architecture, such as CHRP (Common Hardware Reference Platform), or RSPC (PowerPC Reference Platform). The RS/6000 44P Series Model 270 is a CHRP architecture system.

Use the FUNCTION SELECTION menu to perform tasks.

After a task is selected, a resource menu may be presented showing all resources supported by the task.

You can use a fast path method to perform a task by using the **diag** command and the **-T** flag. The fast-path tasks are as follows:

- Certify – certifies media
- Chkspares – checks for the availability of spare sectors
- Download – downloads microcode to an adapter or device
- Disp\_mcode – displays current level of microcode
- Format – formats media
- Identify – identifies the PCI RAID physical disks

To run these tasks directly from the command line, specify the resource and other task-unique flags. Use the descriptions in this chapter to understand which flags are needed for a given task.

---

### Tasks

The following tasks are described in this chapter:

- Add Resource to Resource List
- AIX Shell Prompt
- Analyze Adapter Internal Log
- Backup and Restore Media
- Certify Media
- Change Hardware Vital Product Data
- Configure Dials and LPFKeys
- Configure ISA Adapters
- Configure Reboot Policy
- Configure Remote Maintenance Policy
- Configure Ring Indicate Power On
- Configure Ring Indicate Power On Policy

- Configure Service Processor
- Configure Surveillance Policy
- Create Customized Configuration Diskette
- Delete Resource from Resource List
- Disk Maintenance
- Display Configuration and Resource List
- Display Firmware Device Node Information
- Display Hardware Error Report
- Display Hardware Vital Product Data
- Display Machine Check Error Log
- Display Microcode Level
- Display or Change Bootlist
- Display or Change Diagnostic Run Time Options
- Display Previous Diagnostic Results
- Display Resource Attributes
- Display Service Hints
- Display Software Product Data
- Display System Environmental Sensors
- Display Test Patterns
- Download Microcode
- Fibre Channel RAID Service Aids
- Flash SK-NET FDDI Firmware
- Format Media
- Generic Microcode Download
- Local Area Network Analyzer
- Log Repair Action
- Periodic Diagnostics
- PCI RAID Physical Disk Identify
- Process Supplemental Media
- Run Diagnostics
- Run Error Log Analysis
- Run Exercisers
- Save or Restore Hardware Management Policies
- Save or Restore Service Processor Configuration
- SCSI Bus Analyzer
- SCSI Device Identification and Removal
- SCSD Tape Drive Service Aid
- Spare Sector Availability
- SSA Service Aid
- Update Disk Based Diagnostics
- Update System or Service Processor Flash
- Update System Flash
- 7135 RAIDiant Array Service Aids
- 7318 Serial Communication Network Server

---

## Add Resource to Resource List

Use this task to add resources back to the resource list.

**Note:** Only resources that were previously detected by the diagnostics and deleted from the Diagnostic Test List are listed. If no resources are available to be added, then none are listed.

---

## AIX Shell Prompt

**Note:** Use this Service Aid in Online Service Mode only.

This service aid allows access to the AIX command line. To use this service aid, the user must know the root password (when a root password has been established).

**Note:** Do not use this task to install code or to change the configuration of the system. This task is intended to view files, configuration records, and data. Using this service aid to change the system configuration or install code might result in unexplained system problems after exiting the diagnostics.

---

## Analyze Adapter Internal Log

The PCI RAID adapter has an internal log that logs information about the adapter and the disk drives attached to the adapter. Whenever data is logged in the internal log, the device driver copies the entries to the AIX system error log and clears the internal log.

The Analyze Adapter Internal Log service aid analyzes these entries in the AIX system error log. The service aid displays the errors and the associated service actions. Entries that do not require any service actions are ignored.

---

## Backup and Restore Media

This service aid allows verification of backup media and devices. It presents a menu of tape and diskette devices available for testing and prompts for selecting the desired device. It then presents a menu of available backup formats and prompts for the desired format. The supported formats are **tar**, **backup**, and **cpio**. After the device and format are selected, the service aid backs up a known file to the selected device, restores that file to **/tmp**, and compares the original file to the restored file. The restored file remains in **/tmp** to allow for visual comparison. All errors are reported.

---

## Certify Media

This task allows the selection of diskette or hardfiles to be certified.

Hardfiles can be connected either to a SCSI adapter (non-RAID) or a PCI SCSI RAID adapter. The usage and criteria for a hardfile connected to a non-RAID SCSI adapter are different from those for a hardfile connected to a PCI SCSI RAID adapter.

- Certify Diskette

This selection enables you to verify the data written on a diskette. You can select the type of diskette being verified. The program then reads all of the ID and data fields on the diskette one time and displays the total number of bad sectors found.

- Certify Hardfile Attached to a Non-RAID SCSI Adapter

This selection reads all of the ID and data fields. It checks for bad data and counts all errors encountered. If the unrecovered data errors exceed the threshold value, the hardfile needs to be formatted and certified. If the recovered data errors, recovered (and unrecovered) equipment errors exceed the threshold values, the disk needs to be replaced.

This task can be run directly from the AIX command line. The syntax of the command is as follows:

```
diag -c -d deviceName -T "certify"
```

- Certify Hardfile attached to a PCI SCSI RAID Adapter

This selection is used to certify physical disks attached to a PCI SCSI RAID adapter. Certify reads the entire disk and checks for recovered errors, unrecovered errors, and reassigned errors. If these errors exceed the threshold values, the user is prompted to replace the physical disk.

This task can be run directly from the AIX command line. The syntax of the command is as follows:

```
diag -c -d < RAID adapterName -T "certify {-l chID | -A}"
```

Flag	Description
-l	Physical Disk channel/ID (for example: 27)
-A	All disks

---

## Change Hardware Vital Product Data

Use this service aid to display the Display/Alter VPD Selection Menu. The menu lists all resources installed on the system. When a resource is selected, a menu displays that lists all the VPD for that resource.

**Note:** The user cannot alter the VPD for a specific resource unless it is not machine readable.

---

## Configure Dials and LPFKeys

This service aid provides a tool for configuring and removing dials/LPFKeys (Lighted Program Function Keys) to the asynchronous serial ports.

A TTY must be defined on the async port before the Dials and LPFKs can be configured on the port. Prior to AIX Version 4.2, the Dials and LPFKs could only be configured on the standard serial ports. For AIX Version 4.2 and later, the Dials and LPFKs can be configured on any async port.

This selection invokes the SMIT utility to allow Dials and LPFKs configuration. A TTY must be in the available state on the async port before the Dials and LPFKs can be configured on the port. The task allows an async adapter to be configured, then a TTY port defined on the adapter, and then Dials and LPFKs can be defined on the port.

---

## Configure ISA Adapter

This task uses SMIT to allow the identification and configuration of ISA adapters on systems that have an ISA bus and adapters.

Diagnostic support for ISA adapters not shown in the list may be supported from a supplemental diskette. You can use the Process Supplemental Media task to add ISA adapter support from a supplemental diskette.

Whenever an ISA adapter is installed, this service aid must be run and the adapter configured before the adapter can be tested. You must also run this service aid to remove an ISA adapter from the system whenever an ISA adapter is physically removed from the system.

If diagnostics are run on an ISA adapter that has been removed from the system, the diagnostics fail because the system cannot detect the ISA adapter.

---

## Configure Reboot Policy

This service aid controls how the system tries to recover from a system crash. Use this service aid to display and change the following settings for the Reboot Policy.

**Note:** Some of the following settings may not be displayed by this service aid.

- Maximum Number of Reboot Attempts  
Enter a number that is 0 or greater.

**Note:** A value of 0 indicates 'do not attempt to reboot' to a crashed system.

This number is the maximum number of consecutive attempts to reboot the system. The term *reboot*, in the context of this service aid, is used to describe bringing system hardware back up from scratch, for example from a system reset or power on.

When the reboot process completes successfully, the reboot attempts count is reset to 0, and a *restart* begins. The term *restart*, in the context of this service aid, is used to describe the operating system activation process. Restart always follows a successful reboot.

When a restart fails, and a restart policy is enabled, the system attempts to reboot for the maximum number of attempts.

- Use the O/S Defined Restart Policy (1=Yes, 0=No)

When 'Use the O/S Defined Restart Policy' is set to Yes, the system attempts to reboot from a crash if the operating system has an enabled Defined Restart or Reboot Policy.

When 'Use the O/S Defined Restart Policy' is set to No, or the operating system restart policy is undefined, then the restart policy is determined by the 'Supplemental Restart Policy'.

- Enable Supplemental Restart Policy (1=Yes, 0=No)

The 'Supplemental Restart Policy', if enabled, is used when the O/S Defined Restart Policy is undefined, or is set to False.

When surveillance detects operating system inactivity during restart, an enabled 'Supplemental Restart Policy' causes a system reset and the reboot process begins.

- Call-Out Before Restart(on/off)

When enabled, Call-Out Before Restart allows the system to call out (on a serial port that is enabled for call out) when an operating system restart is initiated. Such calls can be valuable if the number of these events becomes excessive, thus signalling bigger problems.

- Enable Unattended Start Mode (1=Yes, 0=No)

When enabled, 'Unattended Start Mode' allows the system to recover from the loss of ac power.

If the system was powered on when the ac loss occurred, the system reboots when power is restored. If the system was powered off when the ac loss occurred, the system remains off when power is restored.

You can access this service aid directly from the AIX command line by typing:

```
/usr/lpp/diagnostics/bin/uspchrp -b
```

---

## Configure Remote Maintenance Policy

The Remote Maintenance Policy includes modem configurations and phone numbers to use for remote maintenance support. Use this service aid to display and change the following settings for the Remote Maintenance Policy.

**Note:** Some of the following settings may not be displayed by this service aid.

- Configuration File for Modem on S1 Configuration File for Modem on S2

Enter the name of a modem configuration file to load on either serial port 1 (S1) or serial port 2 (S2). The modem configuration files are located in the directory **/usr/share/modems**. If a modem file is already loaded, a Modem file currently loaded message displays.

- Modem file currently loaded on S1 Modem file currently loaded on S2

This is the name of the file that is currently loaded on serial port 1 or serial port 2.

**Note:** These settings are only shown when a modem file is loaded for a serial port.

- Call In Authorized on S1 (on/off) Call In Authorized on S2 (on/off)

Call In allows the Service Processor to receive a call from a remote terminal.

- Call Out Authorized on S1 (on/off) Call Out Authorized on S2 (on/off)

Call Out allows the Service Processor to place calls for maintenance.

- S1 Line Speed S2 Line Speed

A list of line speeds is available by using 'List' on the screen.

- Service Center Phone Number

Telephone number of the service center computer. The service center usually includes a computer that takes calls from systems with call-out capability. This

computer is referred to as the *catcher*. The catcher expects messages in a specific format to which the Service Processor conforms. For more information about the format and catcher computers, refer to the README file in the AIX **/usr/samples/syscatch** directory. Contact the service provider for the correct telephone number to enter here.

- **Customer Administration Center Phone Number**  
Telephone number of the System Administration Center computer (catcher) that receives problem calls from systems. Contact the system administrator for the correct telephone number to enter here.
- **Digital Pager Phone Number In Event of Emergency**  
Number for a pager carried by someone who responds to problem calls from your system.
- **Customer Voice Phone Number**  
Telephone number for a telephone near the system, or answered by someone responsible for the system. This is the telephone number left on the pager for callback.
- **Customer System Phone Number**  
Telephone number to which your system's modem is connected. The service or administration center representatives need this number to make direct contact with your system for problem investigation. This is also referred to as the *Call-in phone number*.
- **Customer Account Number**  
This number is available for service providers to use for record keeping and billing.
- **Call Out Policy-Numbers to call if failure**  
This is set to either first or all. If the call-out policy is set to first, call out stops at the first successful call to one of the following numbers in the order listed:
  1. Service Center
  2. Customer Administration Center
  3. Pager

If Call Out Policy is set to all, call-out attempts to call all of the following numbers in the order listed:

  1. Service Center
  2. Customer Administration Center
  3. Pager
- **Customer RETAIN Login ID Customer RETAIN Login Password**  
These settings apply to the RETAIN service function.
- **Remote Timeout, in seconds Remote Latency, in seconds**  
These settings are functions of the service provider's catcher computer.
- **Number of Retries While Busy**  
This is the number of times the system should retry calls that resulted in busy signals.
- **System Name (System Administrator Aid)**  
Name given to the system and is used when reporting problem messages.

**Note:** If you provide the system name, your support team can quickly identify the location, configuration, and history of your system.

You can access this service aid directly from the AIX command line by typing:  
`/usr/lpp/diagnostics/bin/uspchrp -m`

---

## Configure Ring Indicate Power On Policy

**Note:** This service aid runs on CHRP system units only.

This service aid allows the user to power-on a system by telephone from a remote location. If the system is powered off, and Ring Indicate Power On is enabled, the system powers on at a predetermined number of rings. If the system is already on, no action is taken. In either case, the telephone call is not answered, and the caller receives no feedback that the system has powered on.

Use this service aid to display and change the following settings for the Ring Indicate Power On Policy.

**Note:** Some of the following settings may not be displayed by this service aid.

- Power On Via Ring Indicate (on/off)
- Number of Rings until Power On

You can access this service aid directly from the AIX command line by typing:  
`/usr/lpp/diagnostics/bin/uspchrp -r`

---

## Configure Ring Indicate Power On

**Note:** This service aid runs on RSPC system units only.

This service aid allows the user to display and change the NVRAM settings for the Ring Indicate Power On capability of the service processor.

The settings allows the user to:

- Enable or Disable power on from Ring Indicate
- Read or Set the number of rings before power on

---

## Configure Service Processor

**Note:** This service aid runs on RSPC system units only.

This service aid allows you to display and change the NVRAM settings for the service processor.

This service aid supports the following functions:



- Surveillance Setup
- Modem Configuration
- Call In/Call Out Setup
- Site-Specific Call In/Call Out Setup
- Reboot/Restart Policy Setup

## Surveillance Setup

This selection allows you to display and change the NVRAM settings for the surveillance capability of the service processor.

The settings allow you to:

- Enable or disable surveillance
- Set the surveillance time interval, in minutes
- Set the surveillance delay, in minutes

The current settings are read from NVRAM (Nonvolatile Random Access Memory) and displayed on the screen. Any changes made to the data shown are written to NVRAM.

## Modem Configuration

Use this selection when setting the NVRAM for a modem attached to any of the Service Processor's serial ports. The user inputs the file name of the modem configuration file and the serial port number the formatted modem configuration file is read, converted for NVRAM, and then loaded into NVRAM. Refer to the Service Processor Installation and User's Guide for more information.

## Call In/Out Setup

This selection allows the user to display and change the NVRAM settings for the Call In/Call Out capability of the service processor.

The settings allows the user to:

- Enable or Disable call in on either serial port
- Enable or Disable call out on either serial port
- Set the line speed on either serial port

## Site-Specific Call In/Out Setup

This selection allows you to display and change the NVRAM settings that are site-specific for the call in/call out capability of the service processor.

The site-specific NVRAM settings allow you to set the following:

- Phone number for the service center
- Phone number for the customer administration center
- Phone number for a digital pager
- Phone number for the customer system to call in
- Phone number for the customer voice phone
- Customer account number
- Call out policy
- Customer RETAIN id
- Customer RETAIN password

- Remote timeout value
- Remote latency value
- Number of retries while busy
- System name

The current settings are read from VRAM (Video Random Access Memory) and displayed on the screen. Any changes made to the data shown are written to NVRAM.

## Reboot/Restart Policy Setup

This selection controls how the system tries to recover from a system crash.

Use this service aid to display and change the following settings for the following:

- Boot Policy Setup.
- Minimum Number of Reboot Attempts
- Enter a number that is 0 or greater.

**Note:** A value of 0 indicates "do not attempt to reboot" to a crashed system.

This number is the maximum number of consecutive attempts allowed to reboot the system. The term *reboot*, when used in context of this service aid, describes the system hardware being brought back up. Examples would be a system reset or turning on the power on.

When the maximum number of reboot attempts is exceeded, the system calls out if that function has been enabled.

When the reboot process completes successfully, the reboot-attempts count is reset to 0, and a restart begins. The term *restart*, when used in context of this service aid, describes the operating system activation process. Restart always follows a successful reboot.

When a restart fails, and a restart policy is enabled, the system attempts to reboot for the maximum number of reboot attempts.

- Enable Restart Policy (1=Yes, 0=No)

When the service processor detects operating system inactivity, an enabled "Restart Policy" causes a system reset, and the reboot process begins.

- Call-Out Before Restart (on/off)

When enabled, "Call-Out Before Restart" allows the system to call out (on a serial port that is enabled for call out) when an operating system restart is initiated. Such call-outs can be valuable if the number becomes excessive, which signals bigger problems

- Enable Unattended Start Mode (1=Yes, 0=No)

When enabled, "Unattended Start Mode" allows the system to recover from the loss of ac power.

If the system was powered on when the ac loss occurred, the system reboots when power is restored. If the system was powered off when the ac loss occurred, the system remains off when power is restored.

---

## Configure Surveillance Policy

This service aid monitors the system for hang conditions; that is, hardware or software failures that cause operating system inactivity. When enabled, and surveillance detects operating system inactivity, a call is placed to report the failure.

Use this service aid to display and change the following settings for the Surveillance Policy.

**Note:** Some of the following settings may not be displayed by this service aid.

- Surveillance
  - Surveillance Time Interval, in minutes  
Maximum time between heartbeats from the operating system.
  - Surveillance Delay, in minutes  
Time to delay between when the operating system is in control and when to begin operating system surveillance.
  - Changes are to take effect immediately  
Set this to yes if the changes made to the settings in this menu are to take place immediately. Otherwise, the changes take effect beginning with the next system boot.

You can access this service aid directly from the AIX command line by entering:  
`/usr/lpp/diagnostics/bin/uspchrp -s`

---

## Create Customized Configuration Diskette

This selection invokes the Diagnostic Package Utility Service Aid, which allows the user to create a stand-alone diagnostic package configuration diskette.

The Stand-Alone Diagnostic Package Configuration Diskette allows the following to be changed from the console:

- Default refresh rate for a LFT (Limited Function Terminal)  
The refresh rate used by the stand-alone diagnostic package is 60Hz. If the display's refresh rate is 77Hz, set the refresh rate to 77.
- Different async terminal console  
Use this service aid to create a console configuration file that allows a terminal attached to any RS232 or RS422 adapter to be selected as a console device. The default device is RS232 TTY attached to the first standard serial port (S1).

---

## Delete Resource from Resource List

Use this task to delete resources from the resource list.

**Note:** Only resources that were previously detected by the diagnostics and have not been deleted from the Diagnostic Test List are listed. If no resources are available to be deleted, then none are listed.

---

## Disk Maintenance

- Disk to Disk Copy
- Display/Alter Sector

### Disk to Disk Copy

**Notes:**

1. This service aid cannot be used to update to a different size drive. The service aid only supports copying from a SCSI drive to another SCSI drive of similar size.
2. Use the **migratepv** command when copying the contents to other disk drive types. This command also works when copying SCSI disk drives or when copying to a different size SCSI disk drive. Refer to *System Management Guide: Operating System and Devices* for a procedure on migrating the contents of a physical volume.

This selection allows you to recover data from an old drive when replacing it with a new drive. The service aid recovers all LVM (Logical Volume Manager) software reassigned blocks. To prevent corrupted data from being copied to the new drive, the service aid aborts if an unrecoverable read error is detected. To help prevent possible problems with the new drive, the service aid aborts if the number of bad blocks being reassigned reaches a threshold.

This service aid requires that both the old and new disks be installed in or attached to the system with unique SCSI addresses. This requires that the new disk drive SCSI address must be set to an address that is not currently in use and the drive be installed in an empty location. If there are no empty locations, then one of the other drives must be removed. Once the copy is complete, only one drive may remain installed. Either remove the target drive to return to the original configuration, or use the following steps to complete the replacement of the old drive with the new drive.

1. Remove both drives.
2. Set the SCSI address of the new drive to the SCSI address of the old drive.
3. Install the new drive in the old drive's location.
4. Install any other drives that were removed into their original location.

To prevent problems that can occur when running this service aid from disk, it is suggested that when possible this service aid be run from the diagnostics that are loaded from removable media.

---

## Display/Alter Sector

This selection allows the user to display and alter information on a disk sector. Use this service aid carefully, because inappropriate modification to some disk sectors may result in total loss of all data on the disk. Sectors are addressed by their decimal sector number. Data is displayed both in hex and in ASCII. To prevent corrupted data from being incorrectly corrected, the service aid does not display information that cannot be read correctly.

---

## Display Configuration and Resource List

This service aid displays only the item header for all installed resources. Use this service aid when there is no need to see the VPD (vital product data).

---

## Display Firmware Device Node Information

This task displays the firmware device node information that appears on CHRP platforms. The format of the output data may not be the same among different levels of AIX. It is intended to gather more information about individual or particular devices on the system.

---

## Display Hardware Error Report

This service aid uses the **errpt** command to provide a tool for viewing the hardware error log.

The Display Error Summary and Display Error Detail selections provide the same type of report as the **errpt** command.

---

## Display Hardware Vital Product Data

This service aid displays all installed resources, along with any VPD (Vital Product Data) for those resources. Use this service aid when you want to look at the VPD for a specific resource.

---

## Display Machine Check Error Log

**Note:** The Machine Check Error Log Service Aid is available only on Stand-Alone Diagnostics.

When a machine check occurs, information is collected and logged in an NVRAM error log before the system unit shuts down. This information is logged in the AIX error log and cleared from NVRAM when the system is rebooted from the hard disk, LAN, or stand-alone media. When booting from Stand-Alone Diagnostics, this service aid can convert the logged information into a readable format that can help to isolate the problem. When booting from the hard disk or LAN, the information can be viewed from

the AIX error log, using the Hardware Error Report Service Aid. In either case, the information is analyzed when running the **sysplanar0** diagnostics in Problem Determination Mode.

---

## Display Microcode Level

Use this task to display the current level of microcode on an adapter or device. The syntax of the command is as follows: `diag -c -d device_name -T "disp_mcode"`

---

## Display or Change Bootlist

This service aid allows the bootlist to be displayed, altered, or erased.

The system attempts to perform an IPL from the first device in the list. If the device is not a valid IPL device or if the IPL fails, the system proceeds in turn to the other listed devices to attempt an IPL.

---

## Display or Change Diagnostic Run-Time Options

The Display or Change Diagnostic Run-Time Options task allows the diagnostic run-time options to be set.

**Note:** The run-time options are used only when selecting the Run Diagnostic task.

The run-time options are:

- Display Diagnostic Mode Selection Menus

This option allows the user to enable displaying THE DIAGNOSTIC MODE SELECTION MNU (the default is off).

- Run Tests Multiple Times

This option allows the user to enable running the diagnostic in loop mode (the default is off).

**Note:** This option is only displayed when you run Online Diagnostics in Service Mode.

- Include Advanced Diagnostics

This option allows the user to enable including the Advanced Diagnostics (the default is off).

- Include Error Log Analysis

This option allows the user to enable including the Error Log Analysis (ELA) (the default is off).

- Number of Days Used to Search Error Log

This option allows the user to select the number of days to search the AIX error log for errors when running the Error Log Analysis. The default is 7 days, but it can be changed from 1 to 60 days.

- Display Progress Indicators

This option allows the user to enable the progress indicators when running the Diagnostic Applications. The progress indicators display at the bottom of the screen, which indicate that the test being run (the default is on).

- Diagnostic Event Logging

This option allows the user to enable logging information to the Diagnostic Event Log (the default is on).

- Diagnostic Event Log File Size

This option allows the user to select the maximum size of the Diagnostic Event Log. The default size for the Diagnostic Event Log is 100 KB. The size can be increased in 100 KB increments to a maximum of 1 MB.

---

## Display Previous Diagnostic Results

**Note:** This service aid is not available when you load the diagnostics from a source other than a hard disk drive or a network.

This service aid allows a service representative to display result from a previous diagnostic session. When the Display Previous Diagnostic Results option is selected, the user can view up to 25 no trouble found (NTF) and service request number (SRN) results.

This service aid displays Diagnostic Event Log information, which can be displayed in either short or long version. The information is displayed in reverse chronological order.

This information is not from the AIX operating system error log. This information is stored in the **/var/adm/ras** directory.

You can run the command from the AIX command line by typing:

```
/usr/lpp/diagnostics/bin/diagrpt [[-o] | [-smddy mddy] | [-a] | [-r]]
```

Flag	Description
<b>-o</b>	Displays the last diagnostic results file stored in the <b>/etc/lpp/diagnostics/data</b> directory
<b>-s</b> <i>mddy</i>	Displays all diagnostic result files logged since the date specified
<b>-a</b>	Displays the long version of the Diagnostic Event Log
<b>-r</b>	Displays the short version of the Diagnostic Event Log

---

## Display Resource Attributes

This task displays the Customized Device Attributes associated with a selected resource. This task is similar to running the **lsattr -E -I resource** command.

---

## Display Service Hints

This service aid reads and displays the information in the CERADME file from the diagnostics media. This file contains information that is not in the publications for this version of the diagnostics. The file also contains information about using this particular version of diagnostics.

---

## Display Software Product Data

This task uses SMIT to display information about the installed software and provides the following functions:

- List Installed Software
- List Applied but Not Committed Software Updates
- Show Software Installation History
- Show Fix (APAR) Installation Status
- List Fileset Requisites
- List Fileset Dependents
- List Files Included in a Fileset
- List Fileset containing file

---

## Display System Environmental Sensors

This service aid displays the environmental sensors implemented on a CHRP system. The information displayed is the sensor name, physical location code, literal value of the sensor status, and the literal value of the sensor reading.

The sensor status can be any one of the following:

- **Normal** – The sensor reading is within the normal operating range.
- **Critical High** – The sensor reading indicates a serious problem with the device. Run diagnostics on sysplanar0 to determine what repair action is needed.
- **Critical Low** – The sensor reading indicates a serious problem with the device. Run diagnostics on sysplanar0 to determine what repair action is needed.
- **Hardware Busy** – The system has repeatedly returned a busy indication, and a reading is not available. Try the service aid again. If the problem continues, run diagnostics on sysplanar0 in problem determination mode to determine what repair action is needed.
- **Hardware Error** - The sensor could not be read because of a hardware error. Run diagnostics on sysplanar0 in problem determination mode to determine what repair action is needed.
- **Warning High** – The sensor reading indicates a problem with the device. This could become a critical problem if action is not taken. Run diagnostics on sysplanar0 to determine what repair action is needed.
- **Warning Low** – The sensor reading indicates a problem with the device. This could become a critical problem if action is not taken. Run diagnostics on sysplanar0 to determine what repair action is needed.



This service aid can also be run as a command. Use the command to list the sensors and their values in a text format, list the sensors and their values in numerical format, or a specific sensor can be queried to return either the sensor status or sensor value.

Run the command by entering one of the following:

**Note:** These commands work only when the flags are entered one at a time (such as those shown in Examples 1 and 2)

```
/usr/lpp/diagnostics/bin/uesensor -l | -a /usr/lpp/diagnostics/bin/uesensor -t  
token -i index [-v]
```

Flag	Description
------	-------------

-l	List the sensors and their values in a text format.
----	---

-a	List the sensors and their values in a numerical format. For each sensor, the following numerical values are displayed as:
----	--

```
token index status measuredvalue  
location code
```

-t token	Specifies the sensor token to query.
----------	--------------------------------------

-i index	Specifies the sensor index to query.
----------	--------------------------------------

-v	Indicates to return the sensor measured value. The sensor status is returned by default.
----	--

## Examples

1. Display a list of the environmental sensors:

```
/usr/lpp/diagnostics/bin/uesensor -l
```

This is the result of running the example command only.

Sensor = Fan Speed Status = Normal Value = 2436 RPM Location Code = F1

Sensor = Power Supply Status = Normal Value = Present and operational Location Code = V1

Sensor = Power Supply Status = Critical low Value = Present and not operational Location Code = V2

2. Display a list of the environmental sensors in a numerical list:

```
/usr/lpp/diagnostics/bin/uesensor -a
```

This is the result of running the example command only.

```
3 0 11 87 P1 9001 0 11 2345 F1 9004 0 11 2 V1 9004 1 9 2 V2
```

3. Return the status of sensor 9004, index 1:

```
/usr/lpp/diagnostics/bin/uesensor -t 9004 -i 1
```

This is the result of running the example command only.

4. Return the value of sensor 9004, index 1:

```
/usr/lpp/diagnostics/bin/uesensor -t 9004 -i 1 -v
```

This is the result of running the example command only.

---

## Display Test Patterns

This service aid provides a means of adjusting system display units by providing displayable test patterns. You can select the display type and test pattern. After you make the selections, the test pattern displays.

---

## Download Microcode

This service aid provides a way to copy microcode to an adapter or device. The service aid presents a list of adapters and devices that use microcode. After the adapter or device is selected, you can check the current level and download the needed microcode.

This task can be run directly from the AIX command line. The following sections guide you for a particular type of adapter or device.

### Download Microcode to PCI SCSI RAID Adapter

The syntax of the command for a PCI SCSI RAID Adapter is as follows: `diag -c -d RAID_adapterName -T "download [-B] [-D] [-P]"`

Flag	Description
<b>-B</b>	Download boot block microcode (default to functional microcode).
<b>-D</b>	Microcode is on diskette (default to <b>/etc/microcode</b> directory).
<b>-P</b>	Download the previous level of microcode (default to latest level).

### Download Microcode to Disk Drive Attached to a PCI SCSI RAID Adapter

The syntax of the command for a disk drive attached to a PCI RAID Adapter is as follows: `diag -c -d RAID_adapterName -T "download {-l chID | -A} [-D] [-P]"`

Flag	Description
<b>-A</b>	All disk drives.
<b>-D</b>	Microcode is on diskette (default to <b>/etc/microcode</b> directory).
<b>-l</b>	RAID disk drive-physical disk channel/ID (for example 27).
<b>-P</b>	Download the previous level of microcode (default to latest level).

### Download Microcode to a PCI FC-AL Adapter

The syntax of the command for a PCI FC-AL Adapter is as follows: `diag -c -d device_name -T "download [-s {diskette|disk}] -f [-l {latest|previous}]"`

Flag	Description
<b>-d</b>	Device name is the name of the adapter.
<b>-f</b>	Force the download even if the current level of microcode is not on the media.
<b>-l</b>	Level of microcode to download. The default is latest.
<b>-s</b>	Microcode source of the new microcode. The default value is disk.

The microcode image file must be in **/etc/microcode**.

## Download Microcode to Other Devices

The syntax of the command is as follows: `diag -c -d device_name -T "download [-s diskette ] [-l previous] [-F]"`

Flag	Description
-F	Force flag. Required to download microcode if the current level is unavailable on the source.
-l	Microcode level. Latest is default.
-s	Microcode source. <b>/etc/microcode</b> is default. Default source device is disk.

---

## Fiber Channel RAID Service Aids

The Fibre Channel RAID (Redundant Array Independent Disk) service aids contain the following functions:

### Certify LUN

This selection reads and checks each block of data in the LUN (Logical Unit Number). If excessive errors are encountered the user is notified.

You can run this task from the AIX command line. The syntax of the fastpath command is as follows: `diag -T "certify"`

### Certify Spare Physical Disk

This selection allows the user to certify (check integrity of the data) on drives that are designated as spares.

You can run this task from the AIX command line. The syntax of the fastpath command is as follows: `diag -T "certify"`

### Format Physical Disk

This selection formats a selected disk drive.

You can run this task from the AIX command line. The syntax of the fastpath command is as follows: `diag -T "format"`

### Array Controller Microcode Download

This selection allows the microcode on the Fibre Channel RAID controller to be updated when required.

You can run this task from the AIX command line. The syntax of the fastpath command is as follows: `diag -T "download"`

### Physical Disk Microcode Download

This selection is used to update the microcode on any of the disk drives in the array.

You can run this task from the AIX command line. The syntax of the fastpath command is as follows: `diag -T "download"`

### Update EEPROM

This selection is used to update the contents of the EEPROM (Electrically Erasable Programmable Read Only Memory) on a selected controller.

### Replace Controller

Use this selection when it is necessary to replace a controller in the array.

---

## Flash SK-NET FDDI Firmware

This task allows the Flash firmware on the SysKconnect SK-NET FDDI adapter to be updated.

---

## Format Media

This task allows the selection of diskettes, hardfiles, or optical media to be formatted. Each selection is described below.

### Hardfile Attached to SCSI Adapter (non-RAID)

- Hardfile Format

Writes all of the disk. The pattern written on the disk is device-dependent; that is, some drives might write all 0s, while some might write hexadecimal number 5F.

  - Resource Selection List (choice of floppy drive or hard drive)
  - If floppy (fd0):
    - Diskette Media Service Aid
    - Choose type of diskette to format
    - Formatting occurs
  - If Hard drive (hdisk0)
    - Format Media Task
    - Format and Certify Disk
    - Format without Certify
    - Erase Disk
- Hardfile Format and Certify

Performs the same function as hard file Format. After the format is completed, certify runs. This certify reassigns all bad blocks that are encountered.
- Hardfile Erase Disk

This option can be used to overwrite (remove) all data currently stored in user-accessible blocks of the disk. The Erase Disk option writes one or more patterns to the disk. An additional option allows data in a selectable block to be read and displayed on the system console.

To use the Erase Disk option, specify the number (0-3) of patterns to be written. Select the patterns to be written; the patterns are written serially. That is, the first pattern is written to all blocks. Then the next pattern is written to all blocks, overlaying the previous pattern. A random pattern is written by selecting the **Write random pattern?** option.

**Note:** The Erase Disk service aid has not been certified as meeting the Department of Defense or any other organizations' security guidelines.

If the data on the drive is to be overwritten, use the following steps:

1. Use the Erase Disk selection to overwrite the data on the drive.
2. Run a format without certify.
3. Run a second pass of the Erase Disk selection.

For a newly installed drive, you can ensure that all blocks on the drive are overwritten with your pattern when you use the following procedure:

1. Format the drive.
2. Check the defect MAP (Maintenance Analysis Procedure) by running the Erase Disk selection.

**Note:** If you use the Format and Certify option, there may be some blocks which get placed into the grown defect MAP.

3. If there are bad blocks in the defect MAP, record the information presented and ensure that this information is kept with the drive. This data is used when the drive is to be overwritten.
4. Use the drive as you would normally.
5. When the drive is no longer needed and is to be erased, run the same version of the Erase Disk selection that was used in step 2.

**Note:** Using the same version of the service aid is only critical if there were any bad blocks found in step 3.

6. Compare the bad blocks which were recorded with the drive in step 3 with those that now appear in the grown defect MAP.

**Note:** If there are differences between the saved data and the newly obtained data, then all sectors on this drive cannot be overwritten. The new bad blocks are not overwritten.

7. If the bad block list is the same, continue running the service aid to overwrite the disk with the chosen pattern(s).

This task can be run directly from the AIX command line. The syntax of the command is as follows: `diag -c -d deviceName -T "format [-s* fmtcert | erase -a {read | write}] [-F]"`

Flag	Description
<b>fmtcert</b>	Formats and certifies the disk.
*	Available in no-console mode only.
<b>-F</b>	Force flag. Forces disk erasure even if all blocks cannot be erased due to errors accessing grown defect map.

**Note:** Erase option in command line mode uses default values. To selectively read or write, use the **diag** command in console mode.

## Hardfile Attached to PCI SCSI RAID Adapter

This function formats the physical disks attached to a PCI SCSI RAID adapter. This task can be run directly from the AIX command line. The syntax of the command is as follows: `diag -c -d RAID adapterName -T "format {-l chId | -A }"`

Flag	Description
<b>-l</b>	Physical disk channel/ID (An example of physical disk channel/ID is 27, where the channel is 2 and the ID is 7.)
<b>-A</b>	All disks

## Optical Media

This function formats the media without certifying.

- Optical Media Initialize

Formats the media without certifying. This function does not reassign the defective blocks or erase the data on the media. It provides a quick way of formatting the media and cleaning the disk.

**Note:** It takes approximately one minute to format the media.

- Optical Media Format and Certify

Formats and certifies the media. This function reassigns the defective blocks and erases all data on the media.

This task can be run directly from the AIX command line. The following usage statement describes the syntax of the command: `diag -c -d deviceName -T "format [-s {initialize | fmtcert} ]"`

Option	Description
--------	-------------

<b>initialize</b>	Formats media without certifying
<b>fmtcert</b>	Formats and certifies the media

## Diskette Format

This selection formats a diskette by writing patterns to it.

---

## Generic Microcode Download

This service aid provides a means of executing a generic script from a diskette. The intended purpose for this generic script is to load microcode to a supported resource. This script can run whatever program is required to download the microcode onto the adapter or device.

This service aid is supported in both concurrent and stand-alone modes from disk, LAN, or loadable media.

On entry, the service aid displays information about what it does. It then asks for a Genucode diskette to be inserted into the diskette drive. The diskette must be in tar format. The service aid restores the script file **genucode** to the **/tmp** directory. Then the script is executed. The script must at that point then pull any other needed files from the diskette. The script should then execute whatever program is necessary in order to perform its function. On completion, a status code is returned, and the user is returned to the service aid. .

The **genucode** script should have a `#!/usr/bin/ksh` line at the beginning of the file. Return status of 0 should be returned if the program was successful, else a non-zero status should be returned

---

## Local Area Network Analyzer

This selection is used to exercise the LAN communications adapters (Token-Ring, Ethernet, and (FDDI) Fiber Distributed Data Interface). The following services are available:

- Connectivity testing between these two network stations. Data is transferred between the two stations, requiring the user to input the Web addresses of both stations.
- Monitoring ring (Token-Ring only). The ring is monitored for a specified period of time. Soft and hard errors are analyzed.

---

## Log Repair Action

The Log Repair Action task logs a repair action in the AIX Error Log. A Repair Action Log indicates that a FRU has been replaced, and error log analysis should not be done for any errors logged before the repair action. The Log Repair Action task lists all resources. Replaced resources can be selected from the list, and when **commit** (F7 Key) is selected, a repair action is logged for each selected resource.

---

## Periodic Diagnostics

This selection provides a tool for configuring periodic diagnostics and automatic error log analysis. You can select a hardware resource to be tested once a day, at a user-specified time. If the resource cannot be tested because it is busy, error log analysis is performed. Hardware errors logged against a resource can also be monitored by enabling Automatic Error Log Analysis. This allows error log analysis to be performed every time a hardware error is put into the error log. If a problem is detected, a message is posted to the system console and a mail message sent to the users belonging to the system group with information about the failure such as service request number.

The service aid provides the following functions:

- Add or delete a resource to the periodic test list
- Modify the time to test a resource
- Display the periodic test list
- Modify the error notification mailing list
- Disable or enable Automatic Error Log Analysis

---

## PCI RAID Physical Disk Identify

This selection identifies physical disks connected to a PCI SCSI-2 F/W RAID adapter.

This task can be run directly from the AIX command line. The syntax of the command is as follows:

```
diag -c -d pci RAID adapter -T identify
```

---

## Process Supplemental Media

Diagnostic Supplemental Media contains all the necessary diagnostic programs and files required to test a particular resource. The supplemental media is normally released and shipped with the resource as indicated on the diskette label. Diagnostic Supplemental Media must be used when the device support has not been incorporated into the latest diagnostic CD-ROM.

This task processes the Diagnostic Supplemental Media. Insert the supplemental media when you are prompted, then press Enter. After processing has completed, go to the Resource Selection list to find the resource to test.

---

## Run Diagnostics

The Run Diagnostics task invokes the Resource Selection List menu. When the commit key is pressed, diagnostics are run on all selected resources.

The procedures for running the diagnostics depend on the state of the diagnostics run-time options. See "Display or Change Diagnostic Run-Time Options" on page 126.

---

## Run Error Log Analysis

The Run Error Log Analysis task invokes the Resource Selection List menu. When the commit key is pressed, Error Log Analysis is run on all selected resources.

---

## Run Exercisers

This task provides a tool to troubleshoot intermittent system problems on AIX version 4.3.2 or later. This task provides an exerciser supervisor that controls the selected exercisers.

When you select Run Exercisers from the Task Selection menu, the EXERCISER SELECTION menu displays. Select the exerciser you want to run. Each exerciser has other menus to set options for that exerciser.

## Exerciser Commands (Cmd)

Use the following commands as needed in the exerciser menus and reports. Not all commands are available in each menu or report.

Cmd	Description
-----	-------------



<b>a</b>	Acknowledge an error
<b>b</b>	Back one page
<b>c</b>	Toggle between cycle count and last error
<b>e</b>	View the AIX error log
<b>f</b>	Page forward one page
<b>q</b>	Return to Main Menu
<b>r</b>	Refresh screen
<b>s</b>	Enable or disable beep on error
<b>x</b>	Exit system exerciser

## Acronyms

The following list describes abbreviations used in the exerciser reports. To toggle between two states for (example, Activate/Halt Devices), use the number of the device.

### Acronym

	Description
<b>COE</b>	Continue on error (use number to select).
<b>CP</b>	Device has run the specified number of cycles and is not running
<b>DD</b>	Exerciser has been terminated by a signal
<b>ER</b>	Device has stopped with an error
<b>HG</b>	Device is hung
<b>HOE</b>	Halt on error (use number to select)
<b>RN</b>	Device is running
<b>ST</b>	Device is stopped

## Memory Exerciser

The memory exercisers are labeled memx, where x is a number for the exerciser. Multiple exercisers can be active.

The memory exerciser requests as many memory buffers as possible from AIX. The exerciser then fills the memory buffers with specified bit patterns, then reads and compares the memory buffers to the specified bit patterns.

On systems with multiple processors, a process is started for each processor. The free memory space is split evenly between the available processors, thus reducing the time required to exercise all of the memory.

If the system is working properly, no comparison errors are produced. If a nonrecoverable memory error occurs, the system crashes. Recoverable memory errors are logged by the AIX operating system.

The following items must be available to run this service aid:

- Online diagnostics loaded in maintenance mode
- 128 KB of free space in **/etc/lpp/diagnostics/data**
- The following commands must be available:
  - **vmstat**
  - **lsps**
  - **bootinfo**

---

## Save or Restore Hardware Management Policies

Use this service aid to save or restore the settings from Ring Indicate Power On Policy, Surveillance Policy, Remote Maintenance Policy and Reboot Policy.

- Save Hardware Management Policies

This selection writes all of the settings for the hardware management policies to the **/etc/lpp/diagnostics/data/hmpolicies** file:

- Restore Hardware Management Policies

This selection restores all of the settings for the hardware management policies from the contents of the **/etc/lpp/diagnostics/data/hmpolicies** file:

You can access this service aid directly from the AIX command line by entering:

```
/usr/lpp/diagnostics/bin/uspchrp -a
```

---

## Save or Restore Service Processor Configuration

**Note:** This service aid runs on RSPC system units only.

Use this service aid to save or restore the Service Processor Configuration to or from a file. The Service Processor Configuration includes the Ring Indicator Power On Configuration.

- Save Service Processor Configuration

This selection writes all of the settings for the Ring Indicate Power On and the Service Processor to the **/etc/lpp/diagnostics/data/spconfig** file.

- Restore Service Processor Configuration

This selection restores all of the settings for the Ring Indicate Power On and the Service Processor from the **/etc/lpp/diagnostics/data/spconfig** file.

---

## SCSI BUS Analyzer

This service aid enables you to diagnose a SCSI Bus problem in a free-lance mode.

To use this service aid, the user should understand how a SCSI bus works. Use this service aid when the diagnostics cannot communicate with anything on the SCSI bus and cannot isolate the problem. Normally the procedure for finding a problem on the SCSI bus with this service aid is to start with a single device attached, ensure that it is working, then start adding additional devices and cables to the bus, ensuring that each one works. This service aid works with any valid SCSI bus configuration.

The SCSI Bus Analyzer Service Aid transmits a SCSI Inquiry command to a selectable SCSI Address. The service aid then waits for a response. If no response is received within a defined amount of time, the service aid displays a timeout message. If an error occurs or a response is received, the service aid then displays one of the following messages:

- The exerciser transmitted a SCSI Inquiry command and received a valid response back without any errors being detected.

- The exerciser transmitted a SCSI Inquiry command and did not receive any response or error status back. Check that the address is valid, then retry.
- The exerciser transmitted a SCSI Inquiry command and the adapter indicated a SCSI bus error.
- The exerciser transmitted a SCSI Inquiry command and an adapter error occurred.
- The exerciser transmitted a SCSI Inquiry command and an unrecoverable I/O error occurred.

When the SCSI Bus Service Aid is started, a description of the service aid displays.

Press the Enter key to display the Adapter Selection menu. Use this menu to enter which address to transmit the SCSI Inquiry Command.

When the adapter is selected, the SCSI Bus Address Selection menu displays. Use this menu to enter which address to transmit the SCSI Inquiry Command.

After the address is selected, the SCSI Bus Test Run menu displays. Use this menu to transmit the SCSI Inquiry Command by pressing the Enter key. The service aid then indicates the status of the transmission. When the transmission is completed, the results of the transmission display.

**Notes:**

1. A Check Condition can be returned when the bus or device is working properly.
2. AIX does not allow the command to be sent if the device is in use by another process.

---

## SCSI Device Identification and Removal

This service aid allows the user to choose a SCSI device or location from a menu and to identify a device located in a system unit that uses a SCSI Enclosure Services (SES) backplane.

The service aid also does the following:

- Generates a menu displaying all SCSI devices
- Lists the device and all of its sibling devices
- Lists all SCSI adapters and their ports
- Lists all SCSI devices on a port

---

## SCSI Tape Drive Service Aid

This service aid enables you to obtain the status or maintenance information from a SCSI tape drive. Only some models of SCSI tape drive are supported.

The service aid provides the following options:

- Display time since a tape drive was last cleaned.

The time since the drive was last cleaned displays on the screen. In addition, a message indicating whether the drive is recommended to be cleaned is also displayed.

- Copy a tape drive's trace table.

The trace table of the tape drive is written to diskettes or a file. The diskettes must be formatted for DOS. Writing the trace table may require several diskettes, but the actual number of diskettes is determined by the size of the trace table. Label the diskettes as follows:

'TRACE x DAT'

(where *x* is a sequential diskette number). The complete trace table consists of the sequential concatenation of all the diskette data files.

When the trace table is written to a disk file, the service aid prompts for a file name. The default name is: '/tmp/TRACE x ', where *x* is the AIX name of the SCSI tape drive being tested.

- Display or copy a tape drive's log sense information.

The service aid provides options to display the log sense information to the screen, to copy it to a DOS formatted diskette or to copy it to a file. The file name LOGSENSE.DAT is used when the log sense data is written on the diskette. The service aid prompts for a file name when the log sense data is to be copied to a file.

This service aid can be run directly from the AIX command line. The syntax of the command is as follows (path is /usr/lpp/diagnostics/bin/utape):

```
utape [-h | -?] [-d device] [-n | -l | -t]
```

OR

```
utape -c -d device [-v] {-n | {-l | -t} { -D | -f [filename]}}
```

Flag	Description
------	-------------

<b>-c</b>	Run the service aid without displaying menus. The return code indicates success or failure. The output is suppressed except for the usage statement and the numeric value for hours since cleaned (if <b>-n</b> and <b>-D</b> flags are used).
<b>-D</b>	Copy data to diskette.
<b>-f</b>	Copy data to the filename given after this flag or to a default filename if no name is specified.
<b>-h, -?</b>	Display a usage statement and/or return code. If the <b>-c</b> flag is present, only the return code displays to indicate the service aid did not run. If the <b>-c</b> is not used, a usage statement displays and the service aid exits.
<b>-l</b>	Display or copy log sense information.
<b>-n</b>	Display time since drive was last cleaned.
<b>-t</b>	Copy trace table.
<b>-v</b>	Verbose mode. If the <b>-c</b> flag is present, the information displays on the screen. If the <b>-n</b> flag is present, the information about tape-head cleaning is printed.

---

## Spare Sector Availability

This selection checks the number of spare sectors available on the optical disk. The spare sectors are used to reassign when defective sectors are encountered during normal usage or during a format and certify operation. Low availability of spare sectors indicates that the disk needs to be backed up and replaced. Formatting the disk does not improve the availability of spare sectors.

This task can be run directly from the AIX command line. The syntax of the command is as follows:

```
diag -c -d < deviceName -T chkspares
```

---

## SSA Service Aid

This service aid provides tools for diagnosing and resolving problems on SSA-attached devices. The following tools are provided:

- Set Service Mode
- Link Verification
- Configuration Verification
- Format and Certify Disk

---

## Update Disk-Based Diagnostics

This service aid allows fixes (APARs) to be applied.

This task invokes the SMIT Update Software by Fix (APAR) task. The task allows the input device and APARs to be selected. Any APAR can be installed using this task.

---

## Update System or Service Processor Flash

This selection updates the system or service processor flash for CHRP system units.

Further update and recovery instructions may be provided with the update. It is necessary to know the fully qualified path and file name of the flash-update image file that was provided. If the flash-update image file is on a diskette, the service aid can list the files on the diskette for selection.

Refer to the update instructions or the system unit's service guide to determine the level of the system unit or service processor flash.

When run from online diagnostics, the flash-update image file is copied to the **/var** file system. If there is not enough space in the **/var** file system for the flash-update image file, an error is reported. If this occurs, exit the service aid, increase the size of the **/var** file system and retry the service aid. After the file is copied, a warning screen asks for confirmation to continue the update flash. Continuing the update flash reboots the system. The system does not return to diagnostics, and the current flash image is not saved. After the reboot, the **/var/update\_flash\_image** file can be removed.

When the service aid is running from stand alone diagnostics, the flash-update image file is copied to the file system from diskette. The user needs to provide the image on a diskette since the user does not have access to remote file systems or any other files that are on the system. If enough space is not available, an error is reported stating additional system memory is needed. After the file is copied, a warning screen asks for confirmation to continue the update flash. Continuing the update flash reboots the system. The current flash image is not saved.

The **update\_flash** command can be used in place of this service aid. It is located in the **/usr/lpp/diagnostics/bin** directory.

Attention: The **update\_flash** command reboots the entire system. Do not use this command if more than one user is logged in to the system.

---

## Update System Flash

**Note:** This service aid runs on RSPC (Power PC Reference Platform) system units only.

This selection updates the system flash for RSPC systems.

The user provides a valid binary image either on diskette or from a qualified path name. The diskettes can be in DOS or in a backup format.

The flash-update image is copied to the **/var** file system. If there is not enough space in the file system for the flash update image file, an error is reported. If this occurs, increase the file size of the **/var** file system. The current flash image is not saved. The command automatically removes the **/var/update\_flash\_image** file.

After user confirmation, the command reboots the system twice to complete the flash update.

---

## 7135 RAIDiant Array Service Aid

The 7135 RAIDiant Array service aids contain the following functions:

- Certify LUN  
Reads and checks each block of data in the LUN. If excessive errors are encountered, the user is notified.
- Certify Spare Physical Disk  
Allows the user to certify (check the integrity of the data) on drives designated as spares.
- Format Physical Disk  
Used to format a selected disk drive.
- Array Controller Microcode Download  
Allows the microcode on the 7135 controller to be updated when required.
- Physical Disk Microcode Download

Used to update the microcode on any of the disk drives in the array.

- Update EEPROM

Used to update the contents of the EEPROM on a selected controller.

- Replace Controller

Used when it is necessary to replace a controller in the array.

**Adapter Microcode Download:** Usage: `diag -c -d deviceName -T "download [-B] [-D] [-P]"`

Flag	Description
------	-------------

-B	Download boot block microcode (default to functional microcode)
----	---

-D	Microcode is on diskette (default to <b>/etc/microcode</b> directory)
----	---

-P	Download the previous level of microcode (default to latest level)
----	--

**Physical Disk Microcode Download:** Usage: `diag -c -d deviceName -T "download -l ChId [-D] [-P]"`

Flag	Description
------	-------------

-l	Physical disk channel/ID (for example, 27)
----	--

-D	Microcode is on diskette (default to <b>/etc/microcode</b> directory)
----	---

-P	Download the previous level of microcode (default to latest level)
----	--

**Physical Disk Format:** Usage: `diag -c -d deviceName -T "format -l ChId`

Flag	Description
------	-------------

-l	Physical disk channel/ID (for example, 27)
----	--

**Physical Disk Certify:** Usage: `diag -c -d deviceName -T "certify -l ChId`

Flag	Description
------	-------------

-l	Physical disk channel/ID (for example, 23)
----	--

**Physical Disk Identify:** Usage: `diag -c -d deviceName -T "identify"`

---

## 7318 Serial Communications Network Server Service Aid

This service aid provides a tool for diagnosing terminal server problems.





---

## Chapter 7. Using the System Verification Procedure

Use the system verification procedure to check the system for correct operation.

If you are analyzing a hardware problem, see “Chapter 8. Hardware Problem Determination” on page 149.

---

### Step 1. Considerations before Running This Procedure

1. If this system unit is directly attached to another system unit or attached to a network, make sure that communications with the other system unit are stopped.
2. This procedure requires use of all of the system resources. No other activity can be running on the system while you are doing this procedure.
3. This procedure requires a display connected to the video port or an ASCII terminal attached to the S1 port.
4. Before starting this procedure, stop all programs and the operating system.
5. This procedure runs the Online Diagnostics in Service mode or Stand-alone Diagnostics. If the Online Diagnostics are installed, they should be run. See the operator manual for your type of ASCII terminal to find the key sequences you need to respond to the diagnostics.
6. If you need more information about diagnostics, see “Chapter 5. Using the Standalone and Online Diagnostics” on page 107.
7. If a console display is not selected, the diagnostics stop. The instructions for selecting a console display are displayed on all of the graphic displays and any terminal attached to the S1 port. Follow the displayed instructions to select a console display.
8. Go to Step 2.

---

### Step 2. Loading the Diagnostics

1. Stop all application programs running on the operating system.
2. Stop the operating system.
3. Turn off power.
4. If you are loading the Stand-alone Diagnostics and running them from an ASCII terminal, do the following:
  - The attributes for the terminal must be set to match the defaults of the diagnostics.
  - If you need to change any settings, record the normal settings, and be sure the terminal attributes are set to work with the diagnostics. If needed, see “Appendix D. General Attributes Required When Using a TTY Terminal” on page 165.
5. Turn on power.

- When the keyboard indicator appears, press F5 on the directly attached keyboard (F5 on the ASCII keyboard) (if you are loading the Stand-Alone Diagnostics) or F6 on the directly attached keyboard (F6 on the ASCII terminal keyboard) to load the Online Diagnostics.
  - Enter any requested passwords.
  - Follow the instructions to select a console.
6. When the Diagnostic Operating Instructions display, go to Step 3. If you are unable to load the diagnostics, go to “Problem Determination When Unable to Load Diagnostics” on page 154.

---

### Step 3. Running System Verification

1. On the Diagnostic Operating Instructions screen, press the Enter key.
2. If the terminal type has not been defined, use the **Initialize Terminal** option on the Function Selection menu to initialize the operating system environment before you can continue with the diagnostics.
3. If you want to do a general checkout with minimal operator action, select the **Diagnostic Routines** option on the Function Selection menu.  
If you want to do a more complete checkout, including the use of wrap plugs, select the **Advanced Diagnostics** option on the Function Selection menu. The advanced diagnostics are primarily for the service representative; they may instruct you to install wrap plugs to better isolate a problem.
4. Select the **System Verification** option on the Diagnostic Mode Selection menu.
5. If you want to run a general checkout of all installed resources, select the **All Resource** option on the Diagnostic Selection menu.  
If you want to check one particular resource, select that resource on the Diagnostic Selection menu.
6. Go to Step 4.

---

### Step 4. Additional System Verification

The checkout programs end with either the Testing Complete menu and a message stating

No trouble was found

or the A Problem Was Detected On (Time Stamp) menu with an SRN (Service Request Number).

1. Press Enter to return to the Diagnostic Selection menu.
2. If you want to check other resources, select the resource. When you have checked all of the resources you need to check, go to Step 5.

---

## Step 5. Stopping the Diagnostics

1. If you are running Online diagnostics, shut down the system first using the following procedure:
  - a. Press F3 repeatedly until you get to the Diagnostic Operating Instructions, then follow the displayed instructions.
  - b. Press F3 once, and then follow the displayed instructions to shut down the system.
2. If you changed any attributes on your ASCII terminal to run the diagnostics, change the settings back to normal.
3. This completes the system verification. Report the SRN (if you received one) to the service organization. To do a normal boot, turn off the system unit and wait 30 seconds, and then set the power switch of the system unit to On.



---

## Chapter 8. Hardware Problem Determination

This chapter provides information on using Stand-alone or online diagnostics to help you solve hardware problems. In addition, it provides a list of error codes and recommended actions that you can take to resolve the problem before contacting a service representative.

---

### Problem Determination Using the Standalone or Online Diagnostics

Use this procedure to obtain a service request number (SRN) when you are able to load the Stand-alone or Online Diagnostics. If you are unable to load the Stand-alone or Online Diagnostics, go to “Problem Determination When Unable to Load Diagnostics” on page 154. The service organization uses the SRN to determine which field replaceable units (FRUs) are needed to restore the system to correct operation.

#### Step 1. Considerations before Running This Procedure

**Note:** See the operator manual for your ASCII terminal to find the key sequences you need to respond to the diagnostic programs.

- The diagnostics can use a display connected to the video port or an ASCII terminal attached to a serial port.
- This procedure asks you to select the type of diagnostics you want to run. If you need more information about the types, see “Chapter 5. Using the Standalone and Online Diagnostics” on page 107.
- Go to step 2.

#### Step 2

**Are the Online Diagnostics installed on this system?**

**NO**                      Go to “Step 15” on page 153.

**YES**                     Go to “Step 3”.

#### Step 3

Determine if the operating system is accepting commands.

**Is the operating system accepting commands?**

**NO**                      The system must be turned off in order to run diagnostics.

Verify with the system administration and users that the system may be turned off. If so, then turn off the system unit and go to “Step 6” on page 150.

**YES**                     Go to “Step 4” on page 150.

## Step 4

Diagnostic tests can be run on many resources while the operating system is running. However, you can obtain more extensive problem isolation by running Online Diagnostics in Service mode.

### Do you want to run the Online Diagnostics in Service mode?

**NO** Go to "Step 5".

**YES** Do the following to shut down your system:

1. At the system prompt, stop the operating system using the shutdown command for your operating system.
2. After the operating system is stopped, turn off the system unit.
3. Go to "Step 6".

## Step 5

This step invokes the Online Diagnostics in concurrent mode.

1. Log in as root user.
2. Enter the **diag** command.
3. Wait until the Diagnostic Operating Instructions are displayed, or wait for three minutes.

### Are the Diagnostic Operating Instructions displayed without any obvious console display problems?

**NO** Do the following to shut down your system:

1. At the system prompt, stop the operating system using the proper command for your operating system.
2. After the operating system is stopped, turn off the system unit.
3. Go to "Step 6".

**YES** Go to "Step 9" on page 151.

## Step 6

This step loads Online Diagnostics in service mode. If you are unable to load the diagnostics, go to "Step 7" on page 151.

1. Turn on the power.
2. When the keyboard indicator (icon or text) appears, press F6 on the directly attached keyboard, or 6 on the ASCII terminal keyboard, to indicate that diagnostics are to be loaded.
3. Enter any requested passwords.
4. Follow any instructions to select a console.

### Did the Diagnostics Operating Instructions display without any obvious display problem?

**NO** Go to "Step 7".

**YES** Go to "Step 9".

## Step 7

Starting at the top of the following table, find your symptom and follow the instructions given in the Action column.

Symptom	Action
Display problem	Go to "Step 8".
All other symptoms	Go to "Problem Determination When Unable to Load Diagnostics" on page 154

## Step 8

Find your type of console display in the following table. Then follow the instructions given in the Action column.

Console Display	Action
Display Device	Go to the display documentation for problem determination.
ASCII terminal	Go to the problem-determination documentation for this type of terminal.

## Step 9

The diagnostics loaded correctly.

Press the Enter key.

### Is the Function Selection menu displayed?

**NO** Go to "Step 10".

**YES** Go to "Step 11" on page 152.

## Step 10

There is a problem with the keyboard.

Find the type of keyboard you are using in the following table. Then follow the instructions given in the Action column.

Keyboard Type	Action
101-key keyboard. Identify by the type of Enter key used. The Enter key is within one horizontal row of keys.	Record error code MOKBD001 and report the problem to the service organization.
102-key keyboard. Identify by the type of Enter key used. The Enter key extends into two horizontal rows of keys.	Record error code MOKBD002 and report the problem to the service organization.

Keyboard Type	Action
Kanji keyboard. Identify by the Japanese characters.	Record error code MOKBD003 and report the problem to the service organization.
ASCII-terminal keyboard. This applies to all attached terminals.	Go to the problem-determination documentation for this type of terminal.

## Step 11

1. If the terminal type has not been defined, use the **Initialize Terminal** option on the Function Selection menu to initialize the operating system environment before you can continue with the diagnostics. This is a separate and different operation from selecting the console display.
2. Select **Diagnostic** Routines.
3. Press the Enter key.
4. In the following table, find the menu or system response you received when you selected **Diagnostics**. Follow the instructions given in the Action column.

System Response	Action
The Diagnostic Mode Selection menu is displayed.	Select Problem Determination and go to "Step 12" on page 153.
The Missing Resource menu is displayed.	Follow the displayed instructions until either the Diagnostic Mode Selection menu or an SRN is displayed.  If the Diagnostic Mode Selection menu is displayed, select Problem Determination and go to "Step 12" on page 153.  If you get an SRN, record it, and go to "Step 14" on page 153.
The New Resource menu is displayed.	Follow the displayed instructions. <b>Note:</b> Devices attached to serial ports S1 or S2 do not appear on the New Resource menu. Also, ISA adapters do not appear unless they have been identified and configured.  If the Diagnostic Mode Selection menu is displayed, select Problem Determination and go to "Step 12" on page 153.  If you get an SRN, record it, and go to "Step 14" on page 153.  If you do not get an SRN, go to "Step 17" on page 154.
The system does not respond to selecting <b>diagnostics</b> .	Go to "Step 10" on page 151.



## Step 12

### Did the Diagnostic Selection Menu display?

- NO** If **Problem Determination** was selected from the Diagnostic Mode Selection menu, and if a recent error has been logged in the error log, the diagnostics automatically begin testing the resource. Follow the displayed instructions.
- If the **No Trouble Found** screen is displayed, press Enter.
  - If another resource is tested, repeat this step.
  - If the **Diagnostic Selection** menu is displayed, go to “Step 13”.
  - If an SRN is displayed, record it, and go to “Step 14”.
- YES** Go to “Step 13”.

## Step 13

The **All Resources** option checks most of the configured adapters and devices.

Select and run the diagnostic tests on the resources you are having problems with or select the **All Resources** option to check all of the configured resources. Find the response in the following table and follow the instructions given in the Action column.

Diagnostic Response	Action
An SRN is displayed.	Go to “Step 14”.
The system hangs.	Report SRN 109-200.
The Testing Complete menu and the No trouble was found message displays and you have not tested all of the resources.	Press Enter and continue with the testing.
The Testing Complete menu and the No trouble was found message displays and you have tested all of the resources.	Go to “Step 17” on page 154.

## Step 14

The diagnostics produced an SRN for this problem. Do the following:

1. Record the SRN and other numbers read out.
2. Report the SRN to the service organization.
3. **STOP.** You have completed these procedures.

## Step 15

When you are loading the Stand-alone Diagnostics, the attributes for the terminal must be set to match the defaults of the diagnostic programs. The ASCII terminal must be attached to serial port 1 on the system unit.

### Are you going to load Stand-alone Diagnostics and run them from a ASCII terminal?

- NO** Go to “Step 16” on page 154.

- YES** Go to “Running Diagnostics from a TTY Terminal” on page 109 and be sure your terminal attributes are set to work with the diagnostic programs.
- Return to “Step 16” when you finish checking the attributes. Record any settings that are changed.

## Step 16

This step loads the Stand-alone Diagnostics. If you are unable to load the diagnostics, go to “Step 7” on page 151.

1. Turn on the power.
2. Insert the diagnostic CD-ROM into the CD-ROM drive.
3. When the keyboard indicator displays, press F5 on the directly attached keyboard, or 5 on the ASCII keyboard, to indicate that diagnostics are to be loaded.
4. Enter any requested passwords.
5. Follow any instructions to select a console.

**Did the Diagnostics Operating Instructions display without any obvious display problem?**

- NO** Go to “Step 7” on page 151.
- YES** Go to “Step 9” on page 151.

## Step 17

The diagnostics did not find a hardware problem. If you still have a problem, contact your software support center.

---

## Problem Determination When Unable to Load Diagnostics

Use this procedure to obtain an error code. The service organization uses the error code to determine which field replaceable units (FRUs) are needed to restore the system to correct operation.

### Step 1. Considerations before Running This Procedure

- The diagnostics can use a display connected to the video port or an ASCII terminal attached to a serial port.
- Go to “Step 2”.

### Step 2

**Are the Online Diagnostics installed on this system?**

- NO** Go to “Step 4” on page 155.
- YES** Go to “Step 3” on page 155.

### Step 3

This step attempts to load Online Diagnostics in service mode.

1. Turn off the power.
2. Turn on the power.
3. If the keyboard indicator displays, press F6 on the directly attached keyboard, or 6 on the ASCII keyboard, to indicate that diagnostics are to be loaded.
4. Enter any requested passwords.
5. Follow any instructions to select a console.
6. Wait until the diagnostics load or the system appears to stop.

#### Did the diagnostics load?

- NO**                      Go to "Step 5".
- YES**                     Go to "Step 6" on page 158.

### Step 4

This step attempts to load the Stand-alone diagnostics.

1. Turn off the power.
2. Turn on the power.
3. Insert the diagnostic CD-ROM into the CD-ROM drive.
4. If the keyboard indicator displays, press F5 on the directly attached keyboard, or 5 on the ASCII keyboard, to indicate that diagnostics are to be loaded.
5. Enter any requested passwords.
6. Follow any instructions to select a console.
7. Wait until the diagnostics load or the system appears to stop.

#### Did the diagnostics load?

- NO**                      Go to "Step 5".
- YES**                     Go to "Step 6" on page 158.

### Step 5

Starting at the top of the following table, find your symptom and follow the instructions given in the Action column.

Symptom	Action
The power LED does not come on, or comes on and does not stay on.	Check the power cable to the outlet. Check the circuit breakers and check for power at the outlet.  Ensure that the room temperature is within 60 - 90°F.  If you do not find a problem, record error code M0PS0000 and report the problem to the service organization.

Symptom	Action
The system appears to be stopped and NO beep was heard from the system unit.	Processor POST failure. Report error code M0CPU000.
The system appears to be stopped and NO beep was heard from the system unit. E122, E123, or E124 is displayed on the operator panel display.	No good memory could be found. Report error code MOMEM000.
The system appears to be stopped. A beep was heard from the system unit.	No good memory could be found. Report error code MOMEM001.
The diagnostics are loaded and there was NO beep heard from the system unit during the IPL sequence.	Record error code M0SPK001.
The system stops with the Diagnostic Operating Instructions displayed.	Go to "Step 6" on page 158.
The diskette LED is blinking rapidly, or E1EA or E1EB is displayed on the operator panel.	The flash EPROM data is corrupted. Run the recovery procedure for the flash EPROM.
The system stops with a prompt to enter a password.	Enter the password. You are not allowed to continue until a correct password has been entered. When you have entered a valid password, wait for one of the other conditions to occur.
The system stops with an eight-digit error code(s) displayed on the console.	Record the error code(s) and report the problem to the service organization.
The system login prompt is displayed.	You may not have pressed the correct key, or you may not have pressed the key soon enough when you were to indicate a Service Mode boot of diagnostic programs. If this was the case, start over at the beginning of this step.  If you are sure that you pressed the correct key in a timely manner, go to Step 7.
The system does not respond when the password is entered.	Go to Step 7.

Symptom	Action
<p>The system stopped and an indicator is displayed on the system console and an eight-digit error code is not displayed.</p>	<p>If the indicator (text or icon) represents:</p> <ul style="list-style-type: none"> <li>• A keyboard, record error code M0KBD000 and report the problem to the service organization.</li> <li>• Memory, record error code M0MEM002 and report the problem to the service organization.</li> <li>• SCSI, record error code M0CON000 and report the problem to the service organization.</li> <li>• Network, record error code M0NET000 and report the problem to the service organization.</li> <li>• Speaker/Audio, record error code M0BT0000 and report the problem to the service organization.</li> </ul>
<p>The System Management Services menu is displayed.</p>	<p>The device or media that you are attempting to boot from might be faulty.</p> <ol style="list-style-type: none"> <li>1. Check the SMS error log for any errors. To check the error log: <ul style="list-style-type: none"> <li>• Select <b>tools</b></li> <li>• Select <b>error log</b></li> <li>• If an error is logged, check the time stamp.</li> <li>• If the error was logged during the current boot attempt, record it and report it to your service representative.</li> <li>• If no recent error is logged in the error log, continue to the next step below.</li> </ul> </li> <li>2. If you are attempting to load the Online Diagnostics, try loading the Stand-alone Diagnostics. Otherwise, record error code M0SCSI01 and report to the service organization.</li> </ol>
<p>The system appears to be stopped, the disk activity light is on continuously, and a beep was heard from the system unit.</p>	<p>Record error code M0MEM001 and report the problem to the service organization.</p>
<p>The system stops with the message STARTING SOFTWARE PLEASE WAIT displayed.</p>	<p>Report error code M0BT0000.</p>
<p>The message The system will continue the boot process is displayed continuously on the system unit's console.</p>	<p>Report error code M0SCSI01.</p>

## Step 6

The diagnostics loaded correctly.

Go to “Problem Determination Using the Standalone or Online Diagnostics” on page 149.

## Step 7

There is a problem with the keyboard.

Find the type of keyboard you are using in the following table. Then follow the instructions given in the Action column.

<b>Keyboard Type</b>	<b>Action</b>
101-key keyboard. Identify by the type of Enter key used. The Enter key is within one horizontal row of keys.	Record error code MOKBD001 and report the problem to the service organization.
102-key keyboard. Identify by the type of Enter key used. The Enter key extends into two horizontal rows of keys.	Record error code MOKBD002 and report the problem to the service organization.
Kanji keyboard. Identify by the Japanese characters.	Record error code MOKBD003 and report the problem to the service organization.
ASCII-terminal keyboard. This applies to all attached terminals.	Go to the problem-determination documentation for this type of terminal.

---

## **Appendix A. Environmental Notices**

---

### **Product Recycling and Disposal**

Components of the system unit, such as structural parts and circuit cards, can be recycled where recycling facilities exist. Companies are available to disassemble, reutilize, recycle, or dispose of electronic products. Contact your account representative for more information. This system unit contains batteries and circuit boards with lead solder. Before you dispose of this unit, these batteries and circuit boards must be removed and discarded according to local regulations or recycled where facilities exist. This book contains specific information on each battery type where applicable.

---

### **Battery Return Program**

In the United States, IBM has established a collection process for reuse, recycling, or proper disposal of used IBM batteries and battery packs. For information on proper disposal of the batteries in this unit, please contact IBM at 1-800-426-4333. Please have the IBM part number that is listed on the battery available when you make your call. For information on battery disposal outside the United States, contact your local waste disposal facility.

---

### **Environmental Design**

The environmental efforts that have gone into the design of this system signify IBM's commitment to improve the quality of its products and processes. Some of these accomplishments include the elimination of the use of Class I ozone-depleting chemicals in the manufacturing process and reductions in manufacturing wastes. For more information, contact an IBM account representative.

### **Unit Emissions**

The unit-related emission value is equal to or lower than 70dB(A).

Der Geräuschpegel der Einheit ist kleiner oder gleich 70 db(A).





---

## Appendix B. Notices

This information was developed for products and services offered in the U.S.A.

The manufacturer may not offer the products, services, or features discussed in this document in other countries. Consult the manufacturer's representative for information on the products and services currently available in your area. Any reference to the manufacturer's product, program, or service is not intended to state or imply that only that product, program, or service may be used. Any functionally equivalent product, program or service that does not infringe any intellectual property right of the manufacturer may be used instead. However, it is the user's responsibility to evaluate and verify the operation of any product, program, or service.

The manufacturer may have patents or pending patent applications covering subject matter described in this document. The furnishing of this document does not give you any license to these patents. You can send license inquiries, in writing, to the manufacturer.

**The following paragraph does not apply to the United Kingdom or any country where such provisions are inconsistent with local law:** THIS PUBLICATION IS PROVIDED "AS IS" WITHOUT WARRANTY OF ANY KIND, EITHER EXPRESS OR IMPLIED, INCLUDING, BUT NOT LIMITED TO, THE IMPLIED WARRANTIES OF MERCHANTABILITY OR FITNESS FOR A PARTICULAR PURPOSE. Some states do not allow disclaimer of express or implied warranties in certain transactions, therefore, this statement may not apply to you.

This information could include technical inaccuracies or typographical errors. Changes are periodically made to the information herein: these changes will be incorporated in new editions of the publication. The manufacturer may make improvements and/or changes in the product(s) and/or the programs(s) described in this publication at any time without notice..

Information concerning products made by other than the manufacturer was obtained from the suppliers of those products, their published announcements, or other publicly available sources. The manufacturer has not tested those products and cannot confirm the accuracy of performance, compatibility or any other claims related to products made by other than the manufacturer. Questions on the capabilities of products made by other than the manufacturer should be addressed to the suppliers of those products.



---

## Appendix C. Checking the Current Firmware Levels

To check the current levels that are installed on the system, do the following:

1. Log in as root user.
2. Enter the following command:

```
lscfg -vp | grep alterable
```

3. Press Enter. A report will be produced similar to the following:

```
ROM Level.(alterable).....sh000221 <=== service processor F/W level  
ROM Level.(alterable).....SPH00056 <=== system F/W level
```

### Notes:

1. In the example above, if the current version of service processor firmware is sh000221, the last six characters of the ROM Level represent a date in a *yyymmdd* format, where *yy* is the last two digits of the year, *mm* is the month and *dd* is the day of the firmware (Julian date).
2. Also in the example above, if the current version of system firmware is SPH00056, the last five characters of the ROM Level represent a date in a *yyddd* format, where *yy* is the last two digits of the year and *ddd* is the Gregorian date of the firmware.

Check the RS/6000 support web site at <http://www.rs6000.ibm.com/support/micro> for the latest level of downloadable firmware and update instructions. If the version of system firmware installed on your system is newer than (has a later date) or the same date as the system firmware shown on the Web site, do not download and apply the update. If the version of service processor firmware installed on your system is newer than (has a later date) or the same date as the service processor firmware shown on the Web site, do not download and apply the update.



## Appendix D. General Attributes Required When Using a TTY Terminal

The following general attributes are the default settings for the diagnostic programs. Be sure your terminal is set to these attributes.

**Note:** Set these attributes before the diagnostic programs are loaded.

General Setup Attributes	3151 /11/31/41 Settings	3151 /51/61 Settings	3161 /3164 Settings	Description
Machine mode	3151	3151 PC	3161 or 3164	The diagnostic programs are set to emulate use of the 3161 ASCII Display Terminal. If your terminal can emulate a 5085, 3161 or 3164 terminal, use these attribute settings. Otherwise, refer to your operator's manual, compare the attribute descriptions with those of your terminal, and set your attributes accordingly.
Generated Code Set		ASCII		
Screen	Normal	Normal		Uses the EIA-232 interface protocol.
Row and Column	24 x 80	24 x 80		Uses the EIA-232 interface protocol.
Scroll	Jump	Jump	Jump	When the last character on the bottom line is entered, the screen moves down one line.
Auto LF	Off	Off	Off	For the "On" setting, pressing the Return key moves the cursor to the first character position of the next line. For the "Off" setting, pressing the Return key moves the cursor to the first character position of the current line. The CR and LF characters are generated by the New line setting.
CRT saver	Off	Off	10	The "10" setting causes the display screen to go blank if there is no activity for 10 minutes. When the system unit sends data or a key is pressed, the screen contents display again.

General Setup Attributes	3151 /11/31/41 Settings	3151 /51/61 Settings	3161 /3164 Settings	Description
Line wrap	On	On	On	The cursor moves to the first character position of the next line in the page after it reaches the last character position of the current line in the page.
Forcing insert	Off	Off		
Tab	Field	Field	Field	The column tab stops are ignored, and the tab operation depends on the field attribute character positions.
Trace			All	Both inbound data (data to the system unit) and outbound data (data from the system unit) to and from the main port can be transferred to the auxiliary port without disturbing communications with the system unit when the Trace key is pressed.

---

## Additional Communication Attributes

The following communication attributes are for the 3151, 3161, and 3164 terminals.

Communication Setup Attributes	3151/11 /31/41) Settings	3151 /51/61, Settings	3161 /3164 Settings	Description
Operating mode	Echo	Echo	Echo	Data entered from the keyboard on the terminal is sent to the system unit for translation and then sent back to the display screen. Sometimes called <i>conversational mode</i> .
Line speed	9600 bps	9600 bps	9600 bps	Uses the 9600 bps (bits per second) line speed to communicate with the system unit.
Word length (bits)	8	8	8	Selects eight bits as a data word length (byte).
Parity	No	No	No	Does not add a parity bit and is used together with the word length attribute to form the 8-bit data word (byte).
Stop bit	1	1	1	Places a bit after a data word (byte).

<b>Communication Setup Attributes</b>	<b>3151/11 /31/41) Settings</b>	<b>3151 /51/61, Settings</b>	<b>3161 /3164 Settings</b>	<b>Description</b>
Turnaround character	CR	CR	CR	Selects the carriage return (CR) character as the line turnaround character.
Interface	EIA-232	EIA-232	EIA-232	Uses the EIA-232 interface protocol.
Line control	IPRTS	IPRTS	IPRTS	Uses the 'permanent request to send' (IPRTS) signal to communicate with system unit.
Break signal (ms)	500	500	500	The terminal sends a break signal to the system unit within 500 ms after the Break key is pressed.
Send null suppress	On	On		Trailing null characters are not sent to the system unit.
Send null			On	Trailing null characters are sent to the system unit.
Response delay (ms)	100	100	100	The terminal waits for 100 ms for the system unit to respond.

---

### **Additional Keyboard Attributes**

The following keyboard attributes are for the keyboard attached to the 3151, 3161, and 3164 terminals.

<b>Keyboard Setup Attributes</b>	<b>3151/11 /31/41 Settings</b>	<b>3151 /51/61 Settings</b>	<b>3161 /3164 Settings</b>	<b>Description</b>
Enter	Return	Return	Return	The Enter key functions as the Return key.
Return	New line	New line	New line	The cursor moves to the next line when the Return key is pressed.
New line	CR	CR	CR	The Return key generates the carriage return (CR) and the line feed (LF) characters. The line turnaround occurs after the CR and LF characters are generated.
Send	Page	Page	Page	The contents of the current page are sent to the system unit when the Send key is pressed.
Insert character	Space	Space	Space	A blank character is inserted when the Insert key is pressed.

---

## Additional Printer Attributes

The following printer attributes are for a printer attached to the 3151, 3161, and 3164 terminals.

Printer Setup Attributes	3151/11 /31/41 Settings	3151 /51/61 Settings	3161 /3164 Settings	Description
Line speed	9600	9600	9600	Uses 19200 or 9600 bps (bits per second) line speed to communicate with the system unit.
Word length (bits)	8	8	8	Selects eight bits as a data word length (byte).
Parity	Even	Even	No	
Stop bit	1	1	1	Places a bit after a data word (byte).
Characters	ALL	ALL		
Line end			CR-LF	
Print			View port	
Print EOL			Off	
Print null			Off	



---

## Appendix E. Modem Configurations

The Service Processor is designed to place little demand on the attached modem, thereby increasing the setup and connection success rates.

---

### Sample Modem Configuration Files

Several sample modem configurations files are supplied that either work directly with your modem, or provide a good starting point for a custom setup, if required. These files are included on the Sample Modem Configuration Files diskette and in your Service Processor firmware with the following names:

Diskette File Name	Service Processor Firmware File Name
modem_z.cfg	modem_z.sp
modem_z0.cfg	modem_z0.sp
modem_f.cfg	modem_f.sp
modem_f0.cfg	modem_f0.sp
modem_f1.cfg	modem_f1.sp
modem_m0.cfg	modem_m0.sp
modem_m1.cfg	modem_m1.sp

The sample modem configuration files are located in the **/usr/share/modems** subdirectory, if your server is using AIX. A listing of each file is included at the end of this appendix.

Use the following selection procedures and your modem manual, to determine which of the configuration files is suitable for your use.

---

### Configuration File Selection

1. Is your modem an IBM 7852-400?

If Yes, use modem configuration file **modem\_m0.cfg** and then go to step 7.

**Note:** The IBM 7852-400 modem has DIP switches on the right side of the unit. See "IBM 7852-400 DIP Switch Settings" on page 172 for the correct switch settings.

If No, continue with step 2.

2. Is your modem an IBM 7857-017?

If Yes, use modem configuration file **modem\_m1.cfg** and then go to step 7.

**Note:** The IBM 7857-017 modem has two telephone line connections on the back of the unit. One is marked **LL** (for Leased Line), and the other is marked

**PTSN** (for Public Telephone Switched Network). The service processor expects to use the modem on the public network, so the telephone line should attach to the PTSN connector.

If No, continue with step 3.

3. Does your modem respond to the extended command set (prefixed with &)?

If Yes, go to step 5.

OR

If No, continue with step 4.

4. Does your modem respond to:

- ATZ reset command,

OR

- ATZn reset commands, where n can be 0, 1, and so on?

If ATZ, configuration file **modem\_z.cfg** is recommended. If ATZn, configuration file **modem\_z0.cfg** is recommended.

Go to step 7.

5. Does your modem command set include a test for V.42 error correction at the remote modem (often called "Auto-Reliable Mode")?

If Yes, disable this test. You can use sample configuration files

**/usr/share/modem\_m0.cfg**

OR

**/usr/share/modem\_m1.cfg** as models to help you create a file for your particular modem. See "Customizing the Modem Configuration Files" on page 171. Go to step 7.

If No, go to step 6.

6. Does your modem respond to:

- AT&F reset command,

OR

- AT&Fn reset commands, where n can be 0, 1, and so on.?

If AT&F, configuration file **modem\_f.cfg** is recommended.

If AT&Fn, configuration file **modem\_f0.cfg** or **modem\_f1.cfg** is recommended, depending on which provides the hardware flow control profile.

7. You have completed selection of the configuration file.

If your modem configuration selection is not available in the Service Processor Modem Configuration Menu, you must access it through the Configure Remote Maintenance Policy Service Aid.

If you find it necessary to adjust any of these configuration files, do so with reference to the manual that came with your modem. It is recommended you select settings that enable hardware flow control and respond to DTR.

**Note:** Some older modems do not respond to the commands **X0** or **&R1**. You should edit out these commands from the modem configuration file if yours is such a modem. See your modem manual for more information.

**Note:** Some modems, such as the IBM 7857-017, are not designed for the paging function. Although they can be used for paging, they return an error message when they do not get the expected response from another modem. Therefore, even though the paging was successful, the error message causes the Service Processor to retry, continuing to place pager calls for the number of retries specified in the Call-Out Policy Setup Menu. These retries result in redundant pages.

## Examples for Using the Generic Sample Modem Configuration Files

Modem	Setup Z	Setup Z0 (Rare)	Setup F	Setup F0	Setup F1
AT&T DataPort 2001 **				X	
Bocamodem 1440E			X		
Hayes Smart Modem 300	X				
IBM 5841	X				
IBM 5843	X				
IBM 7851				X	
IBM 7852-10				X	
IBM 7855					X
USRobotics 36.6K Sportster					X
Zoom V.32			X		

**Note:** \*\* Ring interrupt only on first ring.

## Customizing the Modem Configuration Files

You can create your own modem configuration files or modify the samples provided. After you customize your modem configuration files, you *must* access them through the Configure Remote Maintenance Policy Service Aid rather than from the Service Processor menus.

### Notes:

1. If you have already set up your serial ports, line speeds, authorizations and telephone numbers from the Service Processor menus, use the service aid to specify your customized modem configuration files.
2. If you have not already set up your serial ports, line speeds, authorizations, and telephone numbers from the Service Processor menus, you can use the service aids to set them while you specify your customized modem configuration files.

To disable Auto-Reliable Mode testing of the remote modem, use the sample modem configuration file `/usr/share/modems/modem_f.cfg` as a model to modify.

1. Find the necessary command in your modem manual.

2. Copy the `/usr/share/modems/modem_f.cfg` file to a new file with a different name (for example `modem_fx.cfg`).
3. In the new file (`modem_fx.cfg`), change the line `Send "ATE0T\r"` to `Send "ATcccE0T\r"` where `ccc` is the added command as specified your modem manual, as follows:  
 Change the third line of each of the following stanzas:
  - `condout`
  - `condin`
  - `ripo`
4. Save the changes.

## IBM 7852-400 DIP Switch Settings

If you are using a 7852-400 modem to enable service processor communications, the DIP (dual inline package) switches must be set according to the following table.

Switch	Position	Function
1	Up	Force DTR
2	Up	Flow Control &E4
3	Down	Result Codes Enabled
4	Down	Modem Emulation Disabled
5	Up	Auto Answer Enabled
6	Up	Maximum Throughput Enabled
7	Up	RTS Normal Functions
8	Down	Enable Command Mode
9	Down	Remote Digital Loopback Test Enabled
10	Up	Dial-Up Line Enabled
11	*Up	AT Responses Enabled (Extended Responses Disabled)
12	*Down	Asynchronous Operation
13	Up	28.8KB Line Speed
14	Up	
15	Up	CD and DSR Normal Functions
16	Up	2-Wire Leased Line Enabled

\* Only switches 11 and 12 are changed from the factory default settings.

## Xon/Xoff Modems

Some early modems assume software flow control (Xon/Xoff) between the computer and the modem. Modems with this design send extra characters during and after the transmitted data. The Service Processor cannot accept these extra characters. If your configuration includes such a modem, your functional results may be unpredictable.

The sample modem configuration files included in this package do not support these modems, so custom configuration files are necessary. Anchor Automation 2400E is an example of such a modem.

If you experience unexplainable performance problems that may be due to Xon/Xoff characters, it is recommended that you upgrade your modem..

## Ring Detection

Most modems produce an interrupt request each time they detect a ring signal. Some modems generate an interrupt only on the first ring signal that they receive. AT&T Data Port 2001 is an example of such a modem.

The Service Processor uses the ring interrupt request to count the number of rings when Ring Indicate Power-On (RIPO) is enabled. If your modem produces an interrupt on only the first ring, set Ring Indicate Power-On to start on the first ring. Otherwise, you can choose to start Ring Indicate Power-On on any ring count.

## Terminal Emulators

The Service Processor is compatible with simple ASCII terminals, and therefore compatible with most emulators. When a remote session is handed off from the Service Processor to the operating system, agreement between terminal emulators becomes important.

The server's operating system will have some built-in terminal emulators. You may also have a commercially available terminal emulation. It is important that the local and host computers select the same or compatible terminal emulators so that the key assignments and responses match, ensuring successful communications and control.

For best formatting, choose line wrap in your terminal emulator setup.

## Recovery Procedures

Situations such as line noises and power surges can sometimes cause your modem to enter an undefined state. When it is being used for dial-in, dial-out or ring indicate power-on, your modem is initialized each time one of these actions is expected. If one of these environmental conditions occur after your modem has been initialized, it may be necessary to recover your modem to a known state.

If your modem communicates correctly with remote users, it is probably in control. It may be wise to occasionally change some of the functional settings and then change them back, just for the sense of security that the modem is communicating, and to ensure it has been initialized recently.

If your system is particularly difficult to access physically, another strategy is to protect it with an Uninterruptable Power Source (UPS) and a phone-line surge protector.

In case recovery becomes necessary, shut down your system as gracefully as possible. Disconnect the power cable and press the power button to drain capacitance while power is disconnected. Disconnect and reconnect modem power, then reconnect system power to completely reinitialize your system.

---

## Transfer of a Modem Session

Because many modem command variations exist, the sample modem configuration files located at the end of this appendix have been written to capture the largest number of workable modem settings.

The modem command **&Dn** (where 'n' is a number) generally sets the modem response to the Data Terminal Ready (DTR) signal from the server's serial port. The desired response is that the modem will hold a connection while DTR is enabled, and drop the connection when DTR is released. This is the mechanism by which the server hangs up on a connection under normal conditions.

Consult your modem manual for its specific response scheme for the **&Dn** command.

Two strategies are available for dealing with the modem's response to DTR:

- Recovery
- Prevention

Before you use one of these strategies, determine if your server's modem is set up properly to respond to DTR.

With the remote terminal connected to serial port 1 and defined as the Primary Console Device, there are two tests you can perform:

1. Will the modem drop the connection after the System initialization complete message displays at the remote terminal?

If Yes, the modem is set up correctly.

If No, try another **&Dn** setting for your server's modem. See your modem manual for this information. The **&Dn** command appears in three places each in three of the sample modem configuration files:

- modem\_f.cfg
- modem\_f0.cfg
- modem\_f1.cfg

2. Will the server's modem disconnect when the power drops? You can make this observation at the remote terminal by commanding your server to shutdown and power off. (The AIX command **shutdown -F** will do this.) Watch for the message NO CARRIER on your remote terminal.

If Yes, this is the correct response. The modem is set up correctly.

If No, try another **&Dn** setting for your server's modem. See your model manual for this information. The **&Dn** command appears in three places each in three of the sample modem configuration.

If you are using modem\_z.cfg or modem\_z0.cfg, you cannot control DTR response. If your remote terminal does not disconnect after logging off, you must command the remote terminal emulator to hang up. This then breaks the connection.

## Recovery Strategy

The recovery strategy consists of making two calls to establish a remote session. This is the easiest solution to implement, and allows more freedom for configuring your server's serial ports.

To set up a remote terminal session, dial into the Service Processor and start the system. After the operating system is loaded and initialized, the connection will be dropped. At this point, you call the server back and the operating system will answer and offer you the login prompt.

## Prevention Strategy

The disconnect is caused by the operating system when it initializes the Primary Console. The modem tests listed above are conducted with the remote terminal selected as the primary console to manifest the modem's response to DTR transitions.

- If a local ASCII terminal or a graphics console is to be a permanent part of your server, then make one of them the primary console. Your remote terminal will no longer experience the connection loss.
- If a local console is not a permanent part of your server, you can still assign either the unused graphics console or the unused serial port as the primary console. This gives you the desired seamless connection at your remote terminal.
- If you choose to use the unused serial port as the primary console, some initialization traffic will be sent to any serial device attached to that port. As a result, that serial device's connection and function could be affected. These impacts may make that port unattractive for devices other than a temporary local ASCII terminal.

## Modem Configuration Samples

### Sample File modem\_z.cfg

```
#
# COMPONENT_NAME: (ESPSETUP) ENTRY SERVICE PROCESSOR SETUP Z
#
# FUNCTIONS: Modem configuration file for many early Hayes* compatible modems.
# This example uses the ATZ reset command to choose the factory defaults.
# This setup will work for many modems, but it is required for early vintage
# modems which respond to neither the ATZ0 reset command nor the extended (&)
# commands. Refer to your modem manual.
#
# * Trademark of Hayes Microcomputer Products, Inc.
#
# (C) COPYRIGHT International Business Machines Corp. 1996
# All Rights Reserved
# Licensed Materials - Property of IBM
#
# US Government Users Restricted Rights - Use, duplication or
# disclosure restricted by GSA ADP Schedule Contract with IBM Corp.
#
#
# If the modem has configuration switches, they should be set to the
# factory default settings.

ICDelay 1
DefaultTO 10
CallDelay 120
# AT Attention Code , Inserts delay in dialing commands
# Z Reset to factory defaults Q0 Turn on responses
# E0 Turn echo off Q1 Turn off responses
```

```

# V0 Use numeric responses      S0=0 Automatic answer inhibit
# +++ Escape to command mode  S0=2 Answer on second ring
# H0 Hang-up                   T = Tone mode. When used as T\r, it is a
#                               no op to maintain program synchronization
#                               when modem may/will echo the commands.
#
# %N Call-Out phone number     %P Paging phone number
# %S Modem speed (available to users)
#
# Following are common responses from a wide range of modems:
# 16, 15, 12, 10, 5 and 1 are connection responses. Add others as required.
# 7=busy; 6=no dial tone; 4=error; 3=no carrier; 2=ring; 0=OK
#
# PROGRAMMING NOTE: No blanks between double quote marks (").

condout:  send "ATZQ0T\r"                # Reset to factory defaults.
          ignore "\0\r" or "OK\r\n" timeout 2 # Ignore modem response.
          send "ATE0T\r"                  # Initialize modem: Echo OFF,
          expect "\0\r" or "OK\r\n" timeout 2 # Enable responses (Numeric),
          send "ATQ0V0T\r"                # Limit response codes.
          expect "\0\r" timeout 2         # Confirm commands successful.
          send "ATS0=0\r"                 # Set AutoAnswer OFF
          expect "\0\r" timeout 2         # Confirm command successful.
          done

connect:  send "ATDT%N\r"                # Tone dialing command.
          # %N from Call Home setup.

          # Expect a connection response.
          expect "16\r" or "15\r" or "14\r" or "12\r" or "10\r" or "5\r" or "1\r" busy "7\r"
          timeout 60
          done

retry:    send "A/"                      # Repeat the previous command.

          # Expect a connection response.
          expect "16\r" or "15\r" or "14\r" or "12\r" or "10\r" or "5\r" or "1\r" busy "7\r"
          timeout 60
          done

disconnect:
          delay 2                          # Separate from previous data.
          send "+++"                        # Assure command mode.
          delay 2                          # Allow mode switching delay.
          send "ATH0T\r"                    # Set modem switch-hook down
          # (i.e., hang up).
          ignore "\0\r" or "OK\r" timeout 2 # Ignore modem response.
          send "ATE0Q1\r"                  # Initialize modem: Echo OFF,
          # Disable responses.

          ignore "\0\r" timeout 1
          done

condin:   send "ATZQ0T\r"                # Reset to factory defaults.
          ignore "\0\r" or "OK\r\n" timeout 2 # Ignore modem response.
          send "ATE0T\r"                  # Initialize modem: Echo OFF,

```



```

        expect "0\r" or "OK\r\n" timeout 2 # Enable responses (Numeric),
        send "ATQ0V0T\r" # Limit response codes.
        expect "0\r" timeout 2 # Confirm commands successful.
        send "ATS0=2\r" # Set AutoAnswer ON
        expect "0\r" timeout 2 # Confirm command successful.
        done

waitcall: ignore "2\r" timeout 1 # Ignore first ring.
        expect "2\r" timeout 10 # Pick up second ring
        # or timeout.
        # Expect a connection response.
        expect "16\r" or "15\r" or "14\r" or "12\r" or "10\r" or "5\r" or "1\r"
        timeout 60
        done

page: send "ATDT%N,,,,%R;\r" # %N = pager call center number
        # Add enough commas to wait for
        # time to enter paging number.
        # %R = paging number

        # Confirm successful command.
        expect "0\r" timeout 60
        delay 2 # Wait before hanging up.
        send "ATH0T\r" # Hang up.
        expect "0\r" timeout 2 # Confirm successful command.
        done

ripo: send "ATZQ0T\r" # Reset to factory defaults.
        ignore "0\r" or "OK\r\n" timeout 2 # Ignore modem response.
        send "ATE0T\r" # Initialize modem: Echo OFF,
        expect "0\r" or "OK\r\n" timeout 2 # Enable responses (Numeric),
        send "ATQ0V0T\r" # Limit response codes.
        expect "0\r" timeout 2 # Confirm commands successful.
        send "ATS0=0\r" # Set AutoAnswer OFF
        expect "0\r" timeout 2 # Confirm command successful.
        done # RI Power On enabled.

error: # Handle unexpected modem
        # responses.
        expect "8\r" or "7\r" or "6\r" or "4\r" or "3\r"
        delay 2
        done

```

### Sample File modem\_z0.cfg

```

#
# COMPONENT_NAME: (ESPSETUP) ENTRY SERVICE PROCESSOR SETUP Z0
#
# FUNCTIONS: Modem configuration file for some early Hayes* compatible modems.
# This example uses the ATZ0 reset command to choose the factory defaults.
# This setup is recommended for modems that will respond to the ATZ0 command
# and which do not respond to the extended (&) commands. Refer to your modem
# manual.
#
# * Trademark of Hayes Microcomputer Products, Inc.
#

```

```

# (C) COPYRIGHT International Business Machines Corp. 1996
# All Rights Reserved
# Licensed Materials - Property of IBM
#
# US Government Users Restricted Rights - Use, duplication or
# disclosure restricted by GSA ADP Schedule Contract with IBM Corp.
#
#
# If the modem has configuration switches, they should be set to the
# factory default settings.

ICDelay 1
DefaultT0 10
CallDelay 120
# AT Attention Code , Inserts delay in dialing commands
# Z0 Reset. Restore Profile 0 Q0 Turn on responses
# E0 Turn echo off Q1 Turn off responses
# V0 Use numeric responses S0=0 Automatic answer inhibit
# +++ Escape to command mode S0=2 Answer on second ring
# H0 Hang-up X0=0 Limit modem response codes
#
# T = Tone mode. When used as T\r, it is a
# no op to maintain program synchronization
# when modem may/will echo the commands.
#
# %N Call-Out phone number %P Paging phone number
# %S Modem speed (available to users)
#
# Following are common responses from a wide range of modems:
# 16, 15, 12, 10, 5 and 1 are connection responses. Add others as required.
# 7=busy; 6=no dial tone; 4=error; 3=no carrier; 2=ring; 0=OK
#
# PROGRAMMING NOTE: No blanks between double quote marks (").

condout: send "ATZ0Q0T\r" # Reset modem. Select profile 0
ignore "0\r" or "OK\r\n" timeout 2 # Ignore modem response.
send "ATE0T\r" # Initialize modem: Echo OFF,
expect "0\r" or "OK\r\n" timeout 2 # Enable responses (Numeric),
send "ATQ0V0X0T\r" # Limit response codes.
expect "0\r" timeout 2 # Confirm commands successful.
send "ATS0=0\r" # Set AutoAnswer OFF
expect "0\r" timeout 2 # Confirm command successful.
done

connect: send "ATDT%N\r" # Tone dialing command.
# %N from Call Home setup.

# Expect a connection response.
expect "16\r" or "15\r" or "14\r" or "12\r" or "10\r" or "5\r" or "1\r" busy "7\r"
timeout 60
done

retry: send "A/" # Repeat the previous command.

# Expect a connection response.
expect "16\r" or "15\r" or "14\r" or "12\r" or "10\r" or "5\r" or "1\r" busy "7\r"

```

```

timeout 60
done

disconnect:
delay 2 # Separate from previous data.
send "+++" # Assure command mode.
delay 2 # Allow mode switching delay.
send "ATH0T\r" # Set modem switch-hook down
# (i.e., hang up).

ignore "\r" or "OK\r\n" timeout 2 # Ignore modem response.
send "ATE0Q1\r" # Initialize modem: Echo OFF,
# Disable responses.

ignore "\r" timeout 1
done

condin: send "ATZ0Q0T\r" # Reset modem. Select profile 0
ignore "\r" or "OK\r\n" timeout 2 # Ignore modem response.
send "ATE0T\r" # Initialize modem: Echo OFF,
expect "\r" or "OK\r\n" timeout 2 # Enable responses (Numeric),
send "ATQ0V0X0T\r" # Limit response codes.
expect "\r" timeout 2 # Confirm commands successful.
send "ATS0=2\r" # Set AutoAnswer ON
expect "\r" timeout 2 # Confirm command successful.
done

waitcall: ignore "2\r" timeout 1 # Ignore first ring.
expect "2\r" timeout 10 # Pick up second ring
# or timeout.
# Expect a connection response.
expect "16\r" or "15\r" or "14\r" or "12\r" or "10\r" or "5\r" or "1\r"
timeout 60
done

page: send "ATDT%N,,,,%R;\r" # %N = pager call center number
# Add enough commas to wait for
# time to enter paging number.
# %R = paging number

# Confirm successful command.
expect "\r" timeout 60
delay 2 # Wait before hanging up.
send "ATH0T\r" # Hang up.
expect "\r" timeout 2 # Confirm successful command.
done

ripo: send "ATZ0Q0T\r" # Reset modem. Select profile 0
ignore "\r" or "OK\r\n" timeout 2 # Ignore modem response.
send "ATE0T\r" # Initialize modem: Echo OFF,
expect "\r" or "OK\r\n" timeout 2 # Enable responses (Numeric),
send "ATQ0V0X0T\r" # Limit response codes.
expect "\r" timeout 2 # Confirm commands successful.
send "ATS0=0\r" # Set AutoAnswer OFF
expect "\r" timeout 2 # Confirm command successful.
done # RI Power On enabled.

```

```

error:                                     # Handle unexpected modem
                                           # responses.
      expect "8\r" or "7\r" or "6\r" or "4\r" or "3\r"
      delay 2
      done

```

## Sample File modem\_f.cfg

```

#
# COMPONENT_NAME: (ESPSETUP) ENTRY SERVICE PROCESSOR SETUP F
#
# FUNCTIONS: Modem configuration file for many recent Hayes* compatible modems.
# This example uses the AT&F reset command to choose the factory defaults.
# This set up is preferred for modems with extended (&) commands. For early
# vintage modems, setup Z or Z0 is recommended. If your modem responds to
# the extended (&) commands and to factory default choices (&Fn), setup file
# F0 or F1 is recommended.
#
# * Trademark of Hayes Microcomputer Products, Inc.
#
# (C) COPYRIGHT International Business Machines Corp. 1996
# All Rights Reserved
# Licensed Materials - Property of IBM
#
# US Government Users Restricted Rights - Use, duplication or
# disclosure restricted by GSA ADP Schedule Contract with IBM Corp.
#
#
# If the modem has configuration switches, they should be set to the
# factory default settings.

ICDelay 1
DefaultT0 10
CallDelay 120
# AT Attention Code           , Inserts delay in dialing commands
# &F Reset to default profile Q0 Turn on responses
# E0 Turn echo off           Q1 Turn off responses
# V0 Use numeric responses    S0=0 Automatic answer inhibit
# +++ Escape to command mode S0=2 Answer on second ring
# H0 Hang-up                 X0=0 Limit modem response codes
#
#                               T = Tone mode. When used as T\r, it is a
#                               no op to maintain program synchronization
#                               when modem may/will echo the commands.
#
# &C1 Detect CD               &D2 Respond to DTR (often the default)
#
# %N Call-Out phone number    %P Paging phone number
# %S Modem speed (available to users)
#
# Following are common responses from a wide range of modems:
# 16, 15, 12, 10, 5 and 1 are connection responses. Add others as required.
# 7=busy; 6=no dial tone; 4=error; 3=no carrier; 2=ring; 0=OK
#
# PROGRAMMING NOTE: No blanks between double quote marks (").

conduit:  send "AT&FQ0T\r"                # Reset to factory defaults.

```

```

        ignore "\0\r" or "OK\r\n" timeout 2 # Ignore modem response.
        send "ATE0T\r" # Initialize modem: Echo OFF,
        expect "\0\r" or "OK\r\n" timeout 2 # Enable responses (Numeric),
        send "ATQ0V0X0T\r" # Limit response codes.
        expect "\0\r" timeout 2 # Confirm commands successful.
        send "ATS0=0\r" # Set AutoAnswer OFF
        expect "\0\r" timeout 2 # Confirm command successful.
        send "AT&C1&D2\r" # Detect carrier and DTR.
        expect "\0\r" timeout 2 # Confirm command successful.
        done

connect: send "ATDT%N\r" # Tone dialing command.
        # %N from Call Home setup.

        # Expect a connection response.
        expect "16\r" or "15\r" or "14\r" or "12\r" or "10\r" or "5\r" or "1\r" busy "7\r"
        timeout 60
        done

retry: send "A/" # Repeat the previous command.

        # Expect a connection response.
        expect "16\r" or "15\r" or "14\r" or "12\r" or "10\r" or "5\r" or "1\r" busy "7\r"
        timeout 60
        done

disconnect:
        delay 2 # Separate from previous data.
        send "+++" # Assure command mode.
        delay 2 # Allow mode switching delay.
        send "ATH0T\r" # Set modem switch-hook down
        # (i.e., hang up).
        ignore "\0\r" or "OK\r" timeout 2 # Ignore modem response.
        send "ATE0Q1\r" # Initialize modem: Echo OFF,
        # Disable responses.

        ignore "\0\r" timeout 1
        done

condin: send "AT&FQ0T\r" # Reset to factory defaults.
        ignore "\0\r" or "OK\r\n" timeout 2 # Ignore modem response.
        send "ATE0T\r" # Initialize modem: Echo OFF,
        expect "\0\r" or "OK\r\n" timeout 2 # Enable responses (Numeric),
        send "ATQ0V0X0T\r" # Limit response codes.
        expect "\0\r" timeout 2 # Confirm commands successful.
        send "ATS0=2\r" # Set AutoAnswer ON
        expect "\0\r" timeout 2 # Confirm command successful.
        send "AT&C1&D2\r" # Detect carrier and DTR.
        expect "\0\r" timeout 2 # Confirm command successful.
        done

waitcall: ignore "2\r" timeout 1 # Ignore first ring.
        expect "2\r" timeout 10 # Pick up second ring
        # or timeout.
        # Expect a connection response.
        expect "16\r" or "15\r" or "14\r" or "12\r" or "10\r" or "5\r" or "1\r"

```

```

timeout 60
done

page:      send "ATDT%N,,,%R;\r"          # %N = pager call center number
                                                # Add enough commas to wait for
                                                # time to enter paging number.
                                                # %R = paging number

                                                # Confirm successful command.

expect "0\r" timeout 60
delay 2                                         # Wait before hanging up.
send "ATH0\r"                                  # Hang up.
expect "0\r" timeout 2                         # Confirm successful command.
done

ripo:     send "AT&FQ0\r"                   # Reset to factory defaults.
ignore "0\r" or "OK\r\n" timeout 2            # Ignore modem response.
send "ATE0\r"                                  # Initialize modem: Echo OFF,
expect "0\r" or "OK\r\n" timeout 2            # Enable responses (Numeric),
send "ATQ0V0X0\r"                             # Limit response codes.
expect "0\r" timeout 2                         # Confirm commands successful.
send "ATS0=0\r"                                # Set AutoAnswer OFF
expect "0\r" timeout 2                         # Confirm command successful.
send "AT&C1&D2\r"                             # Detect carrier and DTR.
expect "0\r" timeout 2                         # Confirm command successful.
done                                           # RI Power On enabled.

error:                                         # Handle unexpected modem
                                                # responses.

expect "8\r" or "7\r" or "6\r" or "4\r" or "3\r"
delay 2
done

```

## Sample File modem\_f0.cfg

```

#
# COMPONENT_NAME: (ESPSETUP) ENTRY SERVICE PROCESSOR SETUP F0
#
# FUNCTIONS: Modem configuration file for many recent Hayes* compatible modems.
# This example uses the AT&F0 reset command to choose the factory defaults.
# This set up is preferred for modems with extended (&) commands. For early
# vintage modems, setup Z or Z0 is recommended. If your modem responds to
# the extended (&) commands and to factory default choices (&Fn), but doesn't
# work properly with this setup file, setup F1 is recommended.
#
# * Trademark of Hayes Microcomputer Products, Inc.
#
# (C) COPYRIGHT International Business Machines Corp. 1996
# All Rights Reserved
# Licensed Materials - Property of IBM
#
# US Government Users Restricted Rights - Use, duplication or
# disclosure restricted by GSA ADP Schedule Contract with IBM Corp.
#
#
# If the modem has configuration switches, they should be set to the

```

```

# factory default settings.

ICDelay 1
DefaultT0 10
CallDelay 120
# AT Attention Code , Inserts delay in dialing commands
# &F0 Reset. Restore profile 0 Q0 Turn on responses
# E0 Turn echo off Q1 Turn off responses
# V0 Use numeric responses S0=0 Automatic answer inhibit
# +++ Escape to command mode S0=2 Answer on second ring
# H0 Hang-up X0=0 Limit modem response codes
# T = Tone mode. When used as T\r, it is a
# no op to maintain program synchronization
# when modem may/will echo the commands.
#
# &C1 Detect CD &D2 Respond to DTR (often the default)
# &R1 Ignore RTS (CTS)
#
# %N Call-Out phone number %P Paging phone number
# %S Modem speed (available to users)
#
# Following are common responses from a wide range of modems:
# 16, 15, 12, 10, 5 and 1 are connection responses. Add others as required.
# 7=busy; 6=no dial tone; 4=error; 3=no carrier; 2=ring; 0=OK
#
# PROGRAMMING NOTE: No blanks between double quote marks (").

condout: send "AT&F0Q0T\r" # Reset modem. Select profile 0
         ignore "\r" or "OK\r\n" timeout 2 # Ignore modem response.
         send "ATE0T\r" # Initialize modem: Echo OFF,
         expect "\r" or "OK\r\n" timeout 2 # Enable responses (Numeric),
         send "ATQ0V0X0T\r" # Limit response codes.
         expect "\r" timeout 2 # Confirm commands successful.
         send "ATS0=0\r" # Set AutoAnswer OFF
         expect "\r" timeout 2 # Confirm command successful.
         send "AT&C1&D2&R1\r" # Detect carrier and DTR,
                                # Ignore RTS.
         expect "\r" timeout 2 # Confirm command successful.
         done

connect: send "ATDT%N\r" # Tone dialing command.
                                # %N from Call Home setup.

                                # Expect a connection response.
         expect "16\r" or "15\r" or "14\r" or "12\r" or "10\r" or "5\r" or "1\r" busy "7\r"
         timeout 60
         done

retry: send "A/" # Repeat the previous command.

                                # Expect a connection response.
         expect "16\r" or "15\r" or "14\r" or "12\r" or "10\r" or "5\r" or "1\r" busy "7\r"
         timeout 60
         done

```

```

disconnect:
    delay 2
    send "+++"
    delay 2
    send "ATH0T\r"

    ignore "\0\r" or "OK\r" timeout 2
    send "ATE0Q1\r"

    ignore "\0\r" timeout 1
done

conдин:
    send "AT&F0Q0T\r"
    ignore "\0\r" or "OK\r\n" timeout 2
    send "ATE0T\r"
    expect "\0\r" or "OK\r\n" timeout 2
    send "ATQ0V0X0T\r"
    expect "\0\r" timeout 2
    send "ATS0=2\r"
    expect "\0\r" timeout 2
    send "AT&C1&D2&R1\r"

    expect "\0\r" timeout 2
done

waitcall:
    ignore "2\r" timeout 1
    expect "2\r" timeout 10

    expect "16\r" or "15\r" or "14\r" or "12\r" or "10\r" or "5\r" or "1\r"
    timeout 60
done

page:
    send "ATDT%N,,,,%R;\r"

    expect "\0\r" timeout 60
    delay 2
    send "ATH0T\r"
    expect "\0\r" timeout 2
done

riпо:
    send "AT&F0Q0T\r"
    ignore "\0\r" or "OK\r\n" timeout 2
    send "ATE0T\r"
    expect "\0\r" or "OK\r\n" timeout 2
    send "ATQ0V0X0T\r"
    expect "\0\r" timeout 2
    send "ATS0=0\r"
    expect "\0\r" timeout 2
    send "AT&C1&D2&R1\r"

```

```

# Separate from previous data.
# Assure command mode.
# Allow mode switching delay.
# Set modem switch-hook down
# (i.e., hang up).
# Ignore modem response.
# Initialize modem: Echo OFF,
# Disable responses.

```

```

# Reset modem. Select profile 0
# Ignore modem response.
# Initialize modem: Echo OFF,
# Enable responses (Numeric),
# Limit response codes.
# Confirm commands successful.
# Set AutoAnswer ON
# Confirm command successful.
# Detect carrier and DTR,
# Ignore RTS.
# Confirm command successful.

```

```

# Ignore first ring.
# Pick up second ring
# or timeout.
# Expect a connection response.

```

```

# %N = pager call center number
# Add enough commas to wait for
# time to enter paging number.
# %R = paging number

```

```

# Confirm successful command.
# Wait before hanging up.
# Hang up.
# Confirm successful command.

```

```

# Reset modem. Select profile 0
# Ignore modem response.
# Initialize modem: Echo OFF,
# Enable responses (Numeric),
# Limit response codes.
# Confirm commands successful.
# Set AutoAnswer OFF
# Confirm command successful.
# Detect carrier and DTR,
# Ignore RTS.

```



```

        expect "0\r" timeout 2          # Confirm command successful.
        done                            # RI Power On enabled.

error:                                     # Handle unexpected modem
                                           # responses.
        expect "8\r" or "7\r" or "6\r" or "4\r" or "3\r"
        delay 2
        done

```

## Sample File modem\_f1.cfg

```

#
# COMPONENT_NAME: (ESPSETUP) ENTRY SERVICE PROCESSOR SETUP F1
#
# FUNCTIONS: Modem configuration file for many recent Hayes* compatible modems.
# This example uses the AT&F1 reset command to choose the factory defaults.
# This set up is for modems with extended (&) commands and which do not work
# properly with setup F0. For early vintage modems, setup Z or Z0 is
# recommended.
#
# * Trademark of Hayes Microcomputer Products, Inc.
#
# (C) COPYRIGHT International Business Machines Corp. 1996
# All Rights Reserved
# Licensed Materials - Property of IBM
#
# US Government Users Restricted Rights - Use, duplication or
# disclosure restricted by GSA ADP Schedule Contract with IBM Corp.
#
#
# If the modem has configuration switches, they should be set to the
# factory default settings.

ICDelay 1
DefaultT0 10
CallDelay 120
# AT Attention Code , Inserts delay in dialing commands
# &F1 Reset. Restore profile 1 Q0 Turn on responses
# E0 Turn echo off Q1 Turn off responses
# V0 Use numeric responses S0=0 Automatic answer inhibit
# +++ Escape to command mode S0=2 Answer on second ring
# H0 Hang-up X0=0 Limit modem response codes
# T = Tone mode. When used as T\r, it is a
# no op to maintain program synchronization
# when modem may/will echo the commands.
#
# &C1 Detect CD &D2 Respond to DTR (often the default)
# &R1 Ignore RTS (CTS)
#
# %N Call-Out phone number %P Paging phone number
# %S Modem speed (available to users)
#
# Following are common responses from a wide range of modems:
# 16, 15, 12, 10, 5 and 1 are connection responses. Add others as required.
# 7=busy; 6=no dial tone; 4=error; 3=no carrier; 2=ring; 0=OK
#

```

```

# PROGRAMMING NOTE: No blanks between double quote marks (").

condout:  send "AT&F1Q0T\r"           # Reset modem. Select profile 1
          ignore "\0\r" or "OK\r\n" timeout 2 # Ignore modem response.
          send "ATE0T\r"             # Initialize modem: Echo OFF,
          expect "\0\r" or "OK\r\n" timeout 2 # Enable responses (Numeric),
          send "ATQ0V0X0T\r"        # Limit response codes.
          expect "\0\r" timeout 2     # Confirm commands successful.
          send "ATS0=0\r"            # Set AutoAnswer OFF
          expect "\0\r" timeout 2     # Confirm command successful.
          send "AT&C1&D2&R1\r"       # Detect carrier and DTR,
                                     # Ignore RTS.
          expect "\0\r" timeout 2     # Confirm command successful.
          done

connect:  send "ATDT%N\r"            # Tone dialing command.
                                     # %N from Call Home setup.

          # Expect a connection response.
          expect "16\r" or "15\r" or "14\r" or "12\r" or "10\r" or "5\r" or "1\r" busy "7\r"
          timeout 60
          done

retry:    send "A/"                  # Repeat the previous command.

          # Expect a connection response.
          expect "16\r" or "15\r" or "14\r" or "12\r" or "10\r" or "5\r" or "1\r" busy "7\r"
          timeout 60
          done

disconnect: delay 2                  # Separate from previous data.
            send "+++"                # Assure command mode.
            delay 2                  # Allow mode switching delay.
            send "ATH0T\r"           # Set modem switch-hook down
                                     # (i.e., hang up).
            ignore "\0\r" or "OK\r" timeout 2 # Ignore modem response.
            send "ATE0Q1\r"          # Initialize modem: Echo OFF,
                                     # Disable responses.

            ignore "\0\r" timeout 1
            done

condin:   send "AT&F1Q0T\r"           # Reset modem. Select profile 1
          ignore "\0\r" or "OK\r\n" timeout 2 # Ignore modem response.
          send "ATE0T\r"             # Initialize modem: Echo OFF,
          expect "\0\r" or "OK\r\n" timeout 2 # Enable responses (Numeric),
          send "ATQ0V0X0T\r"        # Limit response codes.
          expect "\0\r" timeout 2     # Confirm commands successful.
          send "ATS0=2\r"            # Set AutoAnswer ON
          expect "\0\r" timeout 2     # Confirm command successful.
          send "AT&C1&D2&R1\r"       # Detect carrier and DTR,
                                     # Ignore RTS.
          expect "\0\r" timeout 2     # Confirm command successful.
          done

```

```

waitcall: ignore "2\r" timeout 1           # Ignore first ring.
        expect "2\r" timeout 10          # Pick up second ring
                                           # or timeout.
                                           # Expect a connection response.
expect "16\r" or "15\r" or "14\r" or "12\r" or "10\r" or "5\r" or "1\r"
timeout 60
        done

page:    send "ATDT%N,,,,%R;\r"          # %N = pager call center number
                                           # Add enough commas to wait for
                                           # time to enter paging number.
                                           # %R = paging number

                                           # Confirm successful command.
        expect "0\r" timeout 60
        delay 2                          # Wait before hanging up.
        send "ATH0T\r"                   # Hang up.
        expect "0\r" timeout 2           # Confirm successful command.
        done

rip0:    send "AT&F1Q0T\r"                # Reset modem. Select profile 1
        ignore "0\r" or "OK\r\n" timeout 2 # Ignore modem response.
        send "ATE0T\r"                   # Initialize modem: Echo OFF,
        expect "0\r" or "OK\r\n" timeout 2 # Enable responses (Numeric),
        send "ATQ0V0X0T\r"               # Limit response codes.
        expect "0\r" timeout 2           # Confirm commands successful.
        send "ATS0=0\r"                  # Set AutoAnswer OFF
        expect "0\r" timeout 2           # Confirm command successful.
        send "AT&C1&D2&R1\r"             # Detect carrier and DTR,
                                           # Ignore RTS.
        expect "0\r" timeout 2           # Confirm command successful.
        done                              # RI Power On enabled.

error:                                       # Handle unexpected modem
                                           # responses.
        expect "8\r" or "7\r" or "6\r" or "4\r" or "3\r"
        delay 2
        done

```



---

# Index

## Numerics

- 12/24GB 4mm Tape Drive
  - using 30
- 3.5-inch diskette drive
  - using 12
- 7135 RAIDiant array 142
- 7318 server service aid 143
- 8mm Tape Drive
  - using 23

## A

- about this book xv
- account number 58
- alter/display bootlist 126
- attributes required for TTY terminal 165

## B

- battery
  - disposal, recycling 159

## C

- call-in security 62
- call out 66
- call-out 57
  - policy 57
- CD-ROM drive
  - using 14
- check points 43, 51
- Configure Service Processor 120
- connectors 5
- console mirroring
  - enable/disable 46
  - quick disconnect 67
  - system configuration 67
- customer administration center 56

## D

- diagnostics
  - online 107
  - online diagnostics modes of operation 109
  - operating considerations 107
  - stand-alone 107
  - standalone diagnostics 112
  - TTY terminal attributes 165
- disk drive activity LED 4, 8
- display/alter bootlist 126

## E

- EPROM
  - updates 67
- Ethernet 5
- Ethernet port 5

## F

- fibre channel RAID service aids 131
- flash SK-NET FDDI firmware 132

## G

- general access password, changing 46
- general user menus 43
- graphical system management services 73

## H

- hardware problem determination 149
- headphone jack 4, 8
- heartbeat 65

## I

- Introducing system 1
- introducing tasks and service aids 113

## K

- keyboards
  - using 9

## L

- language selection 53
- laser compliance statement xii
- laser safety information xii
- local area network service aid 135
- log repair action service aid 135

## M

- menus
  - general user 43
  - privileged user 44
  - service processor 42
  - service processor call-in/call-out setup 54
  - service processor call-out policy setup 57
  - service processor customer account setup 58
  - service processor language selection 53
  - service processor menus
    - SMS 41
  - service processor reboot policy setup 58
  - service processor serial port selection 55
  - service processor serial port snoop setup 47
  - service processor serial port speed setup 55
  - service processor setup 45
  - service processor system information 50
  - service processor system power control 48
  - service processor telephone setup 56
  - support menus
    - service processor service aids 41
- microphone receptacle 4, 8

modem  
  configuration file selection 169  
  configurations 169  
  transfer 173  
modem\_f.cfg, sample file 180  
modem\_f0.cfg, sample file 182  
modem\_f1.cfg, sample file 185  
modem\_z.cfg, sample file 175  
modem\_z0.cfg, sample file 177  
mouse  
  using 10

## N

network service aid 135  
notices  
  laser compliance statement xii

## O

online diagnostics 107  
online publications xv  
operational phases, service processor  
  standby 70  
operator panel display 4, 8  
optical disk  
  laser compliance statement xii

## P

pager 56  
parallel port 5  
passwords  
  changing general-access password 46  
  changing privileged access password 46  
  overview 45  
port  
  keyboard 5  
  mouse 5  
POST errors  
  read 43  
power connector 5  
power-on LED 4, 8  
power-on methods 61  
power on switch, location 4  
power-on switch, location 8  
preface xv  
primary console 175  
privileged access password, changing 46  
privileged user menus 44  
problem determination  
  using the stand-alone or online diagnostics 149,  
  154  
  when unable to load diagnostics 154  
product disposal 159  
progress indicators 43, 51  
publications, online xv

## R

read system, POST errors 43, 51  
reading the operator panel display 8  
rear connector locations 5  
reboot recovery 58, 63  
recycling 159  
related publications xv  
remote latency 58  
remote timeout 58  
repair log service aid 135  
reset Service Processor 47  
reset switch 4, 8  
restart recovery 58, 63  
RETAIN 58  
retries 58  
ring indicator power-on 50  
run exercisers 136

## S

safety  
  laser compliance statement xii  
SCSI 138  
  bus analyzer 138  
  device identification and removal 139  
SCSI port 5  
security, call-in 62  
service aids 113, 114  
  7135 RAIDiant array 142  
  7318 service aid 143  
  add resource 114  
  AIX shell prompt 115  
  analyze adapter internal log 115  
  backup/restore media 115  
  call in/out setup 121  
  certify media 115  
  change hardware VPD 116  
  configure dials and LPFKeys 116  
  configure ISA adapter 117  
  configure reboot policy 117  
  configure remote maintenance policy 118  
  configure ring indicate 120  
  configure surveillance policy 123  
  create customized configuration diskette 123  
  delete resource 123  
  disk based diagnostic 141  
  disk to disk copy 124  
  display/alter bootlist 126  
  display/alter sector 125  
  display configuration and resource list 125  
  display firmware device node information 125  
  display hardware error report 125  
  display hardware VPD 125  
  display microcode level 130  
  display or change diagnostic run-time options 126  
  display previous diagnostic results 127

- service aids *(continued)*
    - display resource attributes 127
    - display service hints 128
    - display software product data 128
    - display system environmental sensors 128
    - display test patterns 130
    - download microcode 130
    - fibre channel RAID service aids 131
    - flash SK-NET FDDI firmware 132
    - format media 132
    - generic microcode download 134
    - local area network 135
    - log repair action 135
    - machine check error log 125
    - modem configuration 121
    - PCI RAID physical disk identify 136
    - periodic diagnostics 135
    - process supplemental media 136
    - ring indicate power on policy 120
    - run diagnostics 136
    - run error log analysis 136
    - run exercisers 136
    - save or restore hardware management policies 138
    - save or restore service processor configuration 138
    - SCSI bus analyzer 138
    - SCSI device identification and removal 139
    - SCSI tape drive 139
    - spare sector availability 141
    - SSA service aids 141
    - update system flash 142
    - update system or service processor flash 141
  - service center 56
  - service director feature
    - using 38
  - service mode
    - service processor procedures 71
  - service processor 42
  - service processor call-in security 62
  - service processor feature
    - using 38
  - Service Processor menu inactivity 42
  - service processor menus
    - accessing locally 42
    - accessing remotely 42
    - call-in/call-out 54
    - call-out policy 57
    - customer account 58
    - general user 43
    - language selection 53
    - menu inactivity 42
    - privileged user 44
    - reboot policy 58
    - restart policy 58
    - serial port selection 55
    - Serial Port Snoop Setup Menu 47
  - service processor menus *(continued)*
    - serial port speed setup 55
    - setup menu 45
    - supported menu options 42
    - system information 50
    - system power control 48
    - telephone number 56
  - service processor procedures in service mode 71
  - service provider 56
  - SP operational phases 69
  - SSA service aids 141
  - standalone diagnostics 107
  - start talk mode 46
  - starting the system unit 7
  - STBY 70
  - stopping the system unit 7
  - surveillance
    - failure 65
    - operating system 65
    - set parameters 46
    - system firmware 65
  - system administrator 56
  - system features 1
  - system information menu 50
  - system management services
    - graphical system management services 73
      - config 75
      - multiboot 76
      - utilities 79
    - text-based system management services 94
      - display configuration 94
      - select language 104
      - utilities 98
  - system phone number 57
  - system POST errors
    - read 43
  - system power-on methods 61
  - system unit
    - starting 7
    - stopping 7
  - system verification procedure 145
- ## T
- tablet 5
  - text-based system management services 94
  - trademarks xvi
  - transfer of a modem session 173
  - TTY terminal attributes required for diagnostics
    - general 165
- ## U
- unattended start mode, enable/disable 48
  - update system flash 142
  - using
    - system verification procedure 145

- using service director feature 38
- using service processor feature 38
- using the 12/24GB 4mm Tape Drive 30
- using the 3.5-inch diskette drive 12
- using the 8mm Tape Drive 23
- using the CD-ROM drive 14
- using the keyboards 9
- using the mouse 10
- using the service processor
  - service processor menus
    - SMS 41
  - support menus
    - service processor service aids 41

## **V**

- voice phone number 57



---

## Readers' Comments — We'd Like to Hear from You

RS/6000 44P Series Model 270  
User's Guide

Publication No. SA38-0573-02

Overall, how satisfied are you with the information in this book?

	Very Satisfied	Satisfied	Neutral	Dissatisfied	Very Dissatisfied
Overall satisfaction	<input type="checkbox"/>	<input type="checkbox"/>	<input type="checkbox"/>	<input type="checkbox"/>	<input type="checkbox"/>

How satisfied are you that the information in this book is:

	Very Satisfied	Satisfied	Neutral	Dissatisfied	Very Dissatisfied
Accurate	<input type="checkbox"/>	<input type="checkbox"/>	<input type="checkbox"/>	<input type="checkbox"/>	<input type="checkbox"/>
Complete	<input type="checkbox"/>	<input type="checkbox"/>	<input type="checkbox"/>	<input type="checkbox"/>	<input type="checkbox"/>
Easy to find	<input type="checkbox"/>	<input type="checkbox"/>	<input type="checkbox"/>	<input type="checkbox"/>	<input type="checkbox"/>
Easy to understand	<input type="checkbox"/>	<input type="checkbox"/>	<input type="checkbox"/>	<input type="checkbox"/>	<input type="checkbox"/>
Well organized	<input type="checkbox"/>	<input type="checkbox"/>	<input type="checkbox"/>	<input type="checkbox"/>	<input type="checkbox"/>
Applicable to your tasks	<input type="checkbox"/>	<input type="checkbox"/>	<input type="checkbox"/>	<input type="checkbox"/>	<input type="checkbox"/>

Please tell us how we can improve this book:

Thank you for your responses. May we contact you?  Yes  No

When you send comments to IBM, you grant IBM a nonexclusive right to use or distribute your comments in any way it believes appropriate without incurring any obligation to you.

---

Name

---

Address

---

Company or Organization

---

Phone No.

Readers' Comments — We'd Like to Hear from You  
SA38-0573-02



Cut or Fold  
Along Line

Fold and Tape

Please do not staple

Fold and Tape



NO POSTAGE  
NECESSARY  
IF MAILED IN THE  
UNITED STATES

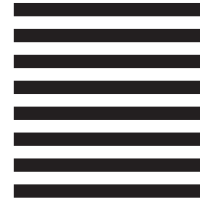

# BUSINESS REPLY MAIL

FIRST-CLASS MAIL PERMIT NO. 40 ARMONK, NEW YORK

POSTAGE WILL BE PAID BY ADDRESSEE

Information Development  
Department H6DS-9561  
11400 Burnet Road  
Austin, TX 78758-3493



Fold and Tape

Please do not staple

Fold and Tape

SA38-0573-02

Cut or Fold  
Along Line





Printed in the United States of America  
on recycled paper containing 10%  
recovered post-consumer fiber.

September 2001

SA38-0573-02

