



Sun™ Ultra™ 45 and Ultra 25 Workstations Getting Started Guide

Sun Microsystems, Inc.
www.sun.com

Part No. 819-1894-13
May 2006, Revision A

Submit comments about this document at: <http://www.sun.com/hwdocs/feedback>

Copyright 2006 Sun Microsystems, Inc., 4150 Network Circle, Santa Clara, California 95054, U.S.A. All rights reserved.

Sun Microsystems, Inc. has intellectual property rights relating to technology that is described in this document. In particular, and without limitation, these intellectual property rights may include one or more of the U.S. patents listed at <http://www.sun.com/patents> and one or more additional patents or pending patent applications in the U.S. and in other countries.

This document and the product to which it pertains are distributed under licenses restricting their use, copying, distribution, and decompilation. No part of the product or of this document may be reproduced in any form by any means without prior written authorization of Sun and its licensors, if any.

Third-party software, including font technology, is copyrighted and licensed from Sun suppliers.

Parts of the product may be derived from Berkeley BSD systems, licensed from the University of California. UNIX is a registered trademark in the U.S. and in other countries, exclusively licensed through X/Open Company, Ltd.

Sun, Sun Microsystems, the Sun logo, AnswerBook2, docs.sun.com, OpenBoot, Ultra, Java, and Solaris are trademarks or registered trademarks of Sun Microsystems, Inc. in the U.S. and in other countries.

All SPARC trademarks are used under license and are trademarks or registered trademarks of SPARC International, Inc. in the U.S. and in other countries. Products bearing SPARC trademarks are based upon an architecture developed by Sun Microsystems, Inc.

The OPEN LOOK and Sun™ Graphical User Interface was developed by Sun Microsystems, Inc. for its users and licensees. Sun acknowledges the pioneering efforts of Xerox in researching and developing the concept of visual or graphical user interfaces for the computer industry. Sun holds a non-exclusive license from Xerox to the Xerox Graphical User Interface, which license also covers Sun's licensees who implement OPEN LOOK GUIs and otherwise comply with Sun's written license agreements.



Sun Microsystems is an ENERGY STAR® partner. Those configurations of this product that bear the ENERGY STAR mark meet or exceed the ENERGY STAR guidelines.

U.S. Government Rights—Commercial use. Government users are subject to the Sun Microsystems, Inc. standard license agreement and applicable provisions of the FAR and its supplements.

DOCUMENTATION IS PROVIDED "AS IS" AND ALL EXPRESS OR IMPLIED CONDITIONS, REPRESENTATIONS AND WARRANTIES, INCLUDING ANY IMPLIED WARRANTY OF MERCHANTABILITY, FITNESS FOR A PARTICULAR PURPOSE OR NON-INFRINGEMENT, ARE DISCLAIMED, EXCEPT TO THE EXTENT THAT SUCH DISCLAIMERS ARE HELD TO BE LEGALLY INVALID.

Copyright 2006 Sun Microsystems, Inc., 4150 Network Circle, Santa Clara, Californie 95054, Etats-Unis. Tous droits réservés.

Sun Microsystems, Inc. a les droits de propriété intellectuels relatants à la technologie qui est décrit dans ce document. En particulier, et sans la limitation, ces droits de propriété intellectuels peuvent inclure un ou plus des brevets américains énumérés à <http://www.sun.com/patents> et un ou les brevets plus supplémentaires ou les applications de brevet en attente dans les Etats-Unis et dans les autres pays.

Ce produit ou document est protégé par un copyright et distribué avec des licences qui en restreignent l'utilisation, la copie, la distribution, et la décompilation. Aucune partie de ce produit ou document ne peut être reproduite sous aucune forme, par quelque moyen que ce soit, sans l'autorisation préalable et écrite de Sun et de ses bailleurs de licence, s'il y en a.

Le logiciel détenu par des tiers, et qui comprend la technologie relative aux polices de caractères, est protégé par un copyright et licencié par des fournisseurs de Sun.

Des parties de ce produit pourront être dérivées des systèmes Berkeley BSD licenciés par l'Université de Californie. UNIX est une marque déposée aux Etats-Unis et dans d'autres pays et licenciée exclusivement par X/Open Company, Ltd.

Sun, Sun Microsystems, le logo Sun, AnswerBook2, docs.sun.com, OpenBoot, Ultra, Java, et Solaris sont des marques de fabrique ou des marques déposées de Sun Microsystems, Inc. aux Etats-Unis et dans d'autres pays.

Toutes les marques SPARC sont utilisées sous licence et sont des marques de fabrique ou des marques déposées de SPARC International, Inc. aux Etats-Unis et dans d'autres pays. Les produits portant les marques SPARC sont basés sur une architecture développée par Sun Microsystems, Inc.

L'interface d'utilisation graphique OPEN LOOK et Sun™ a été développée par Sun Microsystems, Inc. pour ses utilisateurs et licenciés. Sun reconnaît les efforts de pionniers de Xerox pour la recherche et le développement du concept des interfaces d'utilisation visuelle ou graphique pour l'industrie de l'informatique. Sun détient une licence non exclusive de Xerox sur l'interface d'utilisation graphique Xerox, cette licence couvrant également les licenciés de Sun qui mettent en place l'interface d'utilisation graphique OPEN LOOK et qui en outre se conforment aux licences écrites de Sun.

LA DOCUMENTATION EST FOURNIE "EN L'ÉTAT" ET TOUTES AUTRES CONDITIONS, DECLARATIONS ET GARANTIES EXPRESSES OU TACITES SONT FORMELLEMENT EXCLUES, DANS LA MESURE AUTORISEE PAR LA LOI APPLICABLE, Y COMPRIS NOTAMMENT TOUTE GARANTIE IMPLICITE RELATIVE A LA QUALITE MARCHANDE, A L'APTITUDE A UNE UTILISATION PARTICULIERE OU A L'ABSENCE DE CONTREFAÇON.



Please
Recycle



Adobe PostScript

Setting Up the Sun Ultra 45 and Ultra 25 Workstations

This chapter includes information about the following topics:

- “Safety and Compliance Information” on page 1
- “Planning the Installation Process” on page 2
- “Shipping Kit Contents” on page 3
- “External System Description” on page 4
- “Connecting Cables” on page 6
- “Powering On” on page 7
- “Setting Up Preinstalled Software” on page 8
- “Powering Off” on page 11

Safety and Compliance Information

Read the document, *Important Safety Information for Sun Hardware Systems*, 816-7190. The document is included with the Sun Ultra™ 45 and Ultra 25 workstations.

More safety and compliance information can be found in the *Sun Ultra 45 and Ultra 25 Workstations Safety and Compliance Guide*, (819-2785). This guide is installed on the Sun Ultra 45 and Ultra 25 Workstations Hardware Documentation CD, (705-1341). This and all other Sun Sun Ultra 45 and Ultra 25 workstation documentation is available online at:

<http://www.sun.com/documentation/>

Planning the Installation Process

Use the following checklist as a process tool to assist you with installation of the Sun Ultra 45 and Ultra 25 workstations.

TABLE 1-1 Installation Process

Steps	Tasks	Reference
1.	Unpack the workstation and familiarize yourself with the workstation features.	“Shipping Kit Contents” on page 3. “External System Description” on page 4.
2.	Install any optional components. To install DIMMs, graphic accelerators, PCI cards, hard drives, diskette drives, tape drives, or DVD-ROM drives.	<i>Sun Ultra 45 and Ultra 25 Workstations Service and Diagnostics Manual</i> (819-1892) or the documents that ship with the components.
3.	Connect the workstation and external device cables.	“Cable Connections” on page 6.
4.	Power on the workstation.	“Powering On” on page 7.
5.	Answer the Solaris™ software prompts.	“Setting Up Preinstalled Software” on page 8.

Note – Refer to the *Sun Ultra 45 and Ultra 25 Workstations Service and Diagnostics Manual* (819-1892), found on the Sun Sun Ultra 45 and Ultra 25 Workstations Hardware Documentation CD (705-1341), or online at: <http://www.sun.com/documentation> prior to performing any service or maintenance.

Shipping Kit Contents

The following figure shows the contents of your system package, ensure that you have everything shown. If anything is missing, please contact your Sun sales representative.

Note – A monitor is optional and may or may not be included with your system. A monitor is required in order to complete the system setup.

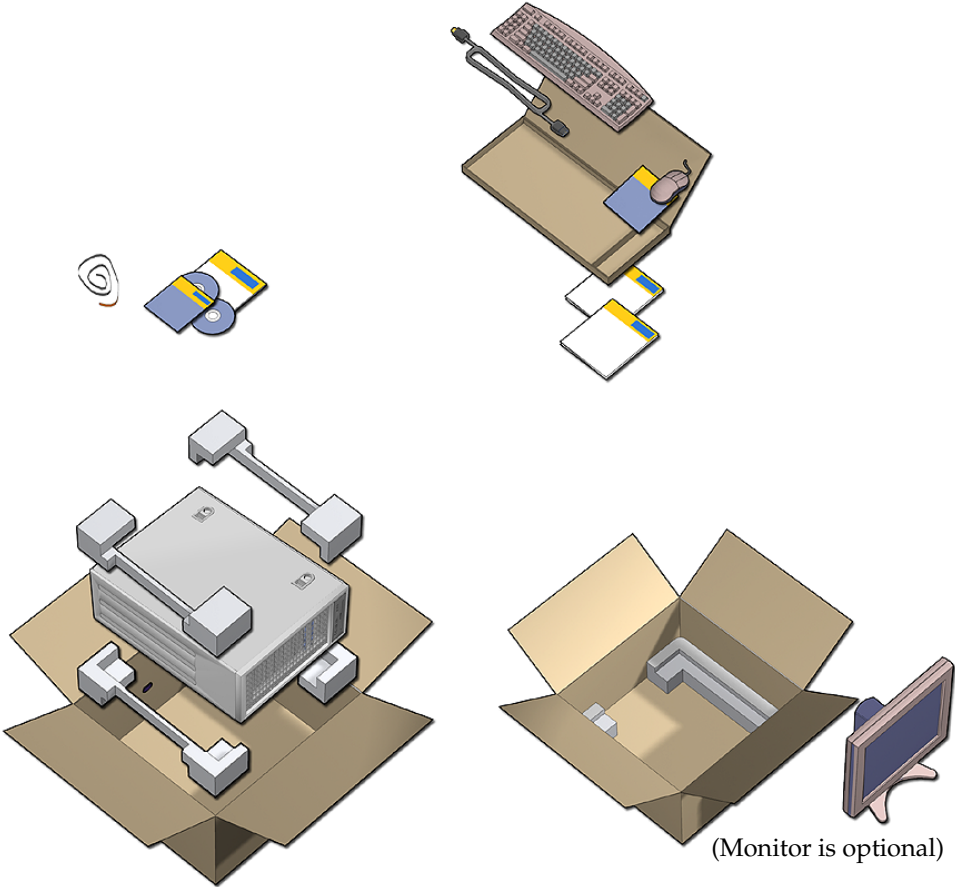

FIGURE 1-1 Sun Sun Ultra 45 and Ultra 25 Workstation Shipping Kit Contents

External System Description

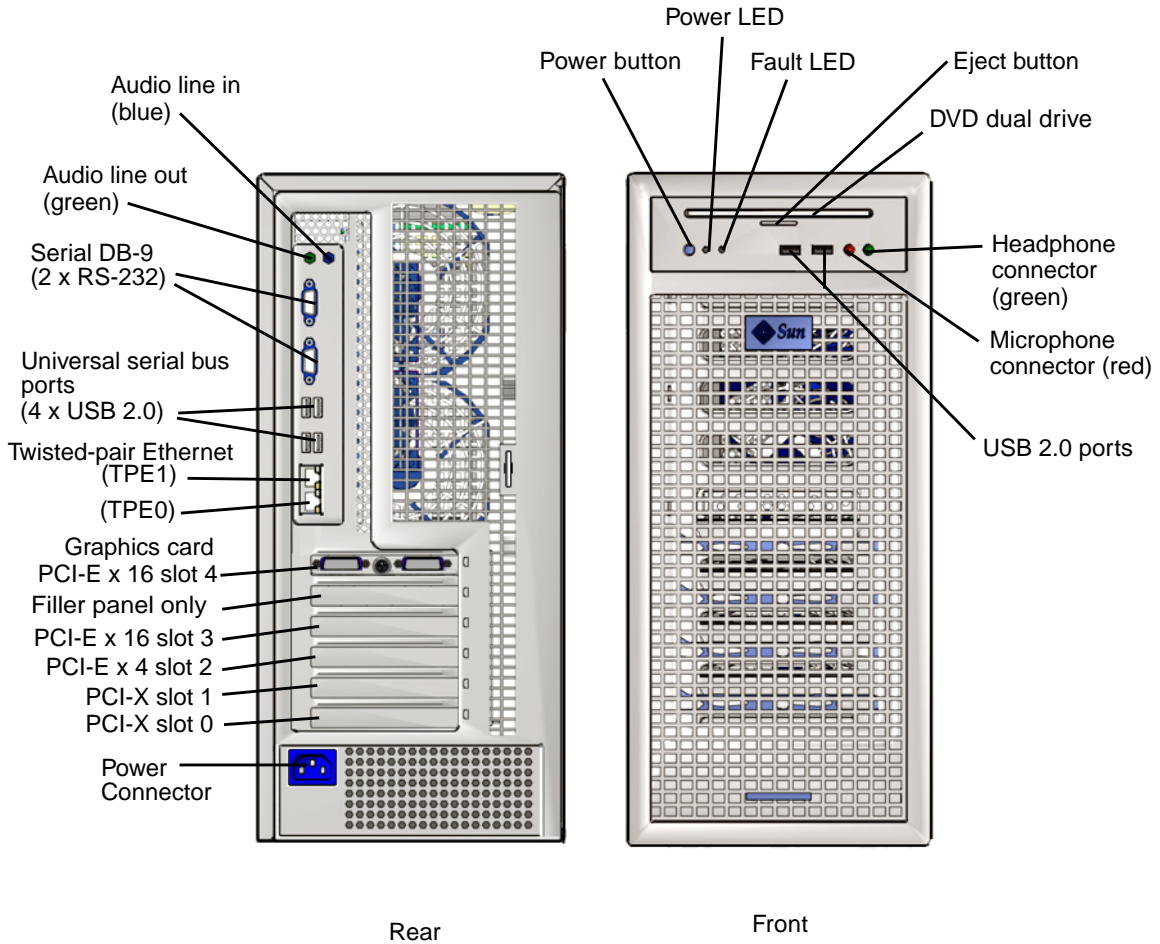

FIGURE 1-2 Rear and Front of the System

Setting up the System

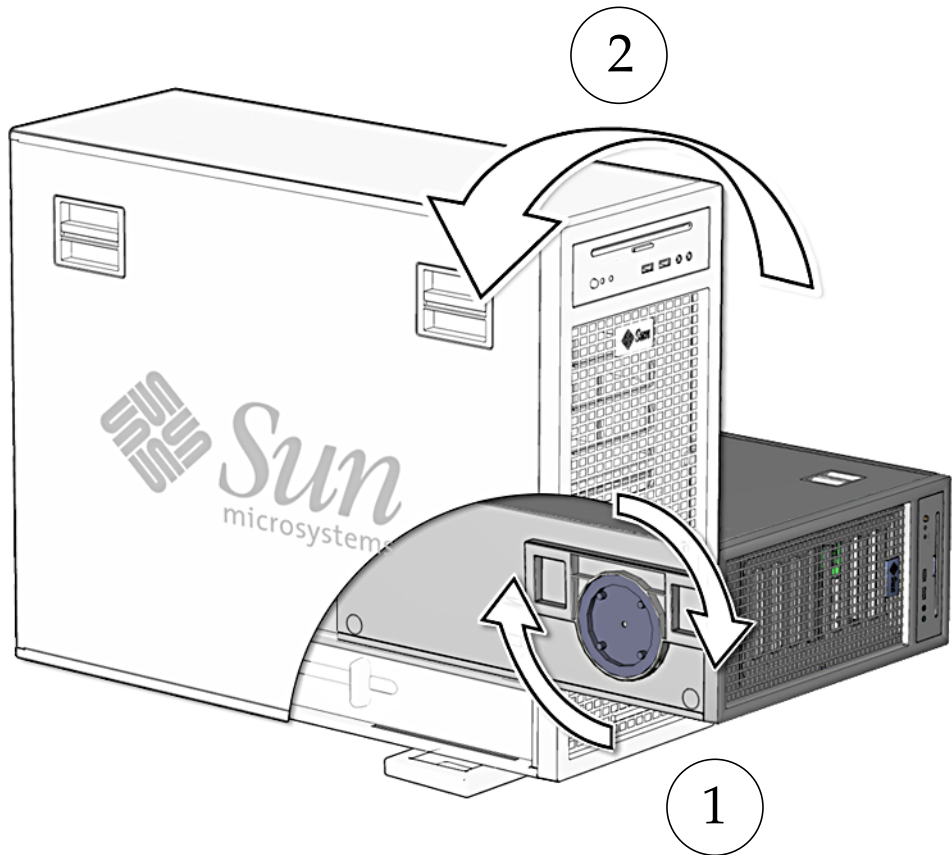

FIGURE 1-3 Setting Up the System Stabilizer

Connecting Cables

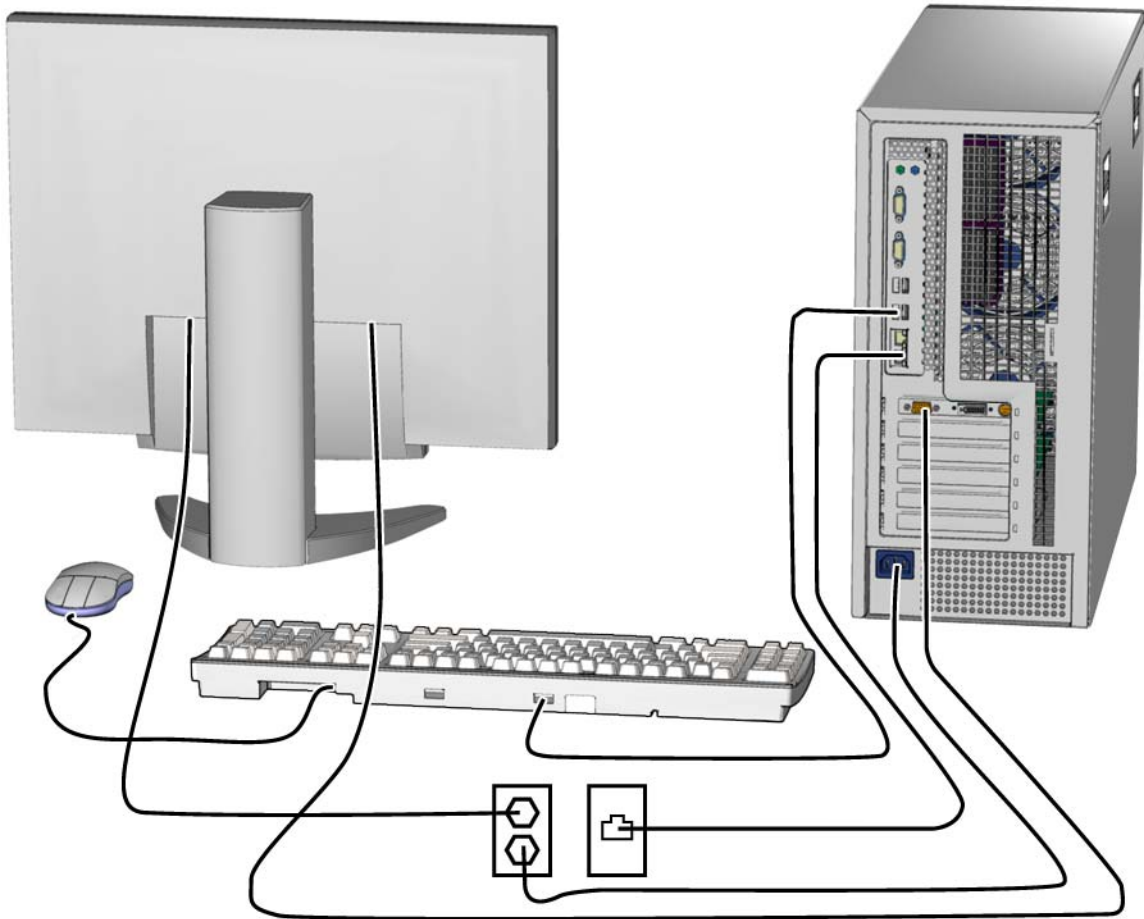

FIGURE 1-4 Cable Connections

Powering On

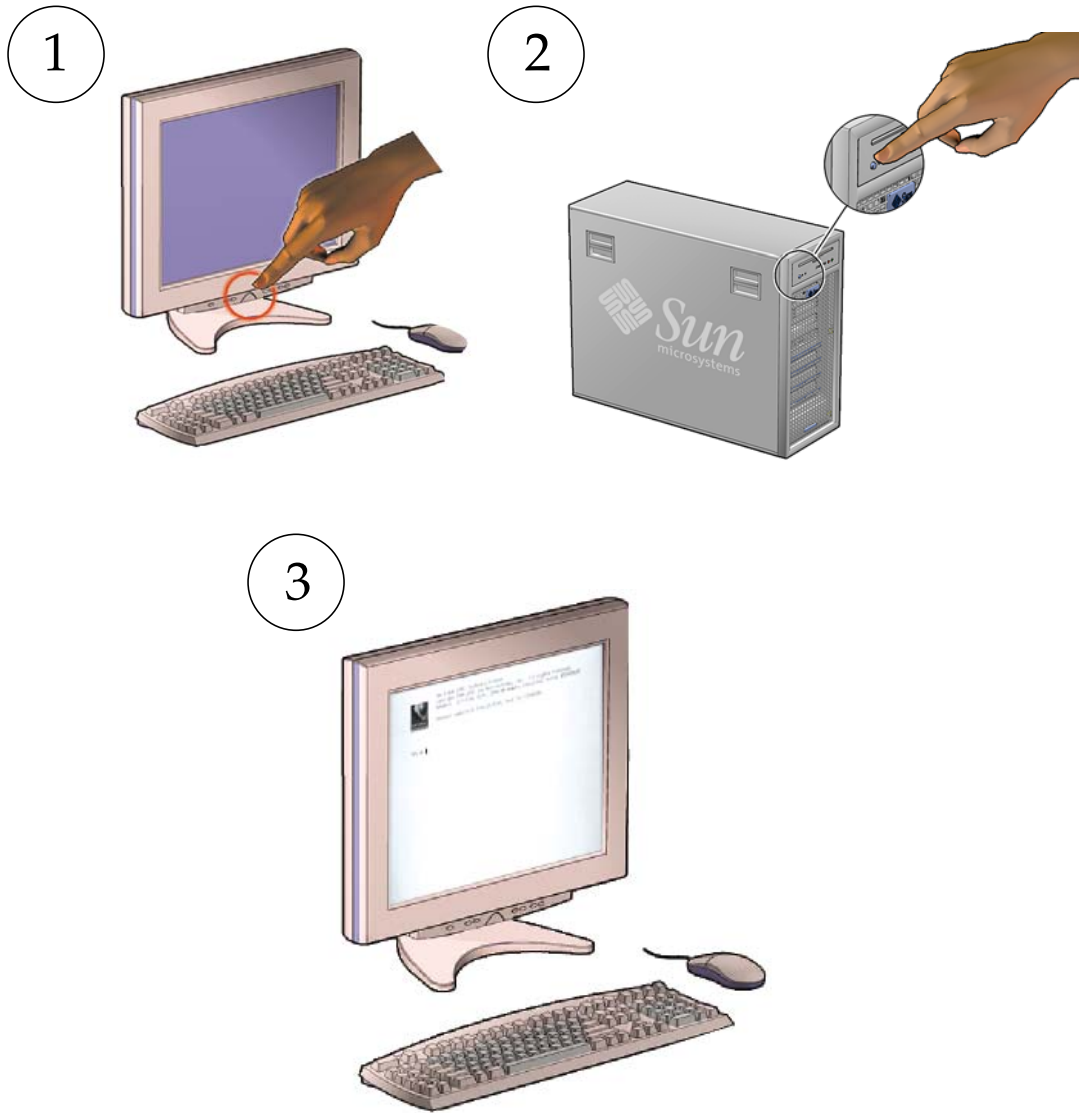

FIGURE 1-5 Powering On Sequence

Setting Up Preinstalled Software

To help answer the setup prompts, your system administrator (SA) should provide you with information specific to your site before you begin. Some of the information might be available on your network—check with your SA. For a networked system, use a copy of TABLE 1-2 to write down the information that you might need to collect before setting up the Solaris Operating System. For a standalone system, use a copy of TABLE 1-3 to write down the information that you might need to collect before setting up the Solaris Operating System.

TABLE 1-2 Information to Collect for A Networked Desktop Solaris Operating System

Solaris 10 Installation Window	Explanation and Notes	
Solaris License	Accept or decline the Solaris Operating System license.	
Solaris Release	Choose Solaris 10 Operating System release.	
Select Language and Locale	Native language and locale to use for the workstation.	
Host Name of Your Workstation	Select a name for the workstation.	
Host Name of Your Server	Obtain this information from your system administrator.	
Host IP Address of Your Name Server		
Network Connectivity Protocols: bge DHCP IPv6	Network or stand-alone workstation protocols. A system administrator might be required to complete this section. Note: Depending on how you answer the network connectivity prompts and what information is provided by your network, you might be prompted for the workstation's host IP address.	
Kerberos Security	Decline, or accept to setup Kerberos security.	

TABLE 1-2 (Continued) Information to Collect for A Networked Desktop Solaris Operating System

Solaris 10 Installation Window	Explanation and Notes	
Name Service (type)	Select a name service to use: NIS+, NIS, DNS, LDAP, or none. Note: This window is not displayed if the workstation is not connected to a network.	
Domain Name	Select NIS or NIS+ domain for this workstation. Note: This window is not displayed if the workstation is not using the NIS or NIS+ service.	
Name Server/ Subnet/ Subnet Mask	Specify the name server or have the workstation find a name server on a local subnet. Note: This window is not displayed if the workstation is not connected to a network.	
Time Zone	Select a local time zone by geographic region, GMT offset, or a time zone file.	

TABLE 1-3 Information to Collect for A Standalone Desktop Solaris Operating System

Solaris 10 Installation Window	Explanation and Notes	Your Information
Host Name of Your Workstation	Select a name for the workstation.	
Select Language and Locale	Native language and locale to use for the workstation.	
Time Zone	Select a local time zone by geographic region, GMT offset, or a time zone file.	
Date and Time	Select the current date and time (or accept the default or enter the current date and time).	
Root and Password	Enter a (superuser ID) and password.	

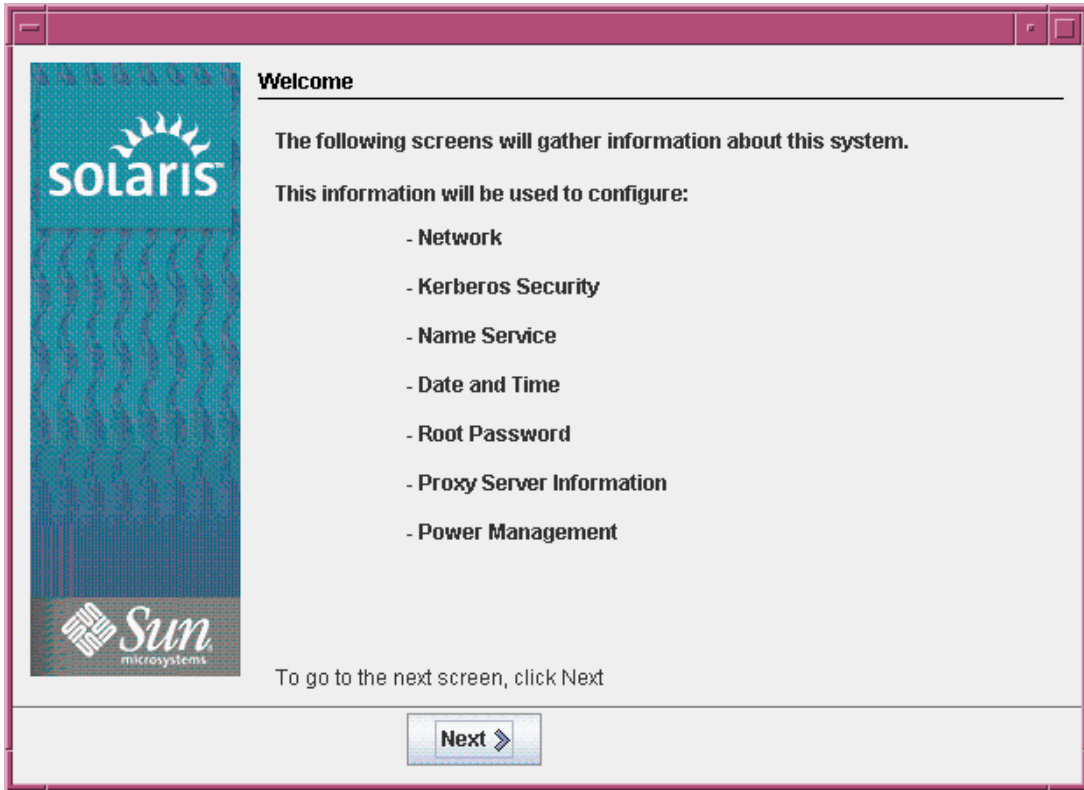
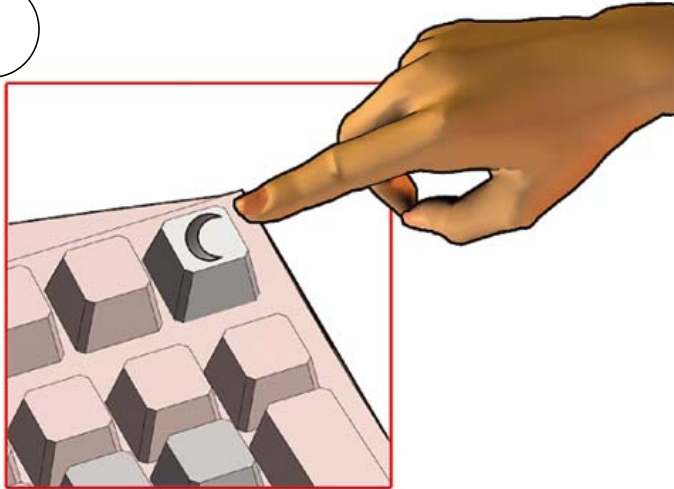

FIGURE 1-6 Solaris Operating System Welcome Screen

Powering Off

1



2



FIGURE 1-7 Powering Off Sequence

