

T A D P O L E

**SPARC** book® I  
User Guide



**SPARC** book<sup>®</sup> I

User Guide

---

## **FCC Class B Notice**

This equipment has been tested and found to comply with the limits for a Class B digital device, pursuant to Part 15 of the FCC rules. These limits are designed to provide reasonable protection against harmful interference in a residential installation. This equipment generates, uses and can radiate radio frequency energy and, if not installed and used in accordance with the instructions, may cause harmful interference to radio communications. However, there is no guarantee that interference will not occur in a particular installation. If this equipment does cause harmful interference to radio or television reception, which can be determined by turning the equipment off and on, the user is encouraged to try to correct the interference by one or more of the following measures:

- Reorient or relocate the receiving antenna
- Increase the separation between the equipment and receiver
- Connect the equipment into an outlet on a circuit different from that to which the receiver is connected
- Consult your supplier, or an experienced radio or television technician for help

## **Modifications**

This equipment contains no user-serviceable parts. You are advised that unauthorized changes or modifications to the equipment could cause it to exceed Class B limits and may void the authority granted by the FCC to operate the equipment.

## **Shielded Cables**

Connections between the SPARCbook and any connected peripherals must be made using shielded cables to maintain compliance with FCC radio frequency emission limits.

## **FCC Part 68 Modem Information**

This equipment complies with Part 68 of the FCC rules. On the underside of this equipment is a label that contains, among other information, the FCC registration number and ringer equivalence number (REN) for this equipment. If requested, this information must be provided to the telephone company.

This equipment uses the following USOC jacks: RJ11C

The REN is used to determine the quantity of devices which may be connected to the telephone line. Excessive RENs on the telephone line may result in the devices not ringing in response to an incoming call. In most, but not all areas, the sum of the RENs should not exceed five (5.0). To be certain of the number of devices that may be connected to the line, as determined by the total RENs, contact the telephone company to determine the maximum REN for the calling area.

If this equipment causes harm to the telephone network, the telephone company will notify you in advance that temporary discontinuance of service may be required. If advance notice is not practical, the telephone company will notify the customer as soon as possible. Also, you will be advised of your right to file a complaint with the FCC if you believe it is necessary.

The telephone company may make changes in its facilities, equipment, operations or procedures that could affect the operation of the equipment. If this happens, the telephone company will provide advance notice in order for you to make the necessary modifications in order to maintain uninterrupted service.

If trouble is experienced with this equipment, please contact Tadpole Technology Inc, 8310 Capital of Texas Highway North, Austin, Texas 78731 Tel: (512) 338 4221 for repair and/or warranty information. If the trouble is causing harm to the telephone network, the telephone company may request you remove the equipment from the network until the problem is resolved.

The following repairs can be done by the customer: None

This equipment cannot be used on telephone company-provided coin service. Connection to Party Line Service is subject to state tariffs.

#### Trademarks

All rights reserved. This product or document is protected by copyright and distributed under licenses restricting its use, copying, distribution and decompilation. No part of this product or document may be reproduced in any form by any means without prior written authorization of Sun and its licensors, if any. This product or the products depicted herein may be protected by one or more U.S. or international patents or pending patents. Portions of this product may be derived from the UNIX<sup>®</sup> and Berkeley 4.3 BSD systems, licensed from UNIX Systems Laboratories, Inc. and the University of California, respectively. Third party font software in this product is protected by copyright and licensed from Sun's Font Suppliers.

RESTRICTED RIGHTS LEGEND: Use, duplication, or disclosure by the government is subject to restrictions as set forth in subparagraph (c) (1) (ii) of the Rights in Technical Data and Computer Software clause at DFARS 252.227-7013 and FAR 52.227-19.

Sun, Sun Microsystems, the Sun Logo, OpenWindows, SunView, SunOS, X-11 NEWS, DeskSet, NFS and NEWS are trademarks or registered trademarks of Sun Microsystems, Inc. UNIX and OPEN LOOK are registered trademarks of UNIX Systems Laboratories, Inc. All other product names mentioned herein are the trademarks of their respective owners. All SPARC trademarks, including the SCD Compliant Logo, are trademarks or registered trademarks of SPARC International, Inc. The SPARCbook trademark is licensed exclusively to Tadpole Technology, Inc. Products bearing SPARC trademarks are based upon an architecture developed by Sun Microsystems, Inc.

The OPEN LOOK<sup>®</sup> and Sun<sup>™</sup> Graphical User Interfaces were developed by Sun Microsystems, Inc. for its users and licensees. Sun acknowledges the pioneering efforts of Xerox in researching and developing the concept of visual or graphical user interfaces for the computer industry. Sun holds a non-exclusive license from Xerox to the Xerox Graphical User Interface, which license also covers Sun's licensees who implement OPEN LOOK GUI's and otherwise comply with Sun's written license agreements.

The X Window System is a product of the Massachusetts Institute of Technology.

UNIX and OPEN LOOK are registered trademarks of UNIX System Laboratories  
PostScript is a trademark of Adobe Systems, Inc  
Sendfax is a registered trademark of Sierra Semiconductor Corp  
SoftPC is a registered trademark of Insignia Solutions Ltd

Issue 1 of January 1992  
Part Number: 980 001

©1992 by Tadpole Technology  
Printed in the UK



---

# CONTENTS

## **Introduction to the Guide**

- User Guide Summary
- Other Documentation
- Typographic Conventions

## **Introduction to SPARCbook**

- Getting Started
- Connecting the Main Supply
- Switching On and Off
- System Startup
- The Mousekey

## **Configuring and Using the SPARCbook**

- Basic System Configuration
- Accounts and Passwords
- The Deskset User Interface
- Power Management and Batteries
- Using Floppy Disks
- Connecting to a Printer
- Connecting to the Network
- Connecting to other Devices
- The Internal Modem

---

**DOS Emulation - SoftPC**

**Backup and Restore Facilities**

**Running SPARC Applications Software**

**Customizing the SPARCbook Solaris Operating System**

Using the CD

Solaris Packages

Unbundled Packages

**Technical Reference and Further Reading**

**Troubleshooting and Problems**

**Index**

---

This page deliberately left blank

---

---

# INTRODUCTION TO THE SPARCbook USER GUIDE

This guide is written and structured to be easy to use. It assumes a basic knowledge of computers and is intended to enable a user to quickly understand and be able to use the facilities provided in the SPARCbook notebook computer. You do not need to have used the UNIX Operating System to be able to follow this guide and to use the SPARCbook product. However, if you do not have experience of SUN or any other UNIX based computers , you are recommended to refer to the full SPARCbook documentation set available as an optional product from Tadpole Technology. Please contact your local sales office for further information.

---

The guide is separated into the following sections:

- **THIS INTRODUCTION**
- **INTRODUCTION TO SPARCbook**

Identifies the SPARCbook system components and explains how to unpack and initially set up the system. This section also tells you about charging the internal battery, running the system from the battery and the charger/adaptor, switching the system on and off, the keyboard, and the use of the Mousekey.

- **CONFIGURING AND USING THE SPARCbook**

Provides information on starting up the system for the first time and setting it up for networked or non-networked operation. It provides an introduction to OpenWindows, the DeskSet applications and the SPARCbook power management tools. Connecting and configuring external devices, including printer, network, mouse, keyboard and a color monitor is described. Finally, configuring and using the internal modem for Fax and data communication is explained.

- **DOS EMULATION**

Describes how to use the DOS emulation software packaged with the SPARCbook system which allows it to emulate an 80386 VGA notebook computer, giving access to the existing PC notebook software base.

- **BACKING UP AND RESTORING THE DISK SOFTWARE**

Explains how to make a complete backup of the supplied software in case of data loss, and how to restore it back onto the disk. It is recommended that this backup is taken at the earliest possible time unless you have access to Compact Disc (CD) facilities, or a copy of the Operating System on Floppy Disk has been purchased with your system.

---

- **RUNNING APPLICATIONS SOFTWARE ON SPARCbook**

Describes how to install and run third party SPARC applications on the SPARCbook. While all SPARC Compliance Definition (SCD) applications and many other applications for other SPARC platforms will run unmodified, there are some hardware differences between the SPARCbook and other SPARC platforms which can affect the way applications are set up and run. This section discusses the hardware differences and gives information on the graphics compatibility modes provided to allow color applications to run on monochrome or color SPARCbook models.

- **CUSTOMIZING THE SOLARIS OPERATING SYSTEM**

Explains how to customize the Solaris Operating System to meet your own requirements. As shipped the Solaris 1.0.1 Operating System for SPARCbook is a subset of the complete OS version. This section describes the bundled packages and explains how to add or remove packages to create your own customized version of the Operating System.

- **TECHNICAL REFERENCE AND FURTHER READING**

Provides technical specifications and information on the SPARCbook computer and interfaces, including connector pinouts and cable details. It also provides a complete list of all the available technical documentation available from Tadpole and from third party publishers covering the SPARCbook software. A summary of each manual is provided as a guide to help you select the ones you need.

- **TROUBLESHOOTING AND PROBLEMS**

Gives a guide on what to do if things do not happen as you expect. This section provides a troubleshooting guide and information on how to tell what is wrong, as well as information on support services and hotlines to provide further assistance.

---

## ***OTHER DOCUMENTATION***

---

The SPARCbook computer provides the power of a multi-user workstation system in a notebook format. The complete documentation set covering all the software for SPARCbook consists of 50 volumes of software guides, reference manuals, tutorials and other documentation. These detailed reference manuals provide information on the UNIX Operating System, the X Window system and the OPEN LOOK Graphical User Interface (GUI).

While this guide is intended to provide the SPARCbook user with basic information on the computer and how to configure it for normal operation, it is not intended to provide complete documentation on the Operating System software provided with the SPARCbook. The section on Further Reading at the end of the guide describes each of the available technical manuals which are available from major third party publishers, and gives information on how to order each manual. Alternatively the entire set of documentation may be ordered as a separate product from your local SPARCbook Sales Office.

---

## ***TYPOGRAPHIC CONVENTIONS***

---

Several conventions are used throughout this guide. These allow you to distinguish easily between User Guide text, examples of the SPARCbook responses and screens, and those cases where examples are being given which require you to enter keystrokes or move the cursor on the SPARCbook.

*Italic font* is used for Topic titles and for emphasis. For example:

The Disk LED is *on* when internal hard disk drive is being accessed.

The SPARCbook user prompt, response or information on the screen is shown in one of two ways. Either a picture of all or part of the screen is shown, or courier font is used to show information that appears on the screen. Courier font is also used to describe system utilities and commands. For example:

The `mail` system will inform you when there is incoming mail from another user.

```
% you have mail
```

Bold courier font is used in examples to show what you type in a particular situation. For example:

To report the current time and date you should use the `date` command:

```
% date
```

Remember that in order to have the computer act upon your commands you should normally hit the Enter key at the end of each line. So, after typing **date** in the above example you would press the Enter key. Sometimes in the text you will be asked to press two keys. For example:

Type **Ctrl-d**

In this case you should press the Ctrl key down first and then, while holding the Ctrl key down, simultaneously press the D key (giving a lower case 'd').

Two key words are used throughout the guide to refer to often used OpenWindows operations. These are the words *Choose* and *Select*, and are always used with a Capital letter. Choose is used to describe choosing a menu option or a selection from an OpenWindows menu. Select is used to initiate an action on a selected item. These terms are described fully in 'Basic Operations' later.



---

Notes are used to give you additional information on a subject. For example a note may refer to another part of this Guide.

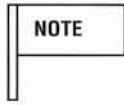

---

See Backing up the Software for further information.

---

Warnings are used to draw your attention to particular operating instructions which, if not heeded, may result in unexpected operation, data corruption or other adverse system behaviour. For example:



---

Do not attempt to install until you have followed the instructions below.

---

---

# INTRODUCTION TO SPARCBOOK

This Section provides an introduction to the SPARCbook system. It describes the basic system, identifies the various components and explains how to unpack and set up the product. It then describes the following basic operations:

- Opening the system
- Installing the battery
- Connecting the charger/adaptor
- Initially charging the battery
- Turning the system on and off
- The SPARCbook keyboard
- The Mousekey



---

The SPARCbook computer may be powered from the main supply or from the internal battery pack. Before operating from battery you must fully charge the battery pack. Information on charging the battery pack is provided in this section of the User Guide. You may use the system while the battery is being charged from the main supply.

---

---

## ***UNPACKING THE SPARCbook***

---

The SPARCbook system comes packaged in a single shipping carton. The packaging is in two sections and should contain the following items:

- This User Guide
- Bag with cables, license agreements, and other documentation
- SPARCbook unit
- Battery charger/adaptor
- Battery pack
- Protective carry case
- CD with Operating System software



---

You should read the license agreements before you open the bag with the cables. By opening the bag you agree to the terms of the license agreement allowing you to use the SPARCbook system software. If you do not accept the terms you may return the SPARCbook system unopened in its original packaging for a full refund.

---

The following cables are supplied:

- Battery charger/adaptor cable for country of purchase
- Centronics parallel interface cable
- Modem cable (USA model)



SPARCbook



Carry-Case

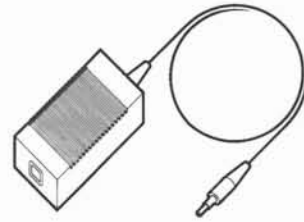

Charger/Adapter



Mains Supply Lead



CD-ROM OS



Phone Cable



Documents



Battery Pack

If you have ordered any optional items these will be shipped in a separate shipping carton with the appropriate documentation and packing list.

---

## ***OPENING THE SYSTEM***

---

Before opening the main system lid you should familiarize yourself with the outside of the system. The back of the system gives access to the I/O facilities and connectors behind a flap.

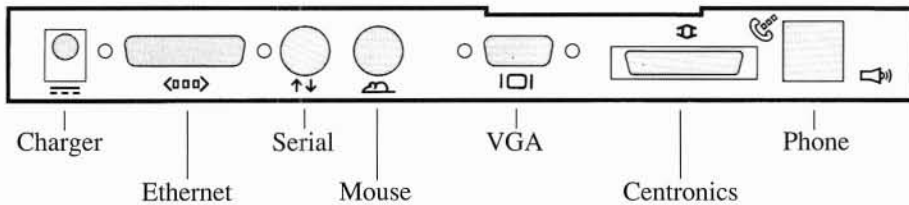
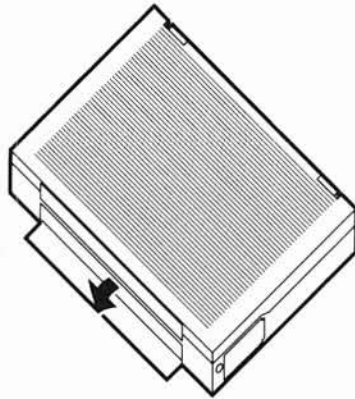

---

The system is opened by using your thumbs to slide the two lugs on the front of the unit outwards. Simultaneously lift the lid of the SPARCbook upwards and adjust to your preference.

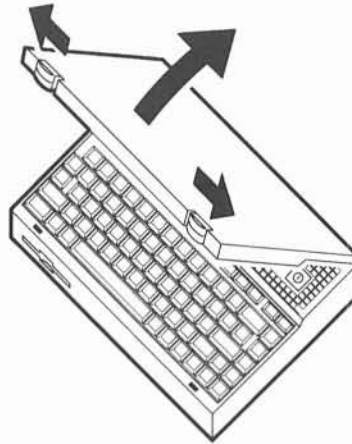

**NOTE**

The high resolution fast response color or paperwhite LCD display used in the SPARCbook has a limited viewing angle, in common with all LCD based products. For best results the SPARCbook should be positioned so that you are looking directly at the display during normal use.

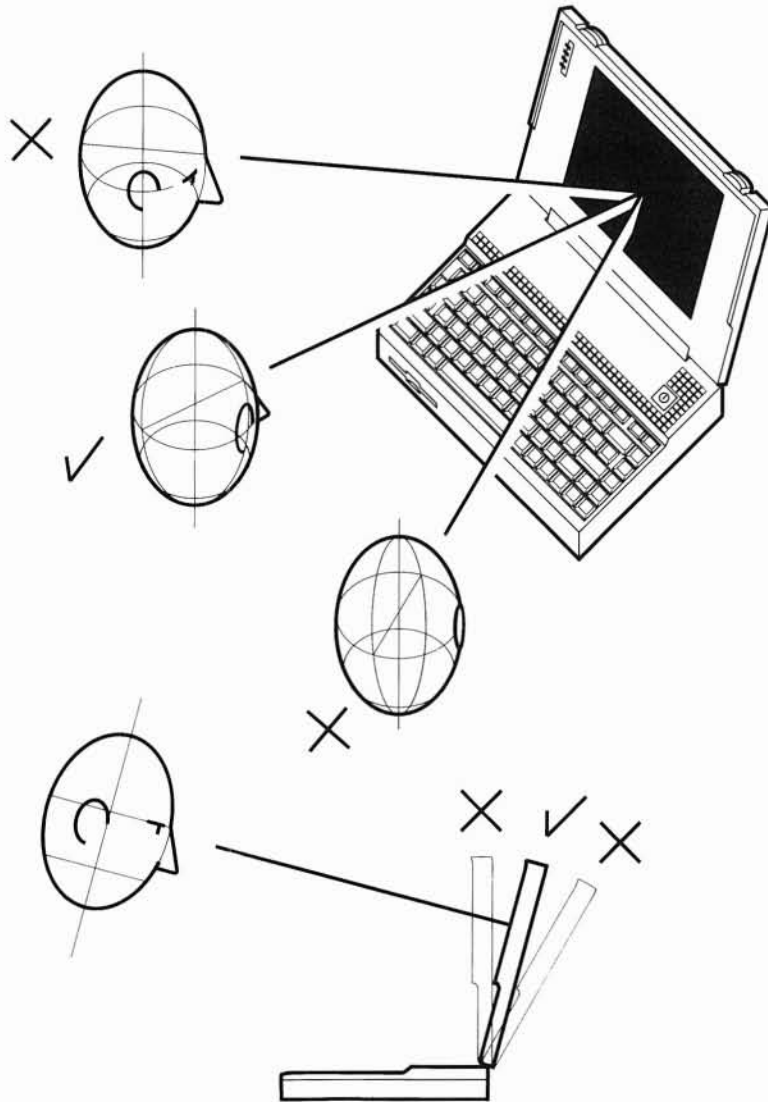

---

## ***INSTALLING THE BATTERY***

---

The SPARCbook is shipped with the battery packed separately. Before you first use the SPARCbook you will need to install the battery pack. To do this ensure that the system is closed and that the external supply is not connected. Use a coin to rotate the battery door button by a small angle (less than a quarter-turn) in the direction of the arrow, and simultaneously pull the packing strip outwards to open the door.

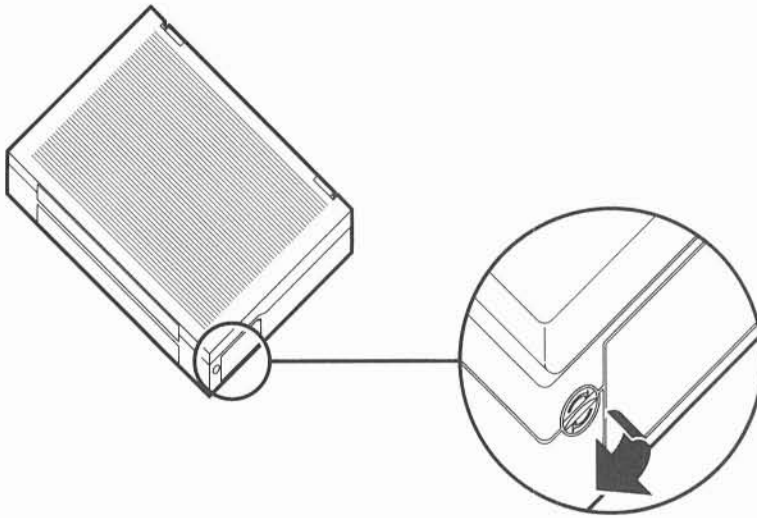

---

When shipping (as opposed to carrying) the SPARCbook it is advisable to remove the battery pack prior to shipment, to eliminate any possibility of damaging the battery contacts if the system is dropped.

---

**NOTE**

---

With the battery installed the battery door will open automatically under the pressure of the battery. When no battery is installed you will need to open the door manually, or by reusing the packing strip supplied.

---



---

To insert the battery ensure that the metal contacts are inserted into the system first, and that the battery is oriented correctly (it can only be inserted one way round). Insert the battery until it is level with the door, and close the battery door to seat it home finally . The door will automatically latch closed.

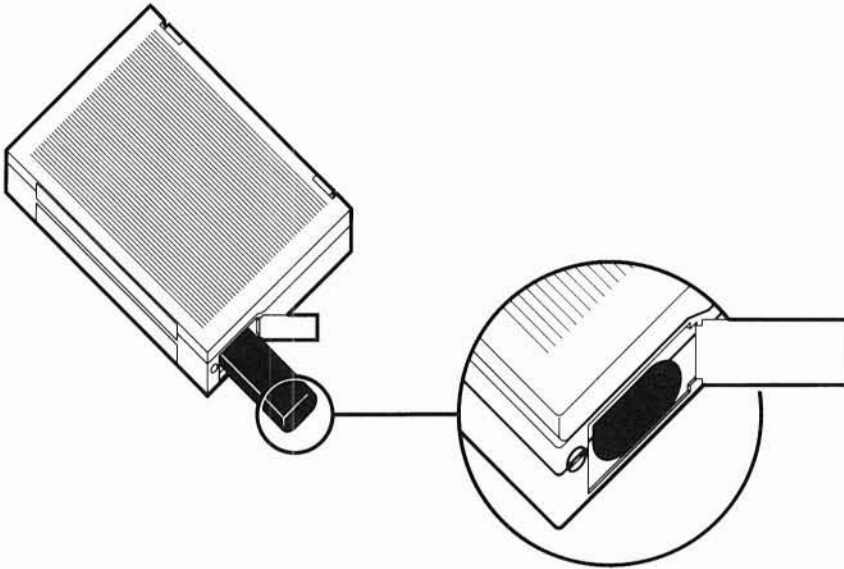

**NOTE**

---

You will not cause any damage to the SPARCbook by operating it from the external adaptor without a battery installed. However, in this case the external supply indicator on the SPARCbook will not be lit, even though the adaptor is being used.

---

---

## CONNECTING THE MAIN SUPPLY

---

As supplied the internal rechargeable battery in the SPARCbook requires fully charging before use. Therefore you must first connect the adaptor to the SPARCbook to charge the battery. You may use the computer while the battery is charging, but in this case the charging will take longer.

**NOTE**

- The typical charging time with the computer off is 2.5 hours
- The typical charging time with the computer *on* is 7 hours

First plug the charger/adaptor jack into the corresponding connector at the back of the SPARCbook system. Then plug the charger/adaptor cable into the 3 pin IEC connector on the SPARCbook charger/adaptor and into the wall socket or distribution panel as shown in the illustration.

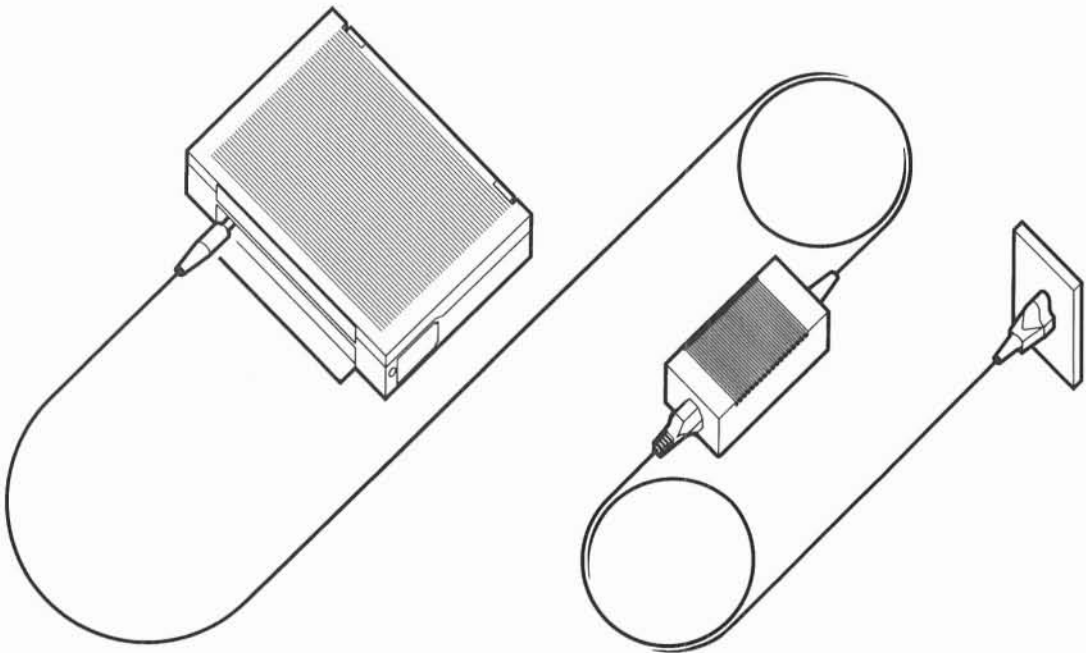

---

The green light on the Main Supply Adaptor should come on showing that the adaptor is operating and is charging the battery.

**NOTE**

The charger will only fast charge if you plug it into the SPARCbook and then into the main supply. If the main supply is already connected when the jack is plugged into the SPARCbook the battery will only trickle charge. In either case the SPARCbook will automatically detect when the battery is fully charged. You cannot do any damage to the computer by leaving the supply connected. Refer to 'Battery Charging' for further information.

---

---

## ***SWITCHING ON AND OFF***

---

The SPARCbook is switched on using the green ON switch above the keyboard. This is the only way of switching the SPARCbook on.

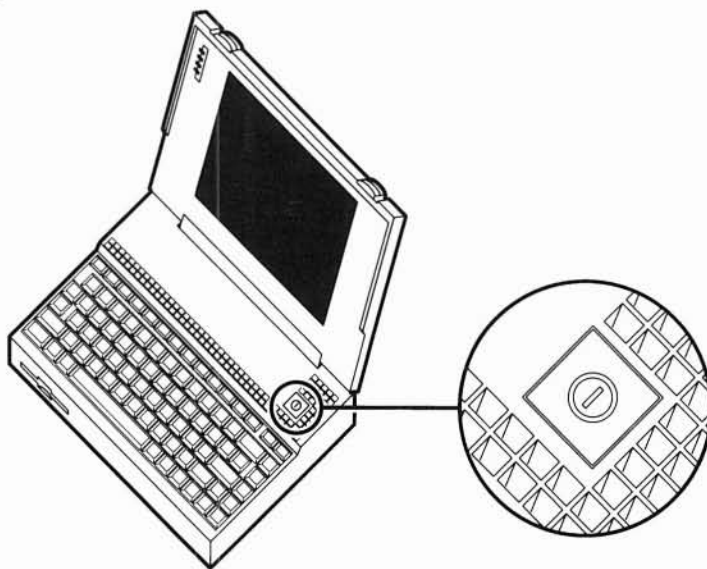

**NOTE**

The ON switch is only used to turn the SPARCbook ON. It does not turn the computer off. Nothing will happen if you press the switch while the system is running.

---

---

The SPARCbook has an automatic save and resume feature. It will automatically save the current state of the system (even in mid application) before powering down. The computer is switched off by pressing the *Alt*, *Esc* and *O* keys on the keyboard simultaneously. These keys are labelled in *Italics* to help you to remember the required keys. The SPARCbook will continue to operate with the disk spinning for 10-15 seconds (40-45 seconds for E models with 32Mb of memory). During this time the complete system state is being saved to the hard disk drive. The system will then beep for 1 second before powering down. The system is now off and can be moved or left. When the system is next switched on it will automatically restart from where it was turned off.



---

While the SPARCbook internal disk drive is specifically designed to be used in portable systems, it is advisable to keep the SPARCbook stationary while the disk is spinning. Sharp knocks to the system may result in damage to a running disk drive and possible unrecoverable loss of data.

---

If there is a hardware or software problem with the system it is possible that pressing **Alt-Esc-O** will not actually turn the system off. In this event it is possible to reset the system manually by using the reset key sequence of **Alt-Esc-R**. This will cause the system to be immediately reset and to restart the system software. Diagnostics and Automatic system checks will be carried out to ensure no corruption has occurred, and after the system has reinitialized the prompt for logging into the system should appear. You may then turn the system off in the normal way. Refer to 'Troubleshooting' for further information.

---

## ***SYSTEM STARTUP***

---

When the SPARCbook is switched on for the first time an automatic startup sequence is entered. The automatic startup runs a brief set of diagnostics to ensure correct operation of the SPARCbook hardware. These diagnostics are run while the disk is spinning up every time the machine is switched on. More extensive diagnostics can be run manually if you suspect a problem with the SPARCbook computer system.

---

**NOTE**

Further information on the diagnostics available can be found in the 'Troubleshooting and Problems' section of this guide.

---

When starting up for the first time (and after a System Reset operation) the system will automatically ask you to supply information for basic configuration. These steps are described in 'Configuring and Using the SPARCbook'.

---

***BRIGHTNESS AND CONTRAST***

---

The SPARCbook uses a Cold Fluorescent (CFL) backlight to provide full screen legibility under all normal lighting conditions. The screen text should be visible as clear black lettering on the white background about 1 second after switching the machine on. If the screen cannot be seen clearly the brightness and contrast may be adjusted from the keyboard.

---

**NOTE**

The Brightness and Contrast controls can be changed at any time. The current values are stored when the system is powered down and are automatically reused when the SPARCbook is switched on again.

---

The brightness and contrast controls are on the bottom right hand side of the keyboard. The **Alt** key on the bottom left hand side of the keyboard must be pressed at the same time as the relevant control in order to have an effect.

Pressing <b>Alt</b> key and →	Increases Contrast
Pressing <b>Alt</b> key and ←	Reduces Contrast
Pressing <b>Alt</b> key and ↑	Increases Brightness
Pressing <b>Alt</b> key and ↓	Reduces Brightness

---

In general it is best to adjust the contrast control first, and then the brightness control.

**NOTE**

The Operating System has facilities to enable you to turn off the backlight when the screen has not been used for a time. Nevertheless the higher the brightness the more power will be drawn from the battery. Running the SPARCbook on minimum Brightness level will extend battery life by approximately 20 minutes for the monochrome model. See 'Power Management' for further information.

---

---

## ***THE KEYBOARD***

---

The SPARCbook uses a keyboard with 82 keys to provide the maximum number of full-size keys in the space constraints of a notebook system. These keys have been laid out to be easy to use and several specific facilities have been incorporated:

- 12 Function keys

The 12 function keys can additionally emulate two further banks of function keys called Left and Right. Pressing the Alt key (also marked L) and a function key provides the Left function, while pressing the Fn key (also marked R) and a function key provides the Right function. These Left and Right function keys are required by certain SPARC software applications.

- Special Function Keys

The Alt key is used to access certain special functions shown below

Alt-Esc-O	Turn System Off
Alt-Esc-R	Reset Hardware
Alt-H	OpenWindows Help
Alt- ←	Reduce Contrast
Alt- →	Increase Contrast
Alt- ↑	Increase Brightness
Alt- ↓	Reduce Brightness

---

The Fn key is used for Mousekey operations (see next section)

Fn-M	Toggle Mouse Mode
Fn-Ctrl	Left Button
Fn-A	Middle Button
Fn-S	Right Button

By default specific function keys are used for OpenWindows functions

F8	Cut
F9	Copy
F10	Paste
F11	Next
F12	Prev

- Backspace and Delete Keys

The Solaris 1.0.1 Operating System can be configured to use different keys for different functions. By default the erase or rubout key is the Del key. The interrupt key to quit an application is the Ctrl-C sequence. These keys are explained in more detail in 'Command Tool' below.

---

## ***THE MOUSEKEY***

---

The SPARCbook uses a special key on the keyboard to emulate a Mouse pointing device. While a conventional mouse may be plugged into the back of the unit, the keyboard itself has been specially designed to emulate all the functions of a three button mouse.

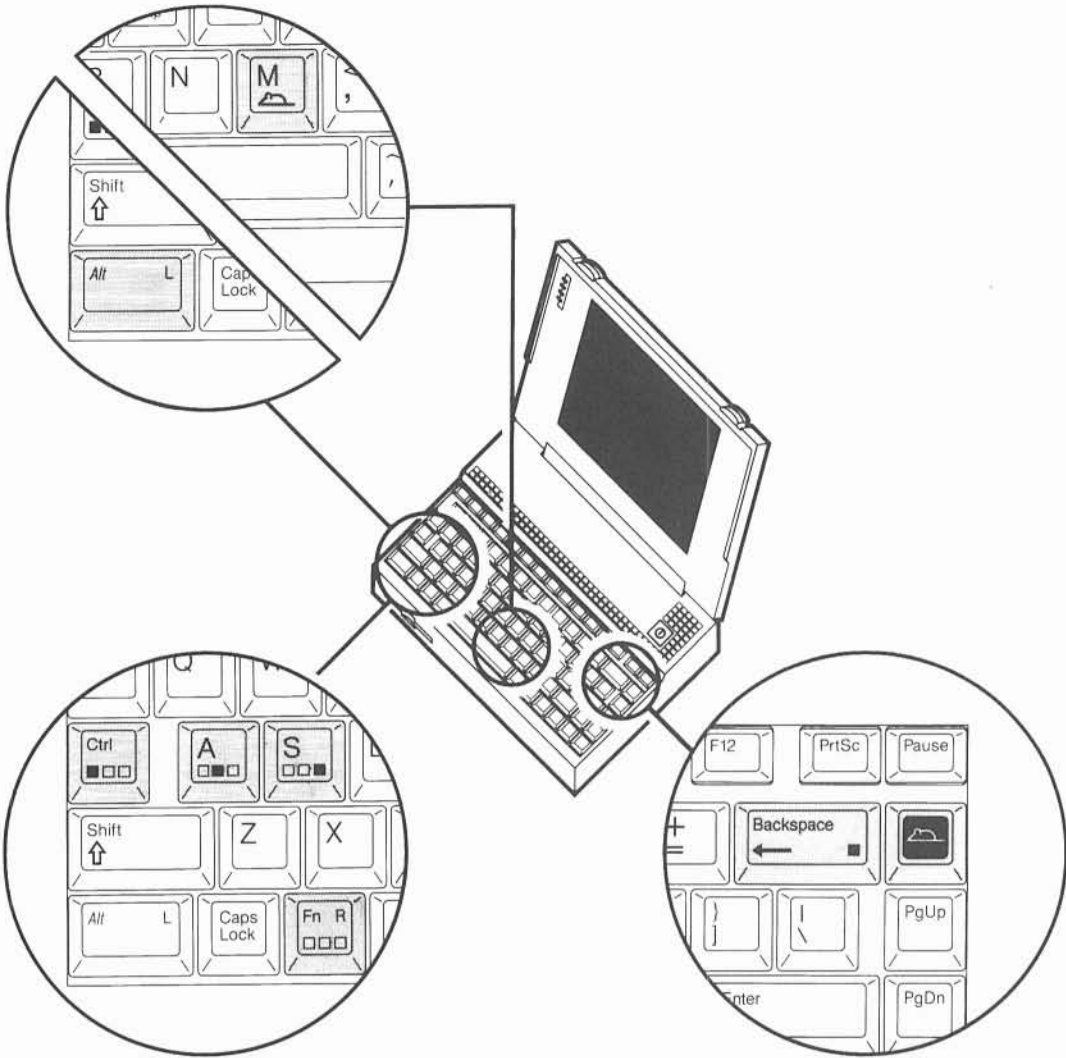

The pointing device is the Mousekey on the top right hand corner of the keyboard. This key does not depress in the normal way but responds to pressure in any direction to provide the facilities of a mouse. The mouse is only normally used when running the OpenWindows software and a demonstration account is provided to enable you to get used to the Mousekey operation (see ‘Starting OpenWindows’ for further information). To move the cursor you press lightly on the Mousekey in the direction you want the cursor to move. Light pressure will move the cursor slowly while heavier pressure will move the cursor faster.



---

**NOTE**

The Mousekey detects the pressure you are using to determine how fast to move the cursor. The pressure needed to move the cursor is configurable with the rest of the system setup and is described in 'Configuring your Deskset Environment'.

---

The Solaris OpenWindows environment supplied on SPARCbook is based on the industry standard OPEN LOOK Graphical User Interface. This interface uses mouse buttons for selecting objects, dragging objects and displaying menus.

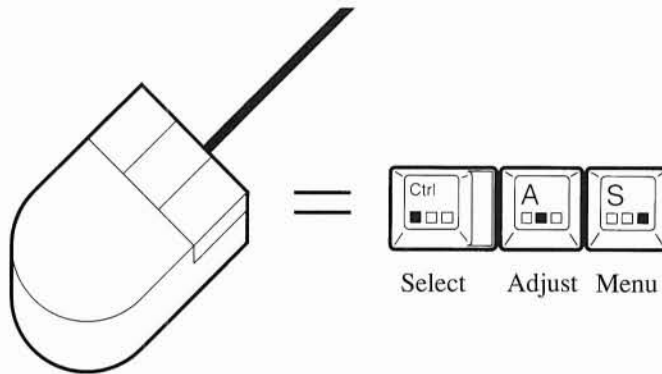

The *Select* key is used to select a choice, window or object.

The *Adjust* key is used to extend or reduce the number of selected objects.

The *Menu* key is used to display a menu or a set of choices.

The SPARCbook uses the keyboard to emulate the operation of these buttons. The keyboard may be used in one of two user selectable modes:

- *Normal Mode*

In this mode the three mouse button keys are used in conjunction with the Function (Fn) key to operate as a mouse button. For example to press the Left Mouse Button in normal mode you would use the Fn-Ctrl key sequence as follows:

---

Press the *Fn* key with your left hand thumb and hold it depressed.

Press the *Ctrl* key while keeping the *Fn* key depressed to simulate pressing the  
Left hand mouse button.

Release the *Ctrl* key while keeping the *Fn* key depressed to simulate releasing the  
Left hand mouse button.

Release the *Fn* key when you have completed the required mouse button operations.

The *Fn-Ctrl*, *Fn-A*, and *Fn-S* key sequences behave exactly as the three mouse buttons, and you can use them exactly as you would a normal mouse. For example, in this guide 'pressing the Select key' is used to mean pressing the *Fn-Ctrl* key sequence.

**NOTE**

---

Some applications require you to press the *Ctrl* key while pressing the Select mouse button. This is achieved by pressing *Fn-Ctrl-BS* sequence (*Fn*, *Ctrl* and Backspace keys at the same time).

---

• *Mouse Mode*

Many applications use the Select key for the majority of mouse based operations. Some use only this key exclusively for all mouse button operations. A special mode allows you to reconfigure the Backspace key (to the left of the Mousekey) as the Select button. This is called Mouse mode. *Ctrl-BS* is then used if the application requires the *Ctrl-Select* operation. As before the *CTRL*, *A* and *S* keys can still be used as all three mouse buttons in conjunction with the *Fn* key.

You may toggle between Normal mode and Mouse mode by using the Mouse mode key sequence:

Press *Fn-M* to toggle between Normal Mode and Mouse Mode

**NOTE**

---

The SPARCbook Operating System software does not enable the Mousekey facility until you have entered the OpenWindows environment. The sections below explain how to startup the SPARCbook and how to practise use of the Mousekey.

---

---

This page deliberately left blank

---

---

# CONFIGURING AND USING THE SPARCBOOK

This section explains how to start the system up and how to initially configure the operating system software. It provides an introduction to the OpenWindows software which is the standard Graphical User Interface (GUI) supplied on the SPARCbook. The bundled DeskSet productivity applications are outlined, and the Power and Battery Management tools explained.

Connecting up to external devices including printers, modems, keyboard or mouse, and a graphics monitor is described, together with the initial system administration required to access the devices you are using. Connection and configuration of the Ethernet network interface and internal modem are also covered.

- 
- Basic System Configuration  
How to configure the SPARCbook including allocating user access and passwords.
  - The DeskSet User Interface  
An initial tutorial on the Solaris OpenWindows Version 3 DeskSet Graphical User Interface.
  - Power Management  
How to use the SPARCbook Power Management facilities, and how to fast charge and change battery packs.
  - Using Floppy Disks
  - Connecting and Using External Devices
    - Printer
    - Network
    - External Graphics Monitor
    - External Mouse and/or keyboard
    - ASCII and X Window terminals
  - Using the Internal Modem

---

## **BASIC SYSTEM CONFIGURATION**

---

The SPARCbook computer system must be initially tailored to your own requirements. This section describes how to customize the SPARCbook system. You can change the system configuration at a later date if you need to alter some of the information supplied. When the system is first turned on the following messages are shown:

```
SPARCbook Monitor V2.0
Serial Number: 1d0000
```

```
Startup ..... Fast Diagnostics PASSED
```

```
Booting from hard disk ....
```

<b>NOTE</b>
-------------

---

The Monitor version number and your own serial number will be different from the example above. The diagnostics take about five seconds to complete.

---

After the Operating System has loaded into memory the screen will clear and will print the following messages. The exact format of the startup messages depends on your system configuration.

```
SUNOS 4.1.2 (SPARCbook)
Copyright (C) 1983-1991 Sun Microsystems Inc
```

```
Memory 8192K
Ethernet Address 0:0:83:1d:0:0
```

```
Booting unix ...
ni0:RARP timed out
Fast boot ... skipping disk checks
Mon Dec 30 14:12:20 GMT 1991
```

---

## SPARCbook SYSTEM CONFIGURATION

---

You will be asked to enter the following information using prompts:

- Machine name
- Time zone
- Date and Time
- Internet address (if installing on a network)
- NIS domain name (if using NIS on this network)
- User accounts (if not using NIS)

If you are installing your system on a network, but do not have your Internet address or NIS domain name, contact the system administrator for your network. Alternatively configure the SPARCbook initially for operation with no network and reconfigure the system later.

If you are using a network make sure that this system is added to the network databases so that it can communicate with other machines on the network.

Press ENTER to begin the setup.

The SPARCbook will now start the system configuration procedure. First you will be asked to assign the machine a unique name called a *hostname*. If you are using the system on its own this can be any convenient name, such as 'sparcbook'. If you are using the system on a network you must make sure the name is unique and does not conflict with any existing machine names on the same network.

---

SYSTEM CONFIGURATION  
HOSTNAME

---

If this system is connected to the network, the hostname must be unique to the local area network. Confirm this with other network users or with the system administrator for your network.

Enter a name to assign to this SPARCbook and press ENTER:

Hostname =>

[?] = Help

After you have entered your chosen hostname the system will request information on your timezone as shown below. If your timezone does not correspond to any of the areas shown you should select Greenwich Mean Time which allows you to select an arbitrary timezone in hours relative to GMT.

---

SYSTEM CONFIGURATION  
TIME ZONE

---

Press <Enter> or <Space> to move forward to your choice and type x.

- \* United States
- \* Canada
- \* Mexico
- \* South America
- \* Europe
- \* Asia
- \* Australia and New Zealand
- \* Greenwich Mean Time

**NOTE**

---

The Time Zone information is used to set and determine the system time. If you intend to use your SPARCbook in multiple Time Zones you should set the Time Zone for the zone you are most usually in. You can then adjust the OpenWindows clock for different time zones when you travel.

---



---

As an example, if you select the United States a second menu will be put up asking you to select the time zone you wish to use within the United States:

SYSTEM CONFIGURATION  
UNITED STATES

---

Press <ENTER> or <SPACE> to move forward to your choice and type x.

TIME ZONE NAME	AREA
US/Eastern	Eastern time zone, USA
US/Central	Central time zone, USA
US/Mountain	Mountain time zone, USA
US/Pacific	Pacific time zone, USA
US/Pacific-New	Pacific time zone, USA with proposed changes to Daylight Savings Time near election time
US/Alaska	Alaska time zone, USA
US/East-Indiana	Eastern time zone, USA no Daylight Savings Time

After you have selected a time zone you will be asked to verify the system time. The system time is kept updated by a separately powered clock device.

SYSTEM CONFIGURATION  
SYSTEM TIME

---

The system time is "Mon Dec 30 14:52:10 1991 PST".

Enter selection and press ENTER:

- 1) Yes, accept that as current time.
- 2) No, prompt me to input current time.

Selection =>

[?] = Help      [Ctrl-B] = Previous Screen      [Ctrl-F] = First Screen

If the time shown is correct select option 1. If the time is wrong you will be prompted to enter the exact time. This will then be remembered by the system and you should not need to change it again. You may also go back a screen as shown by typing *Ctrl-B*, or back to the beginning by typing *Ctrl-F*.

After the time has been configured the system will prompt for whether you are connected to a network. At this stage you should only say 'yes' if the SPARCbook is actually physically connected to a network interface. If the SPARCbook is not connected to a network then you should answer 'no'.

**NOTE**

For information on connecting the SPARCbook to a network refer to 'Connecting to the Ethernet'. You will always be able to reconfigure the SPARCbook when you do actually connect it to a network for the first time if you decide to select 'no' for the moment.

---

SYSTEM CONFIGURATION  
NETWORK

---

Enter selection for whether workstation is attached to a network and press ENTER

- 1) Yes, prompt for additional network questions to configure into network.  
(Verify Ethernet cable is attached to workstation.)
- 2) No, workstation is NOT attached to a network.

Selection =>

[?] = Help      [Ctrl-B] = Previous Screen      [Ctrl-F] = First Screen

If you select 'no' the next two screens will be omitted. The first prompts for the network address which will normally be assigned by the system administrator for your network. If you are setting up a network for the first time, or you do not know what your ethernet address is, you are recommended to configure the SPARCbook for non-networked operation initially, and refer to 'Configuring the Network' later in this guide for further information.

---

SYSTEM CONFIGURATION  
NETWORK ADDRESS

---

You must assign a network address to your workstation. Contact your system administrator for the unique network address of your system. Do not use the displayed address (192.9.200.1) if your workstation is being connected to the Internet network. Do not enter an address unless you are sure it is correct.

Enter the network address to be assigned to this workstation and press ENTER:

Network Address (e.g. 192.9.200.1) =>

[?] = Help      [Ctrl-B] = Previous Screen      [Ctrl-F] = First Screen

After you have entered the address the system will ask you to specify if you are using the Network Information Service (NIS). This was known as Yellow Pages (YP). To use NIS you must know the domain name for your network. For more information on NIS see 'Configuring the Network'. If you are not sure how to proceed specify 'no' to the use of NIS for the moment.

---

SYSTEM CONFIGURATION  
NIS NAME SERVICE

---

NIS is the network information service.

Enter the selection that applies and press ENTER:

- 1) Yes, the network uses NIS. Confirm this with your system administrator.
- 2) No, the workstation will not be using NIS.

Selection =>

[?] = Help      [Ctrl-B] = Previous Screen      [Ctrl-F] = First Screen

---

If you specify to use NIS one further screen will be printed asking you to enter the domain name.

Next, the system will summarize the information supplied so far and ask you to confirm it. If it is not correct you can use Ctrl-B to correct it, or Ctrl-F to start over.

---

## ***ACCOUNTS AND PASSWORDS***

---

The next part of the system configuration procedure asks you to set up accounts and passwords. The UNIX Operating System is designed to be used in a range of system configurations from single user machines to mainframes. It therefore includes facilities to allow its use by different users. Each user 'signs on' or 'logs in' to the system by identifying an account name and (optionally) a password. A special account is called the *superuser* or *root* account. This account has privileges and is used to carry out potentially damaging commands or system configuration procedures. A second special account is preinstalled and provides demonstrations of the SPARCbook. To set up the simplest configuration you will only need to set up a single user account for your own use.

First, you are asked to set a password for the root account. This is for security, as the superuser is able to access and change any user files, as well as alter the system configuration and setup. Do not forget the password or you will not be able to use all the system facilities, and you will need to reload the Operating System using the restore procedure.

---

SYSTEM CONFIGURATION  
SUPERUSER PASSWORD

---

For security reasons it is important to give a password to the superuser (root) account. A password should be six to eight characters long. To give a password to the root account, enter the password below. The password will not appear on the screen as you type it.

Enter superuser password and press ENTER, or press ENTER to continue:

    Password =>

[?] = Help

You will next be asked if you wish to set up a user account. This procedure sets up a user account with a minimum of questions asked and should be used to set up your own account if you are not familiar with the SunOS Operating System. If you are an experienced user you may omit the next steps and use the superuser account to set up your required user configuration using `add_user` or by editing the relevant system files.

<b>NOTE</b>
-------------

---

If you have configured the system to use NIS you will not be prompted to enter user accounts. This is because user accounts are normally maintained on a single master machine on the network called a name server. Consult your system administrator or 'Configuring the Network' later in this guide for further information.

---

---

SYSTEM CONFIGURATION  
USER ACCOUNT

---

To use the system, a user account must be set up. You can set up the account now or separately after configuration.

The following information is needed prior to setting up the account:

User full name - the common name of the user, e.g. John Doe  
User name - the login name of the user, e.g. jdoe  
User id - the system numerical id of the user

Do you want to set up a user account (y/n)?

[?] = Help

The User full name is used for certain system services such as electronic mail. The Login name is what you actually type to register with the SPARCbook and to access the system. The User id is a unique number by which the network identifies this account. Numbers from 1-10 are reserved. You should obtain a number from your network administrator if you have one. If you are setting up a network yourself, or if the system is to be used standalone and you are not familiar with User ids it is recommended that you start at 100. Therefore, for the first account you set up use 100 as the User id, for the next 101, and so on.

The next three screens prompt you for the required information. As an example to set up a user called John Doe with a login of jd you would enter:

```
User full name => John Doe
User name => jd
User id => 100
```

Note that the system will 'suggest' a user name of jdoe. You may use backspace to change this to the required login name if it is different. You will next be asked to enter a password for the user. This is suggested but not mandatory.

---

SYSTEM CONFIGURATION  
USER PASSWORD

---

Passwords are used for security reasons, but are not required. You can enter a password now, or you can also add one later.

Enter the user password, and press ENTER, or press ENTER to continue:

    Password =>

[?] = Help

After you have finished setting up the user account the system will complete its configuration and will complete its boot sequence. The exact messages printed depend on the system configuration but the sequence shown is typical for a networked system:

```
Configuration successfully completed
starting RPC key server
network interface configuration:
ni0: flags=63<UP,BROADCAST,NOTRAILERS,RUNNING>
      inet 192.9.200.99 netmask ffffffff broadcast 192.9.200.0
      ether 0:0:83:1d:0:1
lo0: flags=49<UP,LOOPBACK, RUNNING>
      inet 127.0.0.1 netmask ff000000
starting additional services: biod
starting local daemons: auditd sendmail statd lockd
loaded openwindows module
clearing /tmp
starting standard daemons: update cron uucp
starting network daemons: inetd printer
Mon Dec 30 17:00:08 GMT 1991
```

sparcbook login:

The messages indicate the various steps of the Solaris 1.0.1 Operating System startup. After the startup the system is ready to use and the login prompt is displayed as shown. Assuming you have set up a login account you will now be able to log in under one of the following logins:

---

**root** superuser account - you will enter the UNIX command prompt  
**demo** demonstration account - starts OpenWindows and provides demos  
**<user>** user account - if you have set up an account you will now be able to login as the user name you specified.

**NOTE**

---

You may change any of the settings you have provided in the system configuration procedure at any time by logging into the SPARCbook as root and typing command:

---

**# /usr/etc/install/sys-config**

This will cause the first screen to be entered again allowing you to change any part of the previously setup configuration.



---

Unless you have access to a CDROM drive via the parallel port or a Sun workstation, or have purchased an Operating System backup software copy on Floppy Disk with the SPARCbook, it is strongly recommended that you back up the system software before using the SPARCbook. This will allow you to restore the Operating System as factory supplied in the event of disk corruption causing a failure.

Full instructions on how to make a backup to floppy disk or over a network to tape are provided in 'Backup and Restore Facilities'.

---



---

## ***THE DESKSET USER INTERFACE***

---

The SPARCbook system software provides a user-friendly Graphical User Interface conforming to the industry standard OPEN LOOK specifications. This package is called OpenWindows Version 3 and is part of the Solaris Operating Environment. This section provides an introduction to the OpenWindows Version 3 facilities and gives a quick tutorial on the main features and tools provided on SPARCbook.

### **OpenWindows Version 3 Facilities**

- **DRAG AND DROP CAPABILITY**

Ability to move data between applications by 'dragging' a pictorial representation of data and 'dropping' it onto an application.

- **DESKSET USER INTERFACE TOOLS**

Virtual Window Manager	For running multiple applications
File Manager	For moving and manipulating files
Mail Tool	For using Electronic Mail
Print Tool	For printing files
Calendar Manager	Diary and Calendar software
Text Editor	Simple Document Editor
Fax Tool	Sending Faxes using the modem
Command Tool	Terminal Interface to UNIX
Clock and Calculator	

- **CONFIGURABILITY**

Add new applications and commands  
Set user preferences

**NOTE**

This section can only provide a brief introduction to the OpenWindows environment and facilities. For further information please refer to the optional full documentation on the Graphical User Interface.

---

## ***STARTING OPENWINDOWS***

---

The *demo* login uses the OpenWindows environment. You can have a tutorial of the OpenWindows system and facilities from the SPARCbook itself. While you can call this tutorial up at any time the SPARCbook has been set up to allow you to experiment with the Mousekey and with OpenWindows using the demo account.

To login to the demo account you simply type demo at the login prompt:

```
sparcbook login: demo
```

The system will automatically start up the OpenWindows environment which takes about 30 seconds to initialize. After this time a screen will appear giving a set of demonstration choices as shown below.

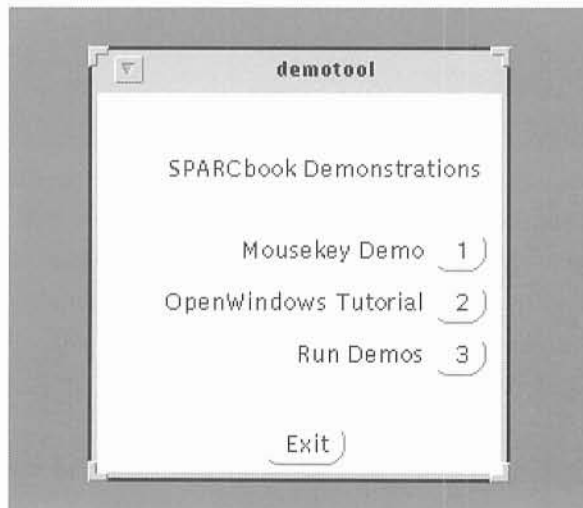

---

## ***MOUSEKEY DEMONSTRATION***

---

If you are using the SPARCbook for the first time you can experiment with the keyboard Mousekey by selecting the Mouse option. To start the demonstration type 1 and then Enter. After the program has loaded a mouse representation and a grid of lines will be drawn. Refer to 'The Mousekey' for further information on using the keyboard mouse. Pressing a mouse button key will cause the corresponding mouse button to change color. Moving the pointer will move the cross, and you should practice moving it to an arbitrary position.

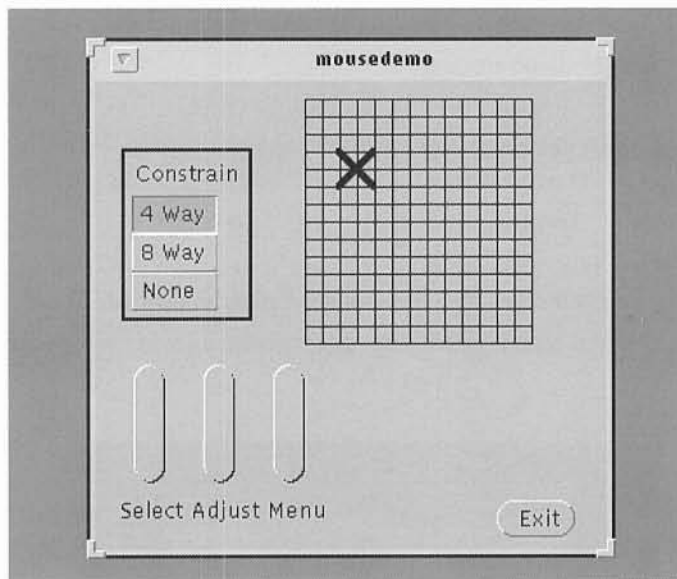

By default in OpenWindows the mouse is constrained to move in only four directions (vertically or horizontally). This makes it easier to move the mouse down and across menus in the OpenWindows environment. It is possible to change this to eight way constraint (diagonals allowed), or to completely unconstrained, as in a normal mouse. To change the default mode move the pointer to the required mode and press the Select key (press Fn and then, while holding Fn down press Ctrl down briefly). The current mode will be displayed.

To exit the Mousekey demonstration move the pointer to the *Exit* box and press the Select key.

---

## ***OPENWINDOWS TUTORIAL***

---

To run the tutorial select Option 2 by typing 2 and then pressing the Enter key. Note that the tutorial is part of the Sun Operating System and assumes you are using a normal mouse. You will therefore need to perform the corresponding operations with the Mousekey when mouse operations are specified. In addition reference is made to the system *Help* key. On a Sun workstation this key is located on the bottom left hand side of the keyboard. On the SPARCbook the same function is carried out using the *Alt-H* key sequence.

<b>NOTE</b>
-------------

You may also use a conventional mouse with the SPARCbook. For further information refer to 'Using an External Mouse'

---

---

## ***USING OPENWINDOWS***

---

If you set up your log in account from the system startup OpenWindows will be started by default when you log in to the SPARCbook. The following message will be displayed:

```
sparcbook login: yourname
SunOS 4.1.2 (SPARCbook)
Starting OpenWindows (Type Control-C to interrupt)
```

OpenWindows will now take about a minute to initialize and startup.

If you are in a UNIX shell (this is the normal command interface to UNIX and is typically signified by a % or a \$ prompt) you may start up OpenWindows by entering the `openwin` command:

```
% /usr/openwin/bin/openwin
```

The picture shows the default environment shipped as standard. Later you will be able to change this default setup for your own preferences.

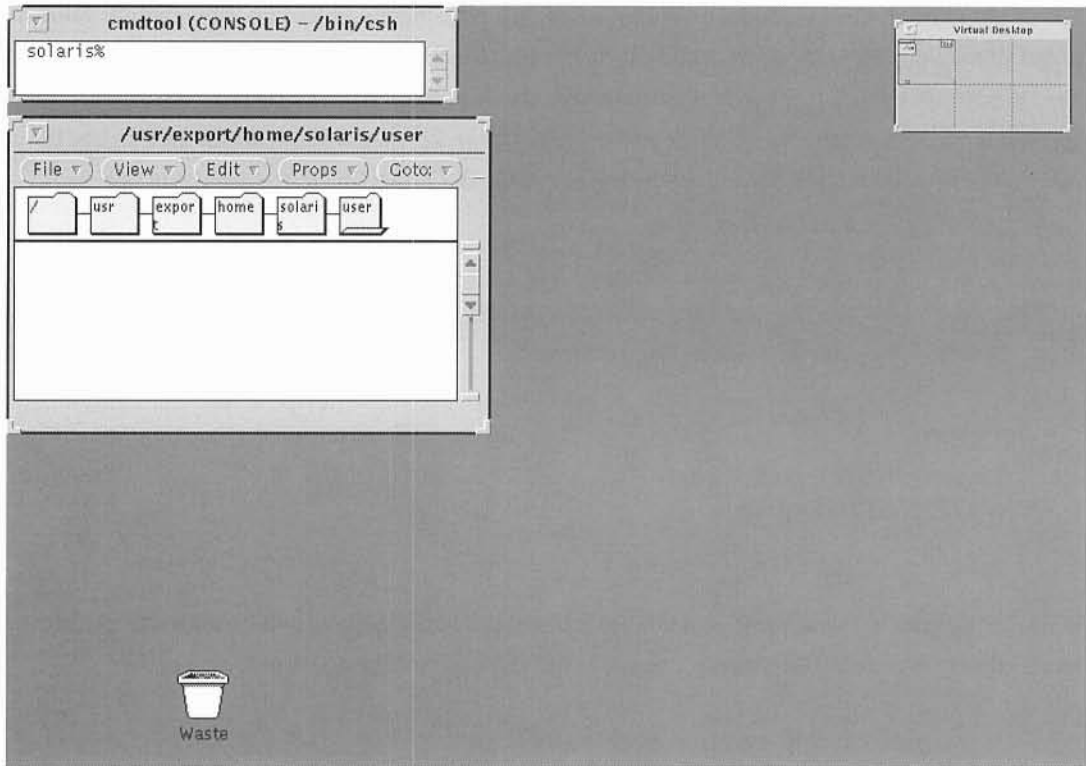

---

## BASIC OPERATIONS

---

The *Workspace* is the entire screen. One or more applications may be run and these may occupy some or all of the Workspace. A typical workspace is shown below; the next paragraphs describe each of the different items that can appear on the workspace and how to use them.

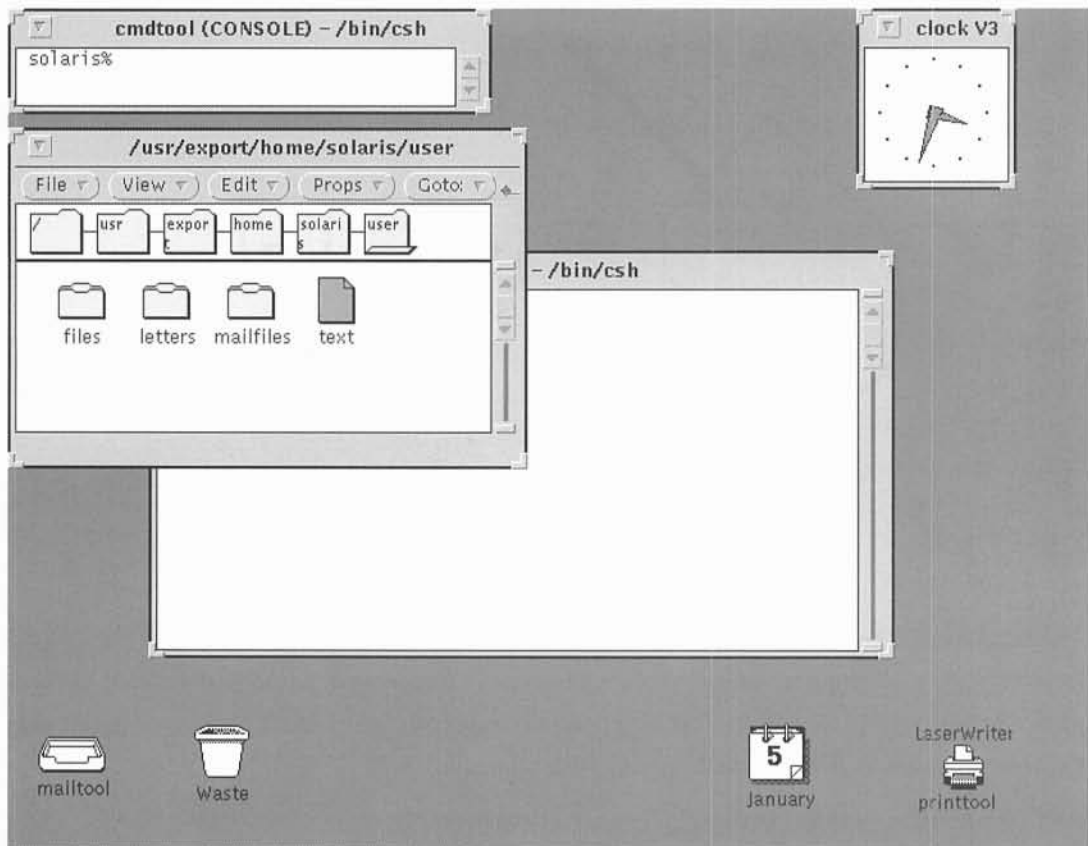

---

## *MENUS AND MOUSE BUTTONS*

---

The SPARCbook keyboard uses the Mousekey to simulate operation of a three button mouse.

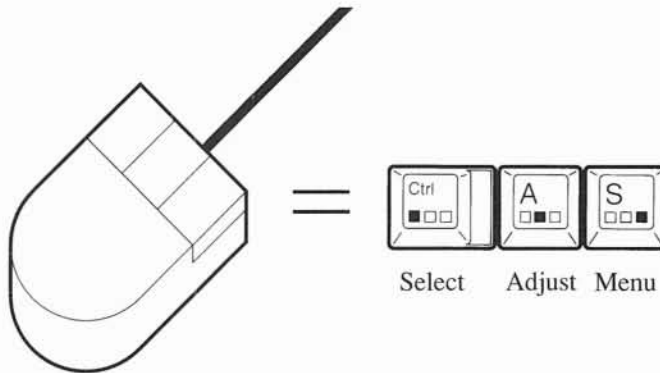

The effect of each key depends on the context in which it is used. As a general summary the following apply, although the exact use of each button is dependent on the application being run at a particular time. The Mousekey itself is used to move the Pointer, which is the arrow used to point at the object, window or item you wish to work with.

The *Select* key is used to select a choice, window or object. For example it has no effect when pressed in the screen background since there is nothing to select. If it is pressed in a window that window becomes *Selected*. This is shown by the filled in border at the top of the window. The *Selected* window is the one which you are using; all keyboard input will be directed to that window.



As another example of the use of the *Select* key you can use it to cut and paste text from one place to another (in the same or different windows). For example, if you press the *Select* key and while holding it down drag the pointer (using the Mousekey) across a line of text that line will become highlighted and is *Selected*. Another operation may now be performed on this line (for example it may be cut, or have its font changed in a desktop publishing application).



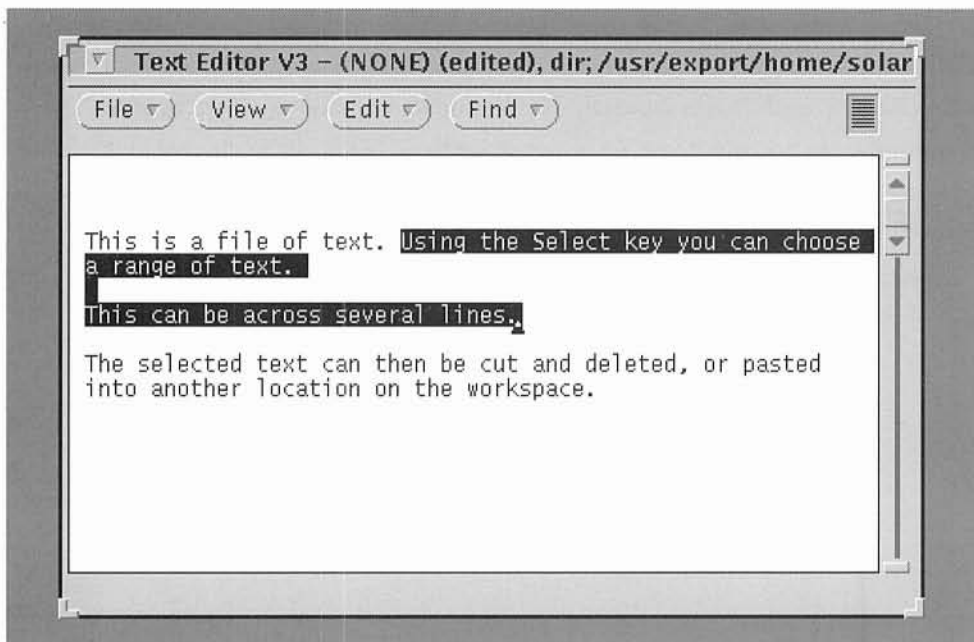

The Adjust Key is used to extend or reduce the number of selected objects. Using the same example as before you could select the beginning of a page of text to be marked and then press the Adjust key at the end of the page. This would have the same effect as dragging the cursor across the text while the Select key was depressed. On completion of the operation the selected text will be highlighted.

The *Menu* key is used to display a menu or a set of choices and to choose an option. When used within a window the Menu key will have a meaning depending on the application. For example, pressing the Menu key on the top of a window shows the window menu. Pressing the Menu key on the background brings up the Workspace menu. These menus are discussed in more detail later in this section. In OPEN LOOK the Menu button symbol is an inverted triangle. Pressing the Menu key with the pointer over the button will reveal a relevant set of choices. To choose a menu option you should hold the Menu key down while moving the pointer to the option you want to select. If you release the key a menu choice will be acted upon if the pointer is over a selection. If the pointer is moved off the menu area before the button is released the menu will disappear and no action will be taken.

---

The workspace menu provides the following options.

- **PROGRAMS**

This option has a second level menu that allows easy access to a range of programs and applications supported under the DeskTop. You can customize this menu to your own requirements (see 'Customizing OpenWindows Menus').

- **UTILITIES**
- **PROPERTIES**

These choices are described in 'Configuring your DeskSet Environment'.

- **PORTABLE**

This option has a second level menu that accesses the battery status and Power Management facilities. See 'Power Management' for further information.

- **EXIT**

If you Choose the exit option all OpenWindows applications will be exited and you will be logged out or returned to the shell prompt depending on how your account is configured.

---

## WINDOWS

---

OpenWindows uses rectangular screen areas called Windows to allow multiple applications to be used at the same time. The Window format conforms to the OPEN LOOK style guidelines which ensure a common 'look and feel' between different applications. As in the Apple Macintosh or MS-Windows environment once you have learnt the basic operations it is simple to use any conforming application.

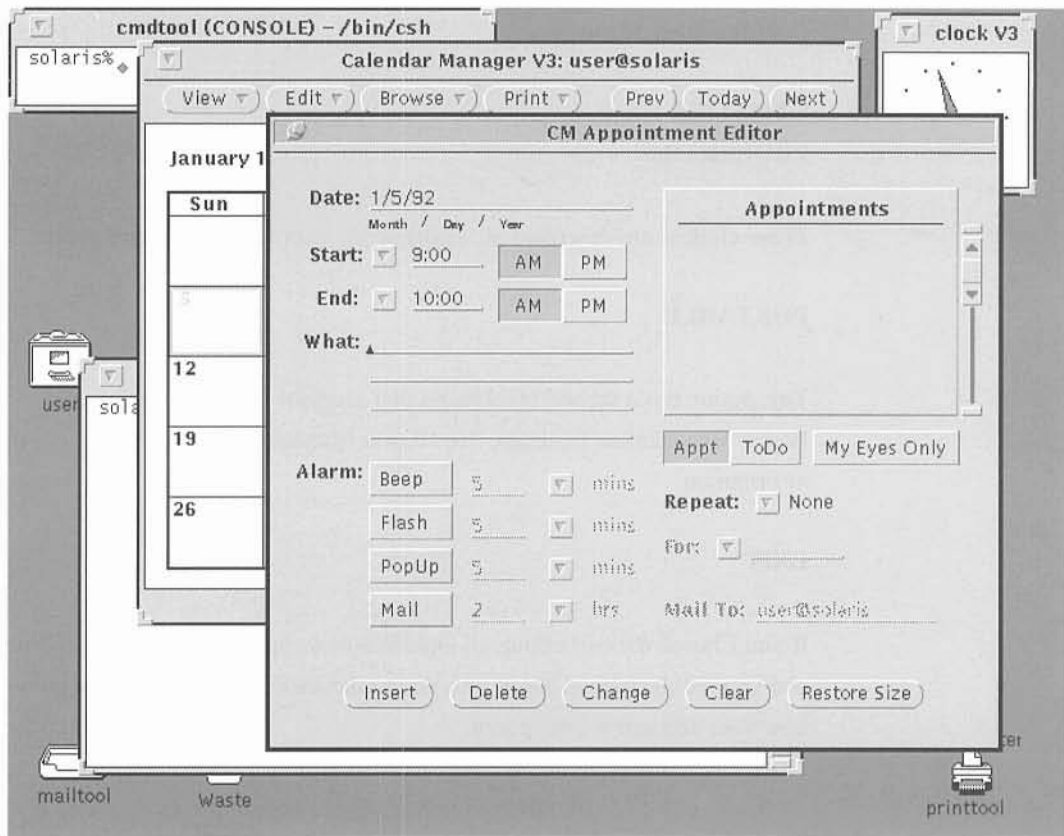

Each window has an associated menu which may be reached by selecting the menu pointer on the top left hand corner. To display a window menu move the pointer to the menu symbol and press the Menu key. The window menu will be displayed.



The options have the following effect:

- **C**lose will change the window into an Icon (see below)
- **F**ull **S**ize will change the window to take up the entire screen height. You can also perform this operation by double-selecting on the top border of the window. To double-select move the pointer to the top of the window and press the Select key twice in rapid succession. The window will now take up the entire screen height. To reverse this operation double-select the top of the window again.
- **M**ove allows you to move the window with the cursor keys. Pressing the cursor keys moves the window slowly; pressing Ctrl and the cursor keys simultaneously causes larger movement. Windows may also be moved easily with the mouse (see Resize Corners below).
- **R**esize allows you to resize the Window with the cursor keys as for move. Windows may also be resized easily with the mouse (see Resize Corners below).
- **P**roperties (if present) allows you to change the properties of a window. This is window and application specific.
- **B**ack moves the window to the back of the Workspace.
- **R**efresh redraws the window (for example if the contents have been corrupted)
- **S**tick determines whether the window will appear in every Virtual Window Manager frame or not (see the section 'Virtual Window Manager').
- **Q**uit closes the window and causes the application to be exited.

---

## ***PUSHPINS***

---

*Pushpins* are used on some menus and windows. They are used like pins on a notice-board. If you Select the Pushpin (using the Mousekey and the Select key) it will be inserted, and the menu or window associated with the pin will remain on the screen. If the inserted pin is Selected the pin will be pulled out, and the menu or window will disappear.

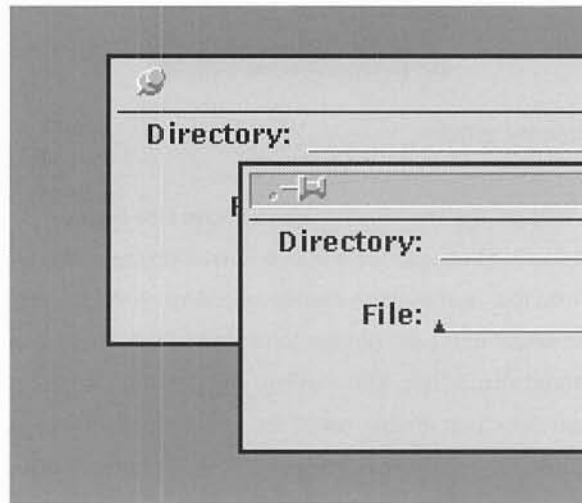

---

## ***RESIZE CORNERS***

---

*Resize Corners* are situated at the corners of windows. Using these corners you can change the size of a window. You can do this by moving the pointer to the corner you want to move, pressing the Select key, and while holding it down 'dragging' the corner to the required new position. When you release the key the window size will have changed. Note that changing the area of a window does not change its scale, only the area of its contents that is actually displayed. If you want to move a window you can Select the window *header* (the bar at the top of the window) and drag it to the required new location before releasing the Select key.

---

## SCROLLBARS

---

On the right hand side of the window (and also in other places) there may be a *scrollbar*. If the application cannot display all the information in the available space the scrollbar can be used to move around. Scrollbars have several different components.

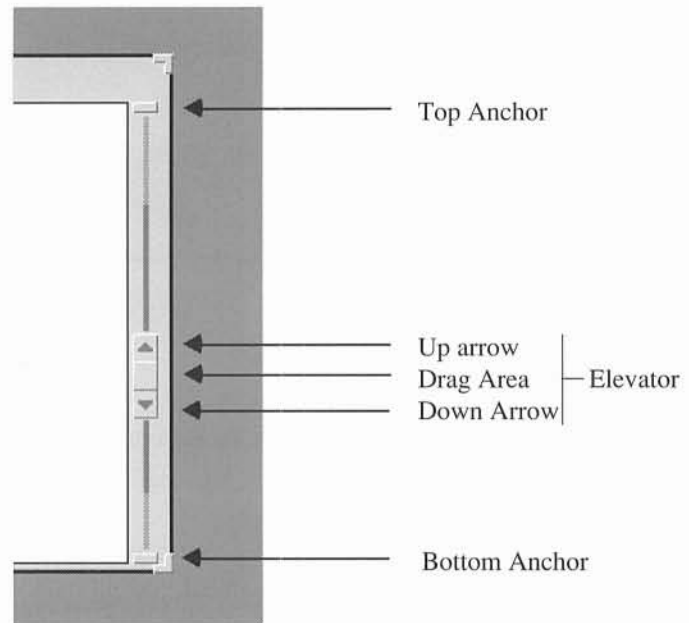

The *elevator* shows where you are in relation to the available total viewable area. The Select key is used to move around the viewable area:

- |  |                                |
|--|--------------------------------|
| • <i>Select</i> the top anchor         | Moves to the beginning         |
| • <i>Select</i> the bottom anchor      | Moves to the end               |
| • <i>Select</i> the up arrow           | Moves up one 'page'            |
| • <i>Select</i> the down arrow         | Moves down one 'page'          |
| • <i>Select</i> the drag area and drag | Moves to an arbitrary position |

---

## ***CONTROLS***

---

*Controls* and Control Areas are used to enter data, to select options or to adjust a parameter. For most controls the Mousekey is used to point at the required setting and the Select key can be used to select or move the required option.

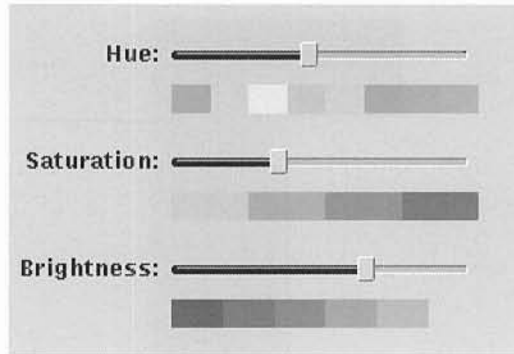

A *text field* allows the user to enter text. To enter text the pointer should be moved to the text field and the field selected with the Select key. The text is then entered in the normal way from the keyboard, and terminated with the Enter key.

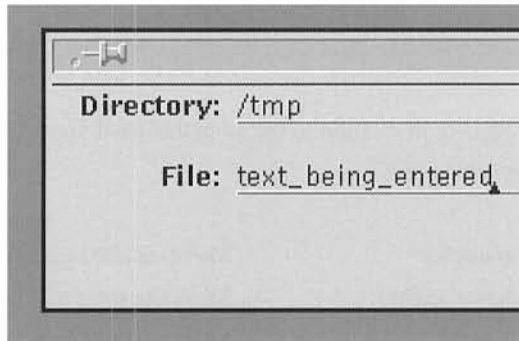

---

## ICONS

---

In OpenWindows user files and applications have pictorial representations called *icons*. Different types of files have different icons. For example, UNIX Operating Systems directories are represented in the File Manager by the folder icon. Each folder contains further files. Some examples of icons are shown below:

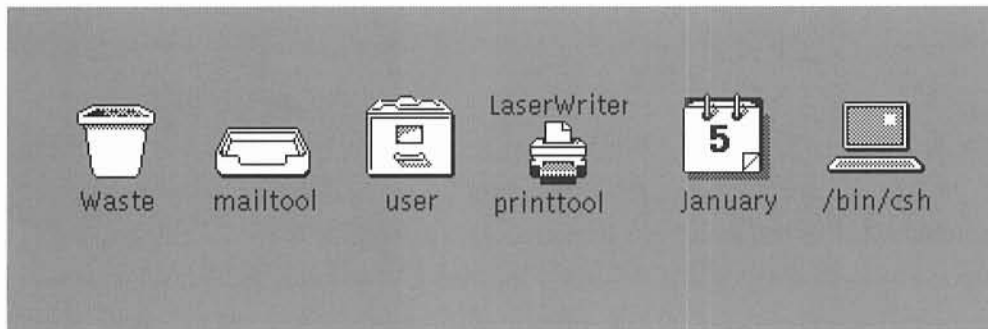

Windows that you are using may be converted into icons at any time. When they are icons they continue to operate as normal windows, but you will not see any changes in the window contents until you change the icon back to a window. Some applications change the icon if attention is required. For example the mail icon can have three different forms.

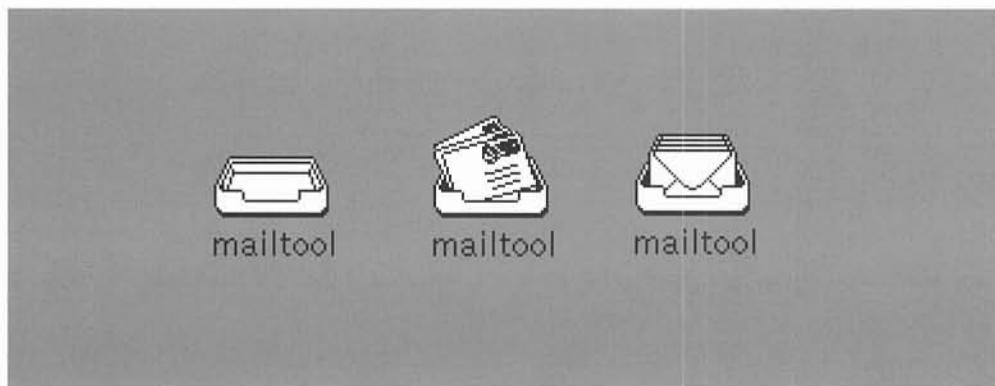



---

You can convert a window to an icon by Selecting the Close button (the small inverted triangle) at the top left of the window. This will instantly convert the window to an icon. If you want to reopen the window you simply need to double-select the icon. Remember that to double-select an object you move the Pointer over the desired object and then press the Select key twice in rapid succession. When this operation is carried out on an icon the iconized window will be reopened in the place where it was originally displayed. Remember that the contents of it may have changed if output was sent to the window while it was iconized.

---

## ***HELP***

---

You may request help at any time if you are not sure how to proceed. To request help on a topic move the pointer to the object or area you would like help on. Then press the alt-h key sequence on the SPARCbook keyboard. A pop-up help window with the available help text will appear at the top left of the display. When you have finished you should just remove the Pushpin by Selecting it.

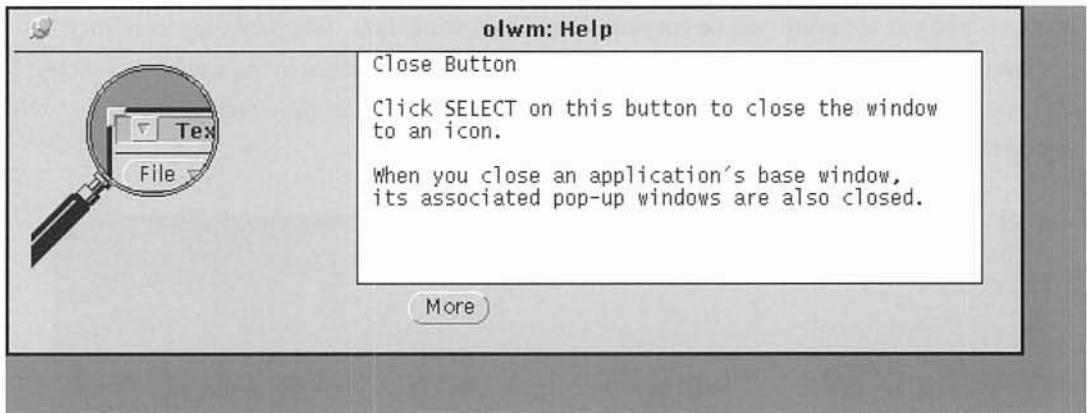

Note that additional help using the *more* button is not available in the bundled SPARCbook Operating System, since the on-line handbooks are not included.

---

## ***MOVING DATA, FUNCTION KEYS***

---

Many applications allow you to copy, cut and paste text within or between windows. Using OpenWindows these operations are carried out using the same controls and operations as for basic manipulation of windows and objects.

To select an area for copying or cutting you may use the Select key and drag over your required selection, or you may Select the start point of the required text and use the Adjust key to adjust the selection to the required end point. When you have selected an area of text it will be highlighted.

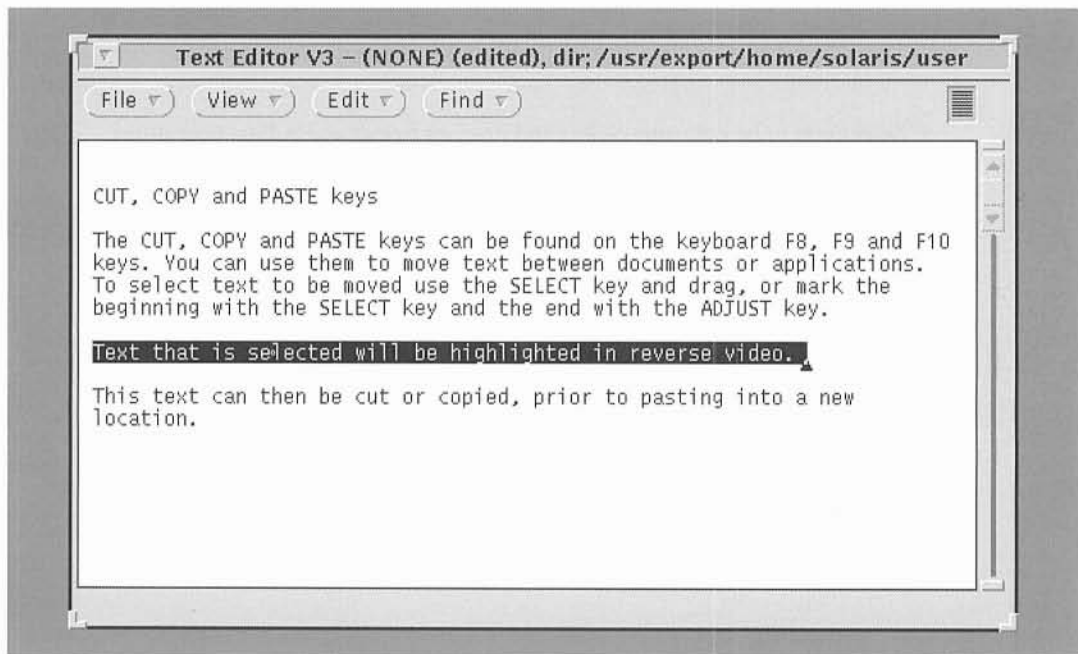

---

Certain function keys have been preassigned for basic operations and are marked on the keyboard.

- Cut key (F8) will remove the highlighted text. It may be copied to another place by using the paste command. By default it will be pasted onto the next command line if you are in a terminal window.
- Copy key (F9) will copy the highlighted text. It may be copied to another place using the paste command.
- Paste key (F10) will paste any buffered text to the selected place. Thus to cut text from one window and place it into another you should perform the following operations:
  1. Select text to be cut using Select and drag, or Select and Adjust operations.
  2. Press the Cut key. The highlighted text should now be removed.
  3. Select the new place to lay the text, with the Select key.
  4. Press the Paste key. The text should appear in the new location.
- Next key (F11) will make the next selection of a series. It is also used as the Next key for DOS applications.
- Prev key (F12) will make the previous selection of a series. It is also used as the Prev key for DOS applications.

---

## ***DRAG AND DROP FACILITIES***

---

OpenWindows Version 3 provides the facilities to drag and drop objects in order to move data between one application and another.

### Examples of Using Drag and Drop

- **Printing a File**

If the Print Tool is running you may print a file by selecting the file from the File Manager window and dragging it (keeping the Select key pressed) onto the Print Tool icon.
- **Deleting a File**

To delete a file you may Select the file from the file manager window and drag it onto the Wastebasket icon.
- **Running an application**

To run an application you may drag the application icon from the File Manager (see later in this Section) onto the workspace. The application will be started automatically. Alternatively you may double-select the application.

**NOTE**

---

Note that the object you are dragging will be highlighted with a 'bulls-eye' target when you are over an area that supports the drop operation. This is called the *Drop Zone* and helps to identify applications which support the Drag and Drop metaphor.

---

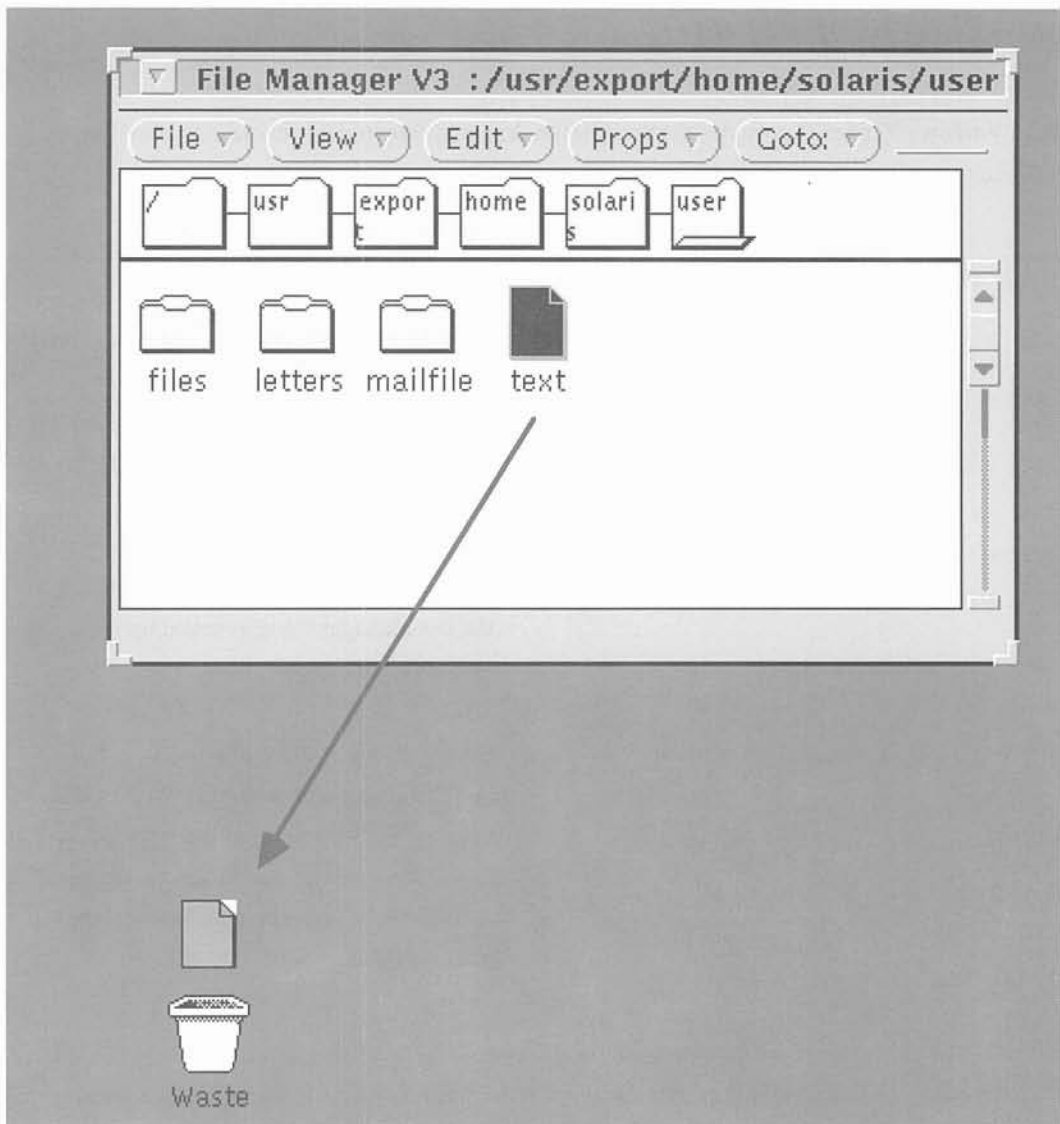

Some DeskSet applications have drag and drop targets in their main windows. These are generally in the top right hand corner. When you drop an object onto the target it will be loaded into the application, replacing what is already there. For example, if you drop a file into the Text Editor drag and drop target, any current text being edited will be replaced with the contents of the file.

In addition some drag and drop targets are shaded indicating that the contents of the current application can be dragged out of the drop target. For example you can select the shaded area from the Text Editor and drag it onto the Print Tool icon drop target to print the current contents of the Text Editor.

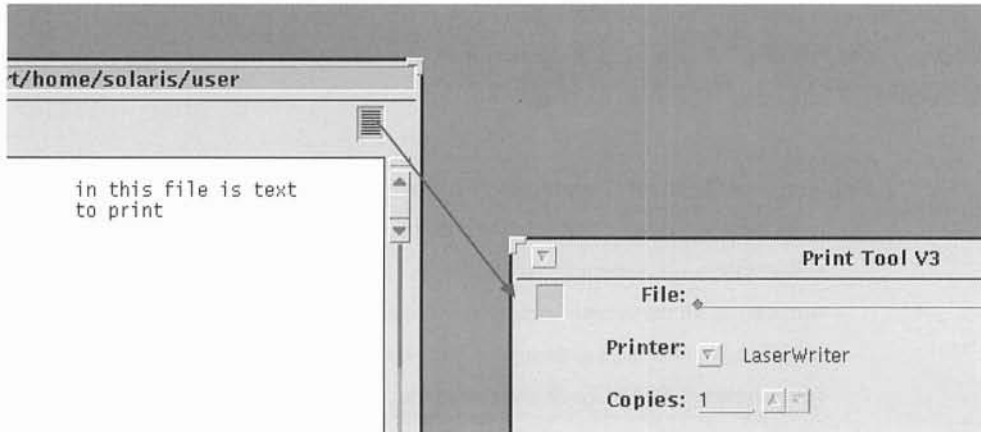

---

## ***THE DESKSET TOOLS***

---

The DeskSet tools provide a set of applications to improve productivity and to make using the SPARCbook facilities as easy as possible. Tools are provided to manage windows, to send and receive electronic mail through the internal modem or over the network, to schedule appointments, and to edit and print text files. The next pages provide an introduction to the tools supplied as part of the embedded SPARCbook Operating System.

<b>NOTE</b>
-------------

---

This User Guide does not provide a complete Reference Manual for the Sun DeskSet tools. It does give an introduction to each major application and shows you how to perform the most commonly required tasks. The Commands Section gives a brief summary of all the various commands available in the DeskSet tools, but for a complete reference you will need to obtain the Sun DeskSet Reference Manual Set, or the complete set of SPARCbook documentation.

---

Almost all of the functions and features in the DeskSet tools can be reached through the menus provided in the main window of each application. The DeskSet tools use common features and facilities and while not all the facilities, can be documented in this introductory guide, you will quickly learn the available features by experimenting with the menu options available in each application.

---

## ***VIRTUAL WINDOW MANAGER***

---

When you start up OpenWindows on the SPARCbook the default window manager is called the OPEN LOOK Virtual Window Manager or *olvwm*. This is a powerful tool to manipulate windows and is particularly useful on the limited screen size provided by a notebook computer.

The Virtual Window Manager gives you a virtual workspace or virtual desktop that is bigger than the screen. By default this is three screens horizontally by two screens vertically, but you may easily change this to suit your own requirements. The virtual desktop is represented by a small window that is by default situated at the top right hand side of the screen.

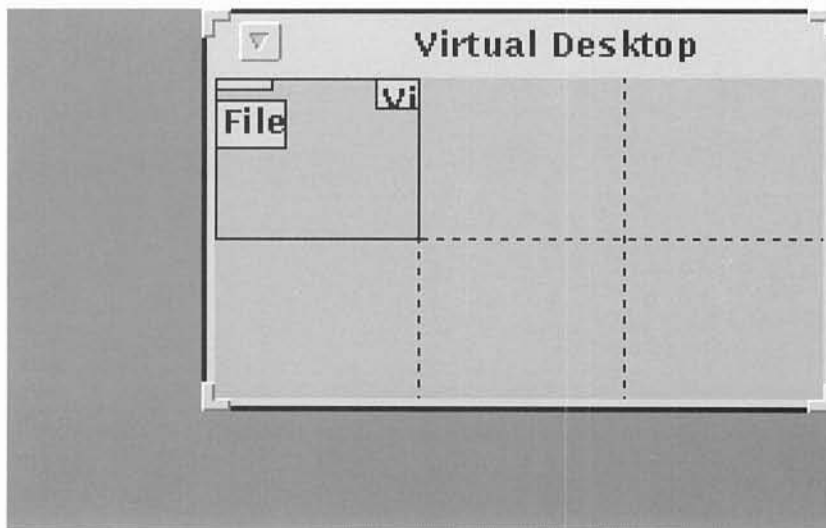

The picture shows the top right hand corner of the screen when you first use OpenWindows. The File Manager window and the console window are on the left hand side of the screen as shown in the Virtual Desktop representation.



---

## ***THE VIRTUAL DESKTOP***

---

To move the current view on the virtual desktop you move the pointer onto the virtual desktop window and into the screen representation or *panel* where you wish to move to. If you double-select the current view will change to the selected panel. For example, the picture shows the screen after you have moved to the bottom right hand panel.

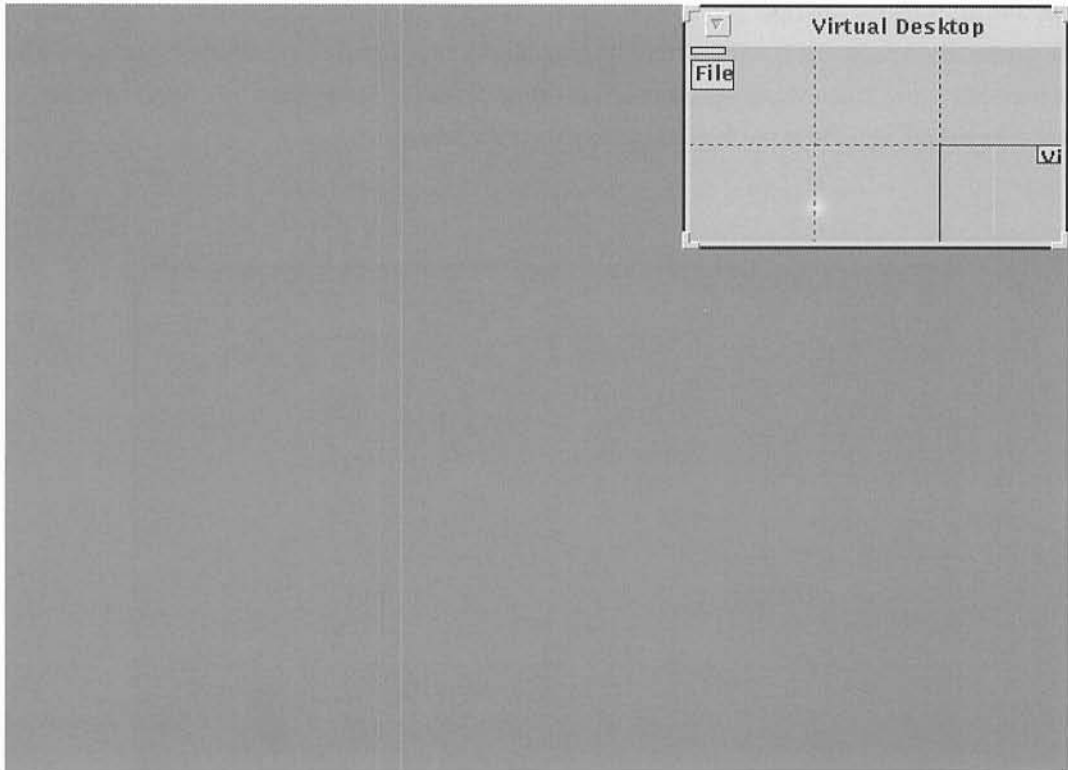

Note that the virtual desktop window has moved with you into the new screen. This is because the virtual desktop window is *sticky*. A sticky window is one that will appear in every panel on the virtual desktop and is useful for applications that you always want at hand. For example, by default the clock program (which you can Select from the Programs menu) is configured as sticky. You may make a window sticky or not by choosing the Stick or Unstick option from the window menu (see 'Windows', above).

---

Also notice that the virtual desktop window contains a scaled image of the entire virtual screen. Each scaled window also contains the first letters of the application name.

Using the virtual desktop you can therefore start multiple applications in different screens on the virtual desktop and switch rapidly between them by double-selecting the panel you want to use in the virtual desktop window.

You may also move round the virtual desktop using the cursor keys. To do this first Select the virtual desktop window by moving the pointer to the window header (the bar on the top of the window with the title) and pressing Select. The window will then be selected and will have a thick black border. You may now use the cursor keys to move you a screen at a time up, down, left or right in the virtual desktop space. You may also move a half-screen at a time by pressing Shift and the relevant cursor key simultaneously.

---

### ***MOVING WINDOWS ON THE VIRTUAL DESKTOP***

---

Because of the space constraints of the notebook computer screen you will often want to use applications that use pages of a larger size than the screen. You may want to change quickly the window you are viewing, or view another part of that window. Using the virtual window manager you can move windows quickly by moving their representations on the virtual desktop. As an example assume the initial window configuration shown in the section 'Using OpenWindows'. This is the default for a new user. Using the Virtual Window Manager, move the File Manager by moving the pointer onto the File Manager representation in the Virtual Manager window and pressing the Select key. While holding the Select key down, drag the File Manager representation into the bottom right hand panel and release the Select key. The File Manager has now been moved to the bottom right hand panel and will disappear from the current view.

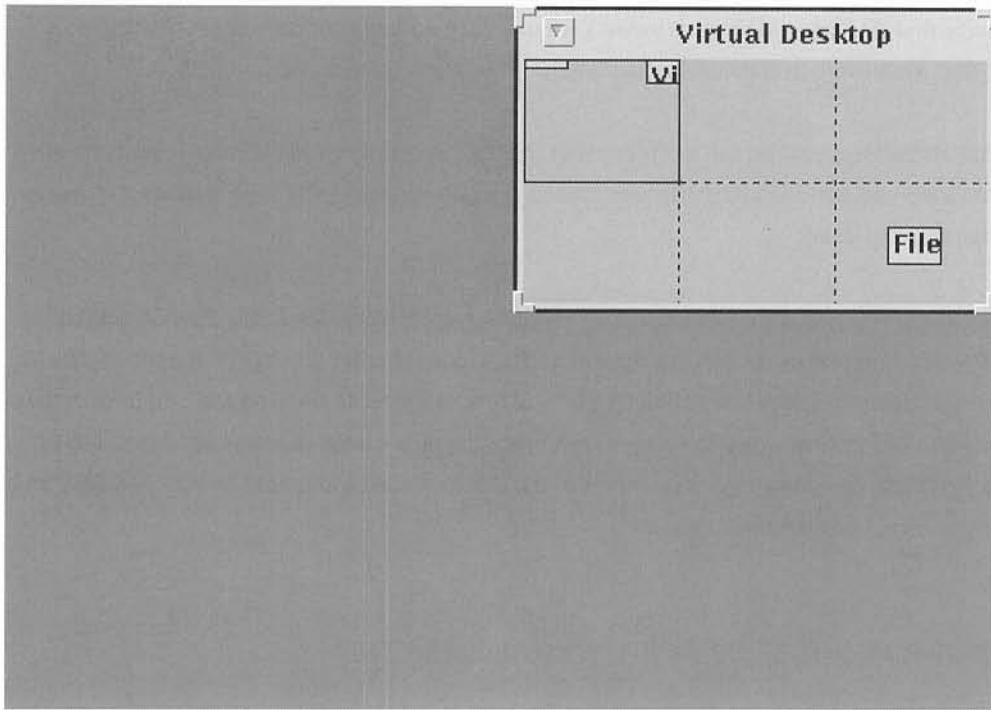

To verify this you can move the pointer to the bottom right hand panel and double-select. Your screen will now show the bottom right hand panel with the File Manager. As a final example, move back to the top left hand panel by double-selecting on it in the Virtual Manager window. Using the Virtual Manager in the same way as the last example, move the File Manager window again, except this time move it right out of the Virtual Manager window. Notice that a border comes onto the current screen. This is the File Manager window, and if you release the Select key it will be placed onto the current screen, and will be seen in the upper left panel of the Virtual Manager window.

---

## ***CONFIGURING THE VIRTUAL DESKTOP***

---

You may change the virtual desktop size by simply resizing the virtual desktop window. It may be resized in units of screen size. If you resize it smaller than its current size you will not lose any windows on the 'removed' area. If you resize it larger again they will reappear.

The SPARCbook keyboard by default has a function key dedicated to the virtual desktop. This key allows you to bring the Virtual Manager window to the front of the screen at any time by simply pressing the F7 function key.

---

**NOTE**

If your application uses this function key you may reassign the key the Virtual Manager uses by changing the `o1vwm` defaults file. See 'Configuring Your Deskset Environment' for further information.

---

---

**NOTE**

It is not possible to perform a Quit operation on the virtual desktop from the `o1vwm` window menu. Attempting this will have no effect. To exit from the windowing system use the Exit option from the main workspace menu.

---

---

## FILE MANAGER

---

The File Manager is a graphical representation of the file system in tree form. In the UNIX Operating System files are contained in directories, which are shown as folders in the File Manager. In each folder can be files, applications or more folders. The file system consists of a hierarchy of folders which form an inverted tree.

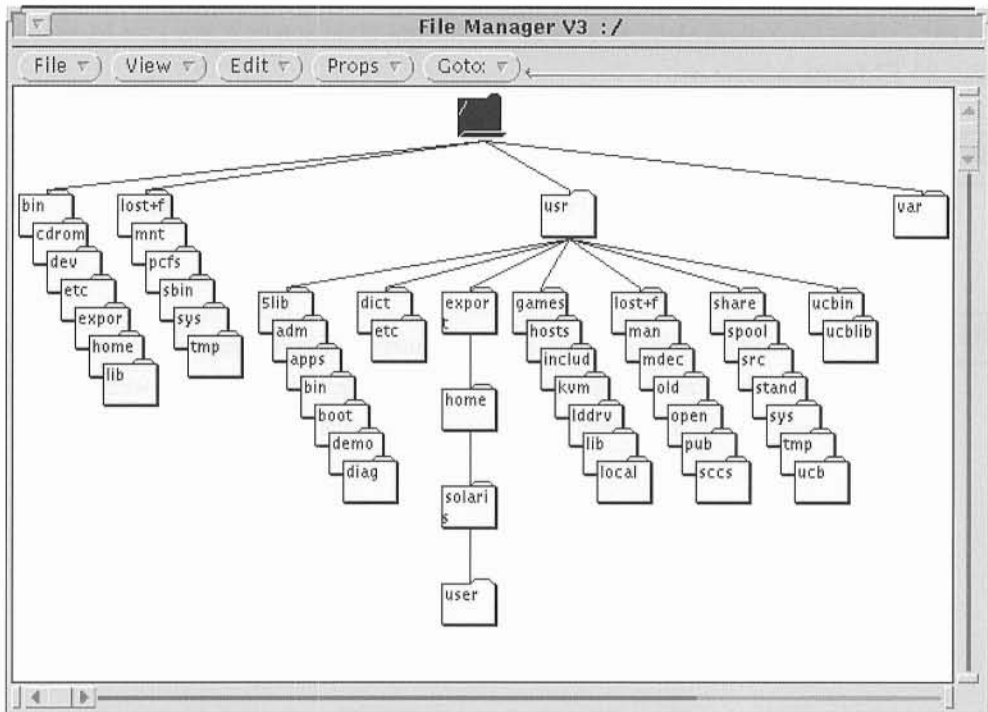

If the file manager is configured to be run when you log in it will display a window showing your own directory tree. If it is not configured to be automatically started, you can start a File Manager by Choosing the File Manager option in the Workspace menu. To do this move the pointer to a free area of the workspace and press the Menu key. While holding the Menu key down move the pointer to the Programs option and then the File Manager selection. Release the Menu key and the main File Manager window will appear.

Each File Manager window contains two areas. The top area or pane shows where you are in the entire SPARCbook machine tree. The lower area shows the contents of the current folder.

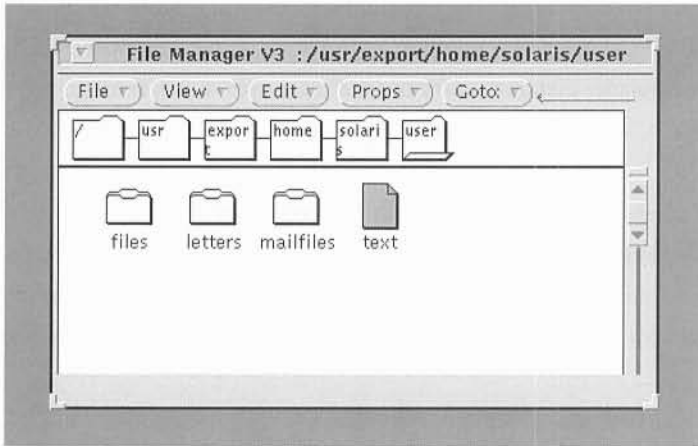

Each file in the file system is represented by an icon. There are three types of icon used for the majority of files. The folder is used to represent a directory of files. Text and other ASCII data files (for example spreadsheets or graphical output files) are represented as sheets of paper or as determined by the application that created them. Applications themselves are represented as a small window, or as an icon representing the application itself.



The File Manager allows you to perform the following operations on selected icons:

- Open files, folders and applications
- Create new files and folders
- Move and copy files, folders and applications
- Link files so they can be accessed from more than one folder

---

As before you can select one or more icons by using the pointer and the Select key, and then dragging the pointer or using the Adjust key if you want to simultaneously select further icons. Each selected icon is highlighted. You carry out operations by using the Mousekey to drag and drop icons on other icons in the File Manager, or on other windows, or on the workspace itself. Alternatively you can use the File Manager menus to carry out the same operations. Finally, you can double-select an icon to open it. The effect depends on the icon itself:

- For an application the application will be started
- For a folder the folder will be opened and its contents shown in a pop-up Window.
- For a data file the corresponding application will generally be opened. If there is no known corresponding application the text editor will be opened to edit the file.

---

## ***COPYING FILES***

---

Files can be moved and copied by selecting them and dragging them to a new destination. The only difference between a move and a copy is that for a copy you need to press the Ctrl key at the same time as you Select the original file. For example to copy a file called `text` from the current displayed folder to the folder called `files` in the picture on the previous page you would do the following:

- Move the pointer over `memo1`
- Press the Ctrl-Select key sequence. Remember that since the Ctrl and Select keys are the same you need to press Ctrl-Fn-backspace (using the backspace key for its optional Select function) in normal mode, and Ctrl-backspace in Mouse Mode.
- While holding the Ctrl-Select sequence move the pointer over the `files` folder (dragging the icon with it).
- Release the Select key and the file will be copied into the `files` folder.

The resulting screen is shown on the next page.



---

## ***THE WASTE-PAPER BASKET***

---

With the File Manager is associated a waste-paper basket. This is a temporary storage area for files to be deleted. If you put a file into the waste-paper basket the icon will change to remind you that the waste-paper basket is not empty. If you open the icon you will see the files you have placed in there, and you may recover them if you need. You can empty the waste-paper basket by moving the pointer into the waste-paper basket window and pressing the menu key. While holding down the menu key move the pointer to the Delete all Files option and release the Menu key.



---

You will not be able to recover any files that you delete with the Empty Wastebasket option.

---



---

## ***FILE MANAGER SUMMARY***

---

<b>NOTE</b>
-------------

---

For further information on the Deskset utilities please refer to the DeskSet Reference Guide available as part of the Tadpole SPARCbook optional documentation set.

---

- OPENING A FILE**      To open a file you may double-select it, drag it onto an application or the workspace, or Select it and use the File menu to open it. Applications are started in the same way.
- FOLDERS**              You can view the contents of a folder and move to that folder by double-selecting it, or by dragging and dropping it onto the workspace.
- NEW FILES AND FOLDERS**      Make sure you are in the folder where you wish to create a file or folder. From the File menu Choose the Create Folder or Create Document options. A default file or folder will be created with the name NewDocument or NewFolder. This will be underlined and/or highlighted.
- RENAMING FILES AND FOLDERS**      If a file or folder name is underlined you may immediately type in text to change its name (for example after it has just been created). Otherwise Select on the name area underneath the file or folder icon and then type the required text into the space, finishing with the Enter key.

---

**MANIPULATING  
FILES**

You can move files by Selecting the desired file, and then dragging it to a new destination. For example, you may move a file from the current workspace to a folder by dropping it on the folder icon in the File Manager. You can also edit a file or print a file by dropping it onto the Text Editor or Print Tool icon if they are displayed.

To copy files press the Ctrl key before performing the same drag and drop operation as for a move. If the Ctrl key is pressed during the Select operation a copy will be performed rather than a move. Remember to use the Backspace key as the Select key for this operation.

**CLIPBOARD**

The File Manager maintains a Clipboard area which you may use as temporary space to store files. The Cut/Copy/Paste keys on the keyboard or in the Edit menu automatically use the File Manager clipboard when invoked.

**FILE CABINETS**

You can iconize the File Manager to create a filing cabinet of files. The icon will have the name of the directory in last use. You can reuse the File Manager at any time by double-selecting on the Filing Cabinet icon.

---

## ***MAIL TOOL***

---

The Solaris Operating System provides powerful electronic mail facilities. The Mail Tool application allows you to send and receive electronic mail over the Ethernet or modem interfaces to other users.

The Mail Tool icon shows a tray which is either empty (no mail), has closed envelopes in it (mail that has been read) or has new mail envelopes showing (new mail has arrived).



**NOTE**

You should not attempt to use the Mail Tool until you have set up your mail system, including the modem and/or network interfaces. See the Mail Administration, Network and Modem installation sections of this guide for further details and information.

To open the Mail Tool you need to double-select on the icon. Move the pointer over the Mail Tool icon using the Mousekey and press the Select key twice in rapid succession. The main Mail Tool window will appear which provides all the facilities you need to organize your mail. If the icon is not present you will need to start the Mail Tool by Choosing the Mail Tool option from the Workspace menu.

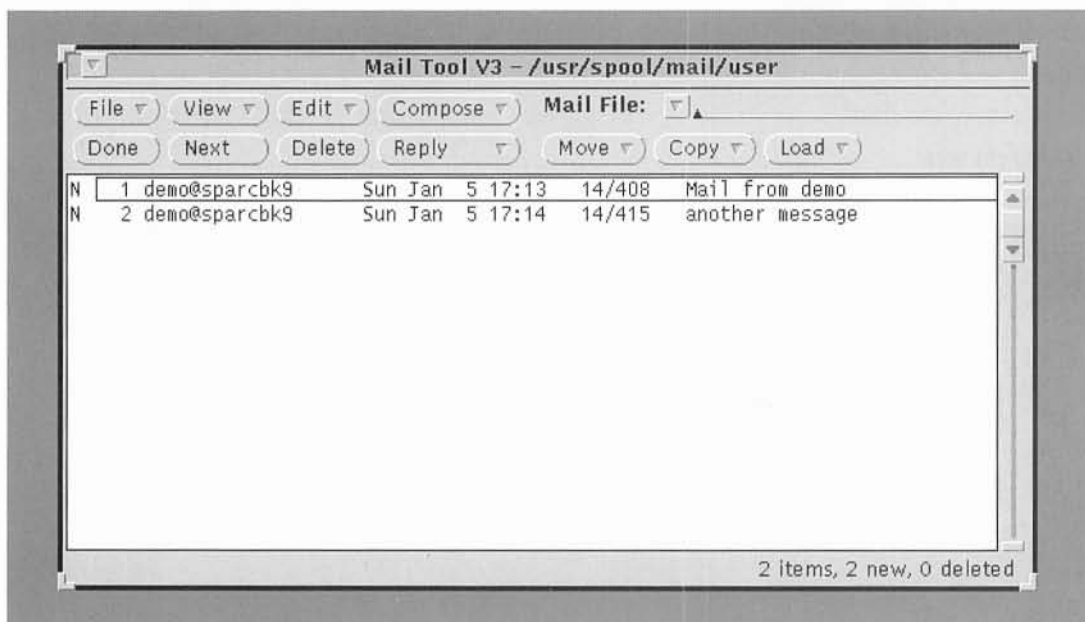

---

## READING MAIL AND REPLYING

---

To view your mail you can simply double select the first item that you wish to view from the list of items displayed by the Mail Tool. Move the pointer over the line containing the message you want to see as shown in the picture and then press the Select key twice in rapid succession. A second window will automatically open showing the selected mail.

If there is an attachment it will be shown in the bottom of the mail window. If you double select on the attachment file icon the Text Editor will be opened allowing you to read or edit the attachment. You can save the attachment to a file by selecting the Copy Out option of the File menu in the attachment area.



You may reply to the mail by moving the pointer to the Reply button and pressing the Select key. A third window will appear with the title 'Compose Message'.

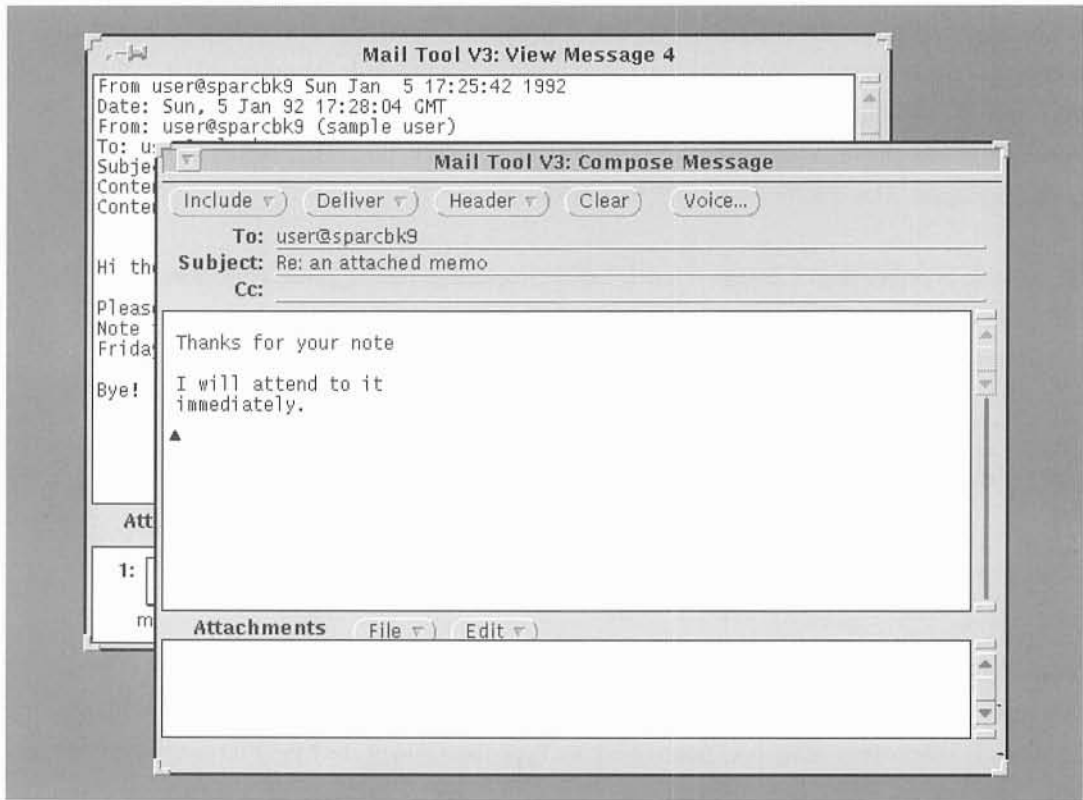

To write your response, move the pointer to the start of the main area and press Select. The window will become selected and a cursor will be displayed at the start of the line. The main window is used to type the mail part of the message. If you want to include all or part of the sender's message in your reply you may select indentation or a bracketed format using the Include menu. Choose the desired menu option (Bracketed, which will place a header and a footer round the message, or Indented, which will use > symbols to show the original text). When you are finished you can simply Select the Deliver button and the message will be forwarded for delivery.

You can either use the Next button or double-select a new item for more mail.

---

## ***DELETING, PRINTING AND SAVING MAIL***

---

If you want to delete an item of mail it must first be selected. Selected items have a rectangular border round the summary line in the main mail window. To delete an item first select it, if necessary, by moving the pointer over the relevant line in the main mail window and pressing the Select key. Once the item has been Selected move the pointer to the Delete button and press the Select key again. The specified item will then be deleted.

If you wish to print a mail message it must first be Selected as for the delete operation. To print a file Choose the Print option from the File menu. The mail message will now be printed on the default printer.

<b>NOTE</b>
-------------

---

Please refer to the system administration section for information on specifying the default printer. Note that the Mail Tool can only print to this printer. If you wish to save a mail file for printing out using the Print Tool you can do so by saving the mail to a file.

---

Incoming Mail can be saved into single files called *Mail Files* which contain collections of mail messages. To create a Mail File move the pointer to the start of the Mail Files text line in the top right hand corner of the Mail Tool main window. Type the name of the Mail File you want to create. Then Select one or more pieces of mail and move the pointer to the Move or Copy button. If you press Select the mail will be saved to the new Mail File. Using the menu options on the Move or Copy buttons you can save mail to different Mail Files. You can review Mail Files by simply selecting the Mail File you want to view from the Mail File menu.

To perform other operations on Mail Files such as emptying, renaming or deleting files you can enter the Mail Files window by selecting the Mail Files option in the File menu of the main Mail Tool window. To perform an operation select the Mail File you want to use and then press the relevant button or menu option in the Mail File window.

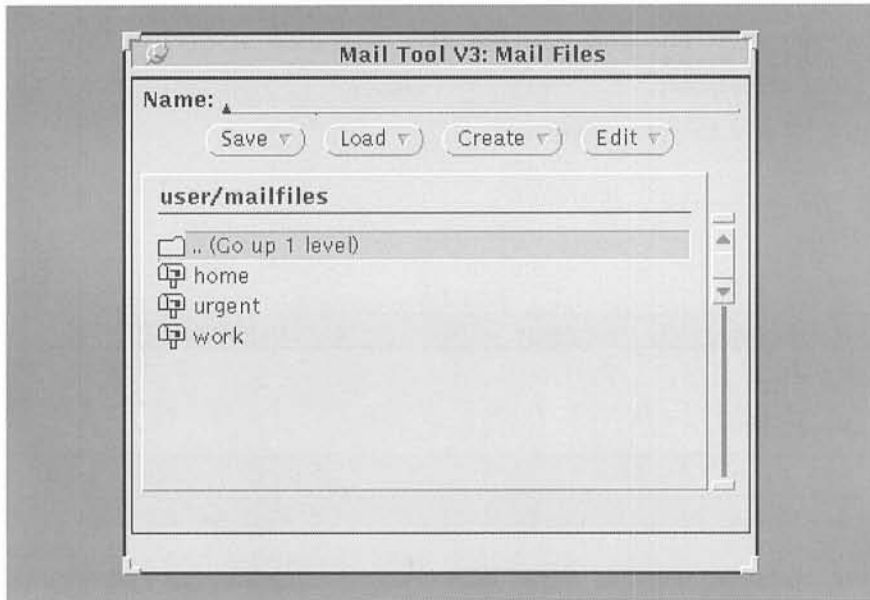

---

## ***WRITING MAIL***

---

To write and send mail you should Select the Compose function. A new message window will be displayed. Type the name of the person who you wish to send mail to and then press the Enter key; You may then enter a subject which will form the header for the mail, and optionally another person to receive a copy. You can then type your message into the main area of the window. You can attach a document by Choosing the Add option of the File menu in the Attachments area. A new small window will appear asking you to enter the directory and the filename of the file you wish to attach. When you have specified the file you wish to attach Select the End button. An icon will appear in the attached area showing the attached file(s).



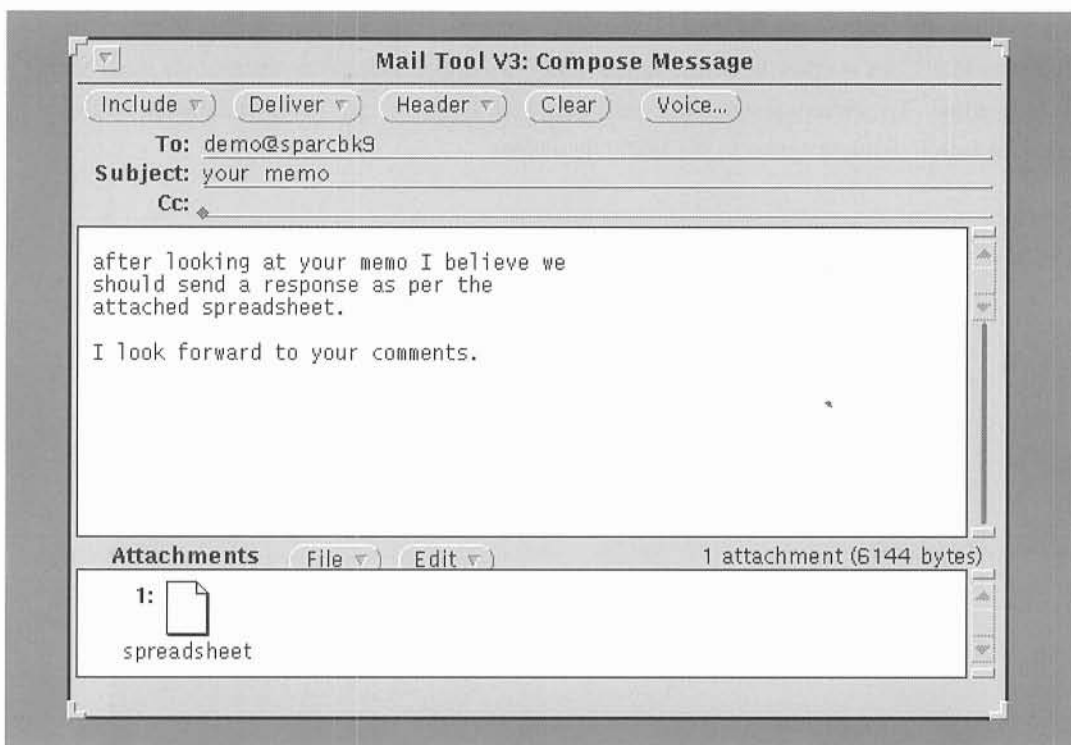

When you have completed your mail operations you may select the Done key to quit the Mail Tool. The Mail Tool window will be once more iconized.

---

## ***AUTOMATIC MAIL RESPONSES***

---

When you are away from the office or on vacation you may leave your SPARCbook switched on and attached to the network unattended, and it can automatically respond to any mail it receives. To use this facility Choose the Vacation Notifier from the Compose menu in the main Mail Tool window. If you Choose the Start menu option a pop-up window will be displayed with a standard message. You can edit this message to your own requirements. The \$\$SUBJECT field should normally be left since the system will automatically insert the title of the author's mail in this field. An example of a modified message is shown.

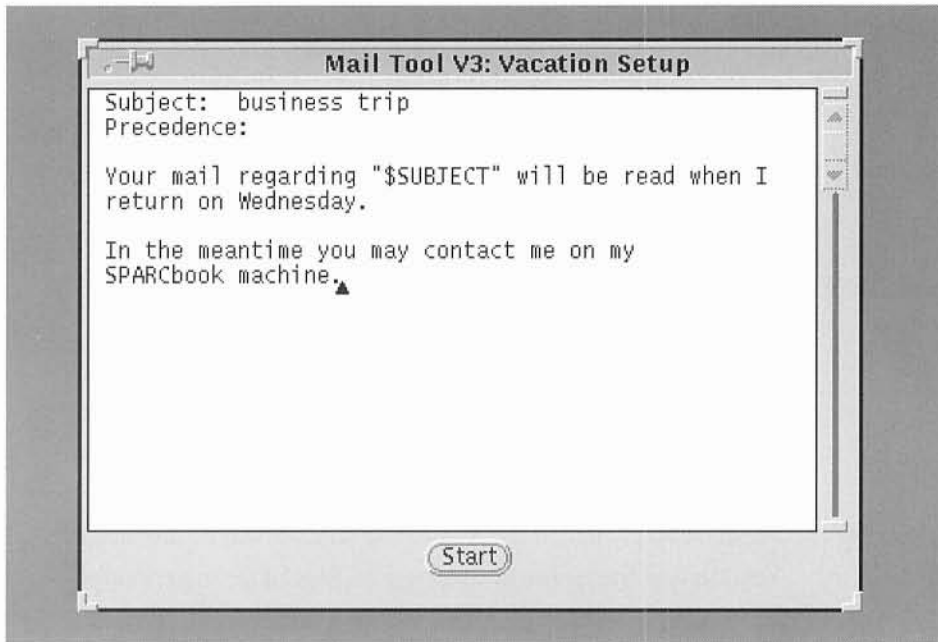

While you are away all messages are stored as normal in your mail in box. Senders are notified that you are away if they send mail to you.

To stop the automatic mail responder on your return Choose the Stop option from the Vacation Notifier menu.

---

## ***MAIL SYSTEM CONNECTION***

---

The bundled SPARCbook Operating System provides facilities to attach directly to a network with access to Internet based electronic mail facilities. The internal SPARCbook modem (USA model only) may also be used to dial in to a remote system to receive your mail. Further information on setting up the network and Electronic mail can be found in the sections covering configuration of the Ethernet and Modem interfaces.

---

## ***MAIL TOOL SUMMARY***

---

For further information on the Deskset utilities please refer to the DeskSet Reference Guide available as part of the Tadpole SPARCbook optional documentation set.

---

- READING MAIL** To read your mail double-select the Mail Tool icon if it is present, or Choose it from the workspace menu if it is not present. The mail window will then appear showing any incoming mail. To read a message move the cursor to the relevant line and double-select. A new window will be displayed with the message.
- REPLYING TO MAIL** Select the Reply button and a Compose window will be displayed. You can type a response by Selecting the start of the main window and writing your message. When you have finished, Selecting the Deliver button will cause the mail to be forwarded and the Compose window to be closed.
- DELETING MAIL** In the mail window Select the item of mail to delete and then Select the Delete button.
- FORWARDING MAIL** In the mail window Select the item of mail to be forwarded and then from the Compose menu Choose the Forward option. A Compose window will be displayed with the message for forwarding. Select the To: field and type the name of the addressee. Then Select the Deliver button to forward the mail.
- SENDING NEW MAIL** In the mail window Select the Compose button. A window then appears for writing a message with fields for the addressee and subject. After you have written the message it can be sent by Selecting the Deliver button. You may attach a file by Choosing the Add option from the File menu.

- 
- SAVING MAIL** Mail can be saved in Mail Files. Select the Mail File using the Mail File menu on the top right hand corner of the Mail Tool window, or type the name of a mail file. Use Move and Copy to save selected Mail Messages to a Mail file. See also the Mail File window selected from the Mail File option of the Mail Tool file menu.
- VIEWING MAIL** Choose the desired Mail File from the Mail File menu button options. This will become the default mail file. If you want to return to the Message In file you simply Choose the Load In-Box option of the File menu on the main Mail Tool window.
- ON VACATION** Choose the Vacation Notifier from the Compose menu in the main Mail Tool window, and Select the Start option. Edit your message and Select Start. On your return Select the Stop option to stop automatic mail responses.

---

## ***PRINT TOOL***

---

The Print Tool application is a simple interface to the printers attached on your own SPARCbook, or remotely on the Ethernet network attached to another machine. Using the Print Tool you can print both PostScript and normal text files to suitable printers. The Print Tool will automatically queue files for printing to one or more printers and print them in the background.

**NOTE**

You should not attempt to use the Print Tool until you have set up your printer system. See the Printer Administration section of this guide for further details and information.

The Print Tool icon shows a graphical representation of a printer with the name of the printer below it. If you need to start the Print Tool you should Choose it from the main Workspace menu options.



The simplest way of printing a file is simply to Select it, to drag it to the Print Tool icon (holding the Select key down) and then dropping the copy onto the Print Icon (by releasing the Select key). This will cause the file to be printed on the printer.

To change the printer you want to send your file to, to stop the printing of a file, or to examine the status of the files that are queued for the printer you will need to enter the Print Tool application by double selecting the Print Tool icon.

The Print Tool window will then be displayed.

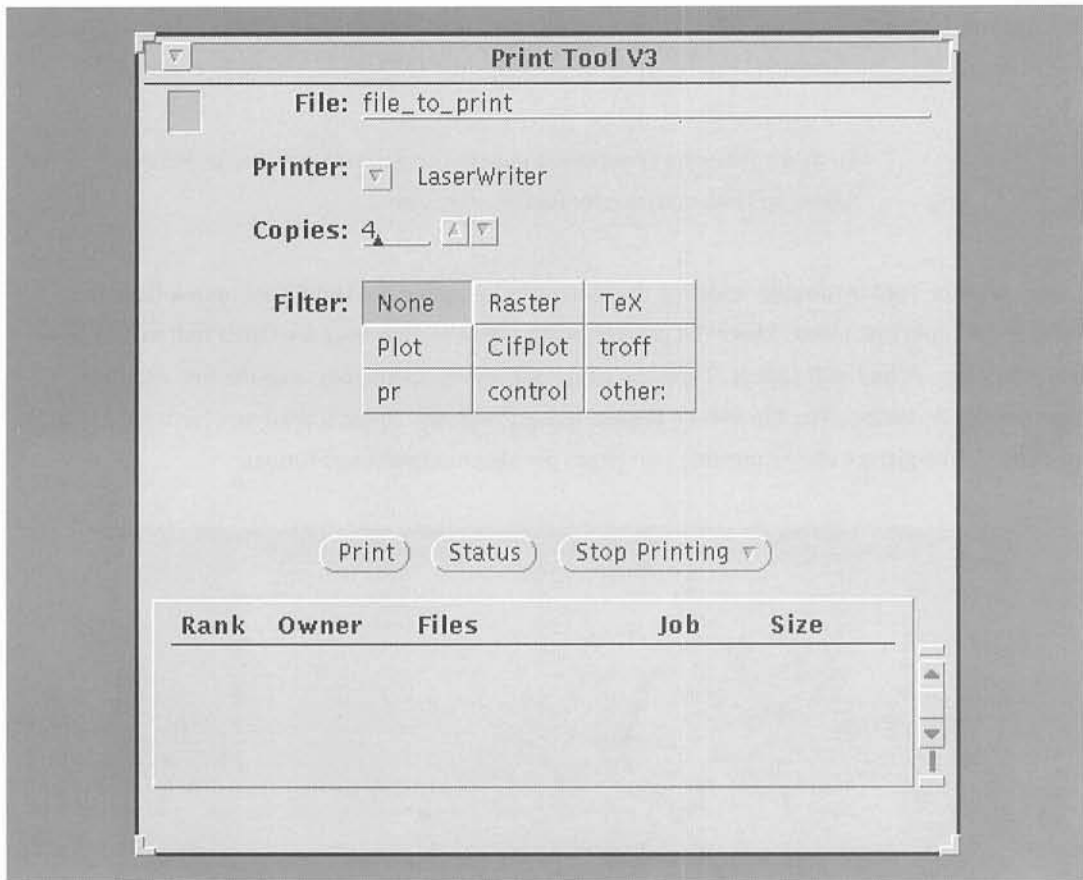

Using the Print Tool you may specify a file to be printed, change the number of copies, or change the selected printer as shown below in the Print Tool summary.

---

## ***PRINTING OPTIONS***

---

By default the Print Tool will print ASCII files to the specified printer. In addition you can specify a *filter* or a UNIX command line. To select a filter you simply Select on the filter name in the Print Tool window. In the SPARCbook bundled Operating System only the *pr* is operational by default. The *pr* filter separates the file into pages and prints a header for each page.

You may also specify a custom filter using available commands from the Solaris Operating System. For example the a2ps command can be used for printing ASCII files to a PostScript printer.

**NOTE**

To try the following example you must be using a PostScript printer. Please refer to the Setting up Printers section for further information.

Open the Print Tool by double-selecting the icon or by choosing the Print Tool option from the Workspace programs menu. Move the pointer to the filters section over the Other button and press the Select key. A line will appear. Type one of the following commands onto the line and then Select the Print button. The file will be printed using PostScript in the format you have specified. As an example the picture shows printing two pages per sheet in landscape format.

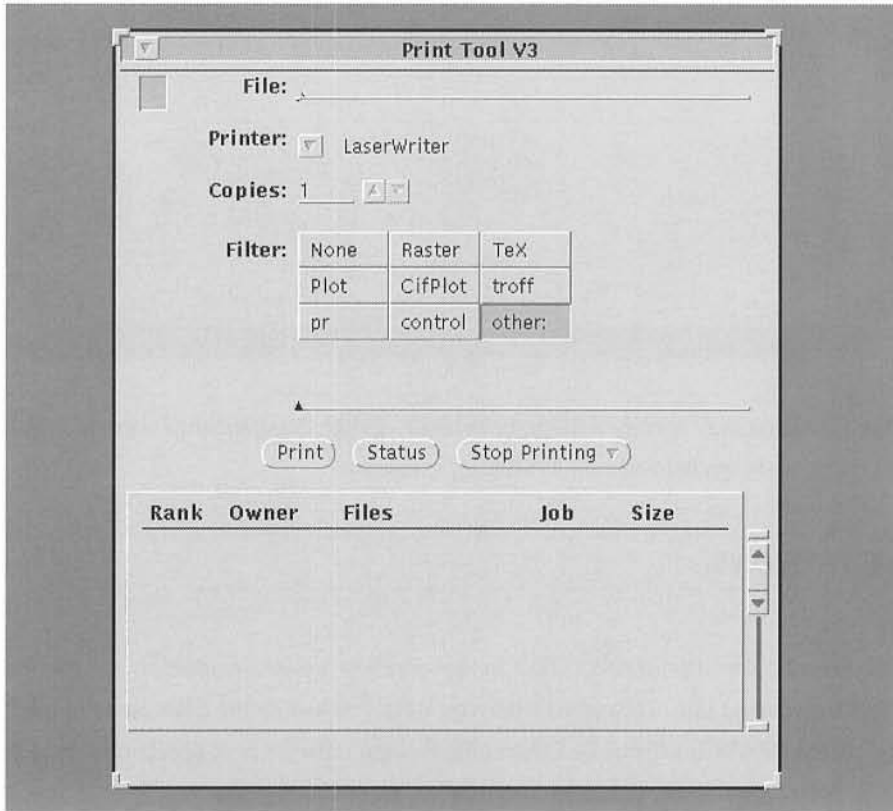

---

**NOTE**

The Solaris printing system is capable of dealing with a large number of different printers and print options. To describe them all is beyond the scope of this guide and you should refer to the complete Solaris documentation for further information.

---



You should always ensure that the specified printer is connected before trying to print the file. For example, if you try and print to a printer on a remote system when not connected to the Ethernet network you will be given warning error messages.

---

---

***PRINT TOOL SUMMARY***

---

**NOTE**

For further information on the Deskset utilities please refer to the DeskSet Reference Guide available as part of the Tadpole SPARCbook optional documentation set.

---

**PRINTING FILES**

To print a file Select the required file from the file manager window or desktop. Holding the select key down drag the file icon on top of the required printer icon and drop the file by releasing the select key. Alternatively, enter the print tool by double selecting on the Print Tool icon and specify the file name in the 'File' section at the top of the window. Then select the Print button to print the file.

**MULTIPLE COPIES**

In the Print Tool Window either type the number of required copies or use the Select key with the mouse pointer over the up or down arrow to choose a number of copies.

**PRINT STATUS**

Select the Status button to display the status of files to be printed.

**STOPPING  
PRINTING**

If you want to stop the printing of a particular file Select the file from the status part of the Print Tool window. Then move the mouse pointer to the Stop Printing button and press the menu key. Choose the 'Selected Print Job' option and release the menu key. Alternatively you may Choose the 'All Print Jobs' option to stop the entire print queue.



---

## ***CALENDAR MANAGER***

---

The Calendar Manager is an application which allows you to keep a diary and schedule. In a networked environment it also allows you to access and look up the calendars of other users on a network. The Calendar Manager icon shows the current date.

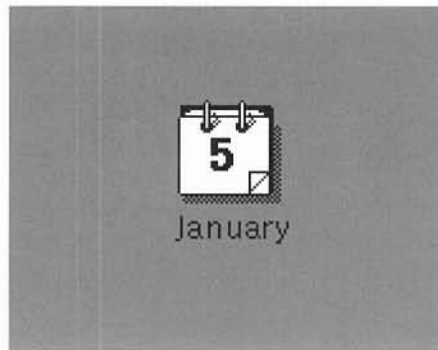

To open the Calendar manager double-select on the Calendar icon. If the icon is not present you will need to Choose the Calendar Manager from the Workspace Menu.

By default the Calendar Manager displays a month at a time. You can change this to a day, a week or a year at a time by Choosing from the View menu. For example, to change to a week at a time view move the pointer to the View button and press the Menu key. While holding the Menu key down move the pointer to the Week selection and release the Menu key. The current week will then be displayed on the main window. Depending on whether you are viewing by day, week, or month you can look at the next or previous period by selecting the Next or Prev buttons on the top right hand corner of the window. Selecting Today will always bring you back to the current view.

---

## APPOINTMENT AND TO DO LISTS

---

As well as the main window you can pop-up separate windows at any time to display lists of all Appointments and Todo items for a particular day, week, month or year. First Select the day, week or year you want the lists for (by default it will be the current period). To pin up the ToDo list for the selected day Choose the ToDo option from the second level menu behind the View button.

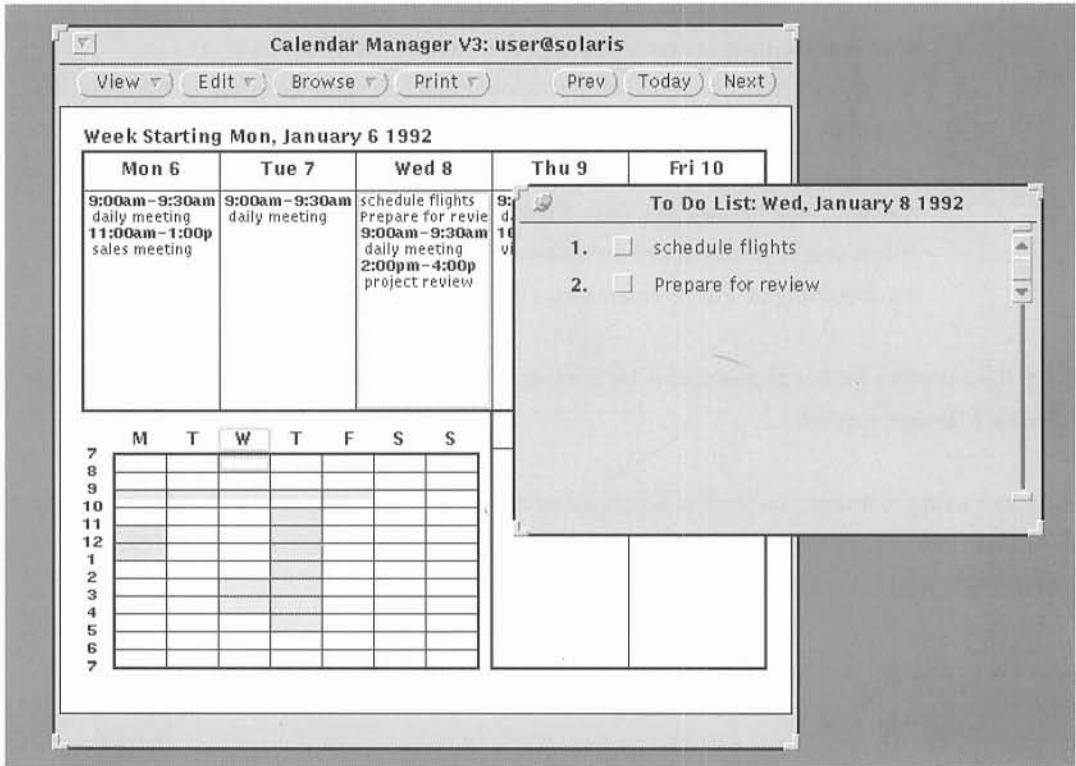

---

To enter an appointment or ToDo item you need to Select the day you want to schedule for and then Choose the Appointment or ToDo option in the Edit menu. Then follow the steps below:

- Type information describing the appointment in the What field.
- Move the pointer to the Start menu button and Select a Time. Each hour has a submenu with 0, 15, 30 and 45 minute options. By default the time in the End field will be set to one hour later. To change the End time use the End menu button.
- If the appointment or meeting is a regular one you can use the Repeat button menu to choose the time between meetings (for example daily or weekly)
- If you want to be reminded of the appointment Select the beep and/or flash buttons.
- Normally others on the network you have access permission granted by will be able to see your appointments. If you want to keep this appointment private you can Select the 'Your Eyes Only' button.
- When you have entered all the information you need Select the Insert button and the appointment will be entered into the Calendar Manager.

If you want to enter further appointments for another day double-select on the new day in the main Calendar Manager window.

To Delete an appointment you need to Select a date and display the appointment window using the Edit menu. Then Select the appointment in the list you want to delete and Select on the Delete button. ToDo items may be deleted in the same way.

Likewise to *change* an appointment or ToDo item select the Change button rather than the Delete button.

---

## ***BROWSING REMOTE CALENDARS***

---

Using the Calendar Manager you can look at other peoples' Calendars if you are included on their Access List. This way it is possible to schedule meetings and to send mail to each meeting attendee about a new appointment. To look at other Calendars you need to Choose the Multi-Browse option from the Browse menu.

Using the Multi-Browse display you can overlay different Calendars to see if a free time slot is available. Alternatively you can Select a time from the main Calendar Manager window and see in the Multi-Browse display who is busy at that time. In the example three calendars are displayed. The check mark in the scrolling list shows that `md@solaris` (the user `md` on the machine named `solaris`) is busy at the time that was selected.

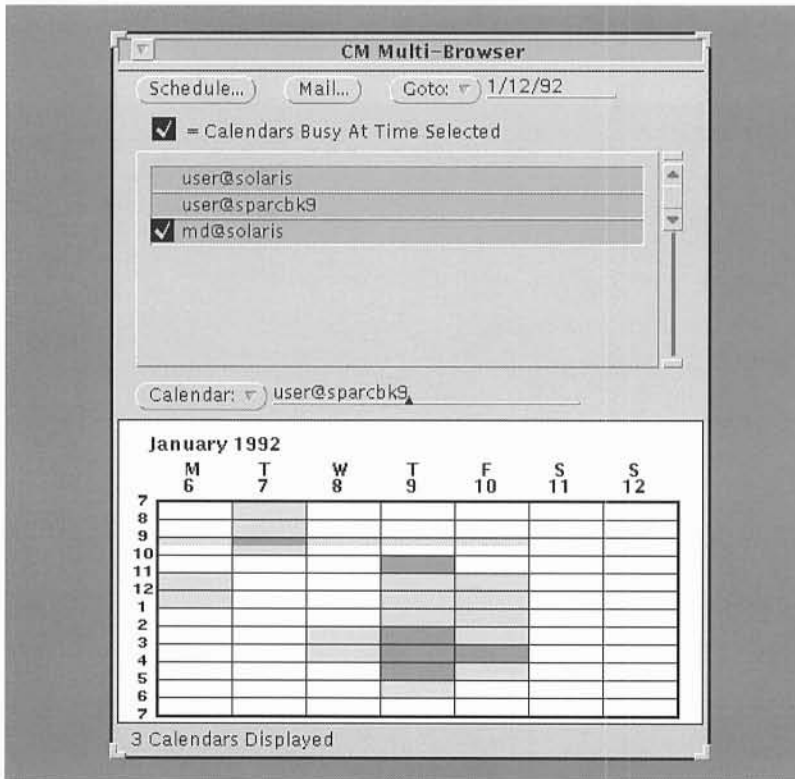

In order to add calendars to the Browse menu you need to be in the Multi-Browse window. Type the login name of the user you wish to see. If the user is not a local user (not one on your own machine) you also need the '@' symbol, followed by the user's machine name. For example:

`tim` would be the user with login `tim` on your own machine  
`bob@jupiter` would be the user with login `bob` on the machine called `jupiter`.

Using the menu you can add, delete, or sort the calendars that you access.

---

## ***SCHEDULING MEETINGS***

---

Once you have found a suitable appointment time you can schedule the appointment into the calendars of all the users who have given you Insert Access. Double-Select on the starting time you would like to schedule the meeting for in the Multi-Browser menu. The Appointment editor window will then appear.

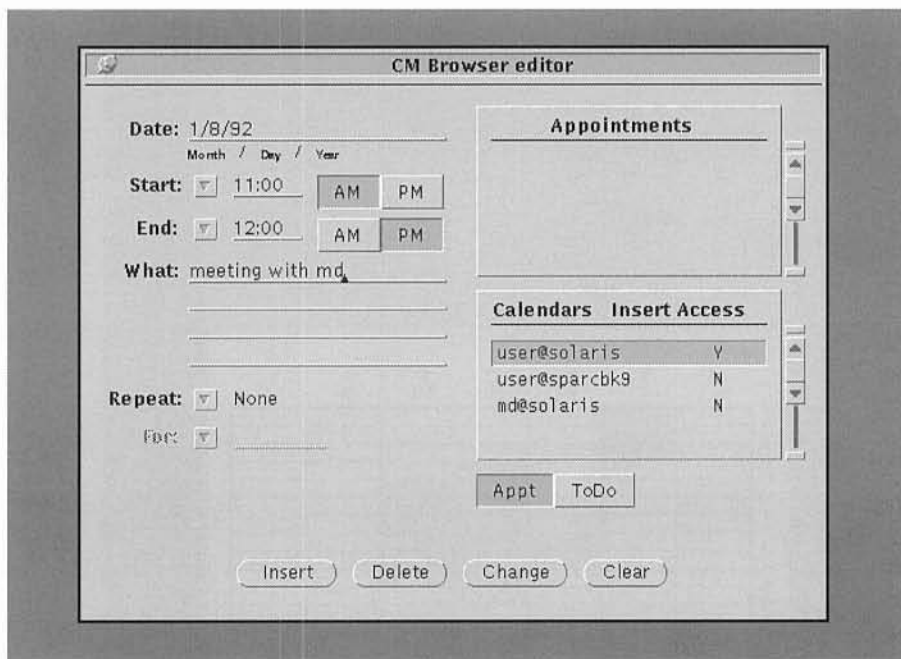

---

Follow the steps below to schedule the meeting:

- The Selected time will be filled in, although you can change the meeting start or end by Selecting the Start and End buttons.
- Fill in the meeting details in the What: text field.
- Press Select on the Insert button to add the appointment to all the Selected Calendars (these will be those that you have Insert Access permission for).

You can send mail to the meeting attendees using the mail facilities in the Calendar manager. This can also be used to mail those users for whom you do not have Insert Access permission so that they can schedule the appointment themselves.

To send mail to all the users whose calendars you have selected, you should Select the Mail... button in the Multi-Browse window. The meeting subject and times will already be filled in. You may modify the message or add to it before sending if you so wish. When you are ready to send the mail, Select the Deliver button.

---

## ***CUSTOMIZING THE CALENDAR MANAGER***

---

You can customize the Calendar Manager to your own requirements by Choosing the Properties option from the Edit menu in the main Calendar Manager window. In order to see all the options you may use the Menu button at the top of the window. The Access List and Permissions option allows you to specify who can Browse your own Calendar, who can insert and who can delete appointments.

The default is that the World (ie all users) can Browse your Calendar but not modify it.

<b>NOTE</b>
-------------

---

Remember that even when others can browse your Calendar they will not be able to see items that you marked with the Your Eyes Only setting.

---

You may add or delete users from the list using the same procedure as when adding remote users to the Browsing facility (see above).

---

## ***PRINTING CALENDARS***

---

Using the Calendar Manager you can print day, week, month or year view calendars, as well as Appointment and ToDo lists onto a local or remote PostScript printer. If you are not using the default printer you can select a different printer using the Printer Settings option in the Properties menu. This is accessed from the Edit menu in the main Calendar window.

<b>NOTE</b>
-------------

---

You should not attempt to use the Printer until you have set up your printer system. See the Printer Administration section of this guide for further details and information.

---

To print Calendar views Select the day for which you want to print. Then move the pointer to the Print button and select the day, week, month or year button for the period for which you want a print out. Finally, you can print the appropriate appointment and ToDo lists from the Print menu submenu if you wish.

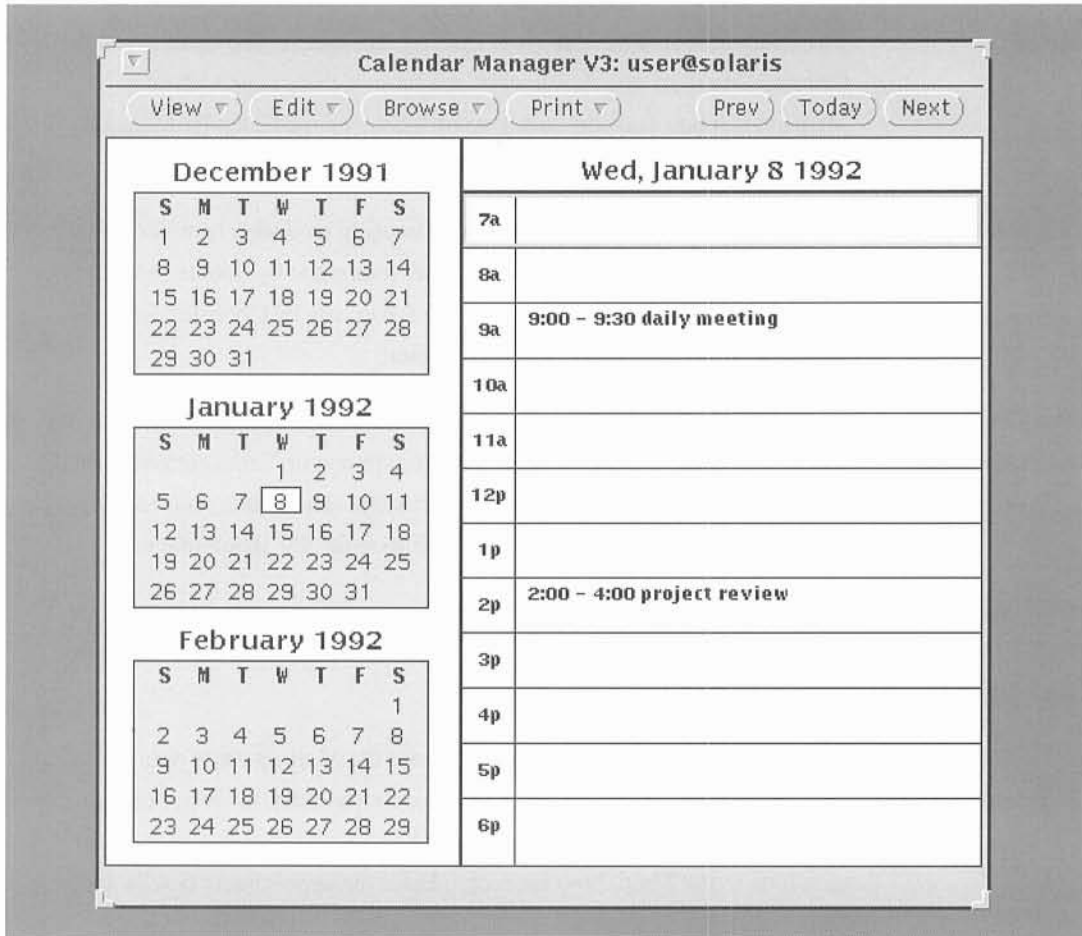



---

## **CALENDAR MANAGER SUMMARY**

---

<b>NOTE</b>
-------------

For further information on the DeskSet utilities please refer to the DeskSet Reference Guide available as part of the Tadpole SPARCbook optional documentation set.

---

### **ICON**

The Calendar Manager Icon shows the current date. If you want to use the Calendar Manager double-select on the Icon. If there is no Calendar Manager running you can start it up by Choosing the Calendar Manager option from the main Workspace menu.

### **VIEWING**

View by day, week, month or year by Choosing an option from the View menu. Change the day you period you are looking at by double-selecting on the period. Look at Appointments or ToDo lists by Choosing from the second level menus behind the View button.

### **MAKING APPOINTMENTS**

Use Select to choose the day you require to make an appointment. That day will then be highlighted. Choose the Appointment or ToDo options from the Edit menu. Type in and Select the information, time, alarm and Your Eyes Only as required. Select the Insert button to make the appointment.

### **CHANGING/ DELETING APPOINTMENTS**

Select a date and Choose the Appointment or ToDo option from the Edit menu. Select over the item(s) you want to delete and Select the Delete or Change button.

### **USING OTHER CALENDARS**

To Browse other peoples calendars Choose the Multi-Browse option from the Browse menu. Select the Calendars you want to view. Select a Selected Calendar to remove it. To make an appointment double-select on a time in the Multi-Browser menu. Enter the appointment details and Select the Insert button.

### **PRINTING**

Choose a day, week, month or year view to print from the Print menu. Move to the Second level menu to print an Appointment or ToDo list.

---

## ***TEXT EDITOR***

---

The Text Editor is a simple editor application for text documents. It does not have the capabilities of a word processor. To access the text editor you can either drag and drop an existing text file onto the workspace or you can explicitly open the editor for a new edit from the Workspace menu. To start up the editor move the pointer to an unused area of the workspace and press the Menu key. From the Programs menu select the Text Editor option. The base Text Editor window will then be displayed.



The header displays the name of the file you are editing (or "NONE" if you have not yet assigned a name to the file) and shows you the directory where it is located. When you have made changes the word "edited" is displayed following the file name.

---

## ***MANIPULATING TEXT***

---

To create text Select the window by placing the pointer in the main window area and pressing the Select key. Then type the desired text into the window. The Del or Backspace keys will erase text and you can use the cursor keys or the Mousekey pointer to move the text insertion point.

You can select an area of text using the Select and Adjust keys as follows:

- Move the pointer and press Select to set the insert point
- Select a word by moving the pointer over a word and double-selecting (press the Select key twice in rapid succession)
- Select a line by moving the pointer to the line and triple-selecting
- Select the entire document by quadruple-selecting
- Select an area of text by moving the pointer to the start of the desired region and pressing the Select key. While holding the key down move the pointer to the end of the area and release the Select key. Alternatively use the Select and Adjust keys.
- Selected text may be deleted (by pressing the Del key), replaced (by just typing the replacement text), cut or copied (by using the Cut or Copy keys). Text may be pasted to a different place or a different window using the Paste key.

---

## ***TEXT FILES***

---

The File menu allows you to load and save your text files. To load a file you can Select the Load File option in the File menu. A popup window will ask you to specify the directory and the file name. By default the selected directory will be your home directory where your own files normally live. Similarly you can save the current file or include another file from the File menu options.

Note that the Text Editor stores text as you write it. If you write a long line of text without Carriage Returns the text will be wrapped to display separate lines. However the text is stored as a single line. You can format a document into lines of no longer than 72 characters from the Extras menu. To access the Extras menu move the pointer into the main Text Editor window and press the Menu

---

key. While holding down the Menu key move the pointer to the Extras option and then to the Format option. This will reformat the text into lines of no more than 72 characters so that it is suitable for printing.

---

## ***TEXT EDITOR SUMMARY***

---

<b>NOTE</b>
-------------

For further information on the DeskSet utilities please refer to the DeskSet Reference Guide available as part of the Tadpole SPARCbook optional documentation set.

---

**OPENING A FILE** You can open a file by selecting it from the File Manager window and dragging it onto the Workspace. Alternatively you can start the Text Editor from the Workspace menu and can specify a file to load from the File menu of the main Text Editor window. To do this move the pointer to the Workspace area and press the Menu key. While holding the Menu key down Select the Text Editor option from the Programs menu. When in the Text Editor move the pointer to the File button and Select the Load File option using the Menu key. Specify the directory and file name in the pop-up window and Select the Load File button. The requested file will be loaded into the Text Editor.

**SAVING FILES** To save a file move the pointer to the File button and select the Save File Option using the Menu key. Enter the desired file name into the Save File pop-up menu and Select the Save file button.

**PRINTING FILES** Depending on how you have entered text you may want to format the text into lines before printing. See the main section above for details. To print a file you can either save it and print it from the File Manager or you can simply Drag and Drop it onto the Print Tool application. To do this move the pointer to the Text symbol on the top right hand side of the Text Editor window and press the Select key. While holding the key down move the pointer which drags the text symbol until it is over the Print Tool. Release the Select key and the file will be printed.

---

## ***FAX TOOL***

---

The Fax tool is provided to allow you to send Faxes using the modem interface. This tool allows you to specify an ASCII or a PostScript file and to send it by Fax to a specified destination. It also provides the facilities to send more than one file (for example a PostScript header page and ASCII text ) as a single Fax.

**NOTE**

The Fax utility uses the internal modem interface. Before using the Fax facility you must connect the modem interface to the telephone line. Refer to 'The Internal Modem' for more information on setting up the modem interface.

If the Fax Tool icon is not on your workspace you can start up the application by Choosing the Fax Tool from the Workspace programs menu. To send a Fax you can drag and drop a text file onto the Fax icon. A pop-up window will appear asking you to select a Fax number to send the Fax to. The last number dialed is the default.



If you want to send more than one file, or to configure the Fax Tool, you can open the Fax Tool window by double-selecting on the Fax Tool icon.

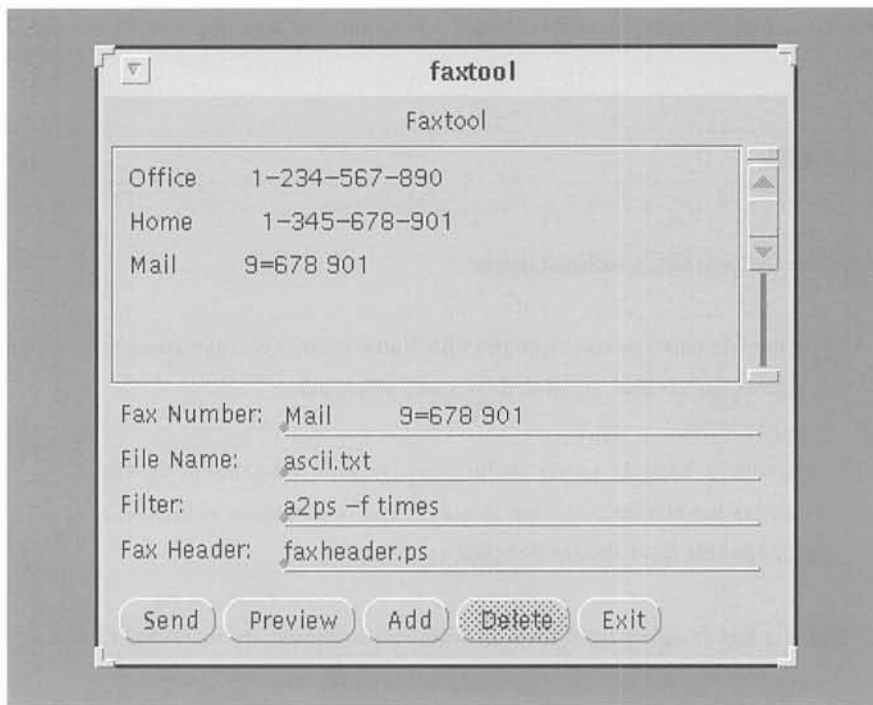

---

## ***SETTING UP A FAX DIRECTORY***

---

The top section of the Fax Tool shows a list of the currently available Fax Numbers. When you first start up the Fax Tool this box will be blank. To add a Fax number move the pointer to the Fax Number field and Select the text field. Now enter a name and a Fax number. The name (which must start with a lower or upper case letter from A-Z) is used to sort the Fax numbers. The number may include the following special characters:

- = Specifies to wait for a secondary dial tone before proceeding
- Specifies to delay for 4 seconds

---

You may insert spaces in the number for readability, and these are ignored.

To add a number Select the Add button once you have entered the details into the Fax Number field. To delete entries Select one or more numbers from the Fax Number area and then Select the Delete key.

---

## ***SENDING FAXES***

---

To send a Fax follow the procedure outlined below:

- Type the file name to send into the File Name field. You may specify multiple file names on the line, separated by space characters.
- If you want to include a separate header page type the name of the file containing the header you want to use. If you do not want to include a header file this field should be blank (see below).
- Select a Fax Number from the Fax Numbers available, or Select the Fax Number field and enter the required Fax number.
- Select the Send Button.

The Fax will then be sent. A pop-up window will advise you when the Fax transmission has successfully completed. If the Fax was only part transmitted, or if the remote number is busy (engaged) you will be given an option between Retrying and Aborting the operation.

---

## ***POSTSCRIPT AND ASCII FILES***

---

The Fax Tool operates on PostScript format files. PostScript is a graphics description language developed by Adobe Systems. The Fax Tool automatically detects whether the files you have specified are PostScript files, or normal ASCII text files.







---

## ***PREVIEWING FAXES***

---

If you Select the Preview button, instead of the Send button, the Fax Tool will show the Fax on the SPARCbook screen to review its format. (This may also be used as a simple viewer for PostScript files, but is not as sophisticated as the `pageview` utility). You can use the next button to sequence through the pages, or you can type a page number to view. If you un-pin the pop-up window the previewer will exit. If you then wish to send the Fax you can Select the Send button in the main Fax Tool window.

---

## ***FAX TOOL SUMMARY***

---

- SENDING A FAX**      Drag and Drop a file from the File Manager onto the Fax Icon.  
Alternatively, if no Icon is displayed Choose the Fax Tool from the Workspace programs menu and type the Fax number and file name into the relevant text fields. Select a Fax number from the directory and then Select the Send button.
- FAX DIRECTORY**      Open the Fax Tool and Select the Fax Number field. Type in the name (starting with lower or upper case A-Z) and then the Fax number. Select the Add button to add the entry. To delete a number first Select it in the directory part of the window and then Select the Delete button.
- FILTER**                You may specify a command line to preprocess text files for the Fax Tool. This filter output must be PostScript. See the examples above for further information.
- PREVIEW**             You can preview a Fax a page at a time. Select the Preview button in the main Fax window.

---

## COMMAND TOOL

---

The Command Tool provides a terminal interface into the Solaris Operating Environment. You may have multiple Command Tools running at any one time. Using the Command Tool you can directly access all the UNIX Operating system commands and facilities directly. These facilities are required to perform some of the system administration procedures described later in this Guide. Appendix A gives a summary of the UNIX commands available in the bundled Solaris 1.0.1 Operating System. Solaris 1.0.1 provides a choice of command line interpreters or UNIX 'shells'. The Command Tool will open a new shell of the same type as your login account . (by default the 'C' shell, `csh`).

**NOTE**

By default the erase character is set to the DEL key. The interrupt character to stop a process is the Ctrl-C key sequence. The backspace key sends a Ctrl-H sequence to the command tool which will not erase a character. If you make a mistake typing a command line use the DEL key to erase it, unless you have changed the default erase key.

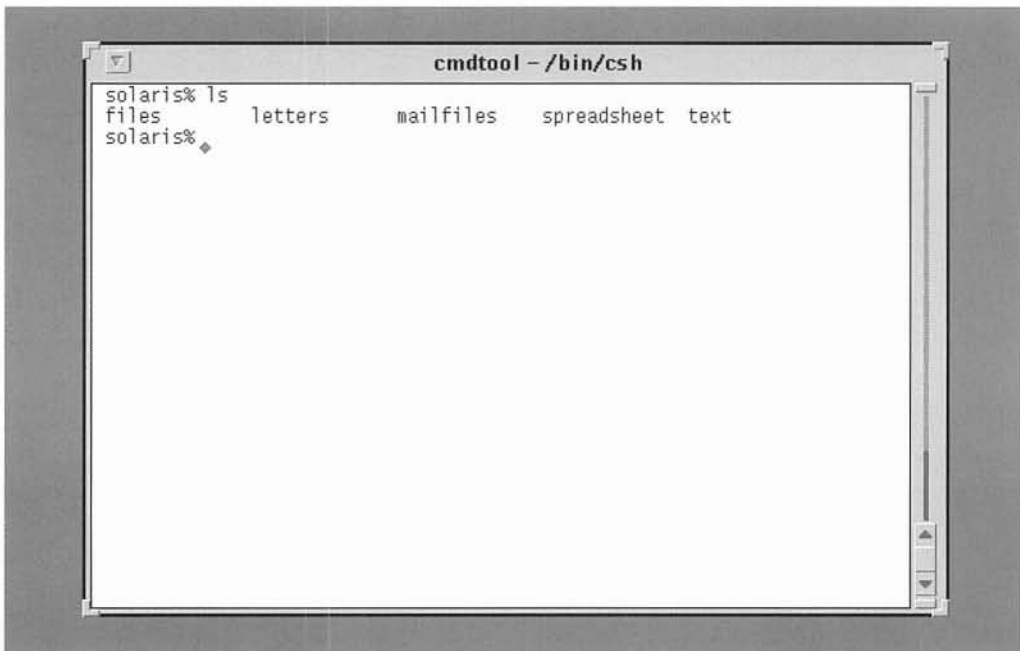

The screenshot shows a window titled "cmdtool - /bin/csh". Inside the window, a terminal session is displayed with the following text:

```
solaris% ls
files      letters   mailfiles spreadsheet text
solaris%
```

The terminal prompt "solaris%" is followed by the command "ls", which outputs a list of files and directories: "files", "letters", "mailfiles", "spreadsheet", and "text". The prompt "solaris%" appears again on the next line, with a cursor character (a small diamond) at the end.

---

**NOTE**

For further information on UNIX Shells, the command line interface, and the available UNIX utilities you should refer to UNIX manuals, textbooks, or the Optional complete SPARCbook Documentation set.

---

You can see a 'history' of previous output by using the sliders on the edge of the command tool window. For information on customizing the command tool window see 'Configuring your Deskset Environment'.

---

***CLOCK AND CALCULATOR***

---

Several other tools are bundled with the SPARCbook implementation of Solaris 1.0.1. In particular, the general purpose Clock and Calculator are available from the Workspace menu and provide basic clock and calculator functions. Both applications have additional facilities which are summarized below.

---

**NOTE**

For further information on the DeskSet utilities please refer to the DeskSet Reference Guide available as part of the Tadpole SPARCbook optional documentation set.

---

---

***CLOCK SUMMARY***

---

**DISPLAY CLOCK**      The Clock can be displayed as an icon or as a window. To start the clock Select the clock from the Workspace menu by moving the pointer to an unused part of the workspace and pressing the Menu key. Select the clock option and the clock menu will be displayed. To display as an icon Select the icon button on the top left hand corner. You may also resize the clock window using the Resize corners.

**CUSTOMIZING**      You can customize the clock by selecting the Clock properties window. Move the pointer into the main Clock and press the Menu key. Select the properties option and a popup window will appear.

---

**ALARM CLOCK** From the Properties window you can set a stopwatch (watch the clock as you reset, start and stop the stopwatch), or set an alarm time. The system will beep at the specified time unless you specify a command to be carried out instead.

---

## ***CALCULATOR SUMMARY***

---

**STARTING UP** You can start up the calculator from the Workspace menu by Choosing the Calculator option from the main Workspace menu. This can be iconized by Selecting the Icon button on the top left hand corner of the window.

**MENUS** Buttons with the triangular menu symbol have menus of options accessed in the normal way by moving the pointer over them and pressing the Menu key.

**MEMORIES** The calculator has 10 memory registers accessible with the Mem..., Rcl, Sto and Exch buttons.

**FUNCTIONS** Using the Fun button you can define your own functions. If you Select the Fun button a popup window appears. You can define up to 10 functions numbered 0-9. Enter a name into the Description field and the function in the Value field. When you Select the Enter Function button the function will be stored and will then appear in the Fun menu whenever you use the calculator.

---

## ***CONFIGURING YOUR DESKSET ENVIRONMENT***

---

The Deskset Environment is set up when you start up OpenWindows. You can easily change the default applications that are started up and the appearance of the screen to suit your own requirements.

When you log in, the File Manager and the console window are started by default. As an example you might prefer not to use the File Manager, and instead have two command tools come up automatically, one as an icon and one ready to use. To do this create your desired set of applications on the screen as you would like to see them when you start up OpenWindows. Using the given example you would quit the File Manager and set up two command tools, one iconized. When you have your desired set of applications on the screen, Select the Save Workspace option in the Utilities menu. After a few seconds a pop-up window will say that your save operation is complete. When you next start-up OpenWindows your workspace will start with the same applications as currently on your screen.

To change the Workspace appearance and operation Choose the Properties option from the main Workspace menu. A window with the available colors will appear showing a corner of a window and a block of the various color options supported by the SPARCbook. Using the internal LCD display on monochrome SPARCbook models these will be shown as gray-scale shades, but on an external color monitor you will be able to choose different colors. You can experiment with the options to change the default Workspace appearance, and the small sub-window will reflect your changes. If you Select the Apply button the changes will be applied to your Workspace and will be saved. At any time you can revert to the factory preset values by Selecting the Reset button.

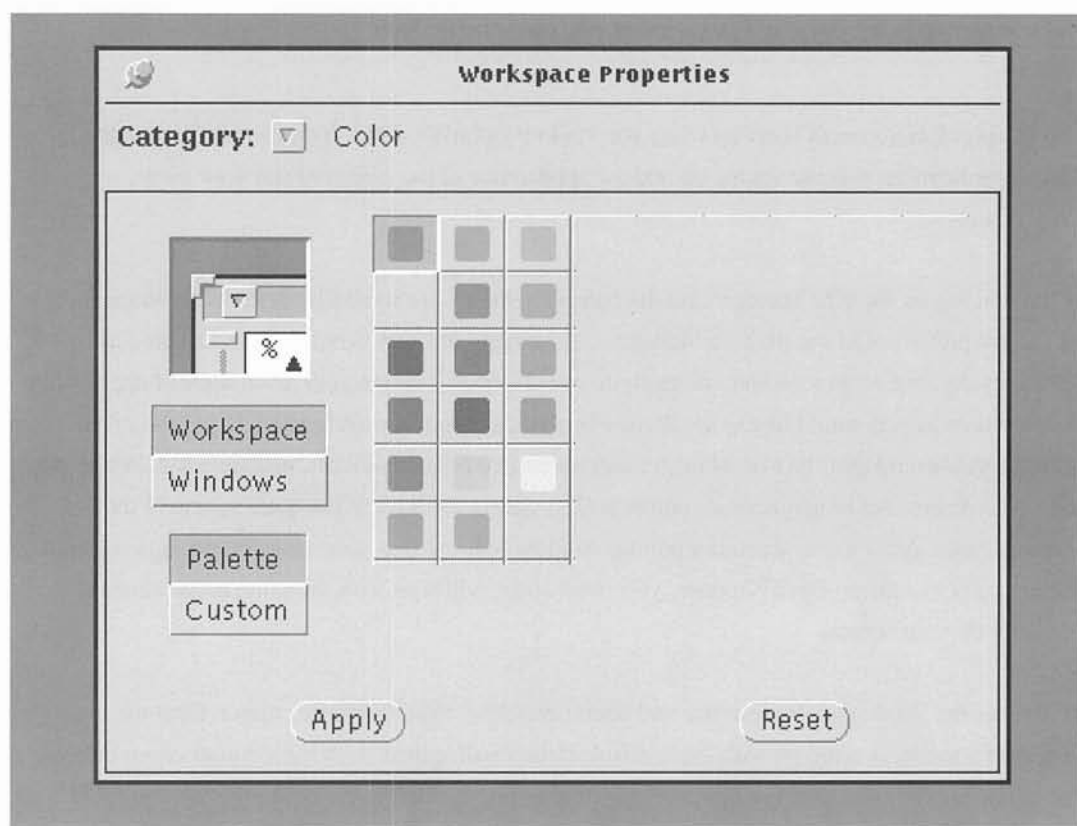

Using the Category Menu you can also experiment with other options for the Workspace Manager.

---

## *CUSTOMIZING OPENWINDOWS MENUS*

---

Using OpenWindows it is possible to configure your own menus. For example, you might want to add a particularly often-used command, or an application, to the main Workspace Menu.

- Open the Top Level Menu Configuration file

The menu configuration file is called `/usr/openwin/lib/openwin-menu`. First copy this file into your own directory using the File Manager or the `cp` command. Rename the new file `.openwin-menu`. From the command line (at the UNIX shell prompt or from the `cmdtool` prompt) this can be achieved with the following commands which first change directory to the default of your home directory, and then copies the file to the new name.

```
sparcbook% cd
sparcbook% cp /usr/openwin/lib/openwin-menu .openwin-menu
sparcbook%
```



---

Using a text editor (either the OpenWindows Text Editor or a UNIX editor such as `vi` from a `cmdtool`) open the new file for editing.

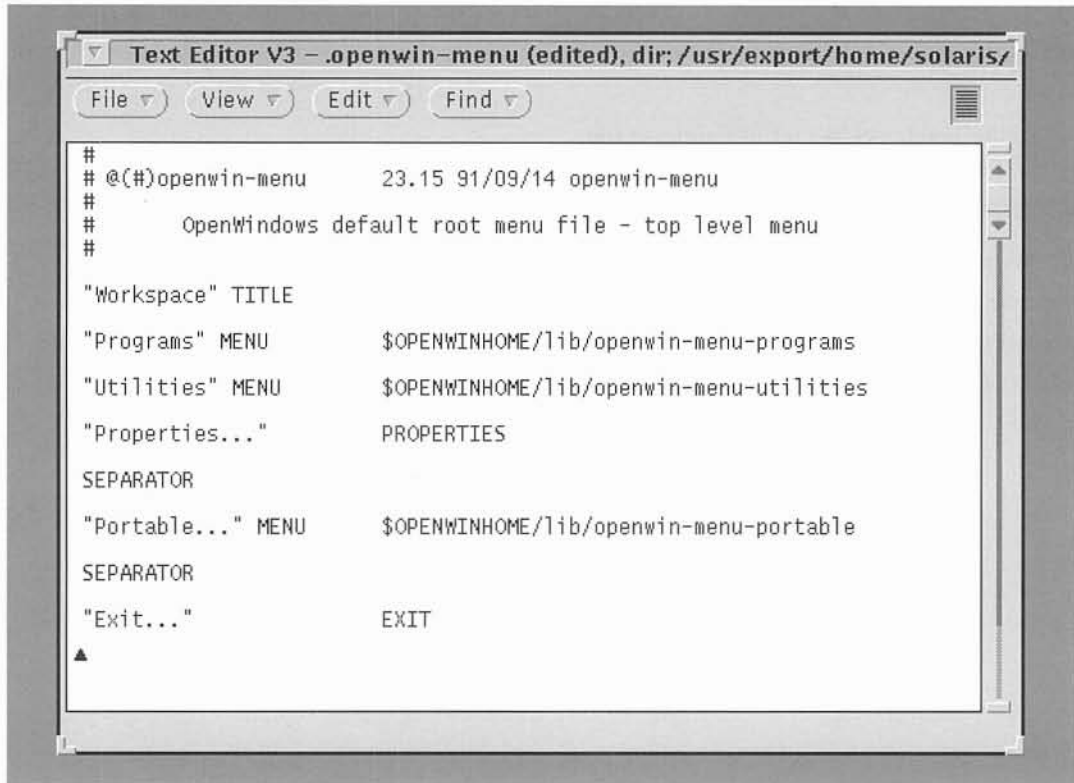

- Create new Entry

As an example you might add the following line below the Portable entry:

```
"My Menu"          MENU      $HOME/.openwin-menu-mine
```

This will set up a new entry called My Menu, and will use the new file specified to determine the contents of the new menu. `$HOME` is a mnemonic that specifies your normal login directory, called your *home* directory.

- Edit a menu file if specified

If you have specified a new menu file you now need to create it. You can look at the existing examples such as the `programs` menu file which resides in `/usr/openwin/lib` and is called `openwin-menu-programs` for the structure of the new file. To cause a command or application to be executed when the menu option is chosen you end the entry with an `exec` line. For example, suppose that you wanted to set up My Menu to have two options. The first will print the date. The second will start up the `xfontsel` program which can be used to select available system fonts. The `.openwin-menu-mine` file might look like this:

```
#
# After the hash you may place comments
# My own menu
#

"Mine"    TITLE PIN           # Title and specify a pushpin

"Date..."      exec /usr/bin/date
"Fonts..."     exec $OPENWINHOME/bin/xfontsel
```

- Exit and Restart OpenWindows

In order for OpenWindows to use the new configuration it must be restarted. To exit OpenWindows Select the Exit option from the main Workspace menu. When you are back to the prompt or your log in message either restart OpenWindows using the `openwin` command, or log back in. The new menu should now be available.

---

## ***MODIFYING KEY MAPPINGS***

---

In certain cases you may need to modify the actions taken by some of the keys. For example, an application may use one of the keys designated as Cut, Copy, Paste etc for its own purposes. Often the application itself will provide facilities to remap its use of the keys, and you should refer to the application manual for further information. However, it is possible to modify the standard key mappings from the Operating System.

---

To do this first copy the file `/usr/openwin/lib/Xdefaults` into your own directory using the File Manager or the `cp` command. Rename the new file `.Xdefaults`. To do this from a Command Tool, rather than the File Manager, you would type the following commands to the shell `%` or `$` prompt.

```
sparcbook% cd
sparcbook% cp /usr/openwin/lib/Xdefaults .Xdefaults
sparcbook%
```

This changes directory to your home directory (in case you were not already there) and copies the file.

Using a text editor (either the OpenWindows Text Editor or a UNIX editor such as `vi`) open the new file for editing.

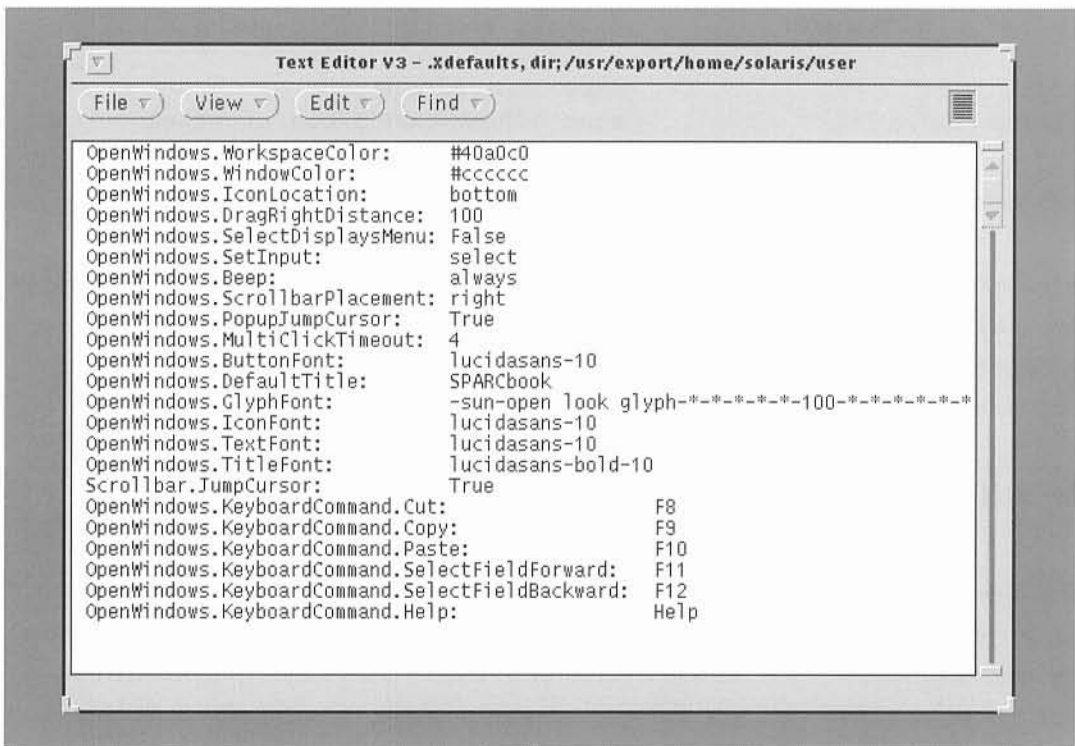

The file may not look exactly as shown but will be similar. This file configures your default X Window environment. To change the key used by a particular function you should change the mapping in this file. For example, to move the Copy key to its location on a Sun type-4 keyboard you need to change the mapping for Copy from F9 (its position on the SPARCbook keyboard) to L6 (its position on the Sun keyboard). The SPARCbook key mappings include definitions for key equivalents called L1 to L12 and R1 to R12. These simulate the Left and Right function keys on larger keyboards and are obtained using the Alt-Fx and Fn-Fx key sequences respectively. You can therefore make the following change:

```
to      OpenWindows.KeyboardCommand.Copy:      F9
        OpenWindows.KeyboardCommand.Copy:      L6
```

To make the changes take effect without having to exit OpenWindows you need to change your X resources using the `xrdb` command as follows:

```
% cd
% xrdb .Xdefaults
```

The next time you start up OpenWindows the new `.Xdefaults` file will automatically be read in and so you only need do this command once. If you follow the example above, the Copy key will now be Alt-F6 and not F9. To revert to the factory defaults you can delete or rename your `.Xdefaults` file and restart OpenWindows.

---

## **UTILITIES**

---

The Utilities option in the main Workspace menu provides a set of useful options.

- **Refresh** will cause the screen to be redrawn. This is necessary if the display becomes corrupted for some reason.
- **Reset Input** can be used to restart input if the system does not respond to your typing. This is usually due to a command or application not operating correctly.
- **Function keys** displays a pop-up window with the Function keys displayed from F1-F12. Selecting these has the same effect as pressing a Function key.
- **Window Controls** is a sub-menu that allows you to select basic window operations for the selected window. If you wish to use this it is easiest to pin it to the workspace so it is always accessible.
- **Save Workspace** allows you to save the current applications and positioning of windows so that when you next use OpenWindows the environment will be the same.
- **Lock Screen** will cause the screen to blank showing a pattern. You must enter your password to unlock the screen.
- **Console** should be used to bring up a Console terminal window if you lose the default console. The Console is used to print warning or error messages that are detected by the system. You should not have more than one console running at any one time.
- **Mousekey** has a submenu with two options. **Reset** will recalibrate the Mousekey. This sets the current mousekey valuse assuming the key is not being pressed and may be used if the mouse drifts or is uneven. **Parameters** will display a pop-up window allowing you to adjust the mouse sensitivity and constraint. See 'The Mousekey' for further information on the internal Mousekey.

---

## **POWER MANAGEMENT**

---

The SPARCbook is designed to operate from batteries for a minimum of two hours. Various power management techniques are used in the design of the system to extend the normal battery life to the maximum possible time. However, there are several facilities provided which you can use to influence and extend the battery life. This section describes the Power Management facilities as well as basic operations like charging the battery and changing battery packs.

<b>NOTE</b>
-------------

The two hour figure is based on continuous operation with the monochrome display on full brightness and the hard disk operational. It does not include operation of any external devices, or of the floppy disk. Use of these devices while operating from the battery will cause a considerable degradation of the battery operating time. Use of the Ethernet interface in particular, while operating from battery is not recommended because of the high power consumption of external transceivers.

The SPARCbook color models have a considerably higher power consumption because of the display technology. These will operate for about one to one and a half hours before recharging is required.

---

## **THE BATTERY MANAGEMENT SYSTEM**

---

The SPARCbook system has a battery monitor to detect the battery level. In order for this to operate correctly the mains power pack must be either disconnected or switched off, since the monitor only operates correctly when the battery is being used.

The charge level of the battery can be observed using the Battery Monitor option in the Portable menu. To see this, move the pointer into a spare area of the Workspace and press the Menu key. While holding the Menu key down move the pointer to the Portable menu and then across and onto the Battery Monitor option. When the pointer is above the Battery Monitor selection release the Menu key. After a short wait a battery monitor window will appear showing the level of the

---

battery. Because of the discharging characteristics of Nickel Cadmium batteries the bar display is most accurate at the top and bottom (ie when the battery is nearly fully charged or nearly discharged).

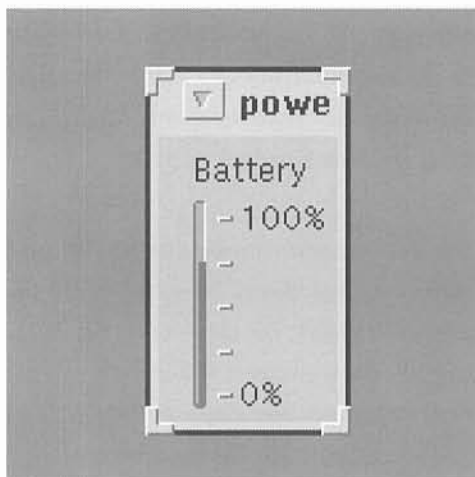

**NOTE**

---

While this description primarily relates to OpenWindows it is possible to obtain the battery level from the UNIX command prompt. The command `battery` will report the battery level as an estimated percentage of charge left in the battery to the nearest 10%.

---

---

## **SYSTEM SHUT DOWN AND BATTERY RECHARGE**

---

The SPARCbook system monitors the battery level and provides you two warnings as the battery level drops. The first warning occurs when there is about 20 minutes (10 minutes on color models) of battery operating time left. This warning appears as a message on the Console window. In addition the Red LED marked with a battery symbol on the top left hand side of the system starts to flash.

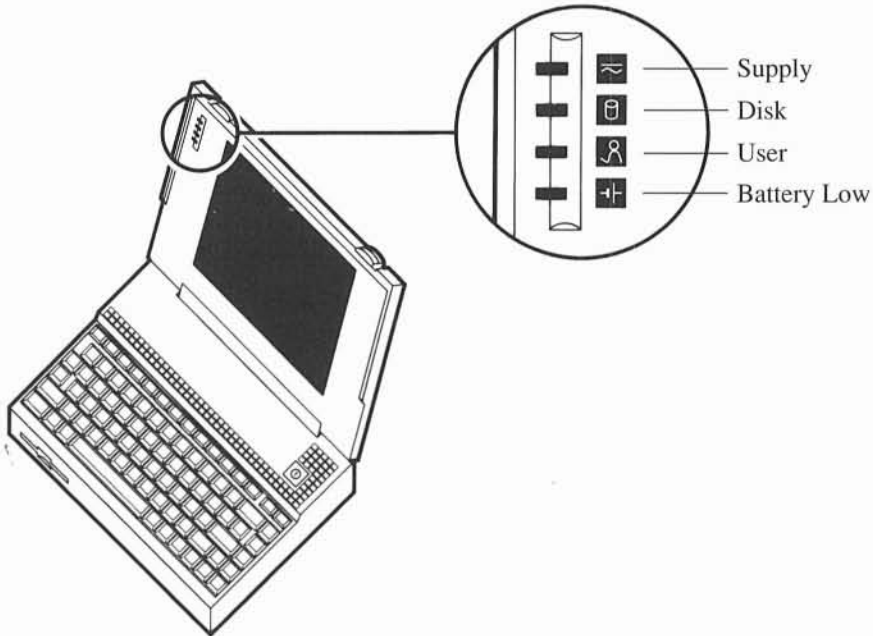

At this time you should use the Save and Resume facility to shut down the computer and replace the battery if you have a spare. Alternatively you should plug the charger/adaptor into the back of the unit to power the system and recharge the battery.



---

If you do not take any action a second warning will be issued when the computer has about 2-3 minutes of battery life left. The red LED will be solidly lit. By default the system will save its state and shut down automatically at this stage. However, it is possible to override the shutdown.



---

If you override the automatic shutdown on battery exhaustion you run the risk of corrupting disk files. These files may not be recoverable and, in an extreme case, you may need to rebuild your disk drive.

---

---

## ***BATTERY CHARGING***

---

The only way of recharging the internal battery is to connect the external charger. The system may be on or off while the battery is being recharged but the charging will be faster if the system is turned off. The battery takes two and a half hours to recharge if the system is off and about seven hours to recharge if the system is being used.



---

The SPARCbook uses temperature sensing as the primary method of detecting when the battery is fully charged. When the battery temperature reaches 43 degrees Celsius the charging is switched into trickle mode. To fast charge the battery successfully the ambient temperature should be less than 35 degrees.

---

When the charger/adaptor is plugged in and is not fast charging it will automatically trickle charge the battery pack, maintaining it at full charge. You will not cause any problem by leaving the charger connected to the system for extended periods of time.

---

## **CHANGING THE BATTERY**

---

The battery pack is specially designed for the SPARCbook computer. Spare packs are available as product options from your SPARCbook supplier. To remove or change the battery first ensure the system is off and the main power supply is disconnected.



---

Do not remove the battery while the system is running. If you do so data files are likely to be corrupted and, in an extreme case, you may not be able to restart the system due to disk file corruption.

---

Using a coin rotate the battery door button by a small angle (less than a quarter-turn) in the direction of the arrow. The door should pop open and the battery will be clearly visible. Pull the battery straight out of the battery compartment.

**NOTE**

---

You may run your SPARCbook computer from the external charger/adaptor without the battery installed. In this case the External Supply LED (the top LED) will not light even though the system is under external power. In addition you will need to pull the door open manually when opening the battery compartment since there will be no battery installed to spring the door open.

---

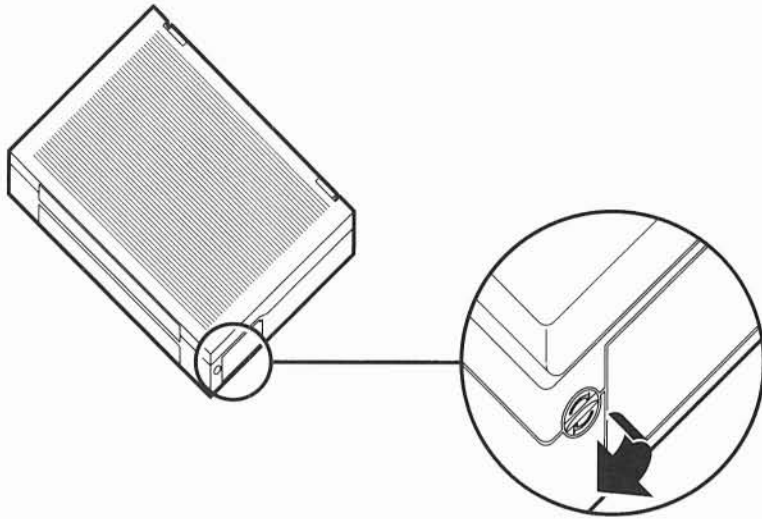

To insert a new battery ensure that the metallic contacts are inserted first and that the battery is oriented correctly (it can only be inserted one way round). Insert the battery into the compartment until it is level with the battery door, and use the door to seat the battery home. Close the battery door fully and the internal spring catch will automatically hold it shut.

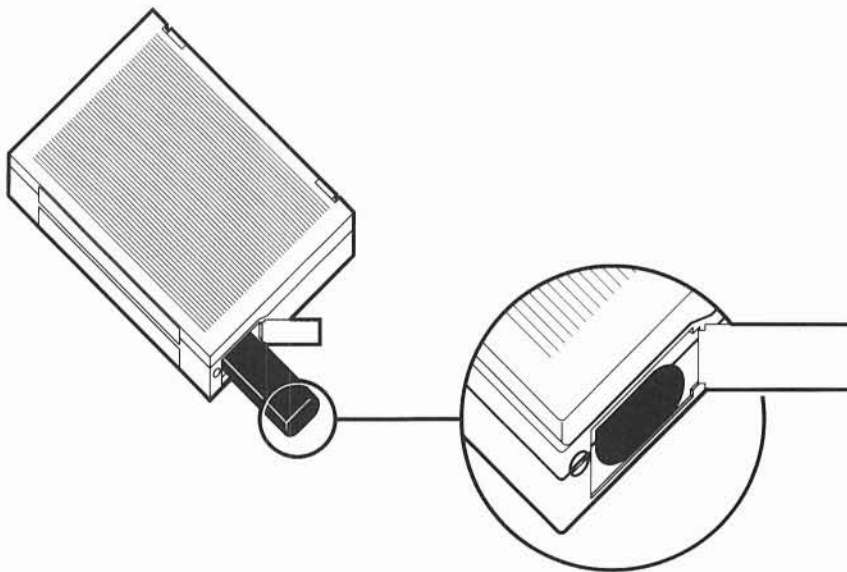

---

## ***EXTENDING BATTERY LIFE***

---

Battery life is dependent on many factors. The SPARCbook automatically stops the processor clock and peripheral devices when they are not being used to reduce power consumption. There are also several ways you can increase the battery life, depending on your application.

### **DISK SPIN DOWN**

- After a selectable period of inactivity the hard disk is spun down to the idle state. When the disk is next accessed there will be a delay of about 3 seconds while it spins up. The period is set by default to 2 minutes.

### **DISPLAY BACKLIGHT**

- After a selectable period the display backlight is turned off. The backlight is automatically turned back on whenever a key is pressed. The period is set by default to 5 minutes.

<b>NOTE</b>
-------------

---

The LCD display backlight consumes about 20% of the power used by the system. If you operate on reduced brightness ( by using the keyboard **alt- ↓** sequence, or the **Preferences** tool described below) you will extend the battery life by typically up to 20 minutes on monochrome models.

---

### **SYSTEM SHUT DOWN**

- After a selectable period the system will turn itself off to conserve power. By default this is set to 15 minutes, although you can disable this facility completely.

---

## SLOW MODE

- To conserve power you can run the system at one half the normal speed. System peripheral functions such as disk operations continue to function at the normal speed, but the processor and memory speed are run at half speed. This mode is useful for extending battery life when doing tasks that require little processing power - for example word processing. Running in slow mode will extend the system battery life by up to 30 minutes.

The various power management functions can be customized to meet specific requirements. In order to set up preferences you may use the OpenWindows environment. To do this Choose the **Preferences** option by moving the pointer into a spare area of the Workspace and pressing the Menu key. While holding the key down move the pointer to the Portable menu and then across and onto the Preferences option. When the pointer is above the Preferences selection release the Menu key. After a short wait a window will appear with the various options detailed above. Using the Select key (same as the Ctrl key) and the pointer you can set the configuration to meet your requirements. If you are uncertain about the OpenWindows operation refer to the Deskset User Interface section of this guide.

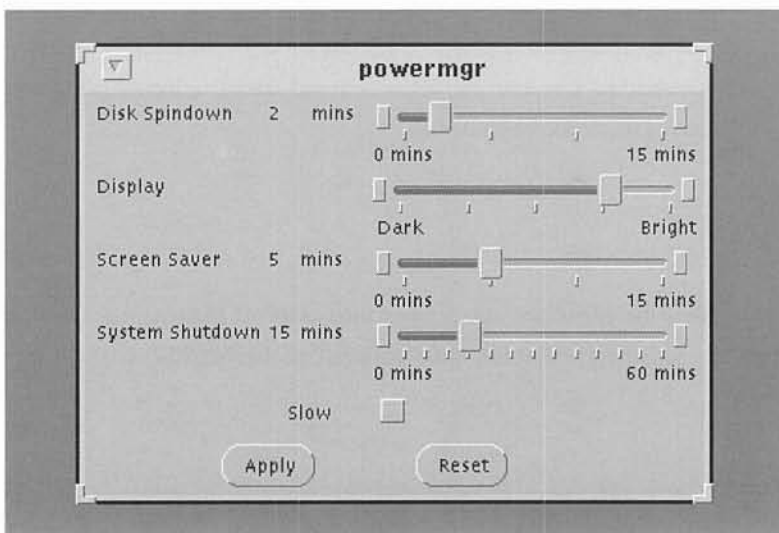

To set up your new choices Select the Apply button by moving the pointer over the Apply button and pressing the Select key. If you wish to return to the factory defaults at any time you can Select the Reset button. When you have set up the required configuration Select the pushpin to remove the window from the screen.

It is also possible to perform the same power management functions from the system shell prompt. To adjust the settings from the UNIX shell use the following command:

```
% pwrman [-disk n] [-screen n] [-off n] [-slow] [-normal] [-reset]
```

- `n` sets the required time in seconds for each mode referred to above. A value of zero causes the mode never to be entered.
- `normal` turns the slow mode off if it has been enabled.
- `reset` returns the power management functions to their factory defaults.
- `pwrman` with no arguments lists the current settings.

---

## ***BATTERY LIFE***

---

Overall battery life depends on many factors such as operating temperature, charge/discharge cycles and usage patterns. The SPARCbook battery pack is designed to operate at up to 80% of its initial efficiency for up to 1000 complete charge/discharge cycles.

The SPARCbook battery pack utilizes the latest generation of Nickel Cadmium batteries. Unlike previous generations the pack does not exhibit what has been described as memory. You may regularly only partly discharge the battery pack, with no effect on overall charge capacity or battery life. You do not need to deep discharge the batteries at any time, and trickle charging with the external charger/adaptor may be maintained for extended periods. Eventually, however, the battery pack will wear out after typically around 2000 hours of portable use. The charge life becomes shorter and shorter and at this stage you will need to replace the battery pack.

---

**NOTE**

Replacement battery packs may be purchased from your SPARCbook sales office. You should be careful in disposing of Nickel Cadmium batteries since they contain substances harmful to the environment. Your SPARCbook supplier will be pleased to accept returned batteries for safe recycling.

---

---

***USING FLOPPY DISKS***

---

The SPARCbook system is capable of reading and writing industry standard 3.5" double sided single or double density floppy disk drives. Each floppy disk can store 720K or 1.44M bytes of data when formatted. The drive can also read industry standard MS-DOS PC formatted disks with MS-DOS file systems.

**NOTE**

The 3.5" floppy disk drive is only supported on those SPARCbook models that contain a single hard disk. These are the S1-85, 120 and 120E models and the corresponding color versions. Other models do not support the floppy, so software loading and backup must be performed through the Ethernet, or using the optional parallel to SCSI convertor product.

---

**NOTE**

When purchasing blank floppy disks for SPARCbook you must ensure that you specify double-sided double density 135 tracks per inch (tpi) to get the maximum 1.44M byte capacity.

---

To insert a floppy disk into the system remove it from its packaging and insert it fully into the drive with the label on the top side. When the disk is fully inserted the button will protrude from the front of the system for when you want to remove the disk again. To eject the disk press the button.

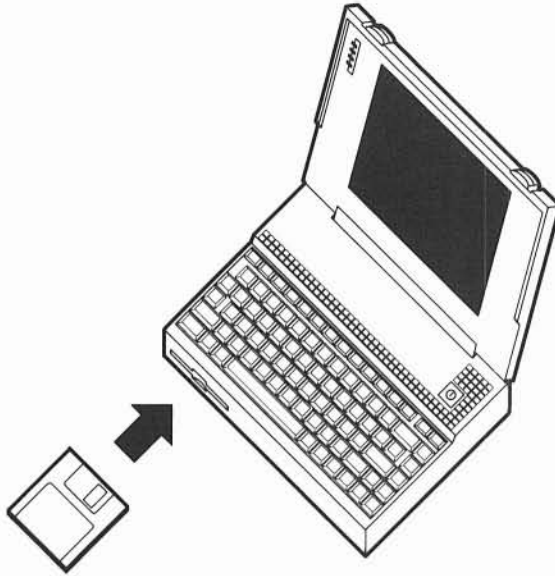

---

Be careful not to insert the floppy disk the wrong way up. If you do not observe this warning it is possible to damage the floppy disk mechanism.

---

Before use floppy disks must be *formatted*. You can format floppy disks from the OpenWindows environment or from the shell prompt. However, if you are using the OpenWindows utilities these will automatically format the floppy disk when necessary.

Floppy disks are used for software distribution and backup. You can either store individual files on the Floppy just like in your home directory, or you can use it as a data storage device like a tape drive and store a stream of data on it. The first way is useful to store files you want to access frequently or for temporary storage space. The second way is more efficient for making backups. An OpenWindows utility is provided to use the floppy disk in either way.

If you attempt to use an unformatted disk or there are problems reading the disk, a pop-up window will appear asking you if you are sure whether you want to format the disk. Formatting the disk will destroy any data that is already on the disk.



---

To use the floppy disk from the OpenWindows environment you need to choose one of the options from the Floppy Tools menu in the Programs section of the Workspace Manager. In the Floppy menu are options for Format, Backup, Restore, Files and End.

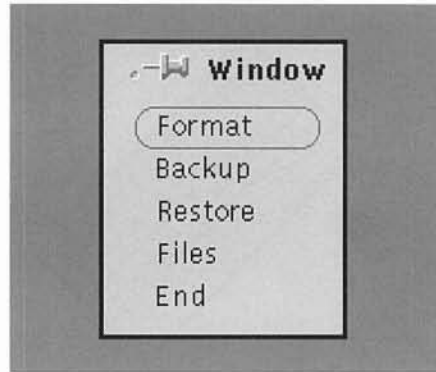

---

## ***FORMATTING FLOPPY DISKS***

---

To format a floppy disk from the OpenWindows environment Choose the Format option from the Floppy Tools menu. A pop-up window will ask you to make sure that you want to format the disk and then proceed. If the disk is write protected you cannot format it.

To format a floppy disk from the Solaris shell prompt use the following command:

```
% fdformat          to format a standard high density floppy
% fdformat          to format a low (720Kbyte) density floppy
```

---

## ***SAVING AND RESTORING FILES USING FLOPPY DISKS***

---

To copy a file or file(s) onto a floppy disk you can use the OpenWindows facilities. The OpenWindows backup facility allows you to save files or a directory of files to one or more floppy disks.

**NOTE**

The OpenWindows Floppy disk utilities provide a simple backup and restore mechanism for a small number of files. You may only perform a single backup or restore operation to one or more floppy disks - you cannot use the utilities to add files to an existing disk unless you use the Files utility (see Below). For a more complete discussion on backup and restore methods you should refer to 'Backup and Restore'.

To Backup a file or directory Choose the Backup option from the Floppy Tools menu.

A window will appear with the backup utility. This windows contains several choice options.

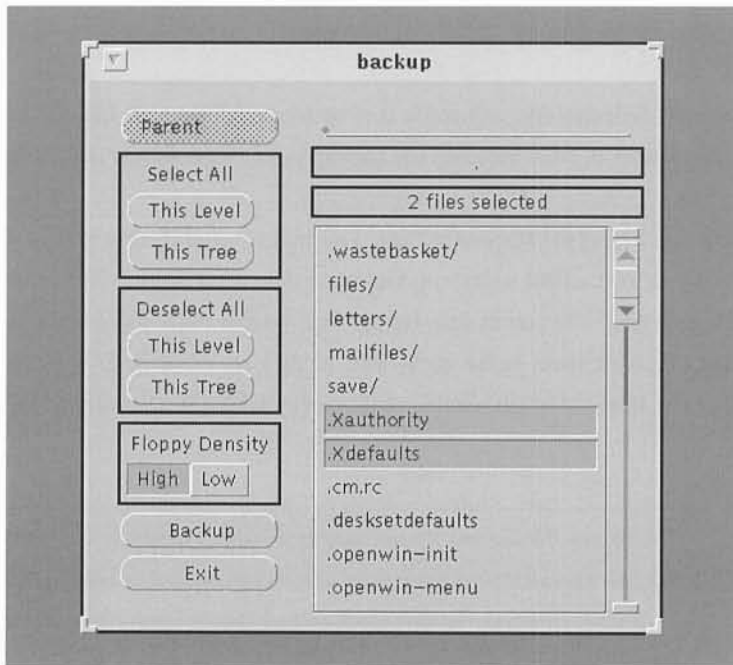

---

By default the backup utility will operate from your home directory. If you want to operate from a different directory Select the Text field at the top of the window using the pointer and the Select key, and enter your required directory or folder name.

You may select files to backup as follows:

- Selecting on a file (shown without a trailing / character) will include it for backup.
- Selecting on a directory or folder (shown with a trailing / character) will cause you to move into that folder.
- Select All at *This Level* will include all files in the current folder, but not sub-folders.
- Select All in *This Tree* will include all files and sub-folders in the current folder for backup.

Selecting on an already Selected file will cause it to be removed from the list of files for backup. A running total of the number of files Selected for backup is kept and shown at the top of the window.

To start the backup you Select the *Backup* button. You will be prompted to enter a disk and then the backup will start. If you have asked to backup too much data for a single disk you will be prompted to replace the disk each time it becomes full. Remember to label each disk as you make the backup since you will need to restore them in the same order as they are created. If you insert an unformatted disk at any time a pop-up window will appear asking if you want to format it or replace it with another.

**NOTE**

---

The Floppy Backup and Restore facilities use the Operating System `tar` command. Files written and saved using these utilities can be read by other systems using the `tar` command. However, the first block on each disk is reserved for directory information.

---

To restore the contents of a disk or disks Choose the Restore option from the Floppy Tools menu. The Restore window will appear.



You may use the Examine button to look at a previous backup. The contents of the disk(s) will be displayed in the window. By default the files will be restored into your home directory or folder. However, you may change this by entering a new directory name in the Restore to: text field.



---

If you have previously saved files from your home directory and choose to restore them to the same directory, then any files that already exist with the same name will be overwritten. If you have made any changes to the files since you made the back up these will be lost. To avoid this restore the files into a new directory or folder and then use the File Manager, or the UNIX utilities to move the ones you want into their normal places.

---

---

## ***USING THE FLOPPY DISK FILES FACILITY***

---

For temporary file storage you can use the floppy disk as a normal directory. To do this you will need to Choose the **Files** option in the Floppy Tools menu.

Depending on whether the Disk has been previously used one of two things will now happen. If the disk has not previously been used and is not formatted you will be asked if you want to format the disk. If the disk is formatted but is not in a recognizable format you will be asked if the Floppy Files operation should continue.

If you choose to continue there will be a short pause while an empty file system and directory are written to the disk. When this is complete a File Manager window will appear with the `/floppy` title. If the disk has already been used the File Manager window will immediately be opened. The figure shows an example File Manager window for the floppy disk.

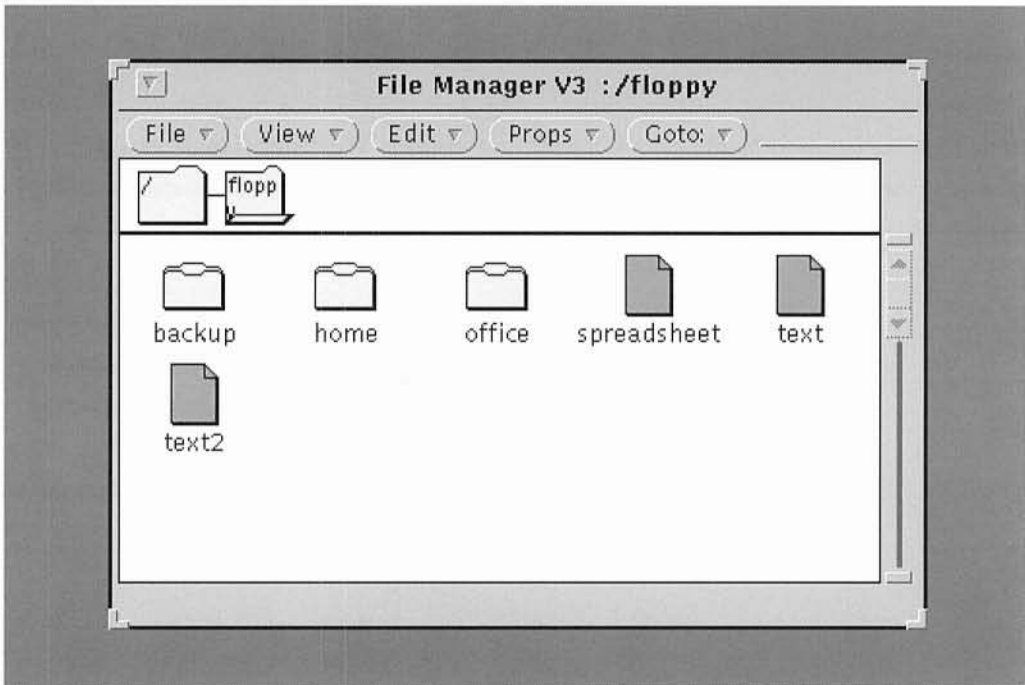

You may now use the File Manager window exactly as any other folder. You can move or copy files as you require using all the OpenWindows facilities. Remember that the waste-paper basket files remain on the floppy disk until you explicitly delete them with the Empty Waste-Basket facility.

When you have finished with the floppy disk drive you must Choose the **End** option from the Floppy Tools menu. This will cause the files to be written completely to the Floppy Disk and the File Manager to be closed. You must not eject the disk until you have completed the **End** operation.



---

Failure to complete the Floppy Files operation by choosing **End** from the Floppy menu could result in your files being lost and/or corrupted. You must use the **End** option to complete floppy operations before ejecting the floppy disk.

---

**NOTE**

The floppy file system is made using the Solaris 1.0 `newfs` and `mount` commands as follows:

```
% newfs /dev/fd0
% mount /dev/fd0 /floppy
```

This causes a 1.44Mb file system to be built onto the floppy and the floppy to be mounted. The floppy is unmounted by Choosing the **End** option.

```
% umount /floppy
```

---

---

## MS-DOS DISKS

---

The SPARCbook Operating System can read MS-DOS format disks directly from the OpenWindows UNIX tools. To mount a PC file system you will need to use the command tool or shell interface. UNIX and MS-DOS files may be transferred to and from MS-DOS format floppy disks.

```
% mount /pcfs           will mount a MS-DOS formatted floppy disk to be
                        accessed from the directory /pcfs
% umount /pcfs          will dismount an MS-DOS formatted floppy disk.
```

---

**NOTE**

You must *mount* a floppy disk with a file system before using it. You must not eject the floppy disk before dismounting it or you may corrupt the floppy disk files.

---

---

***CONNECTING AND USING EXTERNAL DEVICES***

---

The SPARCbook system provides a number of external interfaces to connect to industry standard communications facilities and peripherals. This section describes how to connect external devices and how to access them from the Solaris Operating System.

- Printer - Serial or Parallel
- Ethernet Network
- External VGA or Extended VGA Graphics Monitor
- External Mouse, and/or Keyboard
- Terminal, or other Serial Device

---

***CONNECTING A PRINTER***

---

The SPARCbook system may be used with a serial or a parallel printer. The first step is to physically connect the printer to the system. The serial port is a 9 pin mini-DIN connector; the parallel port is a miniature 34 way connector. A converter cable is supplied with your SPARCbook to interface to a standard IBM style 25 way pin socket for the Centronics parallel port.

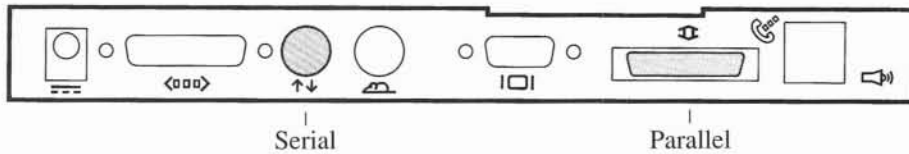

You can obtain printer cables for both Serial and parallel printers from your cable supplier. Alternatively you may make up your own cables. The section 'Connector Reference' gives details of the connector pin-outs and the exact construction of cables for most applications.



---

You should always use shielded cables for connection to peripheral devices. Failure to observe this warning could result in the generation of interference outside FCC class B limits rescinding the license granted by the FCC to operate the equipment.

---

**NOTE**

---

Remember that the SPARCbook can be used as a networked machine. You may easily connect to printers on remote SPARCbook or other UNIX based machines. For further information on remote printers see *Configuring a Remote Printer*.

---



---

Since the Solaris Operating System prints files as a background activity it uses spool directories to copy print requests to. Printing of simple ASCII files can be accommodated with only a small amount of disk space, but printing complex PostScript based files can consume well over 2 Megabytes per page. In planning how to set up a printer service for one or more SPARCbook machines you should be aware of the possible space requirements if you intend to print large files. In such cases it may be better to use a print server on the network if one is available.

---

## ***CONFIGURING A LOCAL PRINTER***

---

To interface to the serial printer you need to connect the 9 way mini-DIN connector to your printer connection. Refer to 'Connector Reference' for details of the required cable. The SPARCbook system uses industry standard RS232 signal levels and you can configure the baud rate from 110 baud to 38400 baud.

To interface to a parallel (Centronics interface) type printer you need to connect the 34 way miniature D connector to the supplied interface cable. This cable provides a 25 pin female D type socket compatible with the de-facto IBM standard. Refer to 'Connector Reference' for details of the required cable between the 25 PinD type connector and a Centronics printer.



---

You must use the correctly wired cable to connect between the SPARCbook and your printer. Failure to observe this warning could damage the SPARCbook and/or your printer.

---

In order to carry out the following procedures you need to have superuser privileges. Either log in as root, or if you are doing the printer setup from the OpenWindows environment you can open a terminal window by Choosing the `cmdtool` option from the main Workspace menu, and type `su` to obtain superuser access. You will be asked to enter the root password, and the prompt will change to a '#' symbol, to remind you that you now have the 'superuser' status. When you have finished the administration operations type Ctrl-d to revert to your normal privilege level.

- Connect the serial or parallel printer to the SPARCbook system and ensure that it is turned on.
- Check basic data communications between the SPARCbook and the printer.

**NOTE**

In normal use the printers are accessed through UNIX utilities or the OpenWindows print tool. For setting up the printers you access the devices directly as follows:

Serial Printer	/dev/serial
Parallel Printer	/dev/parallel

Type:

```
# (stty options; cat /etc/motd) >/dev/parallel    for a parallel printer
# (stty options; cat /etc/motd) >/dev/serial      for a serial printer
```

Options are one or more of the following (these are for serial printers only except the last two)

```
baud      baud rate eg 1200, 9600 etc
-evenp    set even parity (default)
-oddp     set odd parity
-parity    no parity
-tabs     convert tabs to spaces
-onlcr    output CR-LF for CR or NL
```

If all is well the /etc/motd file should be printed out on your printer. If you experience difficulties refer to 'Printer Problems' below.

- Set up the printer system files

You must first create a /etc/printcap file entry for the printer or printers you are using. Using the Text Editor in OpenWindows, or a UNIX command line editor such as vi, edit the file /etc/printcap.

---

The example below shows the lines (which are shown Selected) added for the Canon Bubble Parallel Printer (BJ-10), a notebook sized printer for normal ASCII type files, and corresponds to a typical minimal entry for a parallel printer device.

```
# Canon Bubble Jet Printer
canon|lp|canon bj-10:\
      :lp=/dev/parallel:sd=/var/spool/lpd:
```

The first line is a comment with a # symbol at its start. The next line is the name line, and gives the names by which the printer is known. One printer in the `printcap` file must have a name `lp`. This will be the default printer. In this case the Bubble Jet is the only printer and therefore must have `lp` as one of its names. The last line gives the line printer device (`lp=`) and the spool directory (`sd=`). For one printer this should be the directory `/var/spool/lpd`, and is where temporary spool files are created for background printing. If you specify more than one printer you will need to specify and create a different spool directory as explained in the second example below.

The next example adds a second printer to the system, this time connected to a serial port. Let us assume an Epson MX-80 printer configured to operate at 9600 baud with no parity and hardware `rts/cts` handshaking enabled. The following lines would be added to the `/etc/printcap` file:

```
# Epson MX-80 Dot Matrix printer
epson|mx-80|dot matrix|epson mx80:\
      lp=/dev/serial:br#9600:\
      ms=-parity,crtscts: sd=/var/spool/serial:
```

This specifies a serial printer on the `/dev/serial` line. The `br` option specifies the printer baud rate. The `ms` option specifies the line characteristics chosen from the available `stty` utility options the most often used options were specified on the previous page. The `crtscts` entry specifies to use hardware `rts/cts` handshaking. Note that a different spool directory is required, and that this must be created next .

---

Other parameters are useful for printcap descriptions are:

**mx#0:** set maximum file size unlimited. This is useful for PostScript printers where the default of 500K bytes can easily be exceeded. However, beware of system disk space limitations when printing large PostScript files.

**pl#x:** printer page length is x lines (default 66)

**pw#n:** printer page width is n characters (default 132)

- Create any required Spool directories

By default the system includes a spool directory `/var/spool/lpd` for temporary storage of files as they are being printed. If you specify more than one printer you will need to create a spool directory for each additional device. Using the example above you would need to do the following to set up the `/var/spool/serial` directory:

```
# cd /var/spool           (change to spool directory)
# mkdir serial            (make a new spool directory)
# chown daemon serial    (change owner to printer daemon)
# chmod g+w serial       (set file mode)
```

You will need to do the same with any other required printer spool directory using your specified name rather than 'serial' used in the example.

If all is well you should now be able to print files to the printers you have set up using the OpenWindows Print Tool program, or using the UNIX `lpr` command. If you have difficulties refer to 'Printer Problems' below.

---

## ***CONFIGURING A REMOTE PRINTER***

---

If your SPARCbook is connected to a network you may use printers that are connected to other machines on the network by specifying a slightly different `/etc/printcap` description. The following lines might be added to the printcap file to enable printing to a remote machine called `jupiter` with an attached laserwriter printer.

---

```
# Laserwriter on Jupiter
lwriter|lw|laser-writer:\
:lp=:rm=jupiter:rp=lw:sd=/var/spool/juplp:
```

All remote printers have the `lp=` field. The `rm` field specifies the hostname of the remote machine to use, and must be known to the local system as an accessible machine on the network. `rp` specifies the remote machine printer name (in this example `lw`).

Ensure that you create the spool directory as detailed in the previous section.

---

## ***PRINTER PROBLEMS***

---

If you have followed these instructions everything should work first time. This section gives some limited advice on what to do if something goes wrong or if the printer does not work. For further software information you will need to refer to the optional complete Solaris documentation. For further hardware information refer to your printer manual and the pinout descriptions in 'Connector Reference'.

If everything appears to be working but there is no output to the printer when you try and access it directly using `/dev/serial` or `/dev/parallel` check the following:

- Check the printer is plugged in and switched on.
- Check the cables are correct for the SPARCbook and the printer. If the printer cable is not exactly correct for the printer hardware setup then printing may not be enabled.
- Try the printer self-test if there is one.
- Check that the baud rate and data settings for the printer and the computer match.

If a serial printer appears to be printing but is producing garbage or incorrect characters check the baud rate and data settings again, since this is the most likely cause of the problem.

---

If the Print Tool or `lpr` command does not work but direct printing does then an error message may be printed out on the screen or in the console window.

```
lpr: [printername]: unknown printer
```

The specified printername was not found in `/etc/printcap`. Check you have set up this file (see above).

```
lpr: [printername]: jobs queued, but cannot start daemon.
```

The printer daemon has stopped. Try running the `lpd` program as superuser:

```
% su
# /usr/lib/lpd          starts line printer daemon
```

```
waiting for printer to become ready (offline ?)
```

The printer device could not be opened. Typically the printer is off-line or not connected. You may need to stop the print job and then restart it after connecting a printer, or putting it on-line.

```
waiting for [hostname] to come up
```

The software cannot find the remote printer. Either the ethernet connection is not operating or the printer daemon on the remote machine has stopped. Check you can communicate with the remote machine. You may need to stop the print job and restart it.

If there is still no printer output you should consult your printer manual and the optional full Solaris documentation for further assistance.

---

## ***CONFIGURING THE NETWORK***

---

This section explains how to connect the SPARCbook to an existing Ethernet network and how to create a network of SPARCbook machines. First the physical connection is explained, and then the procedures to connect the SPARCbook to an existing network. Finally the procedures required for setting up a simple network of SPARCbook machines are explained.

---

## ***TERMINOLOGY***

---

The Network Interface uses various industry standards for both the hardware and software connection. Some of the terms used in the rest of this section are explained below:

- ADDRESS** Every machine on a network has its own Ethernet *address*. This is a unique identifier for each machine. The physical address of any machine is assigned by the manufacturer and has a manufacturer's part and a machine address. However, the network address you will most often use is the logical address which is made up of the Internet Protocol (IP) address and a unique number assigned to each machine on the local network. Each system address has a corresponding system name.
- CLIENT** A network *client* machine is a system that may use the services provided by a master *server* machine for disk storage space, printer access or some other network-wide service.
- DOMAIN** Each network of machines can be assigned a unique name. The name assigned to a group of machines on a site is called a *domain*.
- INTERNET** *Internet* is a wide area network spanning worldwide locations. Many UNIX based systems with Ethernet Local Area Networks are part of, or have access to, the Internet network.

---

NFS	The <i>Network File System</i> , or NFS, is part of the SUN suite of Open Network Computing (ONC) protocols. NFS allows you to use directories of files on a remote machine as if they were actually on your own systems. Unlike the AT&T Remote File System (RFS) which only provides facilities for UNIX based machines, NFS can be used to connect to different Operating Systems such as DOS, using PC-NFS.
NIS	<i>Network Information Service</i> . Previously known as Sun Yellow Pages® the NIS provides a service whereby systems on a network can find out other systems' names and Ethernet addresses from the NIS master.
SERVER	A machine that provides services to other machines on the network is called a <i>server</i> . The server can provide services varying from updating all machines on the network as new machines are added, to providing network wide disk, backup, or printing services.
TCP/IP	<i>TCP/IP</i> is a family of protocols that determine how data is transferred across a network.
TRANSCIEVER	The <i>transceiver</i> is a physical unit that interfaces the SPARCbook Ethernet connector to an actual network medium. Depending on the transceiver the network may be either thick wire, thin wire or a twisted pair type connection.

<b>NOTE</b>
-------------

---

Solaris 1.0.1 contains extensive support for network communications and configuration facilities. Solaris 1.0.1 supports TCP/IP, RFS, NFS, automounting, and the NIS name serving facilities. This User Guide provides information on how to connect as a client to an existing NIS based network, and how to create a simple network of SPARCbook based machines. However, the system administration of large networks is beyond the scope of this guide and you are strongly recommended to refer to the optional complete documentation set for further information. Note also that only NFS is bundled with the SPARCbook Operating System. The RFS facilities are available for loading from the supplied CD.

---



---

## ***CONNECTING TO THE ETHERNET***

---

There are several different types of physical media which the SPARCbook Ethernet interface can be used to connect to. These include traditional Ethernet cable, the lower cost Cheapernet Coaxial cable and more recent twisted pair physical connections. Before connecting to a network you need to know which media you will be using.

In any case you will need a transceiver interface which connects the system to the network. There are many different types of transceiver interface available from third party vendors and the SPARCbook uses an industry standard 15 pin female D type connector with slidelock to interface to the transceiver cable or directly to a miniature transceiver.

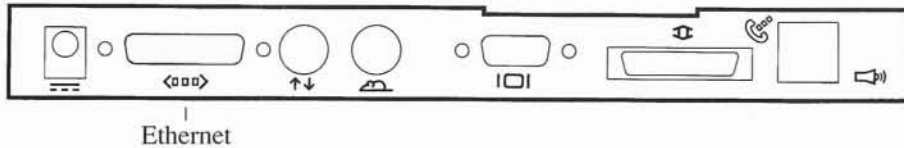

To connect the system to an existing Ethernet you will need to connect the transceiver or transceiver cable to the back of the SPARCbook. The 15 Pin D type connector has a slidelock to retain the transceiver cable which can be quite heavy for a traditional Ethernet. If using cable, the other end of the Transceiver cable is connected to the transceiver which provides the actual network interface. The method of connection between the transceiver and the network is dependant on the transceiver and the network type.

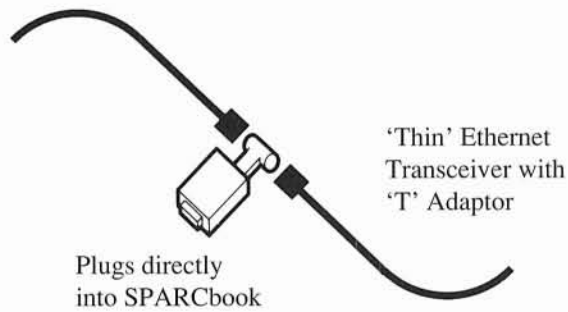
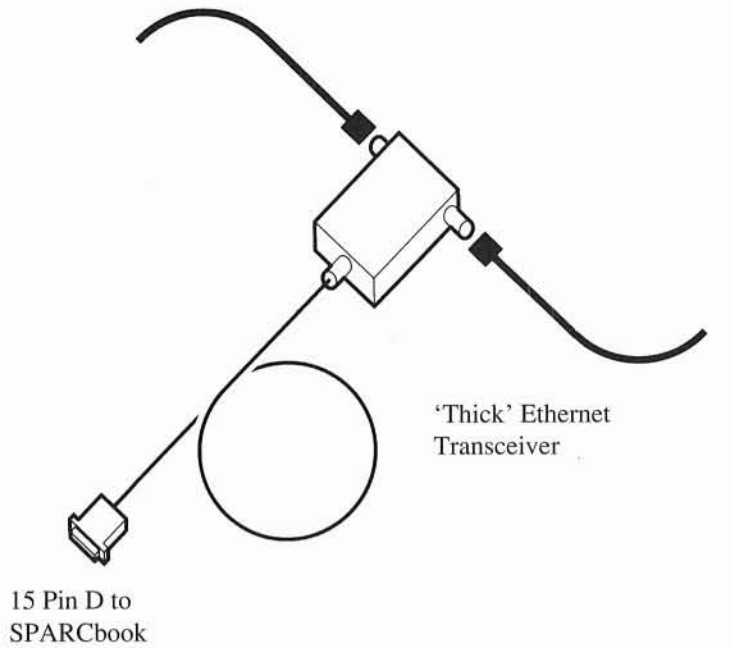

---

## ***NETWORK ADDRESSES***

---

If you are interfacing to an existing network you will need to obtain or determine a new unique Internet Protocol (IP) address for your machine. An address uniquely identifies your machine on the network. Addresses are normally allocated by a single person for the network - the network administrator. If you are setting up a new network you need to determine the network addresses you will use.

---

Worldwide Internet addresses are allocated and administered by an organization known as the DDN/ARPANET Network Information Center (NIC). If you intend to access Internet you must obtain an Internet address from the NIC. Even if you do not it is strongly recommended that you obtain a unique network address from the NIC to avoid later difficulties.

All IP addresses consist of 32 bits, normally written as four decimal numbers each from 0-255, separated by periods. As an example a typical IP address is 192.200.23.98. There are three types of network class assigned by the NIC:

- Class A Only the largest networks are assigned Class A addresses which have the first number in the address as 0-127. Each Class A network has over 16 million available addresses.
- Class B Large organizations and groups of subnetworks sometimes have a Class B address. The first number is 128-191, the second number is also assigned by the NIC, and over 65000 addresses are available for each Class B network.
- Class C The majority of networks are classified as Class C networks. These use a first number of 192-223, with the second two numbers also allocated by the NIC, and each has up to 254 hosts available.

As part of the setup procedure the first time you use a SPARCbook on a network you will need to enter an Internet address. You are strongly recommended to obtain your own Class C address from the NIC. For further information contact the NIC at the following address:

Via Electronic mail:	HOSTMASTER@NIC.DDN.MIL
Via Telephone:	(800) 235-3155
Via Postal mail:	SRI International DDN Network Information Center 333 Ravenswood Avenue EJ217 Menlo Park, CA 94025

---

## ***INTERFACING TO AN EXISTING NETWORK***

---

In order to use a network you must first tell your system of the existence of the other machines on the network, as well as alert those machines that a new system has been added. There are two ways of doing this that will be discussed here. The first is to edit the relevant configuration files on all the machines that require to communicate with each other; the second is to update an NIS server machine with details of the new network configuration and allow that information to be propagated automatically onto the other network machines.

---

## ***INITIAL SYSTEM CONFIGURATION***

---

If you initially configured your SPARCbook as a networked machine (see ‘Basic System Configuration’) you can proceed to the next section. If you did not, or wish to change the configuration, you will need to reinitialize your system with the relevant network parameters. To do this you will need to exit OpenWindows, if it is running, log in as the superuser using the `root` log in account, and run the `sys-config` program.

```
login: root
# /usr/etc/install/sys-config
```

The initial system setup menus are displayed. Refer to the ‘Basic System Configuration’ section at the start of this guide which guides you through the set-up procedure. You will need to enter the Internet address and whether you want to run NIS or not. You will then need to restart the Operating System for the new information to take effect. This will happen automatically if you answer ‘yes’ to the system reboot question.

After you have configured the system as a networking node you can proceed with configuring the machine onto a network with or without NIS.

---

**NOTE**

The SPARCbook will automatically detect whether it is on the network when it powers up and during use. The removal of the network connection is regarded as a normal event on a portable, and if you configure the system for networking it will correctly operate on or off the network. See the section 'Networks and Portable Machines' for a further discussion.

---

---

## ***CONFIGURING FOR A NETWORK WITHOUT NIS***

---

If the network you are connecting to is not running NIS you first need to edit a single configuration file on each machine to get the SPARCbook installed on a network initially. The file `/etc/hosts` provides a directory of all the systems on the network that you are able to communicate with, and provides information on the names and addresses of each machine.

- Edit the Local Hosts File

To edit the `/etc/hosts` file you must be logged in as root. You can edit the file from the OpenWindows environment using the Text Editor, or you can use the `vi` editor from the command shell prompt.

By default the `/etc/hosts` file contains entries for the local machine called `localhost`. In addition the startup procedure you went through when you first started up the SPARCbook asked you to assign a unique name to the system which was placed into the `/etc/hosts` file. The example shows the default file for a machine named `jupiter` with an Internet address of `192.52.161.99`.

```
#
# Sun Host Database
#
# If the NIS is running, this file is only consulted when booting
#
127.0.0.1 localhost
#
192.52.161.99      jupiter loghost
```

---

This file requires editing with additional lines for every machine that you need to communicate with on the network. Each line consists of the following information:

```
ip-number hostname [# comments]
```

The example local network address is by default 192.52.161. This is provided as an example only. It is recommended for anything other than small or test local networks that you obtain IP addresses from the NIC as outlined above. As an example, the following might be a typical file for a network of 6 machines if you were allocated a Class C network address of 192.52.161

```
#
# Sun Host Database
#
# If the NIS is running, this file is only consulted when booting
#
127.0.0.1          localhost
#
192.52.161.99     jupiter loghost # my own SPARCbook
#
192.52.161.1      saturn          # reception
192.52.161.2      mercury          # stores
192.52.161.3      solar            # server machine
#
# The lab Sun workstations
#
192.52.161.20     sundev1          # devt Sun Workstation
192.52.161.21     sundev2          # backup devt Sun
```

Once all the machine names and addresses have been added you should save the file.

---

- Edit the Remote Hosts Files

In order for each machine to recognize your own system you need to add your system name and address to each of the machines you want to be able to communicate with. To do this edit the `/etc/hosts` file each machine and add a line with your own system name and the IP address. For the previous example you would add the following line:

```
192.52.161.99    jupiter        # the new SPARCbook
```

- Set up the Default Router

If your network is local and you are not connecting to any other networks you do not need to do this. On a larger network one or more of the machines will be a *router*. A router is a server machine that communicates with other networks. Requests for access to other networks are sent through routers. To set up a router you need to edit the file `/etc/defaultrouter`.

First set up the `/etc/default router` file by using the OpenWindows Text Editor, or the `vi` editor from a Command Tool. You will need to create this file and it should contain the name of the router machine. Then edit the file `/etc/rc.local` and remove the '#' symbols from the following lines:

```
#if [ -z "$defroute" ]; then
#   if [ -f /usr/etc/in.routed ]; then
#       in.routed;      echo 'running routing daemon.'
#   fi
#fi
```

- Set up Equivalent Hosts Files

This step is optional. By default all machines listed in the `/etc/hosts` file have access to your machine. The `hosts.equiv` file is a list of machines from which users may log in (using `rlogin`) and/or use the printing services on your machine without a password (assuming that there are user accounts for those users on the local machine). For example the following `hosts.equiv` file would allow anyone on the machines named `mars` and `mercury` to log into your own machine without a password.

---

```
mars
mercury
```

The file is simply a list of machine names - one per line. You can edit it using the OpenWindows text editor or the `vi` screen editor. The default is a file with a single line consisting of the `+` character which is equivalent to allowing all known machines access.

- Set up the User Hosts File

The `.rhosts` file is optional. You may set up a `.rhosts` file in any user's home directory. The format of `.rhosts` is the same as that of `hosts.equiv` but the file applies to the particular user. Thus if the previous example was used for a `.rhosts` file the user could log in from `mars` or `mercury` without using a password. In addition you may specify other users on a remote machine who can log in without using your password. For example your own `.rhosts` file might look like this:

```
mars
mercury
mars tim
```

This means that you can log in to the local machine from `mars` and `mercury` as yourself, and that the user called `tim` on `mars` can also log in to the local machine as you.

The `hosts.equiv` and `.rhosts` files allow a measure of network security to be maintained while making it easy for users to access the resources of remote machines. Remember that since only you can write your own files a remote user must have access to your account before he will be able to write files or even copy files into your own directory.

If you have followed the above procedures you should now be able to log in and communicate with other machines on the network from your normal log in account.

For an overview of the available network facilities see 'Network Facilities'.



---

## ***CONFIGURING FOR A NETWORK WITH NIS***

---

If the network you are connecting to is running the Network Information Service (NIS) you will only need to add your machine details to the NIS master server machine. This information is used to update all other machines on the network automatically with the new machine name and address. Therefore as an NIS client you should only need to configure the system for NIS operation to gain access to all of the network facilities. You should, however, ensure that details of your machine have been added to the network NIS server. Information on setting up a SPARCbook as an NIS server is provided in the next section.

You may set up `hosts.equiv` and `.rhosts` files as described in the previous section if you wish.

If you have difficulty in communicating with other machines on the NIS network you will need to seek advice from your network administrator or refer to the optional complete documentation package for the Solaris 1.0 Operating System.

---

## ***CREATING A NEW NETWORK***

---

If you are creating a new network of machines you can employ the basic networking interfaces or you can implement the NIS schemes. A detailed description of setting up large networks is beyond the scope of this User Guide and you should refer to the optional documentation for further information. However, to set up a simple network you can simply follow the procedures outlined in *Configuring a Network Without NIS*. If you follow these instructions for each system on the network you can immediately start to use the main network facilities provided in the Solaris 1.0.1 operating system. These are summarized in the next section.

---

Alternatively you can configure one of the machines on the network to be the NIS server and configure the other machines as clients. The following section explains how to set up a single NIS server on a single network. The server is assumed to be a Sun Workstation running SunOS 4.1.x or a SPARCbook running Solaris 1.0.1. Setting up of more complex networks is beyond the scope of this Guide and you should refer to the optional complete documentation product for further information.

**NOTE**

If you are setting up a new network you need to choose between setting up a network based on NIS and one without NIS. The latter is easier for a network with only a small number of machines, but on a large network with many machines and different users NIS is an fundamental tool for managing the network administration requirements.

---

## ***SETTING UP A SIMPLE NIS SERVER***

---

- Set up the `/etc/hosts` file as described in ‘Configuring a Network without NIS’ for all the machines in the network.
- Ensure no network services are being used and log in as the superuser:

```
login: root
#
```

- Initialize the NIS database files:

```
# cd /var/yp
# /usr/etc/yp/ypinit -m (initialize the NIS server)
```

---

Answer no to the question on non-fatal errors. The system will then ask for the names of other NIS servers. Since you are setting up for only a single server you should type **Ctrl-D** to the question. The `ypinit` program will then initialize the system databases for NIS service. After this has completed you can start the NIS server itself. The next time you boot the system this will all happen automatically.

```
# ypserv                                (start the NIS server)
```

Next edit the file `/etc/rc.local` using the OpenWindows Text Editor, or a screen editor such as `vi`. Look for the lines shown below:

```
#  
#   Master NIS server runs the XFR daemon  
#  
#   ypxfrd                                echo -n ' ypxfrd'
```

Delete the `#` comment symbol at the start of the `ypxfrd` line which will then be as shown below, and then save the file.

```
#  
#   Master NIS server runs the XFR daemon  
#  
   ypxfrd                                echo -n ' ypxfrd'
```

In future this will start up automatically if the system is rebooted. For now, however, you must start it manually by typing:

```
# ypxfrd                                (start the XFR daemon)
```

Finally, you need to configure the client machines to run NIS so that they consult the server for the host and other NIS information. See 'Initial System Configuration' and 'Configuring for a Network with NIS' above for further information.

---

**NOTE**

For NIS to operate you must set up the server first, and then the client machines. If client machines are already on the network you will need to restart them using the `reboot` command executed as `superuser` before the NIS service will operate.

---

If you add a host to the network at a later date you only have to edit the `/etc/hosts` file on the NIS server and remake the NIS database by doing the following on the NIS server. The new machine will then be able to access all the existing networked machines with no further changes.

```
# cd /var/yp
# make
```

(re-make the NIS database maps)

---

**NOTE**

This Guide can only describe the simplest NIS configuration. For information on setting up NIS passwords, automounters, user and group databases, C2 level secure networks, master and slave servers, and other more advanced network administration topics you will need to refer to the optional complete documentation package for the SPARCbook Solaris Operating System.

---

---

## ***NETWORK FACILITIES***

---

This is a brief guide to the network facilities available on the SPARCbook system. This covers copying files, logging in to a remote system, and executing programs on a remote system. The following section describes how to set up a simple network-wide distributed file system.

---

**NOTE**

There are many other network capabilities provided in the Solaris Operating System. If you are not familiar with UNIX networking you should refer to the optional complete documentation set for further information.

---

---

## ***COPYING FILES***

---

The `rcp` command is used to copy files between machines. You may do this from the File menu of the File Manager in OpenWindows. Choose the Remote Copy option by moving the pointer to the Files button, pressing the Menu key and holding it down while you move the pointer to the remote copy option. Releasing the Menu key will cause a pop-up window to be shown. Fill in the requested fields. You should not specify the name of your own machine. The path can be a file name or a directory name. The next example shows copying a file called `info` from the local machine to the `/tmp` directory on a machine called `mars`.

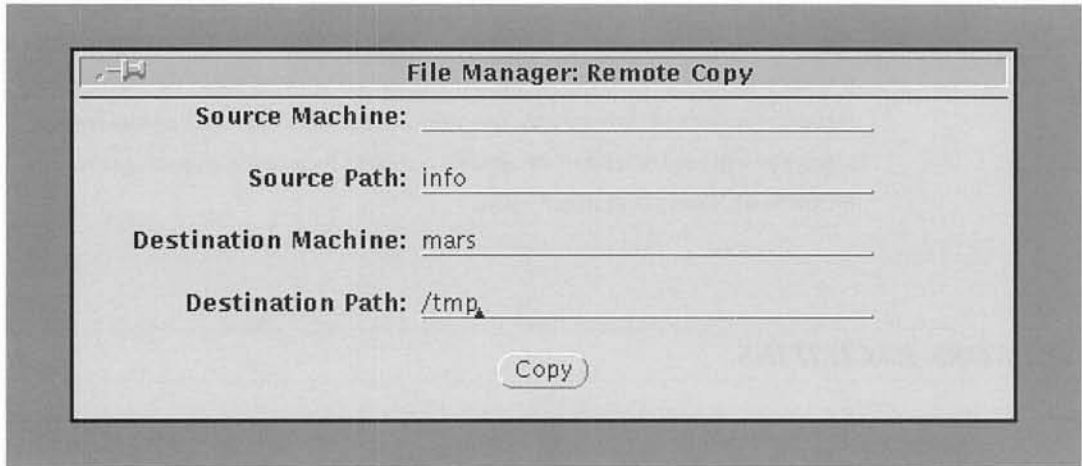

Alternatively, from the shell command prompt you can use `rcp` as follows:

```
% rcp [-r] [fromsys:]fromfile [tosys:]tofile
```

<code>-r</code>	is to copy a directory as opposed to a file.
<code>fromsys:</code>	is the name of the remote system you are copying from. It is not used if you are copying from your own machine.
<code>tosys:</code>	is the name of the remote system you are copying to. It is not used if you are copying to your own machine.

---

The same example as before using the rcp command would be:

```
% rcp info mars:/tmp/info
```

---

## **REMOTE LOG IN**

---

You may log in over the network as a user onto another machine. Depending on how you have set up the network you may need to supply a password to log into a different machine. In addition you will not be able to log in to a remote machine unless you have a user account on that machine or the NIS service is running and knows your password.

The format of the remote log in command is as follows:

```
% rlogin [-l user] machine
```

`-l user` is the log in name to use for the remote machine. The default is your own name, when you can omit the `-l` option.

If the remote machine is not running (for example it is switched off) nothing will happen when you attempt to login (although after several minutes the connection attempt will time out). To stop the log in attempt press the interrupt key sequence (`Ctrl-c`). To log out you may either log out as normal using the `Ctrl-d` key sequence or you can break the network connection by typing the tilde symbol and then a period.

```
% rlogin mars
Last login: Sun Sep 23 06:00:05 from jupiter
mars% ~.
Closed connection
%
```

---

## **REMOTE PROGRAM EXECUTION**

---

If you want to execute a command on a remote machine rather than actually log in, you can execute it using the remote shell or `rsh` utility. The command syntax is as follows:

```
% rsh sysname command
```

<code>sysname</code>	is the name of the remote system to execute the command on
<code>command</code>	is the command to execute

For example to list the files in `/home` on the machine called `mars` you would type the following:

```
% rsh mars ls /home
peter paul user demo          file/directory names
%
```

---

## **CHECKING A REMOTE SYSTEM**

---

To see if another machine is operating on the network you can use the `ping` command. `ping` sends a low level protocol request to the specified machine and waits for a response.

```
$ /usr/etc/ping mars
mars is alive
$ /usr/etc/ping mercury
no answer from mercury
```

The command syntax is:

```
$ ping name [t]
```

<code>sysname</code>	is the name of the remote system
<code>t</code>	is optional time in seconds to wait before giving up. The default is 20 seconds.

---

## ***NETWORK PROBLEMS***

---

Most network problems are either related to the initial set up of the hardware, or are to do with the system file configurations. Some of the more common errors give appropriate error messages when you try and execute commands.

- `Permission denied` message

This message is because you do not have permission to carry out the requested operation. This could be for one of the following reasons:

- You do not have a user account on the remote system

- You have not set up a `.rhosts`.

- If you do not have a `.rhosts` file set up you may be able to login to the remote machine but not use `rsh` or `rsh`.

- The directory you are trying to read or write has been set up so you have no permission to read or write it.

See 'System Setup' and 'Configuring the Network' for more information on the file configuration and setting up users.

- `[hostname]: unknown host`

This message is because your system does not recognize the host name you have used. Check the following:

- If you are not running NIS check the remote system name is in the `/etc/hosts` file

- If you are not running NIS check your system name is in the remote systems `/etc/hosts` file

- If you are running NIS check that the NIS server `/etc/hosts` file has your system name included and that the NIS database has been updated (see 'Setting up a Simple NIS Server').



- 
- Login incorrect

This message is typically because an `rcp` or `rsh` operation has attempted to login to a remote system where you do not have an account set up. Look at the same things as for the `Permission Denied` message above.

<b>NOTE</b>
-------------

---

Using NIS it is possible to set up a single network wide user database for all network users to allow them to log into any authorized machine. You will need to refer to the full documentation for further information on this service.

---

---

## ***SETTING UP A DISTRIBUTED FILE SYSTEM***

---

The SPARCbook implementation of Solaris 1.0.1 provides facilities to run both the Sun Network File System (NFS) and the AT&T Remote File System (RFS). Both are examples of distributed file systems. However, only the NFS file system is supported in the bundled SPARCbook distribution. The RFS package is available on the system CD supplied with the machine. Refer to 'Customizing the Solaris Operating System' for more information. Use of a distributed file system allows you to set up a network with users able to access files on remote machines as if they were their own. For example a file server can be configured with a large disk drive to store shared files such as manual pages, which are then accessible to all users. This section explains how to set up a distributed file system based on NFS. For more detailed information you will need to refer to the optional full Solaris 1.0.1 documentation.

You will need to be logged in as root, or to be in a Command Tool and have executed the '`su`' command, to carry out the following procedures. Remember to log out or type `Ctrl-d` when you have finished revert to your normal privileges.

---

## SHARING A DIRECTORY

---

You can make one or more of your own directories available to the network. Other users on the network are then able to access these directories, and any files or subdirectories. To make your whole system available you can specify the root directory, but more normally you will only make a file system or a specific directory of files available.

You will need to log in as root to perform the following operation from an OpenWindows command tool shell prompt or from the log in shell prompt.

Using the OpenWindows Text Editor, or a UNIX editor such as vi from a command tool, edit the file `/etc/exports`. This file will not already exist if you have never used this facility on your SPARCbook. This file consists of a set of lines each of the following format. In addition any line starting with a # symbol is taken as a comment and has no effect.

```
directory [-option[,option]...]
```

`directory` is the name of the directory you wish to share or *export*.

`option` is typically one or more of the following:

```
ro                export the directory read only (the default is read/write)
rw=host[:host]... export the directory read only except to the specified host
                  name(s).
root=host[:host]...allow root (superuser) access to the specified hosts
                  name(s). The default is not to allow superuser access
                  privileges.
```

As an example the following lines would allow other network users to be able to read or write any of the files in the `/usr` directory, and to read but not write the files in the `/opt/editors` directory on your machine.

---

```
# /etc/exports file
# directories to share

/usr                # read/write access
/opt/editors        -ro    # read only access
```

To allow the directory to be exported you can either restart the operating system by logging in as the superuser and typing `reboot`, or you can immediately allow access by running the following commands. Note that once the `/etc/exports` file exists the specified directories will be exported automatically whenever the operating system is restarted (as opposed to saved and resumed) from then on. The following commands can be used to export a directory without needing to reboot:

```
# nfsd 4 &                start NFS daemons
# exportfs -a            export the directories specified
# rpc.mountd-n          start the mount daemon
```

If you adding directories to an existing `/etc/exports` file the NFS daemons will already be running and you only need enter the `exportfs` command. If you type `exportfs` on its own with no arguments the system will report a list of shared directories. You can also unexport a shared directory at any time by using the `exportfs -u` command as the examples below show:

```
# exportfs -u /usr        deny NFS access to /usr
# exportfs -ua           deny NFS access to all directories
```

**NOTE**

---

NFS shares directories on a file system basis. Thus, if you have a dual disk SPARCbook and you wanted to export all of your files you would need to export the root directory (`/`) and any mounted file system directories. To get a list of the mounted file system directories use the `mount` command.

---

**NOTE**

---

You should be careful when you shut down the machine, or when you use the `exportfs -u` command since the resources on your machine will then become unavailable to other users, even if they are in the process of actually using them.

---

---

## USING SHARED DIRECTORIES

---

To access a directory that has been made available for sharing on the network you use the `mount` command. This allows you to mount both local file systems and remote directories, and to then access them from within your normal directory structure.

You will need to log in as root or be superuser to perform the following operation from an OpenWindows Command Tool shell prompt or from the login shell prompt.

```
# mount [-r] [-o options] remname:pathname mtpoint
```

<code>-r</code>	specifies to mount read only (default is read/write)
<code>options</code>	is one or more of following, comma separated
<code>soft</code>	return an error if NFS request is not accomplished and stop trying (default is hard)
<code>hard</code>	try repeatedly until maximum retries is reached
<code>retry=n</code>	set maximum retries to n (default is 10000)
<code>remname</code>	is the name of the remote system
<code>pathname</code>	is the directory name on the remote system
<code>mtpoint</code>	is the directory name on the local system to place the directory

As an example assume you wanted to mount the `editors` and the `usr` directories from the previous examples on a different machine. Suppose that you want to use a new directory called `/usr/files` and that the machine with the actual directories on is called `pluto`.

```
# mkdir /usr/files
# mkdir /usr/files/plutos_usr
# mkdir /usr/files/editors
```

---

These steps are only needed if new directories are required. You can mount exported directories onto existing directories if you wish but you will not be able to access the existing directories' contents while the remote directory is mounted on them. The command `mkdir` makes a new directory and is the equivalent of making a new folder from the File Manager in the OpenWindows environment.

Next mount the directories:

```
# mount pluto:/usr /usr/files/plutos_usr
# mount -r pluto:/opt/editors /usr/files/editors
```

Note that for the second command you must specify read-only since the directory was only made available read-only. The directory structure of the machine you are using will now be changed as shown.

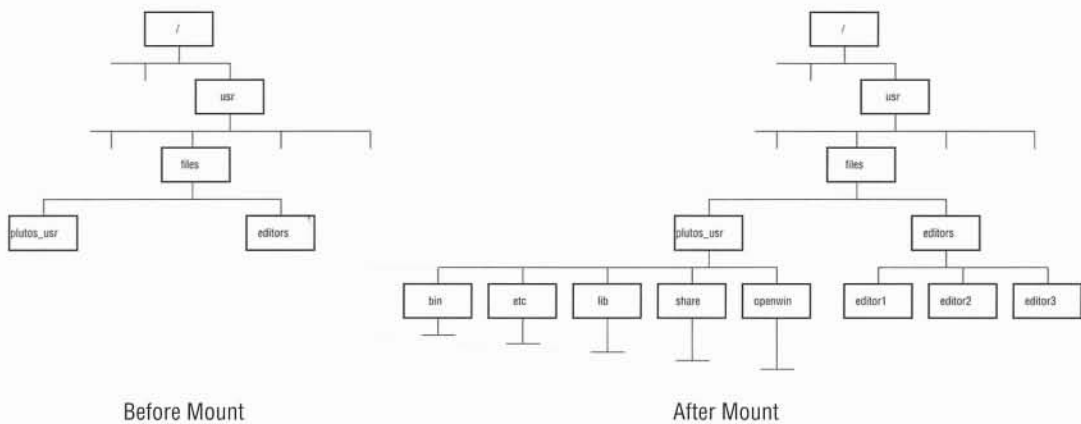

---

You may also specify remote directories to be mounted automatically when you start up the Operating System or after a reboot (but not after a save and resume). To do this you need to edit the `/etc/fstab` file. The `fstab` file consists a set of lines for each directory and file system to be mounted. The default SPARCbook `fstab` file for a single disk system is:

```
/dev/sd0a      /      4.2 rw 1 1
/dev/fd0       /pcfs  pcfs rw,noauto 0 0
```

Each line has 6 fields separated by space or tab characters. These fields are:

Device to mount:	This is the device name for a local file system or the <code>remname:pathname</code> as defined above for a remote directory.
Mount point	This is the directory where the file system or remote directory is to be mounted.
FS type	This is the type of file system which will normally be <code>4.2</code> , for a local file system, or <code>nfs</code> , for a remote mounted directory.
Options	normally <code>ro</code> for read only, or <code>rw</code> for read/write. The other NFS options specified above may also be used. The <code>noauto</code> field means the directory will not be mounted automatically at Operating System startup.
Freq	Number of days between dumps for the automated backup facilities documented in the full operating system documentation. Normally set to 1 for local file systems and 0 for remote mounted directories.
Fsck Pass	Normally 1 for the root file system, 2 for all other local file systems, and 0 for remotely mounted directories.

As an example, to automatically mount the directories specified before you would edit the `/etc/fstab` file by adding the following two lines:

---

```
pluto:/usr /usr/files/pluto_usr nfs rw 0 0
pluto:/export/editors /usr/files/editors nfs ro 0 0
```

You may unmount a directory at any time by using the `umount` command with Mount point directory as an argument. For example, to unmount the two directories used previously you would type:

```
# umount /usr/files/plutouser
# umount /usr/files/editors
```

If you get a message saying `[name]: Device busy`, it is because the machine is still using files in that directory. This may be because an application is using files in that directory, or simply that your current directory is in the mounted tree. You will need to quit any applications that are using the remote resources, and/or change directory to a local directory before trying again.

---

## ***NETWORKS AND PORTABLE MACHINES***

---

Since the SPARCbook is a true notebook sized computer it may be frequently connected and disconnected from the network. This does not pose any significant problems as long as you are aware of the implications of your actions.

In normal use when connected to the network you will have access to all of the network facilities. This can be very useful in providing access to large file servers, printers and other resources available on the network. However, when you are away from the network you will only have the local facilities on your own SPARCbook machine. The Save and Resume feature may be used to switch off your SPARCbook before you disconnect it from the network and take it away. When you return and reconnect to the network the Resume facility will take you back to where you were. However you need to be aware of several possible implications of frequent connection and reconnection to a distributed file system.

---

- USING REMOTE RESOURCES

You should not be using files in remote directories when you shut down the system. If you do attempt to shut down or Save while you have files open on remote directories you may lose any changes you have made and you may have problems when you restart the machine (for example the files you are using may have changed, or may no longer be present). In addition if the remote server is shut down while you are away the knowledge of your connection will be lost and you will not be able to access the file when you resume. It is recommended that you do not Save while you are using remote resources. Instead unmount them before switching the SPARCbook off.

- PRINTING

It is not recommended to try and print files to a remote printer when you are not connected to the network. However, if you do try and print a file to a remote printer while you are not attached to the network the print file will be spooled. Errors will be displayed on the Print Tool or the Console and the printer processes may stop. Refer to 'Printer Problems' if this happens.

- MAIL

If you have set up a remote system for mail services the SPARCbook will only access the remote system when it is connected to the network. Received mail can be collected when the SPARCbook is next connected. Mail to be transmitted via the network should only be sent when you are attached to the network physically, or by logging into a remote machine using the internal modem connection. See 'Configuring Electronic Mail' for further information.



---

## ***ATTACHING AN EXTERNAL VGA MONITOR***

---

The SPARCbook system can be used with an external color VGA monitor. This section explains what types of VGA monitor are supported, how to physically connect the monitor to the SPARCbook, and how to operate the system with the VGA monitor connected.

**NOTE**

The SPARCbook system will consume more power when a VGA monitor is being driven. While a VGA monitor can be driven when the SPARCbook is battery powered it is recommended that you connect the SPARCbook to the external charger/adaptor when using an external monitor.

SPARCbook models with monochrome screens use color mapping to map colors to grey scales. OpenWindows and applications run in color by default, even on a monochrome SPARCbook, and will therefore run in color on the external VGA display.

---

## ***CONNECTING THE VGA MONITOR***

---

The SPARCbook can drive any standard 640x480 VGA color monitor intended for IBM or compatible computers. 16 colors are simultaneously displayable from a choice of 256144 shades. It is possible to simultaneously drive the internal LCD flat panel and the external VGA monitor at the 640x480 resolution.

The back-panel connector is the IBM PS/2 style 15 Pin D type connector with three rows. The pin-out is standard and is detailed in the 'Technical Reference' Section.



---

Most VGA monitors will be supplied with a cable compatible with this connector. Older VGA monitors may require a converter cable available from any PC dealer or outlet. To connect the VGA monitor simply plug the monitor 15 way D Type cable into the SPARCbook and turn the VGA monitor on.

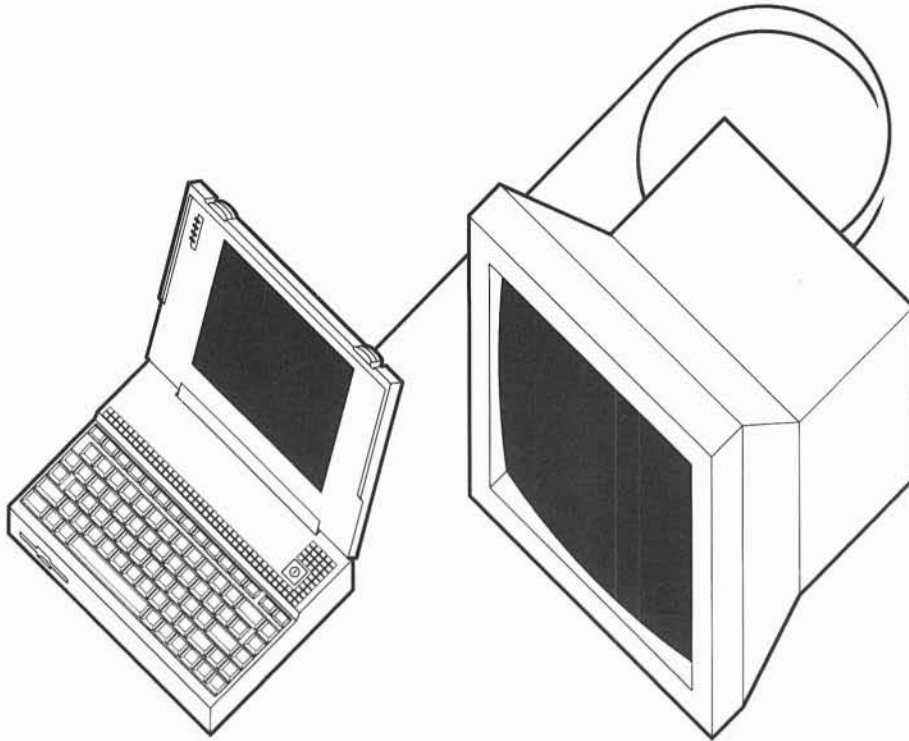

---

### ***USING THE EXTERNAL MONITOR***

---

By default the external monitor is disabled to conserve power. In order to ensure that you do not inadvertently leave the monitor interface running when you take the SPARCbook away the external monitor is disabled every time you turn the SPARCbook off. To enable the interface from OpenWindows you simply need to Choose the **External VGA** option from the Workspace Manager Portable menu.

---

To do this from the move the pointer into a spare area of the Workspace and press the Menu key (this is the same as the 's' key). While holding down the Menu key move the pointer down to the Portable selection and then across to the **External VGA** menu option. Release the Menu key and the VGA monitor will be automatically enabled.

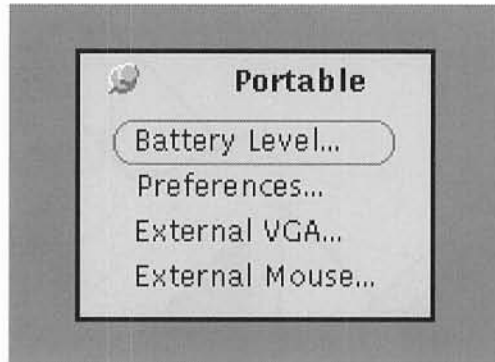

If the VGA monitor is connected and is powered on the display should show the same picture as is on the internal LCD display.

**NOTE**

---

You may also turn on the external monitor from the shell command prompt. The command `extvga` will turn the external VGA monitor on.

---

---

## USING A HIGH RESOLUTION EXTERNAL MONITOR

---

The SPARCbook system also supports connection to an external Industry Standard Super-VGA monitor at 800x600 resolution. 16 colors from 262144 are displayed as for the standard VGA monitor.

<b>NOTE</b>
-------------

The 800x600 option requires an autosyncing monitor capable of displaying both 640x480 and 800x600 resolutions. See the 'Technical Reference' section for further information.

---

The OpenWindows software may be configured to run with the external 800x600 colour monitor. In this case the internal LCD display is turned off and you are not able to use it until you exit from OpenWindows and revert to standard 640x480 resolution.

To work in the high resolution mode you must enter OpenWindows from the shell command line. By default when you normally log in (except as root) you will see a message

Starting OpenWindows (Ctrl-C to escape)

If you press Ctrl-C when this message is displayed the system will enter the shell command line prompt. You may then enter the following to start up OpenWindows:

<code>% openwin</code>	this is the normal method and will run 640x480 on the internal display and optionally on the external display.
<code>% openwin -high</code>	this will automatically enable the external VGA monitor interface and will start-up OpenWindows running in 800x600 resolution on the external display. The internal display will be turned off.

When you perform a system Shut-down or Reset the display will automatically revert to the 640x480 mode on the internal display when it starts up again. If you switch the system off using the Save and Resume facility the system will resume in the 800x600 mode.



---

If you are going to resume without the high resolution monitor you should first exit your applications and exit from the OpenWindows server. If you do not do this then you will not be able to access the screen when you resume because the SPARCbook will be in external 800x600 mode. If you forget to exit then you can forcibly quit the server when you resume by typing the `Alt-Esc-X`. Remember this will also quit any applications that are running at the time. The display will be switched back on and you will be at the UNIX or login prompt. To restart the OpenWindows server log in as normal, or type the `/usr/openwin/bin/openwin` command to the UNIX prompt.

---

### ***USING AN EXTERNAL MOUSE***

---

The SPARCbook allows the connection of a conventional external Mouse to the system. Operation of the external Mouse is completely transparent to all system software and applications.

The SPARCbook provides support for an IBM PS/2 compatible connector, signal levels and Microsoft/Logitech three byte data format. The Mouse connector is the standard 6 pin mini-DIN. Refer to 'Technical Reference' for the connector pin out.

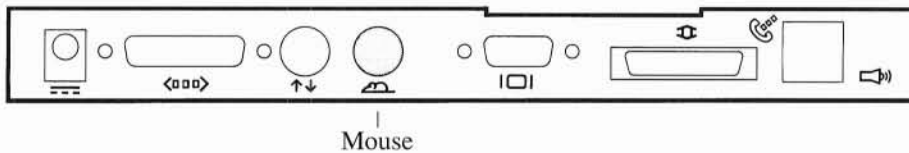

**NOTE**

---

You may only use a PS/2 compatible Mouse. You must not connect an RS232 serial Mouse (including a mouse for a Sun workstation) to the SPARCbook or you may damage the mouse and /or SPARCbook.

---

---

To use the Mouse simply plug it into the socket at the back of the SPARCbook. The mouse must be initialized after it has been plugged in by Choosing the **External Mouse** option from the Workspace Manager Portable menu in the same way as described above for the External VGA facility.

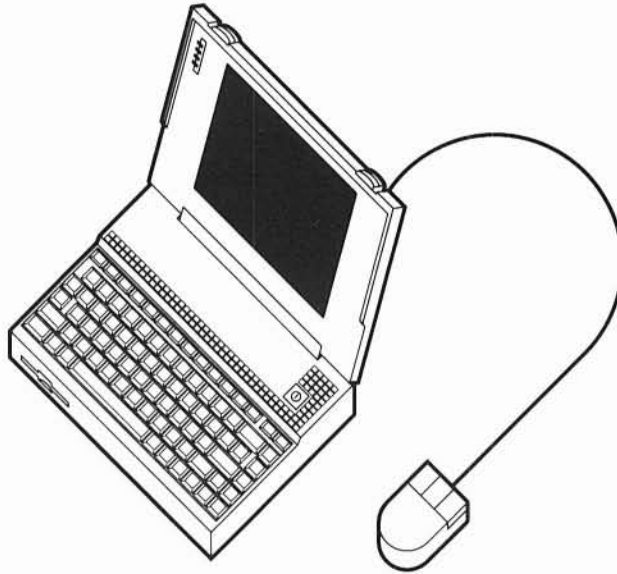

**NOTE**

---

You must reinitialize the external mouse from the OpenWindows environment as described above every time you use the machine. The internal Mousekey is still enabled when you are using the external mouse. If you unplug the external mouse you need take no further action to continue using the internal Mousekey.

---

---

### ***USING AN EXTERNAL KEYBOARD***

---

If you wish to use an external full size keyboard with the SPARCbook you may do so by plugging in a suitable keyboard to the Mouse port. It is not possible to use an external keyboard and Mouse simultaneously unless your keyboard provides an internal or an attached Mouse implementation compatible with the SPARCbook standard Mouse protocol.

---

The keyboard must be electrically compatible with the IBM PS/2 TTL keyboard. Other keyboards may be used but they must have the correct TTL level interface. The pinout arrangement is the same as for the Mouse and is specified in the 'Technical Reference' section.



---

You must not use an RS232 level keyboard on the Mouse port. If you do not use the correct interface you may damage the SPARCbook and/or your keyboard. A Sun workstation keyboard cannot be used since it implements RS232 levels.

---

To use the keyboard simply plug it into the Mouse socket at the back of the SPARCbook system. The external keyboard can only be used from the OpenWindows environment. The keyboard interface must be determined when you enter the OpenWindows server. Therefore to use the external keyboard you must ensure that it is connected before you start OpenWindows. When you have started up OpenWindows the SPARCbook keyboard will no longer accept input until you exit OpenWindows.

```
$ openwin -keyboard           this will automatically enable the external
                               keyboard interface and will start
                               OpenWindows.
```

```
$ openwin -high -keyboard    this will automatically enable the external
                               keyboard interface and will start
                               OpenWindows for the 800x600 high
                               resolution display.
```

**NOTE**

---

When using an external keyboard the Save and Resume facility cannot be initiated. To turn the system off you must first exit OpenWindows. This will cause control to revert automatically to the internal keyboard. When the OpenWindows server has exited and the terminal display is shown on the SPARCbook screen you may turn the system off using the Save and Resume facility in the normal way.

---

---

## ***CONNECTING AN ASCII TERMINAL***

---

A conventional ASCII terminal can be connected to the SPARCbook serial I/O port to give an additional user or login port. The SPARCbook supports serial I/O devices with RS232 interfaces at baud rates from 300 to 38400 baud. By default the serial port is not enabled as a login port, to allow it to be used as a printer port. This section describes how to connect a serial terminal to the SPARCbook and how to configure it as a login device.

<b>NOTE</b>
-------------

The SPARCbook is an FCC registered Class B device. If you connect a peripheral to it that is not Class B registered the entire system becomes a Class A device and should not be used in a residential area. You should take care to use only Class B registered devices in a residential area and you should ensure that all peripherals connected to the SPARCbook do so with fully shielded cables.

- Connect the Terminal to the SPARCbook

The SPARCbook serial port requires a cable from the port to the terminal. This cable depends on the terminal being used. The Technical Reference Section gives details of the SPARCbook serial port connector pin out and gives details of the construction of commonly required cables. You may also need to consult the Technical Manual for the terminal you are using.

- Enable a Login port and Set the Baud Rate

To enable the SPARCbook serial port for a second log in you must tell the Operating System that the serial port is to be used as a log in port. To do this you will need to be logged in as the superuser to the root account.

Using the OpenWindows Text Editor or a UNIX editor such as `vi` from the `cmdtool` interface edit the file `/etc/ttytab`. The first few lines of this file are shown below:



---

```
# @(f)ttytab 1.6 89/12/18 SMI
#
# name  getty                type      status comments
#
console  "/usr/etc/getty std.9600" sun        on local secure
ttya     "/usr/etc/getty std.9600" unknown   off local secure
ttyp0    none                       network   off secure
```

To enable the serial port for a log in from an attached terminal you need to change the `off` status for the `ttya` line to `on`. Once you have made the change you should save the file and exit the editor.

Next you must tell the Operating System to reread the `/etc/ttytab` file. To do this enter the following command to the command tool or shell prompt:

```
# init -HUP
```

This command will enable the serial port for a log in from a connected terminal or other serial device. If you have connected the serial port cable correctly the system should respond with a login message when you press `Enter` or `Return` on the terminal keyboard. If the terminal is set up for a speed other than the initial speed used by the system the SPARCbook will change baud rate after each character is sent until it sees the correct rate. You may need to press `Enter` or `Return` several times to obtain a prompt if the baud rate is not correct.

Whenever you shut down the system and restart it the login port will be available on the serial port line.

- Disable a Login port

If you have enabled the login port and at a later date want to change the usage of the port back to a normal port for a printer or other serial I/O device not requiring a login you should reedit the `/etc/ttytab` file and change the `yes` status for `ttya` back to `no`. You will then need to tell the system again by executing the same `init -HUP` command.

---

## ***CONNECTING AN X TERMINAL***

---

You may connect a third party X Window terminal to the SPARCbook using the integral Ethernet interface. An X terminal allows you to have a second port into the SPARCbook with graphics capability. You should follow the instructions provided with X terminal on how to interface it to the SPARCbook and how to configure the software interface. You should also refer to 'Configuring the Network' for information on how to connect and set up the network interface.

<b>NOTE</b>
-------------

---

X Terminals have an integral X Window Server allowing them to display graphics. They then connect over Ethernet to the SPARCbook *clients*. The clients, or applications, send standard protocol sequences over the network to the connected terminal. In this way it is possible to run OpenWindows and other SPARCbook facilities over the network. However, you should remember that you will not be able to use any of the display PostScript facilities of the SPARCbook on the X terminal since the SPARCbook PostScript support is built into the NeWS server. As an example you will be able to use the basic Fax Tool facility but you will not be able to use the Preview facility in the Fax Tool from an attached X terminal.

---

---

## ***THE INTERNAL MODEM***

---

The SPARCbook computer includes a Hayes Compatible 2400 baud data and 9600 baud SendFax® internal modem. The specifications and protocols for the modem are provided in the Technical Reference. This section provides information on how to connect and configure the modem.

To use the modem you need to plug it into the wall phone socket using the lead supplied.

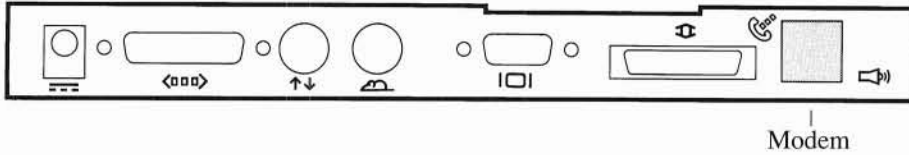

---

The SPARCbook is approved for connection to the US telephone system in accordance with FCC Part 68 rules. You are not permitted to connect the internal modem to the telephone system in any other country. In countries other than the USA you should contact your SPARCbook supplier for details of available external modems.

---

The modem will normally be used in a direct calling mode. This might be used for logging into a remote machine, accessing a bulletin board or sending a Fax. However, many UNIX based systems, including SPARCbook, restrict external user access to maintain security. It is often only possible to dial in to a special account which restricts access to other parts of the system. The mechanism for doing this is called UNIX to UNIX Copy or *uucp*. This section also describes how to set up the *uucp* system files for such a connection.

**NOTE**

---

A complete description of *uucp* and its facilities is beyond the scope of this Guide. For further information you should refer to the optional complete Solaris 1.0.1 documentation set.

---

---

## ***SENDING A FAX***

---

To send a Fax you can use the OpenWindows Fax Tool utility documented in the DeskSet reference section. You can also send a Fax directly from the command line prompt as follows:

---

`$ sendfax filename destination`

`filename` is the file you want to send. This must be a PostScript format file.

`destination` is the user phone number. The phone number is specified in the normal way (and can include the tone dial characters \* and #). Two special characters may be used to control the access.

- Specifies to wait for a secondary dial tone before proceeding
- Specifies to pause for 4 seconds

As an example to send a PostScript file called `memo` to a Fax on phone number 1 234 567 890 from an exchange where 9 is the access code to get an external dialtone, you would specify the following command:

`$ sendfax memo 9=1234567890`

If you want to send ASCII files you will need to preprocess the ASCII to generate PostScript code. If you are not familiar with UNIX commands you should use the OpenWindows Fax Tool for this function. From the command line you can preprocess a text file using the `a2ps` utility. For example, to send the ASCII file `text` to the same number you could type:

`$ a2ps text | sendfax - 9=1234567890`

The `-` symbol tells `sendfax` to use 'standard input' (this is the output of the 'pipe' from the `a2ps` command) rather than a file name.

**NOTE**

---

The Fax utility does not spool Fax requests. If the line is unobtainable or engaged a corresponding message will be printed. See the 'Fax Tool' for further information.

---

---

## *DIALING OUT TO A REMOTE SYSTEM*

---

You can use the phone line to dial directly out to a remote system or bulletin board. To open a connection to a remote system you use the `cu` utility. To establish a connection you will first need to be in at a command shell from your login account or by opening a `cmdtool` in the OpenWindows environment.

The `cu` command runs in two phases. The first phase establishes the connection. The second phase is interactive and allows you to transfer files between SPARCbook machines or the SPARCbook and other UNIX systems.

To dial up a remote system type the following command:

```
% cu [number]
```

As for the Fax utilities the Phone number `[number]` is specified in the normal way (and can include the tone dial characters \* and #). The same two special characters are used for the special functions.

- = Specifies to wait for a secondary dial tone before proceeding
- Specifies to delay for 4 seconds

Alternatively if you have set up a remote login (see below) you can simply specify:

```
% cu systemname
```

As an example, to dial a phone number 1 234 567 890 from an exchange where 9 is the access code to get an external dialtone, you would specify the following command:

```
% cu 9=1234567890
```

Once you have accessed the remote system the action taken depends on the remote configuration. Assuming the remote system is running UNIX there are several additional command options that `cu` gives you over and above the ability to log in and use the remote machine.

!	Escape into a command prompt on the local machine. The connection remains active. Once in the command prompt typing <code>Ctrl-d</code> will return you to the connection.
%take from [to]	Copy a file. <code>from</code> specifies the file name on the remote system, <code>to</code> is the file name to copy to on the local system. If <code>to</code> is omitted the same file name is used.
%put from [to]	Put is the opposite of take. It sends the <code>from</code> file to the remote system.
. (Period)	Terminates the connection.

In order to use system abbreviations you must edit the uucp file called `/etc/uucp/Systems`.



Before you change any uucp related files you should be logged in as root, or have executed the `su` command, and you must change your user ID to uucp. This is because uucp owns all the administrative files. To do this log in as root and then type:

```
# su uucp
$
```

When you are finished type

```
$ exit
#
```

If you do not follow this procedure you can stop the uucp system from working correctly when you have completed setting it up.

Using the OpenWindows Text Editor or `vi` you can edit the `Systems` file to get easy access to a defined set of remote systems. These are three typical systems file entries:

```
mars      Any;15 ACU 2400 9=1234567890 in:-in: nuucp word: secret
mercury   Any;15 ACU 2400 9=Austin123456 in:-in: user word: myown
mypc      Any;15 ACU 2400 9=homepc      ""
```

---

The format of the system file is as follows:

<code>name</code>	This is the system name. Note that this must correspond to the network name of the system.
<code>time</code>	<code>Any;15</code> is the default and allows connections at any time. It specifies a retry for uucp (see below) every 15 minutes if the connection fails. You can also specify when to call by using <code>Su, Mo, Tu</code> etc for days of the week and by specifying a time. For example to call only overnight and at weekends you could use <code>'Wk 1700-0800, Sa, Su;15'</code> instead of <code>'Any;15'</code> . ( <code>Wk</code> is an abbreviation for <code>Mo, Tu, We, Th, Fr</code> )
<code>type</code>	should be <code>ACU</code> which specifies the Modem interface
<code>class</code>	should be <code>2400</code> which is the default. The SPARCbook modem will automatically adjust to lower speeds if necessary.
<code>phone</code>	this is the phone number of the system you are accessing. This is in the format of above. You can also specify abbreviations from the <code>Dialcodes</code> file (see below).
<code>login</code>	this is to log in to the remote computer. In the example above the machine <code>mars</code> can only be dialed into by uucp. However, the machine <code>mercury</code> has a login that you can access. The login field consists of pairs of fields that are what the specified system expects to receive and what to send as a result. To obtain a Login the standard sequence <code>in:-in:</code> is used. This is waiting for the <code>Login:</code> prompt. In the example above your normal login would be <code>user</code> and then the local system looks for the <code>password:</code> prompt. Then your password is entered. If you do not want to actually log in you can specify just the <code>" "</code> characters as for the <code>mypc</code> entry; in this case the line will simply connect you. If you type Enter when you are connected you should get the remote system prompt.

You can store any number of abbreviations in the uucp file called `/etc/uucp/Dialcodes`. Using the OpenWindows Text Editor or `vi` you can edit the `Dialcodes` file. Each line has a name, a corresponding number and an optional comment. Note that names must start with a lower or upper case letter from A-Z to avoid confusion with numbers.

---

```
officefax      234 567 890
homefax       1 300 300 300
austin        1 512                # austin area code
```

---

**NOTE**

For security reasons many UNIX systems that are accessed from the phone system only allow the `nuucp` login which is the `uucp` interface. See the next section for information on how to set up `uucp`. If you do set up a system to allow a direct log in you should take measures to ensure a user logging in from outside cannot do damage to your computer installation or access sensitive data.

---

---

## ***THE UUCP FACILITY***

---

Using UUCP you can copy files and queue transfer requests to and from a remote system. Unlike the previous utilities `uucp` is not permanently connected to the phone line. Instead all `uucp` tasks and requests are queued. Periodically `uucp` may be configured to start up and will determine if there is anything to do. If necessary it will dial out to one or more remote systems and either deal with the outstanding requests or enquire from them if there is any new information or data for the local machine. This facility can be used to transfer files unattended between machines.

**NOTE**

The `uucp` utility can be complex to set up. This section explains how to set up the default `uucp` interface for a machine that is connected to the phone line. You should refer to the optional full documentation set if you want to configure `uucp` in any other than the basic way described.

---

To use `uucp` you must set up a few default files as follows. Remember you must have logged in as root, and have changed your ID with the `su` command to that of `uucp`.



---

- The Systems file

The first file is the `Systems` file which was discussed in the previous section. This must be set up for each remote system that you want to communicate with. The example below shows the entry for a machine named `mars` running a public `uucp` account with a password of `secret`.

```
mars      Any  ACU   2400   9=1234567890   in:-in: nuucp word: secret
```

As explained in the previous section you would normally only alter the system name, the phone number and the password to access a remote system.

- The Poll File

The file `/etc/uucp/poll` gives information for polling remote computers.

The format of the file is the system name, followed by a TAB character followed by the hours (24 hour clock) the machine should be called. The example below calls the machine `mars` every 4 hours:

```
      mars           0       4       8       12       16       20
```

---

## ***SETTING UP UUCP ON THE REMOTE MACHINE***

---

Setting up `uucp` on the remote machine depends on the version of the Operating System and `uucp` being used. If the machine is not a SPARCbook you should consult the system administrator or the Operating System documentation for the machine you wish to access. As a minimum if you are using a SPARCbook for the remote machine you do not need to configure any files at all.

By default as shipped you can call directly between two SPARCbook systems by connecting both to the phone network and using the `cu` facility, or by setting up the `Systems` file on the calling machine and using the `uuto` and `uupick` utilities described next.

---

## USING UUCP UTILITIES

---

The uucp facility may now be used to copy files to and from remote systems as a background activity. The `uuto` and `uupick` commands are used to transfer files:

- Sending Files

The `uuto` utility sends the specified files or directories to a remote user. The remote user is notified of the arrival of the files by mail.

```
% uuto [-m] [-p] files destination
```

`files` This is the file or files to copy. This should just be the pathname(s) of the files and/or directories to copy.

`destination`

This is of the form `system!user` where `system` must be a system known in the `/etc/uucp/Systems` file, and `user` is the name of a user on the remote computer to whom mail will be sent when the file copy is complete.

`[-m]` the `-m` is optional (do not type the brackets if you use it) and sends you mail when the copy has been successfully completed.

`[-p]` the `-p` is optional. If you use it a copy of the file will be spooled for the delivery. If you do not the original copy will be used. Remember that the copy may not occur for some time depending on the system configuration so you should specify `-p` if you intend to change the file or delete it.

---

For example to copy the files `worklist` and `playlist` from your current directory on a system called `jupiter` to a user with log in account `tim` on the machine called `mars` set up in the previous example you might type:

```
% uuto -p worklist playlist mars!tim
```

#### • Receiving Files

The `uupick` command allows a user to receive files sent by `uuto`.

```
% uupick [-s system]
```

`-s`            the `-s` is optional (do not type the brackets if you use it) . You can specify a single system to look for files from. The default is to look for files from any system.

`uupick` will print lines for each received file or directory and will ask you what to do with them. Options are:

<code>Enter</code>	Press the <code>Enter</code> key to go to the next entry and take no action.
<code>d</code>	Delete the entry.
<code>m [dir]</code>	Move the file or directory into the current directory. <code>dir</code> is optional and is the name of a directory to put the data in.
<code>a [dir]</code>	Same as <code>m</code> but operates on all the files that have arrived.
<code>p</code>	Print the file on the default printer.
<code>q</code>	Quit.

For example to receive the two files sent previously and place them in a directory called `infiles`, the user `tim` would type:

```
% uupick
from jupiter jupiter:file worklist ? m infiles
from jupiter jupiter:file playlist ? m infiles
%
```

---

## ***ELECTRONIC MAIL***

---

The SPARCbook system has facilities for the sending and receipt of Electronic mail or email. The user interface to the mail system has already been described in the section on the deskset Mail Tool facility. However, before this facility can be used the email system must be configured for your own requirements. This section describes the email service and how to initially configure your SPARCbook for the sending and receiving of email.

While working as part of a larger network of machines the network itself will normally provide email facilities. When you take the SPARCbook away from the network you can use the `cu` facility to dial in to a remote system to collect your mail.

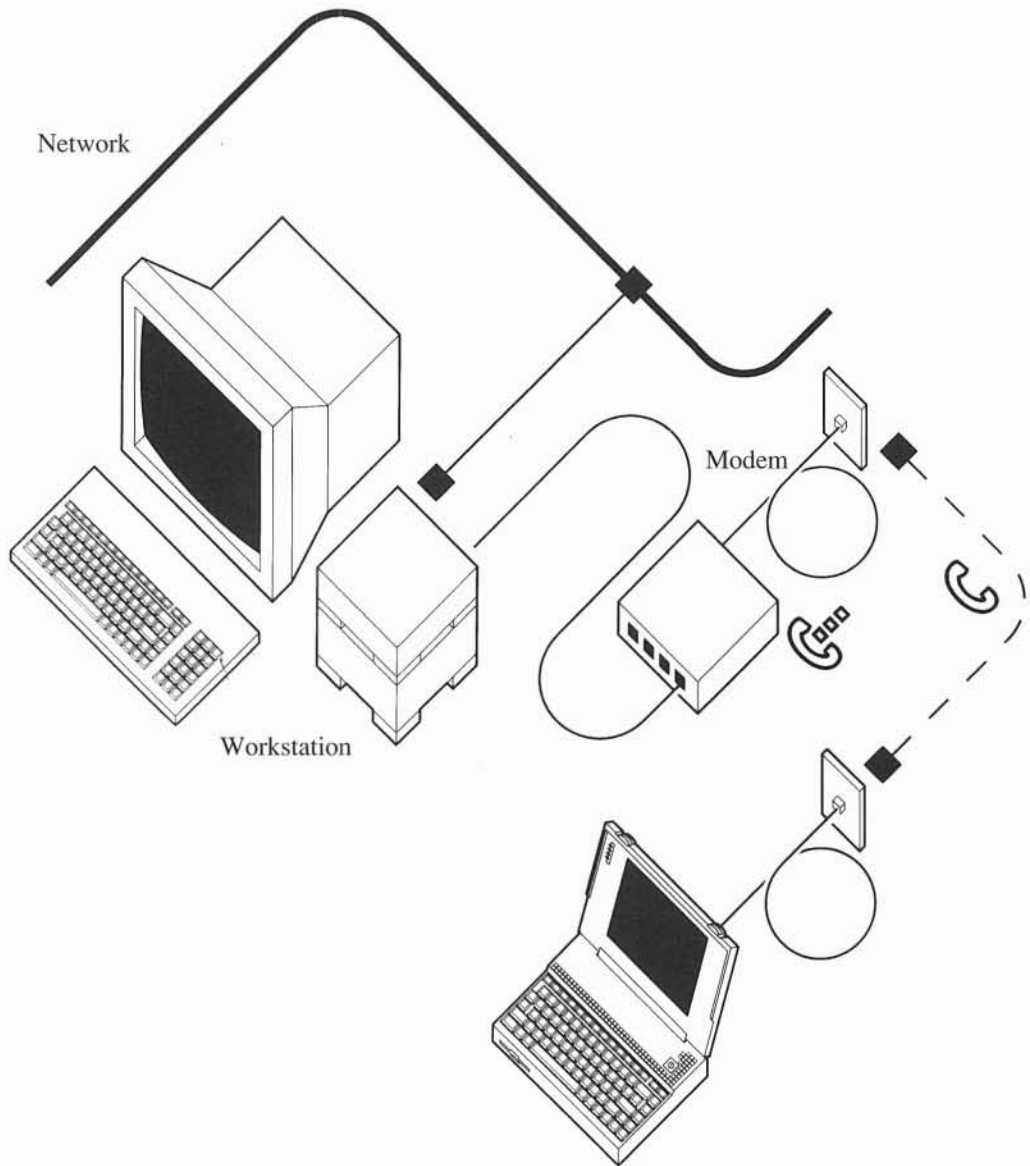

Dialing into a workstation with attached Modem

---

The next section provides information on how to configure your system to send and receive electronic mail from an attached network, and how to use the modem and the `uucp` interface to log in to the network and pick up your mail remotely.

**NOTE**

It is also possible to set up a SPARCbook as a complete standalone email system. In this mode it would be essentially a standalone domain to the Internet and would be able to send and receive mail to any other Internet user directly. To do this you will need to register with an Internet mail feed organization, and register as a new Internet node. This is beyond the scope of this User Guide and you will need to refer to a UNIX administrator or the optional complete Solaris documentation for further information.

---

## ***SETTING UP EMAIL***

---

By default the SPARCbook operating system is shipped ready to use an existing Ethernet based mail facility. If you are attaching to a network that already provides email facilities you only need to follow the instructions on how to connect a system up to the network. Once you have carried out these steps you should contact your network administrator so that your name can be added to those that the network knows about. A typical Internet email address for a user named `user` might be:

`user@eng.company.com`

In this case the Internet services would know that the top level machine for your *domain* was the machine called `eng.company.com` which provides mail services in your company and is connected to Internet. A domain is a set of machines that are networked together. You may actually be on a different machine from the top level machine, but your local domain would handle the mail routing and delivery after arrival at the `eng.company.com` machine.

Once you are connected over Ethernet to a mail server machine you should be able to send and receive electronic mail when connected to the network.

---

In order to access the mail facilities when you are away from the network you can use the modem facility inside the SPARCbook system. To do this you have to arrange to forward your mail to another address when your machine is no longer on the network. The machine you forward the mail to must have a dial-in line available so you can dial into it and access your mail. You will therefore require an account on this system. In a small configuration this system might be the mail server itself.

The main mail server is connected via Ethernet to your own system called `jupiter`. Another machine (in this example a SPARCbook called `mercury`) is also connected to the phone system and provides a server facility for users who want to dial in and collect their mail. Of course it would be possible to use the main mail server for this facility but in a large organization it may not be desirable for the main mail server to be accessible by any user dialing in. You need to arrange to have a user account on `mercury`. Then, before you remove your SPARCbook from the main network you arrange with the system administrator to have your mail forwarded to the new address. Note that in this case your mail address remains as before (`user@eng.company.com`) but the local route your mail takes to get to you has changed from `user@jupiter` to `user@mercury`.

In a larger system configuration you might have the following system configuration, shown in the picture opposite.

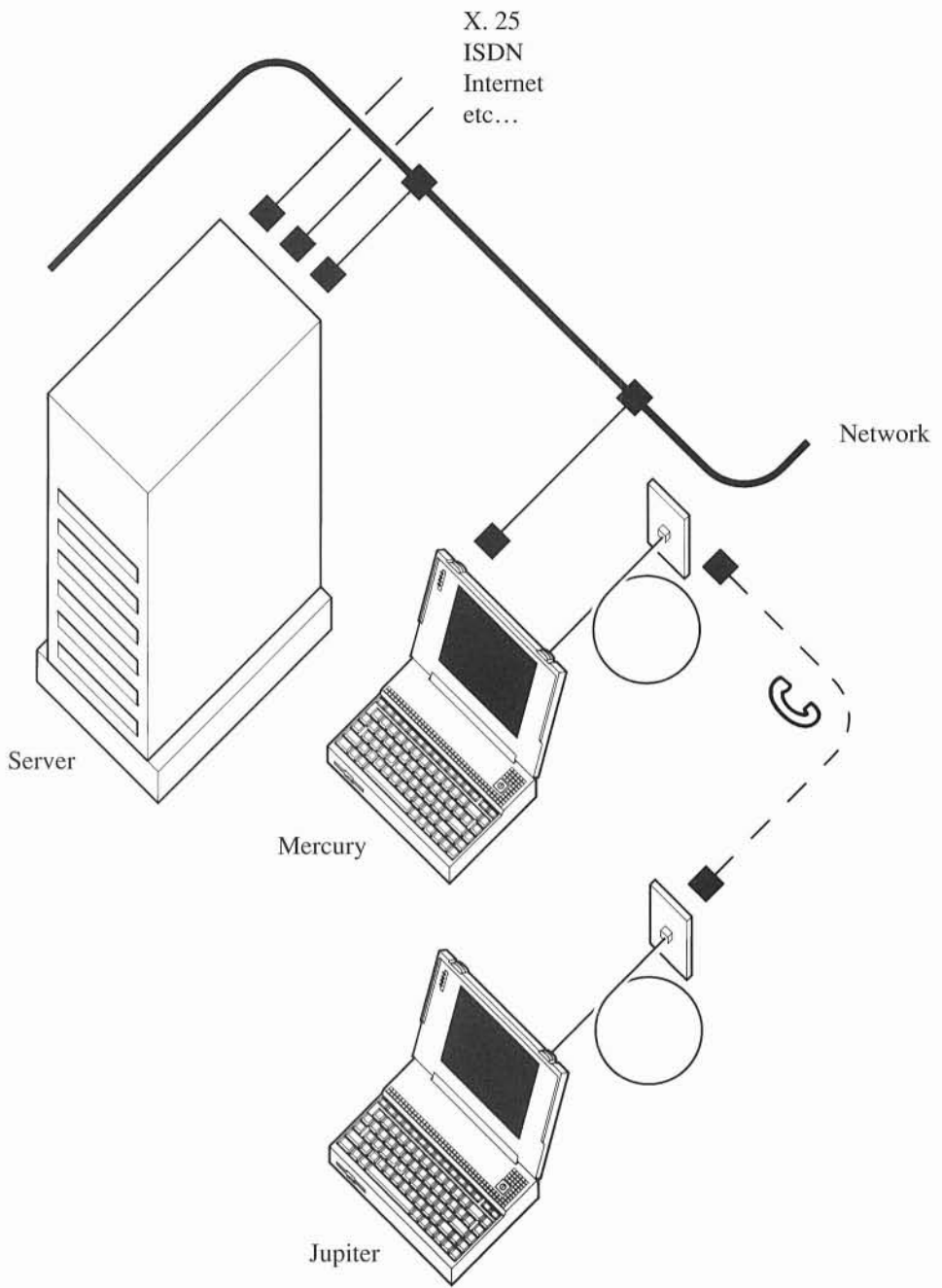



---

To access your mail remotely you need to dial up the remote system (in this case, mercury) and log in to your user account. Since you are logged in over a serial line you do not have access to the OpenWindows tools and you will therefore need to access your mail from the UNIX mail command. To do this type mail to the command tool prompt.

If you have mail a list of messages will be printed on the screen as shown below:

```
Mail version SMI 4.0 Wed Oct 23 10:38:28 PDT 1991   Type ? for help
"/usr/spool/mail/user": 3 messages 3 new 3 unread
>N  1 tim@mars      Sat Jan 11 09:53 15/422 message from tim
   N  2 root@mercury Sat Jan 11 11:08 14/411 system administration
   N  3 peter@jupiter Sat Jan 11 11:09 18/423 your meeting
&
```

The > symbol refers to the current message. The N means that the message is new. Other types are o (old messages), r (read messages) and u (unread messages). Typing a ? will give a help summary of the available commands. Some of these are summarized below.

- d [list] delete specified messages
- f [list] print the header summary again for the specified messages
- m [user] send some mail to user - you will be prompted for a Subject. Enter the Subject and type Enter. You can then type your message. When you have finished type Ctrl-d to return to the mail prompt (the '&').
- r [list] Reply to the current or a list of messages. The reply will go only to the sender of each message. Again, type in your message and Ctrl-d to finish.
- q Quit

List can be a message number or numbers separated by space characters, or can be the name of a user.

---

As an alternative you can read your mail (but not respond to it) from the Mail Tool by copying the mail file from the remote machine to your machine and viewing it locally. To do this use `cu` to establish a connection to the remote machine (see 'Dialing Out to a Remote System' for further information), and then copy your remote mail file to a local file so that you can examine it using the mail file capability of the mail tool. As an example if your login name was `user` you might use the following command:

```
% take /var/spool/mail/user newmail
```

This would copy the mailfile on the remote machine to your own machine and call it `newmail`. Then using the `mailfiles` option in the Files menu of the Mail Tool specify to use the file `newmail` and you will be able to read all of your mail on the local machine.

<b>NOTE</b>
-------------

---

If you use the Mail Tool you will not be able to send mail since you are not connected to the network, unless you have an application package allowing you to do this. To send mail you will need to login and use the command line mail facility as outlined above

---

---

This page deliberately left blank

---

---

# DOS EMULATION

This section describes the DOS emulation interface and provides information on using the DOS emulation package.

The SPARCbook system is provided with DOS emulation capability. This allows you to use the SPARCbook exactly like a 386 notebook PC. Using DOS emulation you can run one or more DOS virtual systems from the user login or from the OpenWindows environment. Unlike in other implementations running on non-native processors, the SPARCbook uses PC compatible I/O devices, removing the requirement for emulation of many PC I/O devices and increasing system performance. The DOS emulation capability provides an Intel 80386 emulation and is capable of running any PC application, including MS-Windows 3. An MS-DOS license is provided bundled with the SPARCbook Operating System.

**NOTE**

---

DOS emulation will not be supported until SPARCbook Version B of the Solaris 1.0.1 Operating Environment. Please refer to the accompanying README documentation for further information.

---

---

This page deliberately left blank

---

## ***BACKUP AND RESTORE***

---

This section describes the backup and restore facilities provided as part of the SPARCbook implementation of Solaris 1.0.1 It gives information on making and restoring backups and provides procedures for what to do if your hard disk is corrupted and you need to restore its contents from floppy disk or from an attached network.



---

The SPARCbook Solaris 1.0 Operating System is provided on a CD with your SPARCbook. If you do not have access to a Sun Workstation with an attached CD-ROM drive, or the optional parallel port to SCSI converter and a SCSI CD-ROM drive you are strongly advised to make a full system backup before you use the SPARCbook. If you do not take a backup and your disk is corrupted you will not be able to recover its contents unless you have a floppy disk based configuration and you have purchased the floppy disk backup set.

---

**NOTE**

---

The Solaris Operating System contains many facilities for automated backup in a large networked environment. This guide only describes basic backup and restore facilities to allow you to rebuild the disk in case of system corruption. For a complete description of the backup and restore capabilities of Solaris you will need to refer to the Optional Full Documentation set. For information on backing up small numbers of user files and data to the floppy disk see also 'Using the Floppy'.

---

---

## ***BACKING UP TO FLOPPY***

---

This section describes how to make a backup of the supplied Operating System onto Floppy disk. This procedure may be used at any time to create a complete back up of your disk. If you carry this out when you first set up your SPARCbook you will create a set of disks that forms the optional Floppy disk backup of the bundled Operating System, available from your SPARCbook supplier. If you have access to a Sun workstation over Ethernet you can make the backup over Ethernet to a disk or storage medium. This can be considerably faster and easier than making the backup onto floppy which takes a minimum of 20 high density floppy disks. Refer to Backing Up Over Ethernet for further information.

<b>NOTE</b>
-------------

---

If you are using a SPARCbook with a second hard disk in place of the floppy you must use Ethernet or the optional parallel to SCSI converter for your backup. This is described in the next section.

---

To backup onto Floppy disk you should follow this procedure.

- Create the miniature file system (minifs).

If you have removed the minifs files (see below) you will not be able to carry out this step.

The miniature file system is a minimal UNIX implementation that is loaded onto the hard disk and is used to restore a backup from floppy disk or from the network. To create the minifs you need to be logged in as root or have executed the 'su' command. From OpenWindows you need to open the `cmdtool` application. When you have the shell prompt you should type:

```
# /usr/etc/install/makeminifs
```

This will prompt for you to enter two floppy disks, one at a time, as shown below. When you see each message you should remove the previous disk and insert the next. Remember to label the disks in the correct order for future use.

---

```
makeminifs: Please insert floppy 1 - type any key to continue
             Writing floppy 1 100%
             Verifying floppy 1 100%
makeminifs: Please insert floppy 2 - type any key to continue
             Writing floppy 2 100%
             Verifying floppy 2 100%
makeminifs: Back up of minifs completed
```

If the system detects that the disk is not formatted it will automatically format the disk before it uses it. If a read, write or verify error occurs you will be informed and asked to replace the disk with a new one. For example:

```
makeminifs: Please insert floppy 1 - type any key to continue
             Writing floppy 1 100%
             Verifying floppy 1 53%
Floppy Disc Read Error
makeminifs: Please insert a new floppy 1 - type any key to continue
```

You should keep the minifs backup in a safe place. To be secure it is advisable to keep a second backup of the minifs since you will not be able to recover the system unless you have a working minifs backup.

- Back up the hard disk files

In order to back up the hard disk files you must ensure the following:

- (1) You are the only user on the system, and you are logged into the root account
- (2) You are not using the network and no distributed file systems from the network are mounted onto your machine

Then type the following to the shell prompt

```
# cd /
# /usr/etc/install/makefloppybu [-number]
```



---

This will read the contents of all the files on the disk and will create a backup of the entire file directory structure onto floppy disks. Files are stored in a compressed format. The `-number` option makes an estimate of the total number of disks required before continuing. This can take several minutes to determine.

**NOTE**

---

This utility makes a complete backup of the directory tree in your system starting at the top or root directory. The utility uses `compress` for each file and then uses `cpio -oc` to write the files to the floppy disk.

---

At the end of each disk you will be prompted to put a new disk in the drive. If the disk appears to be unformatted the disk will be automatically formatted. Remember to label each disk in sequence with its number as it completes.

After you have made the backup you can remove the minifs file from the main system. This will give over 2Mb of extra space available for user files and applications. To do this type:

```
# /usr/etc/install/makeminifs -d
Warning: you cannot now make another minifs backup.
        Do you want to continue (y/n)
y
#
```



---

After you have removed the minifs file you cannot recover it except by copying a backup back onto the system. You should ensure that you have two backups of the minifs before you remove it.

---

---

## RESTORING FROM FLOPPY

---

This section describes how to restore a backup created using the previously described backup facility. This procedure is also used to restore the optional Floppy Disk backup product available from your SPARCbook supplier.



---

Carrying out the Restore procedure removes all the existing data on the hard disk. You will not be able to recover any existing data after you have started the procedure.

---

- Load the minifs

First, you need to load the minifs file system onto the hard disk. This procedure is carried out from the startup sequence since your hard disk may be completely corrupted. To do this first turn the system On, or if the system is already On then use Reset.

Press the On switch

To turn the machine on

Press Ctrl-Alt-R

To reset the machine

Then press a key to stop the automatic startup sequence. The monitor menu will be displayed.

**NOTE**

```
1> Continue with Automatic System Startup
2> Boot Operating System or file           (Boot)
3> Standalone Restore                       (Restore hard disk)
4> Enter System Diagnostics                (Full Diagnostics)
```

Enter Choice>

To restore the Operating System select option 3. A new screen will prompt you to select the floppy disk or the Ethernet to restore from. Restoring from Ethernet is described below; for this procedure you should select to restore from floppy. The system will then prompt you to insert each of the two disks of the minifs into the floppy disk drive. It will tell you the proportion of each disk it has read as it progresses.

---

Once all three disks have been read the SPARCbook will start up the minifs Operating System subset. This contains just enough to install the rest of the Operating System onto the hard disk. The software will automatically perform the entire restore process, prompting you to insert each floppy disk in turn.

#### SPARCbook Standalone Restore

```
Select restore from floppy disk (1)
      restore from Ethernet      (2)
Choice> 1
```

!! WARNING !!

Continuing will destroy any existing hard disk data.Continue ? [Y/N]

Type Y to continue and then insert the backup floppy disks one at a time, and in the correct order, until the restore is completed. If there are errors on the restore you will not be able to continue. If repeating the operation does not fix the problem you will need to use an alternative backup.

<b>NOTE</b>
-------------

---

The SPARCbook restore facility will restore files onto the same partitions as when the backup was made. If you have changed the partition table it will give you the option of using the original partition table or the current one. Depending on the partition sizes it may only be possible to restore the backup to the original table. Refer to the 'Technical Reference' section for more information on disk partitions.

---

---

## ***BACKING UP OVER ETHERNET***

---

This section describes how to make a backup of the supplied Operating System over Ethernet to another system. It is assumed that you will be using a tape drive attached to a Sun Workstation as the backup system. However, other remote machines using TCP/IP networking with access to a backup media will work equally well. This procedure may be used at any time to create a complete back up of your disk.

To make a backup over the network you will first need to ensure that you can communicate with the machine that is going to do the backup. Refer to 'Configuring the Network' for further information. For backing up over a network this section assumes that you are connected on Ethernet to the remote machine and that you have set up the configuration so that you can perform commands on the remote machine.

To try this out execute the following command from the SPARCbook when logged in as root:

```
# rsh [system] uname -n
```

Replace [system] in the command with the name of the remote system you are intending to use. The remote system should print its name if the command has executed successfully.

In order to back up the hard disk files you must ensure the following:

- (1) You are the only user on the system, logged in as root
- (2) You are not using the network and no distributed file systems from the network are mounted onto your machine
- (3) You have installed a tape into the remote system tape drive and it is not write protected.

---

To make the backup type the following command:

```
# makenetbu system [device]
```

<code>system</code>	is the name of the remote system to back up to.
<code>device</code>	is optional. By default the system uses the device name <code>/dev/nrst8</code> on the remote system. You may specify an alternate device, but it must be a no-rewind device.

The `makenetbu` command assumes that the remote system is a Sun workstation running SunOS 4.1.x. If you use a different system for the backup you may need to specify the device name. The backup proceeds completely automatically, and reports progress as it proceeds. It first writes the `minifs` file to the backup device if it is available, and then uses the same procedure as the floppy disk backup system to compress and save all the disk files. To backup the distributed SPARCbook Operating System over the Ethernet to a SPARCstation IPC takes about 25 minutes.

**NOTE**

---

The compression algorithm used provides a typical 30% reduction in the overall space required to store the hard disk data. Thus on a 120Mb streamer tape drive you can store about 180Mb of disk files. On the largest SPARCbook configurations you may require a second tape depending on how full your disks are. If you do the system will prompt you when a second tape is required.

---

The `minifs` file takes up over 2Mb of space on the SPARCbook disk. It is not required for normal operations but is needed if you have to do a disk restore from the network. In making the Ethernet backup the `minifs` is automatically stored as the first file on the tape if it is available.

After you have made the backup you can remove the `minifs` file from the main system. This will give over 2Mb of extra space available for user files and applications. To do this type:

```
# makeminifs -d
Warning: you cannot now make another minifs backup.
        Do you want to continue (y/n)
Y
#
```



---

After you have removed the minifs file you cannot recover it. You should ensure that you have two backups of the minifs before you remove it.

---

If you perform a subsequent `makebu` operation the utility will report that there is no minifs file present and continue.

**NOTE**

---

You cannot restore a backup made without a minifs file unless you also have access to a backup made with the file. As an alternative to making a full backup, before you remove the minifs file (if you need the space), you can use the network remote copy (`rcp`) to save the minifs on a different machine. See 'Using the Network' for further information on `rcp`. To do this use the following command.

---

```
# rcp /stand/minifs system:filename
```

where `system` is the name of the remote system to store the file and `filename` is where to save it on that system.

---

## ***RESTORING FROM ETHERNET***

---

This section describes how to restore a backup created using the previously described backup facility.



---

Carrying out the Restore procedure removes all the existing data on the hard disk. You will not be able to recover any existing data after you have started the procedure.

---

- 
- Load the minifs

First, you need to load the minifs file system onto the hard disk. This procedure is carried out from the startup sequence since your hard disk may be completely corrupted. Before this can be done the minifs must first be loaded off the tape and onto a remote system file so that it is accessible to the SPARCbook monitor.

Load a backup tape with a minifs on into the tape drive on the remote system. On the remote system restore the minifs file to a location on the remote system. For example to restore it to the `/tmp` directory on a Sun workstation type the following on the Sun workstation:

```
# cd /tmp
# cpio -ivt </dev/nrst8
-r-r-r- 1 root   root   261848 Sep 9 17:01 1991, minifs
197 blocks
#
```

A similar line to the one shown will appear after a few minutes, showing that the minifs file has been read from the tape. The numbers and the date will be different.

<b>NOTE</b>
-------------

---

Note that the non-rewind tape device (`nrst8`) was used. The tape is now ready for the main disk data files restore operation and should not be moved until the restore operation is complete. However, if you are restoring a backup made on a different tape, without the minifs, you should now change the tapes to the backup you want to restore.

---

Next, return to the SPARCbook and turn the system On, or if the system is already On then use Reset.

Press the On switch  
Press `Ctrl-Alt-R`

To turn the machine on  
To reset the machine

---

Press a key to stop the automatic startup sequence. The monitor menu will be displayed.

- 1> Continue with Automatic System Startup
- 2> Boot Operating System or file *(Boot)*
- 3> Standalone Restore *(Restore hard disk)*
- 4> Enter System Diagnostics *(Full Diagnostics)*

Enter Choice>

To restore the Operating System select option 3. A new screen will prompt you to select the floppy disk or the Ethernet to restore from. Restoring from Floppy is described above; for this procedure you should select to restore from Ethernet. The system will then prompt for an Ethernet logical address (Internet address) and the file name on the remote machine. You should enter the requested information. If you are unsure about the Ethernet address of the remote machine you should refer to 'Configuring Ethernet' or consult the machine's owner or system administrator. For example, to restore the minifs file from the previous example, assuming the remote machine has an Ethernet address of 192.52.161.100 you would type the following:

```
Enter Network Address of machine where
minifs resides, in numerical format (eg 192.52.161.52).
The remote machine must be able to handle Trivial File
Transfer Protocol (TFTP) requests.
```

```
Server Network address (default 0.0.0.0) > 192.52.161.100
SPARCbook Network address (default 0.0.0.0) > 192.52.161.52
Enter File Name of minifs on remote machine> /tmp/minifs
```



---

**NOTE**

For the above step to succeed the remote system must have your address in its `/etc/hosts` file and must be configured to run the Trival File Transfer Protocol (tftp). Refer to 'Configuring the Network' for information on `/etc/hosts`. To start up tftp on a Sun workstation running SunOS 4.1 you may need to edit `/etc/inetd.conf` and remove the # comment symbol at the start of the `tftp` line. If the line has a `-s` argument you will need to remove that as well. If you make changes to this file you will need to send a signal to `inetd` to ask it to reinitialize as follows:

```
# ps -ax | grep inetd
# kill -HUP [inetd.pid]
```

[`inetd.pid`] should be replaced with the process ID number from the first command.

If you need further help on this consult the Sun workstation owner, or the Sun documentation for further information.

---

Once the minifs has been read over the network the SPARCbook will start up the minifs Operating System subset. This contains just enough to install the rest of the Operating System onto the hard disk. The software will ask for the remote machine name, and then to confirm the tape device name (to which you should just type the Enter key if you are using a Sun tape drive). It will then automatically perform the entire restore process. Further intervention is not required unless the backup uses more than one tape.

#### SPARCbook Standalone Restore

```
Select restore from floppy disk (1)
      restore from Ethernet      (2)
Choice> 2
```

```
Enter remote machine name ? []
Enter device or file name ? [/dev/rst8]
```

```
!! WARNING !!
Continuing will destroy any existing hard disk data.Continue ? [Y/N]
```

---

Type **Y** to continue and the restore operation will proceed. Once the restore operation is complete the SPARCbook will automatically reboot into the newly restored disk.

**NOTE**

---

The SPARCbook restore facility will restore files onto the same partitions as when the backup was made. If you have changed the partition table it will give you the option of using the original partition table or the current one. Depending on the partition sizes it may only be possible to restore the backup to the original table. Refer to the 'Technical Reference' section for more information on disk partitions.

---

---

This page deliberately left blank

---

# RUNNING SPARC APPLICATIONS

Using the industry standard SPARC processor and the SunOS 4.1.2 based Solaris 1.0.1 Operating Environment the SPARCbook provides access to over 2000 third party applications available for SPARC architecture products. However, not all SPARC applications will necessarily run on the SPARCbook. The main limitations are as follows:

Older SunView applications are not supported. SunView depends on Sun Microsystems specific graphics hardware which is not available within the SPARCbook product. Applications to run on the SPARCbook must either use X Window as their graphics system, or must be written for OpenWindows. The SPARCbook Operating System uses X Window Release 4 and OpenWindows Version 3, but you may run earlier X or OpenWindows applications directly on the SPARCbook. SunView applications are not supported.

- Applications that require the existence of Sun specific hardware, such as the audio facilities, attached Sbus hardware etc, or that make direct calls into undocumented device driver interfaces in the Sun kernel, will not run on the SPARCbook.
- Applications that use Sun or other vendor specific hardware (such as IDPROMs) for licensing may not run on SPARCbook.

---

In general all third party X or OpenWindows applications written for Sun-4 and compatible workstations will run on the SPARCbook provided they do not conflict with the above requirements. In particular applications that meet the SPARC Compliance Definition (SCD) will run on SPARCbook. Common third party applications that have been tested on SPARCbook include Framemaker (Frame Technology Corp), Lotus 1-2-3 (Lotus Corp), Wingz (Informix Corp), WordPerfect (WordPerfect Corp), Write Draw & Paint (Island Graphics) and 20-20 (Access).

---

## ***INSTALLING SUNOS 4.1 APPLICATIONS***

---

Installing SunOS 4.1 applications can require minor modifications to the steps laid out in the application manual depending on the hardware configurations the installation process requires. All the Sun utilities for installing and running applications are available on the SPARCbook. You can install applications using one of the following methods:

Method	Requirements
1. Installation via local floppy	SPARCbook configuration with a Floppy, application on Floppy media
2. Installation via remote floppy	SPARCbook configuration with no floppy, access to a remote Sun or SPARCbook system with a floppy, application on Floppy media
3. Installation via local CD or tape	SPARCbook with optional Parallel/SCSI converter, attached local SCSI drive, application on CD or Tape media.
4. Installation via remote CD or tape	SPARCbook with network access to a remote Sun or SPARCbook configuration with attached CD or Tape drive, application on CD or Tape media.

---

Method 1 and 3 are usually catered for in the application standard installation procedure and you should refer to the application installation documentation for further information. Methods 2 and 4 may or may not be covered in the application documentation. To install an application from a remote system you will normally need to carry out the first stages of installation on the remote machine. Wherever possible follow the application documentation. If this does not cover remote installation try the procedures outlined in the next section.

---

## ***INSTALLING APPLICATIONS USING A REMOTE MACHINE***

---

Most applications perform installation in two stages. The first involves loading the application files off the shipping media (floppy, tape or CD) and onto a directory on the local machine. The second is to initialize the files, license the application, if necessary, and start up the application.

In this situation you can normally use the networking facilities to copy the application files over the network and into the SPARCbook system before continuing the installation process on the SPARCbook. For example, assume that you have loaded the application files into a remote machine called `mars` in a directory called `/opt/app`. In order to maintain file ownerships and layout it is best to use the `tar` command to package the application while transferring it. On the local SPARCbook create a directory for the application (for example the directory name `/opt/new`) and remote copy across the network using the `tar` command onto the SPARCbook as follows:

```
# mkdir -p /opt/new           make the directory
# cd /opt/new                 change directory
# rsh mars "cd /opt/app; tar cf - ." | tar xvf -
```

This last command causes the application files to be archived into a file which is then 'piped' between the remote machine and the local SPARCbook to be un-archived in the local directory.

<b>NOTE</b>
-------------

---

This assumes that networking is fully operational between the two systems. Refer to *Configuring the Network* for further information on setting up networks.

---

---

The application files are now installed on the local SPARCbook machine, and you should be able to continue the installation process on the SPARCbook. After you have completed the installation you should remove the files on the remote machine. In the example given the command `rm -rf /opt/app` would be carried out on the machine `mars`.

**NOTE**

This method may not be possible, or may not work, with all applications. If you experience difficulties in installing applications you should contact your application vendor or SPARCbook Technical Support.



On smaller SPARCbook configurations, running large applications may cause system resource limitations to restrict the application operation, or in some case prevent it starting up at all. Refer to 'Memory Usage and Swap Space' for further information on how to overcome such problems.

---

## ***SUN-OS GRAPHICS INTERFACES***

---

SunOS applications are, in general, designed to run on a standard Sun Microsystems hardware configuration. While the software should make calls to standard system interfaces and libraries in order to conform with the industry standards there are some difficulties in the area of graphics. Many applications assume the presence of a high resolution screen which may vary from the Sun Monochrome 1152 x 900 configuration to colour 1280 x 1024 frame buffers. In general a higher resolution does not pose a problem, but a lower resolution can result in not all of the information the application developer intended being completely visible on the screen at one time.

SunOS applications for X or OpenWindows will run unmodified on the SPARCbook which uses a 640 x 480 resolution display. The X11 and OpenWindows protocols ensure that applications will normally use windows that are only as large as the display itself. However, while portable applications, and those conformant with the SPARC Compliance Definition, should run and present no problems, certain applications may have difficulties with the small format screen. In order to address this several system software interfaces are built into the SPARCbook version of the Solaris 1.0.1 Operating System.

---

## ***VIRTUAL SCREEN***

---

By default the SPARCbook Operating System uses a Virtual Window Manager for the 640 x 480 screen. The Virtual Window Manager allows you to display a 640 x 480 window into a virtual screen which may be as large as you like. For example the default configuration gives a virtual screen of 1920 x 960 pixels. Facilities are provided to pan the window over the entire virtual screen, or to move application windows into the viewing window. For further information refer to the OpenWindows section describing the Virtual Window Manager facilities.

---

## ***CONFIGURING THE APPLICATION FOR A SMALL SCREEN***

---

Since most applications are designed to run on high resolution screens the standard font sizes used look large on the smaller SPARCbook display. This, in turn, makes the applications windows large, often exceeding the size of a single panel of the Virtual Window Manager. Most applications include facilities to change the size of fonts used on the display. This allows you to configure the application to the SPARCbook display.

The standard fonts provided with the SPARCbook include the families Lucida, Courier, Times, Helvetica and Palatino. Many others are available on the full CD version of the Operating System. Each font is available in different sizes (and for the NeWS PostScript server can be used as completely scaleable fonts). Typically applications will use 12 or 14 point text size for text, window buttons, menus and so on.

On the SPARCbook the OpenWindows applications and standard X Window application interfaces are set up for operation on a small screen using 10 point font sizes. This is achieved by setting the system wide `xdefaults` file in `/usr/lib/openwin`, and by configuring the DeskSet tools to start up in 'small' mode in the `openwin-menu` files. You should not alter these unless you fully understand these files.



---

**NOTE**

For a full discussion of Fonts, Xdefaults, and facilities for changing the system configuration you will need to refer to the optional complete documentation product for the SPARCbook. As shipped the standard Operating System has been pre-configured to be optimal on the SPARCbook screen.

---

All applications that run under X and OpenWindows use a set of *resources*. Many of these resources can be changed to tailor the application to your requirements.

To run on the SPARCbook you may want to reduce the application font size from its default to 10 point. To do this you will need to refer to the application documentation, but typically the application will use a file from the directory `/usr/openwin/lib/app-defaults`, or `/usr/lib/x11/app-defaults`. Often you can copy such a file into your own home directory and modify your own copy. Then, whenever you start up the application, it will consult the resource file in your home directory and initialize itself accordingly.

Some applications have easy ways to configure for different screen or font sizes. For others you may have to modify the resource files yourself.



---

You should only attempt the following procedures if you are prepared to experiment in application configuration. The following examples will not work for all applications and you should always refer to the application documentation before attempting any reconfiguration.

---

Look for lines similar to the following in resource files if they exist:

```
app*font: -adobe-courier-medium-r-normal--14-140-75-75-m-90-iso8859-1
```

This is defining a font specification for the application. Font names can at first sight be intimidating and it is not obvious how to change them. The specification includes information fields with the Foundry, font family, point size, pixel sizes, and so on. A program called `xfontsel` allows you to look at fonts and select different fonts for your application. As an example start up `xfontsel` from a command tool as follows:

```
% xfontsel &
```

After a short time a window will appear with a row of menu options along the top. To look at the example font move the pointer to the `Fndry` box and press the Menu key. Move the pointer down to the `adobe` selection and release the pointer. The names that are not in bold are not available on the bundled SPARCbook operating system. Repeat this for each field until the message at the top right indicates that only 1 font matches. The window should now show the selected font and its name.



This font is the equivalent of the full font name given above since wild cards are allowed using the `*` symbol in a font specification, provided only one font matches. Now using the pointer and menu key on the `pxlsz` option change the pixel size from 14 point to 10 point. The font is shown and can therefore be used by an application. You can therefore change the initial 14 point definition to a

---

10 point font by changing the resource file line to either of the two equivalents below. You can see the full name by selecting each of the wild card fields and seeing the value of the selected font.

```
-adobe-courier-medium-r-normal--10-*-*-*-*-*-*  
-adobe-courier-medium-r-normal--10-100-75-75-m-60-iso8859-1
```



---

Before you change any resource files be sure to make a copy in case you need to revert to the original file.

---

**NOTE**

---

The information in this section provides only guidelines on configuring applications to your requirements, and does not necessarily apply to all applications. You must refer to the application documentation for detailed procedures on configuration to meet your requirements.

---

---

## ***MONOCHROME AND COLOR APPLICATIONS***

---

The SPARCbook uses a 4 bit deep frame buffer which allows the simultaneous display of up to 16 colors chosen from a palette of 4096. Many applications will assume the presence of a Sun monochrome frame buffer or a color 8 bit frame buffer capable of displaying 256 colors. Portable applications should be able to run within the 16 color limitation. However, if the application has not been written for portability it may not run or may exit when it requires more than 16 colors. Other applications may automatically revert to a monochrome mode if the number of colors required are more than the available set.

If this occurs you can sometimes specify fewer colors to the application and it will then run. Typically over 8 colors are available to user applications, in addition to the standard ones the basic OpenWindows interface use. To see the settings for the current available colors, and to change them you can run the OpenWindows `colorchooser` program. When applications start up they may change the color map to meet their own requirements.

---

You should refer to the application documentation to see if there are any facilities to restrict the number of colors used. For example they may have a Properties facility as in the OpenWindows workspace menu (See *Configuring Your DeskSet Environment*). In the same way as altering default font sizes described in the previous section, X and OpenWindows based applications use resource files to describe default colors.

Look for lines similar to the following in resource files if they exist:

```
app*text.color: green
```

If a large number of colors are defined in the resource file you may be able to change some of them to reduce the overall number of colors required. You should be prepared to experiment to configure the application to your requirements if you do not like the way it starts up.

As a last resort you may need to run the application in a monochrome mode by specifying that the system is running on a monochrome screen. The SPARCbook OpenWindows server has a special mode to allow the running of applications in a monochrome mode, simulating a 1280 x 960 pixel display. This is described in the next section.

---

## ***HIGH RESOLUTION MONOCHROME MODE***

---

The high resolution monochrome mode configures the SPARCbook X11/NeWS server to be a monochrome display device to applications. All applications will run in monochrome in this mode. The SPARCbook emulates a 1280 x 960 pixel display by using a *dithering* technique. Each four pixel square of the emulated screen (the *virtual* screen) is mapped to a single gray scale pixel on the display. Using gray scales the pixel intensity is varied according to how many pixels are 'on' in the corresponding 4 pixels on the virtual screen. Using this method the entire information on a 1280 x 960 display is mapped onto the SPARCbook screen.

---

Applications behave as if they are running on a large screen. By default all fonts and windows will appear to be extremely small, since the SPARCbook is specifically configured to operate OpenWindows in a 'small' mode for the embedded screen. To operate in the monochrome mode you may prefer to change some of the default font and application sizes by copying the files from the directory `/usr/openwin/lib/monochrome` into your home directory. The following files are available:

<code>.Xdefaults</code>	Changes the X Window environment to use 14 point Fonts by default.
<code>.openwin-menu</code>	Uses 'large' versions of the DeskSet tools. The default is to use the 'small' version.
<code>.openwin-menu-programs</code>	As for <code>.openwin-menu</code>

Be careful to first save these files if you already have your own versions in your home directory. If you want to use these files you should copy them into your home directory using the File Manager or UNIX tools.

To enter the high resolution monochrome mode you will first need to exit from OpenWindows in order to restart the server. Then, from the UNIX shell prompt start up OpenWindows using the following command:

```
/usr/openwin/bin/openwin -mono
```

You may now use the system exactly as if you were running on a 1280 x 960 pixel resolution monochrome screen. Because of the dithering process fine detail on the screen will be difficult to use. Two special key sequences allow you to zoom in and out of an area. The zoom operation changes the display to show a 640 x 480 monochrome image corresponding one to one with a 640 x 480 area of the virtual screen. To enter this mode move the pointer to the top left hand corner of the area you wish to zoom in on and press the Alt-PgUp key sequence. To zoom back out use the Alt-PgDn Sequence.

---

<b>NOTE</b>
-------------

Because of the dithering algorithms used, applications which are graphics operation intensive will run relatively slowly in the high resolution monochrome

---

---

# CUSTOMIZING THE SPARCBOOK OPERATING SYSTEM

SPARCbook is provided with a bundled run time version of the Solaris 1.0. operating system that occupies about 50M bytes of disk space. With every SPARCbook is shipped the entire Solaris 1.0 operating system on a CD-ROM. This section covers the following main topics:

- The bundled SPARCbook Operating System
- The differences between the SPARCbook version of Solaris 1.0.1 and that provided for a Sun workstation or 'clone'
- How to change the bundled Operating System Configuration
- Using the CD files mounted on a server

**NOTE**

---

The reconfiguration of the SPARCbook Operating System requires access to a CD-ROM player attached either locally using the optional parallel to SCSI convertor, or to a remote Sun workstation or server. In the later case the remote Sun and the SPARCbook must be connected over Ethernet. Please refer to 'Configuring the Network' as a prerequisite to carrying out the operations described in this section if you are using a remote system and you do not have networking operational.

---

---

## ***CLUSTERS***

---

The Solaris 1.0.1 Operating System (SunOS 4.1.2) is packaged as a set of modules, otherwise known as *clusters* or *packages*. Each cluster consists of a set of files applicable to a particular application.

**NOTE**

The Solaris 1.0.1 packages are not the same as the Solaris 2.0 UNIX System V Release 4 packages. Hence for the rest of this section the term cluster will be used rather than package to avoid confusion.

The SPARCbook Solaris CD contains a complete implementation of the Solaris 1.0.1 product from SunSoft Inc, with the exclusion of the SunView clusters which are not supported on the SPARCbook product, and the OpenWindows Version 2 clusters which are replaced with the OpenWindows Version 3 product. In addition the CD contains a complete configuration system, comprising over 150M bytes that can be mounted from a SPARCbook as a server directory to access any required facilities. Note that many functions can only be carried out by installing clusters onto your local system (for example using the RFS networking option). However, using the complete tree installed on the CD you can access read-only data such as additional fonts, OpenWindows demonstrations, on line manual pages and so on. Some examples on using this facility are provided later.

This section describes the differences between the SPARCbook Solaris CD and that provided for a Sun Workstation and explains how to load optional clusters onto your system.

---

## ***THE SPARCBOOK BUNDLED OPERATING SYSTEM***

---

As shipped the SPARCbook bundled OS, including the SoftPC package, occupies 53M bytes of disk space, excluding the disk space allocated for the swap area, and the `minifs` files which will normally be removed after having been backed up. On the minimum configuration of an 82M byte disk this leaves 8M bytes of space for user files and up to 16M bytes of combined temporary file system (`/tmp`) and swap space. Facilities are provided to increase the available user space by removing the Programming tools which provides approximately a further 10M bytes of user space.

<b>NOTE</b>
-------------

Disk manufacturers use the term megabyte to refer to 1,000,000 bytes, rather than the Operating System view of a megabyte which is 1,048,576 bytes. As an example the smallest SPARCbook configuration has a disk over 86 'disk' megabytes, corresponding to 82 'operating system' megabytes. This can lead to considerable confusion. In this Guide all figures are given in Operating System M bytes.

The bundled operating system contains the following Solaris 1.0.1 clusters. These have been modified as described below for the SPARCbook implementation.

Cluster	Size (M)	Description
root	2	Sun root file system
usr	14	Core required system files
Install	1	System configuration and installation files
Networking	1	Networking interface (NFS)
Kvm	2	Kernel architecture dependant files
Text	1	Text-processing software
uucp	1	Communications software
OWV3min	25	OWV3 run time package
SoftPC	6	SoftPC files



---

The following main changes have been made from the SunSoft Solaris 1.0.1 files.

- The `kvm` tree has been changed. The device directory has been reduced in size, and SPARCbook devices added. No standalone facilities are available, except those provided by the minifs system.
- Solaris 1.0.1 from Sun provides SunView and OpenWindows Version 2. No SunView support is provided for SPARCbook, and the windowing system is the more recent OpenWindows Version 3. The SPARCbook implementation corresponds to the minimal implementation of OWV3 with the removal of the AvantGarde font family and the addition of SPARCbook specific tools.
- The `terminfo` directory has been removed, except for the minimum number of terminals required to support the SPARCbook.

---

## ***CHANGING THE BUNDLED SYSTEM CONFIGURATION***

---

There are two ways that the bundled Operating System can be changed. The first is to remove some of the existing software in the bundled Operating System. This can be carried out with a standalone SPARCbook system. You will not be able to put the software back unless you have access to the CD version of the Operating System. The second way is to add clusters to an existing SPARCbook system. The next sections describes both facilities.

---

## ***REMOVING PROGRAMMING SOFTWARE***

---

As delivered the SPARCbook version of Solaris 1.0.1 includes the Sun C Compiler, programming tools, archive libraries and include files. If you intend to use your SPARCbook for end user applications only, and do not intend to compile any software you can create an additional 10M bytes of disk space by removing the programming tools. To do this log in to the system as root and do the following:

---

```
# /usr/etc/install/remove_programmer
```

A warning message will be printed and the software will be removed if you confirm that you wish to proceed.

You may also remove the SoftPC package to create an extra 6M bytes of disk space as follows:

```
# /usr/etc/install/remove_SoftPC
```



---

The software cannot be reinstalled once removed except using the `add_clusters` facility below.

---

**NOTE**

---

You can see a list of files that will be removed by the facilities described in this section by looking at the files in `/usr/etc/install/clusters`. You should also remove the minifs if you backed it up, or have access to CD facilities. This will save a further 2M bytes of disk space. See 'Backup and Restore' for further information.

---

---

## ADDING CLUSTERS

---

To add clusters you need to have access to a CD-ROM system. You can do this is one of two ways:

- A locally attached CDROM system, via the optional SPARCbook parallel to SCSI converter.
- A remotely attached CDROM system connected to a remote Sun-4 workstation or server, or locally attached to a remote SPARCbook.

**NOTE**

---

Documentation on the facilities available in these clusters is not provided in this User Guide. Full reference documentation is available in the optional complete SPARCbook Solaris 1.0.1 documentation package.

---

---

The following clusters are available:

Cluster	Size (M)	Description
debugging	1	Profiling libraries for debugging programs
games	3	Traditional UNIX games
manual	8	On-line Manual pages
misc	5	Standard missing files such as terminfo, some include files etc.
owuser	17	Additional OWV3 fonts, and MIT utilities, manual pages and on-line handbooks.
owdemo	8	Additional OWV3 demos and images
owprog	22	OWV3 Programmers environment; this requires owfonts as a prerequisite.
prog	10	The programmer's files removed if you remove the programming software from the bundled Operating System
rfs	1	RFS networking package
security	1	C2-Level security software
shlib_custom	2	Software for building shared libraries
sys	3	Kernel building software
system_v	4	Additional System V and X/Open compatibility software
tli	1	Transport Layer Interface (TLI)
versatec	6	Spooling software for Versatec V-80 printers

To add a cluster you must first have access to the CD-ROM directory. On a local CD-ROM (attached via the optional parallel to SCSI converter) you can get access to the CD-ROM using the following commands (as the super-user):

---

```
# cd /
# mkdir /cdrom
# mount -r /dev/sr0 /cdrom
#
```

You will only need to make the directory if it does not already exist.

You can now access the CD-ROM files in the `/cdrom` directory. If you are using a remote CD-ROM facility you will need to export the remote file system and mount it into your file system. Refer to 'Setting up a Distributed File System' for further information. As an example, to mount the directory from a remote SPARCbook called `venus` which had a CD-ROM mounted as just described you would type:

```
# cd /
# mkdir /cdrom
# mount venus:/cdrom /cdrom
#
```

The `add_clusters` program is primarily intended for adding software. You may also use it to delete previously added clusters. To start up the program type

```
# /usr/etc/install/add_clusters [directoryname]
```

The directory name is option (do not include the brackets if you use it) and is used to specify an alternative directory for the top of the CD-ROM tree. The default is to use the directory `/cdrom`.

A menu of the available clusters will now be given. A message will then be printed:

```
> Select Cluster:
```

---

You should type the number of the cluster you want to install or remove.

> Select Directory [usr]:

By default all additional software is loaded into /usr. If you just type Enter the system will load the cluster into /usr. However, if you do not have sufficient space you may wish to install the package somewhere else. You may specify an alternative directory by typing the directory name to this prompt.



---

The `misc`, `rfs`, `security`, `system_v` and `tli` packages *must* be installed into /usr to operate correctly.

---

The following menu will then be printed:

1. Install Cluster
2. Remove Cluster
3. List Cluster

Enter Choice>

- Install Cluster will then install the selected cluster onto the SPARCbook.
- Remove Cluster will remove the contents of the cluster from the SPARCbook.
- List Cluster will list the contents of the cluster but will not install it.

After the operation has completed the menu of clusters will be printed again. You may either carry out another operation or type 'q' to exit the `add_clusters` program.

**NOTE**

---

Clusters are stored on the CD-ROM as tar files. In addition a complete tree is available on the CD-ROM allowing you to choose the files of your choice. See the next section for further information.

---

---

## ***MOUNTING THE CD ON A SERVER SYSTEM***

---

Many of the facilities available on the complete Operating System CD are not required for all users, or are only occasionally needed. For example access to the OpenWindows demos and images, and the on-line manual pages might be required only rarely. Using the SPARCbook Solaris CD you can mount the CD on a server machine and allow access to various directories using NFS.

For example to allow the manuals to be read by any system on the network a server machine would need to be attached to a CDROM system. The server could be a Sun Workstation with an attached CDROM or a SPARCbook with a local CDROM attached via the optional parallel to SCSI convertor. You would do the following on the server machine:

```
# mkdir /cdrom                If it doesn't already exist
# mount -r /dev/sr0 /cdrom    Mount the CD
```

Next follow the instructions in 'Using Shared Directories' to share or export the /cdrom directory.

On the local SPARCbook a user would do the following to allow access to the on-line manual pages:

```
# mount -r servername:/cdrom/OS/usr/man /usr/man
```

`servername` is the hostname of the remote server. This will mount the CD manual directory onto the local /usr/man directory. Now all users on the local machine should be able to look up manual pages by using the `man` command. For example the following command from a `cmdtool` prompt will print the manual page for the `mkdir` command:

```
% man mkdir
```

Similarly other directories in the complete distribution tree loaded into the OS directory on the CD can be mounted for local SPARCbook use.

---

## TECHNICAL REFERENCE AND FURTHER READING

This section provides more detailed technical information on the SPARCbook product including specifications and hardware interface descriptions. More in-depth information on the Operating System devices and drivers is also provided, with an explanation of the disk drive layout and information on how to change the default partition mappings.

For further information on the SPARCbook hardware and software interfaces you should refer to the Technical Reference Manual which is available as a separate product from your SPARCbook supplier.

At the end of this section there is a brief summary of the available reference documentation for the SPARCbook Operating System, also available from your SPARCbook supplier.

---

## ***SPECIFICATIONS***

---

SPARCbook is a notebook computer based on the SPARC RISC processor developed by SUN Microsystems Inc. The specifications for the SPARCbook 1 computer are detailed below:

### **• Processor and Memory**

Processor	25MHz CY601 Integer Unit
Cache Controller/MMU	25MHz CY604 CMU
Cache	64KB direct mapped virtual cache
FPU	25MHz CY602 Floating Point Unit
DRAM (Standard)	8MB with byte parity
DRAM (-E models)	32MB with byte parity

### **• I/O Interfaces**

Ethernet	IEEE802.3 Compliant 15 pin D Type AUI Interface with SlideLock
Centronics	IBM PS/2 Compatible Interface 36 pin miniature D Type with cable to 25 pin D socket
Mouse/Keyboard	IBM PS/2 Interface (TTL), 6 pin mini-DIN
Modem	2400 baud data and 9600 baud SendFax FCC Part 68 Compliant, 0.3 REN V.29, V.27ter, V.22Bis, V.22, V.21 Bell 212A, Bell 103 standards, RJ11 Jack Socket
VGA	640x480 25.057MHz dot clock 800x600 36.242MHz dot clock (External monitor) 15 Way PS/2 compatible D Type connector
Serial	110 to 38400 baud, 9 pin mini-DIN



---

**• Peripherals**

Winchester Disk      85MB Formatted IDE Interface/125MB Formatted IDE Interface  
One or Two drives per system  
Maximum transfer rate 8M byte/sec buffer to memory  
Maximum sustained transfer rate 1.8Mbyte/sec

Floppy Disk      720KB/1.44MB Formatted 3.5" Floppy disk drive  
Fitted with Single Winchester drive models

**• Display**

Monochrome      640x480 VGA paper-white display side-lit displaying 16 gray  
scales from 64

Color (-C models)      640x480 VGA color STN display side-lit displaying 16 colours  
from 256

**• Keyboard**

82 Key notebook style keyboard with integral Mousekey based  
on Force Sensitive Resistor (FSR) technology.

**• LED**

External DC supply connected  
Disk active  
User controlled indicator  
Battery Low/Exhausted indicator

**• Case and Emissions**

Magnesium Alloy AZ91 Castings  
SPARCbook is certified to FCC Part 15 Class B

**• Power Supply**

Internal      Switched mode PSU with battery charge and charge detection  
facilities.

External      Univeral Input 110V-240VAC Output 18V 0-3.1A DC

---

• **Physical**

Dimensions	11.8" x 8.5" x 1.95"
Weight with/without battery	6.8lb/5.2lb (monochrome versions) 7.0lb/5.4lb (color versions)

• **Environmental**

Temperature (Operational)	5 - 40 degrees Celsius
Temperature (Storage)	-20 - 60 degrees Celsius
Vibration (Operational)	5-100Hz 0.25g
Vibration (Storage)	5-100Hz 1.2g
Shock (Operating)	3G
Shock (Storage)	50G
Humidity (Operating)	8-80% RH

• **Operating System**

SunSoft Solaris 1.0.1	SPARCbook Version A
comprising	SunOS 4.1.2 Sun4m architecture
	OpenWindows V3, SPARCbook utilities
	Meets SPARC Compliance Definition (SCD) 1.1

---

## CONNECTOR REFERENCE

---

This section provides interface information for all the connectors on the SPARCbook computer.

### • DC Power Supply

Connector Type: 2 pin 1.2mm Jack Plug

Connections:

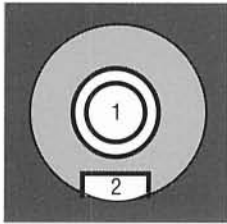

Pin 1	+18V
Pin 2	0V

### • Ethernet Interface

Connector Type: 15 way D Type (Female) with Slide-Lock

Connections:

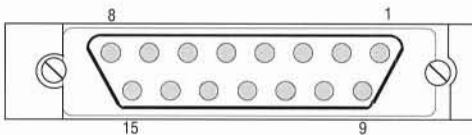

Pin 1	0V	Pin 9	Collision-
Pin 2	Collision+	Pin 10	Transmit-
Pin 3	Transmit+	Pin 11	0V
Pin 4	0V	Pin 12	Receive-
Pin 5	Receive+	Pin 13	Fused +12V
Pin 6	0V	Pin 14	0V
Pin 7	NC	Pin 15	NC
Pin 8	0V		

The 12V for external transceiver power is fused through a thermally resetting Fuse with a trip current of 600mA. If this current is exceeded the fuse will automatically recover after about 30 seconds.

• **Keyboard/Mouse Interface**

Connector Type: 6 pin mini-DIN (Female)

Connections:

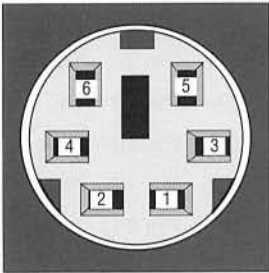

- Pin 1 Data
- Pin 2 NC
- Pin 3 0V
- Pin 4 5V
- Pin 5 Clock
- Pin 6 NC

• **Serial Interface**

Connector Type: 8 Pin mini-DIN (Female)

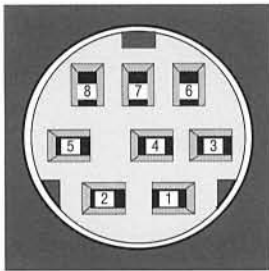

- Pin 1 DTR
- Pin 2 CTS
- Pin 3 Transmit
- Pin 4 0V
- Pin 5 Receive
- Pin 6 RTS
- Pin 7 DCD
- Pin 8 NC

• **VGA Graphics Interface**

Connector Type: 15 Way D Type (Female)

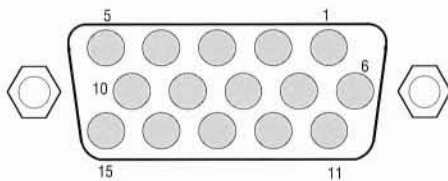

- |             |           |           |
|-------------|-----------|-----------|
| Pin 1 Red   | Pin 6 0V  | Pin 11 NC |
| Pin 2 Green | Pin 7 0V  | Pin 12 NC |
| Pin 3 Blue  | Pin 8 0V  | Pin 13 HS |
| Pin 4 NC    | Pin 9 NC  | Pin 14 VS |
| Pin 5 NC    | Pin 10 0V | Pin 15 NC |

• **Centronics Interface**

Connector Type (Back Panel)

36 Way Miniature D (Male)

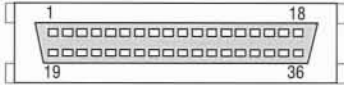

Pin 1	Strobe	Pin 2	Autof	Pin 19	0V	Pin 20	Data6
Pin 3	Data0	Pin 4	Perror	Pin 21	0V	Pin 22	Data 7
Pin 5	Data1	Pin 6	Init	Pin 23	0V	Pin 24	Ack
Pin 7	Data2	Pin 8	Slotin	Pin 25	0V	Pin 26	Busy
Pin 9	Data3	Pin 10	0V	Pin 27	0V	Pin 28	PE
Pin 11	Data4	Pin 12	0V	Pin 29	0V	Pin 30	Slot
Pin 13	Data5	Pin 14	NC	Pin 31	NC	Pin 32	NC
Pin 15	NC	Pin 16	NC	Pin 33	NC	Pin 34	NC
Pin 17	NC	Pin 18	+5V	Pin 35	NC	Pin 36	+5V

Connector Type (Cable) 25 Way D Type (Female)

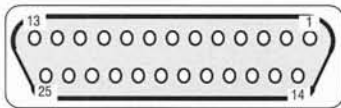

Pin 1	Strobe	Pin 14	Auto
Pin 2	Data 0	Pin 15	Error
Pin 3	Data 1	Pin 16	INIT
Pin 4	Data 2	Pin 17	SLCTIN
Pin 5	Data 3	Pin 18	0V
Pin 6	Data 4	Pin 19	0V
Pin 7	Data 5	Pin 20	0V
Pin 8	Data 6	Pin 21	0V
Pin 9	Data 7	Pin 22	0V
Pin 10	ACK	Pin 23	0V
Pin 11	Busy	Pin 24	0V
Pin 12	PE	Pin 25	0V
Pin 13	SLCT		

---

• **Phone Line Interface**

Connector Type: RJ11

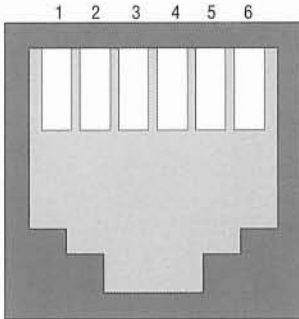

- Pin 1 NC
- Pin 2 NC
- Pin 3 LINE
- Pin 4 LINE
- Pin 5 NC
- Pin 6 NC

---

***STANDARD CABLES***

---

This section gives details of standard cables for serial and parallel interface applications. Since the cable interfaces on the SPARCbook use industry standard connectors you can easily source cables from third parties for connection to peripherals. The parallel connector at the end of the supplied cable conforms to IBM standards, and the serial connector is compatible with the connector used on Sun IPC style workstations. The cable diagrams here are for reference use.

**NOTE**

Connections between the SPARCbook and any connected peripherals must be made using shielded cables to maintain compliance with FCC radio frequency emission limits. You should only use shielded cables for connections to the SPARCbook. Refer to Page 1 of this User Guide if interference is suspected.



If you are specifying cables always refer to the peripheral handbook to verify the pin connections on the peripheral equipment you are using. Failure to observe this warning could result in damage to the peripheral and/or SPARCbook.

- Serial Cable with Handshaking to typical 25 pin D Type interface. This is for a typical piece of Data Terminal Equipment such as an ASCII terminal.

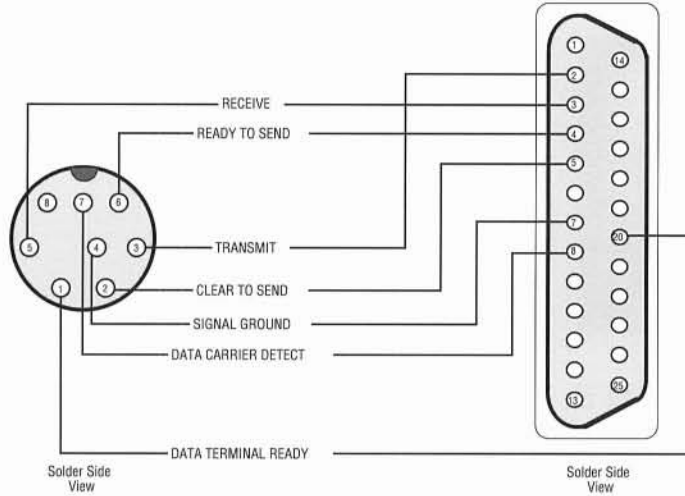

8 Pin mini-DIN to 25 pin D Type (Male) DTE

- Parallel Cable with Printer Strobes to Centronics 34 pin Connector.

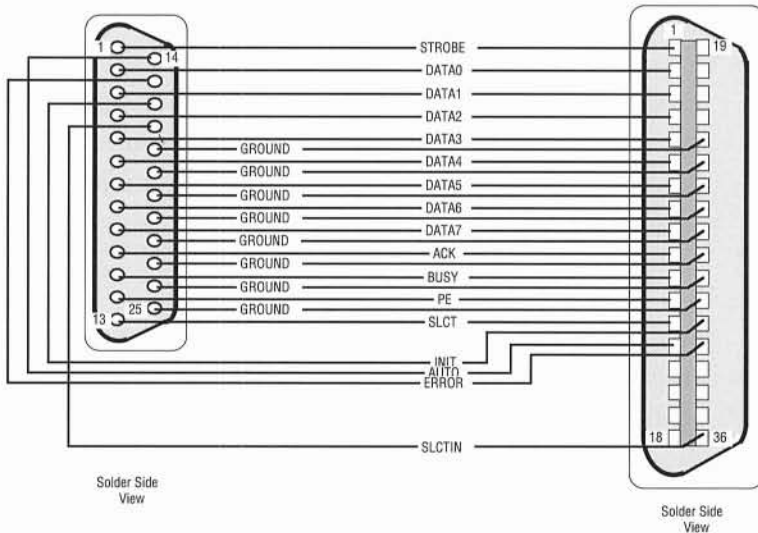

25 pin D Type (Male) to Centronics Style Plug

---

## DEVICE DRIVER INTERFACE AND UTILITIES

---

The SPARCbook I/O devices are accessed from the Solaris 1.0.1 Operating System by file operations on files in the `/dev` directory. The following table shows the corresponding device entry for each of the hardware devices used in the SPARCbook notebook computer. Note that not all devices are present in the standard configuration. For example, the SCSI devices are only available with the optional parallel to SCSI converter product. However, where possible the same device entry names and numbers are used as for a standard sun4m architecture hardware product.

**NOTE**

For further detailed programming information on the SPARCbook I/O devices and peripherals please refer to the SPARCbook Technical Reference manual available as a separate product from your SPARCbook supplier.

Device Name [ <code>/dev/</code> ]	Description
<code>extms</code>	External mouse
<code>fd0</code>	Floppy Disk 3.5"
<code>modem</code>	Internal Modem Interface
<code>parallel</code>	Centronics Parallel interface
<code>nrst8</code>	No rewind SCSI streamer tape device
<code>rsd[0-7][a-h]</code>	SCSI Disk Raw device interfaces
<code>rst8</code>	SCSI streamer tape device
<code>rid[0-1][a-h]</code>	IDE Raw device interfaces
<code>sd[0-7][a-h]</code>	SCSI Disk block device interfaces
<code>sr0</code>	SCSI CDROM
<code>id0a</code>	IDE Disk 0 Partition 0 (Root File System)
<code>id0b</code>	IDE Disk 0 Partition 1 (Swap space)
<code>id0c</code>	IDE Disk 0 Partition 2 (Whole disk)
<code>id0d</code>	IDE Disk 0 Partition 3 (Save/Resume)
<code>id0e</code>	IDE Disk 0 Partition 4 (Not used)
<code>..</code>	<code>..</code>
<code>id0h</code>	IDE Disk 0 Partition 7
<code>id1a</code>	IDE Disk 1 Partition 0
<code>..</code>	<code>..</code>
<code>id1h</code>	IDE Disk 1 Partition 7
<code>serial</code>	RS232 Serial Interface
<code>ttya</code>	RS232 Serial Interface
<code>uc</code>	Internal Microcontroller Interface
<code>vga</code>	VGA Frame Buffer device



---

## DISK LAYOUT AND FILE SYSTEMS

---

The hard disk drive used in the SPARCbook system is divided into areas or *partitions* for Operating System use. The size of the partitions is set up automatically as part of the factory system configuration. However, it is possible to reconfigure the partitions to meet specific requirements. This section describes the default partitioning of the hard disk(s) and explains how to change the partition specifications.

<b>NOTE</b>
-------------

Internal Disks are sized in logical *cylinders* . A logical cylinder comprises 4 logical heads and 16 logical sectors per track. A logical sector is 512 bytes of data. All partitions are sized in logical cylinders, corresponding to 32K bytes of data per cylinder.

### • Configuration 1 Single Disk models

By default single disk models have the layout shown in the table below:

Partition	Position	Size (Cylinders)	Device	Description
System	0	1	-	Partition tables
Swap	1	512	id0b	Swap space
Root	513	Remaining	id0a	Root partition
Whole	0	Whole Disk	id0c	Whole Disk
Resume	end-256	256	id0d	Resume Partition (8Mb)
Resume	end-1024	1024	id0d	Resume Partition (32Mb)

This leaves the following space for the Root file system on SPARCbook models:

S1-85	1863 Cylinders	58.3M bytes
S1-120	3094 Cylinders	96.7M bytes
S1-120E	2326 Cylinders	72.7M bytes

In practice the root file system will have a usable space of less than this amount. The file system is tuned during installation with a minimum free space of 1%, and is optimized for space.

• **Configuration 2 Dual Disk Models**

By default dual disk models have the layout shown in the table below:

Disk 0 Partition	Position	Size (Cylinders)	Device	Description
System	0	1	-	Partition tables
Swap	1	512	id0b	Swap space
Root	513	Remaining	id0a	Root partition
Whole	0	Whole Disk	id0c	Whole Disk

This leaves the following space for the Root file system on SPARCbook models:

S1-170/170E	2119 Cylinders	66.2M bytes
S1-240/240E	3350 Cylinders	104.7M bytes

Disk 1 Partition	Position	Size (Cylinders)	Device	Description
System	0	1	-	Partition tables
opt	1	Remaining	id1a	/opt partition
Whole	0	Whole Disk	id1c	Whole Disk
Resume	end-256	256	id1d	Resume Partition (8Mb)
Resume	end-1024	1024	id1d	Resume Partition (32Mb)

---

This leaves the following space for the `/opt` file system on SPARCbook dual disk configuration models:

S1-170	2375 Cylinders	74.2M bytes
S1-170E	1607 Cylinders	50.2M bytes
S1-240	3604 Cylinders	112.6M bytes
S1-240E	2836 Cylinders	88.6M bytes

---

## ***CHANGING THE DISK LAYOUT***

---

For specific requirements you may change the disk layout to suit your own requirements. However, if you wish to change the layout of a partition that has existing user or system files resident, you will need to backup the relevant files before you change the partition information.



---

If you change the partition information for a partition that has system and/or user files resident then those files will be lost. Ensure you have a full system backup before attempting to change partition information.

---

To change a partition you can use the `format` command in the minifs file system, or in the Operating System itself. You cannot modify a mounted partition. You must also observe the following constraints:

- `id0a` Must be the root partition and must be at least 1760 Cylinders
- `id0b` Must be the primary swap partition and must be at least 384 Cylinders  
This must start at Cylinder 1.
- `id0c` Must always be the whole disk
  
- `id1c` Must always be the whole disk

In addition a Save and Resume partition must be at least the size of the system physical memory. The Save and Resume facility will use the first 8 or 32M byte of this partition, if enabled. See 'Disabling Save and Resume' for further information.



---

If you do not conform to the above requirements the system may not be buildable. You should refer to 'Troubleshooting and Problems' if you have changed the partitions and are unable to load the Operating System.

---

The `format` program provides on-line help and is used to format and partition disks. The procedure below is an example of how to partition a second disk in an S1-240E configuration to provide two 28M byte partitions, an additional 32M bytes of swap space, as well as the Save and Resume area. It also explains how to make file systems and how to mount and use the new partitions.

- The `format` command.

Because this operation does not involve the basic operating system you can carry it out on a running system. If you want to change the root file system layout you will have to reload the Operating System from the minifs file system. Before continuing make sure you have done the following:

- Taken a system Backup
- Unmounted the `/opt` partition (or else you cannot run `format` on it). To do this logged in as root type:

```
# cd /  
# umount /opt
```

- Run the `format` command

```
# format
```

---

The format program will search for disks locally, and via the optional parallel to SCSI converter (if fitted). To partition the second 120Mb disk select disk 1 to the Specific Disk question (disk id1).

**NOTE**

The format program is designed to run on SCSI disks. The program supports the internal IDE disks but is only designed to support partition changes on these disks. Do not use any of the other options on the internal IDE disks.

- Choose Partition Information and then print the current table

```
format> partition
partition> print
```

As shipped a second 120Mb disk partition table on the S1-240 model would have a table similar to the following:

```
partition a - starting cyl      1, # blocks  181504
partition b - starting cyl      0, # blocks    0
partition c - starting cyl      0, # blocks  247104
partition d - starting cyl    2837, # blocks  65536
partition e - starting cyl      0, # blocks    0
partition f - starting cyl      0, # blocks    0
partition g - starting cyl      0, # blocks    0
partition h - starting cyl      0, # blocks    0
```

Partition **a** is the `/opt` file system, **c** is the whole disk, and **d** is the Save and Resume partition.

Note that the printed table shows starting cylinder numbers, and the partition sizes in blocks. You will be asked to enter partition sizes in blocks. You should ensure that all start locations and sizes are on cylinder boundaries (multiples of 64 blocks).

---

- Change the Partitions

```
partition> a  
  
partition a - starting cyl      1, # blocks  181504
```

```
Enter new starting cyl      [1]: 1  
Enter new # blocks [181504]: 57984
```

```
partition> b  
  
partition b - starting cyl      0, # blocks      0
```

```
Enter new starting cyl      [0]: 1813  
Enter new # blocks [0]: 65536
```

```
partition> e  
  
partition e - starting cyl      0, # blocks      0
```

```
Enter new starting cyl      [0]: 907  
Enter new # blocks [0]: 57984
```

These commands create 3 new partitions with 45Mb, 45Mb and 30Mb respectively. The revised partition table can be seen before actually writing it to the disk by using the Print command again. This time the revised partition table will be displayed.

```
partition> print  
  
partition a - starting cyl      1, # blocks      57984  
partition b - starting cyl     1813, # blocks      65536  
partition c - starting cyl      0, # blocks     247104  
partition d - starting cyl     2837, # blocks      65536  
partition e - starting cyl      907, # blocks      57984  
partition f - starting cyl      0, # blocks      0  
partition g - starting cyl      0, # blocks      0  
partition h - starting cyl      0, # blocks      0
```

---

The partition map is written to the disk by issuing the `label` command.

```
partition> label
```



---

The label operation will write the new partition information to the hard disk. It will not be possible to recover the contents of old partitions once this operation is carried out.

---

- Make a File System on the new partition

```
# newfs /dev/id1a          (Partition a)
# newfs /dev/id1e          (Partition e)
```

Partition b does not need a file system since it is being allocated as additional system swap space.

- Reconfigure the OS Configuration files to use the new File Systems and Swap Space

Make directories to mount the new file systems on:

```
# mkdir /opt1              (/opt is created by default at the factory)
```

Edit the file `/etc/fstab` and change the line:

```
/dev/id1a /opt    4.2 rw 1 3
```

to:

```
/dev/id1a /opt    4.2 rw 1 3
/dev/id1e /opt1   4.2 rw 1 3
/dev/id1b swap swap rw 0 0
```

This command configures partition b to be automatically allocated as additional swap space, and the two new file systems to be mounted as `/opt` and `/opt1`. When you next reboot the system the changes will be automatically configured.

---

## ***DISABLING SAVE AND RESUME***

---

The SPARCbook system uses a facility called Save and Resume to allow you to shut the system down from mid-application and restore on the next power up to the exact status when you turned the machine off. This removes the requirement to shut down and reboot the operating system every time you turn the machine on and off. However, the system has to allocate an area of disk space to store the current memory contents when the machine is powered down. For maximum speed, compression techniques are not used resulting in a save and resume requirement equal to the amount of memory space in the system. On an S1-120E model this amounts to 32M byte of disk space allocated for this function. However, if you are prepared to forego the Save and Resume function this disk space may be allocated for additional swap space or user file space.

In order to disable the Save and Resume feature you need to make the following changes to the System. First login to the system as root and then carry out the following command:

```
# /usr/etc/install/disable_saveresume
```

After execution of this command when you turn the SPARCbook off using the Alt-Esc-O keyboard sequence, the system will execute the `halt` command. When you restart the SPARCbook the Operating System will be rebooted.



---

The `halt` command will cause the immediate exit of any applications running and the operating system to shut down. You should ensure that you have saved any work you are doing and shut down any applications before turning the system off. Failure to observe this warning can result in loss of data.

---

You may then reuse the partition (by default `id0d`) freed up by allocating it as additional swap space or as a user file system. The procedures for doing this have been outlined in the preceding pages.

Whether or not Save and Resume are enabled you may also turn the system off or reboot (restart the Operating System) from the command line interface. The following command options are provided.



---

<code>shutdown [time]</code>	time may be 'now' for an immediate shutdown, or +n, where n is a number of minutes. A warning is printed to any logged in users 5 minutes before the shutdown. The SPARCbook will be switched off.
<code>reboot</code>	Write any pending information to the disks, shut down and restart the Operating System.
<code>reboot -- -s</code>	As reboot but restart the Operating System in single user mode. You will need to go Ctrl-D at the single user # prompt to continue into the normal multi user mode.
<code>halt</code>	Write any pending information to the disks, and then stop the Operating System and turn the SPARCbook off.

---

### ***ENABLING SAVE AND RESUME***

---

If you have disabled the Save and Resume facility you may re-enable it at a later date. To do this you first need to ensure that there is a partition allocated to the Save and Resume function. You should ensure that this partition is not present in the `/etc/fstab` file. The Save and Resume function will use an amount of space on the partition corresponding to the physical memory size. Thus on an 8M byte system the Save and Resume partition must be at least 16384 blocks. On a 32M byte system (SPARCbook E models) the Save and Resume partition must be at least 65536 blocks.

You re-enable the Save and Resume facility by executing the following command when logged in as the superuser.

```
# /usr/etc/install/enable_saveresume partition
```

---

`partition` is the name of the Save and Resume partition (for example `/dev/id1f`).

When you next turn your SPARCbook off using the Alt-Esc-O sequence, the system state will be saved, and the resume function will be automatically activated when you restart the SPARCbook.

---

## ***RECONFIGURING THE OPERATING SYSTEM KERNEL***

---

The optional cluster on the full CD version of the SPARCbook Solaris Operating System provides a directory of object modules for reconfiguring and rebuilding the SPARCbook kernel. This directory is built and used in the same way as for a standard Sun kernel and you should refer to the full documentation package for further information.

However, it is possible to configure the kernel `max_users` parameter from the bundled operating system. By default this is set to 8. Unlike its name suggests the `max_users` parameter is not a maximum number of users, but refers to the amount of kernel resources allocated to handling processes, the network activity and the OpenWindows system. You will normally not want to change the default setting. However, the facility exists to change the number as follows:

```
# /usr/etc/install/maxusers n
```

will change the `maxusers` parameter to `n`. `N` must be between 2 and 64. To take effect you must exit all your applications and restart the Operating System by typing `reboot` when logged in as the superuser. `maxusers` typed without an argument will report the current setting.

---

## ***FURTHER READING***

---

The SPARCbook product incorporates a complete SunOS Release 4.1.2 implementation, including PostScript support, enhanced networking and file system support, DOS Emulation support and many other capabilities. Available from your SPARCbook supplier is a complete set of documentation for the Operating System and software provided with SPARCbook. This section provides a summary of the documentation package as a quick reference guide.

SunSoft use Solaris 1.0.1 to describe the SunOS 4.1.2 with bundled SunView 1.8 and OpenWindows Version 2 products. The SPARCbook version of Solaris 1.0.1 comprises SunOS 4.1.2 and a bundled OpenWindows Version 3 product. The SPARCbook version does not include SunView.

<b>NOTE</b>
-------------

The supplied documentation refers to the complete SunSoft implementation of SunOS 4.1.2 and OpenWindows Version 3. Many of the facilities described are not part of the bundled SPARCbook Solaris 1.0 version, but are available in the unbundled packages supplied on CD with the SPARCbook. Some of the features described in the documentation, such as audio capabilities, do not apply to the SPARCbook 1 product, which does not support some of the hardware devices found in a Sun workstation. The information in this guide always takes precedence over the SunSoft documentation.

---

---

## ***SUNOS 4.1.2 DOCUMENTATION***

---

This part of the documentation set is standard SunOS literature and manuals. There is a brief description given of each binder.

### **• SunOS RELEASE AND INSTALL**

Much of the SunOS Release and Install manual is Sun system specific, but it includes sections on the Software clusters, new features in SunOS 4.1.2 and some general information on the Operating System and available documentation. Note specifically that the SunInstall program is not supported on the SPARCbook and that you should follow the installation procedure given in this guide to load the bundled operating system onto the SPARCbook disk.

---

## • USERS GUIDES

These are brief manuals written for the user with little or no UNIX experience. *Getting Started* is for those new to the Sun computing environment. Other guides supplied are *Doing More with SunOS*, *Basic Troubleshooting* and *Customizing your Environment*.

## • GLOBAL INDEX

This binder provides a global index to the SunOS 4.1 facilities. It does not cover the OpenWindows product.

## • SYSTEM AND NETWORK ADMINISTRATION

This is the main manual for system administrators, but will be of interest to all UNIX users. It deals with software administration including backup and restore, disk maintenance, system accounting, security, networking and electronic mail service and advanced UNIX system administration.

## • SunOS REFERENCE MANUAL

This is the traditional UNIX manual pages alphabetically arranged as an index of commands, functions and file formats. The three binders contain the following 8 sections:

- User Commands
- System Calls and Error Numbers
- User-level Library Functions
- Devices, Drivers, protocols and Network Interfaces
- File Formats
- Games and Demos
- Public files, tables and TROFF macros
- System maintenance and operations commands

---

## • SunOS DOCUMENTATION TOOLS

This covers the UNIX editors, `vi`, `ex`, `ed` and `sed`. A formatting documents section explains TROFF and macros for indexing, table formatting and equation setting. The use of NROFF and TROFF explains the text processing utilities.

## • PROGRAMMERS GUIDES

This group of manuals describes programming in the Sun Environment for system and application level. It comprises the following documents:

- C Programmers Guide
- Assembly Language Reference Manual for SPARC
- A RISC tutorial on SPARC
- Porting Software to SPARC systems
- Debugging Tools

## • PROGRAMMERS OVERVIEW

The *System Services Overview* contains details of internationalization, security features, networking and UNIX standards compatibility. *Programming Utilities and Libraries* provides an overview of the Sun environment, facilities, utilities and libraries for the applications programmer.

## • NETWORK PROGRAMMING GUIDE

This manual provides an overview of NFS, pipes, sockets, network commands, the on-line database service (NIS) and the network managers and monitors.

## • WRITING DEVICE DRIVERS/STREAMS PROGRAMMING

This document provides a guide to writing device drivers for SunOS 4.1 systems and provides detailed information on STREAMS programming including theory, the SunOS implementation, and an index of STREAMS functions and data structures.

---

## ***OPENWINDOWS VERSION 3 DOCUMENTATION***

---

This covers the OpenWindows Graphical User Interface (GUI) and the DeskSet Reference Tools. Documentation for novice users of the DeskSet environment through to detailed programming information on the X11/NeWS server and libraries is available.

- **OPENWINDOWS VERSION 3 RELEASE MANUAL**

Describes the OpenWindows Version 3 release including a general overview, new features and limitations.

- **OPENWINDOWS VERSION 3 INSTALLATION AND START-UP GUIDE**

Describes how to install and startup the OpenWindows software. This is of limited use for the SPARCbook implementation since the bundled release is pre-installed. However, the guide also contains useful information on the other OpenWindows clusters, and special environments.

- **OPENWINDOWS VERSION 3 DESKSET REFERENCE GUIDE**

Provides information on how to use the DeskSet tools consisting of: File Manager, Mail Tool, Calendar Manager, Text Editor, Print Tool, Tape Tool, Snapshot, Shell Tool, Command Tool, Console, Performance Meters, Clock, Calculator, Icon Editor and Binder.

- **OPENWINDOWS VERSION 3 USERS GUIDE**

Provides a user's introduction to the DeskSet environment and information on customizing the environment as well as running non-DeskSet applications.

---

- **OPENWINDOWS VERSION 3 PROGRAMMERS GUIDE**

Provides an overview of programming for the OpenWindows environment including the X11/NeWS server and its components. Information on NeWS and X11 utilities, clients, font and color support is provided.

- **OPENWINDOWS VERSION 3 REFERENCE MANUAL**

This contains the OpenWindows Version 3 UNIX style Manual Pages

- **XVIEW 3.0 REFERENCE MANUAL: CONVERTING SUNVIEW APPLICATIONS**

This contains instructions on converting the older SunView applications to XView. It provides details of the XView toolkit architecture.

- **OLIT 3.0 WIDGET REFERENCE SET**

This contains the reference introduction to the OLIT Widget Set. The manual pages for the Widget Set are also available on-line on the CD version of the SPARCbook Solaris OS.

- **NeWS PROGRAMMERS GUIDE**

Provides information on the NeWS language, including events, classes, canvases, memory management, client-server interface, debugging and operators and types.

- **NeWS TOOLKIT REFERENCE MANUAL**

Provides reference information on the TNT programmers interface.

- **TOOLTALK 1.0 SETUP AND ADMINISTRATION GUIDE**

Provides information on ToolTalk setup and maintenance for System Administrators.

---

- **TOOLTALK 1.0 PROGRAMMERS GUIDE**

Describes the ToolTalk service and provides information on adding ToolTalk messaging capabilities to new or existing applications.

- **OPENWINDOWS VERSION 3 DESKTOP INTEGRATION GUIDE**

Provides programmers with information on the technologies available for developing and integrating applications for the OpenWindows Version 3 environment. It is written for ISVs who have previous windowing experience and who wish to integrate their applications with other DeskTop facilities. This includes discussions on selections, drag and drop, the Classing Engine and ToolTalk services.

---

## ***BOOKS AND OTHER DOCUMENTATION***

---

The following books are also supplied as part of the SPARCbook reference manual set.

- **OPEN LOOK MANUALS**

The OPEN LOOK Functional Specification and Application Style Guide provide a definition of the OPEN LOOK Graphical User Interface for Applications Developers.

- **POSTSCRIPT MANUAL SET**

The PostScript Red book is the Language Reference manual. The blue book is the Tutorial and Cookbook providing worked examples of using the PostScript language.

- **X WINDOW MANUAL SET**

This is the complete 8 volume manual set published by O'Reilly & Associates for the X Window system. It provides a comprehensive user and programmer guide to the X Window graphics software implemented on SPARCbook as part of the X11/NeWS server.



---

## ***TECHNICAL REFERENCE GUIDE***

---

The Technical Reference guide for the SPARCbook covers the SPARCbook hardware in considerable detail. It is provided as part of the optional complete SPARCbook documentation set, and as a separate product option. It covers the following main topics and is targeted primarily at systems software developers.

- Technical Overview Provides an overview of the SPARCbook System Architecture
- SPARC CPU Module Describes the 601, 602 and 604 SPARC device set used in the SPARCbook.
- AT bus Interface Describes the core S1 ASIC and provides the programming interface to the device.
- Hardware Devices Describes the I/O controllers and devices used in the SPARCbook to register level.
- System Software Describes the Operating System implementation on the SPARCbook and information on the EPROM monitor interface.
- System Schematics Provides the SPARCbook schematics and interfaces.
- Component Specifications Provides the system component specifications for the major SPARCbook subassemblies.

---

# **TROUBLESHOOTING AND PROBLEMS**

This section provides information on troubleshooting problems that might arise using the SPARCbook product. It gives information on how to use the system diagnostics, and some guidelines on what to do if you suspect hardware or software problems. It is primarily intended to allow you to diagnose the source of a problem and to enable you to determine whether you can take corrective action yourself, or whether you need to call on the assistance of Technical Support personnel.

---

## ***HARDWARE***

---

The SPARCbook system provides simple low level diagnostics that can be run to determine possible hardware problems in the system. While these diagnostics cannot cover all eventualities they will provide a reasonable first line confidence test in the basic operating hardware of the SPARCbook system.

---

### **SYSTEM WILL NOT START UP**

---

If the system does not respond when you switch on there is either a serious problem or there is no power to the system. When the system is first turned on all the LED indicators to the left of the display except the disk indicator should be lit for a brief period and the system should issue a small beep.

#### **PROBLEM: NO STARTUP BEEP**

- If there is no Beep from the system check the following:

Is the battery dead?	To check this plug in the external adaptor and try again.
Is the adaptor faulty ?	Observe the Green light at the front of the adaptor. If it does not light when the main supply is connected the adaptor is faulty.

If power is being supplied to the system and there is no response there is a major hardware fault and you should contact your supplier for assistance.

---

## PROBLEM: NO DISPLAY INITIALIZATION

- If there is a Beep but the display does not initialize check the following:

Is the battery dead?

If the Red LED is fully or dimly lit then the battery is flat. You will need to recharge it using the external adaptor. You may use the system while you do this.

If the display has not initialized there is probably a serious problem with the system. The system will try and communicate through the serial port if it cannot access the display. To check this connect a serial ASCII terminal to the serial port (see Connecting a Terminal) and configure the terminal for 9600 baud operation, 8 bits, no parity, no handshaking. Reset the SPARCbook and if any output appears on the terminal attempt to run the diagnostics as detailed below. Note that the input device will still be the SPARCbook keyboard.

---

## ***RUNNING DIAGNOSTICS***

---

By default the SPARCbook system runs a set of fast diagnostics at power up. The results of these are reported on the system screen. You may also run more extensive diagnostics manually. To do this carry out the following procedure:

- Interrupt the startup

When the `Press any key . . .` message is displayed on the bottom right of the screen press the space bar. A menu of options will be displayed.

- 
- Select the System Diagnostics Option

Type 4 <ret> to select the diagnostics. A menu of available diagnostics will be printed:

```
SPARCbook Diagnostics
System Configuration:

    Serial No: 1b0653
    8Mb DRAM
    FPU
    Hard Disk:
        Drive 0: 82Mb QUANTUM GO80A rev. 3.3.4
    Hardware Revision Level: 1.0
    Firmware Revision Level: 0.2

1> CPU/FPU
2> MMU
3> I/O
4> MEMORY
5> System Controller
6> Check Hard Disks
7> Full System Tests
8> Configure Parity
9> Start Up System

Enter Choice>
```

The system configuration and hardware revision level will be printed first and will vary according to your own system. You may then select a particular test to run. If any tests fail it is indicative of a hardware failure and you should contact your supplier for assistance. Using option 7 it is possible to run continuous diagnostics until you press any key to exit.

Using option 8 you can turn the system DRAM parity off. By default the SPARCbook is factory configured with parity enabled. If you choose to switch parity detection off there will be a small performance increase in DRAM access times.

---

**NOTE**

While turning parity protection off can provide a small increase in performance it is not recommended except for diagnostic purposes, since it reduces the hardware system error detection capabilities of the SPARCbook.

---

---

**DISK PROBLEMS**

---

If the hard disk experiences a shock during operational use or has a media flaw it is possible that hard data errors can occur from the drive over time. The UNIX operating system will detect this situation and will report an error. The SPARCbook system provides the capability of automatically remapping bad blocks so that they are replaced with a new block that is good. You can also perform a complete scan of the disk to detect any bad blocks if you suspect disk problems.

The UNIX Operating System will report a message such as the following if it detects a bad block during normal usage:

```
Bad Block on Device 0 Block 135412
Hard Disk error
```

At this point the operating system may be unable to continue due to the data error and it may *panic*.

---

**NOTE**

A UNIX panic is a situation where the operating system is unable to continue due to a serious hardware or internal software error. In order not to potentially further corrupt data the Operating System will immediately abort or panic. It will usually try and print information about the situation which should be recorded for subsequent examination of the problem. See Operating System Panic for further information.

---

If the Operating System is able to recover it will not panic, but will instead flush any buffers that do not depend on the faulty block to the disk and will then automatically reboot.

---

## ***REPAIRING A BAD BLOCK***

---

The disk drives used in the SPARCbook will automatically re-assign defective disk sectors where possible. However, occasionally the disk drive is unable to carry out the re-assignment. In this instance it is possible to try and interactively repair the bad disk block, although the disk may have too many re-assigned sectors already. If an unrecoverable disk error occurs the SPARCbook will indicate the error and will prompt you to restart the system. Depending on the location of the error the system may stop operation in any case. You should reset the SPARCbook using the Ctrl-Alt-R key sequence. When the monitor starts up it will enter a menu that asks you whether you wish to attempt to fix the problem or whether to continue.

```
SPARCbook: Warning - Disk Errors have been found.  
Disk errors should be repaired before the system is  
restarted, although this may result in a loss of data.  
Refer to the SPARCbook User Guide for further information.
```

- ```
1> Interactively Repair Disk Errors  
2> Continue with automatic system startup
```

```
Enter choice>
```

If you select option (1) the monitor will again attempt to read the disk block that previously failed. If this works the following message will be printed:

```
Repairing block 12345 on Drive 0  
The monitor has successfully read this block
```

- ```
1> Allocate a new block  
2> Do not repair this block
```

```
Enter Choice>
```

If you select (1) the system will allocate a new block in any case. You should take this action if you get persistent bad blocks with this block number, even if the monitor is able to read the block. If this is an isolated incident you may select (2) which will not reallocate the block. If the error recurs with the same block number you will then need to Allocate a new block.

---

## ***DISK SCANNING***

---

Since the SPARCbook drives are preformatted it is not possible to reformat the disk drive. If you start to get persistent hard errors it is a symptom of a serious problem with the hard disk drive and you will need to have it replaced.

The SPARCbook diagnostics menu contains a menu option to Check hard disks. This option will ask you if you want to perform a disk scan on the hard disk(s) in the system. This scan is non-destructive and can be used to quickly verify whether a system hard disk has blocks which cause hard unrecoverable read errors.

---

## ***OTHER HARDWARE PROBLEMS***

---

### **PROBLEM: NO EXTERNAL VGA**

By default the external VGA port is disabled to conserve power while the operating system is running. However, when the system is first powered on the VGA port is enabled with a standard 640 x 480 resolution to permit diagnostics. Therefore, to determine quickly whether the VGA is working you should plug the VGA monitor in and then reset the SPARCbook. The display should show the same as the internal LCD display for the duration of the system diagnostics and startup and should then go blank when the external port is switched off.

To start up the VGA port from UNIX you should use the OpenWindows menu, or use the command `extvga`. Refer to 'Using the External Monitor' for further information.

### **PROBLEM: EXTERNAL MOUSE DOES NOT WORK**

When using an external mouse you must ensure that it is a PS/2 style mouse with a TTL synchronous data interface, and that the mouse data format is compatible with the Logitech/Microsoft 3 byte protocol. A mouse that does not meet these specifications will not work. Please refer to the manual for your mouse for further information.



---

#### PROBLEM: EXTERNAL KEYBOARD DOES NOT WORK

The external keyboard must also be PS/2 compatible and use the same TTL synchronous data interface. A keyboard that does not meet these specifications will not work. To use an external keyboard you must start up OpenWindows with the external keyboard enabled. Refer to 'Using an External Keyboard' for further information.

#### PROBLEM: SERIAL PORT DOES NOT WORK

By default the serial port is disabled to conserve power. It is enabled automatically by the operating system when the device is opened. By default the port is enabled for a printer application. If you want to connect a login device to the serial port you will need to edit the file `/etc/ttytab`. Refer to 'Connecting an ASCII Terminal' for further information.

If the serial port still does not appear to work check the following:

- Is the serial cable wired correctly ? The simplest wiring connects only Transmit Data, Receive Data and Ground. It is very easy to get pins 2 and 3 the wrong way round for Data Terminal Equipment (DTE) or Data Communications Equipment (DCE).

#### PROBLEM: ETHERNET DOES NOT OPERATE

Read the 'Configuring Ethernet' section of the Guide carefully. Networking must be enabled before the network will run. If you suspect the Ethernet hardware run the diagnostics. If these seem fine then try using the monitor to load a file from a remote system using the beginning of the Standalone Restore facility. Refer to 'Restoring From Ethernet' for further information. If this works then it is likely to be a software configuration problem. See 'Networking Problems' below.

---

## ***SOFTWARE PROBLEMS***

---

Since the Operating System controls the peripherals the Operating System configuration is a critical part of enabling the entire system to operate correctly. For example, a minor change in a networking configuration file can prevent the entire networking interface from operating. On a UNIX system the role of a system administrator is to resolve day to day operational problems with the Operating System to ensure the smooth running of a particular installation. The SPARCbook is more of a portable system and special efforts have been made to make the Operating System easy to use for the inexperienced UNIX user. Nevertheless situations may arise where you need the help of an experienced system administrator or the available SPARCbook technical support services.

This section provides some information on common software problems and gives brief advice as to the course of action to be taken in each case. By its very nature it cannot be complete.

---

## ***STOPPING PROCESSES***

---

You can stop a process that is using keyboard input in most cases by sending the *interrupt* character to it. By default this is the *Ctrl-c* key sequence. This will normally cause a program to exit. However, in some cases the program will not recognize or act on the interrupt character and you will need to kill the process in order to quit it. This is described in the next sections. The OpenWindows X11/NeWS server also has a special character sequence to cause it to abort.

<b>NOTE</b>
-------------

---

Aborting the X11/NeWS server will also kill any programs that are running on the OpenWindows screen. This should only be used as a last resort if you do not get any response from the system while running OpenWindows.

---

To kill the X11/NeWS server type `ctrl-alt-x`.

---

In extreme cases the system can completely hang. This is an operating system fault and should never happen. However, as an example there are situations where programs run out of memory and are unable to recover when unforeseen circumstances can occur. In this case there is little option but to reset the machine. See 'Resetting the SPARCbook' below for further information. The 'Memory Usage and Swap space' sections below may also be relevant.

---

## ***KILLING A PROGRAM***

---

To see what processes or programs are running you should open a command tool or be at the normal UNIX shell prompt. The following commands will give a summary of the running processes:

```
% ps                gives a summary of your own processes
% ps -a            gives a summary of all user processes
% ps -ax          gives a summary of all system and user processes
```

This information can be used to kill processes that have hung or that do not respond to the interrupt command. To kill a process you need to record its process number from the `ps` command output. For example the following output shows a program demo running:

```
% ps
PID  TTY      TIME  COMD
678  p2      0.00  sh
713  p2      0.05  sh
718  p2      0.32  demo
728  p2      0.01  ps
%
```

---

The Process number or PID is the number on the left side of the screen. So to kill the demo process you would type:

```
% kill -9 718
```

The -9 specifies that the process should be killed regardless of what it is doing. If you do not own the process you will need to assume the root privileges to carry out this step. To do this you need to first execute the `su` command and enter the root password. When you have finished type `Ctrl-d` to exit the `su` shell and return to your normal user privileges.

---

## ***OPERATING SYSTEM PANIC***

---

If there is a hardware or a software fault the Operating System can panic. This is what occurs when the Operating System makes a decision that it cannot continue to run the machine. This can be due to a variety of reasons but should only occur due to a soft or hard hardware error, or due to a serious software problem or bug in the Operating System. If the system does panic a message will be printed on the screen saying so, together with as much information as the Operating System is able to gather about the cause. You should record the information for subsequent use by Technical Support personnel. The system may be able to reboot automatically or may require manual resetting as described below.

---

## ***RESETTING THE SPARCBOOK***

---

If the Operating System has panicked or all other remedies have failed you will have to reset the SPARCbook. This should only be used as a last resort since the Operating System will have open files and unflushed buffers and will have to be repaired when the system is rebooted. To reset the system press `Alt-Esc-r` simultaneously.



---

You should only press `Alt-Esc-r` when you want to reset the system. If you perform this operation during normal system use, the file system will be corrupted and will require repairing. You may also lose files that you were working on at the time. In an extreme case you may need to rebuild the file system on the disk.

---

After resetting, the SPARCbook will attempt to reboot in the normal way and will do a complete UNIX reboot (as opposed to a resume operation). However, because the system was shut down with a reset command an automatic file system check program (`fsck`) will be run. In most cases this will complete automatically. However, in some instances it may require manual intervention to repair the file system. A typical example is shown below:

```
checking root file system
/dev/rid0a: UNREF FILE I=17481 OWNER=user MODE=100755
/dev/rid0a: SIZE=0 MTIME=Jan 3 12:27 1992 (CLEARED)
/dev/rid0a: SUMMARY INFORMATION BAD (SALVAGED)
/dev/rid0a: 3992 files, 57802 used, 8229 free
/dev/rid0a: (53 frags, 1022 blocks, 0.1% fragmentation)
Mounted FS Fixed - rebooting Single User
```

Alternatively you may be asked to start `fsck` by the system itself.

Enter the root password to gain access to the system maintenance facilities. Note that you cannot use OpenWindows or the network facilities at this stage. You must now run the `fsck` program as follows:

```
# fsck /dev/id0a
```

You may be asked questions as the file system check proceeds. Typically any files removed are temporary files, files with duplicate references or null files. You may be asked whether to Reconnect a file. This means that a file has been found but the system has lost track of its name. It will be stored in the directory `/lost+found` with a unique number. Such files may be examined and recovered after the system has been completely rebooted. If the file is specified as having 0 characters it is empty and you should answer 'no' to the 'reconnect' question and 'yes' to the

---

'clear' question. You should typically answer 'yes' to the questions posed as the system will try and do the best job it can at repairing the file system. However, in rare cases critical system files can get corrupted and answering 'yes' can mean that the system cannot be rebooted and must be completely restored from a backup. In this event you may be able to save some of your data before you rebuild the system. The data will have to be saved from the single user environment. If you have not used the `fsck` program before and you are unsure how to proceed you will need to ask for help or technical support.

After completion of the `fsck` the system will either automatically reboot, or may complete its single user startup sequence and give the `#` prompt. In the latter case simply type `Ctrl-d` to continue the normal boot sequence.

---

## ***FAILING PROGRAM***

---

Programs can fail to run for a variety of reasons. Some of these are shown below:

### **PROBLEM: PROGRAM FAILS**

A segmentation fault or core dump error message is due to the Operating System encountering an unrecoverable error during program execution. Possible causes are:

- Corrupt program - the disk copy of the program has been corrupted
- Shared Library inconsistency - the program was compiled with a shared library that is incompatible with the SPARCbook version. You may use the `ldd` utility to determine what libraries a program is loading:

---

```
% ldd /usr/bin/ls
```

```
dynamic linker: /usr/bin/ls: file loaded: /usr/lib/libw.so.1
dynamic linker: /usr/bin/ls: file loaded: /usr/lib/libintl.so.1
dynamic linker: /usr/bin/ls: file loaded: /usr/lib/libc.so.1
dynamic linker: /usr/bin/ls: file loaded: /usr/lib/libdl.so.1
%
```

This problem can only be resolved by relinking the application with the SPARCbook or SunOS shared libraries.

- Program Error - a programming fault can cause a segmentation violation if, for example, a program attempts to write to an illegal or protected address.
- Out of Swap Space or Memory Space - a message may sometimes be printed on the console if either of these conditions occur. If you are running OpenWindows the server may suddenly exit, returning you into the terminal interface. See 'Memory Usage and Swap Space' below for how to prevent this problem.
- Memory failure - there has been a memory error (hardware) during program execution

The bundled SPARCbook operating system includes the `trace` utility which allows you to monitor the system calls made by a process. This can sometimes help an experienced UNIX programmer track down the cause of a problem. In addition experienced UNIX programmers may be able to use the `crash`, `adb` or `dbx` debugger utilities provided to determine the cause of a core dump.

<b>NOTE</b>
-------------

---

If a segmentation violation or core dump message is printed and you are not going to examine the core file with a debugger it is sensible to remove the core file. Core files can each consume several megabytes of disk space.

---

---

## **WARNING MESSAGES**

---

The UNIX Operating system will often print warning messages as system information. There is nothing necessarily wrong, but you need to understand which messages are an indication of a potential problem and which are simply for information.

Warning messages generally come out onto the Console window, but can also come out in a `cmdtool` window or in the application window you are using. The following is an example of an information message on the console, meaning that someone with an account 'user' has successfully performed an `su` command, and now has superuser access privileges.

```
Jan 12 19:43:16 su: 'su root' succeeded for user on /dev/tty2
```

The following messages are also generally not an indication of any problem.

```
XIO: fatal I/O error 32 (Broken pipe) on X server ":0.0"
after 1068 requests (1068 known processed) with 0
events remaining
The connection was probably broken by a server
shutdown or KillClient
```

This message is because the X11 server was told to kill a process when it still had outstanding events to write to a window. It is usually as a result of quitting a demonstration or an X11 program using the Window Quit option.

```
XView warning: Notifier error: Unknown client
```

You may see messages such as this when you exit from the X11/NeWS server. They are not an indication of any abnormal behaviour.



---

Some messages are an indication that the system has run out of resources and require attention. For example a program may fail to start or may print a message such as:

```
        out of swap space
or     out of memory
or     FS full on /dev/sd0a: cannot write %xyx
```

As a general guide you should try and exit the offending program in this situation. It is prudent to reboot the operating system after such an event since applications and the Operating System do not always recover from resource failures gracefully. (Running out of space on the floppy disk or on attached media is not an abnormal event and simply requires you to take the appropriate action). If you run out of disk space you must either move files to a different file system, or to a networked server, or you must remove them. Overcoming swap space and memory limitations is discussed in the next section.

---

## ***MEMORY USAGE AND SWAP SPACE***

---

The Solaris Operating System uses Virtual Memory. This allows multiple programs to be running at any one time even though they will not all fit into the available memory at any one time. Areas of the program that are not running at a given moment can be 'swapped' to a special area on the hard disk drive called the 'swap space'. However, all applications require a certain amount of memory to be available before they will start up. The 8Mb of memory provided in the standard SPARCbook model (E versions have 32Mb memory) can be used up if you start up many applications and leave them on the OpenWindows Workspace. Programs which have been closed to icons, for example, are still running and may be using significant amounts of memory.

In addition, instead of running out of memory, you may have too many applications running to fit into the available memory and swap space allocated for the system. The default system has 16M bytes of space allocated to swap. You can find out how much of this you are using at any time with the `psstat` command. This will print out the available and used swap space.

---

```
# pstat -s
```

Print swap space statistics

The strategies below show how to minimize your memory and swap space requirements. However, you may also add swap space to the system as explained in the next section.

The system has been configured to allow a reasonable number of tools and applications to be used simultaneously. Typically a user might be running one or two third party applications, together with a Mail Tool, a clock and a File Manager. Depending on the size of the applications this should not present any difficulties. However, if you attempt to run a large number of complex applications on the SPARCbook sooner or later you are likely to run out of memory or swap space.

To minimize your memory and swap usage bear the following in mind:

- Minimize the number of DeskSet tools you use. The tools use large amounts of memory. For example, if you only use the Calendar Manager occasionally call it up from the Workspace menu when you need it rather than leaving it as an icon on your workspace.
- Avoid using tools that use memory continuously or often. For example the performance meter tool runs every second. Similarly if you enable the second hand on the clock the clock program must run every second.
- Keep your mail in mailfiles if you have more than tens of messages. Each message that appears when you open your mail file takes memory.
- Keep tools iconified if you are not using them, but do not want to quit them. For example, the performance meter and the File Manager tools are suspended when they are iconified, freeing up memory (but not swap space) for other processes.
- Arrange tools on the screen so they do not overlap. This reduces repainting by the Window manager.

- If you are using the multi-browser in the Calendar Manager, quit it when you are finished rather than iconizing it, it is almost as quick to restart it from the Calendar Manager as it is to open it from the icon.
- Do not use a background image for the main background, plain backgrounds use less memory.
- Avoid using PostScript applications at the same time as OpenLook applications.
- Do not try and run too many applications at once. You may have to reduce the number of different applications active or on the DeskTop if you want to run a new large application.

---

## ***ADDING SWAP SPACE***

---

You may add swap space to your system in one of two ways. The first has already been described in the Technical Reference section and involves allocating a disk partition as further swap space. This could be a new partition if you have the space available, or could be achieved by using the Save and Resume partition (in which case you will lose the Save and Resume functionality). Alternatively you may designate a normal file as additional swap space for the system. For example the following commands will create a 6M byte file for use as extra swap space (you will need to be superuser or logged in as root to do this).

```
# mkdir /swap
# cd /swap
# mkfile 6m SWAPFILE           (Make a 6M byte file)
```

To add a swap file or an unused disk partition to the system you should add lines such as the following to the file `/etc/fstab`.

```
or      /swap/SWAPFILE  swap swap rw 0 0    for a swap file
        /dev/id1d  swap  swap rw 0 0    to add the sd1d partition
```

---

Finally tell the system that the additional swap space is to be allocated by executing the `swapon` command. This will add the newly created swap partition. When the Operating System restarts it will automatically set the additional swap area up so you only need to do this once.

**# swapon -a**



---

If you allocate a partition for Swap space all existing data on it will be removed. Refer to the Technical Reference section on Disk Layouts and Disabling Save and Resume for further information.

---

---

## ***NETWORKING PROBLEMS***

---

The Solaris 2.0 Networking facilities depend on system wide configuration and setup. If you are unable to communicate over the network you should ask for help from an experienced UNIX system administrator. If such a person is not available you should carefully go through the procedures outlined in the Configuring the Network Section to check the system setup. The most common problems are outlined below:

- Hardware Problems
  - Faulty transceiver
  - Faulty transceiver cable
  - Bad connection to Ethernet cable
  - Unterminated Ethernet cable
- Software Problems
  - Entry for remote system not in `/etc/hosts` (not NIS)
  - Entry for your system not in remote hosts (not NIS)
  - NIS Database not remade after your host entered (NIS)
  - Ethernet Addresses incorrect or duplicate
  - No write permission to requested resources

---

A quick way of determining whether basic ethernet communication is set up correctly between machines is to use the `ping` command. This command checks whether low level packets can be sent and received. To use it specify:

```
% ping systemname
```

 where systemname is the name of the machine you wish to communicate with.

If the communications path is operating a message will be returned:

```
systemname is alive
```

If there is a hardware or a configuration problem nothing will happen as the transmitted packets are not being returned. The command will timeout but you may terminate it with the `Ctrl-C` interrupt command. If `ping` fails there is a basic hardware or software configuration problem and you should check the hardware interfaces and the basic software setup.

---

## ***GETTING FURTHER HELP***

---

If you are unable to diagnose the problem yourself you will need to obtain technical support from a UNIX administrator or from your SPARCbook supplier. Be ready to provide the following information to assist in determining the cause of the problem:

Machine Model Number and Serial Number (from base of unit)

Machine configuration (what peripherals are connected)

For networking problems a brief description of your network will be helpful

A description of the problem and any steps you have taken to overcome it

Any warning messages or Panic Message output you have observed

---

# SOLARIS 1.0.1 BUNDLED COMMAND SUMMARY

## SPARCbook Version A for OpenWindows V3 applications

This summary provides a short guide to the available commands in the SPARCbook bundled version of the Solaris 1.0.1 Operating System. It is intended for a quick reference only and is not complete. For further information on these commands you will need to refer to the complete documentation package available as a separate product from your SPARCbook supplier.

Each command is printed in the following form

`command [options] arguments (ref)`

Ref is OWV3	Available in OpenWindows only
SYSV	Available in /usr/5bin

For some commands only the most commonly required options are listed. There may be other options available but not summarized here. Where a command is available both in the UCB and SYSV trees the UCB version is summarized. In addition some internal administration commands are not summarized. Note that not all commands are supported for all devices, and some command options are hardware dependant. For example the `mt` command will only operate on a remote tape unit, or one connected via the parallel port connection.

**NOTE**

This summary is for reference purposes only and is intended to provide an aide-memoire for users familiar with the UNIX command structure. It provides only a single line explanation of the use of each command and is not intended as an exhaustive reference.

---

**ac [options]**  
login accounting

-w wtmp        alternate wtmp file  
-p            print individual totals  
-d            each 24 hour period

**acctcms**  
command summary from per-process accounting records

-a            print in ASCII not internal format  
-c            sort by CPU time  
-j            combine all commands invoked once  
-n            sort by number of processes  
-s            files in internal format  
-t            process as total accounting records  
-p            prime time only  
-o            non-prime time only

**acctprc1**  
**acctprc2**  
process accounting

**adb [options] [object [core]]**  
general purpose debugger

-w            open object and core for writing  
-k            kernel memory mapping, for /dev/mem  
-l dir        dir to seek command files (/usr/lib/adb)

**adbgen file.adb**  
generate adb script

**addbib [options] [database]**  
create or extend a bibliographic database

-a            do not prompt for an abstract  
-p file       use a new prompting skeleton from file

**add-clusters**  
provides software installation services

**add\_user uname uid gid name homedir shell**  
add a user account to the system

**appres [classname]**  
list application resource database (OLV3)

**apropos**  
locate commands by man page lookup

**ar options afile [names]**  
maintain portable archive or library

d            delete named files from afile  
r            replace named files  
ru           replace named files if newer  
r[a|b] posname    replace after|before file posname  
q            append quickly to end of file  
t            print table of contents  
p            print named files  
m[[a|b] posname]    move to end or after|before posname  
x            extract names (or all)  
v            verbose  
c            do not print create message

**arch [-k]**  
display architecture of host - returns sun4

-k            display kernel architecture - returns sun4m

**as [options] file**  
assembler

-o objfile    output to objfile  
-L            save defined labels beginning with L  
-R            make initialized data read only  
-On           enable peephole optimization level n  
-P            run cpp on each input file  
pass -lpath, -Dname, -Dname=def, -Uname  
-S[C]        pass disassembly of emitted code to stdout  
C prevents comment lines

**at [options] time[date] [+ inc] [script]**  
execute commands at a later time

-c            use csh to execute script  
-s            use sh, default is to use SHELL env var  
-m            send mail after job completes  
-l [job]     reports all jobs scheduled for user, or specified jobs  
-r job        un schedules previously scheduled jobs  
time         not used for -l and -r, hh:mm or hh:mm now (requires + inc)  
date         Monday-Friday, or Jan-Dec 1-31  
+ inc        + n minutes/days/weeks/months/years  
script       command or script to execute

**atq [options]**  
display jobs queued to run at specified times

-c            display jobs in order they were created  
-n            display only the current total number of jobs

**atrm [options] arg**  
remove jobs queued by at or batch

arg user name or job number (see atq for list)  
- all. If invoked as root all jobs will be flushed  
-f force - ignore any messages  
-i interactive - answer y to remove each job

**awk [-Fc] [prog] [params] [files]**  
pattern processing language

-Fc Separate fields by character c (default white space)  
prog Specified patterns  
params Parameters of form x=..., y=...  
files Input file(s)

**banner strings**  
prints up to 10 characters in large letters (SYSV)

**bar [options]**  
create tape archives, and add or extract files

c create new file  
r write named files to end (not 1/4" cartridge)  
x extract  
t list contents  
u add if not there or modified (not 1/4" cartridge)  
014578 specify dev/rmtx, default is 8  
f use next argument as bar-file  
e exit if error  
o suppress owner and mode info  
v verbose  
w wait for user confirmation (y)  
b blocking factor (default 20)  
X use next argument as file of exclusions  
l error if all links not resolved  
F exclude SCCS directories  
FF exclude SCCS, .o, errs, core and a.out files  
m do not use file modification time  
h follow symbolic links  
p restore to original modes  
B perform multiple reads to fill block  
i ignore directory checksum errors  
s force group/owner to be as bar process  
H string up to 128 chars for volume header ID  
S dir target directory for extraction  
U user ID in volume header  
Z compress/decompress  
R read and print volume header  
N check user owns media  
T terminate media search after specified files found  
l use next argument as file of files

**basename string [suffix]**  
deliver portion of a pathname

**bc [options] [file]**  
arbitrary precision arithmetic language

-c compile only  
-l provide arbitrary precision math library

**biff [y|n]**  
give notice of incoming mail

y allow notification  
n disable notification

**binder**  
modify deskset bindings database (OWV3)

**bitmap file WxH**  
**bmtoa,atobm file**  
bitmap editor for X (OWV3)  
bitmap converters to and from ASCII (OWV3)

WxH width and height in pixels  
-help print available options

**bldrgb**  
build a colormap database (OWV3)

**cal [[month] year]**  
print calendar for current or specified month/year

month 1-12  
year 1-9999

**calctool [options]**  
a desktop calculator (OWV3)

-[2|3] 2 is 2D look, 3 is 3D look (default)  
-a num display num digits after decimal point  
-l start up a left handed version  
-m monochrome  
-v print version number  
-Wn/+Wn do not/do print titline

**calendar [-]**  
reminder service

- Perform for all users who have calendar file in their home directory

**captoinfo [options]**  
convert a termcap description to a terminfo entry

-v verbose  
-V print version  
-t print fields one per line  
-w width change output to width characters



---

**cat [options] files**

concatenate and print files

-b number lines, except for blank lines  
-n number lines  
-u do not buffer output  
-s substitute single blank line for multiple lines  
-v print non-printable characters visibly  
-t as -v and print tabs as ^I and formfeed as ^L  
-e as -v and print \$ at end of each line

**cb [options] [file]**

simple C program beautifier

-j join split lines  
-s standard C style  
-l leng split lines longer than leng

**cc [options]**

C compiler

-a insert code to count basic blocks  
-align\_block force global uninit data symbol block to be page aligned  
-Bbinding binding is static|dynamic  
-c do not link, produce .o  
-C do not remove comments with cpp  
-dalign generate double load/stores  
-dryrun show commands but do not execute  
-Dname[=def] define name to cpp  
-E run through cpp only  
-fsingle use single precision FP  
-g produce output for dbx and dbxtool  
-go produce output for adb also  
-help info  
-Ipathname Include files  
-llibrary link with library  
-Ldir directory for library search  
-M run macro preprocessor only  
-misalign allow load and store of misaligned data  
-o file output file  
-Olevel 1 postpass assembly level optimization only  
2 global optimization (default)  
3 optimize use and definition of externals  
4 trace effects of pointer assignments  
-P run cpp only  
-pic position independent code  
-PIC as -pic but with 32 bit addresses  
-pipe use pipes not intermediate files  
-Qoption p o pass option o to program p (as|cpp|inline|ld)  
-Qpath name add name to compilation search path  
-Qproduce t t is .c|.i|.o|.s  
-R merge data with text for as  
-S produce assembly file only  
-temp=dir dir for temporary files  
-time report execution times  
-Uname undefine name to cpp  
-w do not print warnings

**cd [directory]**

change working directory

directory new directory - default is home directory

**checknr [options] [files]**

check nroff and troff input files; report possible errors

-f ignore \f font changes  
-s ignore \s size changes  
-a .x1 .y1 ... add pairs of macros  
-c.x1 .... define commands otherwise undefined

**chgrp [options] group file**

change the group ownership of a file

-R Recursively descend down stated directory  
-f force - do not report errors

**chkey**

change user encryption key

**chmod [options] [mode] file**

change mode of a file

options u|g|o|a +|-|= r|w|x|s|t|X eg a+x  
u user, g group, o other, a all,  
+ add, - take away, = assign absolute  
r read, w write, x execute, s user or group set-ID,  
t sticky, X execute if directory  
mode OR of:  
4000 Set user ID  
2000 Set Group ID  
1000 Set sticky bit  
0400 Read by Owner  
0200 Write by Owner  
0100 Execute by owner  
0070 Allow read/write/execute by group  
0007 Allow read/write/execute by others  
eg 755 is rwx for owner, rx for all others

**chown [options] owner file**

change the owner of a file

-R Recursively descend down stated directory  
-f do not report errors

**chroot newroot command**

change root directory for a command

**chrtbl [file]**

generate character classification table

**clear**

clear the terminal screen or cmdtool window

**click [-y|-n]**  
enable or disable keyboard click

**clock [options]**  
display time in a window (OWV3)

-Wn/+Wn use/do not use titeline  
-D debugging  
-T test mode  
-24 use 24 hour mode if digital clock  
-analog/digital use analog/digital clock  
+date/-date do/do not show date  
-r use roman numerals in icon  
+seconds/-seconds show/do not show seconds  
-v show version number  
-TZ timezone start with different timezone  
-alarm setting setting is none|once|daily  
-alarmtime hh:mm alarm time  
-alarmcmd cmd command to run on alarm  
-hourcmd cmd command to run every hour on the hour

**cm (xview options)**

**cm\_delete [options]**

**cm\_lookup [options]**

calendar manager, appointment and resource scheduling  
delete appointments from Calendar Manager database  
look up appointments from Calendar Manager database  
(OWV3)

-c calendar name of calendar, default is your own  
-d date date in format mm/dd/yy  
-v view view is day|week|month

**cm\_insert [options]**

insert appointments into Calendar Manager database  
(OWV3)

options as for cm\_delete  
-s start start time hh:mm  
-e end end time  
-w what up to 5 lines description (use "n")

**cmap\_alloc [options]**

allocate default colormaps for non-default visuals (OWV3)

-display display:n.screen  
which X11 server to use, default is DISPLAY  
-force create a colormap even if one already  
-allscreens create for all screens on a display  
-depth n create for those visuals with depth n  
-visual class create for those visuals with class class  
-verbose print diagnostics  
-help usage

**cmap\_compact**

colormap configuration to reduce colormap flashing  
(OWV3)

**cmdtool [options][xview options]**

run a shell in an OpenWindows terminal window (OWV3)

-C console cmdtool  
-M num set log to wrap after num bytes  
-P count checkpoint log after every count editing ops  
-B style set style for bold text  
-l command pass command to shell (escape spaces)  
xview options see xview

**cmp [options] file1 file2**

compare two files

-l print the byte number (decimal) and differing  
bytes (octal) for every difference (default first)  
-s print nothing - just return codes

**col [options]**

filter reverse line feeds

-b output device cannot backspace  
-f fine - allow half line motions  
-h convert white space to tabs where possible  
-p pass escape sequences

**colcrt [options]**

filter nroff output for terminal with no overstrike

- suppress all underlining  
-2 print all half linefeeds

**colrm startcol [endcol]**

remove characters from specified columns

**comm [options] file1 file2**

select or reject lines common to two sorted files

-[1][2][3] 1 do not print lines only in file1  
2 do not print lines only in file2  
3 do not print lines common to both files

**compress [options] files**

**uncompress [-cv] files**

compress/uncompress file(s)

-c write to standard output  
-f force compression (default not to if no help)  
-v display % compression for each file  
-b bits bits is 9-16, default 16

**cp [options] files target**  
copy files

-i prompt for confirmation if overwriting  
-p preserve modification time and mode  
-r recursive copy for directories

**cpio [options]**  
copy file archives in and out

-i [bBcdfmrsStuv6] [pattern] copy in  
-o [aBcv] copy out  
-p [adlmuv] directory copy across

-a reset access times after copy  
-b reverse order of bytes and half words  
-B block 5120 bytes to record, default 512  
-c read or write headers in ASCII form  
-required to transfer devices  
-d create directories as needed  
-f copy in all files except patterns  
-l cpio -p only, link files where possible  
-m Retain file modification time  
-s swap bytes within each half-word  
-S swap half-words within each word  
-t print table of contents, do not create files  
-u copy unconditionally (normally old will not replace new)  
-v verbose, name each file as it is copied  
-6 process UNIX Version 6 files

**cpp [options] [files]**  
C language preprocessor

-B support // as a comment (C++)  
-C pass all comments  
-H print pathnames of included files  
-M generate makefile dependency list  
-p use only 8 characters for symbols  
-P do not produce line control information  
-R allow recursive macros  
-T use only 8 characters for preprocessor names  
-undef remove all predefined symbol definitions  
-Dname[=def] define name as 1 [def]  
-I dir include directory  
-Uname undefine name  
-Ydir use dir instead of /usr/include for includes

**crash [options]**  
examine system images

-d dumpfile system memory image, default /dev/mem  
-n namefile default /vmunix  
-w file write to file

**crontab [options]**  
user crontab file

file copy crontab file to admin directory  
-e username edit username's crontab file  
-r username remove username's crontab file  
-l username list username's crontab file  
file format is: min hour day mon weekday  
string min 0-59, hour 0-23, day 1-31,  
mon 1-12, weekday 0-6 0=sun, \* = all values  
or list with , string is command.

**csch [options] [argument..]**  
shell command interpreter with C like syntax

-b do not interpret subsequent arguments as options  
-c read commands from first filename argument  
-e terminate if a command returns non zero  
-f fast start - do not read .cshrc or .login  
-i forced interactive  
-n interpret input but do not execute commands  
-s take commands from standard input  
-t read and execute a single line  
-v verbose  
-x echo commands

**csplit [options] file arg1 [..argn]**  
context split a file

-s do not print size of each created file  
-k leave created files if an error occurs  
-f prefix files are called prefix00..n, default is xx00..n  
args /rexp/ create file up to line including rexp  
%rexp% skip up to line including rexp  
Inno create file from current line to Inno  
[num] repeat argument

**ctags [options] filename**  
create a tags file for ex or vi

-a append output to existing file  
-B use backward searching patterns  
-F use forward searching patterns (default)  
-t create tags for typedefs  
-u update specified files in tags file  
-v produce an index for vgrind  
-w suppress warning diagnostics  
-x produce list of object names

**ctrace [options]**

generate a C program trace

-f funs trace only functions funs  
 -v funs trace all but funs  
 -[o|x|u|e] print in octal|hex|unsigned|float  
 -l n check n statements for looping trace  
 -s suppress trace from simple assignments  
 -t n trace n variables per statement (max 20)  
 -P run C preprocessor before trace  
 -b use only basic functions  
 -p 's' change printf to s for print function  
 -r f use f instead of runtime.c

**cu [options] [destination]**

call another UNIX system

-d print diagnostics  
 destination phone no, system name or LAN address  
 -l line direct connection  
 -s speed data rate, default from /etc/uucp/Devices  
 -e force even parity  
 -h half duplex  
 -n request user prompt for phone number  
 -o force odd parity  
 -t dial an auto-answer terminal  
 commands after connection established  
 . terminate conversation  
 ! escape to a local shell  
 %cd change directory on local system  
 %take from to  
 %put from to

**cxref [options] files**

generate a C program cross reference

-c combined cross reference of all input files  
 -w num width of output (min 51)  
 -o file output to file  
 -s do not print input file names  
 -t format for 80 column output

**date [options]**

print and set the date

-u display in Greenwich Mean Time (default local)  
 yymmddhhmm yy year, mm month, dd day, hh hour, mm minute

**dbx [options]**

source level debugger

-f c estimate of number of functions is c [500]  
 -i force input terminal style  
 -l dir add dir for source file search  
 -k kernel debugging  
 -kbd debug a program that uses keyboard up/down  
 -P fd create pipeline to dbxtool process

-r execute objfile immediately  
 -s startup read initialization from startup  
 -sr tstartup read init from temp tstartup and then remove

**dc**

desk calculator (reverse polish style)

**dd [options]**

convert and copy a file

if=file input file name, default stdin  
 of=file output file name, default stdout  
 ibs=n input block size n bytes (512)  
 obs=n output block size n bytes (512)  
 bs=n input and output block size  
 cbs=n conversion buffer size  
 files=n copy and concatenate n files  
 skip=n skip n input blocks before start  
 seek=n as for skip for seek devices  
 count=n copy only n input blocks  
 conv=x x is ascii|lcase|ucase|swab|noerror|sync

**deroff [options] [files]**

remove nroff/troff, tbl and eqn constructs

files file(s) to remove from  
 -w output a word list

**devinfo**

print system device information

**devnm name**

identify device name

**df [options]**

report free disk space on file systems in 1024 byte blocks

-a report on all filesystems  
 -i report number of used/free inodes  
 -t type report on type file systems (eg nfs)

**diff [options] file1 file2**

find differences in two files or directories

-b ignore trailing blanks  
 -i ignore case  
 -t expand tabs in output  
 -w ignore all blanks  
 -e produce output suitable for ed  
 -l long format (directories only)  
 -r recursively (directories only)  
 -s report identical files (directories only)

**diff3 [options] file1 file2 file3**

three way file comparison (SYSV)

**diffmk old new marked**

mark differences between versions of a troff input file

**digestp [see mailp]**

Frontend to PostScript printer for USENET digest files (OWV3)

**dircmp [options] dir1 dir2**  
directory comparison (SYSV)

-d create list of all file differences  
-s suppress identical file messages  
-wn width of output is n (default 72)

**dis [options] file**  
COFF object code disassembler

-o print in octal  
-V print version number  
-L look up source labels (-g only)  
-d sec disassemble sec as data  
-da sec disassemble sec as data and print address  
-F func disassemble only func  
-t sec disassemble sec as text  
-l X disassemble library libX.a

**dkinfo disk**  
report information on a disk configuration**domainname [newname]**  
get or set name of current secure RPC domain**du [options] [names]**  
summarize disk usage in 1Kbyte blocks

names file or directory names to summarize  
default is current directory  
-s only print grand total of specified names  
-a generate information for each file  
default is each directory

**dump [options] fs|file**  
incremental file system dump

0-9 dump level  
a archive create contents in file archive  
b factor blocking factor  
c cartridge  
d bpi tape density  
D diskette  
f dumpfile dump to dumpfile not /dev/rmt8  
n notify to operator group  
s size size of volume  
t tracks tracks for a cartridge  
u update dump record  
v verify  
w list file systems needing backup  
W list all file systems, including w

**dumpfs**  
dump file system information**echo [args]**  
echo arguments**ed [options] [files]**  
text editor

-s suppress printing of diagnostics and some info  
-p specify a prompt string  
-x use encryption

**edquota**  
edit user quotas**eject [options] [device]**  
eject media from drive with no manual eject

-d display default device  
-f force eject if busy  
-n display nicknames  
-q is media present  
device|nickname device to eject

**env [name=value] [command]**  
print or set environment for command execution**eqn [options] file**  
typeset mathematics

-dxy set equation delimiters to x and y  
-fn change font globally to n  
-pn reduce sub and superscripts by n point sizes  
-sn change point size globally to n

**error [options] [files]**  
categorize compiler error messages

-n do not touch files, errors to stdout  
-q interactive query mode  
-v invoke vi on completion  
-t list list is suffices eg .c.y.\*  
-s print statistics

**etherfind [options]**  
find packets on Ethernet

-d print no of dropped packets  
-n do not convert address/port to names  
-p do not go promiscuous  
-r RPC mode  
-t timestamp each packet  
-u make output buffered  
-v verbose  
-x dump packet in hex

-c count      exit after count packets  
 -i interface    listen on interface (netstat)  
 -l length      limit no of bytes (with -x)  
 expression    eg dst dest, src source etc

**ex [options] file**  
 text editor

-s            suppress feedback  
 -v            invoke vi  
 -r file        recover file after system crash  
 -L            list files saved after system crash  
 -R            read only  
 -V            verbose  
 -l            set up for editing LISP programs  
 -x            use encryption  
 -c command    start by issuing command

**expand [options] [files]**

**unexpand [-a] [files]**  
 expand tab characters to space characters and vice versa

-tabstop      sets TAB as tabstop characters (default 8)  
 -tab1,tab2... set TAB at columns specified  
 -a            insert TAB for 2 or more spaces

**exportfs [options] [path]**

-a            export all in /etc/exports  
 -i            ignore options in /etc/exports  
 -u            unexport paths  
 -v            verbose  
 -o options    ro|rw=host[:host..]|anon=uid|root=host[:host..]  
               |access=client[:client..]|secure

**expr args**

evaluate arguments as an expression

**extract\_unbundled**

extract and execute unbundled product installation scripts

**extvga**

turn on the SPARCbook VGA port

**fastboot**

shutdown the operating system and reboot

**fasthalt**

shutdown the operating system and switch off

**faxp [see mailp]**

frontend to PostScript for Fax files (OWV3)

**faxtool [file]**

send Facsimile to modem port (OWV3)

**fdformat [options]**

format diskette

-b label      put MS-DOS label on disk after formatting  
 -d            install MS-DOS file system and boot sector  
 -f            do not ask for confirmation  
 -l            format a low density (720K) diskette  
 -v            verify after format

**file [options] [files]**

determine file type

-c            check magic file for format errors  
 -f names      names contains list of files to examine  
 -L            follow symbolic links  
 -m mfile      use mfile as magic file not /etc/magic

**filemgr [options][xview options]**

OpenWindows mouse-based file manager (OWV3)

-d directory    start in specified directory  
 -i num        check on files every num seconds  
 -a            check file modification times  
 xview options see xview

**filep [see mailp]**

frontend to PostScript printer for ASCII files (OWV3)

**find pathlist expr**

find files

-name pattern    true if pattern matches filename  
 -perm onum      true if permission matches onum  
 -size n[c]        true if n blocks or n characters if c specified  
 -atime n         true if accessed n days ago  
 -mtime n         true if modified n days ago  
 -ctime n         true if status changed n days ago  
 -exec cmd        true if executed cmd returns zero ,  
                   terminate with \; {} is current pathname  
 -ls              print pathname and statistics  
 -ok cmd         interactive version of exec  
 -print          print current pathname  
 -newer timefile    true if file modified more recently than timefile  
 -depth          do directory entries before directory  
 -prune          do not descend into directories  
 -cpio device     write in cpio format to device  
 -ncpio device    write in cpio -c format to device  
 -local          true if file physically on local file system  
 ( expression )    true if expression true  
 -type c         true if type of file is b block, c character,  
                   d directory, l symbolic link, p fifo, f plain  
                   file, s socket.  
 -links n        true if file has n links  
 -user name      true if file belongs to name

-nouser true if file belongs to an unknown user  
 -group name true if file belongs to group name  
 -nogroup true if file belongs to an unknown group  
 -fstype type true if filesystem file is in is of type  
 -inum n true if file has inode number n  
 -xdev do not traverse a different filesystem

an example find dir -atime +7 -exec rm {} \;  
 removes all files in dir older than a week

**finger [options] [users]**  
 display information about local and remote users

-b suppress home directory and shell in long format  
 -f suppress header  
 -h suppress .project file  
 -i idle format  
 -l long format  
 -m match only on user name  
 -p suppress .plan file  
 -q quick format output  
 -s short format  
 -w suppress full name

**fixframe**  
 convert FrameMaker 2.0 PostScript files (OWV3)

**fixinterleaf**  
 convert Interleaf PostScript files (OWV3)

**floppytool [xview options]**  
 simple floppy backup/restore (OWV3)

xview options see xview

**fmt [options] [files]**  
 simple text formatter

-c crown margin mode  
 -s split line only, do not join  
 -w width output width columns, default 72

**fold [-width] [files]**  
 fold long lines

**format [/dev/rdisk/x]**  
 format a hard disk and set partition table

**fpversion4**  
 print the SPARC FPU version

**from [options]**  
 display sender and date of mail messages (UCB)

username use usernames mailbox (default is yours)  
 -s sender only display headers from sender

**fsck [options]**  
 check and repair file systems

-b block use block as superblock (32 is alternate)  
 -w check writable file systems only  
 -y assume yes responses whatever  
 -n assume no, open file system ro  
 -c convert to dynamic table format

**fsirand [-p] special**  
 install random inode generation numbers

-p print generation numbers but do not change

**ftp [options] [hostname]**  
 file transfer program

-d enable debugging  
 -g disable filename 'globbing'  
 -i turn off interactive prompt in multiple transfers  
 -n no auto-login  
 -v show responses from remote server  
 commands lcommand run command on local machine  
 help get help  
 get remotefile localfile  
 put localfile remotefile

**fuser [options] file|resource**  
 identify processes using a file or structure

- cancel current options  
 -k send SIGKILL to each process  
 -u print user login name

**gcore [-o file] pid**  
 get core image of running process

**getopt**  
**getopts**  
 parse command options

**gprof**  
 display call-graph profile data

-a suppress statically declared functions  
 -b brief  
 -c static call graph  
 -s produce gmon.sum profile file  
 -z display routines with zero usage  
 -e|f fun display for routine fun and descendants  
 -E fun suppress display for routine fun  
 -F fun use only fun times in calculating statistics

**graph [options]**  
draw a graph

-a sp [st] supply abscissae, spacing sp, start st  
-b disconnect graph after each input label  
-c string string is default label for each point  
-g grid grid=0 no grid, 1 frame with ticks,  
2 full grid (default)  
-l label label is label for graph  
-m mode mode=0 disconnected, 1 connected lines  
-s save screen, do not erase first  
-x [l] lo [up [sp]] l=log, lo and up=limits, sp=grid spacing  
-y [l] lo [up [sp]] l=log, lo and up=limits, sp=grid spacing  
-h f f is fraction of space for height  
-w f f is fraction of space for width  
-r f f is fraction of space right before plotting  
-u f f is fraction of space up before plotting  
-t transpose x and y axes

**grep [options] expr [files]**

**egrep [options] expr [files]**

**fgrep [options] string [files]**

search a file for a pattern using limited regular expression  
search a file for a pattern using full regular expression  
search a file for a character string

-b print block numbers for found instances  
-c print only a count of lines  
-i ignore case distinction  
-h do not print filenames for multiple files  
-l list only filenames with matching lines  
-n print line numbers for found instances  
-s work silently  
-v print lines except those that contain expr  
-w file take list of expressions from file  
-x print only lines that entirely match string  
(fgrep only)

**groups [user]**

print group membership of user

**grpck**

check group database entries

**halt [options]**

stop the processor

-n do not sync  
-q quick halt  
-y halt, even from a dialup terminal

**head [-n] [file]**

display first lines of a file

-n number of lines, default 10

**hostid**

print hexadecimal host identifier

**hostname**

print system hostname

**iconedit [file] [xview options]**

create and edit images for OpenWindows icons (OWV3)

file contains image  
xview options see xview

**id**

print user and group name and ID

**indent file [options]**

indent and format a C program source file

-bap insert blank line after each procedure  
-bacc insert blank line round conditional block  
-bbb blank line before block comment  
-nbc no new line after declaration comma  
-bl reformat if (...) { with a new line  
-bs force a blank after sizeof  
-cn n is col to start comments [33]  
-cdn n is col to start declarations [as cn]  
-nncdb allow /\* comment \*/  
-nce do not force else to preceding }  
-nfc1 disable formatting of comments in col 1  
-in n is number of spaces per indent level [4]  
-ln n is max length of line [78]  
-sob remove optional blank lines  
-st pass stdin to stdout  
-troff generate troff code  
-v verbose

**indxbib file**

create an inverted index to a bibliographic database

**inline [options] files**

in-line procedure call expander

-w display warnings  
-v verbose  
-o file write to file  
-i inline read in-line code templates from inline

**install [options] files**

install files

-g group set group of installed file/directory  
-m mode set mode of installed file/directory  
-o owner if root, set owner of file/directory  
-s strip executables as copied  
-d create a directory



**intro3\_start**  
introduce the DeskTop manager (OWV3)

**iotstat [options]**  
report I/O statistics

-c report user/system/idling times  
-d report disk info  
-D more disk info  
-l report counts not rates  
-t report terminal character info  
disk specify disk  
interval [cnt] report every interval secs, print cnt reports

**ipcrm [options]**  
remove a message queue, semaphore or shared memory ID

-q msgqid remove message queue identifier  
-m shmid remove shared memory identifier  
-s semid remove semaphore identifier  
-Q msgkey remove message queue created by msgkey  
-M shmkey remove shared memory created by shmkey  
-S semkey remove semaphore created by semkey

**ipcs [options]**  
report inter-process communications facilities status

-q info about active message queues  
-m info about active shared memory segments  
-s info about active semaphores  
-b info on biggest allowable size  
-c creators login name and group  
-o outstanding usage  
-p PID info  
-t time info  
-a all options  
-C corefile corefile, default /dev/kmem  
-N namelist namelist, default /stand/unix

**join [options] file1 file2**  
relational database operator

-an additional line for each unpairable line in file n  
-e s replace empty output fields with string s  
-jn m join on mth field of file n, if no n both files  
-o list include fields specified in list, elements n.m  
-tc use c as a separator (default tab)

**keylogin**  
decrypt and store secret key

**keylogout [-f]**  
delete stored secret key

-f forget the rootkey

**kill [-signal] pid**  
terminate a process by default

-signal signal to send (default SIGTERM)  
pid process ID, or process group ID  
-l list signals

**last [options]**  
indicate last user or terminal logins

-n num limit number of entries to num  
-f file use file, default /var/adm/wtmpx

**lastcomm [options]**  
show last commands executed in reverse order

command only show specified command entries  
user only show entries for specified user  
term only show entries for specified term

**ld [options] files**  
dynamic link editor

-align datum force datum to be pagealigned  
-assert key check assertion for key  
key is definitions|nodefinitions|  
nosymbolic|pure-text  
-A incremental loading  
-Bkey key is dynamic|nosymbolic|static|symbolic  
-d force allocation of common storage  
-dc -d and copy initialized data from shared objects  
-dp force alias definition of undefined entry points  
-D n pad data segment to n (hex) bytes long  
-e entry define entry point  
-lx[v] include libx.a[v]  
-Ldir add dir to library search list  
-M produce load map  
-n text ro with data following text  
-N do not make text ro  
-o name output to file name  
-p data segment to start on page boundary  
-r generate relocation bits for another ld  
-s strip output  
-S strip output except for locals and globals  
-t trace  
-T n start text at hex address n  
-Tdata n start data at hex address n  
-u name name is an undefined symbol  
-x preserve only global symbols  
-X record local symbols  
-ysym display each file in which sym appears  
-z demand paged process

**ldd files**  
list dynamic dependencies

**ldf [fontname]**  
list and load PostScript defined NeWS font (OWV3)

**leave** **[ [+ ] hmmm ]**  
remind you when it is time to leave

+ [hh]mmm incremental time from now

**led on/off**  
turn the user LED on or off

**lex** **[ options ] [ files ]**  
lexical analysis program generator

-f fast mode, do not pack tables  
-t output to stdout [lex.yy.c]  
-v print summary of statistics

**line**  
read one line

**linkmgr** **[ options ]**  
link manager control panel (OWV3)

-t trace ToolTalk messages  
-w print all warnings on stderr  
-v print version no  
-h help

**lint** **[ options ] files**  
C program verifier

-a report assignments of longs to non long variables  
-b report break statements that are not reached  
-c complain about non-portable casts  
-h heuristic tests  
-i produce a .ln file  
-n do not check compatibility with libc  
-q do not complain about non-Sun compiler portability problems  
-u do not complain about used and not defined, or defined and not used, variables  
-v do not complain about unused function args  
-x report non-used externs  
-z do not complain about non-defined structures  
-Clib create lib-library.ln  
-Dname[=def] define name for cpp  
-ldir add dir to include search  
-llib use lib not /usr/lib/lint  
-o file output file  
-Uname undefine name

**listres** **[ options ]**  
list resources in widgets (OWV3)

-all all known objects  
-nosuper not resources inherited from superclass  
-variable use class record variable name  
-top name name is widget at top of heirarchy  
-format string string is printf style to print name, instance, class and type

**ln** **[ options ] files target**  
link files

-f no questions asked  
-s create symbolic link

**loadkeys** **[ file ]**  
**dumpkeys**  
load and dump keyboard translation tables

**logger** **[ options ]**  
add entries to the system log

-t tag mark each added line with tag  
-p priority enter message with specified priority  
-i log pid of logger process  
-f file use file as message  
message message to log

**login** **[ -p ] [ name ]**  
sign on to the system

-p preserve environment

**logname**  
get login name

**look** **[ options ] string [ file ]**  
find words in system dictionary or lines in list

file file to use [/usr/dict/words]  
-d dictionary order  
-f fold case  
-tc all chars to right of c are ignored

**lookbib**  
find references in a bibliographic database

**lorder files**  
find an ordering relation for an object library

**lp** **[ options ] [ files ]**  
**cancel** **[ options ] printers**  
send/cancel requests to the LP print service

-c make copies before printing  
-ddest dest is printer  
-m send mail on completion  
-nnum num is number of copies  
-ooption printer-dependant options  
-s suppress messages  
-t title print title on banner page  
-w write a message or send mail on completion

**lpc [command]**

line printer control program

help lists available commands

**lpq [options]**

display queue of printer jobs

-Pprinter specified printer  
 -l long format  
 +[interval] display periodically until empty (seconds)

**lpr [options]**

send a job to the printer

-Pprinter specified printer  
 -#num num copies of each file  
 -Cclass class is job classification  
 -Jjob job is job name  
 -Ttitle title is title name  
 -i[n] indent output n characters (default 8)  
 -n font n is 1-4, mount specified font  
 -wcols cols is page width (default 72)  
 -m send mail on completion  
 -r remove file on completion of spooling  
 -h do not print burst page  
 -s do not copy files  
 -p filter through pr  
 -l print control chars, no page breaks  
 -t filter through troff  
 -g files contain plot data  
 -v files contain a raster image

**lprm [options]**

remove jobs from the printer queue

-Pprinter specify printer  
 - remove all your jobs, if root all jobs  
 job job number  
 user jobs owned by user

**lpstat [options]**

print information about status of LP print service

-a [[list] info on print destinations  
 -c [[list] info on classes  
 -d print system default printer  
 -o [[list] info on output requests  
 -p [[list] status of printers  
 -r info on scheduler  
 -s status summary  
 -t all status  
 -u [[list] print status on users to default printer  
 -v [[list] print names and devices

**lptest [options]**

generate lineprinter ripple pattern

[l [c]] l is line length (default 79)  
 c is line count (default 200)

**ls [options] [names]**

list contents of a directory

-a all entries including . entries  
 -A as -a but not . or ..  
 -c use time for sort  
 -d only list name of directories  
 -f force directory interpretation  
 -F add / directory, \* executable, @ symbolic link  
 -g show group ownership in long format  
 -i list inodes  
 -l long format  
 -L list referenced file not symbolic link  
 -q show non-graphic characters as ?  
 -r reverse order  
 -R recursively down directories  
 -s list size in blocks  
 -t sort by time not name  
 -u use time of last access not modification  
 -1 print one entry per line

**lscp [options] files dest****lsrcp [options] files dest**

copy files in a Link Manager/ToolTalk safe way (OWV3)  
 remote copy files in a Link Manager/ToolTalk safe way

-p preserve time (root only) and mode  
 -r recursive, dest must be a directory  
 -L copy LM/TT objects only  
 -v/-h print version/usage

**lsmv [options] files dest****lsrm [options] files**

move files in a Link Manager/ToolTalk safe way (OWV3)  
 Remove files/directories in a Link Manager/ToolTalk safe way (OWV3)

- treat following args as filenames  
 -f force  
 -L move LM/TT objects only  
 -v/-h print version/usage

**lstar [options]**

archive files and Link Manager/ToolTalk objects

c create a new lstarfile  
 t list the tabel of contents  
 x extract  
 E do not archive other LM/TT links  
 f use next arg as lstarfile name  
 h follow symbolic links

p preserve modes  
 L do not invoke tar (must use -f)  
 R do not recurse (with -L only)  
 S only archive TT specs  
 v verbose

**lswh**

list TFS whiteout entries

**m4 [files]**

macro language processor

**mach**

display processor type

**machid**

return a true status if processor of specified type

**mail [options]**

**Mail [-deHInUV] [options]**

**Mail [-dFinUV] [options] recipient**

read mail or send mail to users

read mail

send mail

-d turn on debugging  
 -e test for presence of mail  
 -F file record mail in file  
 -H print header summary  
 -i ignore interrupts  
 -n do not use Mail.rc  
 -N do not print header summary  
 -U convert UUCP style to internet  
 -v pass -v to sendmail  
 -f file read from file [mbox]  
 -f +folder use file folder in folder dir  
 -h num num is number of network hops  
 -r address pass address to delivery software  
 -s subject set Subject header field to subject  
 -T file print contents of all ops on file  
 -u user read users's mailbox (if not ro)  
 commands help - print command summary

**mailp [options] file**

frontend to the mp PostScript pretty printer (OWV3)

-s subject use subject as new subject  
 -h no banner  
 -F print who mail is from rather than for  
 -l print 2 pages per page in landscape mode

**mailstats**

print statistics collected by sendmail

**mailtool [options][xview options]**

OpenWindows interface for the mail program (OWV3)

-Mx expert mode  
 -Mi int check for mail every int seconds  
 xview options see xview

**make [options]**

maintain, update and regenerate programs and files

-f makefile use makefile [m]Makefile  
 -d display reasons for rebuilding  
 -dd verbose display  
 -D display makefiles read  
 -DD display makefiles and hidden dependencies  
 -e environment variables override makefiles  
 -i ignore error codes returned  
 -k stop on current tree when error  
 -n print but do not execute commands  
 -p print complete macro and target descriptions  
 -P report dependencies, do not build  
 -q question mode  
 -r do not read in default makefile rules  
 -s silent mode  
 -S undo effect of -k option  
 -t touch targets but do not perform rules  
 macro=value macro definition

**makefloppybu**

make a backup to floppy

-number estimate required disks

**makeminifs [-d]**

make a copy of the minifs on floppy disk

-d delete the minifs from the hard drive

**makenetbu [options]**

make a backup over the network

system remote hostname  
 device backup device [nrst8]

**man [options] names**

display manual reference pages

-t troff pages for output  
 -M path change search path  
 -T macros use macros, default tmac.an  
 -k keyword find all entries relating to keyword  
 -f filename locate entries relating to filename

**mconnect [options] [hostname]**

connect to SMTP mail server socket

-p port specify port, default is 25  
 -r raw mode

**mesg [-n] [-y]**  
permit or deny messages

-n do not allow write messages to your terminal  
-y allow write messages to your terminal

**mkdir [-p] dirnames**  
make directories

-p make all non-existent parents first

**mkfile [options] file**  
make a file

-n create empty filename  
-v verbose

**mkfs [-N] device size [options]**  
make a file system

-N print parameters but do not make FS  
options these are in order  
size size in blocks (512 bytes)  
nsect sectors per track [32]  
ntrack tracks per cylinder [16]  
blksize 4096|8192 default is 8192  
fragsize fragment size 512-8192 [1024]  
ncpg cylinders per group [16]  
nbpi bytes per inode block [2048]  
opt t|s for time or space, default t  
apc alternates per cylinder [0]  
rot ms to service transfer complete and  
initiate new transfer [1]  
nrpos no of distinguished rotational posns [8]  
maxcontig max no of blocks before delay [1]

**mknod name b|c major minor**  
make a special file

**mkstr [-] m p f**  
create an error message by massaging C source files

- place error messages at end of specified file  
m messagefile  
p prefix for creating files  
f filenames

**modload filename[options]**  
load a kernel module

-v verbose  
-A unix\_file default /unix  
-conf confile configuration file  
-entry point entry point, default xxxinit  
-exec file execute file if successful load  
-o file linker output file

**modstat**

display status of kernel loadable modules  
**modunload -id n [option]**  
unload a module

n module id from modstat  
-exec file execute file if successful unload

**more [options]**  
**page [options]**  
browse or page through a text file

-c clear before displaying  
-d display error messages  
-f do not fold long lines  
-l do not treat FF as page break  
-s replace multiple blank lines with single  
-u suppress highlighting  
-num display num lines in each screenful  
+num start at linenum num  
+/string start 2 lines above line containing string

**mount [options]**  
**umount [options]**  
mount or unmount file systems and remote resources

-v verbose  
-p print list suitable for fstab  
-a mount all in fstab  
-f fake mtab entry but do not mount  
-n do not make mtab entry  
-t type fstype 4.2|nfs|rfs|lo|hsfs|tmp  
-r read only  
-o options file system options

**mp [options]**  
PostScript pretty printer (OWV3)

-F header with mail from, default mail for  
-PS print PostScript input as text  
-a format as a news article  
-d format as a digest  
-f format for use with a Filofax  
-l output in landscape, 2 pages per page  
-m output as a mail folder  
-o output as a normal ASCII file  
-p file use file as PostScript prologue  
-s name use name as subject for printout  
-tm output for use with Time Manager  
-ts output for use with Time/System International  
-v print version  
-? print usage

**mt [-f device] command [count]**  
magnetic tape control

eof write count EOF marks  
fsf forward space over count EOF marks

fsr	forward space count records
bsf	back space over count EOF marks
bsr	back space count records
eom	go to end of recorded data
rewind	rewind tape
offline	rewind and take tape offline
status	print status info
retension	rewind, fast forward, rewind
erase	erase the tape

**mv [options] files target**  
move files

-i	confirm before overwriting
-f	overwrite in any case

**nawk**  
pattern scanning and processing language

-f file	file is source
-F c	field separator is c
var=value	set var to value

**netstat [options]**  
show network status

-a	show state of all sockets
-i	show interface state
-m	show private buffer pool info
-n	show network addresses as numbers
-r	show routing tables
-s	show per-protocol statistics
-f inet unix	show only one family

**newaliases**  
rebuild the data base for the mail aliases file

**newfs [options] [mkfsopts] raw**  
create a new file system

-N	print out parameters only
-v	verbose
mkfsopts	-a apc, -b size, -C maxcontig, -c cpg, -d rotdelay, -f fragsize, -i bpi, -m free, -o opt, -r rpm, -s size, -t tpi, -n nrot (see mkfs)
raw	raw device

**newgroup group**  
log into a new group

**newspp [see mailp]**  
frontend to PostScript printer for USENET news articles (OWV3)

**newsserverstr [host][portno]**  
generate a string for the NEWSERVER variable (OWV3)

**nfsstat [options]**  
Network File System statistics

-c	display client configuration
-m	display stats for each NFS mounted FS
-n	display NFS info
-r	display RPC info
-s	display server info
-z	zero statistics

**nice [-inc] command**  
run a command at low priority

-inc	inc = -20 to 19, default 10, 19 is lowest. Root may use -n to increase priority.
------	--

**nl [options]**  
line numbering filter

-btype	type=a number all lines, t number lines with printable text, n no lines, pexp lines with regular expression exp
-ftype	as -b for footer
-htype	as -b for header
-vnum	num is start number, default 1
-iinc	inc is increment, default 1
-p	do not restart at page throws
-lnum	num is no of blank lines considered as 1, default 1
-ssep	sep is character to separate line number and line default is tab
-wwidth	width is no of characters for line number [6]
-nformat	format=ln left justified, rn right justified, rz right justified with zeroes
-ddelim	delim is logical page section start (default \:)

**nm [options] [files]**  
print symbol name list

-a	print all symbols
-g	print only global symbols
-n	sort numerically not alphabetically
-o	prepend file or archive element to each lin
-p	do not sort
-r	sort in reverse order
-s	sort by symbol size
-u	print only undefined symbols

**nohup command**  
run a command immune to hangups and quits

**nroff [options]**  
format documents for display or line printer

-e	produce equally spaced words
-h	use output tab characters
-i	read stdin after input files exhausted

- q invoke simultaneous input-output
- mname prepend tmac.name to input files
- nN number first page as N
- opagelist page range specifier
- raN set register a to N
- sN stop every N pages (default 1)
- Tname prepare output for device name

**nslookup [-l] [address]**  
query name servers interactively

- l use local hosts name server
- address use name server on machine with internet address

**od [options] file [offset[.b]]**  
octal dump

- a interpret bytes as chars and display by name
- b interpret bytes as unsigned octal
- c interpret bytes as unsigned chars
- d interpret shorts as unsigned decimal
- f interpret longs as fp
- h interpret shorts as hex
- i interpret shorts as signed decimal
- l interpret longs as signed decimal
- o interpret shorts as unsigned octal
- s[n] look for strings of n ASCII chars [3]
- v show all data
- w[n] display n bytes per line
- x interpret shorts as hex
- offset from beginning of file . is decimal, b is 512 byte blocks, default is octal bytes

**olwm [options]**  
OPEN LOOK window manager for OpenWindows (OWV3)

- 2d/3d use 2/3 dimensional look (default 3)
- display string use string as display, overrides DISPLAY
- f, -follow use focus-follows-mouse mode
- fn name use name font for window titles
- name rname use rname to look up resources
- parent ignore windows already on screen
- xrm rstring specify resources in rstring

**olvwm [options]**  
OPEN LOOK virtual window manager for OpenWindows (OWV3)

- 2d/3d use 2/3 dimensional look (default 3)
- display string use string as display, overrides DISPLAY
- f, -follow use focus-follows-mouse mode
- fn name use name font for window titles
- name rname use rname to look up resources
- parent ignore windows already on screen
- xrm rstring specify resources in rstring
- single manage windows for single screen only
- multi manage windows for multiple screens

**openwin [options]**  
OpenWindows startup script (OWV3)

- server name use name as server, default xnews
- noauth do not use MAGIC COOKIE

**on [options] host command**  
execute a command on a remote system

- i interactive mode
- d debug mode
- n no input

**pack, pcat, unpack files**  
compress and expand files

**pagesize**  
display size of a page of memory

**pageview [options]**  
PostScript previewer for OpenWindows (OWV3)

- mono use mono canvas
- w num width is num inches, default 8.5
- h num height is num inches, default 11
- dpi num num dpi, default 85
- mcd num colordensity, default 100
- page num start at page num
- dir name set working dir to name
- orient orient is left|right|upsidedown
- aa turn on anti-aliasing
- v version

**passwd [options] name**  
change login or NIS password and attributes

- a display name and aging info for all users
- f change the full name
- l change the local name (default)
- s change the login shell
- y change passwd, shell or full name in NIS dbase
- d [user] display name and aging for user
- e user expire password for user
- F name treat name as the password file
- n num user set maturity for users password to num days
- x num user set expiration for users password to num days

**paste [options] file1 file2**  
merge same lines of several files or subsequent lines of one file

- use instead of filename for filter/pipe to read from standard input.
- d"chars" replace newline characters in each but last file with alternate chars, default tab
- s merge subsequent lines rather than one from each file

**pax [options]**

portable archive exchange (SYSV)

-w write files out  
 -r read files in  
 -rw copy files  
 -a append to specified archive  
 -c complement pattern match sense  
 -d do not create intermediate directories  
 -i interactively rename files  
 -l link files arther than copy if possible  
 -m do not retain file modification times  
 -n if -r treat files as ordinary filenames  
 -o retain file ownership  
 -p preserve access time of input files  
 -u copy file only if newer  
 -v list files  
 -y prompt for disposition of each file  
 -bn blocking factor n bytes or nk KB or nb blocks or nm MB  
 -f archive specify name  
 -s string string is ed syntax /old/new/[gp]  
 -t device name input or output device  
 -x format format is cpio|tar

**paxcpio [options]**

copy archive files in and out (SYSV)

-o cpio out  
 -i cpio in  
 -p cpio pass  
 -a reset access times  
 -B block 5120 bytes per record  
 -c write header info in ASCII  
 -d create directories as required  
 -f copy all files except patterns  
 -l link files where possible  
 -m retain modification times  
 -r interactively rename files  
 -t print table of contents  
 -u copy files unconditionally  
 -v verbose

**perfmeter [options]**

display system performance in dials or charts (OWV3)

-a display all values simultaneously  
 -c n number of samples to cache  
 -d use metered dials  
 -g use strip charts  
 -h int set hour hand to int seconds  
 -l log samples to file  
 -m int set minute hand to int seconds  
 -n file file is for perfmeter samples  
 -name app app is application name to get resources  
 -p len page length [60]  
 -s time time is sample time in seconds  
 -t value cpu|pkts|page|swap|intr|disk|cntxt|load|colls|errs

-v show version number  
 -C chart ceiling set ceiling for chart  
 -H display horizontally  
 -L display strips in line  
 -S display charts solid filled  
 -V display vertically  
 -Wn no title line  
 +Wn with title line

**pg [options] [files]**

file perusal filter for CRTs (SYSV)

-num specify no of lines, default to fit terminal or window  
 -c clear screen at start  
 -e do not pause at each end of file  
 -f do not split lines  
 -n do not wait for newline on command  
 -p string use string as prompt - can contain %d  
 -s highlight messages  
 +num start at linenum  
 +/pattern/ start at first line containing pattern

**ping host [timeout]**

send ECHO\_REQUEST packet to network hosts

timeout seconds to wait for response (default 20)

**plot**

graphics filters for various printers

**pm**

OpenWindows Process Manager (OWV3)

**pr [options] [files]**

print files

-f use formfeed not newlines for pages  
 -m print all files simultaneously, 1 per col  
 -t do not print header/trailer  
 -h string use string in place of filename in header  
 -ln n is number of lines [66]  
 -s[c] separate cols by c not whitespace [tab]  
 -wn n is width in columns [72]  
 -n produce n column output  
 +n begin at page n

**printenv [variable]**

display environment values currently set

**printtool [xview options]**

OpenWindows tool for printing files (OWV3)

xview options see xview



**prof [options]**  
display profile data

-a report all symbols  
-l sort by symbol value  
-n sort by number of calls  
-s produce summary in mon.sum  
-z display routines with zero usage  
-v [-low[-high]] produce graphic output for plot  
low and high are percentages

**ps [options]**  
report process status

-a include processes owned by others  
-c display command name  
-C display raw CPU time  
-e display environment as well as args  
-g display all processes  
-j listing for job control information  
-k use /vmcore  
-l long listing  
-n produce numeric output  
-r only 'running' processes  
-S display accumulated time, including children  
-u user oriented output  
-U update private database  
-v describe virtual memory information  
-w used 132 col output  
-x include processes with no controlling terminal  
-tx processes for terminal /dev/tty  
num process info for pic num

**psh [files]**  
NeWS PostScript shell (OWV3)

**psps**  
NeWS process lister (OWV3)

**pstat [options]**  
print system information

-a all process slots  
-f print open file table  
-i print inode table  
-p print active process table  
-S print streams table  
-s print swap space usage info  
-T print used/free slots in system tables  
-u pid print info on process pid

**ptx [options]**  
generate a permuted index

-f fold upper and lower cases  
-t prepare output for phototypesetter  
-w n output is n characters width [72]

-g n n characters gap per line [3]  
-o only use file only for keywords  
-i ignore use file ignore for keywords to ignore  
-b break use file break for word separators  
-r leading non-blank chars are identifiers

**pwck/grpck**  
check password and group files

**pwd**  
print working directory name

**pwrman [options]**  
SPARCbook power manager

-d n seconds to disk spin down  
-s n seconds to screen off  
-o n seconds to power down  
-slow 12.5MHz mode  
-normal 25MHz mode  
-reset set factory defaults

**pwrmgr**  
SPARCbook power manager (OWV3)

**quot [options]**  
summarize file system ownership

-a report on all mounted file systems  
-c print blocks, #files, cum total  
-f no of files and space  
-h estimate no of blocks  
-n produce list of all files and owners  
-v files not accessed in 30/60/90 days

**quota [-v] [user]**  
display users disk quota and usage

-v display quota on all mounted file systems

**quotacheck [options] filesystem**  
file system quota consistency checker

-v indicate calculated quotas  
-a check files systems in mnttab  
-p run parallel passes on file systems

**quotaon [-av] [filesystem]**  
**quotaoff [-av] [filesystem]**  
**repquota [-av] [filesystem]**  
turn file system quotas on and off, summarize file quotas

-a turn on/off all file systems with quotas enabled  
-v display messages

**ranlib [-t] archives**

convert archives to random libraries

**-t** touch archive but do not modify**rash [options]**

convert a raster file to a PostScript file (OWV3)

**-2** scale by factor of 2  
**-nxm** scale by n in x, m in y  
**-s w h** scale to w wide and h high  
**-H h** scale to h high, preserves aspect ratio  
**-W w** scale to w wide, preserves aspect ratio  
**-l x y** lower left corner at x y units  
**-c x y** center at x y units  
**-R angle** angle to rotate in degrees  
**-e** output EPSF  
**-i** produce integral pixel out for input  
**-m** convert color to 8 bit grey scale  
**-n** no showpage command at end  
**-r** print in landscape mode  
**-w file** use file as PostScript wrapper

**rcp [options] from to**

remote file copy

**-p** attempt to save modes and times  
**-r** recursive (destination must be directory)

**rdate hostname**

set system date from a remote host

**rdist [options]**

remote file distribution program

**-b** binary conversion  
**-h** follow symbolic links  
**-i** ignore unresolved links  
**-n** print commands but do not execute  
**-q** quiet mode  
**-R** remove extraneous files  
**-v** verify files are up to date  
**-w** whole mode  
**-y** younger mode  
**-d macro=value** define macro  
**-c pathnames [login@]hostname[:destpath]**  
**-f distfile** use distfile as description file  
**-m host** machine to be updated

**reboot [options]**

reboot the system

**-d** dump core before reboot  
**-n** do not sync  
**-q** do not shut down running processes  
**--s** reboot to single user

**refer [options] file**

expand and insert references from a bibliographics database

**-b** bare mode  
**-e** accumulate references  
**-n** do not search the default file  
**-ar** reverse first r author names (default all)  
**-cstring** Capitalize fields with keyletters in string  
**-k** use labels instead of number references  
**-l** use labels from authors name and year  
**-p file** search file of references  
**-skeys** sort references by fields with keyletters in keys

**renice priority pid**

alter priority of running process

**repquota [options] [filesystems]**

summarize quotas for a file system

**-a** report on all file systems with quotas  
**-v** report all quotas

**restore [options] [file]**

incremental file system restore

**i** interactive - use help for help  
**r** restore entire tape  
**R** resume restoring  
**t** table of contents  
**x** extract named files  
**a file** dump toc from file not tape  
**d** debug info  
**h** extract dir not referenced files  
**m** extract by inode no  
**v** verbose  
**b factor** blocking factor  
**f file** use file not /dev/rmt?  
**s n** skip to nth file on tape

**rev [files]**

reverse order of characters in every line

**rgb [dbname]****showrgb [dbname]**

build or display the color name database (OWV3)

**rlogin [options] hostname**

remote login

**-L** run in 'litout' mode  
**-8** pass 8 bit data across net, default is 7 bit  
**-ec** use escape character c to disconnect line  
**-l user** use user as login name

**rm, rmdir [options] files**  
remove files or directories

-f do not prompt on write-protected files  
-r recursive removal  
-i interactive mode

**rpcinfo [options]**  
report RPC information

-p [host] print list of RPC registered programs

**rffbib [options]**  
format and print a bibliographic database

options as rff except -i and -q

**rpcgen**  
RPC protocol compiler

-c compile into XDR routines  
-Dname[=value] define name  
-h compile into a header file  
-I compile support for inetd  
-K secs exit if no activity after secs  
-l compile into client stubs  
-L use syslog not stderr  
-m compile into server stubs, no main  
-o file output file  
-s transport transport is upd|tcp  
-t compile into RPC dispatch table  
-T generate code for RPC dispatch tables

**rsh [options]**  
remote shell

-l user use remote user name  
-n redirect input to /dev/null  
hostname host to execute on  
command command to execute

**rup [options]**  
show host status of local machines (RPC version)

-h sort alphabetically by hostname  
-l sort by load average  
-t sort by up time

**ruptime [options]**  
show host status of local machines

-a count users idle for >1 hour  
-l sort by load average  
-r reverse sort order  
-t sort by up time  
-u sort by number of users

**rusage**  
print resource usage for a command

**rusers [options]**  
who's logged in on local machines

-a report even if no users logged on  
-h sort by host name  
-i sort by idle time  
-l long listing  
-u sort by number of users

**rwall hostnames**  
write to all users over a network

**rwho [-a]**  
who's logged in on local machines

-a all users, even if idle > 1 hour

**sccs [options]**  
front end to SCCS

-r use real user ID not effective user ID  
-dprefix define root portion of pathname for history files  
-pdir directory for history files [SCCS]

**sccs-admin [options]**  
create and administer SCCS files

-b force binary encoding  
-h check structure of existing SCCS file  
-n create new history file  
-z recompute checksum  
-auser[group] add user or group allowed to check in/out  
default is any  
-dflag delete flag from SCCS file  
-euser[group] erase user or group from authorized list  
-fflag [value] set flag to value  
-i[file] initialize history file from file  
-lrelease unlock release, a for all releases  
-m [list] insert mr numbers into file  
-rrelease specify release for current delta  
-t [file] insert or remove description file  
-y [comment] insert comment

**sccs-cdc [options] s.file**  
change the delta commentary of an SCCS delta

-r sid specify SID of delta to change  
-mmr-list specify one or more mr nos  
-y[comment] insert comment

**sccs-comb [options] s.file**  
combine SCCS deltas

-o access reconstructed file at release delta  
-s generate scripts to gather statistics  
-csid-list include specified list of deltas  
-pSID oldest SID to be preserved

**sccs-delta [options] s.file**  
make a delta to an SCCS file

-n retain the edited .g file  
-p display line by line differences  
-s silent  
-gsid-list list of deltas to omit  
-mmr-list mnr numbers  
-rsid specify version to check in  
-y[comment] insert comment

**sccs-get [options] s.file**  
retrieve a version of an SCCS file

-b create a new branch  
-e retrieve version for editing  
-g get SCCS ID only  
-k suppress expansion of ID keywords  
-m precede each line with SID  
-n precede each line with %M% and tab  
-p write text to stdout  
-s suppress stdout output  
-t retrieve most recent delta  
-[p] retrieve summary of delta table  
-a seq retrieve version corresponding to sequence  
-cdate-time retrieve latest version prior to date time  
yy[mm[dd[hh[mm[ss]]]]]  
-Gnew new is name of new version  
-isid-list list of deltas to include in retrieved version  
-rsid retrieve specified version  
-xsid-list exclude specified deltas

**sccs-help [arg]**  
get help on SCCS error or warning messages

**sccs-prs [options] s.file**  
display selected portions of an SCCS binary

-a include all deltas  
-e earlier than delta specified  
-l later than delta specified  
-cdate-time latest delta prior to date-time in format  
yy[mm[dd[hh[mm[ss]]]]]  
-dspec produce report to spec  
-rsid SID for which info required

**sccs-prt [options] s.file**  
display delta table info from an SCCS file

-a display log entries for all deltas  
-b print body of s.file  
-e everything  
-f print flags  
-i print serial nos of included, excluded and ignored deltas  
-s print only first line of delta table entries  
-t print descriptive text in s.file

-u print user/groups allowed to make changes  
-cdate-time exclude before specified time  
-rdate-time exclude newer than specified time  
-ysid exclude prior to sid

**sccs-rmdel -rsid s.file**  
remove a delta from an SCCS file

**sccs-sact s.file**  
show editing activity status for an SCCS file

**sccs-sccsdiff [options] s.file**  
compare two versions of an SCCS file

-p pipe output through pr  
-rsid specify version for comparison  
diff-options pass options to diff

**sccs-unget [options] s.file**  
undo a previous get of an SCCS file

-n retain the retrieved version  
-s suppress display of SID  
-rsid specify pending delta to abort

**sccs-val [options] s.file**  
validate an SCCS file

-s silent  
-mname compare name with %M% ID keyword  
-rsid check on specified SID  
-y type compare type with %Y%

**script [-a] filename**  
make typescript of a terminal session

-a append to filename

**sdiff [options] file1 file2**  
print file differences side by side

-w n output line n characters, default 130  
-l print only left side on identical lines  
-s do not print identical lines  
-o output user controlled merger of file1 and file2

**sed [options]**  
stream editor

-n suppress the default output  
-e script script is edit command for sed  
-f sfile take script from sfile

**sendmail [options]**

send mail over the internet

-ba Arpanet mode  
 -bd run as daemon  
 -bi initialize the alias databas  
 -bp print a summary of the mail queue  
 -bs use SMTP  
 -bt run in address test mode  
 -bv verify names only  
 -bz create the configuration freeze file  
 -Cfile use alternate configuration file  
 -dX debugging value of X  
 -Ffullname set fullname of the sender  
 -fname set name of 'from' person  
 -hN set hop count to N  
 -Mid deliver with message ID id  
 -n do not do aliasing  
 -ox value set option x to value  
 -q [time] process saved messages at intervals of time  
 xs, xm, xh, xd, xw (secs,mins,hrs, days or  
 weeks), if no time process once  
 -Rstring attempt to deliver mail with with recipient  
 containing string  
 -t read message for recipients  
 -v verbose mode

**sh [options]**

standard UNIX command interpreter

-i interactive  
 -s read commands from stdin  
 -c string read commands from string

**shelltool [options] [xview options]**

run a shell in an OpenWindows terminal window (OWV3)

-C redirect console output to this shelltool  
 -B style use style for displaying bold text  
 -l command pass command to shell  
 xview options see xview

**showmount**

show all remote mounts

**showrev [-c command]**

show machine and software revision information

**shutdown [options] time**

close down the system at a given time

-f arrange not to check file systems on reboot  
 -h execute halt  
 -k simulate shutdown  
 -n do not sync  
 -r execute reboot  
 time +n (mins) or hh:mm or now

**size [files]**

display the size of an object file

**sleep time**

suspend execution for time seconds

**snapshot [options]**

capture image and save to a file

-d dir use dir for load and save  
 -f file use file for load and save  
 -g display color using greyscale ramp  
 -l file file to view on startup  
 -n do not confirm overwrites  
 -v print version no

**soelim [files]**

resolve and eliminate .so requests from nroff or troff input

**sort [options]**

sort and/or merge files

-c check input file is sorted  
 -m merge only  
 -u unique  
 -ofile use file for output  
 -y kmem start bu using kmem KB of memory  
 -z size size is longest line  
 -T dir dir to place temporary files  
 -d dictionary order  
 -f fold lower case into upper case  
 -i ignore non-printable characters  
 -M compare as months  
 -n sort by arithmetic value  
 -r reverse comparison sense  
 -b ignore leading blanks  
 -tx use x as field separator

**sortbib**

sort a bibliographic database

**spell [options] [files]**

report spelling errors

-b check British spelling  
 -l follow chains of all included files  
 -v print all words not in list  
 -x print every plausible stem with =  
 -d hlist use hlist as hashed spelling list  
 -h spellhist place misspelled words into spellhist  
 -s hstop use hstop as hashed stop list

**spline [options]**

interpolate smooth curve

-a supply abscissas  
 -k arg use k for boundary computation  
 -n space output so n intervals  
 -p make output periodic  
 -x lo hi lo and hi are x limits

**split -n file**  
split a file into pieces

-n size of pieces, default 1000 lines

**spray [options]**  
spray packets

-c count count packets, default 100K bytes  
-d delay delay between packets in uS (0)  
-l length default 86  
-t nettype class of transport

**strings [options] file**  
find printable strings in an object file or binary

- look everywhere (default initialized data only)  
-o precede each string by its offset  
-num use num as min string length, default 4

**strip files**  
remove symbols and relocation bits from an object file

**stty [options]**  
set the options for a terminal

-a report all settings  
-g report settings formatted for stty  
speed report speed  
size report window size  
parenb/-parenb enable/disable parity  
parodd/-parodd odd, mark/even,space parity  
cs[5|6|7|8] character size  
0 hang up line  
110..38400 baud rate  
hupcl/-hupcl hang up/do not hang up on last close  
cstopb/-cstopb use 2/1 stop bits per character  
cread/-cread enable/disable receiver  
clocal/-clocal assume line with/without modem control  
ixoff/-ixoff send/do not send XON/XOFF sequences  
raw/-raw enable/disable raw input (no processing)  
sane reset to a sensible value  
rows n window size n rows  
columns n window size n columns

**su [name]**  
become super-user or another user

**sum**  
print checksum and block count of a file

**swapon [options]**  
specify additional device for swapping

-a make all devices of type swap in fstab available  
name device or file to add

**symorder [-s] orderlist file**  
rearrange a list of symbols

-s silent operation

**sync**  
update the super block

sys-config redo the system configuration

**sys-unconfig**  
undo the system configuration

**syslogd [options]**  
log system messages

-d turn on debugging  
-ffile use alternative configuration file  
-m mins interval between mark messages (20 mins)

**tabs [options]**  
set tabs on a terminal

tabspec -n or -a,-b .... default -8

**tail [options] [file]**  
deliver the last part of a file

+n [l|b|c] start n lines|blocks|chars from start  
-n [l|b|c] start n lines|blocks|chars from end  
-f follow, monitor growth  
-r reverse order

**talk username [tty]**  
talk to another user

**tapetool [xview options]**  
Read files to and from a tape drive (OWV3)

xview options see xview

**tar [options]**  
tape file archiver

c create a new tape  
r replace - write files to end of tape  
t list files on tape  
u update  
x extract  
v verbose  
w interactive  
f use next arg as device/file name  
b use next arg as blocking factor (1-20)  
B force block filling  
e exit on errors  
i ignore checksum directory errors  
F exclude SCCS files

FF	exclude SCCS, *.o, core, errs and a.out	-Em n	n pixels scrollbar margin width (4)
l	complain if cant resolve links	-En n	number of lines of text, (45)
m	do not restore modification times	-Et n	n lines between caret and top (2)
o	extract with users uid/gid	xview options	see xview
p	restore modes		
h	follow symbolic links		
n	n is 0 1 4 5 7 8 use /dev/rmtn		

**tbl [-ms] [files]**  
format tables for nroff or troff

**tcopy source [dest]**  
copy a magnetic tape

**tcov [options] files**  
construct test coverage analysis and profile

-a	display execution count for each statement
-n	display line numbers of n most frequent

**tee [options] [file]**  
copy stdin to stdout and file

-i	ignore interrupts
-a	append to file rather than overwrite

**telnet [host [port]]**  
user interface to remote system using TELNET protocol

? get help on commands

**test expr**  
condition evaluation command

-r file	true if file is readable
-w file	true if file is writable
-x file	true if file is executable
-f file	true if file is a regular file
-d file	true if file is a directory
-h file	true if file is a symbolic link
-c file	true if file is character special
-b file	true if file is block special
-p file	true if file is named pipe (FIFO)
-s file	true if size > 0
-z s1	true if length of string s1 is zero
-n s1	true if length of s1 non-zero
s1 = s2	true if strings identical
s1 != s2	true if strings not identical

**textedit [options][xview options]**  
OpenWindows Simple Text Editor (OWV3)

-Ea on off	whether adjustment makes pending-delete
-Ei on off	auto-indent, default off
-Eo on off	can Store as New File overwrite
-Er on off	read-only
-Ec N	checkpoint after c editing operations
-El n	n lines between caret and bottom (2)

**tftp [host]**  
trivial file transfer protocol program

? print command help information

**tic [options] file**  
terminfo compiler

-v[n]	verbose n is 1-10 default 1
-c	check file for errors

**time command**  
time a command

**timmanp[see mailp]**

**timesysp [see mailp]**  
frontend to PostScript printer for Time Manager files  
frontend for Time/System International files (OWV3)

**tip [options] host|number**  
connect to a remote system

-entry	use entry as speed entry
-v	display commands as executed
commands	~? gives help

**touch [options] files**  
update access and modification times of a file

-f	force touch
-c	do not create file if it did not exist

**tput [options]**  
initialize a terminal or query terminfo database (SYSV)

init	initialize according to TERM\
reset	reset terminal
longname	print terminal long name

**tr [options] string1 string2**  
translate characters

-c	complement string1
-d	delete all input characters in string1
-s	squeeze all repeated output chars in string 2 to single chars

**trace [options] command|pid**  
trace system calls and signals

-c	print summary of system call and signal counts
-t	prefix each line with time of day
-o file	output file
-p pid	attach to process pid

**troff [options] [files]**  
typeset or format documents

- a send ASCII approximation to stdout
- i read standard input after files exhausted
- q disable echo during .rd request
- t direct output to stdout not printer
- mpackage prepend tmac.package to files
- nN number first page as N
- olist page list to print
- raN set register a to N

**true, false**  
produce true or false values

**tset, reset [options]**  
establish or restore terminal characteristics

- print name of terminal (tset)
- ec set erase to c, default ^H or backspace
- ic set interrupt to c, default is ^C
- kc set line kill to c, default is ^U
- s output commands to set and export TERM

**tsort [file]**  
topological sort

**ttcp [options] files dest**

**ttcrp [options] files dest**  
copy files in a ToolTalk safe way (OWV3)  
remote copy files in a ToolTalk safe way (OWV3)

- p preserve time (root only) and mode
- r recursive, dest must be a directory
- L copy LM/TT objects only
- v/-h print version/usage

**ttmv [options] files dest**

**ttrm [options] files**  
move files in a ToolTalk safe way (OWV3)  
remove files/directories in a ToolTalk safe way (OWV3)

- treat following args as filenames
- f force
- L move LM/TT objects only
- v/-h print version/usage

**tttar [options]**  
archive files and ToolTalk objects (OWV3)

- c create a new Istarfile
- t list the table of contents
- x extract
- E do not archive other LM/TT links
- f use next arg as Istarfile name
- h follow symbolic links
- p preserve modes

- L do not invoke tar (must use -f)
- R do not recurse (with -L only)
- S only archive TT specs
- v verbose

**tty [options]**  
get the name of the terminal

- s do not print name, just give exit code

**tunefs [options]**  
tune an unmounted file system

- a max max is max no of contiguous blocks before rotational delay (default 1)
- d delay time in mS to initiate a 2nd transfer
- e num max no of blocks from a cylinder group
- m minfree % of space held back for normal users

**ul [options]**  
do underlining

- t terminal override TERM setting
- i use a separate line with '-i's

**uname [options]**  
print name of current system

- a print all information
- m print machine hardware name
- n print nodename
- r print operating system release
- s print name of operating system (default)
- v print operating system version

**unifdef [options] [files]**  
resolve and remove ifdefs from cpp input

- c complement normal operation
- l replaced lines removed with blank lines
- t plain text options
- iDname ignore but print lines with name
- iUname ignore but print lines with name

**uniq [options] [input [output]]**  
report repeated lines in a file

- u output only lines not repeated in input file
- d write one copy of just the repeated lines
- c precede with count
- n skip n fields
- +n skip n characters

**units**  
conversion program



**unix2dos [options] from to**  
convert ISO format text file to DOS format

-ascii        add carriage returns to conform to DOS  
-iso         convert ISO to DOS (default)  
-7            convert 8 bit chars to 7 bit DOS chars

**unwhiteout file**  
remove a TFS whiteout entry

**uptime**  
show how long a system has been up

**users**  
display a list of users logged in

**ustar [options]**  
process tape archives (SYSV)

-c            create archive  
-r            write names to end of archive  
-t            list names in archive  
-u            add files if do not exist or are modified  
-x            extract files  
-b            blocking factor default 1, max 20  
-f file       file to use  
-l            report if cannot resolve all links  
-m            do not restore modification times  
-o            give user/group ownership to extractor  
-v            verbose  
-w            interactive mode

**ucheck [options]**  
check uucp directories and permissions file

-v            verbose  
-xdebug       debug is 0-9(max)

**uucp [options] source dest**

**uux [options] command**  
UNIX to UNIX system copy  
UNIX to UNIX system command execution

-             make stdin go to command (uux)  
-C            force copy of local file to spool directory  
-f            do not make intermediate directories  
-ggrade      specify service grade  
-j            show uucp job ID  
-m            send mail on completion  
-nuser       notify user on remote system that file was sent  
-r            queue job but do not start transfer  
-xN          N is debug level (0-9 max)

**uencode [file] label**

**udecode [file]**  
encode a binary file or decode its ASCII representation

**uulog [options] system**  
query uucp log file

-ssys        print transfer work involving system sys  
-fssystem    tail -f of log for system

**uname [options]**  
list UUCP names of systems that can be accessed

-c            display names known to cu  
-l            display local system name

**uupick [-s system]**  
accept or reject files sent

\*             print command summary

**uusend [options] file system**  
send a file to a remote host

-f            do not make intermediate directories  
-r            queue job but do not start uucico  
-m mode      specify mode (octal)

**uustat [options]**  
uucp status inquiry and job control

-a            list all jobs in queue  
-p            execute a ps for all PIDs in lock files  
-kid          kill uucp request with job id of id  
-m            report accessibility of all machines  
-q            list jobs queued for each machine  
-rid          rejuvenate job id  
-ssystem      report status for remote system  
-uuser       report status for all user requests

**uuto [options] files dest**  
public UNIX to UNIX system file copy

-p            copy source file to spool directory  
-m            send mail when complete

**vacation [options]**  
automatically respond to incoming mail messages

-l            initialize files and start vacation  
-a alias      alias is a valid alias  
-j            do not check To: or Cc: line for recipient  
-t[N]         interval between repeat replies [default 1 week]  
              N is integer and s|m|h|d|w seconds-weeks

**vgrind [options]**  
grind nice program listings

-2            two column output  
-f            filter mode  
-n            do not make keywords boldface  
-w            TAB in 4 positions not 8  
-x            output index file in pretty format

-d file            alternative language definition file  
 -h header        header for every page  
 -llanguage      language to use  
 -sn              point size to output

**vi [options] file**  
 screen oriented editor based on ex

-t tag            edit file containing tag  
 -r file          recover file after crash  
 -l                set up for editing LISP programs  
 -L                list files saved as a result of a crash  
 -wn              set default window size to n  
 -R                read-only mode  
 -x                encryption mode  
 -c command     begin by executing command

**vipw**  
 edit the password file

**vmstat [options]**  
 report virtual memory statistics

-c                report cache flushing statistics  
 -f                report fork info  
 -i                report interrupts info  
 -s                report paging info  
 -S                report swapping info

**w [options]**  
 who is logged in and what are they doing

-h                suppress the heading  
 -s                short form output

**wait**  
 await completion of a process

**wall**  
 write to all users

**wc [options] files**  
 word count

-l                count lines  
 -w                count words  
 -c                counr characters

**what [-s] file**  
 extract SCCS version from a file

-s                stop after first occurrence of pattern

**whatis command**  
 display a one line summary about a command

**whereis command**  
 locate binary, source and manual pages for a command

**which [filename]**  
 locate a command; display pathname or alias

**who [options]**  
 who is on the system

file            use file instead of /etc/utmp  
 am i            prints who you are

**whoami**  
 display effective current username

**whodo [options]**  
 who is doing what

-h              no heading  
 -l              long format

**whois [-h host] identifier**  
 Internet user name directory service

**winsysck [options]**  
 check which window system protocols available (OWV3)

-a              continue after first protocol found  
 -v              print names on stdout  
 -display string use display string

**write user [line]**  
 write to another user

**xargs**  
 construct argument list(s) and execute command

**xauth [options]**  
 X authority file utility (OWV3)

-f authfile     authority file to use  
 -v              verbose  
 -i              ignore authority file locks  
 -b              break locks

**xclipboard [xview options]**  
 X clipboard client (OWV3)

xview options see xview

**xcolor [options]**  
 display all colors in an X window (OWV3)

-display dpy    use dpy display  
 -geometry geom use geometry geom  
 -dump           dump values to stdout

**xdm [options]**  
 X display manager (OWV3)

**xdpyinfo**  
display information utility for X (OWV3)

**xfontsel [options] [xview options]**  
X font selection utility (OWV3)

-pattern name use name as pattern to match against  
-print write specifier to stdout on close  
-sample text use text in place of default  
xview options see xview

**xhost [options]**  
server access control program for X (OWV3)

- turn access control on (default)  
+ turn access control off  
+hostname allow hostname access  
-hostname remove hostname from access list

**xinit**  
X Window System initializer (OWV3)

**xlock [options]**  
lock an X display until password is entered (OWV3)

-display dsp display to lock  
-mode x hop|life|qix|image|swarm|rotor|blank  
-delay usecs delay between batches  
-batchcount n n is number of things to do  
-nice level level is nicelevel  
-timeout secs number of seconds till password times out  
-saturation v v is saturation of color ramp (0-1)  
-font name font for prompt screen  
-fg color text on password screen to color  
-bg color background on password screen to color  
-/+mono display in monochrome  
-/+nolock draw patterns but do not lock display  
-/+allowroot allow root password to unlock  
-/+enablesaver will disable normal screen saver

**xlogo**  
display X Window System logo (OWV3)

**xlsatoms**  
list interned atoms on a server (OWV3)

**xlsclients [options]**  
list client applications running on a display (OWV3)

-display dpy display to use  
-a all  
-l long listing  
-m max no of chars per command

**xlsfonts [options]**  
server font list display for X (OWV3)

-display dpy display to use  
-l,-ll,-lll medium, long, very long listings

-m long listing also prints min and max  
-C use multiple columns  
-1 use a single column  
-w width width to print, default 79

**xlswins [options]**  
server window list display for X (OWV3)

-display dpy display to use  
-l long listing  
-indent no indent spaces per level

**xmodmap [options] [filename]**  
utility to modify keymaps in X (OWV3)

-display dpy display to use  
-help help  
-grammar help on grammar  
-verbose print logging info  
-n display what xmodmap would do  
-e expression execute expression  
-pm print current map  
-pk print current keytable  
-pp print current pointer map  
- use stdin as input file

**xnews [options]**  
window system server (OWV3)

:display listen for X11 and NeWS on display  
-auth file authorization file  
-defeatsecurity disable security  
-fp path set a default font path  
-nobanner do not display OWV3 banner

**xpr [options]**  
print an X window dump (OWV3)

-device dev dev is la100|ljet|pjet|ps  
-scale scale scale bit to grid  
-height inches max height of page  
-width inches max width of page  
-left inches left margin  
-top inches top margin  
-header string string to be printed above window  
-trailer string string to be printed below window  
-landscape landscape mode  
-portrait portrait mode  
-rv reverse video  
-compact use run-length encoding  
-psfig do not put postscript picture into center

**xprop**  
property display for X (OWV3)

-help print command line options  
-grammar help on grammar

**xrdb**

X resource database utility (OWV3)

**xrefresh**

refresh all or part of an X screen (OWV3)

-white use a white background  
 -black use a black background  
 -solid color use a background of color color  
 -root use the root window background  
 -geometry g area to refresh WxH+X+Y  
 -display dpy display to refresh

**xsend username****xget****enroll**

send, receive and set up secret mail

**xset [options]**

user preference utility for X (OWV3)

-display dpy display to use  
 b on/off bell on or off  
 c on/off keyclick  
 fp=path,... set font path  
 fp default reset font path to default  
 [+/-]fp[+/-] prepend or append font paths  
 m acc thr mouse acceleration and threshold  
 p entry col pixel color map entry and color  
 r on/off autorepeat  
 s on/off screen saver

**xsetroot [options]**

set root window parameters for X (OWV3)

-def set defaults  
 -cursor cfile mfile set cursor to cursorfile and maskfile  
 -cursor\_name c set cursor to name c  
 -bitmap file use file for background tiles  
 -mod x y x/y 1-16 to set plaid  
 -gray background gray  
 -fg color foreground color  
 -bg color background color  
 -rv exchange background and foreground  
 -display dpy display to use

**xstr [options] files**

extract strings from C programs for shared strings

-c file take C source text from file  
 -v verbose  
 -l array specify array [xstr]

**xv\_get\_sel [options]**

copy contents of a selection to standard output (OWV3)

-rank 1 is primary, 2 is secondary, 3 is clipboard  
 -t secs waits secs for response

**xwd [options]**

dump an image of an X window (OWV3)

-display dpy display to use  
 -nobdrs no border  
 -out file output file  
 -xy use xy format, default is z  
 -add value add value to every pixel  
 -frame include window manager frame

**xwininfo [options]**

window information utility for X (OWV3)

-root root window  
 -int display window IDs as integers  
 -tree display root,parent and children  
 -stats display info  
 -bits display info on raw bits  
 -events display event masks  
 -size display sizing hints  
 -wm display window manager hints  
 -frame do not ignore frames  
 -metric display mm and pixels  
 -english display in and pixels  
 -all display everything

**xwud [options]**

image displayer for X (OWV3)

-bg color if bitmap color for 0 bits  
 -display dpy display to use  
 -fewcolors use for small no of colors  
 -fg color for mono bitmap color for 1 bits  
 -geometry g geometry to use  
 -help help  
 -in file input file, default stdin  
 -new create a new colormap  
 -noclick do not terminate on window click  
 -plane no display single bit plane  
 -raw use current colors  
 -rv reverse colors  
 -std map map is RGB\_X\_MAP, X is BEST, DEFAULT or GRAY

**xview**

toolkit information for X (OWV3)

-Wx small|medium|large|extra\_large  
 -Wt fontname  
 -Ws x y width and height in pixels  
 -Wp x y initial position in pixels  
 -Wg g geometry format [WxH][+|-X+|-Y] pixels  
 -WP x y icon position in pixels  
 -Wl window title if not overwritten by app  
 +Wij-Wi come up open or iconized  
 -Wf r g b foreground color  
 -Wb r g b background color  
 -fg string foreground color  
 -bg string background color

---

-WI string icon image if not overwritten by app  
-WL string icon label if not overwritten by app  
-WT string icon font  
-Wd string string set resource with no command line equivalent  
-WH print help  
-Wr display set display

**yacc [options] grammar**  
yet another compiler-compiler

-d generate y.tab.h with define statements  
-v generate y.output  
-l generate y.tab.c with no numbered line directives  
-t set yydebug

**yes [string]**  
repeatedly output y or string

**ypcat [options] mname**

**ypmatch [options] key mname**  
print values in an NIS database  
print value of one or more keys from an NIS database

-d domain specify a domain other than the default  
-k display keys for maps with null values  
-x display map nickname table

**ypinit [options]**  
build and install an NIS database

-m local host is to be master  
-s host set up a NIS slave server database from host

**ypmake**  
rebuild NIS database

cd /var/yp; make

**yppasswd [username]**  
change your network password in the NIS database

**ypwhich [options]**  
return name of NIS server or map master

-d domain specify a domain other than the default  
-m mname find NIS server for map mname  
-x display map nickname table

**zdump [options]**  
time zone dumper

-v verbose  
-c year cut off at year  
zonenames zones to print time out

---

# INDEX

## A

a2ps 86

Account

    Demo 39

    Root 33

    Superuser 33,136

    User 33

    User ID 35

add\_clusters 227

Address

    Ethernet 145

    Internet 146

    IP 145

Adjust key 22,46

Alt Key 20

Alt-Esc-O 17

Alt-Esc-R 17,267

Applications

    Color 218

    Configuring 215

    Graphics 211,214

    Loading 212

    Monochrome 218

    OpenWindows 211

    Running 211

    SPARC 211

    SunView 211

Appointments 89

ASCII

    Fax 102,179

    Printing 136

    Terminal 175

    To PostScript 103

## B

Backlight 123

Backup

    Floppy 129,198

    minifs 198

    Network 203

Bad Blocks 262

Basic System Configuration 27

Battery

    Charger/Adaptor 15

    Changing 15,121

    Charging 15,120

    Door 13,122

    Installation 13

    Life 123,125

    Monitor 117

    Warning 119

Baud Rate 137,175

Brightness 18,123

Browse 91

Bundled Operating System 223

Buttons,Mousekey 20,22

---

## C

Cables 237

Calculator 108

Calendar Manager

    Appointments 89

    Browse Facility 91

    Customizing 94

    Printing 94

    Scheduling 92

    To Do Lists 89

    Using 88

CD-ROM 229

Centronics

    Port 140

    Pinout 236

Changing Battery Pack 15,121

CheaperNet 144

Choose 5,46

Client 142,154

Clock 107

Clusters 222

cmdtool 106

Command Tool 106

Configuring

    DeskSet Environment 109

    Disk Partitions 240

    email 189

    Ethernet 31,142

    Modem 177

    Network 142

    Printer 136

    Startup 27

    Terminal 175

    uucp 180,183

    Virtual Desktop 67

    X Terminal 177

Connectors and Pinouts 11,234

Console 116

Contrast 18

Controls 54

Copy and Paste 45,57

Copy Key 20,58

Copy Files over Network 156

cu 180

Customizing

    Calendar Manager 94

    Clusters 224

    OpenWindows Menus 111

    Operating System 221

Cut

    And Paste 45,57

    Key 20,58

## D

Demo

    Mousekey 39,40

    OpenWindows 39

    Tutorial 39

DeskSet

    Configuring 109

    Tools 62

    User Interface 38

Device Names 239

Diagnostics 259,263  
dialcodes 181  
Dialing Out 180  
Directories,Shared 163  
Disk  
    Bad Blocks 261  
    Layout 240  
    Partitions 240  
    Space 240,272  
    Spin Down 124  
    Swap Space 240,272  
Display Backlight 123  
Distributed File System 160  
Documentation 250  
Domain 32,142  
DOS 195  
Double-Select 51,56  
Drag and Drop 59

## E

Editor,Text 97  
Electronic mail 187  
email 187  
Environmental Specifications 233  
Ethernet  
    Address 32,145  
    Backing Up 203  
    Client 152  
    Configuring 142  
    Domain 32,142  
    Pinout 234

Server 153  
Transceiver 144  
    router 150  
/etc/hosts 148  
Export 161  
exportfs 162  
External  
    High Resolution Monitor 171  
    Keyboard 173  
    Mouse 172  
    Printer 134  
    VGA Monitor 168

## F

Fax  
    Numbers 101  
    Tool 100  
    Dialing 101  
    Fax Header 104  
    PostScript 102  
    Preview 105  
    Sending Faxes 102,178  
FCC  
    Class B 232  
    Emissions 232  
    Part 68 178



---

## Files

- Copying 70
- Deleting 59
- Directory 68
- Folders 68
- Naming 72
- Opening 69
- Printing 59,84

File Manager 68

File System Check 268

Filter 103

## Floppy Disk

- Format 127,128
- Density 126
- MSDOS 133
- Files 132
- Restore 131,201
- Save 129,198
- Using 126,198,201

Fn key 20

Folders 68

Fonts 215

## Format

- Floppy Disk 128
- Hard Disk 240,261

fsck 268

Function Keys 19

## H

Halt 248

Hayes Modem 177

Help 56,276

High Resolution mode 219

High Resolution monitor 174

hosts.equiv 150

Hostname 28

Hosts file 148

## I

IDPROM 211

IP Address 145

Icons 55,69

init 176

## Installing

- Applications 212

- External Devices 134

- From CD 207,212,225

- From Ethernet 205,212

- From floppy 201,212

- From tape 212

- Operating System 201,205,207

Internal Modem 178

## Internet

- Address 145

- Registering 146

---

## **K**

Key Mappings 113

Keyboard

External 173

Layout 19

Mousekey 21

Pinout 235

Killing Programs 265

## **L**

LEDs 119,232

Left Function keys 19

Loading minifs 201,206

Lock Screen 116

Login

Accounts 33

Passwords 33

Terminal 175

## **M**

Mail

Files 78

Reading 75

Remote 192

Replying 76

Responses 80

Tool 74

Writing 77

server 190

makefloppybu 199

makeminifs 198,200,205

makenetbu 204

maxusers 249

Memory Usage 272

Menu

Key 22,46

Menus 46

OpenWindows 111

Symbol 46

Utilities 116

Window 51

Workspace 48

Menus 44

minifs 198,206

Modem

Configuring 177

Dialing Out 180

Fax 177

Standards 231

Modifying Key Mappings 113

Monitor

High Resolution 171

VGA 168

Monochrome Mode 219

mount 163,229

Mouse

External 172

Pinout 235

---

## Mousekey

- Adjust 22
- Buttons 22
- Constraint 40
- Ctrl-Select 23
- Demo 40
- Menu 22,116
- Mouse Mode 23
- Normal Mode 22
- Operation 20,44
- Select 22

## MS-DOS

- Emulation 195
- Floppy Disk 133

## MS-Windows 3 195

## Multi-Browse 91

## N

### newfs 246

### NFS 143,160

### NIC 146

### NIS

- Client 142,152,154
- Description 143
- Server 142
- Setting Up 152

## Network

- Address 32,145
- Backup 203
- Configuration 31,142

## Information Service 32

### Portable 166

### Restore 205

## O

### Olvwm 63

### Off,Switching 17

### On,Switching 16

### On-line Help 41,56

### Opening System 10

### openwin 174,220

### OpenWindows

#### Customizing 111

#### Documentation 253

#### Exit 49

#### Help 41,46

#### Tutorial 41

#### V2 224

#### V3 211,224

## P

### Panic 267

### Parallel

#### Cable 238

#### Pinout 236

#### Port 135

#### Printer 134

### Partition Tables 240

### Paste Key 20,58

Password 34,36  
ping 158  
Pinout Connectors 234  
poll file 184  
PostScript  
    Display 105  
    Fax 102  
    Printing 86  
Power Management 117,124  
Power Supply 232,234  
printcap 137  
Print Tool 84  
Printer  
    Configuration 136  
    Cable 134  
Printing  
    Calendars 94  
    Files 84  
    Options 85  
Programming Software 224,226  
pstat 272  
Pushpins 52

## R

rcp 156  
Reboot 248  
Reconfiguring the kernel 249  
Refresh 116  
Remote Printer 139  
Reset System 267  
Reset Input 116

Resize  
    Corners 52  
    Windows 52  
Restore  
    from CD 208,225  
    from Floppy 131,201  
    from Network 208  
    rhosts 150  
Right Function keys 19  
rlogin 157  
root 33  
Router 150  
rsh 158,203

## S

Save Workspace 109,116  
Save and Resume  
    Disabling 247  
    Disk space 240,247  
    Enabling 248  
    Operation 16  
SCD 212  
Screen Saver 124  
Scrollbars 53  
Select 5,45  
Select key 22,45  
Sending Faxes 102,178

---

Serial  
    Cable 238  
    Pinout 235  
    Port 135,175  
    Printer 134  
Server 142,153  
Setting up email 187  
Sharing Directories 163  
Shutdown 16,248  
Slow Mode 124  
SoftPC 225  
Software  
    Adding 225  
    Removing 224  
SPARC Applications 211  
SPARC Compliance Definition 212  
Specifications 231  
Spool Directories 139  
Startup 16  
Sticky Windows 51,64  
stty 137  
su 33,136  
Sun Graphics 211,214  
SunView 211,218  
Superuser  
    Password 33  
    Root Account 33  
Swap Space  
    Running out 272  
    Adding 244,274  
Switching Off 17  
Switching On 16  
sys-config 37,147  
System  
    Halt 248  
    Reboot 248  
    Reset 248,267  
Systems File 181

**T**

TCP/IP 143  
TFTP 208  
Target,Drag and Drop 60  
Technical Reference  
    Manual 256  
    Specifications 230  
Terminal 175  
terminfo 224,226  
Text Editor 60,97  
Thinnet 144  
Time 30,107  
Time Zone 29  
ToDo lists 89  
Transceiver 143,145  
Trivial File Transfer Protocol 208  
Troubleshooting  
    Hardware 258  
    Network 159,275  
    Printer 140  
    Software 265  
Tutorial 41

---

---

## U

ttytab 176

umount 166

User

Account 33

ID 35

Utilities 116

uucp

Systems file 184

poll file 184

uupick 186

uuto 185

## V

VGA Pinout 235

VGA Monitor 168,231

Vacation 80

Virtual Desktop 63

Virtual Screen 219

Virtual Window Manager 63,215

## W

Waste-Paper Basket 71

Window

Controls 54

Select 45

Menu 51

Windows

Moving 52,65

Operation 50

Resize 52

Sticky 51,64

Windows-3 195

Workspace

Appearance 43

Menu 48

Properties 109

## X

Xdefaults 115,215,220

xfonset 217

X resources 216

X Terminal 177



SPARC book<sup>®</sup> | User Guide

TADPOLE

Tadpole Technology Inc.  
8310 Capital of Texas Highway North  
Suite 375  
Austin, TX 78731

Phone: 1-800-232-6656

Printed in the U.K.

Part Number: 980 001  
Revision 1 of January 1992