

PrecisionBook 132/180

Hardware User's Guide



431105902A

Please contact RDI Computer at:

RDI Computer Corporation
2300 Faraday Avenue
Carlsbad, CA 92008
Phone (760) 929-0992
FAX (760) 929-9702
email: info@rdi.com
<http://www.rdi.com>

For RDI Customer Service:
2308 Faraday Avenue
Carlsbad, CA 92008
7:00 AM to 6:00 PM PST
Phone 1-800-734-7030
or (760) 929-0992
FAX (760) 931-5981
email: support@rdi.com

PrecisionBook User's Guide, Copyright 1997 RDI Computer Corporation.

All rights reserved.

December 1997

RDI Part # 431105902, Revision A

Printed in the United States of America

PrecisionBook, Colorplus, Peripheral Expansion Unit, and PXU are trademarks of RDI Computer Corporation.

HP-UX and PA-RISC are trademarks or registered trademarks of the Hewlett-Packard Company. Proxima Ovation is a registered trademark of Proxima Corporation. Ethernet is a trademark of Xerox Corporation.

All other product names mentioned herein are trademarks or registered trademarks of their respective owners.

Preface	xv
Conventions in this User's Guide	xv
Procedures	xv
Notes	xv
Warnings and Cautions	xv
Keyboard Input	xvi
Screen Messages	xvi
Variables	xvii
Supplemental Documentation	xvii
Introducing PrecisionBook	1-1
Introducing PrecisionBook Components	1-1
Introducing PrecisionBook Features	1-2
Quick Start	2-1
Using PrecisionBook	3-1
Setting Up	3-1
Opening the Display Cover	3-1
Providing Power	3-3
Operating PrecisionBook	3-6
Starting PrecisionBook	3-6
Shutting PrecisionBook Down	3-9
Using Reboot	3-11
Moving PrecisionBook	3-11
Restarting PrecisionBook	3-12
Using PrecisionBook Features	3-14
Removing Hard Disk Drives	3-14
Recording with the External Microphone	3-16
Ejecting PCMCIA Cards	3-16
Terminating Devices Attached to the SCSI Port	3-16
Using an External Keyboard or Pointing Device	3-17
Using an External Display	3-17
Connecting an Ethernet Cable	3-17
Using the Serial/Parallel/AUI Port	3-18
Upgrading Memory (RAM)	3-19

Troubleshooting 4-1

Starting and Booting 4-1
Battery Operation 4-3
SCSI Port 4-4
Ethernet 4-4
AUI Port 4-5
Serial Ports 4-6
External Video Port 4-6
External Keyboard 4-7
External Mouse Port 4-7
Customer Service and Support 4-7

Low Battery Shutdown A-1

Overview A-1
 Battery Status A-2
 Duration A-2
 System Actions A-2
 Actions You can Perform A-2

External Monitor Matrix B-1

Changing Resolutions B-2

Notice Disclaimer of Warranty

RDI Computer Corporation makes no representations or warranties with respect to this manual, and shall not be liable for technical or editorial omissions made herein; nor incidental or consequential damages resulting from the furnishing, performance, or use of this manual. Further, RDI Computer Corporation reserves the right to make changes in the specifications of the product described within this manual at any time without notice and without obligation of RDI Computer Corporation to notify any person of such revision or changes.

Copyright Notice

All rights reserved. No part of this publication may be reproduced, stored in a retrieval system, or transmitted, in any form or by any means, electronic, mechanical, photocopying, recording, or otherwise, without the prior written permission of RDI Computer Corporation. No patent liability is assumed with respect to the use of the information contained herein. While every precaution has been taken in the preparation of this publication, RDI Computer Corporation assumes no responsibility for errors or omissions. Nor is any liability assumed for damages resulting from the use of the information contained herein. Further, this publication and features described herein are subject to change without notice.

FCC Compliance Statement

This equipment has been tested and found to comply with the limits for a class B digital device, pursuant to Part 15 of the FCC Rules. These limits are designed to provide reasonable protection against harmful interference when the equipment is operated in a commercial environment. This equipment generates, uses, and can radiate radio frequency energy and, if not installed and used in accordance with the instructions, may cause harmful interference to radio and television reception. However, there is no guarantee that interference will not occur in a particular installation.

Declaration of Conformity

We, RDI Computer Corporation,
2300 Faraday Avenue
Carlsbad, California USA 92008
(760) 929-0992

Declare under our sole responsibility that the
product

PrecisionBook Portable Workstation

complies with Part 15 of FCC Rules. Operation is subject to the following two conditions: 1) this device may not cause harmful interference, and 2) this device must accept any interference received, including interference that may cause undesired operation.

If this equipment does cause interference to radio and television reception, which can be determined by turning the equipment off and on, the user is encouraged to try to correct the interference by one or more of the following measures:

- Reorient or relocate the receiving antenna. Increase the separation between the equipment and receiver.
- Connect the equipment into an outlet on a circuit different from that to which the receiver is connected.
- Consult the dealer or an experienced radio/TV technician for help.

Shielded Cables

Connections between the PrecisionBook workstation and peripherals must be made using shielded cables in order to maintain compliance with FCC radio frequency emission limits.

The connection of nonshielded equipment interface cable to this equipment will invalidate the FCC Certification of this device and may cause interference levels that exceed the limits established by the FCC for this equipment. It is the responsibility of the user to obtain and use a shielded equipment interface cable with this device. If this equipment has more than one interface connector, do not leave cables connected to unused interfaces.

Changes or modifications not expressly approved by the manufacturer could void the user's authority to operate the equipment.

Modifications

Modifications to this device not approved by RDI Computer Corporation may void the authority granted to the user by the FCC to operate this equipment.

DOC Class B Notice

This digital apparatus does not exceed Class B limits for radio noise emission for a digital apparatus as set out in the Radio Interference Regulations of the Canadian Department of Communications.

Avis

Le présent appareil numérique ne met pas de bruits radioélectriques dépassant les limites applicables aux appareils numériques de la classe B prescrites dans le Règlement sur le brouillage radioélectrique édicté par le ministère des Communications du Canada.

Safety Precautions



WARNING: Hazardous voltages are present inside the PrecisionBook workstation. To reduce the risk of electrical shock and/or personal injury, follow the operating and installation instructions carefully.



WARNING: Do not attempt to recharge alkaline or other non-rechargeable batteries with the PrecisionBook workstation's AC adapter/charger. Alkaline batteries cannot be recharged. Attempting to recharge alkaline batteries may cause personal injury and/or damage to the PrecisionBook workstation.



WARNING: To prevent fire, shock hazard, or damage to the equipment, do not expose the PrecisionBook workstation to rain or moisture. Do not immerse the PrecisionBook workstation in water. If water has entered the PrecisionBook workstation cabinet, do not use the workstation until it has been inspected by an authorized RDI service representative.



WARNING: Do not dispose of PrecisionBook batteries in fire. Disposal of PrecisionBook batteries in fire may cause personal injury.



WARNING: All service and upgrades to the PrecisionBook workstation must be performed by a trained technician only. Otherwise, you may encounter personal injury and/or damage your workstation.

Mesures de Securite



ATTENTION: Il y a la presence des voltages hasardeux dedant l'ordinateur Precision Book. Pour reduire le risque de recevoir un choc electrique et/ou se blesser, il faut suivre soigneusement les instructions d'operation et d'installation.



ATTENTION: Ne pas tenter de recharger les batteries alkalines ou les batteries nonrechargeables avec l'adapteur/chargeur AC de l'ordinateur Precision Book. Les batteries alkalines ne sont pas rechargeables, et d'essayer de recharger les batteries alkalines pourrait resulter en blessure et/ou causer des degats a l'ordinateur Precision Book.



ATTENTION: Pour eviter du feu, le risque de choc, ou des degats aux equipements, ne pas exposer l'ordinateur Precision Book a la pluie ou a l'humidite. Ne pas immerger l'ordinateur Precision Book dans l'eau. S'il y a de l'eau qui est penetree dans la boite de l'ordinateur Precision Book, n'utilisez pas l'ordinateur jusqu'a ce qu'il est inspecte par RDI.



ATTENTION: Ne pas disposer au feu des batteries du Precision Book. Disposer des batteries du Precision Book au feu pourrait causer blessure.



ATTENTION: Il faut que tous les services et des augmentations de qualite a l'ordinateur Precision Book soient executes par un technicien qualifie. Autrement, on pourrait se blesser et/ou il pourrait y avoir des dommages a l'ordinateur Precision Book.

Sicherheitshinweise



WARNUNG: Beim Betrieb der PrecisionBook Workstation treten hohe Spannungen innerhalb des Gehäuses auf. Bitte befolgen Sie auf jeden Fall die Bedienungs- und Installationsanweisungen um jegliches Risiko einer Verletzung oder eines Personenschadens zu vermeiden.



WARNUNG: Versuchen Sie auf keinen Fall, Ihre PrecisionBook Workstation mit Trockenbatterien (Primärzellen) zu betreiben oder solche mit dem Netz/Ladegerät zu laden. Versuche dieser Art können Personen- oder Sachschaden zur Folge haben.



WARNUNG: Betreiben Sie Ihre PrecisionBook Workstation nicht bei feuchten oder nassen Umgebungsbedingungen. Falls Wasser oder Feuchtigkeit in das Gehäuse eingedrungen ist, sollten Sie Ihr Gerät vor Wiedereinbetriebnahme von einem qualifizierten Servicetechniker überprüfen lassen.



WARNUNG: Entsorgen Sie verbrauchte PrecisionBook Batterien nicht durch verbrennen. Es besteht Verletzungsgefahr, wenn PrecisionBook Batterien ins Feuer geworfen werden.



WARNUNG: Alle Reparatur und Aufrüstungsarbeiten am PrecisionBook müssen von besonders geschultem Personal ausgeführt werden, andernfalls besteht Verletzungsgefahr und/oder Ihre Workstation kann beschädigt werden.

Important Safety Instructions

The following instructions pertain to the risk of fire, electric shock or bodily injury. Please read all of these instructions carefully.

1. Save these instructions for later use.
2. Follow all of the instructions and warnings marked on this workstation or included in this manual.
3. Do not use this workstation in unstable or unsupported conditions.
4. The workstation may fall, causing serious damage to the workstation and others around.
5. Slots and openings in the cabinet are for ventilation. To ensure reliable operation of the workstation, and to protect it from overheating, these openings must not be blocked or covered. Don't use this workstation on a bed, sofa, rug or other similar surface. This workstation should never be placed near an oven, a radiator, or heat register. This workstation should not be placed in a built-in installation unless proper ventilation is provided.
6. Never push objects of any kind into the workstation cabinet openings as they may touch dangerous voltage points or short out parts that could result in a fire or electrical shock. Keep liquids of any kind away from the workstation.
7. This workstation should only be connected to the AC power source indicated on your workstation system's information label. If you are not sure of the type of AC power available, consult your dealer or local power company. Only connect this workstation to a power outlet matching the power requirements of this workstation.
8. Do not allow anything to rest on the power cord. Do not locate this workstation where people will walk on the cord.
9. If you have to use an extension cord with this workstation, make sure that the total amperage rating of all equipment plugged into it does not exceed the amperage rating of the extension cord. Also, make sure that the total of all workstations plugged into the main AC power outlet does not exceed 15 amps.
10. Unplug your workstation from the main electrical power outlet before cleaning. Do not use liquid cleaners or aerosol cleaners. Use a damp cloth for cleaning.
11. Do not use this workstation near water.

INFORMATIONS IMPORTANTES DE SECURITE

Les instructions suivantes se rapportent au risque du feu, du choc électrique, et de la blessure. Veuillez lire soigneusement tous ces instructions.

1. Garder ces instructions
2. Suivre tous les instructions et avis marques sur cet ordinateur ou notes dans ce manuel.
3. Ne pas utiliser cet ordinateur dans les conditions instables ou non soutenues.
4. L'ordinateur pourrait tomber, de cette façon causant du dommage sérieux à l'ordinateur et aux autres présents.

5. Il y a des fentes et des ouvertures dans la boîte de l'ordinateur pour la ventilation. Pour insurer l'opération fiable de l'ordinateur, et pour le protéger de surchauffer, il faut que ces ouvertures ne soient pas bloquées ou couvertes. Ne pas utiliser cet ordinateur sur un lit, un canapé, un petit tapis ou autre surface comparable. Il faut jamais mettre l'ordinateur près d'un four, d'un radiateur, ou d'un appareil de chauffage. Il faut pas mettre cet ordinateur dans une installation encastrée à moins qu'on fournisse de la ventilation adéquate.
6. Ne jamais mettre des objets dans les ouvertures de la boîte de l'ordinateur parce qu'ils pourraient toucher des points de voltages dangereux ou court-circuiter certaines parties, résultant au feu ou au choc électrique. Garder que toujours il n'y a pas de liquides près de l'ordinateur.
7. Il faut que cet ordinateur soit connecté uniquement à la source de courant AC qui est indiquée sur l'étiquette d'information de l'ordinateur. Si vous n'êtes pas sûr du type de la source de courant AC, il faut consulter avec votre fournisseur ou votre agence d'électricité. Connecter cet ordinateur uniquement à une prise de courant qui remplit les conditions d'électricité de cet ordinateur.
8. Ne rien laisser appuyer sur le câble électrique. Ne pas situer cet ordinateur ou on marchera sur le câble.
9. S'il faut utiliser un câble de prolongation avec cet ordinateur, il faut que l'ampérage de tout ce qui est connecté au câble n'exécède pas l'ampérage du câble de prolongation. En plus, il faut que l'ampérage totale de tous les ordinateurs connectés à la conduite maîtresse AC n'exécède pas 15 ampères.
10. Avant de nettoyer l'ordinateur, il faut le débrancher de la conduite maîtresse. Ne pas utiliser des nettoyants liquides ou aérosols. Utiliser une toile humide pour nettoyer.
11. Ne pas utiliser cet ordinateur près de l'eau.

Battery Warning Instruction



WARNING: *Danger of explosion if battery is incorrectly replaced. Replace only with the same or equipment type recommended by the manufacturer. Dispose of used batteries according to the manufacturer's instructions.*



ATTENTION: *Il y a danger d'explosion s'il y a remplacement incorrect de la batterie. Remplacer uniquement avec une batterie de même type ou d'un type recommandé par le constructeur. Mettre au rebut les batteries usagées conformément aux instructions du fabricant.*



VORSICHT: *Explosionsgefahr bei unsachgemäßem Austausch der Batterie. Ersatz nur durch denselben oder einen vom Hersteller empfohlenen ähnlichen Typ. Entsorgung gebrauchter Batterien nach Angaben des Herstellers.*

Wichtige Sicherheitsvorschriften. Unbedingt beachten.

Die nachfolgenden Anweisungen betreffen die Gefahr von Verletzungen durch elektrische Spannung, Feuer und mechanische Einwirkung. Bitte lesen sie diese Anweisungen sorgfältig.

1. Heben Sie diese Anweisungen für den späteren Gebrauch auf.
2. Beachten Sie alle Hinweise, die am Gerät selbst angebracht oder in den zugehörigen Handbüchern vermerkt sind.
3. Stellen Sie das Gerät an einem sicheren, stabilen Arbeitsplatz auf.

4. Die Workstation kann herunterfallen, was ernsthafte Verletzungen von Anwesenden oder starke Schäden am Gerät selbst verursachen kann.
5. Am Gerät angebrachte Öffnungen (Schlitze und sonstige Öffnungen) dienen der Belüftung des Gerätes. Um ein zuverlässiges Arbeiten des Gerätes zu gewährleisten und um Überhitzung zu vermeiden, müssen diese Öffnungen unbedingt freigehalten werden. Betreiben Sie das Gerät nie auf Betten, Sofas oder anderen, weichen Unterlagen.
6. Stecken Sie keine Gegenstände (Schraubenzieher, Büroklammern, etc.) in die Öffnungen. Sie würden damit Kurzschlüsse herbeiführen, die zur Zerstörung des Gerätes führen, sich der Gefahr eines Stromschlages aussetzen oder das Gerät in Brand setzen.
7. Das Gerät darf nur an vorschriftsmässige Steckdosen mit der auf dem Gerät angegebenen Netzspannung angeschlossen werden. Wenn Sie nicht sicher sind, welche Netzspannung richtig ist, wenden Sie sich an den Lieferanten des Gerätes oder an das zuständige Elektrizitätswerk.. Bitte nur an genügend stark abgesicherte Steckdosen anschliessen, die der Leistungsaufnahme des Gerätes entsprechen.
8. Auf das Netzanschlusskabel dürfen keine Gegenstände gestellt werden.
9. Legen Sie das Netzkabel so, dass niemand darauftreten oder darüber stolpern kann.
10. Wenn Sie Verlängerungskabel benutzen, müssen Sie sicher sein, dass die gesamte Leistungsaufnahme nicht grösser ist, als das Verlängerungskabel zulässt. Der gesamte Stromverbrauch aller angeschlossenen Geräte darf nicht mehr als 15A betragen.
11. Wenn Sie das Gerät reinigen, muss das Netzkabel aus der Steckdose gezogen werden.

Wartung der Workstation

Wenn Ihre Workstation nicht ordnungsgemäss arbeitet, dürfen Sie nur die Einstellungen vornehmen, die im Handbuch genannt werden. Andere Einstellungen oder Veränderungen können den Rechner beschädigen oder zerstören. Umfangreiche und kostspielige Reparaturen würden notwendig werden, um das Gerät wieder betriebsfähig zu machen.

Ziehen Sie den Netzstecker aus der Steckdose und verständigen Sie den zuständigen Kundendienst bei folgenden Störungen:

1. Netzkabel ist defekt oder stark abgenutzt.
2. Flüssigkeit ist in das Gerät gelangt.
3. Das Gerät war Regen oder Leitungswasser ausgesetzt.
4. Das Gerät ist heruntergefallen oder das Gehäuse ist beschädigt.
5. Das Gerät arbeitet nicht mehr richtig.

Achtung!

Wenn Sie das Gerät öffnen müssen (Abnahme der verschraubten Haube), ist unbedingt folgendes zu beachten:

1. Das Netzkabel muss aus der Steckdose gezogen werden und zwar bevor Sie das Gerät öffnen.
2. Die Haube muss wieder montiert und verschraubt werden. Erst dann darf das Netzkabel wieder eingesteckt werden.

**Warranty Policy
Terms and Conditions**

RDI Computer Corporation (hereafter "RDI") warrants its products to perform in accordance with published specifications at the time of shipment. This warranty insures that all RDI products are free from defects in material and workmanship when used under the condition described below:

RDI's products, including the PrecisionBook, UltraBook, PowerScreen, PXU (Peripheral Expansion Unit), and MAX are designed for commercial use and not for use in "rugged" or harsh environments. Using the product in an environment considered by RDI as "non-commercial" and/or outside the environmental specifications, invalidates the product warranty. If in any doubt, contact RDI Customer Service at (800) 734-7030 or (760) 929-0992 for further clarification.

Warranty Period

Every RDI product is covered by a one year warranty starting from the original date of shipment from RDI. Extended warranties for additional years may be purchased as an option. (See Extended Warranty Program section)

Coverage and Limitations

If in RDI's opinion the product malfunctions at anytime during the stated warranty period, RDI will cover all defects in material and workmanship in the product. Coverage under this policy shall not include:

- Any product not distributed by RDI or an Authorized RDI dealer.
- Any product in which the serial number has been defaced, modified, or removed.
- Inspection and testing by RDI resulting in no defects found.
- Removal and maintenance of accessories, attachments, machines, or other devices (RDI and non-RDI) not covered by this agreement.
- Internal peripherals (i.e. hard disk) and options (i.e. memory) not supplied by RDI.
- Repair, maintenance and adjustment of RDI product required due to, but not limited to, neglect, misuse (including repair or maintenance by parties other than RDI or its authorized representatives), abuse, usage not in accordance with product specifications and instructions, accident, unauthorized alterations, repairs or modifications, damage caused by internal and/or external peripherals and options not supplied by RDI, improper environment (including lightning, static electricity, fire, or extreme temperatures), or acts of God.
- Service necessitated to comply with requirements of regulations of any Governmental body or agency arising after the date of purchase.
- Any software component of any product.
- Data recovery due to hard disk drive failure or motherboard failure.

Limitation of Implied Warranties

All implied warranties, including warranties of merchantability and fitness for a particular purpose, are limited in duration to the length of the specific product warranty. RDI, at its sole discretion, may replace the product in whole or in part with comparable equipment and may use re-manufactured and refurbished parts and modules in performing service. Replacement parts and modules shall become the end-user's property; the replaced parts shall become the property of RDI. RDI shall have no obligation to return replaced parts. In no event shall RDI be liable for any delay in rendering service under this warranty. RDI's maximum liability under this warranty shall be limited to the replacement portion of the product under dispute with comparable equipment.

Exclusion of Damages

RDI's liability for any defective product is limited to the repair or replacement of the product at its option. RDI shall have no liability or responsibility to the end-user or any other person or entity with respect to any liability for damage to other property, including software, caused by any defects in the product, damages based upon inconvenience, loss of use of the product, loss in time, loss of data, loss of business, commercial loss, or any other damages, whether incidental, consequential or otherwise. In no event shall RDI be liable for loss of profits or any indirect, special, or consequential damages arising out of any breach of this warranty policy. State laws vary the end-user's rights under this warranty policy.

Warranty Service

Products requiring repair must be shipped prepaid to a RDI repair facility. A Return Material Authorization (RMA) number must be issued by RDI Customer Service prior to any warranty return shipment. The product to be serviced must be accompanied by your assigned RMA number, dated proof of purchase, your name, address, and description of the problem as well as all interconnecting cables, cords, and supplements originally supplied with the product. All non-RDI equipment, accessories, attachments, modifications, programs, data and storage media must be removed from the product before it is delivered for service. RDI shall not be responsible for items that are not removed.

If you have any questions, or require an RMA number, please contact RDI Customer Service at: Phone: (800) 734-7030 or (760) 929-0992, Fax: (760) 931-5981 or Email: support@rdi.com.

Extended Warranty Program

RDI Computer Corporation offers extended warranties for the PrecisionBook, PowerScreen, PXU and MAX products for subsequent years after the initial one year warranty has expired. End-users are offered the option to purchase an extended warranty at time of purchase of their system or anytime thereafter. When an RDI product is under its original warranty, the end-user may purchase an extended warranty to commence from the date the original warranty expires. When the RDI product is beyond the original warranty period, end-users wishing to begin an extended warranty program must send the RDI system to the RDI Customer Service Department for a Serviceability Inspection (SI). The end-user will be responsible for all shipping charges. The inspection will be performed at no charge. Should a system not pass the SI, the customer will be contacted to authorize the repairs and will be invoiced at Time and Materials charges before commencing the extended warranty program.

Extended Warranty Period

RDI offers second and third year warranty options. The extended warranty covers repair and service charges for one or two 12-month periods from either the time of purchase of the extended warranty or the date the original warranty expires (where an end-user purchases the service contract at the time of system purchase or during the initial 12 month warranty period). The purchase of the second year warranty is required prior to the purchase of the third year extended warranty.

Placing Orders

Extended warranties may be purchased at the time the system order is placed, during the warranty period, or after the initial warranty expires. To place an order for an extended warranty, please fill out the Extended Warranty Order Form attached to this document and include your purchase order or check -made payable to RDI Computer Corporation. If you have any questions, please contact RDI Sales at (800) 734-5483 or Fax (760) 931-1063 or Customer Service at (800) 734-7030 or Fax to (760) 931-5981 or email: support@rdi.com.

Time and Materials Service

For end-users who do not choose the extended warranty option, RDI Customer Service provides time and materials repairs. The hourly labor rate is \$125 per hour and a minimum two hour charge is assessed for any time and materials repairs. Charges thereafter are assessed at half-hour intervals. Time and materials repairs occur on a best effort basis. Turn-around time for time and materials repairs is based on material availability.

Notes

P

Preface

Preface

Welcome to the PrecisionBook User's Guide. This manual contains valuable information about using your new PrecisionBook. The Preface describes:

- Conventions used in this guide.
- Supplemental documentation.

Conventions in this User's Guide

The following conventions are used in this user's guide:

Procedures

Procedures are numbered.

Example:

1. Turn on your workstation.

Notes

Notes precede information that requires special attention.

Example:

Note:

For your convenience, you can use your PrecisionBook on-board LCD or attach an external monitor.

Warnings and Cautions

Information of a hazardous nature is shown as indented text preceded by .

Warnings are in italics to highlight conditions of potential personal injury. Cautions point out possible equipment damage.

Example:



Warning: *Disconnect all AC power and remove the battery prior to performing any cleaning and maintenance. Personal injury and equipment damage could result if a power source is connected to the PrecisionBook during cleaning or maintenance.*

Warnings are in italics to highlight conditions of potential personal injury. Cautions point out possible equipment damage.

Keyboard Input

Keyboard input appears in **boldfaced** type.

Screen Messages

Screen messages appear in Courier type within a box.

Example:

After the PrecisionBook passes its self-test, the following initial message appears:

```

Firmware Version x.x
Duplex Console IO Dependent Code (IODC) revision x
Memory Test/Initialization Completed

-----
(c) Copyright 1995-1998, Hewlett-Packard Company, All rights reserved
-----

Processor  Speed      State      Coprocessor State      Cache Size
-----  -----  -----  -----  -----
x          xxxMHz    Active    Functional    xxKB

Available memory (bytes):  xxxxxxxxxx
Good memory required (bytes): xxxxxxxxxx

Primary boot path:  SE SCSI.x.x
Alternate boot path: SE SCSI.x.x
Console path:      GRAPHICS(x)
Keyboard path:     PS2

System is 700 Series.
```

Variables

Variables appear as an italicized *x*. For example, the *x*'s in the preceding screen are variables because the values shown will vary from system to system.

Supplemental Documentation

This User's Guide is an informational guide taken from the PrecisionBook System Reference Set. Additional information can be found in that reference set.

For more information about the HP-UX operating system, refer to the HP-UX installation guides found in the PrecisionBook System Reference Set. For more information about the PrecisionBook than is contained in this user's guide, refer to the RDI Documentation CD that accompanies your PrecisionBook or contact your authorized PrecisionBook representative.

Notes

1

Introducing PrecisionBook

Introduction

Before using your PrecisionBook portable workstation, it is important to review the following topics covered in Chapter 1:

- Unpacking your components.
- A list of PrecisionBook features.

Introducing PrecisionBook Components

As you unpack your PrecisionBook, check the shipping carton and the components inside it for damage. Figure 1-1 shows the items you should find in your shipping carton.

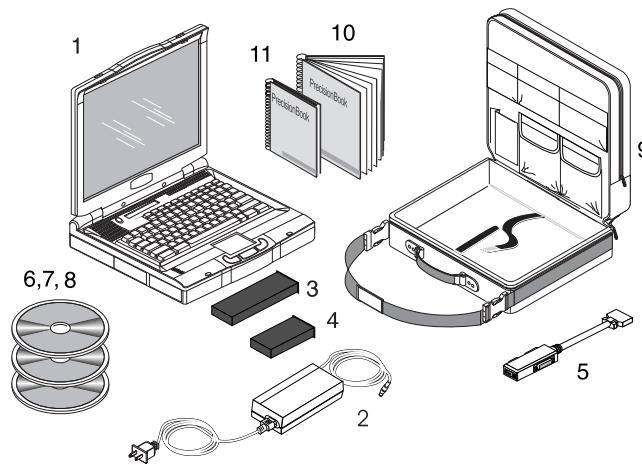

Figure 1-1 PrecisionBook Components

If either the shipping carton is damaged or the PrecisionBook components are missing or damaged, please contact your shipper or dealer immediately.

Each carton contains:

1. PrecisionBook portable workstation
2. AC adapter and power cord
3. Rechargeable battery pack
4. Removable hard drive
5. I/O break-out cable
6. HP-UX 10.2 or higher compact disc
7. RDI Software compact disc
8. RDI Documentation compact disc
9. Carrying case
10. PrecisionBook User's Guide (this manual)
11. Operating System Installation Guide

Optional PrecisionBook Accessories:

- Optional external floppy drive (not shown)
- Optional CD-ROM drive (not shown)
- Optional fax/modem PCMCIA card (not shown)

Introducing PrecisionBook Features

Your new PrecisionBook includes the following features:

- A PA-RISC 7300LC motherboard, running at 132 or 180 MHz (depending on your configuration) with a 64 KB data cache and a 64 KB instruction cache
- 32 MB of high-speed RAM with ECC, upgradeable to 512 MB

- One of the following active matrix color LCD displays
 - 12.1 inch with 1024 x 768 resolution, supporting a 16M-color palette and 256 shades of gray
 - 14.1 inch with 1024 x 768 resolution, supporting a 16M-color palette and 256 shades of gray
- A full-size 97-key PS/2 keyboard with 12 function keys
- An integrated three-button GlidePoint touchpad
- A status LCD that displays system status icons
- Up to three removable hard disk drives (HDD's).

Note:

Depending on your configuration, you may have two removable HDDs and one removable battery.

- Audio input and output jacks that support:
 - Headphones, for private listening
 - Line Out, for connection to external stereophonic devices
 - Line In, for connection to external audio sources
 - Microphone, for connection to an external microphone
- Internal monophonic speaker
- PCMCIA Type III slot (also supports type I and type II cards)
- A connector for a low-profile external floppy disk drive
- A 50-pin Fast SCSI 2 port

- A keyboard port for connecting an external PS/2 keyboard
- A mouse port for connecting an external PS/2 mouse
- A port for connecting an AC power adapter
- A docking port so that you can connect your PrecisionBook to an expansion dock
- A VGA DB 15 port for attaching an optional external monitor
- A standard RJ45 port that supports 10-Base T twisted pair Ethernet connections
- A single 50-pin port and I/O break-out cable (supplied) that supports two serial, one parallel, and one AUI connector for connecting industry-standard serial and parallel Centronics devices

For more information about the features listed here, see Chapter 2 of the *PrecisionBook Hardware Reference Guide*.

For tips on using the features listed here, see Chapter 3 of this guide.

2 Quick Start

Quick-start provides a brief, pictorial introduction to get you started. Refer to Chapter 3, PrecisionBook Operation, for more detailed information.

For more detailed hardware descriptions and theories of operation, see the PrecisionBook Hardware Reference Guide.

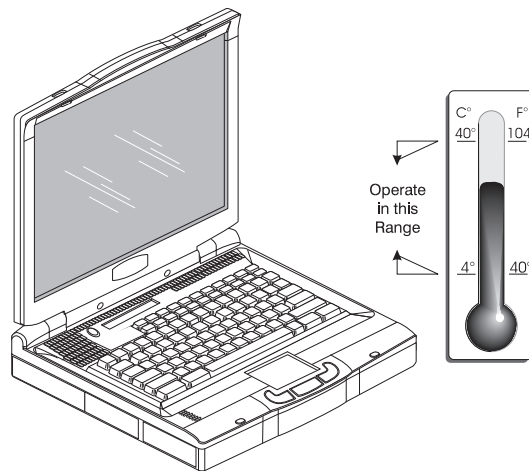

Quick Start

Step 1 Check the ambient air temperature.



Caution: If your workstation has been exposed to temperature extremes (variations of more than 10 degrees of temperature or 10 percentage points of humidity), you will need to stabilize the workstation's temperature. Let your PrecisionBook adjust to room temperature before proceeding. As shown in Step 1, the operating temperature range is 4° to 40° C.

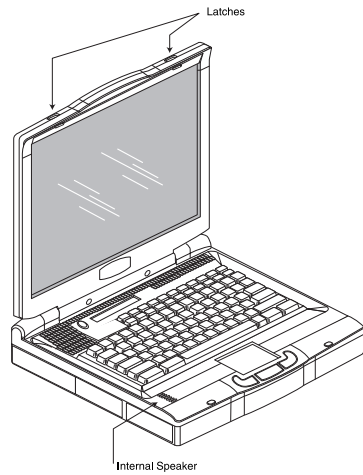

Step 2 Open the PrecisionBook

Open the PrecisionBook display screen by sliding the display cover latches as shown in Step 2.

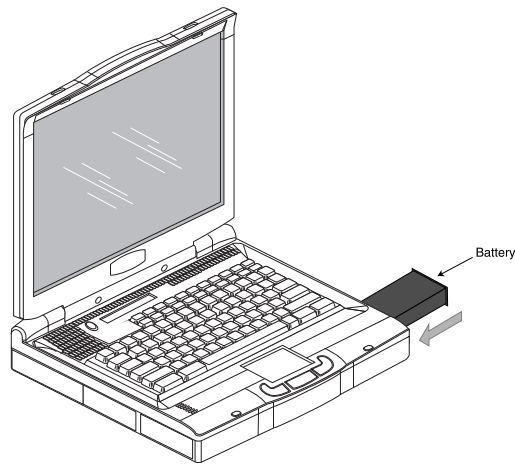

Step 3 Install the Lithium-Ion batteries.

If you have turned on the PrecisionBook, power down the PrecisionBook and turn it off. Insert the battery pack in the bay. Push in until you hear it click into place. The battery bay is located on the same side of the unit as the PCMCIA and SCSI ports.



Warning: Never use alkaline batteries with the PrecisionBook. Alkaline batteries cannot be recharged and may explode if you try to recharge them.



Warnung: Versuchen sie auf keinen Fall, Ihre PrecisionBook workstation mit Trockenbatterien (Primarzellen) zu betreiben oder solche mit dem Netz/Ladegerat zu laden. Versuche dieser Art können Personen-oder Sachschaden zur Folge Haben.

Quick Start

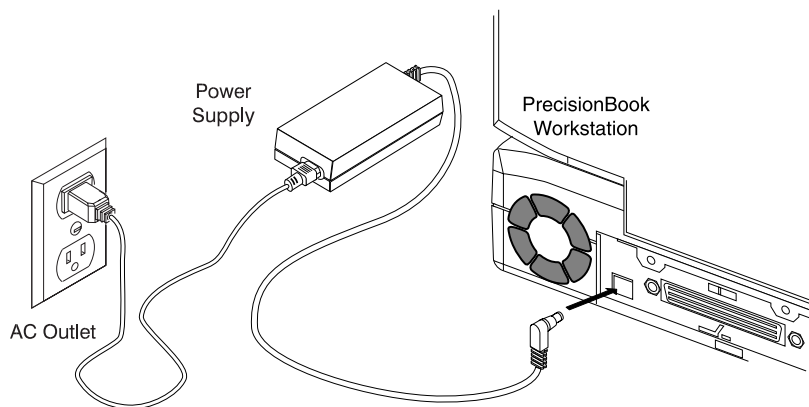

Step 4 Plug in the AC power adapter.

Step 4 shows connecting the AC adapter for AC power operation. The battery need not be installed for AC operation.

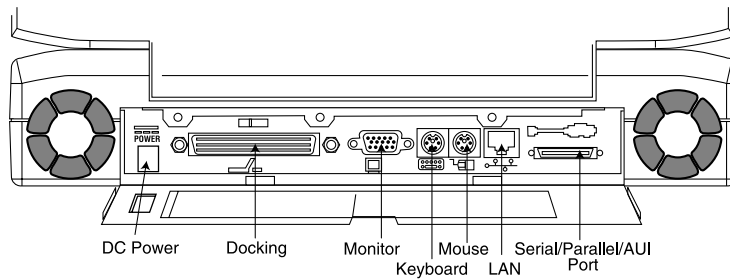

Step 5 Open the PrecisionBook back and side panels.

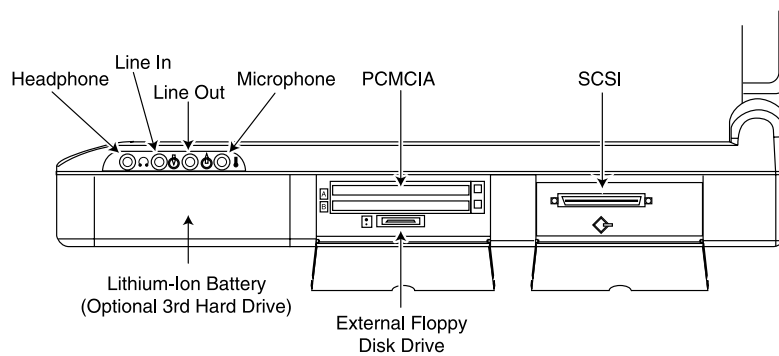

Step 5 continued.

Step 5 shows the back panel. Although the PrecisionBook is completely self-contained, the back panel provides access for connecting the workstation to a wide variety of external devices, including Ethernet networks. Lower the cover plate and connect the

external device to the appropriate connector. For serial or parallel connections, use the supplied I/O break-out cable. For Fast SCSI 2 connections, use the SCSI port shown in Step 5. See Chapter 3 for more on connections.

Turn on all external devices, then turn on your PrecisionBook, as shown in Step 6.

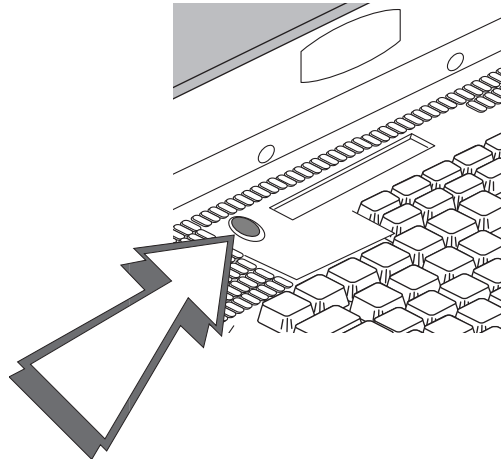

Quick Start

Step 6 Turn the power switch on.

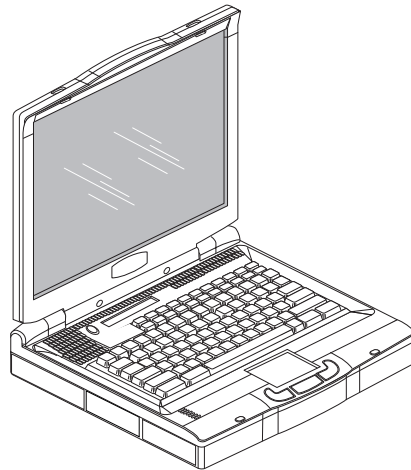

Step 7 View the initial system screens.

After the self-tests have been successfully completed, an initial message appears. Then system messages scroll as the operating system loads.

If the system is booted with the factory software load intact, the Common Desktop Environment (CDE) login banner appears. Login at this time and follow the prompts.

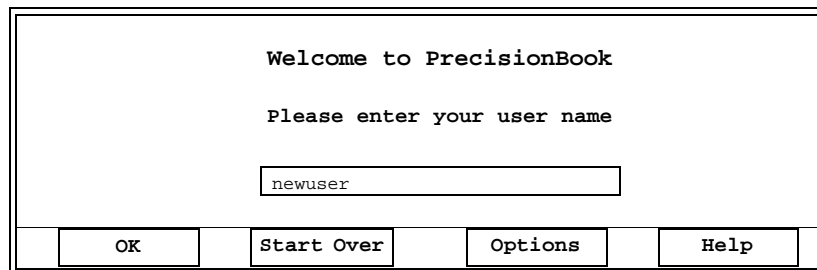

Step 8 Log on to the system.

Note:

If the factory software load is altered, the CDE login banner may not appear. If this is the case, after the last system message, the screen displays the login and password prompts and you can log into the system. At this point, you may start your application.

Quick Start

Notes

3 Using PrecisionBook

This chapter provides valuable information on using the PrecisionBook. A few minutes spent here will ensure you get the most out of PrecisionBook.

Setting Up

The PrecisionBook is designed to provide many years of error-free operation. The workstation will last longer by following these guidelines:

- Position the PrecisionBook so you can easily access the connectors on the back and side panels.
- The area should be free of obstructions, allowing you to open the display screen completely, without hindrance.
- Adequate ventilation is required for the PrecisionBook. Do not cover or block the ventilation slots or fans on the case.



Caution: Never spray or directly apply strong cleaners or solvents directly to the PrecisionBook case or LCD.

Opening the Display Cover

The display is located on the inside of the top cover. When you are not using the PrecisionBook, the cover should remain closed. This protects the display against damage.

To open the display cover:

1. Slide the two display cover latches outward to the left and right sides of the unit (see Figure 3-1).
2. Gently raise the cover to its full, upright position.

You can adjust the screen up to 27 degrees from vertical for a better viewing angle. Use the backlight intensity keys on the integral keyboard to adjust the brightness of the backlight to achieve the best viewing conditions.

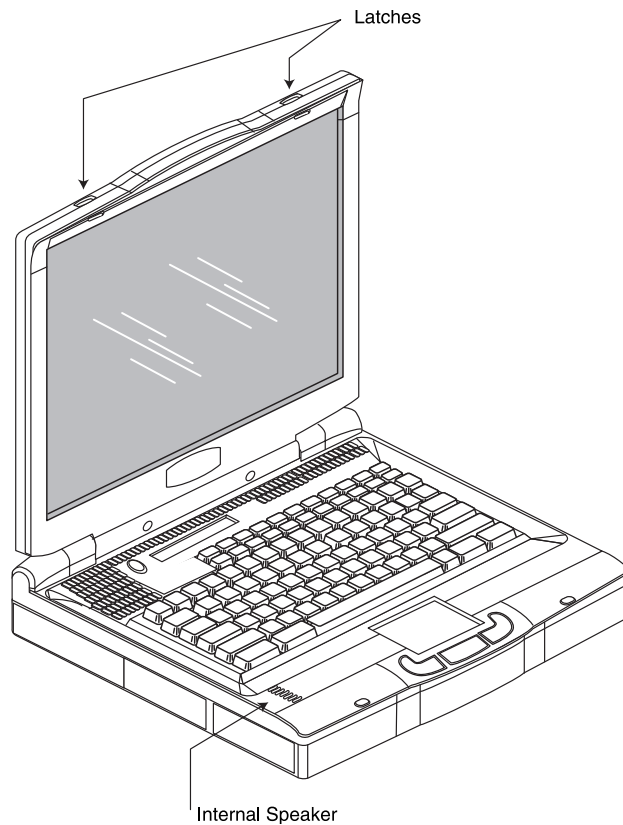

Figure 3-1 Raising the Display Cover

To close the display cover:

1. Gently pull the cover forward and down.
2. Carefully press the back of the cover down toward the keyboard until both case latches “click” into their closed positions.

At this point, you can connect the PrecisionBook to your selected optional equipment and power up the workstation.

Providing Power

The PrecisionBook can operate from a rechargeable Lithium-Ion battery pack or an AC power adapter.

See Using Batteries for installation instructions.

Using an AC adapter

You may use AC power to operate the PrecisionBook. The battery need not be installed for AC operation.

To power the PrecisionBook from AC power:

1. Locate the PrecisionBook near a grounded AC outlet.
2. Make sure the outlet is not controlled by a wall switch, which can cause the workstation to be turned off accidentally.



Warning: *Use only the supplied AC adapter with the PrecisionBook. Do not use an AC adapter designed for use with another product.*

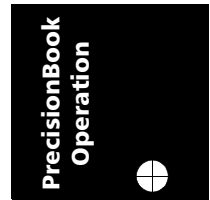

3. Plug the connector from the AC adapter into the power input socket on the PrecisionBook. Then plug the AC cable plug into a nearby AC outlet.

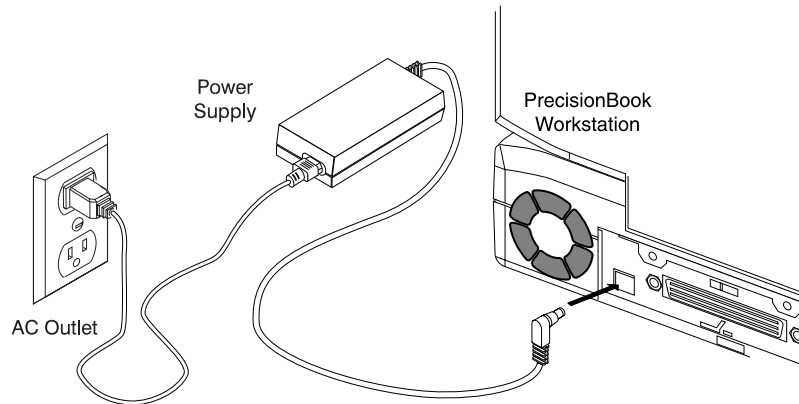

Figure 3-2 Connecting to AC Power

4. After installing a new battery pack, use the AC adapter to recharge the battery pack. It takes about three hours to recharge a new battery when the PrecisionBook is turned off. After fully charging the battery pack, you can operate the PrecisionBook for about one hour on battery power, depending on your configuration and application.

Note:

The AC adapter can be plugged into a 100 – 240-Volt source at 50 – 60 Hz. The AC adapter will automatically adjust to the AC input voltage and frequency. The only requirement is that the AC adapter/charger must correctly fit the AC outlet.

Using Batteries

Note:

The PrecisionBook includes three device bays, one of which may be occupied by either a removable battery pack or an optional hard disk drive. If the device bay on the right side

of the unit (the same side as the PCMCIA and SCSI ports) is occupied by an optional hard disk drive, you will not be able to run PrecisionBook using onboard battery power.

To install the battery pack:

1. If you have turned on the PrecisionBook, power down the PrecisionBook and turn it off.
2. Insert the battery pack in the bay. Push in until you hear it click into place. The battery bay is located in the same side of the unit as the PCMCIA and SCSI ports.

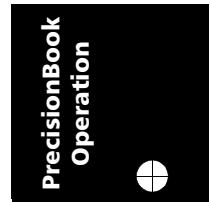
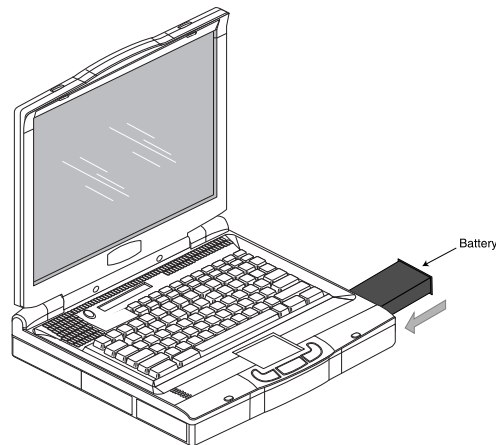

Figure 3-3 Installing the Battery Pack

To remove the battery pack:

1. Power down the PrecisionBook and turn it off.
2. Turn the PrecisionBook over.
3. Press the battery latch (see Figure 3-4) away from the battery.

4. Grasp the battery's faceplate and gently pull it out of the battery bay.

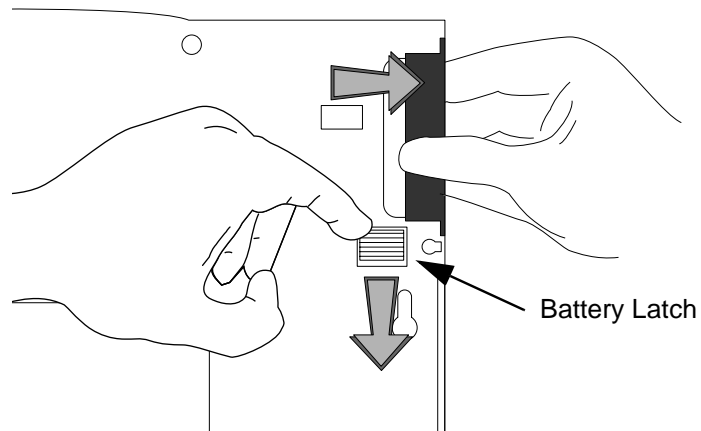

Figure 3-4 Removing the Battery Pack

Operating PrecisionBook

Before turning on your PrecisionBook workstation and beginning your day, you will need to prepare the workstation. This includes acclimating the workstation to its environment and starting its operating system.

Starting PrecisionBook

To ensure long life and ease of operation, you need to follow a few general guidelines when starting up and shutting down your PrecisionBook workstation.



Warning: *Failure to start up and shut down the PrecisionBook workstation properly can damage important system files and may affect your product warranty.*

To start the PrecisionBook:

1. Make sure the PrecisionBook is at room temperature before powering up. This is particularly important when the workstation is brought from a very cold environment into a warm room. In such cases, moisture can condense on and inside the workstation and cause problems. Allow at least two hours for the PrecisionBook's temperature to stabilize after bringing it from a very cold or very warm environment before proceeding.
2. If you will be using PrecisionBook on an Ethernet network, contact the person responsible for your computer network (the Network Administrator) to obtain the following applicable information:
 - A host name that does not duplicate an existing host name
 - An IP address
 - An optional Network Information Service (NIS) domain name
 - A user account and password if using NIS
 - An Ethernet cable
3. Connect the Ethernet cable to the 10-Base T Ethernet connector.
4. Make sure that all cables attached to peripherals (such as printers, mouse, monitor, or SCSI devices) are securely plugged into the correct connectors. Pay particular attention to the two serial ports: check that the device intended for attachment to port 1 is not accidentally plugged into port 2.
5. Make certain that each device is plugged into an AC outlet or power strip. External peripherals such as monitors and SCSI devices require their own power cords.

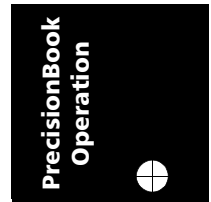

6. If SCSI devices are connected to the PrecisionBook, install an active SCSI bus terminator on the last SCSI device only; otherwise you may experience erratic performance.

Note:

For more information on termination and configuration devices, refer to Terminating Devices Attached to the SCSI Port later in this chapter and your SCSI device documentation.



Caution: External devices can have a maximum SCSI bus length of 2 meters and must have active termination installed at the last device on the external bus.

7. Power up peripherals such as SCSI devices or a monitor before powering-up the PrecisionBook. Refer to the instructions that came with the peripherals for more information about starting order.
8. Use the PrecisionBook's power switch to turn on your workstation.

The PrecisionBook begins its self-test diagnostics and starts to boot. It is normal for the screen to be blank for up to 20 seconds before displaying the following initial message:

```

Firmware Version x.x

Duplex Console IO Dependent Code (IODC) revision x

Memory Test/Initialization Completed

-----
(c) Copyright 1995-1998, Hewlett-Packard Company, All rights reserved
-----

Processor  Speed      State      Coprocessor State      Cache Size
-----
x          xxxMHz    Active    Functional              xxKB

Available memory (bytes):  xxxxxxxxxx
Good memory required (bytes): xxxxxxxxxx

Primary boot path:  SE SCSI.x.x
Alternate boot path: SE SCSI.x.x
Console path:      GRAPHICS(x)
Keyboard path:     PS2

System is 700 Series.
```

PrecisionBook
Operation

A variety of system messages will be displayed on the screen as HP-UX continues to boot. After the last system message, the system will display the CDE Console Login and Password banner.

If the PrecisionBook does not respond when the power switch is turned on, refer to Chapter 4 of this guide for troubleshooting suggestions.

Note: After powering-up the PrecisionBook for the first time, you are ready to configure your workstation.

Shutting PrecisionBook Down

Before turning off your PrecisionBook for the day, you will need to shut down its operating system and power down any peripheral devices you have connected to the PrecisionBook.



Warning: *DO NOT simply unplug the workstation to turn the power off, as this can damage or destroy critical operating system files and data. Failing to properly shut down the operating system and workstation can also damage attached peripheral devices as well as the workstation itself.*

To shut down the operating system:

1. Save your work.
2. Log out from the system by typing:

logout

and pressing Enter.

3. At the “hostname console login” prompt, log in as:

root

4. Enter the root password at the “Password” prompt, and press Enter.

5. For PrecisionBook Systems running HP-UX 10.2, type the following command:

/usr/sbin/reboot -h

and press Enter.

Note:

For additional information on shutting down the system under HP-UX 10.2, see the HP-UX manual page for shutdown, init, and halt.

6. Power-down all peripherals, such as SCSI devices or a monitor first.
7. Turn off the PrecisionBook.

Note:

The hard disk automatically parks the heads and spins down.

To perform an orderly shutdown using the power switch:

Press the power switch and wait for the system message directing you to turn off the power.

The PrecisionBook will then shut off power to the unit. You may now unplug the unit from its power source.

Using Reboot

In some cases, the system may not accept the “shutdown” command. If this occurs, type `/usr/sbin/reboot -h` (for HP-UX 10.2) and press Enter. The program responds by displaying the following series of messages:

```
Shutdown at xx:xx (in x minutes)

** FINAL System shutdown message from xxxxxx
System shutdown time has arrived

sync'ing disks (xx buffers to flush):xx
0 buffers not flushed
0 buffers still dirty

System has halted
OK to turn off power or reset system
UNLESS "WAIT for UPS to turn off power" message was printed above
```

PrecisionBook
Operation



Caution: DO NOT turn off power to the PrecisionBook until you see the “OK to turn off or reset system...” message shown above. Turning the power off before seeing this message could damage important system files, peripheral devices, or the workstation. It may take one to two minutes for this message to appear.

Moving PrecisionBook

1. If you want to move the PrecisionBook after powering down, disconnect all cables and connectors (including the AC adapter cable) from the PrecisionBook.

2. Close and latch the rear panel cover, then fold the display cover down and close and latch the case.
3. You can now move the PrecisionBook to a new location, reconnect, and restart.

Note:

If you move the PrecisionBook to a different network, or move to standalone configuration, you should use the SAM tool to setup new network or stand alone configurations. Doing this lets you select the correct configuration for the new network and will enable the system to boot correctly after being moved.

Restarting PrecisionBook

Restarting a PrecisionBook that has been halted and powered down is a simple procedure.

To restart the PrecisionBook:

1. Verify that cables from all connected peripheral devices, such as SCSI devices or an external monitor, are connected to the appropriate connectors on the back of the PrecisionBook.
2. Power-up the peripherals before powering-up the PrecisionBook (see the peripheral manuals for more information).
3. Turn on the PrecisionBook.

The PrecisionBook begins its self-test diagnostics and starts to boot. It is normal for the screen to be blank for up to 20 seconds before displaying the following initial message:

```

Firmware Version x.x

Duplex Console IO Dependent Code (IODC) revision x

Memory Test/Initialization Completed

-----
(c) Copyright 1995-1998, Hewlett-Packard Company, All rights reserved
-----

Processor  Speed      State      Coprocessor State      Cache Size
-----
x          xxxMHz    Active    Functional              xxKB

Available memory (bytes):  xxxxxxxxxx
Good memory required (bytes): xxxxxxxxxx

Primary boot path:  SE SCSI.x.x
Alternate boot path: SE SCSI.x.x
Console path:      GRAPHICS(x)
Keyboard path:     PS2

System is 700 Series.
```

PrecisionBook
Operation

Various system messages will appear on the screen during the boot process. After the last system message, the screen will display the “host name console login” prompt, where “host name” is the one you entered when you configured the PrecisionBook.

4. Enter your user ID at the “hostname console login” prompt and press Enter.
5. Enter your password at the “Password” prompt and press Enter.

Note:

Depending on your configuration and applications, the Lithium-Ion battery pack provides up to one hour of continuous-use operation from a full charge.

When the battery reaches the end of its charge a PowerTool icon will pop up onto the screen. The icon will be flashing, indicating low battery power (if CDE is running). If CDE is not running, a “low battery” message appears on the Console and the PrecisionBook

beeps. You must switch to AC power or power-down the workstation. For more on the low battery shutdown procedure, refer to Appendix A of this guide, Low Battery Shutdown.

Note:

When powering down the workstation, follow the shut-down procedures found in Shutting PrecisionBook Down. Otherwise, files on the system may become corrupt.



Caution: Do not allow the PrecisionBook's batteries to fully discharge while operating the workstation from battery power. Corrupt files may result.

The battery pack can be recharged from AC power in about 3 hours. The system's Lithium-Ion battery charges whether the system is on or off, provided the unit is connected to an external power source.

Using PrecisionBook Features

This section contains operational tips and other information unique to the PrecisionBook feature set. For more detailed information on a listed feature, refer to Chapter 2 of the Hardware Reference Guide.

Removing Hard Disk Drives

The PrecisionBook comes equipped with up to three removable hard disk drives.

To remove a hard disk drive:

1. Power down the PrecisionBook and turn it off.
2. Turn the PrecisionBook over.
3. Press the hard disk drive latch (see Figure 3-5) away from the drive.

4. Grasp the drive's faceplate and gently pull it out of the drive bay.

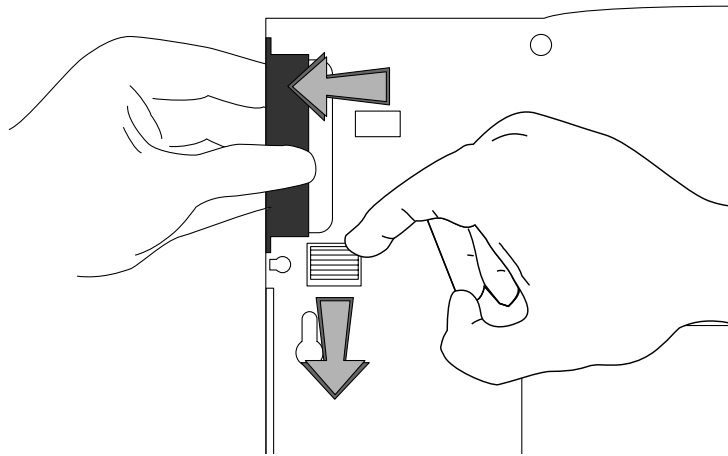

Figure 3-5 Removing the Hard Disk Drive

To insert a hard disk drive:

1. Insert the drive into the drive bay.

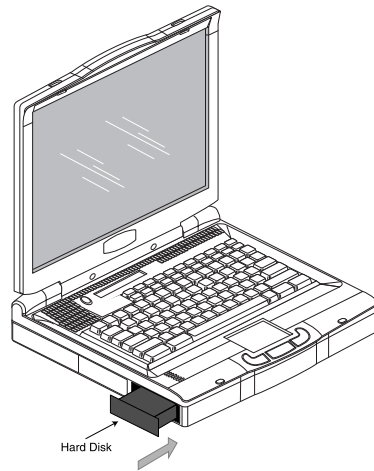
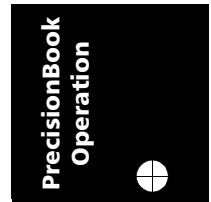

Figure 3-6 Installing a Hard Disk Drive



2. Press gently but firmly until you hear the drive click into place.

Recording with the External Microphone

To use the microphone to record:

1. Make sure the recording source is sufficiently close to the microphone (1 to 2 ft).
2. Unplug any external audio input devices connected to the PrecisionBook.

Note:

If you connect an external audio input device, other than the PrecisionBook's external microphone, the microphone jack is disabled until you remove the external audio input device.

Ejecting PCMCIA Cards

The eject buttons work each slot independently. To eject a card, push the applicable PCMCIA eject button. The card will release and slide out.

Terminating Devices Attached to the SCSI Port

Due to termination requirements and bus loading, follow the configuration guidelines discussed in this section.

Daisy-chained SCSI devices-termination must occur after the last SCSI device. Check the SCSI device manual to see if the device is to be powered on before the restarting of the PrecisionBook.

External SCSI devices-use an active terminator with the appropriate connector.

SCSI Bus-External devices can have a maximum SCSI bus length of 2 meters and must have active termination installed at the last device on the external bus.

Using an External Keyboard or Pointing Device

- An external keyboard and the on-board keyboard can both be used for typing, along with a single pointing device (mouse or touchpad).
- The integrated touchpad remains enabled whether or not an external pointing device is used.

Using an External Display

To connect an external monitor:

1. Start with the PrecisionBook properly shut down and powered off.
2. To connect an external monitor, connect it directly to the PrecisionBook's external video port. Refer to Appendix B, External Monitor Matrix, for more information.

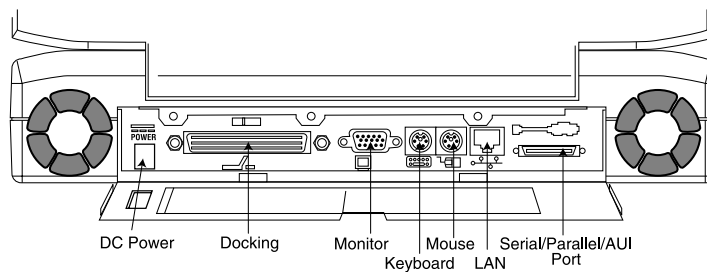

Figure 3-7 PrecisionBook Rear Access port

Connecting an Ethernet Cable

To connect the PrecisionBook to an Ethernet network:

1. With the PrecisionBook turned off, set it on a work surface near the Ethernet twisted-pair cable or transceiver/AUI.

2. Attach a twisted-pair cable to the PrecisionBook's 10-Base T Ethernet (LAN) connector (see Figure 3-7).

Using the Serial/Parallel/AUI Port

The PrecisionBook back panel has a 50-pin connector housing two serial ports, a parallel port, and an AUI (see Figure 3-8).

To access serial and parallel ports:

1. Turn off the PrecisionBook and the serial devices you will be connecting to it.
2. Connect the male end of the I/O break-out cable to the PrecisionBook's 50-pin serial/parallel/AUI connector on the rear panel (see Figure 3-7).
3. The other end of the I/O break-out cable has two 9-pin connectors for attaching serial devices a 25-pin parallel connector for attaching parallel devices, and a 15-pin AUI connector for attaching other workstation devices (see Figure 3-8). Make the appropriate serial and parallel connections.

For a list of pin assignments for the PrecisionBook connector and I/O break-out cable, refer to the PrecisionBook Hardware Reference Guide, Appendix B.

The two serial ports are designated Serial 1 and Serial 2 on the I/O break-out cable. When you connect serial devices to the I/O break-out cable, make sure the device intended for Serial port 1 is plugged into the port 1 connector and the device for Serial port 2 is plugged into the port 2 connector.

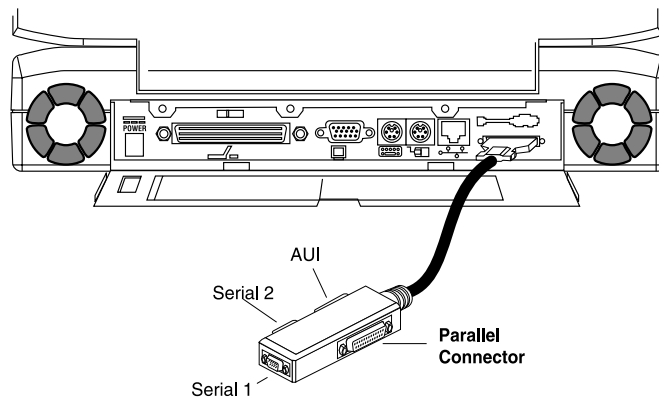

Figure 3-8 Serial Parallel and AUI Connections

PrecisionBook
Operation

Upgrading Memory (RAM)

PrecisionBook can support up to 512 MB of random access memory (RAM). To upgrade RAM, add or replace RAM modules, available from RDI or authorized dealers in 32MB, 128MB, and 256MB sizes.



Warning: *Be sure to wear a grounding strap whenever you upgrade system memory. If you do not, you may damage the PrecisionBook and risk voiding your warranty.*

To add a new memory module:

1. Power down the PrecisionBook and turn it off.
2. Disconnect the workstation from its external power source and remove the workstation's onboard battery.

3. Turn the PrecisionBook over.

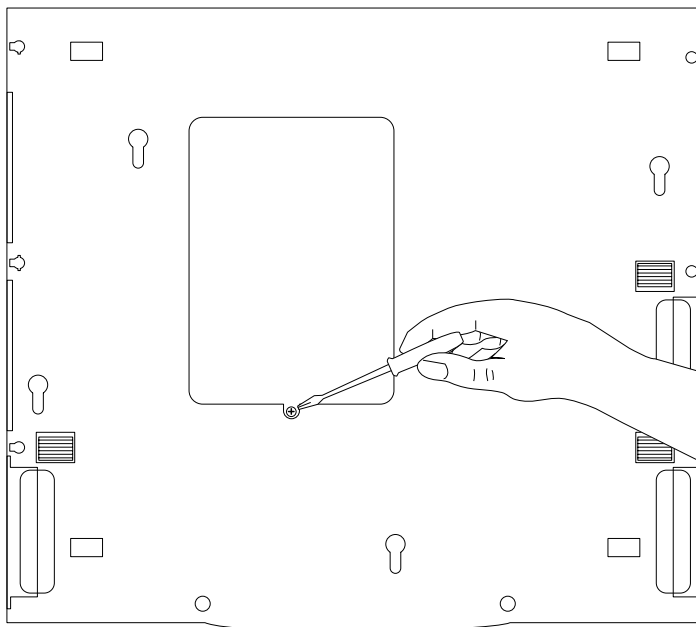

Figure 3-9 Removing the Memory Cover

4. Using a small Phillips screwdriver, remove the memory access cover as shown in Figure 3-9.

5. Insert the new module in the available slot (see Figure 3-10) pressing gently but firmly until it is fully seated in the connector and the locking plastic standoffs.

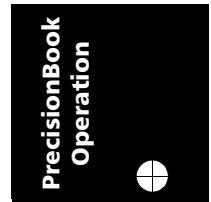
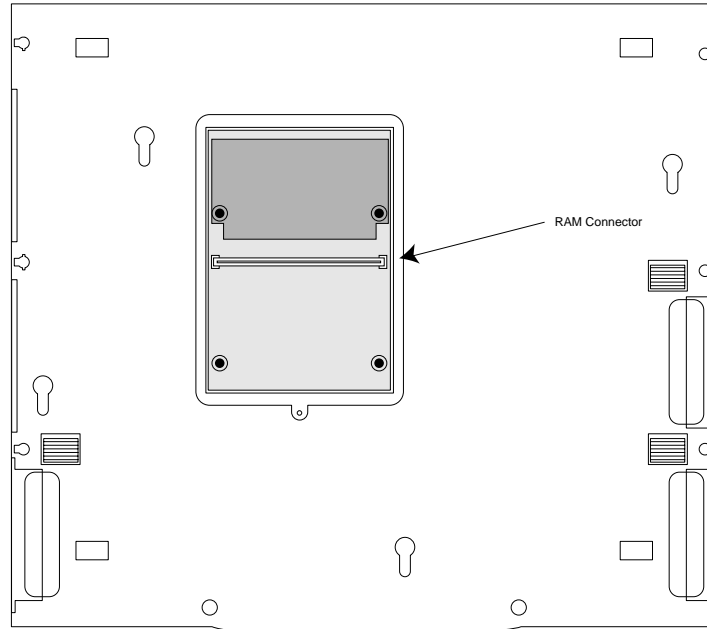

Figure 3-10 Installing the Memory Module

6. Using a small Phillips screwdriver, replace the memory access cover screw.

To replace or upgrade existing memory modules:

1. Power down the PrecisionBook and turn it off.
2. Disconnect the workstation from its external power source and remove the workstation's onboard battery.

3. Turn the PrecisionBook over.

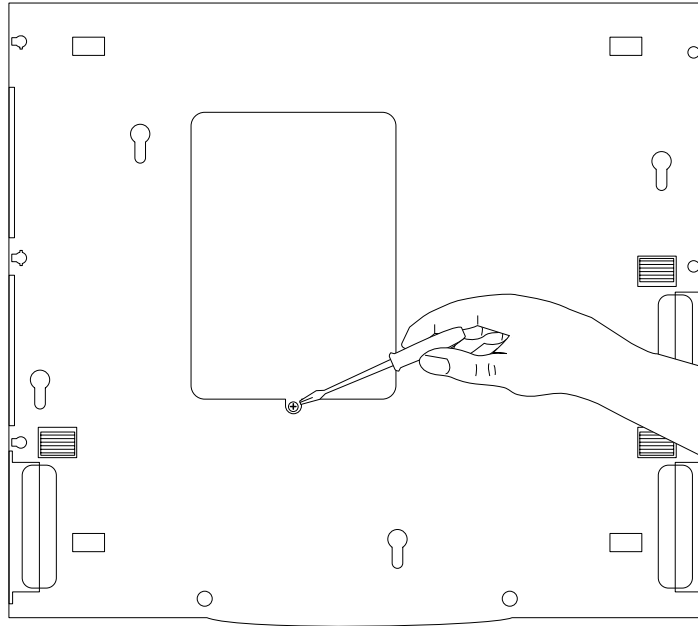

Figure 3-11 Removing the Memory Cover

4. Using a small Phillips screwdriver, remove the memory access cover as shown in Figure 3-11.
5. Using a small flat-tip screw driver, pry gently upward against the outer edges of the memory module you want to remove, as shown in the following illustrations.



Caution: You must not place the screw driver against any printed circuits, individual memory module chips, or points of contact other than those shown in the following illustrations. Prying at other points of contact may damage your memory modules or the main system board and void your warranty with RDI.

If you have two memory modules installed, use this procedure to remove them.

- a. Using a small flat-tip screw driver, pry gently upward against the outer edges of the system's secondary main memory module, as shown in Figure 3-12.

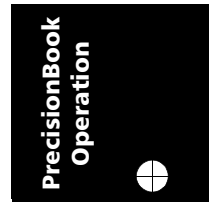
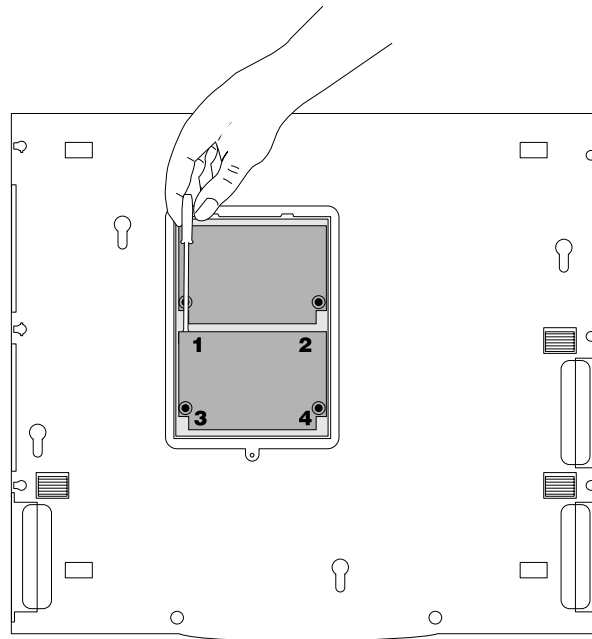

Figure 3-12 Removing the Secondary Memory Module



Caution: You must pry gently upward at the leverage points shown in Figure 3-12 and Figure 3-13 or you may damage your memory modules or the main system board and void your system warranty. The leverage points are numbered and you must pry gently upward in the order shown to remove the memory modules without damaging them.

- b. Grasping the memory module by its outer edges, carefully lift the memory module away from its RAM connector and the unit.

- c. Using a small flat-tip screw driver, pry gently upward against the outer edges of the system's primary main memory module until the memory module is free of its RAM connector, as shown in Figure 3-13.

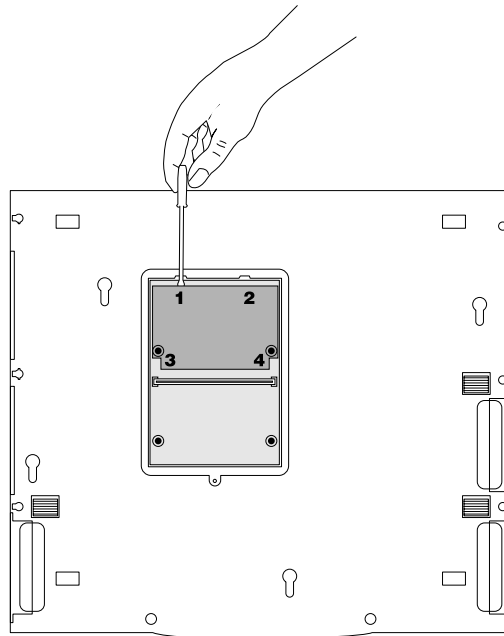

Figure 3-13 Removing the Main Memory Module

- d. Grasping the memory module by its outer edges, carefully lift the memory module away from its RAM connector and the unit.

If you have only one memory module installed, use this procedure to remove it.

Note:

If you are installing or upgrading only one main memory module, install it in the position of the memory module shown in Figure 3-14 (the memory slot closest to the rear of the unit).



Caution: You must pry gently upward at the leverage points shown in Figure 3-14 or you may damage your memory modules or the main system board and void your system warranty. The leverage points are numbered and you must pry gently upward in the order shown to remove the memory modules without damaging them.

- a. Using a small flat-tip screw driver, pry gently upward against the outer edges of the system's primary main memory module until the memory module is free of its RAM connector, as shown in Figure 3-14.

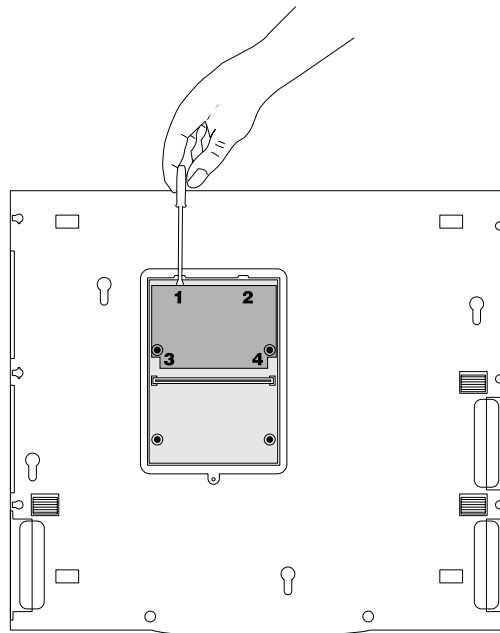

PrecisionBook
Operation

Figure 3-14 Removing the Main Memory Module

- b. Grasping the memory module by its outer edges, carefully lift the memory module away from its memory connector and the unit.

Notes

4 Troubleshooting

In the unlikely event you should encounter a situation that requires corrective action, use the suggestions in this chapter to diagnose and correct the problem. To contact Customer Service and Support, refer to page 4-7.



To help you find the relevant information quickly, refer to the following Quick Fix Table

Table 4-1. Quick Fix Table

If You Have a Problem with ...	See
Starting and Booting	4-1
Battery Operation	4-3
SCSI port	4-4
Ethernet	4-4
AUI	4-5
Serial Ports	4-6
External video port	4-6
External keyboard	4-7
External mouse port	4-7

Troubleshooting

Starting and Booting

1. The PrecisionBook will not power up from the AC adapter.
 - a. Be sure that the power-on icon  is displayed on the Status LCD after pressing the power-on button.
 - b. Make certain that the AC adapter is securely plugged into the PrecisionBook's power input socket and the AC outlet. The AC power icon  displays on the Status LCD when the workstation is connected to AC power.

- c. Use a lamp to test if power is available at the outlet.
2. The PrecisionBook will not power-up from the battery.
 - a. Be sure that the power-on icon  is displayed on the Status LCD after pressing the power-on button.
 - b. Make certain that the battery pack is correctly installed in the battery compartment.
 - c. Check the onboard battery QuikCheck indicator (located on the battery pack) to be sure that the battery pack has been recharged. Refer to Chapter 3 and the *PrecisionBook Hardware Reference Guide* for complete information.
3. The PrecisionBook will not access the Ethernet.
 - a. Make sure the server is properly operating and the Ethernet link is functioning.
 - b. If you use a transceiver or twisted-pair cable, make sure it is securely plugged into the PrecisionBook connector.
 - c. If this is a new network node, check the workstation's operating system to see if it is correctly configured for the network.
4. The PrecisionBook will not boot from the hard disk drive.
 - a. Check that the drive has been completely seated in its device bay by gently but firmly pressing in on the hard drive face plate. The hard drive will "click" into place when seated.

- b. If the hard drive activity icon displays but the PrecisionBook fails to boot, try relocating your bootable drive to another device bay. The operating system may be trying to boot from a different device bay. If this fails the boot files may be corrupted and you may have to reload the operating system.
- c. If the hard drive activity icon indicator displays but the PrecisionBook fails to boot, boot from the RDI CD-ROM and restore the boot file.
- d. If the hard drive activity icon indicator displays but the PrecisionBook fails to boot, boot off the CD-ROM for further diagnostics.

Battery Operation

1. Low battery warning occurs when the workstation is started or shortly after power-up.
 - a. Connect the AC adapter and recharge the battery for 3 hours, then try using the PrecisionBook again.
 - b. If recharging fails to correct the problem, use the PowerTool to recalibrate the battery and its gas gauge, then try recharging the battery pack a second time.
 - c. If recharging fails to correct the problem, test the AC adapter by removing the battery pack from the PrecisionBook and trying to operate from the adapter only.
 - d. If the AC adapter is working and the battery still fails to hold a charge, replace the battery pack.

Troubleshooting

Replacement battery packs can be obtained from your PrecisionBook representative.

Refer to Appendix A for more information.



Warning: *Never use alkaline batteries in the PrecisionBook. This can be very hazardous and severe damage may occur to the workstation.*



Warnung: PrecisionBook wird mit einem aufladbaren nickel cadmium akku ausgeliefert. Versuchen sie auf keinen fall, ihre PrecisionBook workstation mit trockenbatterien (primarzellen) zu betreiben oder solche mit dem konnen personen-oder sachsaden zur folge haben.

SCSI Port

1. External SCSI device fails to function.
 - a. Make certain active termination is installed on the last connected SCSI device. Otherwise, you may experience erratic performance.
 - b. Make sure the SCSI device is connected to an AC outlet and energized.
 - c. Make sure the SCSI cable is properly connected and functioning.
 - d. Make sure the SCSI ID is unique.

Ethernet

1. The PrecisionBook fails to access Ethernet.
 - a. The PrecisionBook must be connected to a functioning Ethernet network while powered-down. Once connected, the workstation can be powered-up.
 - b. If you access the twisted-pair connector, make sure the twisted-pair cable is securely connected to the PrecisionBook connector.

- c. Type **/usr/sbin/ifconfig lan** and press Enter to verify the Ethernet connection. Your display should show a list of active flags, one of which must be “up”. You should also see your Internet address.
- d. Type **/usr/sbin/ping** and press Enter to verify your connection to the host. The display should show the following types of information continuously:
 - “64 bytes returned”
 - Your Internet address
 - One ICMP sequence number
 - The round-trip time it takes data to travel from the workstation to the host and back

If <hostname> is not in your host file, use an IP address.

To stop this information from scrolling, hold down the Ctrl key and press C.

AUI Port

1. The PrecisionBook fails to access an AUI device.
 - a. The PrecisionBook must be connected to a functioning Ethernet/AUI network using the supplied I/O breakout cable while the unit is powered-down. Once connected, the workstation can be powered-up.
 - b. Type **/usr/sbin/ifconfig lan** and press Enter to verify the Ethernet/AUI connection. Your display should show a list of active flags, one of which must be “up”. You should also see your Internet address.
 - c. Type **/usr/sbin/ping** and press Enter to verify your connection to the host. The display should show the following types of information continuously:

Troubleshooting

- “64 bytes returned”
- Your Internet address
- One ICMP sequence number
- The round-trip time it takes data to travel from the workstation to the host and back

If <hostname> is not in your host file, use an IP address.

To stop this information from scrolling, hold down the Ctrl key and press C.

Serial Ports

1. Serial device fails to function.
 - a. Check that the device is connected to the correct serial port. Verify the port assignment by connecting the device cable to the other serial port and retrying the serial port.
 - b. Port parameters may be configured incorrectly for the application or attached device. Refer to the manual that came with your application or device for more information.
 - c. Use SAM to make sure the serial driver was configured in the operating system.

External Video Port

1. External monitor display remains blank.
 - a. Check the monitor connection to the PrecisionBook.

- b. Check Appendix B for the correct combination of external monitor and PROM commands. PrecisionBook will support only select monitor resolution and refresh rates. Check the external monitor manual to make sure the monitor is compatible with the PrecisionBook output.
- c. Be sure to provide the correct PCI-Bus-probe-list parameters to enable or disable the external monitor. Refer to Appendix B.

External Keyboard

1. The external keyboard fails to work.
 - a. Make sure that the external keyboard is securely plugged into the appropriate PrecisionBook connector.

External Mouse Port

1. The external mouse fail to work.
 - a. Make sure that the external mouse is securely plugged into the appropriate PrecisionBook connector.

Troubleshooting

Customer Service and Support

If the troubleshooting information in this chapter does not resolve the problem, you may contact RDI's Customer Service and Support staff.

RDI Customer Service:
7:00 AM to 6:00 PM PST
Phone 1-800 734-7030
Fax (760) 931-5981
Email: support@rdi.com

Before you call, have the PrecisionBook serial number nearby. This number appears on the bottom of the PrecisionBook.

If you received an error message, it will also help if you write down the following information:

1. Serial number of your system.
2. The exact description of the problem.
3. The task you were performing when you encountered the problem.
4. The command you typed when the error occurred. You may want to check the command line to make sure you did not make a mistake.
5. The directory you were in. You can use “pwd” to obtain this information.
6. The account you were using. You can use “whoami” to obtain this information.
7. Version of the operating system you are using. You can use “uname -a” to obtain this information.

A

Low Battery Shutdown

This appendix describes the PrecisionBook's low battery shutdown sequence.

Overview

The PrecisionBook battery is uniquely designed to provide the longest possible duration. As with any battery, however, prolonged use requires the battery to be recharged. Typically, battery power lasts up to one hour, depending on your configuration and applications.

To prolong battery use, use the dimming keys on the keyboard to reduce the intensity of, and the power consumed by, the LCD.

As battery power decreases, the PrecisionBook performs a sequence of events, described in table A-1. During this sequence, the PrecisionBook provides constant messages and an audible alarm informing you of the battery's current status. If you have the Common Desktop Environment (CDE) running, the PowerTool dialog appears, displaying current battery information. If you desire, you can use the PowerTool to turn off the alarm. For more information, refer to "Understanding the PowerTool GUI" in the Maintenance chapter of the Hardware Reference Guide.

Note:

The Duration column in Table A-1 reflects approximate times during typical operating activities and conditions.

Low Battery
Shutdown

Table A-1 PrecisionBook Low Battery Shutdown

Battery Status	Duration	System Actions	Actions You can Perform
Fully charged	Up to 1 hour	None	None required
Low battery condition	10 - 15	Warning message displayed on the Console. Audible warning sounds. If CDE is running, PowerTool window pops up, displaying battery capacity.	Attach AC adapter, or save and begin exiting processes. To complete jobs currently running, use dimmer switch to lower the LCD intensity and save battery power. Use the PowerTool to turn off the alarm, if desired.
Critical battery condition	2 minutes	Power management daemon starts system shutdown sequence. When the shutdown sequence completes, the system displays a message indicating that it is ok to turn off power to the system.	HP-UX shutdown cannot be interrupted. Attaching AC adapter will still require you to boot the PrecisionBook after the shutdown. Connect the AC adapter card and reboot the PrecisionBook. Press the power switch to turn off the system. Leave the system in this state until battery power is exhausted, causing automatic power shutdown.

B External Monitor Matrix

The PrecisionBook is delivered with either a 1024 x 768 pixel resolution 12.1 inch or 14.1 inch Liquid Crystal Display (LCD). It also has the option to drive the external monitors. In some combinations, the PrecisionBook can drive both the LCD and an external monitor simultaneously. This list charts the various combinations and monitor type selections needed to activate them.

PrecisionBook LCD Resolution	External Monitor Resolution
LCD Only Operation	External Monitor Only Operation
1024x768 62Hz (256K Colors)	
<p>Note: The RDI LCD display mode must be disabled to use a Type 5 monitor for external display.</p>	Type 1 1280x1024 75Hz
	Type 2 1280x1024 75Hz (Double buffered)
	Type 3 1280x1024 75Hz Greyscale
	Type 4 1280x1024 75Hz (Double buffered, Greyscale)
	Type 5 1024x768 75Hz
	Type 6 800x600 75Hz
	Type 7 640x480 75Hz
	Type 8 1600x1200 75Hz

Monitor Matrix

PrecisionBook LCD Resolution	External Monitor Resolution
	Type 9 1600x1200 75Hz (Greyscale)
	Type 10 1200x1600 75Hz
	Type 11 1200x1600 75Hz (Greyscale)
	Type 12 1280x1024 72Hz
	Type 13 1280x1024 72Hz (Double buffered)
	Type 14 640x480 60Hz
	Type 15 -user defined-
Simultaneous Operation 1024x768 62Hz (256K Colors)	Type 5 1024x768 62Hz

Note: Simultaneous display is supported in 1024x768 mode for LCD projection panels and projectors.

Changing Resolutions

Changing the display resolution can only be done during the boot sequence, either during start-up or rebooting specifically to change the resolution.

1. Enter the command interpreter mode by pressing any character when the following system message appears:

```
Processor is booting from first available device.  
To discontinue, press any key within 10 seconds.
```

The workstation will now be in HP boot PROM mode. You can now execute PROM commands.

2. Enter the configuration menu and use the **MONitor** command to set the monitor resolution.

–or–

3. Press **Tab** when you see the following system message:

```
To select a new graphics monitor type, press the [TAB] key now.  
Otherwise, EXIT by entering any other key. The system will time out  
in 15 seconds...
```

Note:

You can use the PROM commands **configure monitor**, **rdi lcd**, **rdi external**, to change monitor resolutions. The PROM also contains useful menus and help information to guide you while using these commands.

**Monitor
Matrix**

Notes

Index

A	
AC adapter	1-4
no power	4-1
plugging in	2-3
recharging battery with	3-4
using	3-3
adjusting backlight	3-2
adjusting screen angle	3-2
alkaline battery (DO NOT USE)	2-3
audio	1-3
B	
back panel, opening	2-4
backlight intensity	3-2
battery	3-5
alkaline (DO NOT USE)	2-3
installing	2-2, 3-5
life of	A-2
low battery notice	3-14
low warning	A-1
low warning on startup	4-3
no power	4-1
recharging	3-4
removing	3-5
troubleshooting	4-3
using	3-4
boot	3-9, 4-1
hard disk drives and	4-2
bus terminator	3-8
C	
cable	
connecting	3-17
Ethernet	3-7
cache	1-2
cautions	xv
changing resolution	B-2
cleaners and solvents	3-1
closing	
display cover	3-3
conventions	xv, xvi, xvii
cautions	xv
warnings	xv
cover, closing	3-3
critical battery	A-2
customer support	4-7
D	
daisy-chained SCSI devices, terminating	3-16
data cache	1-2
diagnostics	3-9
display	1-3, 3-17
adjusting angle	3-2
changing resolution	B-2
closing cover	3-3
external	B-1
opening cover	3-1
docking port	1-4
domain name	3-7
IP address	3-7
password	3-7
user name	3-7
E	
ejecting PCMCIA cards	3-16
Ethernet	3-7
cable	3-7
connecting cable	3-17
Internet address	3-7
no access	4-2
RJ45 port	1-4
troubleshooting	4-4
user name and password	

- 3-7
- external 3-17
 - disk drive 1-3
 - display 3-17
 - floppy drive 1-3
 - mouse 3-17
- external monitor B-1
 - changing resolution . . B-2
 - troubleshooting 4-6
 - VGA port 1-4
- external peripherals
 - turning on 3-7
- external SCSI devices, termi-
nating 3-16
- F**
- failure to boot. 4-2
- Fast SCSI
 - SEE SCSI
- floppy disk drive
 - external 1-3
- fully charged A-2
- H**
- hard disk drives 1-3, 3-15
 - installing 3-15
 - no boot. 4-2
 - removing 3-14
- hostname 3-7
- I**
- initial screens, viewing . . . 2-6
- installing 3-15
 - AC adapter 2-3
 - battery 2-2, 3-5
 - RAM 3-19
- Internet address. 3-7
- IP address (domain name) . 3-7
- J**
- jacks. 1-3
- K**
- keyboard 1-3, 3-17
 - external 3-17
 - external keyboard and 3-17
 - troubleshooting 4-7
- L**
- life of battery A-2
- lithium-ion battery
 - SEE battery
- logging in 3-9
- logging out 3-10
- low battery A-2
- low battery warning 3-14
 - on startup 4-3
 - shutdown A-1
- M**
- memory 1-2
 - upgrading. 3-19
- microphone 1-3
 - recording with 3-16
- motherboard 1-2
- mouse
 - SEE touchpad
- moving PrecisionBook . . . 3-11
- N**
- network
 - connecting Ethernet cable
3-17
 - no access 4-2
 - troubleshooting 4-4
 - NIS domain name. 3-7
- notes xv
- O**
- opening
 - back panel 2-4
 - PrecisionBook 3-1
 - side panel 2-4
- opening PrecisionBook . . . 2-2
- operating system, shutting
down 3-10
- P**
- parallel port 3-18
- password 3-7
- PCMCIA 1-3
 - ejecting cards 3-16

- plugging in AC adapter . . . 2-3
- power adapter
 - SEE AC adapter
- power switch. 2-5
- projection panel B-2
- Proxima panels/projectors . B-2
- R**
- RAM. 1-2
 - upgrading 3-19
- recharging battery. 3-4
- recording with external microphone. 3-16
- removing. 3-5
 - hard disk drives 3-14
 - PCMCIA cards 3-16
- resolution, changing B-2
- restarting PrecisionBook. 3-12
- RJ45 port 1-4
- S**
- screen messages xvi
- SCSI. 1-3
 - bus terminator 3-8
 - terminating devices. . 3-16
 - troubleshooting. 4-4
- SCSI bus, terminating. . . 3-16
- secondary cache 1-2
- self-test. 3-9
- serial port 3-18
 - troubleshooting. 4-6
- service 4-7
- shutting PrecisionBook down .
 - 3-9
 - operating system shutdown 3-10
- side panel, opening 2-4
- solvents and cleaners. . . . 3-1
- speaker 1-3
- starting PrecisionBook 3-6, 4-1
 - again. 3-12
 - Ethernet. 3-7
- logging in 3-9
- low battery warning . . 4-3
- no Ethernet 4-2
- no power. 4-1
- SCSI bus terminators . 3-8
- temperature 3-7
- turning on peripherals 3-7
- status LCD 1-3
- support. 4-7
- T**
- technical support 4-7
- temperature 2-1, 3-7
- terminating
 - SCSI devices 3-16
- touchpad. 1-3
 - external mouse and . . 3-17
- troubleshooting
 - battery 4-3
 - Ethernet. 4-4
 - external keyboard/mouse. .
 - 4-7
 - serial ports 4-6
 - starting and booting . . 4-1
- turning on peripherals . . 3-7
- turning on PrecisionBook . 2-5
- U**
- upgrading RAM. 3-19
- user name. 3-7
- V**
- variables xvii
 - conventions. xvii
- ventilation 3-1
- VGA port 1-4
- viewing
 - initial screens 2-6
- W**
- warning
 - low battery 3-14
- warnings. xv

Notes