

# **SPARCbook**

## **Portable Workstation**

# **User Guide**

**SPARCbook 3000 and SPARCbook 3 Families**

---

## **Copyright and Trademark Information**

Copyright © 1997 by Tadpole Technology Inc

Copyright © 1995 by Sun Microsystems, Inc. 2550 Garcia Avenue, Mountain View, California 94043-1100 U.S.A.

All rights reserved. This product or document is protected by copyright and distributed under licenses restricting its use, copying, distribution and decompilation. No part of this product or document may be reproduced in any form by any means without prior written authorization of Sun and its licensors, if any.

Portions of this product may be derived from the UNIX®, licensed from UNIX Systems Laboratories, Inc., a wholly owned subsidiary of Novell, Inc., and from the Berkeley 4.3 BSD system, licensed from the University of California. Third-party software, including font technology in this product, is protected by copyright and licensed from Sun's Suppliers.

RESTRICTED RIGHTS LEGEND: Use, duplication, or disclosure by the government is subject to restrictions as set forth in subparagraph (c) (1) (ii) of the Rights in Technical Data and Computer Software clause at DFARS 252.227-7013 and FAR 52.227-19.

This product or the products depicted herein may be protected by one or more U.S. or international patents or pending patents.

### **TRADEMARKS**

Sun, Sun Microsystems, the Sun logo, OpenWindows, SunView and SunOS are trademarks or registered trademarks of Sun Microsystems, Inc. UNIX and OPEN LOOK are registered trademarks of UNIX Systems Laboratories, Inc. All other product names mentioned herein are the trademarks of their respective owners.

All SPARC trademarks, including the SCD Compliant logo, are trademarks or registered trademarks of SPARC International, Inc. SPARCbook is a trademark of SPARC International Inc, licensed exclusively to Tadpole Technology Inc. Products bearing SPARC trademarks are based upon an architecture developed by Sun Microsystems, Inc.

The OPEN LOOK® and Sun™ Graphical User Interfaces were developed by Sun Microsystems, Inc. for its users and licensees. Sun acknowledges the pioneering efforts of Xerox in researching and developing the concept of visual or graphical user interfaces for the computer industry. Sun holds a non-exclusive license from Xerox to the Xerox Graphical User Interface, which license also covers Sun's licensees who implement OPEN LOOK GUI's and otherwise comply with Sun's written License agreements.

The X Window System is a trademark of X Consortium, Inc.

Notebook Computing Environment and NCE are trademarks of Tadpole Technology, Inc.

All other products or services mentioned herein are identified by the trademarks, service marks or product names of their respective companies or organizations.

Issue 1.0 of 12 June 1997

© by Tadpole Technology plc

Part Number: 980380

Printed in United Kingdom

---

## FCC Class B Notice

This equipment has been tested and found to comply with the limits for a Class B digital device, pursuant to Part 15 of the FCC rules. These limits are designed to provide reasonable protection against harmful interference in a residential installation. This equipment generates, uses and can radiate radio frequency energy and, if not installed and used in accordance with the instructions, may cause harmful interference to radio communications. However, there is no guarantee that interference will not occur in a particular installation. If this equipment does cause harmful interference to radio or television reception, which can be determined by turning the equipment off and on, the user is encouraged to try to correct the interference by one or more of the following measures:

- Reorient or relocate the receiving antenna.
- Increase the separation between the equipment and receiver.
- Connect the equipment into an outlet on a circuit different from that to which the receiver is connected.
- Consult your supplier or an experienced radio or television technician for help.

Properly shielded and grounded cables and connectors must be used in order to meet FCC emission limits. Proper cables and connectors are available from your supplier. Tadpole Technology is not responsible for any radio or television interference caused by using other than recommended cables and connectors or by unauthorized changes or modifications to this equipment. Unauthorized changes or modifications to the equipment could void the authority granted by the FCC to operate the equipment.

This device complies with Part 15 of the FCC rules. Operation is subject to the following two conditions: (1) this device may not cause harmful interference, and (2) this device must accept any interference received, including interference that may cause undesired operation.

**IMPORTANT NOTE:** To ensure compliance with the Class B limit, when this equipment is operated with an external video monitor, the cable used to connect between this equipment and the external monitor must be of a ferrite loaded type. If the cable used is not already fitted with ferrite cores, the user must install a split ferrite core on the cable.

### Canadian Department of Communications Compliance Statement

This equipment does not exceed Class B limits per radio noise emissions for digital apparatus set out in the Radio Interference Regulations of the Canadian Department of Communications.

### Avis de conformité aux normes du ministère des Communications du Canada

Cet équipement ne dépasse pas les limites de Classe B d'émission de bruits radioélectroniques pour les appareils numériques, telles que prescrites par le Règlement sur le brouillage radioélectrique établi par le ministère des Communications du Canada.

## **FCC Part 68 Modem Information**

This information applies **ONLY** to SPARCbook 3, SPARCbook 3 LC, SPARCbook 3XP, SPARCbook 3 TX and SPARCbook Server models which are equipped with an internal modem.

This equipment complies with Part 68 of the FCC rules. On the underside of this equipment is a label that contains, among other information, the FCC registration number and ringer equivalence number (REN) for this equipment. If requested, this information must be provided to the telephone company.

This equipment uses the following USOC jacks: RJ12.

The REN is used to determine the quantity of devices which may be connected to the telephone line. Excessive RENs on the telephone line may result in the devices not ringing in response to an incoming call. In most, but not all areas, the sum of the RENs should not exceed five (5.0). To be certain of the number of devices that may be connected to the line, as determined by the total RENs, contact the telephone company to determine the maximum REN for the calling area.

If this equipment causes harm to the telephone network, the telephone company will notify you in advance that temporary discontinuance of service may be required. If advance notice is not practical, the telephone company will notify the customer as soon as possible. Also, you will be advised of your right to file a complaint with the FCC if you believe it is necessary.

The telephone company may make changes in its facilities, equipment, operations or procedures that could affect the operation of the equipment. If this happens, the telephone company will provide advance notice in order for you to make the necessary modifications in order to maintain uninterrupted service.

If trouble is experienced with this equipment, please contact Tadpole Technology Inc., 12012 Technology Boulevard, Suite 100, Austin, Texas 78727 Tel: 512-219-2200 for repair and/or warranty information. If the trouble is causing harm to the telephone network, the telephone company may request you remove the equipment from the network until the problem is resolved.

The following repairs may be done by the customer: None.

This equipment cannot be used on telephone company-provided coin service. Connection to Party Line Service is subject to state tariffs.

The Telephone Consumer Protection Act of 1991 makes it unlawful for any person to use a computer or any other electronic device to send messages via a telephone fax machine unless such a message contains in a margin at the top or bottom of each transmitted page or on the first page of the transmission, the date and time it is sent and an identification of the business or other entity, or other individual sending the message and the telephone number of the sending machine or such business, other entity or individual.

In order to program this information into this machine, you should follow the steps described in "FAXtool" on page 9-22.

---

## Electrical Safety Notice

**WARNING!**

---

**THE AC ADAPTER SUPPLIED WITH YOUR COMPUTER CONTAINS DANGEROUS VOLTAGES. IT CONTAINS NO USER SERVICEABLE PARTS. DO NOT REMOVE THE COVER.**

---

The following message applies to SPARCbook 3 models with built-in modem.

**WARNING!**

---

**ELECTRICAL CURRENT FROM POWER, TELEPHONE AND COMMUNICATION CABLES IS HAZARDOUS. TO AVOID SHOCK HAZARD, CONNECT AND DISCONNECT CABLES AS DESCRIBED BELOW WHEN INSTALLING, MOVING OR OPENING THE COVERS OF THIS PRODUCT OR ATTACHED DEVICES.**

---

### To connect your computer:

1. Turn your computer and peripherals OFF.
2. Connect all cables between your computer and any peripherals.
3. Connect all signal cables; for example, modem cable to a telephone receptacle.
4. Connect the power cord to the outlet.
5. Turn the peripherals ON and then turn your computer ON.

### To disconnect your computer:

1. Turn everything OFF.
2. Disconnect the power cord.
3. Disconnect the signal cables.
4. Disconnect all cables between your computer and peripherals.

## **Lithium battery**

### **WARNING!**

---

**THIS UNIT CONTAINS AN INTEGRATED LITHIUM BATTERY WHICH IS NOT A CUSTOMER SERVICEABLE PART AND MUST NOT BE REPLACED BY THE CUSTOMER / END USER. IF THE LITHIUM BATTERY REQUIRES REPLACEMENT, THE UNIT MUST BE RETURNED TO THE FACTORY OF MANUFACTURE AS THERE IS A DANGER OF EXPLOSION IF THE BATTERY IS INCORRECTLY REPLACED.**

---

---

## **Environmental Notice**

### **Note**

---

The fluorescent lamp located in the liquid crystal display (LCD) contains a small amount of mercury. Dispose of it in accordance with your company's safety procedures, local procedures or return it to your supplier for safe disposal.

---

# Contents

Copyright and Trademark Information .....	ii
FCC Class B Notice .....	iii
FCC Part 68 Modem Information .....	iv
Electrical Safety Notice .....	v
To connect your computer: .....	v
To disconnect your computer: .....	v
Lithium battery .....	vi
Environmental Notice .....	vi

## About this Guide

Document Summary .....	xvi
Models Covered by this Guide .....	xix
Associated Documents .....	xix
.....	xix
Typographical Conventions .....	xx

## Chapter 1 Getting Started

Caring for your SPARCbook .....	1-2
Installing the Battery .....	1-3
Connecting the AC Adapter .....	1-5
Powering On for the First Time .....	1-6
Powering Off .....	1-7
Powering off using a system shutdown .....	1-7
Powering off using Save .....	1-7
Using Full System Startup .....	1-8
Using Different Screen Environments .....	1-9
Starting NCE .....	1-9
Using an External Keyboard and Mouse .....	1-10

## Chapter 2 Initial System Configuration

What System Configuration Entails .....	2-2
Initial Configuration – Worked Example .....	2-2
Collecting the required system information .....	2-2
Network information .....	2-3
Time zone .....	2-4
Setting a superuser password .....	2-4
Setting up a user account .....	2-5
Restarting the System .....	2-7

## Chapter 3 Main System Components

Front Detail .....	3-2
Rear Detail .....	3-4
Underside Detail .....	3-6
I/O Panel .....	3-7
Model differences .....	3-7
Connector descriptions .....	3-8
The Built-In Display .....	3-10
Viewing angle .....	3-11
Display brightness .....	3-11
The Built-In Keyboard .....	3-11
Function keys .....	3-11
Microcontroller function keys .....	3-12
Delete and interrupt keys .....	3-13
Numeric keypad .....	3-13
Adjusting the keyboard angle .....	3-14
The Pointing Stick .....	3-15
Status Display .....	3-16
Battery status .....	3-16
Machine and OS status .....	3-16

## Chapter 4 Power Management

Power Management System Operation .....	4-2
Battery charging .....	4-2
Battery status .....	4-2
Battery warning LED .....	4-3
Maximizing battery life .....	4-4
The Internal Battery .....	4-4
Operating on internal battery power .....	4-4
Replacing the internal battery .....	4-5
Battery behavior .....	4-5
Battery conditioning .....	4-5
The Internal Battery Pack Charger Unit (IBPC) .....	4-6
Connecting the charger .....	4-6
Using the charger .....	4-7
Storing the charger's cable .....	4-7
Using an External Battery Pack .....	4-8
Identifying the main components .....	4-8
Attaching the external battery pack .....	4-9
Working with the external battery pack .....	4-10
Charging your external battery pack .....	4-10
Stand-alone charging .....	4-11
Detaching your external battery pack .....	4-11



Storing the extension cord .....	4-11
Using A 12V Car Adapter .....	4-12
Important safety information .....	4-12
Connecting your car adapter .....	4-12
Using your car adapter .....	4-13
Disconnecting your car adapter .....	4-14
Operation during engine starts .....	4-14

## **Chapter 5 Save and Resume**

How Save and Resume Functions .....	5-2
Powering Off Using Save .....	5-3
How to ensure Save and Resume operates successfully .....	5-3
What to do if Resume Fails .....	5-4
Automatic Save Features .....	5-5
Save on battery low .....	5-5
Save on system inactivity .....	5-5
Sleep mode .....	5-5
Save and Resume and Security .....	5-6
Enabling and Disabling Save and Resume .....	5-7

## **Chapter 6 Using the Removable Hard Disk**

Overview .....	6-2
Fitting and Removing the Hard Disk .....	6-3
Caring for Removable Hard Disks .....	6-4
Boot Disk Partitions .....	6-5
Model differences .....	6-5
Using Additional Removable Hard Disks .....	6-7
Configuring a boot disk .....	6-8
Configuring a hard disk for additional storage .....	6-9
Using a Removable Hard Disk Drive Adapter .....	6-9
RHDD Security .....	6-12

## **Chapter 7 Using SCSI Devices**

Overview .....	7-2
Connecting SCSI Devices .....	7-3
Maximum number of devices supported .....	7-3
SPARCbook positioning .....	7-3
SCSI Terminators .....	7-4
SCSI IDs .....	7-4
Configuring an External Hard Disk – Worked Example .....	7-6
Using a Tadpole SCSI Floppy Disk Drive .....	7-11

## Chapter 8 Using the Network Interface

Network Terminology .....	8-2
Connecting Your SPARCbook to a Network .....	8-3
An Overview of TCP/IP Networking and the Internet .....	8-4
Internet addresses .....	8-4
Addresses used by systems not connected to the Internet .....	8-6
Network names .....	8-6
Accessing the Internet .....	8-7
Registering Internet addresses .....	8-8
Configuring Your SPARCbook for a TCP/IP Network .....	8-9
Assigning a hostname and IP address .....	8-10
Configuring your SPARCbook to use a name server .....	8-11
Setting up a default router .....	8-12
Testing Your network connection .....	8-12
Sharing Filesystems .....	8-13
Exporting local filesystems .....	8-14
Mounting filesystems .....	8-15
Automatic file mounting .....	8-16
Unmounting a remote filesystem .....	8-17
Executing Remote Commands .....	8-18
Copying files .....	8-18
Remote program execution .....	8-19
SLIP and PPP .....	8-19

## Chapter 9 Remote Computing

Getting Connected .....	9-2
Configuring the modem .....	9-2
Checking the modem is alive .....	9-3
Simple Terminal Login Connection .....	9-3
Remote Network Access .....	9-5
Setting up PPP .....	9-6
Loading the PPP packages .....	9-6
Editing the system files .....	9-7
Editing the UUCP database files .....	9-9
Editing the passwd file .....	9-11
Editing the asppp.cf file .....	9-11
Starting and stopping PPP .....	9-12
Testing the link .....	9-13
Using a SLIP Connection .....	9-13
Electronic Mail .....	9-14
Setting up email .....	9-14
AT Command Set .....	9-15
AT command set description .....	9-17

Class 2 Fax Command Set .....	9-21
FAXtool .....	9-22
Sending a fax .....	9-22

## **Chapter 10 PCMCIA Interface**

Introduction to PCMCIA .....	10-2
The PCMCIA Port .....	10-4
Removing the PCMCIA flap .....	10-4
Installing a PCMCIA Card .....	10-5
Removing a PCMCIA Card .....	10-6
Using PCMCIA Cards .....	10-7
Modem cards .....	10-7
Network interface cards .....	10-7
Memory cards .....	10-8
Hard disks .....	10-8

## **Chapter 11 Using Displays**

SPARCbook Display Interface Overview .....	11-2
Display Interface Operating Modes .....	11-3
Native mode .....	11-3
Emulated mode .....	11-3
Pan and Zoom .....	11-4
Display panning .....	11-4
Display zoom .....	11-4
Color Mapping .....	11-6
Setting the color mode .....	11-6
Resolution limitations .....	11-7
Simultaneous Display Operation .....	11-7
Connecting an External Display .....	11-8
Configuring the Display Interface Using NCE .....	11-9
Using the NCE Display Panel .....	11-9
Configuring the Display Interface at the Command Prompt .....	11-11
Setting the Xserver resolution .....	11-11
Setting up the display interface hardware .....	11-12
Adding to the Display Types List .....	11-14
Display Timing Parameters .....	11-16

## **Chapter 12 Serial, Parallel and Audio I/O**

Using Serial Devices .....	12-2
Configuring serial connections .....	12-2
Using Parallel Devices .....	12-3
Configuring parallel devices .....	12-3
Using Audio Equipment .....	12-4

Adjusting the audio input and outputs .....	12-4
Using the built-in microphone and speaker .....	12-4
External audio sources and outputs .....	12-5

## **Chapter 13 Installing and Using Applications**

Third-party Application Support .....	13-2
Methods of Installing Applications .....	13-3
Applications and Graphics Interfaces .....	13-3
Legibility of Text on a Small Screen .....	13-4
Customizing the Operating System .....	13-5
Installing Packages .....	13-5
Displaying Package Information .....	13-7
Removing Packages .....	13-7
Memory Usage and Swap Space .....	13-8
Using swap space efficiently .....	13-8
Checking swap space usage .....	13-10
Adding swap space .....	13-10

## **Chapter 14 Backup and Restore**

Overview .....	14-2
Backup strategies .....	14-2
Further information .....	14-3
File Backup Facilities .....	14-3
Backing Up Filesystems .....	14-4
Backing up partitions to tape .....	14-5
Making a complete tape backup – worked example .....	14-5
Backing up onto an external hard disk .....	14-6
Restoring Filesystems .....	14-6
Re-installing the Operating System from CD-ROM .....	14-8

## **Chapter 15 System Upgrades**

Overview .....	15-2
Upgrading the Hard Disk Drive .....	15-2
Upgrading the Main Memory .....	15-3
Fitting new SIMMs .....	15-3
Repartitioning the hard disk drive – worked example .....	15-7
Repartitioning the drive .....	15-11

## **Chapter 16 Problem Solving and Support**

Getting Further Help .....	16-2
Problem Solving Checklists .....	16-3
Startup problems .....	16-3
Save and Resume problems .....	16-4

Network problems .....	16-6
Other hardware problems .....	16-7
Using the OpenBoot Diagnostics .....	16-8
Displaying the OpenBoot user interface .....	16-8
Checking SCSI devices .....	16-8
Checking the network interface .....	16-9
Full system hardware selftest .....	16-10
Software Problems .....	16-11
Stopping processes .....	16-11
Killing a program .....	16-12
Operating system panic .....	16-12
Failing program .....	16-12
Warning messages .....	16-13
Resetting Your SPARCbook .....	16-14

## Appendix A Technical Specifications

### Appendix B Connector Reference

DC In .....	B-2
Parallel Port Connector .....	B-2
Ethernet .....	B-3
Video .....	B-3
SCSI .....	B-4
Keyboard/Mouse .....	B-5
Serial Ports .....	B-5
ISDN .....	B-5
Modem (SPARCbook 3 Models Only) .....	B-6

### Appendix C Customer Support Information

What to do if You Suspect a Fault .....	C-2
Conditions .....	C-2
Contact details .....	C-3
System details .....	C-3
Fault details .....	C-3



# About this Guide

This Guide describes how to use the SPARCbook 3 and SPARCbook 3000 Series Notebook Workstations. It describes how to start up and shutdown, how to add accessories and how to use the mobility features. To get the most from your SPARCbook as quickly as possible, please take the time to read the first five chapters of this guide. These provide the most essential information to get your system up and running quickly.

This section provides the following information:

- Document Summary ..... xvi
- Models Covered by this Guide ..... xix
- Associated Documents ..... xix
- Typographical Conventions ..... xx

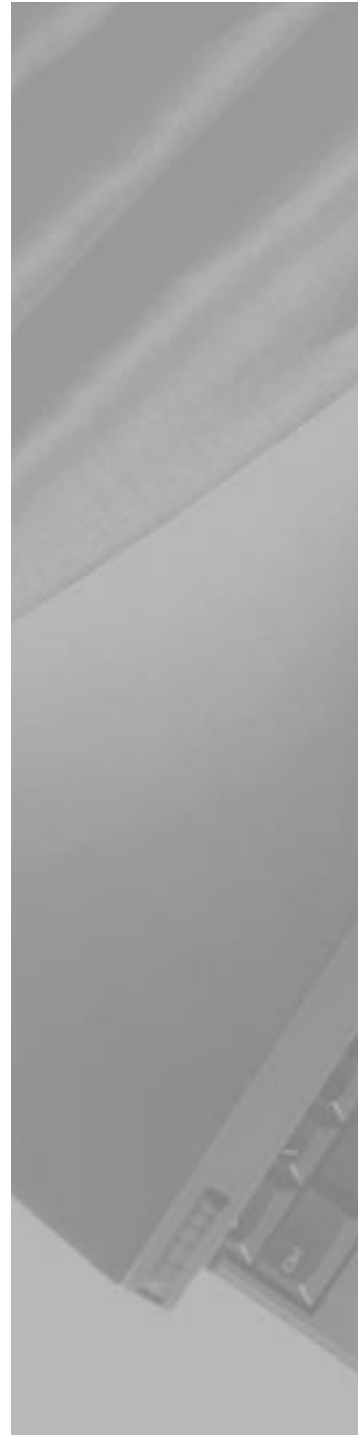

---

## Document Summary

The SPARCbook Portable Workstation User Guide contains the following chapters:

- **Chapter 1 “Getting Started”**  
This chapter describes how to get your SPARCbook operational. It describes how to install and charge the battery for the first time, how to connect your system to an AC supply and how to start up and shut down.
- **Chapter 2 “Initial System Configuration”**  
This chapter describes how to carry out the initial system configuration of your SPARCbook, including how to create your own user account, how to configure an Internet Protocol (IP) address and host name, and how to set the timezone.
- **Chapter 3 “Main System Components”**  
This chapter identifies the main components of your SPARCbook and briefly describes the function of each. Read this chapter to familiarize yourself with the main components.
- **Chapter 4 “Power Management”**  
This chapter describes your SPARCbook’s power management system. It discusses how to use internal and external batteries and a 12V car adapter.
- **Chapter 5 “Save and Resume”**  
This chapter discusses how to use Save and Resume. The Save and Resume feature provides an easy way to start and stop your SPARCbook without having to perform lengthy shutdown and startup procedures.
- **Chapter 6 “Using the Removable Hard Disk”**  
This chapter discusses how to use your SPARCbook’s removable hard disk drive (RHDD). It describes how to fit and remove the drive, how to use additional hard disks and how to ensure a basic level of security for your RHDD.



- **Chapter 7 “Using SCSI Devices”**  
This chapter describes how to connect and use external SCSI devices. It describes how to set the SCSI ID and termination correctly and provides an example of how to configure an external hard disk.
- **Chapter 8 “Using the Network Interface”**  
This chapter provides an introduction to networking concepts, with particular regard to portable computing and describes how to connect your SPARCbook to a network and configure the network interface.
- **Chapter 9 “Remote Computing”**  
This chapter discusses how to use your SPARCbook for remote communications via a modem. It discusses how to set up the internal modem on the SPARCbook 3 Series models, how to set up PCMCIA modems on SPARCbook 3000 models, and how to use remote communications.
- **Chapter 10 “PCMCIA Interface”**  
This chapter discusses how to use the PCMCIA interface to add memory or I/O facilities to your SPARCbook using industry-standard credit card-sized PCMCIA cards.
- **Chapter 11 “Using Displays”**  
This chapter describes how to use your SPARCbook’s sophisticated display interface to drive the built-in display and external high resolution CRT displays.
- **Chapter 12 “Serial, Parallel and Audio I/O”**  
This chapter describes how to use the serial, parallel and audio interfaces.
- **Chapter 13 “Installing and Using Applications”**  
This chapter provides details about running third-party applications, and outlines any limitations that may apply.

- **Chapter 14 “Backup and Restore”**

This chapter describes the backup and restore facilities provided as part of the SPARCbook implementation of Solaris. In particular it provides an example of how to use ufsdump and ufsrestore to backup and restore filesystems.
- **Chapter 15 “System Upgrades”**

This chapter discusses how to carry out upgrades to your SPARCbook. The user installed upgrades covered allow you to add larger hard disk drives and more DRAM to your SPARCbook.
- **Chapter 16 “Problem Solving and Support”**

This chapter provides information about solving common problems that may arise with your SPARCbook. It describes how to obtain technical assistance, provides a problem solving checklist, describes how to use the OpenBoot diagnostics software, and how to solve some common software problems.
- **Appendix A “Technical Specifications”**

This appendix provides detailed technical specifications for the SPARCbook 3 GX and TX (S3GX and S3TX) and SPARCbook 3000 ST and XT models (S3000ST and S3000XT).
- **Appendix B “Connector Reference”**

This appendix provides details of the connector pin assignments for the interfaces on the I/O panel.
- **Appendix C “Customer Support Information”**

All Tadpole products are rigorously tested before dispatch to the customer. However, if your system develops a serious fault it may need to be returned to the factory for repair. This appendix tells you what to do in this event.

---

## Models Covered by this Guide

This guide covers the following models

- SPARCbook 3000ST
- SPARCbook 3000XT
- SPARCbook 3GX
- SPARCbook 3TX

Procedures and described in this guide can be applied to any SPARCbook 3 model using the same operating system although specific details, such as built-in display resolution, may differ.

---

## Associated Documents

Publication	Topics
Read Me <i>First</i>	Release notes for the version of Solaris currently offered for SPARCbook 3 and 3000.
SPARCbook NCE User Guide	Describes how to use the Notebook Computing Environment. referred to in this manual as the <i>NCE User Guide</i> .

---

## Typographical Conventions

A number of typographical conventions are used in this publication to aid your understanding. These are summarized as follows:

Typeface	Meaning	Example
Monospace	Used to indicate text displayed on screen and OS file names.	... the device file <code>/dev/rdiskette</code> .
<b>Monospace Bold</b>	Used to indicate commands you type in.	# <b>more</b> /etc/hotsts
<b>Sans-serif Bold</b>	Used to indicate particular keys or key sequences that you press on the keyboard, and buttons displayed in windows	To power off, press the <b>Pause-O</b> keys.
<i>Italics</i>	Used to emphasize important terms when they are first used and for titles of other publications.	The term <i>domain</i> is often applied to a group of networked computers within an organization.

---

# Getting Started

This chapter describes how to get your SPARCbook operational. It describes how to install and charge the battery for the first time, how to connect your system to an AC supply and how to start up and shut down.

It provides the following sections:

- Caring for your SPARCbook ..... 1 - 2
- Installing the Battery ..... 1 - 3
- Connecting the AC Adapter ..... 1 - 5
- Powering On for the First Time ..... 1 - 6
- Powering Off ..... 1 - 7
- Using Full System Startup ..... 1 - 8
- Using Different Screen Environments ..... 1 - 9
- Starting NCE ..... 1 - 9
- Using an External Keyboard and Mouse ..... 1 - 10

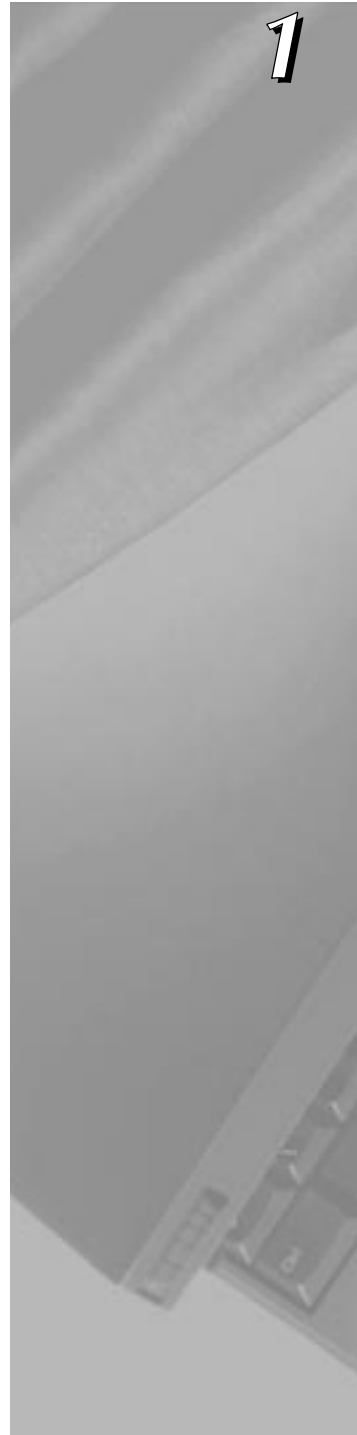

---

# Caring for your SPARCbook

Your SPARCbook is a robust mobile computer system but does require careful handling. To prevent any damage and ensure prolonged reliability, please observe the following precautions:

- Do not place heavy objects on top of your SPARCbook.
- Do not scratch or hit the surface of the display.
- Keep your SPARCbook at least 13 cm (5 in) away from electrical appliances that generate strong magnetic fields, such as motors, televisions, refrigerators or powerful audio speakers.
- Do not disassemble your SPARCbook.
- Do not move your SPARCbook while it is operating.

Cleaning the exterior surface of your SPARCbook and the liquid crystal display (LCD) require different methods. It is recommended that you clean your SPARCbook as follows:

- On the exterior surface, wipe with a soft cloth moistened with a mild detergent.
- On the LCD, use a soft cloth dampened with lens cleaner, antistatic fluid or VDU screen cleaner.

---

## Installing the Battery

When a battery is supplied with your SPARCbook, it is packed separately to protect the battery and SPARCbook contacts while the system is in transit.

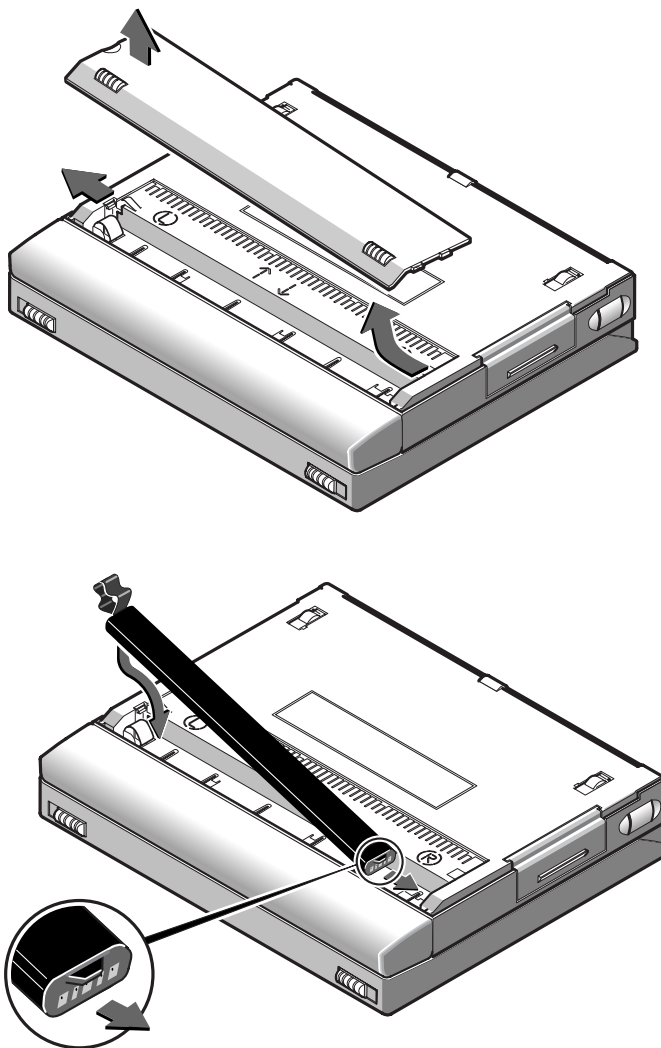

*Figure 1-1 Installing the Battery (SPARCbook 3000 Shown)*

## Getting Started

### Installing the Battery

Install the battery as follows (refer to Figure 1-1):

1. Turn your SPARCbook upside down.
2. Remove the battery cover by pressing the catch with your thumbnail towards the side of the SPARCbook. The cover springs open slightly allowing you to lift it off.
3. Insert the battery, ensuring correct orientation. The battery is shaped to make this easier.
4. Replace the cover.

Now go to “Connecting the AC Adapter” on page 1-5.

#### Battery Charging

☞ Your SPARCbook charges the internal battery automatically when it is connected to an AC adapter or optional car adapter. The AC adapter or car adapter supplies power to your SPARCbook whether your SPARCbook is operating or not.

☞ The internal battery takes between 1.5 and 4 hours to charge the first time, depending on SPARCbook model and whether it is operating or not.

☞ The internal battery uses nickel metal hydride (NiMH) cells. One characteristic of this type of cell is that it takes several full charge and discharge cycles for them to yield their full storage capacity (to become *conditioned*). Once the cells are conditioned, the charge percentage of the battery pack is accurately indicated on the status display.

☞ The internal battery provides around 45 minutes operating time from a full charge, depending upon SPARCbook model and the power management options in operation. See Chapter 4, “Power Management” .



---

## Connecting the AC Adapter

The AC adapter supplied with your SPARCbook operates at any AC voltage in the range of 100 to 240 Volts at 50 or 60Hz. This means that you can use the supplied AC adapter anywhere in the world where there is a suitable supply. You may need to use different AC cords, however.

Connect the AC adapter to your SPARCbook as follows:

- 1.** Connect the DC cord from the AC adapter to the DC-In connector on your SPARCbook.
- 2.** Connect the AC cord from the AC adapter into a wall socket or distribution panel.

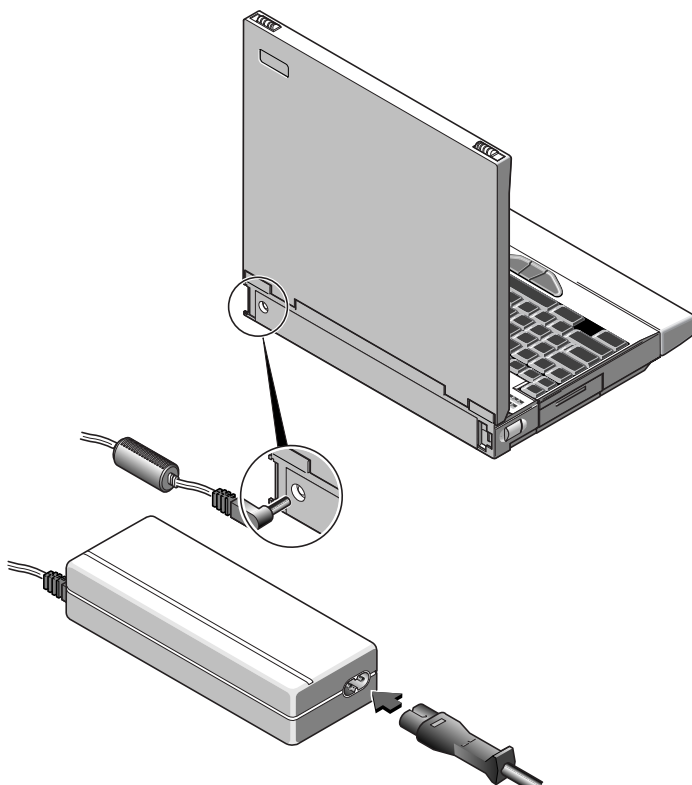
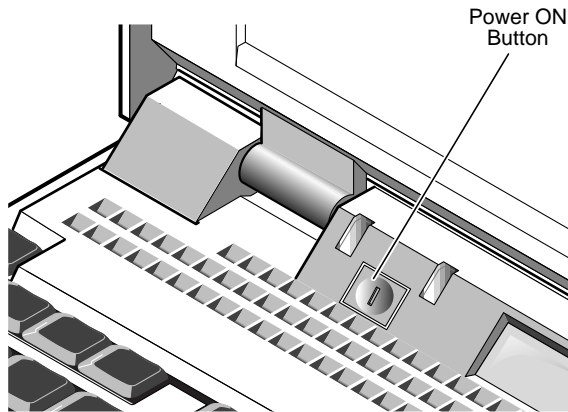

*Figure 1-2 Connecting the AC Adapter*

---

# Powering On for the First Time

To power your SPARCbook on, press the Power On button, as illustrated in Figure 1-3.



*Figure 1-3 Powering On*

As your SPARCbook powers on, a number of codes are displayed in the status display and then, after some delay, the system configuration screen is displayed.

Configuring your system is described in Chapter 2, “Initial System Configuration” .

---

### Note

On a new system, the Power On button is only configured to power your SPARCbook on. It has no effect while the SPARCbook is running. However, it can be configured as a Save button using the NCE Save and Resume panel. See Chapter 5, “Save and Resume” in this guide and “Save and Resume Panel” in your *NCE User Guide*.

---

---

## Powering Off

Your SPARCbook provides you with two methods of shutting down and powering off:

- Conventional system shutdown
- Save

### Powering off using a system shutdown

To shut your SPARCbook down, log in as root and enter the command:

```
# init 0
```

This takes the system down to the OpenBoot prompt and a safe state for power-off. Power off by pressing **Pause-O**. The next time you power on your SPARCbook carries out a full system startup and not a Resume.

### Powering off using Save

The Save facility allows you to power off quickly without having to perform lengthy shutdown procedures. To power off with Save, press **Pause-O** on the keyboard. The built-in display, if it is in use, goes blank and your SPARCbook system beeps before it powers off. It takes between 30 and 90 seconds for the Save to complete.

#### Save and Resume

➤ The Save and Resume feature makes it easy to start and stop your SPARCbook without having to perform the lengthy Solaris shutdown and startup procedures of a conventional UNIX system. The system's complete operational state is saved onto specially assigned partition on the hard disk and is completely restored when you next power on. You do not have to close applications before performing a Save because they are completely unaffected by Save and Resume, allowing you to take up exactly where you left off.

✓ Use Save and Resume only if your SPARCbook is going to be used in the same way when you next power-on.

✗ Use a system shutdown and reboot if you change or remove disks, change displays or change the system's network environment while it is powered off.

Your SPARCbook provides several ways to initiate a Save. These are described in Chapter 5, "Save and Resume" .

---

# Using Full System Startup

Your SPARCbook can be booted in the same way as any conventional desktop SPARC workstation running Solaris.

- Use a full system startup if you have reconfigured your system's hardware in any way while it has been powered off. Save and Resume may fail in cases where the system hardware has been reconfigured.
- Use a full system restart if, for any reason, you do not wish to use the Save and Resume facility.

In cases where you have previously used Save to power off or if Resume fails, a full system startup can be carried out as follows:

- 1.** If your system is powered on, press **Pause-O** to power off.
- 2.** Press the power on button or, if your system already has power but is failing to Resume, press **Pause-R**.
- 3.** When the OpenBoot start-up screen is displayed, press **Pause-A**.



```
Tadpole S3 SPARCbook, keyboard present
ROM Rev 2.15 V1.00
32 MB memory installed, Serial #10683270
Ethernet address 0:0:83:a3:3:86, Host ID: Host ID:
80a30386
```

```
Initializing memory -
Type help for more information
ok
```

- 4.** At the OpenBoot prompt, type in the following commands:

```
ok create no-resume?
ok boot
```

---

## Using Different Screen Environments

Your SPARCbook's built-in display operates in two modes: terminal mode and Xwindows mode. The default mode is Xwindows mode. When your system starts up, the Solaris login window allows you to select the display mode from the **Option** menu.

**Session** Allows you to select between the CDE or the OpenWindows desktop environments, both of which operate in Xwindows mode.

### Command Line Login

Allows you to select the terminal mode. In this mode, your display operates as a simple ASCII terminal and displays the Solaris command line.

### Note

---

If your SPARCbook starts at the command prompt, you can enter OpenWindows by typing the command `openwin`.

The factory installed Solaris 2.5.1 may not have CDE installed. If you wish to use CDE it must be installed from the supplied SunSoft CD-ROM.

---

---

## Starting NCE

The Notebook Computing Environment (NCE) provides a suite of graphical tools that make mobile system administration easier. For example:

- The Display Panel allows you to configure your system to operate at different display resolutions.
- The Save and Resume Panel allows you to configure the operation of the Save and Resume feature.

For information about using NCE, refer to your *NCE User Guide*.

---

# Using an External Keyboard and Mouse

Although the built-in keyboard and pointing stick provide full functionality, you may find it convenient when using your SPARCbook as a desktop machine to use a Sun-compatible keyboard and mouse with your SPARCbook.

The external keyboard and mouse interface is combined, and can be used to connect a type 4 or 5 Sun keyboard and mouse.

### Note

---

Your SPARCbook supports the connection of a Sun-compatible keyboard and Sun-compatible optical or mechanical mouse. Other types of mouse or keyboard should not be connected.

---

The pinout of the combined keyboard and mouse interface is standard, allowing you to connect any Sun-compatible external mouse and keyboard with their standard cables. The combined keyboard and mouse interface allows you to connect an external mouse and keyboard. The mouse can be connected directly to the SPARCbook or indirectly via a connector provided on the external keyboard. The internal pointing stick and keyboard remain active while an external keyboard and mouse are connected.

Your keyboard is enabled as soon as it is connected to your SPARCbook. You can alter the operation of your keyboard and change the keyboard layout if you wish by using the Keyboard panel of the Notebook Computing Environment. See “Keyboard Panel” in your *NCE User Guide*.

# Initial System Configuration

This chapter describes how to carry out the initial system configuration of your SPARCbook, including how to create your own user account, how to configure an Internet Protocol (IP) address and host name, and how to set the timezone.

Your SPARCbook notebook workstation is shipped from the factory with the Solaris operating environment ready installed for you on the removable hard disk. However, before using your SPARCbook for the first time, configure the operating system following the instructions in this chapter. You may require the assistance of a system administrator to carry out the configuration or to provide you with essential information.

This chapter contains the following sections:

- What System Configuration Entails . . . . . 2 - 2
- Initial Configuration – Worked Example . . . . . 2 - 2
- Setting up a user account . . . . . 2 - 5
- Restarting the System . . . . . 2 - 7

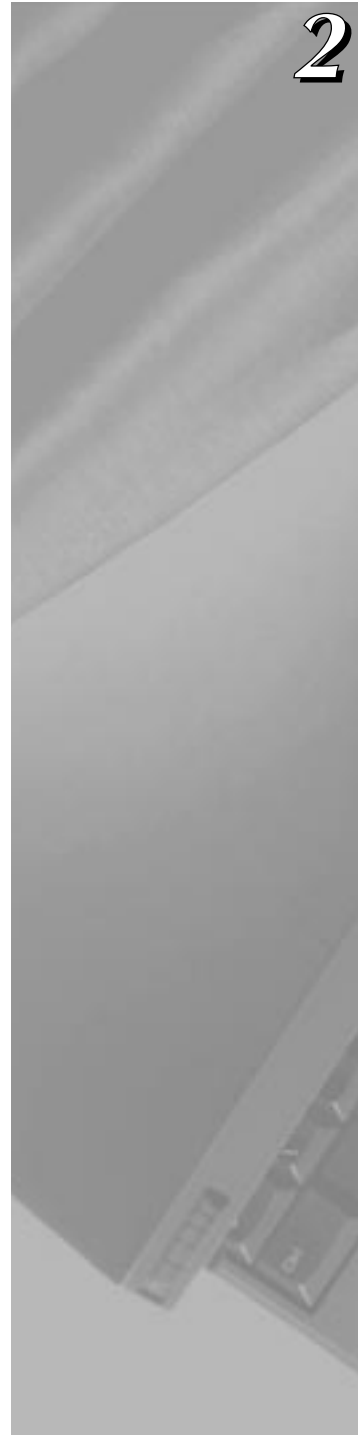

## What System Configuration Entails

Basic configuration of your SPARCbook involves the following basic steps:

- Assigning a host name and Internet Protocol (IP) address to your SPARCbook
- Setting your time zone
- Setting a password for the super user (root) account
- Setting up user accounts

The remainder of this chapter provides you with a worked example.

### Note

---

The initial configuration process may differ slightly between Solaris versions so that the order in which steps are carried out may differ from the worked example below. As a general rule, you should carry out any steps following any instructions displayed on the screen.

For full details of how to configure Solaris, refer the SunSoft Solaris documentation.

---

---

## Initial Configuration – Worked Example

### Collecting the required system information

Before configuring your SPARCbook, assemble the information you will require by filling in the following table. You may need to consult your system administrator for the correct information for your system.



Category	Worked Example	Your Configuration
Host Name	chianti	
IP Address	195.5.2.15	
Subnet Mask	255.255.255.0	
Name Service	None	
Name Server Hostname	None	
Time Zone	No example given	
User Name	Betty Small	

Table 2-1 Configuration Worksheet

## Network information

### ➤ Host Name

The host name of your SPARCbook is the name by which it is known to other computers connected to the network. For example:

Host name: **chianti**

The name must be unique to your SPARCbook system as duplicated names will disrupt the operation of the network.

### ➤ Internet Address

The IP address of your SPARCbook consists of four groups of decimal numbers separated by periods. For example:

Internet (IP) Address: **195.5.2.15**

The IP address must be unique to your SPARCbook system as duplicated addresses will disrupt the network.

### ➤ Name Service

After you have entered your SPARCbook's host name and IP address, you are prompted to select the name service you require. Using NIS and NIS+ can cause start-up problems if you later try to use your SPARCbook without a network connection.

## Initial System Configuration

### *Initial Configuration – Worked Example*

If your SPARCbook is going to be used as a mobile computer, it may be advisable to select `None` from this screen and configure your SPARCbook later to use the domain name service (DNS). See Section “Configuring your SPARCbook to use a name server” on page 8-11.

#### ➤ *Subnets*

This screen prompts you to specify whether or not your SPARCbook is going to be attached to a subnet. Larger corporate networks are often divided into smaller segments called subnets. If your SPARCbook is going to be used as standalone system, enter `No`.

If your SPARCbook is going to be connected to a large network, you will need to consult your system administrator for the correct choice for this screen.

## Time zone

When prompted, enter your time zone information following the on-screen instructions.

If your time zone does not correspond with any of those listed, you can set a time zone relative to Greenwich Mean Time (GMT), also known as Coordinated Universal Time (CUT), or specify a `timezone` file to be used.

## Setting a superuser password

Enter a password for the super user (or root) account. The super user account has special privileges and is used mainly for system administration tasks. Inadvertent or unauthorized use of some of the commands available to super user can damage the operating system and render your SPARCbook unusable. For this reason you are advised to set a password for the super user account.

The password should consist of a minimum of six characters. Any printable characters can be used including letters, numbers and punctuation marks.

After you have entered your root password, a Solaris 2 system displays the Solaris login prompt. You should create a user account as described in the next section.

### Moving Between User and the Root Accounts

➤ Many of the operations described in this guide require you to be logged in as root. The root account gives you the privileges required to carry out system administration tasks such as disk maintenance. However, using the root account for day to day purposes is very risky as you can easily cause damage to the operating system.

➤ As a rule, you should log in to your normal user account for every day purposes. Then, when you need to carry out particular task as root, enter the `su` command and the root password to log in to the root account:

```
% su
Password:
#
```

➤ The hash prompt (#) indicates that you have root privileges.

➤ When you have completed the task requiring root privilege, close the root account by pressing **Ctrl-D** on the keyboard.

## Setting up a user account

### ➤ *Starting the User Account Manager*

For day-to-day use, you should set up a user account by using the OpenWindows admintool. This provides an easy-to-use way to create a user account. To open an admintool window carry out the following steps:

1. At the Solaris prompt, log in as root and then start OpenWindows with the following commands:

```
login: root
password:
# openwin
```

The OpenWindows desktop is displayed.

## Initial System Configuration

### Initial Configuration – Worked Example

2. Move the cursor to a clear area of the desktop background and press and hold the menu (center) mouse button. The OpenWindows desktop menu is displayed.
3. From the menu, select **Programs** and then **Command Tool**. A cmdtool window is displayed.
4. In the command tool window, enter the command:  

```
# admintool
```

The **Admintool** window is displayed. If necessary, select the **User** from the **Browse** menu to display a list of users.
5. From the Edit menu, select Add. The Add User window is displayed.



Figure 2-1 Admintool

➤ *User Name*

This is the login name of the user. This is often an abbreviation or your initials. For example, for the user Betty Small might use `betty`. The comment field is commonly used to describe the user. In this case, the user Betty Small's full name.

➤ *User ID*

The user ID is a unique number by which the network identifies a user account. Numbers 1 through 10 are reserved. You should consult the network administrator for your site for a valid number. If you are using your system as a stand-alone unit, use 100 for the first account, 101 for the next and so on.

➤ *Account Security*

This section is used to specify how the password for the account is to be administered. Use this section to specify such the required change frequency, expiration date and number of days warnings are issued advising that the password should be changed.

➤ *Home Directory*

This section creates a home directory for your new user account. You must enter a directory path in the text field. User accounts are normally located in `/opt`. In this example, Betty Small would enter the path `/opt/bs`.

After you have entered your account details, click on OK and Solaris creates a user account based to your specifications.

---

## Restarting the System

When you have completed system configuration, carry out a complete system reboot by entering the command:

```
# init 0
```

This takes the system down to the OpenBoot prompt and a safe state for power-off without using the Save and Resume feature. Power off by pressing **Pause-O**.

Power on again by pressing the power-on button.

## **Initial System Configuration**

*Restarting the System*

# Main System Components

This chapter identifies the main components of your SPARCbook and briefly describes the function of each. Read this chapter to familiarize yourself with the main components.

This chapter contains the following information:

- Front Detail . . . . . 3 - 2
- Rear Detail . . . . . 3 - 4
- Underside Detail . . . . . 3 - 6
- I/O Panel . . . . . 3 - 7
- The Built-In Display . . . . . 3 - 10
- The Built-In Keyboard . . . . . 3 - 11
- The Pointing Stick . . . . . 3 - 15
- Status Display . . . . . 3 - 16

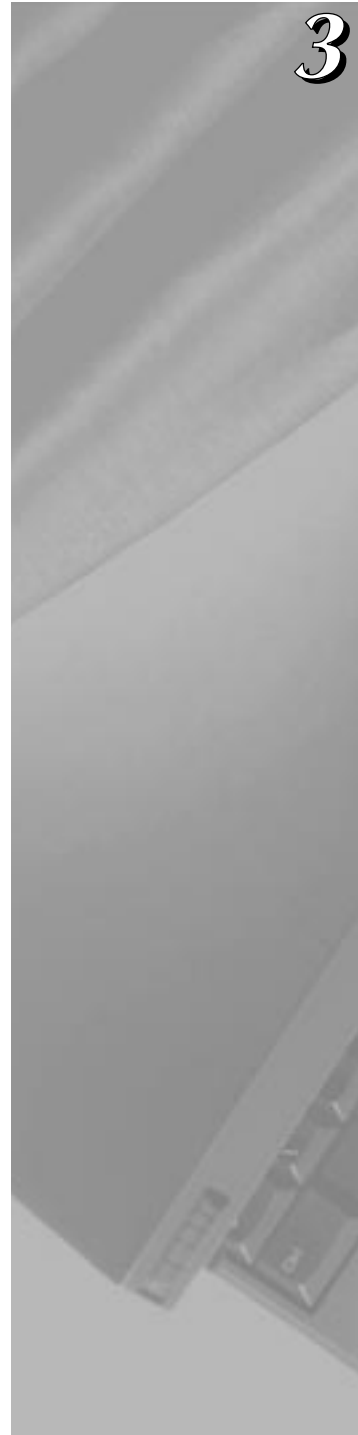

---

## Front Detail

The front detail of your SPARCbook 3000 is illustrated in Figure 3-1.

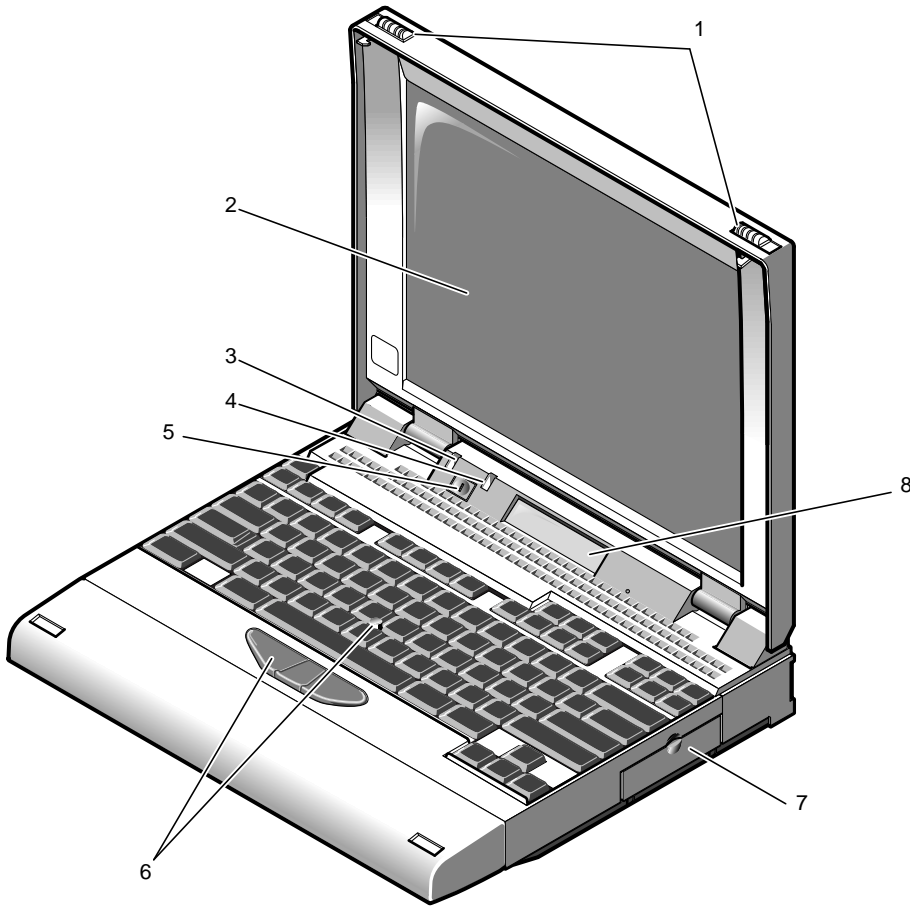

*Figure 3-1 Front View of SPARCbook 3000*



Feature	Function
(1) Latches	The latches are used to open the lid of your SPARCbook. Slide both latches towards the outer edges of the unit to release the lid.
(2) Built-in display	The built-in display, often referred to as the TFT display, displays the system output. You can also use an external display connected at the rear of the unit (see “Connecting an External Display” on page 11-8), in which case this display may be blank.
(3) Power ON LED	The power-ON LED (green) lights when your SPARCbook is powered on.
(4) Battery Warning LED	<p>The battery warning LED (orange) signals when the charge level of the internal battery is low. See “Power Management System Operation” on page 4-2.</p> <p>Your SPARCbook performs an automatic Save when the battery is nearly discharged, allowing you to Resume work when the battery has been replaced or your system has been connected to an AC supply.</p>
(5) Power On Button	<p>The Power On button is used to power your SPARCbook on. On a new system, it is only configured as a power-on button; the unit is powered off by pressing <b>Pause-O</b> on the keyboard. See “Powering off using Save” on page 1-7.</p> <p>However, the button can be configured to function as a power off button in the NCE Save and Resume panel.</p>
(6) Pointing Stick and Mouse Buttons	The Pointing Stick is a built-in pointing device that simulates a mouse. It is used in conjunction with three buttons located at the front of the keyboard which function as mouse buttons.
(7) PCMCIA Port	The PCMCIA port provides two PCMCIA slots. You can install up to two Type I or II devices, or one Type III device in your SPARCbook. See Chapter 10 “PCMCIA Interface”.
(8) Status Display	The status display provides low-level system status information, such as battery charge level and interface operation. See “Status Display” on page 3-16.

---

## Rear Detail

The rear detail of your SPARCbook is illustrated in Figure 3-2.

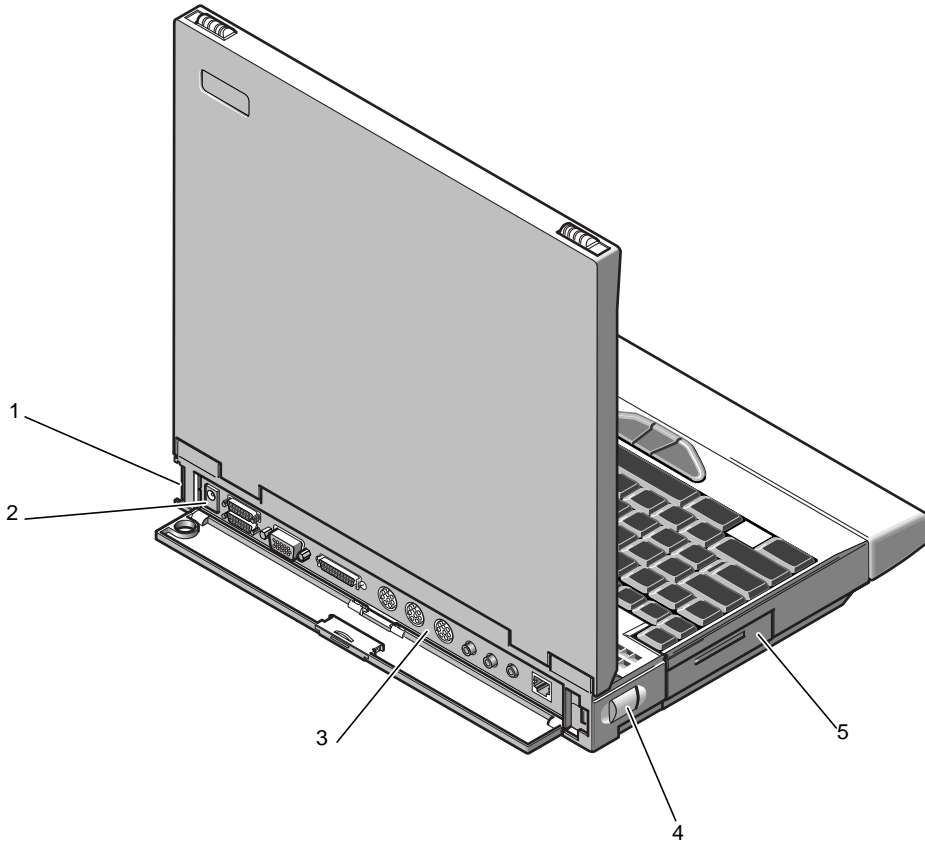

*Figure 3-2 Your SPARCbook 3000 Viewed from the Rear*

Feature	Function
(1) External Battery Connector	The external battery connector is used by an optional clip-on external battery pack to supply power to a SPARCbook. See "Using an External Battery Pack" on page 4-8. <b>This option is not available on SPARCbook 3000 models.</b>
(2) DC-In Connector	The DC-In connector is used to connect the AC adapter or optional vehicle adapter to your SPARCbook.
(3) I/O Panel	The I/O panel provides interface connections used for connecting peripherals and for communications. See "I/O Panel" on page 3-7.
(4) External Battery Release	The external battery release is used to release a clip-on external battery pack when one is attached to your SPARCbook 3. Slide the release towards the front of your SPARCbook 3 to release the battery.
(5) Removable Hard Disk	The hard disk in your SPARCbook is sealed within a removable module. The module can be removed and replaced easily. See "Fitting and Removing the Hard Disk" on page 6-3

### Underside Detail

The underside of the SPARCbook 3000 is illustrated in Figure 3-3.

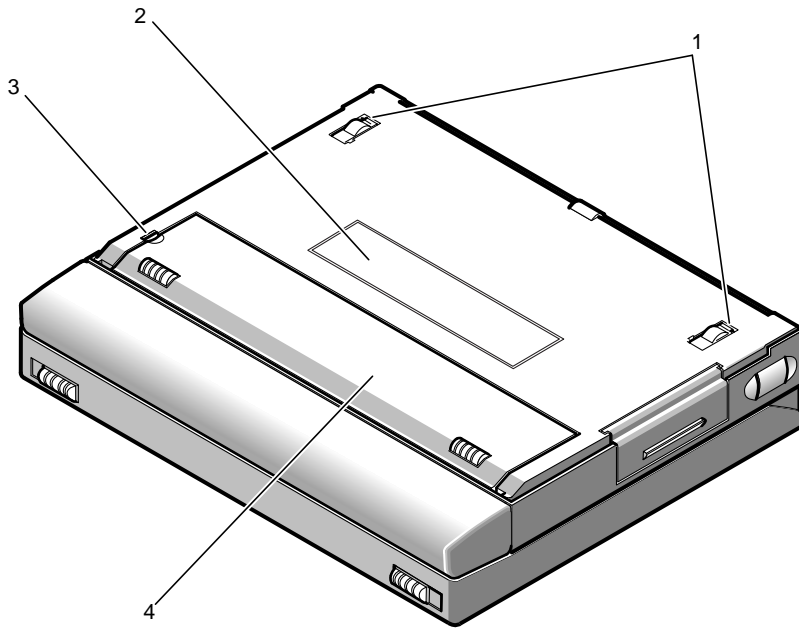

Figure 3-3 The Underside of Your SPARCbook 3000

Feature	Function
(1) Legs	These can be used to tilt the system for a more comfortable typing angle and to cool the system by allowing air to circulate beneath the base casting.
(2) Machine Identification Label	The machine identification label contains the serial number of your SPARCbook and information about the machine type. This information is required to obtain repair service.
(3) Battery Cover Catch	This is used to release the battery cover.
(4) Battery Cover	This covers the battery compartment. Before you can use your SPARCbook you need to insert the internal battery. See "Installing the Battery" on page 1-3

## I/O Panel

The I/O panel at the rear of the SPARCbook provides connectors for all of the expansion and communications interfaces except for the PCMCIA.

### Model differences

The following figures illustrate the I/O panels of the SPARCbook models.

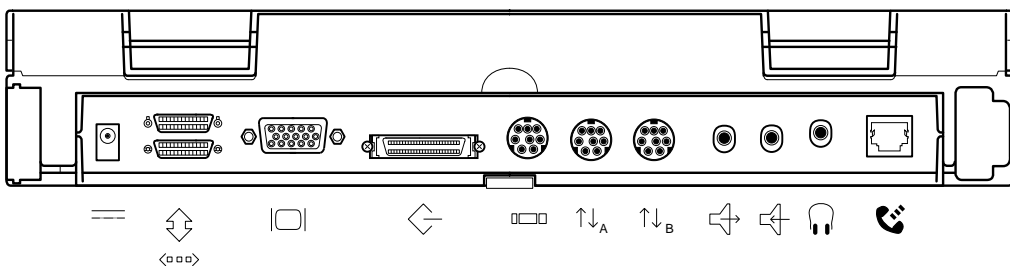

Figure 3-4 I/O Panel, SPARCbook 3000 Models

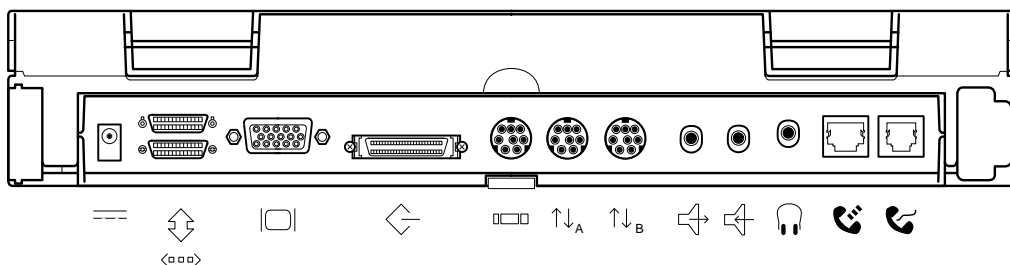

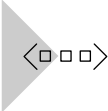
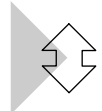
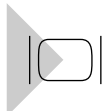
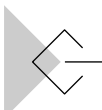
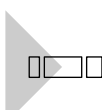

Figure 3-5 I/O Panel, SPARCbook 3 Models



## Main System Components

### I/O Panel

## Connector descriptions

The function of each connector on the I/O panel is described in the following table.

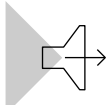
Icon	Name	Description
	Ethernet Interface	The Ethernet interface allows connection to a wide variety of local area networks via an external transceiver. Using the Ethernet interface is discussed in Chapter 8 “Using the Network Interface”.
	Parallel Port	The parallel port allows for the connection of devices such as printers and scanners. See “Using Parallel Devices” on page 12-3.
	Video Port	The video port allows you to connect external displays. A wide variety of displays can be driven directly from this port. Using the display interface is discussed in Chapter 11 “Using Displays”.
	SCSI Port	The SCSI port allows you to connect external hard disks, tape drives, and CD-ROM drives to your SPARCbook. See Chapter 7 “Using SCSI Devices”.
	Keyboard/Mouse Port	The combined keyboard and mouse port allows you to connect a Sun-compatible keyboard and mouse. The external keyboard operates simultaneously with the built-in keyboard. The external mouse operates simultaneously with the Pointing Stick. See “Using Serial Devices” on page 12-2.
	Serial Ports A and B	The serial (or TTY) ports allow the connection of devices such as serial printers, terminals, and external modems. See “Using Serial Devices” on page 12-2.
	Headphones	Stereo headphone socket provided for personal listening. See “Using Audio Equipment” on page 12-4.

Icon	Name	Description
	Audio In	The audio interface provides stereo line-in and line-out connections. It allows stereo sound input from an external sound source, such as a microphone or CD player, to be recorded and stored by your SPARCbook and then played out to external audio equipment. See “Using Audio Equipment” on page 12-4
	Audio Out	
	ISDN Interface	The ISDN interface allows connection to the Integrated Services Digital Network services provided by telephone companies.
	Internal Modem (SPARCbook 3 models only)	The Internal modem interface is used to connect your SPARCbook’s internal fax modem to the telephone system.

**Note**

---

SPARCbook models with a built-in modem are approved for connection to telephone systems in the United States of America (in accordance with FCC Part 68 rules, as written on page iv) and Canada. You are not permitted to connect the internal modem to public telephone systems in any other country.

---

---

## The Built-In Display

The built-in display is used by your SPARCbook to display information when an external high-resolution display is not being used. To use the internal display, open the lid and adjust the viewing angle to suit your needs.

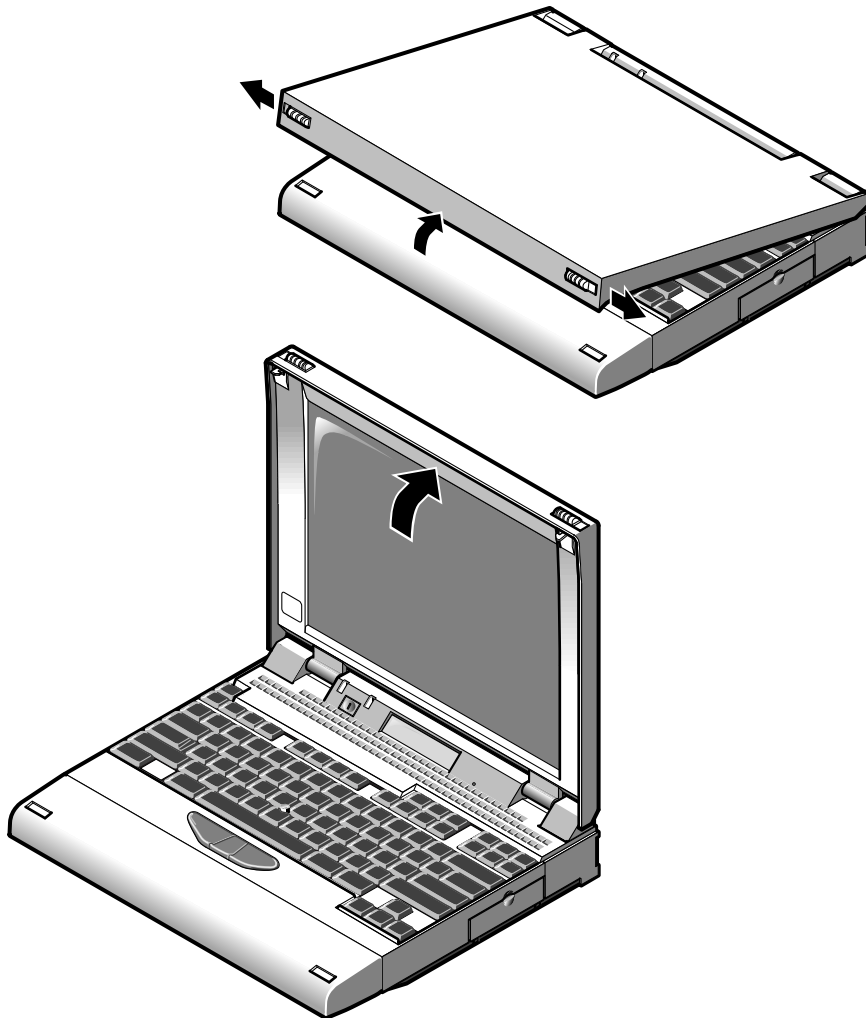

*Figure 3-6 Adjusting the Display Viewing Angle*



## Viewing angle

To open your SPARCbook, slide the two latches on the front of the unit outwards while simultaneously lifting the lid upwards. To obtain the best viewing angle, adjust the position of the lid.

## Display brightness

The display incorporates a fluorescent backlight to provide full-display legibility under a range of lighting conditions. You can adjust the brightness of the built-in display from the keyboard with the following key combinations:

- Screen brightness is increased by pressing **Pause- ↑**
- Screen brightness is decreased by pressing **Pause- ↓**

---

## The Built-In Keyboard

The built-in keyboard provides full-size keys laid out in a conventional manner. However, the number of keys provided is limited by the compact size of the SPARCbook which means that some of keys normally found on a full-sized keyboard must be simulated using key combinations.

## Function keys

The functions of the twelve function keys (**F1 - F12**) are controlled by the operating environment and some applications. In addition the keys emulate two further banks of function keys, normally called Left and Right function keys, when the **Alt** and **Ctrl** keys are pressed as well.

- Pressing the **Alt** key positioned to the *right* of the space bar and a function key provides the Left function.
- Pressing the **Ctrl** key positioned to the *right* of the space bar and a function key provides the Right function.

## Main System Components

### The Built-In Keyboard

The Right functions of **F13**, **F14** and **F15** are provided by pressing the **Ctrl** key (positioned to the *right* of the space bar), plus either the **Delete**, **End** or **Page Down** key respectively. For example, **F14** is emulated by pressing **Ctrl-End**.

## Microcontroller function keys

Your SPARCbook system provides software control over a number of special features, such as increasing or decreasing the brightness of the TFT display. These features are controlled by a dedicated microcontroller and several key combinations are predefined to operate them, as shown below.

Operation	Key Combination
Start Openboot (after power-on or reset)	<b>Pause-A</b>
System reset	<b>Pause-R</b>
System shutdown (using Save)	<b>Pause-O</b>
Cancel Save	<b>Pause-P</b>
Increase TFT display brightness	<b>Pause- ↑</b>
Decrease TFT display brightness	<b>Pause- ↓</b>
Move cursor to center of display	<b>Pause-Home</b>
Calibrate Mouse	<b>Pause-Home</b> (hold down for 3 seconds)
Zoom in	<b>Pause-Page Up</b>
Zoom out	<b>Pause-Page Down</b>
Increase volume	<b>Pause- →</b>
Decrease volume	<b>Pause- ←</b>
Quit OpenWindows	<b>F1-Alt-Delete</b>
Compose	<b>Ctrl</b> ( <i>right</i> of the space bar)- <b>J</b>
Right function keys	<b>Ctrl</b> ( <i>right</i> of the space bar)- <b>Fn</b>
Left function keys	<b>Alt</b> ( <i>right</i> of the space bar)- <b>Fn</b>
Enable/Disable numeric keypad mode	<b>Shift-NumLk</b>

### Delete and interrupt keys

The Solaris Operating System can be configured to use different keys for different functions. By default, the delete key is the **Del** key. The interrupt key, used to quit an application, is the **Ctrl-C** sequence.

### Numeric keypad

Some of the keys also function as a numeric keypad. Numeric-keypad mode can be enabled and disabled by pressing **Shift-NumLk**.

- Pressing **Shift-NumLk** enables numeric-keypad mode.
- Pressing **Shift-NumLk** again disables numeric-keypad mode.

The character for each key while in numeric-keypad mode is screen printed on the top surface next to the (larger) typewriter character, as shown in Figure 3-7.

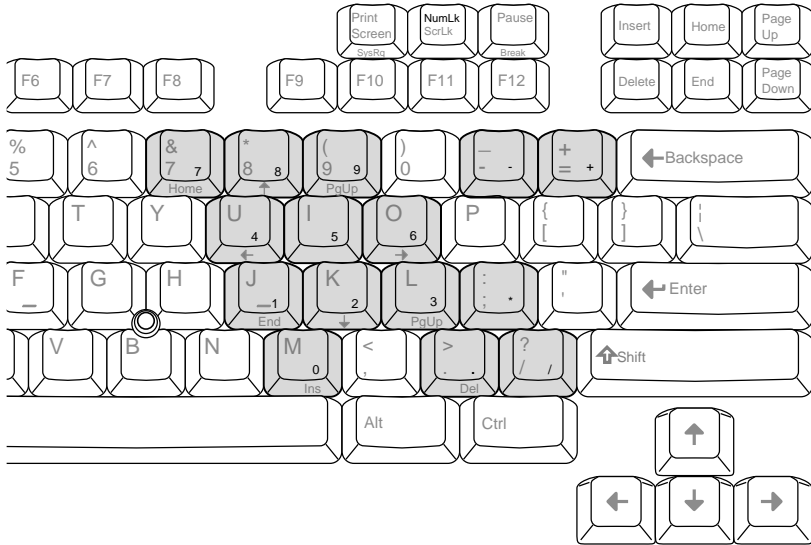

Figure 3-7 Numeric Keypad

## Main System Components

### The Built-In Keyboard

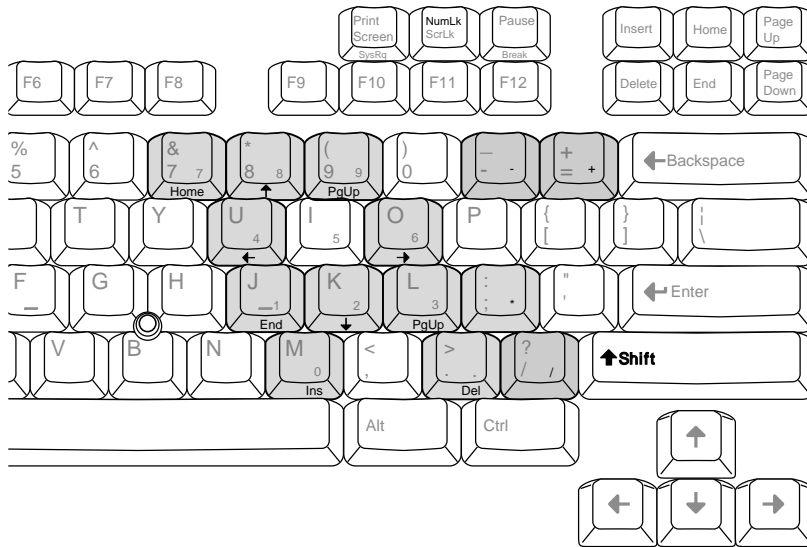

Figure 3-8 Numeric Keys with Shift Pressed

While the numeric-keyboard mode is active, pressing and holding the **Shift** key causes some of the keypad keys to function as cursor and screen control keys. The character for each key, while in keypad mode with the **Shift** key pressed, is printed on the key's front surface, as shown in Figure 3-8

## Adjusting the keyboard angle

The keyboard angle is adjusted by releasing the legs on the underside of your SPARCbook which are illustrated in Figure 3-3 on page 3-6.

### Note

---

Releasing the legs aids system cooling by allowing air to circulate beneath the base casting. This ensures more reliable operation in warmer climates.

---

- Release the legs by pressing them towards the outside of the case. They pop out of their recesses into position.
- To return the legs to their storage position, press them back into the recesses where they click into place.

---

## The Pointing Stick

Your SPARCbook keyboard incorporates a Pointing Stick. This is used, together with three buttons in front of the spacebar, to emulate a 3-button mouse.

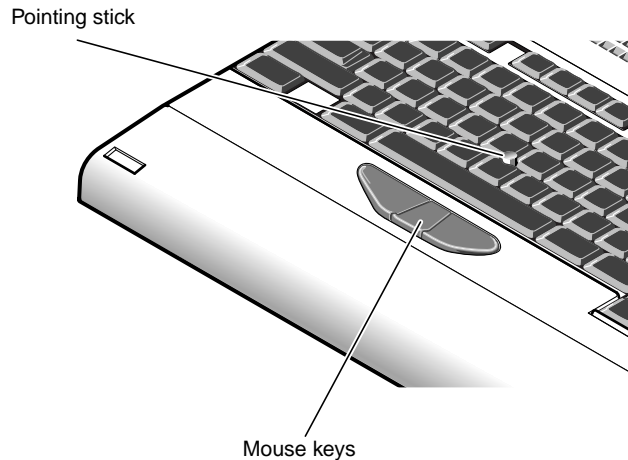

*Figure 3-9 The Pointing Stick*

The Pointing Stick can be operated with the index finger of the left or right hand while your hands are in the normal typing position. The Pointing Stick is pressure-sensitive and the cursor moves in the direction in which it is pressed at a speed corresponding to the pressure applied.

### Note

---

Under some operating conditions, the cursor may drift down or across the display without the pointing stick being pressed, or may move in one direction more effectively than it does in the other. If this happens press **Pause-Home** and hold the keys down for 3 seconds. The microcontroller will recalibrate the pointing stick.

---

---

## Status Display

The status display, located on the front of the unit below the main display, provides you with information about your SPARCbook operating status. It provides two lines of sixteen characters.

The upper line is the battery status line and provides information about the batteries. The lower line is the machine and OS status line and provides information about interface activity, external DC supply and operating system status.

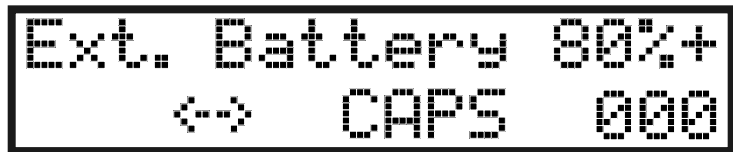

*Figure 3-10 The Status Display*

---

### Note

The battery status line on some earlier S3 models does not show a percentage number until the battery has been fully charged.



---

## Battery status

On a SPARCbook 3, the battery status line indicates whether you are running on the internal battery (Int) or an external battery pack (Ext). It also indicates the level of charge of the battery being monitored as a percentage of a full charge. The plus sign (+) indicates that the battery being monitored is receiving a charge from the AC adapter connected to the DC-In connector.

## Machine and OS status

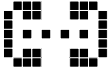
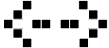
The machine and OS status line displays a row of symbols to indicate interface activity or availability.

Symbol	Name	Meaning
	DC-In Active	Indicates that your SPARCbook is receiving DC power from the external AC adapter or from a car adapter.
	WAN Active	Indicates that a wide area network connection has been established, either via the internal modem or ISDN interface.
	LAN Active	Indicates that the Ethernet interface is active and connected to a viable network.
	PCMCIA Active	Indicates the active presence of a PCMCIA card in the PCMCIA port.
 (sequence)	Disk Activity Spinner	Indicates that hard disk activity is in progress.

The three characters at the extreme right of the machine and OS status line display a hexadecimal code to indicate the status of the operating system software.

## **Main System Components**

*Status Display*



# Power Management

This chapter describes your SPARCbook's power management system. It discusses how to use internal and external batteries and a 12V car adapter.

It contains the following sections:

- Power Management System Operation ..... 4 - 2
- The Internal Battery ..... 4 - 4
- The Internal Battery Pack Charger Unit (IBPC) ..... 4 - 6
- Using an External Battery Pack ..... 4 - 8
- Using A 12V Car Adapter ..... 4 - 12

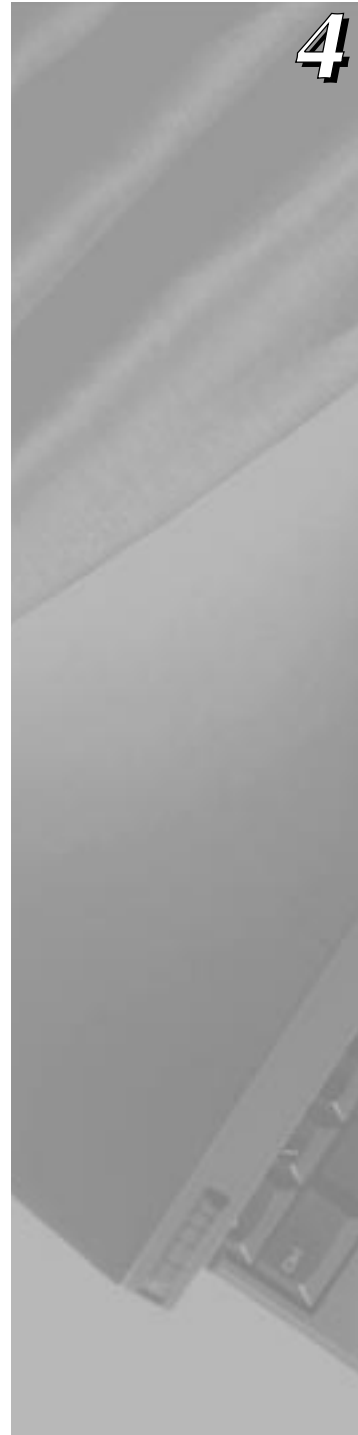

---

# Power Management System Operation

The power management system monitors the DC-In connector, external battery connector and the internal battery.

## Battery charging

Your SPARCbook detects when it is powered from the AC adapter or car adapter, automatically charges the battery and displays a DC symbol in the lower line of the status display. The charging current is adjusted according to the battery's existing level of charge and according to system temperature. The battery is charged at a faster rate until it is almost fully charged, and then the system automatically switches to a trickle charge to maintain the battery in good condition. You can use your SPARCbook as normal while the battery is being charged.

## Battery status

Battery status information is shown on the upper line of the status display. This provides an indication of the battery's level of charge, expressed as a percentage, with a plus (+) sign to indicate that it is receiving a charge or with a minus sign (-) to indicate that it is being drained. See Figure 4-1.



*Figure 4-1 The Status Display*

The power management system detects when the system is being powered from the internal battery or from an external battery pack (SPARCbook 3 models only). These conditions are shown in the status display as follows:

Int. Battery

Indicates that the internal battery's status is being displayed.

Ext. Battery

Indicates that the external battery's status is being displayed (only applies to SPARCbook 3 models).

## Battery warning LED

When your SPARCbook unit has no external DC power connected, the orange-colored battery warning LED provides a visual warning when the battery is nearing exhaustion.

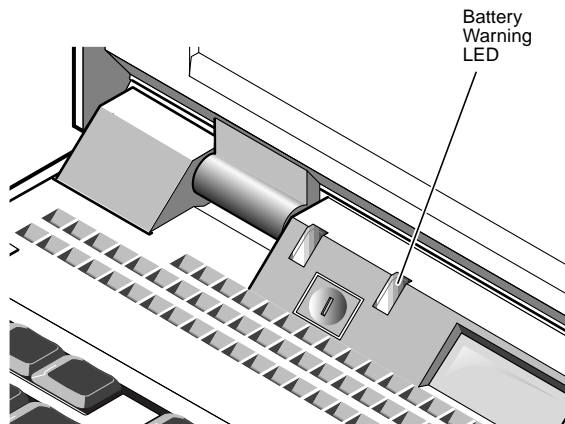

*Figure 4-2 The Battery Warning LED*

The battery warning LED provides two warning levels:

- First, the LED flashes to indicate that there are 3 to 5 minutes of battery power remaining. The LED flashes faster as this time runs down.
- Second, the LED illuminates continuously to indicate that the battery is almost completely discharged.

At the second warning, you can take one of the following actions:

- Connect the AC adapter or car adapter to charge the battery and continue working.
- Connect an external battery pack and continue working (SPARCbook 3 models only).

## Power Management

### *The Internal Battery*

- Power your SPARCbook off using Save (by pressing **Pause-O**), replace the battery with an already fully charged battery and then press the power on button to Resume where you left off.
- Save any files you may be working on and continue working until your SPARCbook performs an automatic Save.

## Maximizing battery life

The Battery and Power tools provided by the Notebook Computing Environment offer several ways for you to extend battery life, such as reducing the screen brightness when using battery power or using a slower CPU clock speed. For information about how to use these facilities, see the *NCE User Guide*.

---

## The Internal Battery

The internal battery is specially designed for use with your SPARCbook. It incorporates a number of safety features.

- It is shaped to aid correct insertion.
- It contains electrical protection against damage by short circuit.
- It is physically protected against chemical leakage or rupture.

## Operating on internal battery power

The internal battery typically powers your SPARCbook for around 45 minutes (or longer depending upon model and power saving options selected). Using any of the interfaces, particularly the Ethernet and SCSI, or an external mouse or keyboard, causes a greater drain on the battery and may shorten this period.

## Replacing the internal battery

Before removing the battery, first ensure the system is powered off and that the external power supply is disconnected. See “Installing the Battery” on page 1-3.

### Caution

---

**Do not remove the battery while your SPARCbook is running or data files may be corrupted and, in extreme cases, you may be unable to restart your SPARCbook.**

---

## Battery behavior

Your computer contains a sophisticated battery management system to ensure optimal performance from your batteries. However, for a new system or a system that has been in storage for an extended period of time, you should note the points below.



### *Self Discharge*

An inherent characteristic of the nickel metal hydride (NiMH) internal battery supplied with your computer is *self discharge*. This causes the battery to become exhausted after several weeks of storage even if it is not fitted into your computer.

Also, when it is installed in your system, the internal battery will discharge while your computer is not in use. This may take up to 3 weeks depending on the level of charge when the system was last used.



### *System behavior with an Exhausted Battery*

The charge percentage may not be shown on the status display if the battery is completely exhausted. However, the percentage appears when the battery has been *characterized* by the battery management system after it has been fully charged.

## Battery conditioning

A new battery, or one that has not been used for a long time, will store less charge than expected for the first few charge and discharge cycles. This is normal. Over the course of five charge and discharge cycles, the capacity of the battery will rise to its correct value.

---

# The Internal Battery Pack Charger Unit (IBPC)

You can recharge spare batteries using the Tadpole Series 2 Internal Battery Charger/Storage unit (T2IBPCHRG).

## Connecting the charger

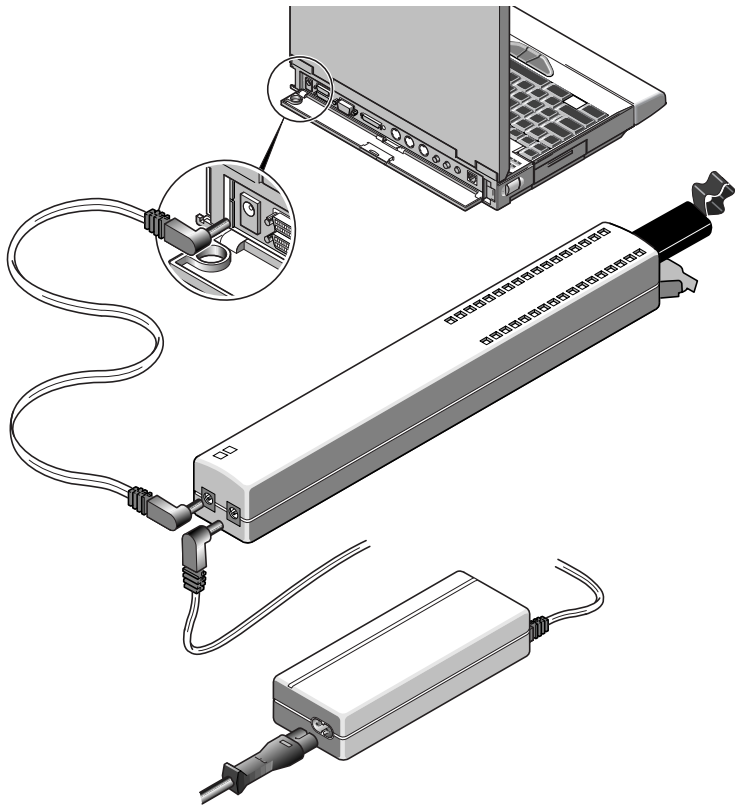

*Figure 4-3 Using the Battery Charger and Storage Unit*

Connect your battery IBPC as follows (see Figure 4-3):

- 1.** Connect the AC adapter to either DC connector on the IPBC
- 2.** Connect the supplied DC connector cable between the remaining DC connector on your IPBC and the DC-In socket on your SPARCbook.

Connecting the charger in this manner allows you to power your SPARCbook at the same time as charging a spare battery.

## **Using the charger**

To charge a battery, insert the battery, contacts first, into the battery cavity (the battery can only be inserted into the charger one way round) and close the charger door. Switch on the power from AC adapter.

The green LED on your charger illuminates when the AC adapter is connected and switched on.

The amber LED on the charger illuminates constantly when the battery is being fast charged and flashes rapidly when the battery becomes fully charged. If the battery is too hot or too cold to charge, the amber LED flashes slowly.

The charger keeps the battery in a fully charged state until it is removed.

The battery can be removed at any time by opening the door at the end of the charger and withdrawing the battery.

## **Storing the charger's cable**

The cable supplied with the charger may be stored in the cable storage area on the underside of the unit.

---

## Using an External Battery Pack

**Note**

---

This section applies to SPARCbook 3 models only.

---

To run your SPARCbook for a longer period away from an AC power supply, you can use the optional external battery pack (available from your SPARCbook dealer) which will power your SPARCbook for up to 6 hours of use from a single charge. The external battery pack allows you to use all of the interfaces, an external RHDD or floppy disk drive while away from an AC supply, although this drains the battery faster.

### Identifying the main components

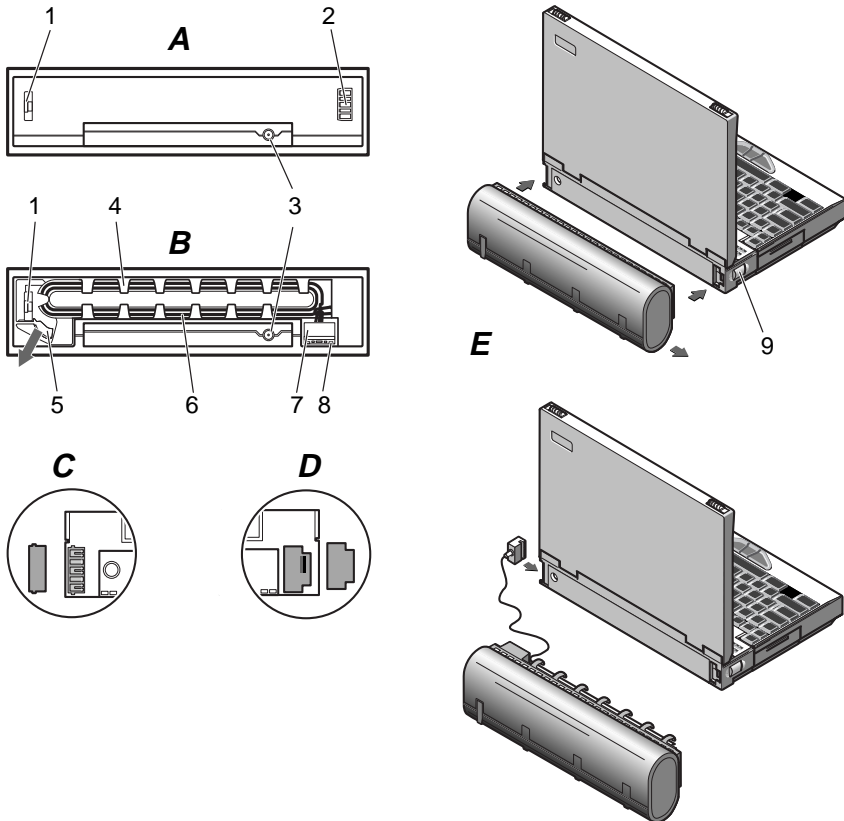

*Figure 4-4 External Battery Pack*



View *A* shows the connector side of the external battery pack, and view *B* shows the connector side of the external battery pack with the cord holder attached. Refer to views **A**, **B** and **E** in Figure 4-4 to identify the following components:

- 1.** Catch
- 2.** Battery plug
- 3.** DC-in connector
- 4.** Extension cord holder
- 5.** Release lever
- 6.** Extension cord
- 7.** Extension plug
- 8.** Stowage for extension plug
- 9.** Battery release

## **Attaching the external battery pack**

The external battery pack can be operated with your computer in one of two ways:

- By direct attachment to the rear of your computer.
- By connection with the extension cord.

### **↳ Direct Attachment**

Attach the external battery pack to your computer as follows:

- 1.** Separate the cord holder [4] from the external battery pack by pressing the release lever [5] and sliding the cord holder off the external battery pack.
- 2.** Remove the two blanking plugs, shown in views **C** and **D** from your computer.
- 3.** Attach the external battery pack to your computer by locating the catch [2] and battery plug [3] in the corresponding receptacles on your computer and sliding, as shown in view **E**.

## Power Management

### Using an External Battery Pack

#### ↳ *Attaching the Extension Cord*

It is not essential to remove the cord holder from the external battery pack. You can also connect the battery pack as follow:

1. Release the extension plug [6] from its stowage [7] and remove the blanking plug, shown in view C, from your computer.
2. Connect the extension plug by sliding it into the battery-in socket on your computer.

## Working with the external battery pack

With the external battery pack fitted, your SPARCbook operates normally. It can be powered from an AC supply, from the internal battery or from the external battery pack. The Notebook Computing Environment (NCE) software, preloaded on your computer, allows you to specify which power source is used at any time and also which battery (internal or external) is discharged first. This is described in the *NCE Guide User Guide*.

## Charging your external battery pack

To charge your external battery pack, connect the AC adapter to the DC-in connector on the *external battery pack*.

### Note

---

It is possible to plug the DC-in connector into the computer when your external battery pack is operating on the extension cord. However, this will not charge the external battery pack.

---

The external battery pack charges automatically and is charged before the internal battery. It takes 3-4 hours to completely charge a discharged battery. When the external battery pack is fully charged, it is kept topped-up with a trickle charge. The battery can still be used while it is charging, but charging takes longer.

### Note

---

The external battery pack suspends charging if it is too hot or too cold. Charging automatically resumes as soon as the battery returns to a suitable temperature.

---

The charge status and condition of the external battery pack is shown on your computer's status display. It can also be monitored using NCE. The main NCE window provides a graphical representation of the charge state of both the internal and external batteries. This is described in the *NCE Guide User Guide*.

## **Stand-alone charging**

The external battery pack can be charged while it is not connected to your computer. To do this, connect the AC adapter to the DC-in connector of the external battery pack. The external battery pack charges automatically.

## **Detaching your external battery pack**

Removal of the external battery pack is a reversal of the attachment procedure:

- 1.** Power your computer off.
- 2.** Slide the release catch on your computer [9], then slide the external battery pack off your computer.
- 3.** Replace the two blanking plugs in your computer to protect the battery-in contacts from damage.
- 4.** If required, attach the cable holder to the external battery pack.

---

### **Note**

If the external battery pack is being used on the extension cord, detach the cord by sliding the extension plug out of the connector recess on your computer.

---

## **Storing the extension cord**

The extension cord [6] can be stored in the cable holder [4], and the extension plug [7] can be stored in the stowage provided [8].

---

### Using A 12V Car Adapter

The Tadpole Series 2 12V car adapter enables you to power your SPARCbook from a 12V vehicle cigarette lighter socket. It has power handling capabilities similar to those of the AC adapter supplied with your SPARCbook and enables you to power your computer with any of the optional accessories.

#### Important safety information

**WARNING!**

---

**DO NOT OPERATE YOUR COMPUTER WHILE YOU ARE DRIVING A VEHICLE.**

---

**WARNING!**

---

**DISCONNECT YOUR CAR ADAPTER FROM THE VEHICLE POWER SUPPLY BEFORE CHANGING THE INTERNAL 5A FUSE.**

---

#### Connecting your car adapter

Connect your car adapter as follows (see Figure 4-5):

**Caution**

---

**The car adapter is suitable for 12 volt negative earth vehicles only. Operation under any other conditions may cause damage to your car adapter or to your computer.**

---

- 1.** Insert the large plug of your car adapter into your car's cigarette lighter socket.

The green LED on your car adapter illuminates when the power from your car is connected correctly.

- 2.** Connect the DC cord from your car adapter to the DC-in socket of your computer.

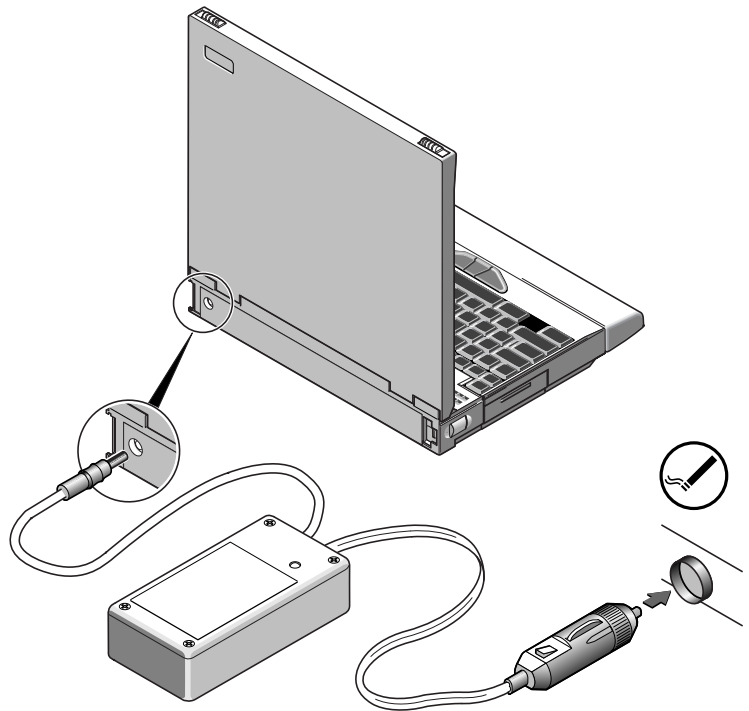

*Figure 4-5 Connecting the Car Adapter*

## **Using your car adapter**

Your SPARCbook can be operated normally while powered from your car adapter. It charges the internal battery in the same way as the AC adapter.

Your car adapter is of a high-efficiency design. However, to conserve your vehicle's battery life, you should disconnect the adapter from the cigarette lighter socket when your SPARCbook is not in use.

## **Power Management**

### *Using A 12V Car Adapter*

#### **Disconnecting your car adapter**

The car adapter can be disconnected from your computer at any time, even while your computer is operating. However, if you do disconnect your car adapter while your computer is running, observe the following:

- Disconnect at the DC-in connector before disconnecting from the cigarette lighter socket.
- Ensure that your computer has an internal battery installed.

#### **Operation during engine starts**

Voltage variations and spikes from your vehicle's power supply during engine starts can disrupt the operation of your SPARCbook. As a precaution, disconnect your car adapter from your SPARCbook before starting the engine, following the instructions in the previous section, and reconnect once the vehicle's engine is running.

# Save and Resume

This chapter discusses how to use Save and Resume. The Save and Resume feature provides an easy way to start and stop your SPARCbook without having to perform lengthy shutdown and startup procedures.

This chapter the following sections:

- How Save and Resume Functions ..... 5 - 2
- Powering Off Using Save ..... 5 - 3
- Automatic Save Features ..... 5 - 5
- Sleep mode ..... 5 - 5
- Save and Resume and Security ..... 5 - 6
- Enabling and Disabling Save and Resume ..... 5 - 7

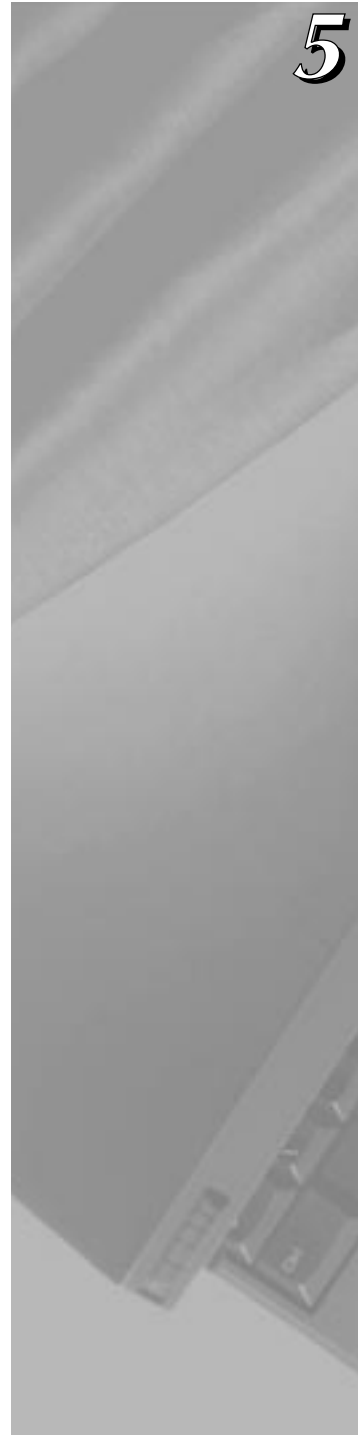

---

# How Save and Resume Functions

The operation of Save and Resume can be summarized as follows:

### ➤ Save

- Your SPARCbook copies the contents of the system's DRAM and system operating parameters onto the *save* partition on the boot disk.
- An OpenBoot status flag is set that causes your SPARCbook to look for valid Save data on the disk when you next power on.

### ➤ Resume

- If the OpenBoot save flag is set when you power on, your SPARCbook attempts to read any stored information in the *save* partition. If it finds valid Save data, it Resumes to exactly the same state in operation when the Save was initiated for *that disk*. If there is no valid save data available, your SPARCbook carries out a conventional Solaris system startup.

### The Save Partition

➤ A partition is reserved on your SPARCbook's boot disk to support the Save and Resume feature. The Save partition's size is equivalent to the main memory capacity of your SPARCbook. For example, if you have a SPARCbook with 64MB of main memory (DRAM) your SPARCbook reserves a Save partition of 64MB. See "Boot Disk Partitions" on page 6-5.

➤ SPARCbook only stores Save information to the *save* partition on the boot disk. It does not store this information anywhere else.

➤ Because your SPARCbook Resumes from the *Save* partition on the boot disk, your SPARCbook will Resume to a different session if you boot a different disk.

➤ Unexpected operations may occur if you try to Resume with a disk Saved on a SPARCbook with a different hardware configuration, such as larger main memory.



---

## Powering Off Using Save

You can initiate a Save in several ways:

- By pressing **Pause-O** on the keyboard.
- By selecting **Save Now** in the NCE Save panel.
- By selecting **Save** at the top of the main NCE window.
- By selecting **Save** from the OpenWindows desktop Utilities menu.
- By typing `save` at the Solaris root prompt.
- By closing the lid ( SPARCbook 3 models only).

The lid closed function can be enabled or disabled via the Save and Resume panel of the Notebook Computing Environment. See “Save and Resume Panel” in your *NCE User Guide*.

You do not have to close applications because they remain completely unaffected by Save and Resume, allowing you to take up work exactly where you left off.

## How to ensure Save and Resume operates successfully

Your SPARCbook Resumes most reliably if the hardware facilities are the same before and after the Save is performed.

To ensure the Save and Resume facility operates correctly, it is important that you avoid making hardware configuration changes while your system is powered off. This applies particularly to hard disks, tape drives, CD-ROMs and PCMCIA memory cards that are mounted as part of your file system, and to network connections that may change.

Your SPARCbook cannot Resume successfully to a file tree that is no longer there. To prevent problems, observe the following precautions:

- Always unmount file systems on external drives that are likely to be disconnected before you power on again.

## Save and Resume

### *Powering Off Using Save*

- Always unmount network file systems if your SPARCbook's network connection is likely to change before you power on again.
- Always disable an external display and switch to the internal display if you intend to change displays before you power-on again.

In many instances, your SPARCbook will recover from these situations but this cannot always be guaranteed.

## What to do if Resume Fails

If your system fails to Resume, carry out a full system reboot with the following procedure:

- 1.** Power off again, if necessary, by pressing **Pause-O**.
- 2.** Press the power on button.
- 3.** When the OpenBoot greeting is displayed, press **Pause-A**. The OpenBoot `ok` prompt is displayed.
- 4.** Enter the following commands:

```
ok create no-resume?  
ok boot disk
```

Your SPARCbook carries out a full system boot.

---

## Automatic Save Features

There are two automatic Save mechanisms which you can enable or disable through the Notebook Computing Environment. These are:

### Save on battery low

When the power management software on your SPARCbook detects that the battery is low, it is able to initiate an automatic Save. You can choose whether the Save occurs after the first or second warning, or you can disable the Save on low battery function altogether. See “Save and Resume Panel” in your *NCE User Guide*.

### Save on system inactivity

When your SPARCbook is unused for a specified period (that is, there is no mouse, keyboard or interface activity), it is able to perform an automatic Save. See “Power Manager Panel” in your *NCE User Guide*.

---

## Sleep mode

In addition to the Save and Resume feature, your SPARCbook provides a *Sleep* mode. The Sleep mode can be enabled via the Notebook Computing Environment. See “Save and Resume Panel” in your *NCE User Guide*.

Sleep saves the current state of your SPARCbook to the hard disk, and turns off the display and I/O devices. Unlike Save, however, Sleep does not power your SPARCbook off completely but reduces the level of battery consumption during periods of inactivity. Your SPARCbook returns to operation instantly when any key is pressed. Sleep is initiated automatically by the period of inactivity you have specified. See “Power Manager Panel” in your *NCE User Guide*.

## Save and Resume

### *Save and Resume and Security*

Your SPARCbook can be moved while in the Sleep mode and operates for typically 5 hours from a fully charged internal battery. If the battery nears discharge while it is in the Sleep mode, your SPARCbook performs a Save on low battery as described in the previous section.

---

## Save and Resume and Security

The Save and Resume feature makes your SPARCbook vulnerable to unauthorized use. This is because Resume will take the system back into your last desktop session, effectively bypassing the normal login prompts.

One way to protect your SPARCbook against unauthorized use is to remove the hard disk while it is without power. Refit it again when you next wish to use your SPARCbook, before you power on.

If this level of protection is not sufficient, you have the following options:

- Power off using a conventional Solaris system shutdown. To do this, log in as root and enter the `init 0` command.

This takes the system down to the OpenBoot prompt and a safe state for power-off. Power off by pressing **Pause-O**. The next time you power on your SPARCbook carries out a full system startup and not a Resume. See “Using Full System Startup” on page 1-8

- Disable Save and Resume altogether, see below.

---

## Enabling and Disabling Save and Resume

Although the Save and Resume feature provides an extremely convenient method of powering down and powering on again, it does present two drawbacks.

- It may compromise the security of the system, as described above.
- It requires the existence of the `save` partition on the boot disk which is the same size as the system's main memory. For example, a SPARCbook with 128MB of main memory requires a 128MB `save` partition. See "Boot Disk Partitions" on page 6-5.

If either of these issues poses a serious problem, the Save and Resume facility can be disabled. Save and Resume can be disabled with a reversible command, as described below, or can be disabled permanently by assigning the `save` partition for general data storage.



### *Disabling Save and Resume*

To disable Save and Resume, enter the following command:

```
# saveresume -n  
SAVE Partition was /dev/rdisk/c0t0d0s4
```

### **Note**

---

This example shows the `save` partition for a SPARCbook 3000 model. For a SPARCbook 3 the `save` partition is `/dev/rdisk/c0t3d0s4`. Make a note of the correct partition to use if you intend to re-enable Save and Resume later. See "Boot Disk Partitions" on page 6-5.

---

This command disables the Save commands (such as **Pause-O**) and unmounts the `save` partition. To power the system down, you can use the normal Solaris shutdown commands. For example:

```
# shutdown -i0
```

When the `ok` (OpenBoot) prompt is displayed, press **Pause-O** to power off. Restart the system in the conventional way for a desktop Solaris system.

## Save and Resume

### *Enabling and Disabling Save and Resume*

#### ➤ *Enabling Save and Resume*

To enable Save and Resume, enter the following command:

```
# saveresume -y /dev/rdisk/c0t0d0s4  
# saveresume  
SAVE Partition is /dev/rdisk/c0t0d0s4
```

---

#### **Note**

This example shows the save partition for a SPARCbook 3000 model. For a SPARCbook 3 the save partition is /dev/rdisk/c0t3d0s4. The save partition is created when the Operating System is installed from the Tadpole distribution CD.

---

# Using the Removable Hard Disk

This chapter discusses how to use your SPARCbook's removable hard disk drive (RHDD). It describes how to fit and remove the drive, how to use additional hard disks and how to ensure a basic level of security for your RHDD.

It contains the following sections:

- Overview ..... 6 - 2
- Fitting and Removing the Hard Disk ..... 6 - 3
- Caring for Removable Hard Disks ..... 6 - 4
- Boot Disk Partitions ..... 6 - 5
- Using Additional Removable Hard Disks ..... 6 - 7
- Using a Removable Hard Disk Drive Adapter ..... 6 - 9
- RHDD Security ..... 6 - 12

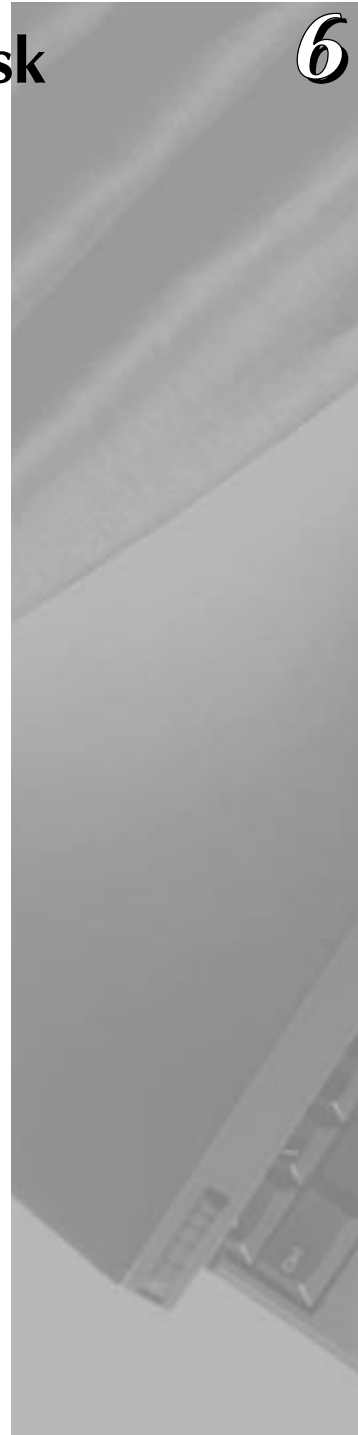

## Overview

Your SPARCbook's hard disk can be removed easily when your system is not in use and can be stored or carried separately. The removable hard disk provides you with effective data security for your SPARCbook when it is not in use and allows you to upgrade your hard disk very easily as larger capacity disk drives become available.

It is possible for you to have several boot disks for several different projects, or for different people who share a SPARCbook workstation to each have their own boot disk.

For example, you may have a disk for use in your office and another disk for use at home. Each could be stored securely when not in use and each could contain the appropriate operating system configuration for its designated location, with networking setup on your office disk and dial-up client services set up on your home disk.

Using the Save and Resume feature, each disk can store a different machine state that your SPARCbook Resumes when you next power on. This means, for example, that when you power on with your home disk fitted, your SPARCbook Resumes to the state Saved onto your home disk.

### Note

---

Your SPARCbook only stores Save data onto the `save` partition on your hard disk. When you initiate a Save, an OpenBoot flag is set in your SPARCbook's NVRAM that causes it to look for valid Save data *on the disk* when you next power up.

---



---

## Fitting and Removing the Hard Disk

Your SPARCbook is shipped from the factory with the hard disk already fitted and ready for you to use. The disk can be removed as follows:

### Caution

---

Ensure that your SPARCbook is powered OFF before removing the hard disk. Removing the hard disk while your SPARCbook is running may damage the disk and destroy important data.

---

1. Place your SPARCbook on a firm surface, such as a desk, with its left side tilted upwards slightly.
2. Slide the hard disk's catch downwards, as shown in Figure 6-1.
3. Pull on the catch to remove the disk from your SPARCbook.

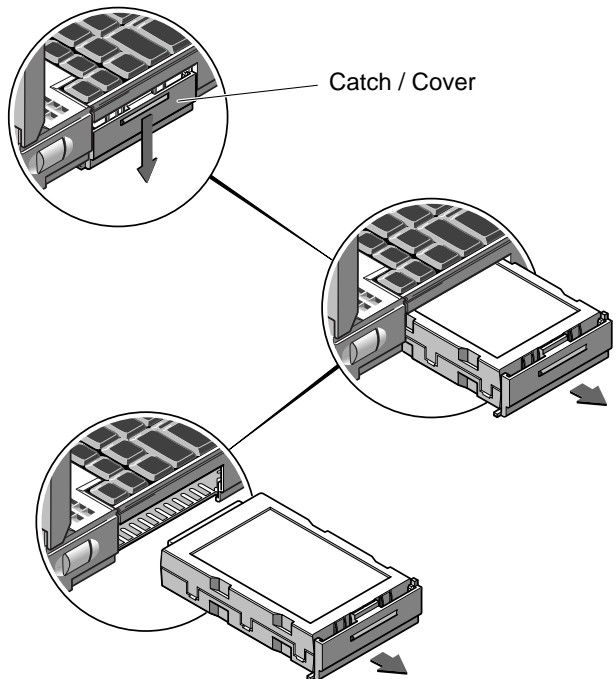

Figure 6-1 Removing the Hard Disk

---

### Caring for Removable Hard Disks

The removable hard disk is designed to be robust but should be handled with care. Follow these precautions in its use.

- **Physical shock and vibration**  
Protect the hard disk from knocks and excessive vibration. You should never remove the hard disk while your SPARCbook is running; always power off first.
- **Condensation**  
If your hard disk is carried separately from your SPARCbook and is subjected to much lower temperatures, bringing it into a warm room may cause condensation. This will not cause damage, but you should allow your hard disk time to acclimatize before using it.
- **Static electricity**  
In common with most electronic components, the removable hard disk is prone to damage due to static electric shock. To prevent such damage, avoid touching any electrical contacts on the hard disk.

## Boot Disk Partitions

The hard disk supplied with your SPARCbook is preloaded to order with the Solaris 2 operating system; the version is dependent upon availability and customer order. The removable disk is preconfigured as a boot disk and is “factory” partitioned as shown in Table 6-1.

Partition		Mount Point	Approx. Size (MB)
SPARCbook 3	SPARCbook 3000		
dsk/c0t3d0s0	dsk/c0t0d0s0	/	25
dsk/c0t3d0s1	dsk/c0t0d0s1	swap	>= DRAM
dsk/c0t3d0s2	dsk/c0t0d0s2		All disk
dsk/c0t3d0s3	dsk/c0t0d0s3	/var	72-96
dsk/c0t3d0s4	dsk/c0t0d0s4	save	Same size as DRAM
dsk/c0t3d0s5	dsk/c0t0d0s5	/opt	Remainder of disk
dsk/c0t3d0s6	dsk/c0t0d0s6	/usr	120

*Table 6-1 Removable Hard Disk Drive Factory Configured Partitions*

### Note

The partition map may differ if the hard disk has been reloaded with the Solaris operating system from the supplied CD-ROM. See “Re-installing the Operating System from CD-ROM” on page 14-8.

The *save* partition is essential to support your SPARCbook’s Save and Resume feature (see Chapter 5, “Save and Resume”) and must be the same size as the memory capacity of your SPARCbook.

The *swap* partition is used by the operating system to store applications that are running in the background. Its size, therefore, is affected by the size of the main memory of your SPARCbook.

## Model differences

The SPARCbook 3 and SPARCbook 3000 models use different types of removable hard disks, which is why different device files are used by default for the two model ranges.

## Using the Removable Hard Disk

### *Boot Disk Partitions*

SPARCbook 3 models use a SCSI removable hard disk drive which is labeled “Series 2” and has switches that set the target ID. SPARCbook 3000 models use an IDE removable hard disk drive which is labeled “IDE” and has no switches. The two types have different connectors so that it is not possible to connect the wrong type of drive to the wrong SPARCbook model.

#### ⇒ *SPARCbook 3*

The SPARCbook 3 Series use a removable SCSI hard disk with a switchable SCSI target ID, which is factory set to 3. This means that device files for the disk slices are at `/dev/c0t3d0sn`, as shown in Table 6-1. A different SCSI ID can be used for the boot disk, if required. For example, if the disk ID were set to 0 and partitioned as shown in the table, then the device files would be at `/dev/c0t0d0sn`.

#### ⇒ *SPARCbook 3000*

The SPARCbook 3000 Series use a removable IDE hard disk drive which has a fixed ID. The factory installed operating system assigns this drive as target 0 with the result that the device files for the disk slices appear at `/dev/rdisk/c0t0d0sn` as shown in Table 6-1.

### **Main Memory Upgrades and Disk Partitions**

⇒ The sizes of `save` and `swap` partitions on the boot disk are related to the main memory capacity of your SPARCbook.

⇒ The main memory is provided by two single in-line memory modules (SIMMs) which are accessible through the battery compartment. This makes it easy for the end user to perform memory upgrades without using special tools or equipment. However, if the capacity of the main memory is increased then the disk’s partition map must be changed to increase the sizes of the `swap` and `save` partitions. See “Upgrading the Main Memory” on page 15-3.

---

## Using Additional Removable Hard Disks

Additional removable hard disks are available from your SPARCbook supplier. These can be supplied preloaded with the Solaris operating system for use as an alternative boot disk, or can be supplied blank for use as additional data storage in conjunction with a removable hard disk drive adapter (RHDDA). See “Using a Removable Hard Disk Drive Adapter” on page 6-9.

Each new hard disk must be configured for your SPARCbook when it is first used. This involves:

- Setting the SCSI ID for the RHDD
- Carrying out disk configuration

---

### Note

You can only use SCSI removable hard disk drives with SPARCbook 3000 models if they are installed in a removable hard disk drive adapter. See “Using a Removable Hard Disk Drive Adapter” on page 6-9.

---

#### ➤ *Setting the SCSI ID for the RHDD*

Before you use the RHDD, you should check and, if necessary, set its SCSI ID. The SCSI ID is set with three switches located on the rear of the Series 2 RHDD as illustrated in Figure 6-2.

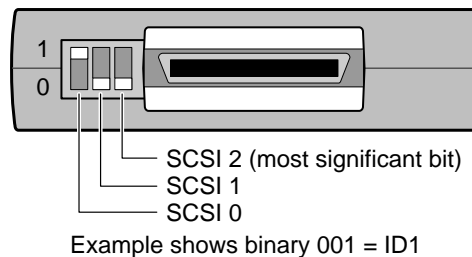

Figure 6-2 The SCSI ID Switch (Series 2 Drives only)

The three switches on the rear of the Series 2 RHDD are binary coded as shown in Table 6-2.

## Using the Removable Hard Disk

### Using Additional Removable Hard Disks









Switch Setting	Selected ID	Switch Setting	Selected ID
	0		4
	1		5
	2		6
	3 <sup>a</sup>		7 <sup>b</sup>

Table 6-2 SCSI ID Switch Settings

- a. It is recommended that you reserve ID3 for the boot disk in SPARCbook 3 models.
- b. Do not use ID7, this is permanently assigned to the SPARCbook itself.

## Configuring a boot disk

This procedure can be used for an RHDD that has been preloaded with Solaris 2 operating system. The SPARCbook uses the shell script `/Factory-config` to configure an RHDD as a boot disk. This creates the disk partitions described in Table 6-1 optimized for your SPARCbook's memory capacity.

Configure a boot disk as follows:

1. Ensure that your SPARCbook is powered off and fit your new RHDD.
2. Press the power on button.
3. When the OpenBoot greeting is displayed, press **Pause-A**. Your SPARCbook displays the OpenBoot monitor prompt.
4. At the OpenBoot prompt, type the following command:  
`ok boot disk:h`
5. Your SPARCbook boots to single user mode and displays the # prompt. Enter the following command:  
`# /Factory-config`
6. Press the **Return** key for the process to begin and follow the displayed instructions.

## Configuring a hard disk for additional storage

The procedure for doing this is described in “Configuring an External Hard Disk – Worked Example” on page 7-6.

---

## Using a Removable Hard Disk Drive Adapter

The removable hard disk drive adapter (RHDDA) can be used to connect an additional Series 2 removable hard disk drives to the SCSI port of your SPARCbook. The RHDDA is connected to the SCSI port on the I/O panel of your SPARCbook and draws power from the SPARCbook’s SCSI port. It does not require a separate power supply.

### Note

---

Only Series 2 removable hard disk drives can be used with the RHDDA. The removable hard disk drive supplied with SPARCbook 3000 models is a different type and can only be used internally.

---

### ➤ *Connecting the RHDDA*

Connect the RHDDA to your SPARCbook as follows:

- 1.** Ensure your SPARCbook is powered off.
- 2.** Connect the RHDDA to the SCSI port on your SPARCbook using the cable supplied with the RHDDA.
- 3.** If necessary, use the remaining SCSI connector on the rear of the RHDDA to connect to other SCSI devices. Because it takes power from the SPARCbook, the RHDDA should be connected nearest to the SPARCbook.
- 4.** Install and configure an RHDD as described below.

## Using the Removable Hard Disk

### *Using a Removable Hard Disk Drive Adapter*

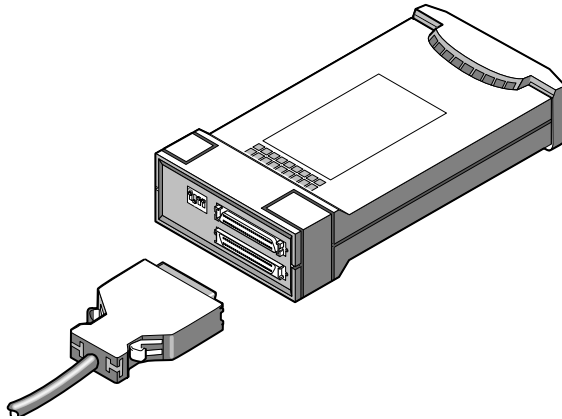

*Figure 6-3 Connecting an RHDDA*

#### **➤** *Inserting an RHDD*

- 1.** Before inserting the drive, set the drive's SCSI ID, as described in "Setting the SCSI ID for the RHDD" on page 6-7. The RHDDA does not have a SCSI ID of its own but takes its ID from the RHDD installed in it.
- 2.** Slide the drive's integral catch/cover downwards; see Figure 6-4.
- 3.** Tilt the front of the RHDDA upwards slightly and slide the drive into place until you feel the connectors engage.
- 4.** Slide the drive's catch/cover upwards to lock the drive in place.
- 5.** Configure the drive as described in "Using Additional Removable Hard Disks" on page 6-7.



➤ **Removing an RHDD**

Before removing the RHDD from an adapter, ensure that there are no disk operations in progress and unmount any file systems on the drive.

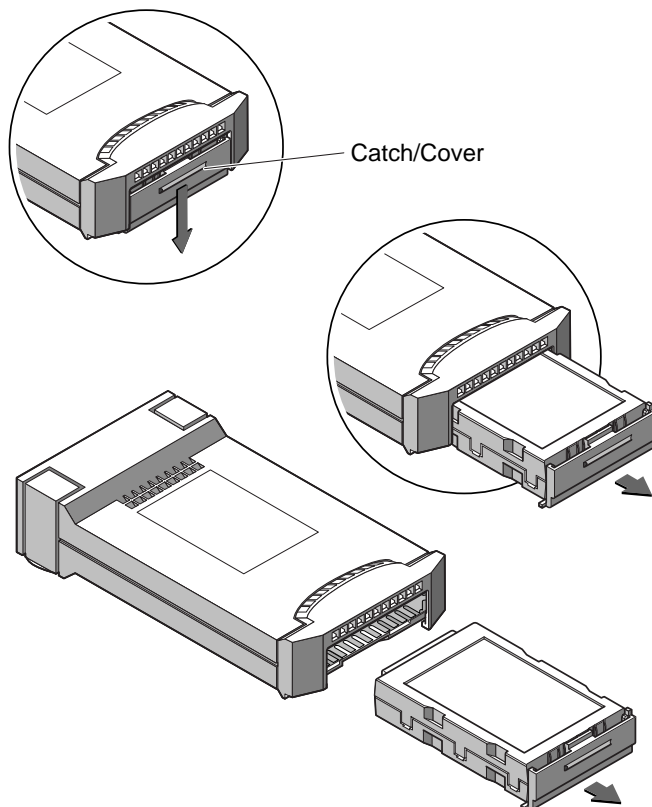

*Figure 6-4 Removing an RHDD From an Adapter*

Remove the drive by sliding the catch/cover downwards and sliding the drive out of the adapter.

➤ **Setting the SCSI Terminator**

The RHDDA contains a switchable terminator. The terminator must be active if the RHDDA is the only SCSI device connected to the SPARCbook.

## Using the Removable Hard Disk

### RHDD Security

The terminator is set by setting the terminator switch, shown in Figure 6-5, to the *down* position. The other three switches have no function.

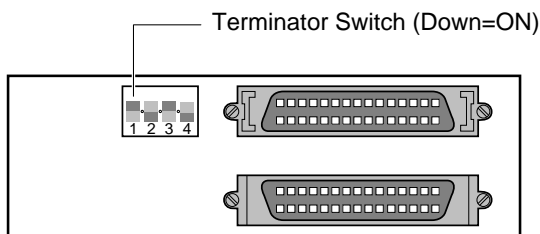

Figure 6-5 The RHDDA Terminator Switch

---

#### Note

Correctly set SCSI terminators are essential to the reliable operation of devices connected via SCSI chain. See “SCSI Terminators” on page 7-4.

---

---

## RHDD Security

The RHDD provides your system a basic level of security by allowing you to remove it from your SPARCbook when it is not in use and storing it separately. However, it is equally possible for the RHDD to be removed by an unauthorized person. The RHDD can be removed and installed into a similar SPARCbook allowing your files and applications to be accessed.

Unauthorized access can be prevented by using the Security panel provided by NCE. This allows you to specify the serial numbers of up to six SPARCbooks that are permitted to access your RHDD. Any other systems are denied access.

For details about using the NCE Security panel, see the *NCE User Guide*.

# Using SCSI Devices

This chapter describes how to connect and use external SCSI devices. It describes how to set the SCSI ID and termination correctly and provides an example of how to configure an external hard disk.

It provides the following information:

- Overview ..... 7 - 2
- Connecting SCSI Devices ..... 7 - 3
- SCSI Terminators ..... 7 - 4
- SCSI IDs ..... 7 - 4
- Configuring an External Hard Disk – Worked Example ... 7 - 6
- Using a Tadpole SCSI Floppy Disk Drive ..... 7 - 11

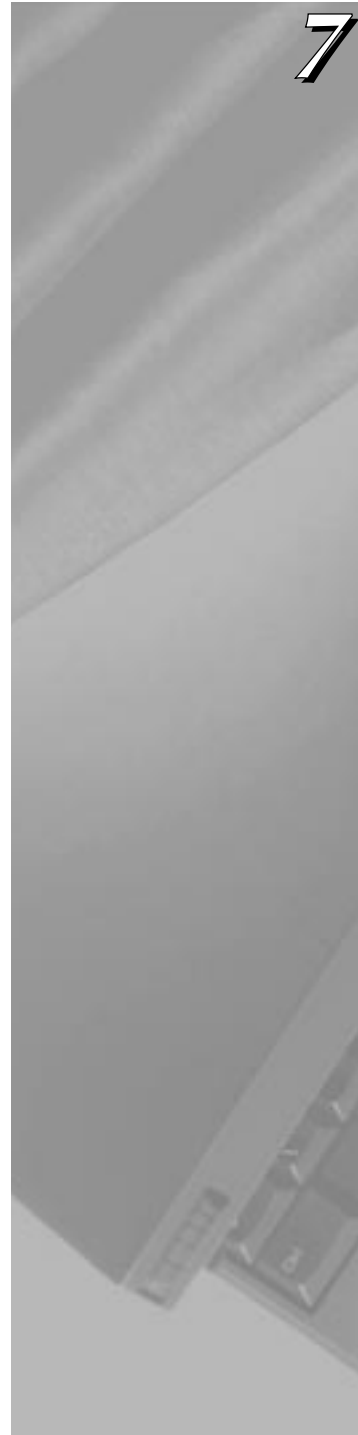

---

## Overview

Your SPARCbook provides a single-ended small computer system interface (SCSI) via the I/O panel at the rear of the unit. An industry-standard 50-pin high density SCSI-2 connector is provided. See “I/O Panel” on page 3-7.

### How to Ensure Reliable SCSI Operation

☞ To ensure reliable operation of SCSI devices with your SPARCbook, always follow these hints:

✗ Do not connect too many devices to your SPARCbook.

You can connect six external devices to SPARCbook 3 models or seven to SPARCbook 3000 models.

✗ Do not exceed the maximum recommended SCSI cable lengths. See the documentation for your SCSI devices.

✓ Select a different SCSI ID (or *target ID*) for each device on the chain.

The default SCSI ID of the removable hard disk supplied in SPARCbook 3 models is ID3.

✓ Ensure that the SCSI chain is correctly terminated. The chain must be terminated at each physical end, but there must be no other terminators in the chain.

✓ Always connect your SPARCbook at one physical end of the SCSI chain because your SPARCbook has permanently fixed terminators.

✓ Power on the SCSI devices before powering on your SPARCbook.

---

## Connecting SCSI Devices

SCSI devices are connected to the SPARCbook in a *daisy chain* arrangement, as illustrated in Figure 7-1.

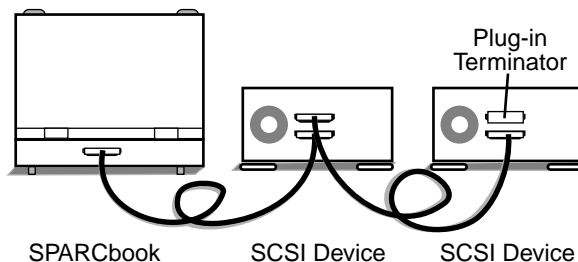

Figure 7-1 A SCSI Daisy Chain

### Maximum number of devices supported

A SCSI chain supports up to eight devices connected along its length. The SPARCbook itself counts as one device and the internal hard disk of SPARCbook 3 models counts as another. This means that up to six external SCSI devices can be connected to SPARCbook 3 models, and up to seven external devices can be connected to SPARCbook 3000 models (which have an IDE internal hard disk).

### SPARCbook positioning

Some SCSI devices provide two connectors so that they can be located in any position along the chain. The SPARCbook has only one connector because it should be located at the end of the chain.

---

## SCSI Terminators

To ensure reliable operation of your SPARCbook and external SCSI devices, you must use an *active* terminator at the end of the SCSI chain. The SPARCbook unit contains permanently fixed terminators and should, therefore, be positioned at one end of the SCSI chain while the device at the far end of the chain will need terminators fitted or enabled.

Some SCSI devices, such as the Tadpole Removable Hard Disk Adapter (RHDDA), contain built-in switchable terminators (see “Setting the SCSI Terminator” on page 6-11) which can be enabled or disabled as appropriate. Where this is not the case, you can obtain plug-in terminators that can be installed on the vacant connector on the device at the end of the chain, as illustrated in Figure 7-1.

### Note

---

A SCSI terminator is a type of resistor network which prevents interference occurring between conductors within the interconnecting cables, and so improve reliability. However, terminators must not be fitted to other devices in the chain as this will cause unreliable operation.

---

---

## SCSI IDs

To allow data on individual drives to be accessed, each device connected to the chain must have a unique address, or SCSI *target ID*. A device’s target ID is not related to its physical position within the daisy chain. IDs are usually assigned in keeping to operating system convention to devices according to type. For example, under Solaris 2.x, a CD-ROM is assigned to SCSI ID 6 and the SPARCbook system is assigned to ID 7.

### Note

---

The boot disks in the SPARCbook 3 and SPARCbook 3000 models are of different types and therefore have different identities. The SPARCbook 3’s removable hard disk is a SCSI disk and the SPARCbook 3000’s hard disk is an IDE device.

---

Every drive has one or more special files associated with it, according to its type function. For example, a hard disk has a block data file and raw data file associated with each partition in the form:

```

/dev/dsk/c0t2d0sn      block data special file
/dev/rdisk/c0t2d0sn   raw data special file

```

Table 7-1 summarizes the assignment of drive IDs for Solaris 2.x on SPARCbook 3 and SPARCbook 3000 models and the special files associated with those IDs.

SCSI ID	Special Files		Function
	SPARCbook 3	SPARCbook 3000	
0	/dev/c0t0d0s[0-7]	/dev/c4t0d0s[0-7]	External Hard Disk Drive
1	/dev/c0t1d0s[0-7]	/dev/c4t1d0s[0-7]	External Hard Disk Drive
2	/dev/c0t2d0s[0-7]	/dev/c4t2d0s[0-7]	External Hard Disk Drive
3	/dev/c0t3d0s[0-7]	/dev/c4t3d0s[0-7]	SPARCbook 3: Removable Hard Disk Drive (with root partition)
			SPARCbook 3000: External Hard Disk Drive
4	/dev/c0t4d0s[0-7]	/dev/c4t4d0s[0-7]	External Hard Disk Drive/Second CD-ROM Drive
5	/dev/diskette		Tadpole External Floppy Disk Drive
	/dev/rmt/0		Tape Drive
6	/dev/c0t6d0s[0-7]	/dev/c4t6d0s[0-7]	First CD-ROM Drive
7	-		System Unit

Table 7-1 SCSI Device Assignments

---

## Configuring an External Hard Disk – Worked Example

The basic procedure for installing an external hard disk drive with a SPARCbook is as follows:

- Connect the drive with termination and SCSI ID correctly set.
- Power the system up and enter a command so that the necessary special files are created.
- Format (if necessary) and partition the hard disk.
- Create and check a file system on each disk partition (or slice).
- Create a mount point and mount the filesystem(s).

These steps are described in a worked example below. The example uses a preformatted drive with a SCSI ID of 2 which is connected to the SCSI port of the SPARCbook. The disk has one partition.

### ➤ *Connecting the drive*

The SCSI ID for a hard disk can be set to 0 (zero), 1 or 2 (see Table 7-1). The removable hard disk on SPARCbook 3 models has its ID set to 3 by default so this ID should not normally be used for an external drive.

If the external drive is the only external device or if it is connected to the end of the SCSI chain, it should have the terminator enabled.

### ➤ *Creating special files – boot time*

Before filesystems can be created on the new hard disk, special files for the new partitions must exist. To create the special files during the boot process the following procedure is used:

- 1.** Press the power on button.
- 2.** When the OpenBoot start-up screen is displayed, press **Pause-A**.



```
Tadpole S3 SPARCbook, keyboard present
ROM Rev 2.15 V1.00
32 MB memory installed, Serial #10683270
Ethernet address 0:0:83:a3:3:86, Host ID: Host ID:
80a30386
```



```
Initializing memory -
Type help for more information
ok
```

### 3. Enter the following command:

```
ok create no-resume?
ok boot -r
```

The `-r` option causes the SPARCbook to carry out hardware reconfiguration. In this example, the SPARCbook detects the external hard disk and creates the necessary special files to allow the filesystem(s) on the new hard disk to be accessed.

The SPARCbook creates both block and raw device files in the `/dev/dsk` and `/dev/rdisk` directories, respectively, for each of eight possible slices (partitions). Thus, in the case of the example drive with a SCSI ID of 2, the following special files are created:

```
/dev/dsk/c0t2d0sn
/dev/rdisk/c0t2d0sn
```

Where:

- `c0` defines the SPARCbook system's internal SCSI controller, in this case 0 (zero). In the case of a SPARCbook 3000, this would be 1.
- `t2` defines the SCSI target address, in this case 2.
- `d0` defines the drive number, which is normally 0 (zero) in the case of a drive with an embedded SCSI controller.
- `sn` defines the disk slice, where `n` is a number between 0 and 7.

---

#### Note

Historically the target ID identified a SCSI *controller* card to which there might be connected one or more disk drives or tape drives. The current tendency is for drives to have a built-in (or *embedded*) SCSI controller in which case the drive ID is most often 0 (zero).

---

## Using SCSI Devices

### *Configuring an External Hard Disk – Worked Example*

#### ➤ *Creating special files – on a live system*

It may be necessary to add an external disk drive to a SPARCbook without powering the system down in order to allow uninterrupted access to available SPARCbook filesystems.

In this case, the block and raw device files, described above, can be created as follows:

1. Become superuser
2. Enter the following commands:

```
# drvconfig -i sd
# disks
```

#### ➤ *Creating disk partitions*

The next step is to create the required disk partitions (or slices). The disk can be organized into up to eight partitions numbered 0 to 7. In this example, one partition is created on slice 2, which occupies the entire disk.

The disk is partitioned as follows:

1. Become superuser
2. Enter the following command:

```
# format
Searching for disks...done

AVAILABLE DISK SELECTIONS:
  0. c0t2d0 <IBM-DVAS-2810 cyl 6183 alt 2 hd 8 sec 32>
    /iommu@0,
10000000/sbsus@10001000/espdma@8400000/esp@4,88000000/sd@2,0
  1. c0t3d0 <TOSHIBA-MK2428FB cyl 4000 alt 2 hd 8 sec 32>
    /iommu@0,
10000000/sbsus@10001000/espdma@8400000/esp@4,88000000/sd@2,0

Specify a disk (enter its number): 0
```

The information displayed for the disks will vary from system to system but should provide information about the drive vendor, drive model and drive characteristics. In this example, a note is made of the number of cylinders that the new drive has, in this case 6183, which is required for disk partitioning.

## Caution

---

Take care to enter the correct drive number. Errors made during this process could damage the filesystem on the boot disk with consequent data loss.

---

```
selecting c0t2d0:
[disk formatted]

FORMAT MENU:
  disk           - select a disk
  type           - select (define) a disk type
  partition      - select (define) a partition table
  current        - describe the current disk
  format         - format and analyze the disk
  repair         - repair a defective sector
  label          - write label to disk
  defect         - defect list management
  backup         - search for backup labels
  verify         - read and display labels
  save           - save new disk/partition definitions
  inquiry        - show vendor, product and revision
  volname        - set 8-character volume name
  quit

format> partition

PARTITION MENU:
  0              - change '0' partition
  1              - change '1' partition
  2              - change '2' partition
  3              - change '3' partition
  4              - change '4' partition
  5              - change '5' partition
  6              - change '6' partition
  7              - change '7' partition
  select         - select a predefined table
  modify         - modify a predefined partition table
  name           - name the current table
  display        - display the current table
  label          - write partition map and label to the disk
  quit
```

In this example, partition 6 is being defined and is going to occupy the entire disk. The disk in this case has 6183 available cylinders, as displayed at the specify a disk prompt.

```
partition> 6

Part  Tag          Flag  Cylinders   Size   Blocks
 2    unassigned    wm     0           0      (0/0/0) 0

Enter partition id tag[unassigned]:<RETURN>
Enter partition permission flag [wm]:<RETURN>
Enter new starting cyl[0]:<RETURN>
Enter partition size [0b, 0c, 0.00mb]:6183c
```

## Using SCSI Devices

### Configuring an External Hard Disk – Worked Example

Once the partitions have been defined, the resulting partition table looks like this:

```
partition> print
Part Tag      Flag  Cylinders  Size    Blocks
0  unassigned  wm    0          0      (0/0/0)    0
1  unassigned  wm    0          0      (0/0/0)    0
2  unassigned  wm    0          0      (0/0/0)    0
3  unassigned  wm    0          0      (0/0/0)    0
4  unassigned  wm    0          0      (0/0/0)    0
5  unassigned  wm    0          0      (0/0/0)    0
6  unassigned  wm    0 - 6179  772.50 (6180/0/0) 1582080
7  unassigned  wm    0          0      (0/0/0)    0
```

Having defined the required partitions, the partition map is written and the disk labeled with the following commands:

```
partition>label
Ready to label disk, continue? y
partition>quit
format>quit
#
```

#### ➤ Create and then check a filesystem on the new disk

1. Become superuser.
2. At the Solaris prompt, enter the following commands:

```
# newfs /dev/rdisk/c0t2d0s6
# fsck /dev/rdisk/c0t2d0s6
```

#### ➤ Create a mount point and mount the filesystem

In this example, a new directory is created in the root directory to provide the mount point, and then the new filesystem is mounted. This is carried out at the Solaris prompt with the following commands:

```
# cd
# mkdir /external
# mount /dev/dsk/c0t2d0s6 /external
```

Filesystems can be mounted automatically at boot time by creating an entry in the `/etc/vfstab` file for each filesystem to be mounted. The file can be edited by the superuser. The new entry contains information about the filesystem's special files, intended mount point, filesystem type and filesystem checking option.

---

## Using a Tadpole SCSI Floppy Disk Drive

The SPARCbook SCSI floppy disk drive (SFDD) is designed for use with all SPARCbook and SPARCbook 3000 models. It draws power from your SPARCbook's SCSI port so does not require a separate power cable. Any additional SCSI devices must, however, be powered separately.

### Caution

---

**The floppy drive is powered from the SCSI port of your computer. Powering more than one floppy drive, or a floppy drive and a removable hard disk drive adapter at the same time may cause damage to your SPARCbook.**

---

The procedure for installing and using the SFDD is as follows:

- Connect the drive.
- Set the SCSI ID and terminator switches.
- Power up the system and enter a command to create the necessary special files so that data on floppy disks can be accessed.
- Format floppy disks (to prepare blank disks for data storage).
- Create a mount point

## Using SCSI Devices

### Using a Tadpole SCSI Floppy Disk Drive

#### ➤ Connecting The Floppy Disk Drive

Connect the SCSI floppy disk drive to the SCSI port of your SPARCbook. You can use the remaining (female) connector on the rear of the floppy drive to connect another SCSI device, if required.

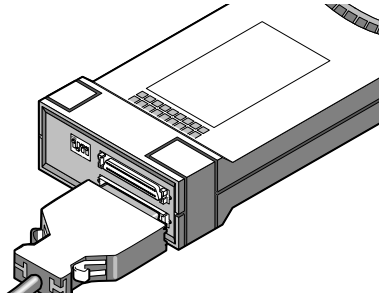

Figure 7-2 Connecting the SCSI Floppy Disk Drive

#### ➤ Setting the SCSI ID Switches

Like all SCSI devices, your floppy drive must have a unique SCSI ID. You set the SCSI ID for your floppy drive using the three SCSI ID switches shown in Figure 7-3. In order to avoid conflicts with other devices, it is recommended that you set the SCSI ID to 5.

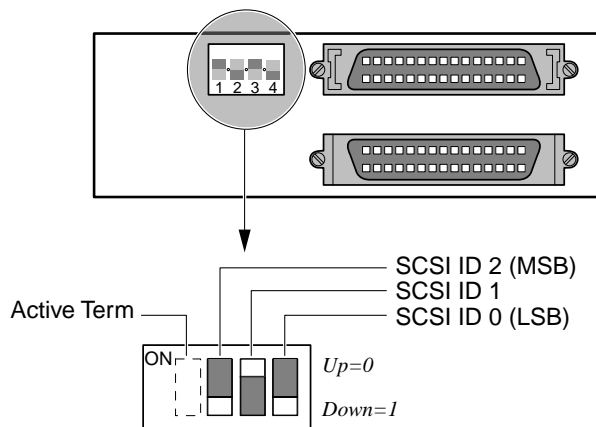

Figure 7-3 SCSI Floppy Disk Drive DIP Switches

#### Note

---

The switches on the floppy drive are wired internally for “active low” operation. This results in the position labeled on the switch as “ON” corresponding to binary 0 (zero).

---

### ➤ *Setting the SCSI Terminator Switch*

If the floppy drive is the only external SCSI device connected to your SPARCbook or is at the end of the SCSI chain, enable the built-in terminator by moving the **ACTIVE TERM** switch to the Down position. (Ignore the ON legend printed on the switch.)



Figure 7-4 Terminator Switch

If your floppy drive is not connected at the end of the SCSI chain, disable the terminators by moving the **ACTIVE TERM** switch to the *Up* position.

### Note

---

Only the device at the physical end of the SCSI chain should be terminated. All other devices should have their terminators removed or switched off.

---

### ➤ *Creating the Special Files – at Boot Time*

Before filesystems can be created or accessed on a floppy disk, special files must exist. To create the special files during the boot process the following procedure is used:

1. Press the power on button.
2. When the OpenBoot start-up screen is displayed, press **Pause-A**. The OpenBoot ok prompt is displayed.
3. Enter the following command:

```
ok boot -r
```

The `-r` option causes the SPARCbook to carry out hardware reconfiguration. In this example, the SPARCbook detects the floppy disk drive and creates the following raw and block special device files to allow the data on a floppy to be accessed:

```
/dev/diskette
/dev/rdiskette
```

## Using SCSI Devices

### Using a Tadpole SCSI Floppy Disk Drive

#### ➤ *Creating the Special Files – on a Live System*

To create the special files on a live system without having to reboot, login as the root user, then type:

```
# drvconfig -i sf
# devlinks
```

You can now use your floppy drive as you would use the built-in floppy drive on a Sun workstation.

### Inserting and Ejecting a Floppy Disk

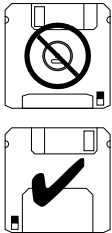

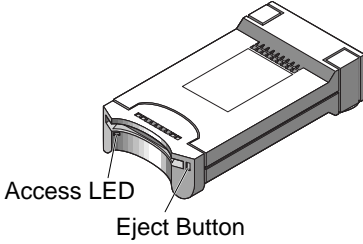

➤ To insert a floppy disk, hold it label side up and slide it into the aperture until it clicks into place.

➤ You can remove the disk from the drive at any time, provided the system is not currently accessing the disk. You should use the `unmount` or `eject` commands before removing the floppy. See below.

➤ To remove a floppy disk, press the eject button.

➤ Only use Save and Resume with a floppy mounted and running if your SPARCbook is going to Resume with the same floppy drive, with the same SCSI ID, with the same floppy disk inserted and with the floppy disk data in the same condition. See “How to ensure Save and Resume operates successfully” on page 5-3.

#### ➤ *Formatting a Floppy Disk*

### Caution

---

**Because the process of formatting destroys any data that is already on the disk. Make sure that any disks you format are either new (and, therefore, previously unused) or hold data that is no longer wanted.**

---



Format a floppy disk by using the `fdformat` command at the Solaris prompt:

```
% fdformat          to format a 1.44Mbyte high density floppy
% fdformat -l       to format a 720Kbyte low density floppy
```

The `fdformat` command partitions the floppy disk following the standard Sun convention, as shown in Table 7-2.

Partition	Start Track	End Track
a	0	$n-2$
b	$n-2$	$n-1$
c	0	$n-1$

Table 7-2 Floppy Disk Partitions

**Caution**

---

**Do not remove the disk from the drive while it is being accessed. Disk access is indicated by the Disk Access LED.**

---

➤ *Mounting a Floppy onto a Filesystem*

Mounting the floppy makes the data on the disk appear as part of the standard filesystem of your SPARCbook, although this is at the expense of some storage capacity of the disk which is used to store filesystem information.

Under UNIX, you can directly mount a floppy disk with either an MS-DOS or a UNIX filesystem.

Formatted disks that you want to use as mounted filesystems must have a filesystem on them. To make a UNIX filesystem, become root and enter the following command:

```
#/usr/sbin/newfs /dev/rdiskette
```

Before you can use the filesystem on the disk, you must first mount the disk. To do this, enter the following command:

```
# mount /dev/diskette /floppy
```

## Using SCSI Devices

### Using a Tadpole SCSI Floppy Disk Drive

The default mount point for MS-DOS filesystems is `/pcfs`. The default mount point for UNIX filesystems is `/floppy`. Before you stop using the filesystem on the floppy, you should unmount the disk using the `umount` command:

```
# umount /floppy
```

#### Caution

---

**Do not remove a floppy disk from the drive while the drive is *mounted*. Instead, use the `umount` command or the `eject` command, before you remove the disk.**

---

Refer to the SunSoft Solaris documentation for information about making MS-DOS filesystems or for further information about the `mount`, `umount` and `eject` commands.

#### ➤ *Using a Disk as a Raw Storage Medium*

Using the disk as a raw storage medium gains the maximum amount of storage space available on the disk. You can use standard UNIX commands to read the contents of a disk by giving the device name as the input stream. For example, the following command would display the contents of the disk on the screen:

```
% cat /dev/rdiskette
```

A number of commands can be used specifically to archive data to and from floppy disk and tape devices. For example, `tar`, `dd`, `cpio` and `eject`.

For information about these commands refer to the manual pages.

# Using the Network Interface

This chapter provides an introduction to networking concepts, with particular regard to portable computing and describes how to connect your SPARCbook to a network and configure the network interface.

This chapter contains the following sections:

- Network Terminology ..... 8 - 2
- Connecting Your SPARCbook to a Network ..... 8 - 3
- An Overview of TCP/IP Networking and the Internet ..... 8 - 4
- Configuring Your SPARCbook for a TCP/IP Network ..... 8 - 9
- Sharing Filesystems ..... 8 - 13
- Executing Remote Commands ..... 8 - 18

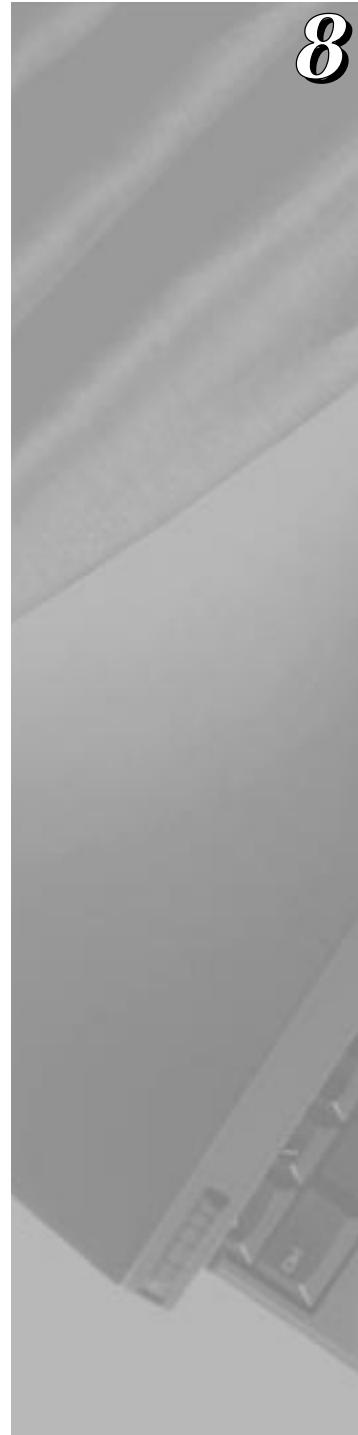

---

# Network Terminology

Some of the terms used in this chapter are explained below:

- AUI** Attachment Unit Interface. A widely-used standard Ethernet connection and electrical interface.
- Client** A network *client* machine is a system that uses the services provided by a server machine for disk storage space, printer access or some other network-wide service.
- Domain** The name assigned to a group of machines within an organization on a site is called a *domain*.
- DNS** Domain Name Service (DNS). A service that allows systems on a network to find out the names of other systems on a network from a server.
- Hostname** The name given to a computer so that it can be referred to easily by other users on the network.
- Internet** The name given to a wide area network that spans the world. Many computers connected to an Ethernet local area network (LAN) are part of or have access to the Internet.
- IP Address** A unique number assigned to each machine on the network. Each system address has a corresponding system name, or hostname.
- NFS** The Network File System (NFS) allows you to use directories or files on a remote machine as if they were actually on your own computer.
- NIS** Network Information Service (NIS). A service that allows systems on a network to find out the names of other systems on a network from a server. This is not recommended for SPARCbooks that are frequently operated away from the network.

- Server** A machine that provides services to other machines on the network, such as providing network-wide disk, backup or printing services.
- TCP/IP** Transmission Control Protocol/Internet Protocol (TCP/IP) is a family of protocols that determine how data is transferred across a network.

---

## Connecting Your SPARCbook to a Network

### Note

---

Your SPARCbook can be connected to a network via the built-in network interface or via a PCMCIA adapter card. See Chapter 10, “PCMCIA Interface”.

---

There are several different types of physical media to which the SPARCbook’s Ethernet interface can be connected. These include:

- Thick wire Ethernet or 10Base5
- Thin wire Ethernet or 10Base2
- Twisted pair or 10BaseT

To connect your SPARCbook to any of these media types a transceiver is required. A wide range of transceivers are available from third-party vendors that can be used to connect between the industry standard connector on the SPARCbook and the physical media.

Your SPARCbook provides 26-pin mini D-type connector located on the I/O panel, as illustrated in Figure 8-1.

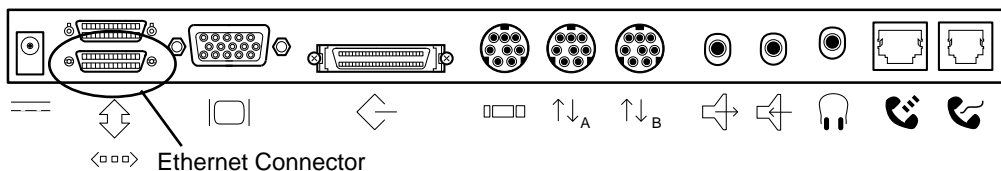
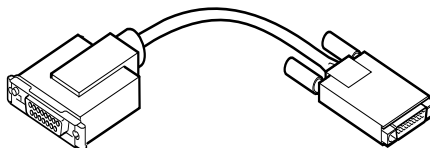

Figure 8-1 Ethernet Connector

## Using the Network Interface

### *An Overview of TCP/IP Networking and the Internet*

A cable adapter is available to allow you to connect between the 26-pin mini D-type and a 15-pin D-type AUI cable.



*Figure 8-2 Ethernet Cable Adapter*

Before you can operate your SPARCbook on a network, it must be correctly configured, as described in “Configuring Your SPARCbook for a TCP/IP Network” on page 8-9.

---

## An Overview of TCP/IP Networking and the Internet

All computers connected to an Ethernet network, either directly or via a telephone line, can potentially access computers all over the world via the Internet. For this to be possible, every computer needs a unique identity so that data and messages can be sent and received anywhere in the world.

Although an in-depth study of networking is beyond the scope of this manual, this section provide a useful overview of how the Internet uses a system of network domains and internet protocol (IP) addresses to make data communications possible over the Internet.

### Internet addresses

Every device connected to a network must have a unique address and must know the address of every other machine on the network that it is going to communicate with. *Internet Protocol* (IP) addresses are used to uniquely identify each machine on the Internet throughout the world. IP address allocation is normally managed by a single person at a particular site, often called the *system administrator*, who is responsible for the reliable operation and security of an organization’s network.

**Note**

---

If you do not belong to an organization with its own internal network, you may gain access to the Internet via a modem through a local Internet Service Provider (ISP).

---

**Classes of Address**

IP addresses consist of 32 bits and are normally written as four decimal numbers each in the range 0-255 and separated by periods. IP addresses have the following form:

a . b . c . d

For example, a typical IP address for a computer might be:

192 . 3 . 4 . 56

Any leading zeros are discarded.

The address functions in two parts: the first is used to identify a particular network; and the second is used to identify an individual computer, normally called a *host*, attached to that network. The proportion of the address used for each function depends upon the class of the network. There are three network classes, as summarized in Table 8-1.

Class	Range	Network Portion	Host Portion	Likely Usage
A	1-126	a	b.c.d	Only the largest networks are assigned Class A addresses. Each Class A network has over 16 million available addresses.
B	128-191	a.b	c.d	Large organizations and groups of subnetworks sometimes have a Class B address. The first and second number are assigned by the NIC, providing over 65000 available addresses for each Class B network.
C	192-224	a.b.c	d	Networks for the majority of companies are Class C networks. The first three numbers are allocated by the NIC, providing up to 254 available hosts for each Class C network.

Table 8-1 Network Classes

## Using the Network Interface

*An Overview of TCP/IP Networking and the Internet*

The majority of smaller organizations use class C addresses, which provide 254 possible host addresses on their network. By convention, host address 0 is used to represent the network itself and 255 is used as a broadcast address. A message sent as a broadcast on a network is received by every other host attached to that network.

In addition, address 127.0.0.1 is used as a *loopback address*; data sent to this address is transmitted back to the same host for testing. This address is usually given the hostname *localhost* in the `/etc/hosts` file (described later in this chapter).

### Addresses used by systems not connected to the Internet

By convention, sites that are not connected to the Internet use 192 or 193 as part a of their network address. However, even if you do not intend to access the Internet immediately, you are advised to obtain an official Internet address for your site. See “Registering Internet addresses” on page 8-8.

### Network names

Although IP addresses provide computers with an efficient means of identifying the source and destination of data and messages transmitted across the Internet, it is much more intuitive for humans to use names. TCP/IP provides a flexible naming system which allows this.

The global Internet is organized into a hierarchical structure of *domains* that follow the network’s organizational and geographical structure. At the top level, or *root domain*, the Internet is organized into a number of domains which reflect the type of organizations or geographical territories within them. For example, `.com` identifies a *domain* used by commercial organizations most often in the United States. There also exist codes for individual countries such as `.uk` for the United Kingdom or `.fr` for France.

Commercial companies, educational establishments and government departments can access the Internet within these domains either directly or through an access provider. The Internet address for an organization consists of a name which is unique to that organization.



For example, a company attached to the .com domain could have the address:

```
anyco.com
```

The diagram in Figure 8-3 shows three fictitious commercial organizations attached to the .com domain. An individual computer called medoc attached to a LAN segment within the company called anyco would have the address:

```
medoc.anyco.com
```

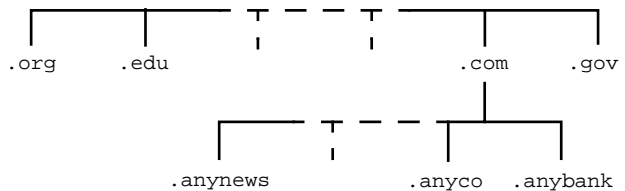

Figure 8-3 Internet Domains

Individual users can be addressed using this scheme. For example, a user called Betty Small who uses medoc at anyco, might have the address:

```
betty_small@medoc.anyco.com
```

Simpler email addresses may be recognized by a mail server which uses database files to recognize the intended destination from Betty Small's email address of:

```
betty_small@anyco.com
```

## Accessing the Internet

To allow access to computers attached to other networks or to the Internet, a *router* or *gateway* is normally required. The router or gateway functions are performed by computers with multiple network connections which provide the necessary link between the Internet and an organization's internal LAN segments. They ensure that data packets are routed according to destination. A gateway may also be used to provide security against unauthorized intrusion.

## Using the Network Interface

*An Overview of TCP/IP Networking and the Internet*

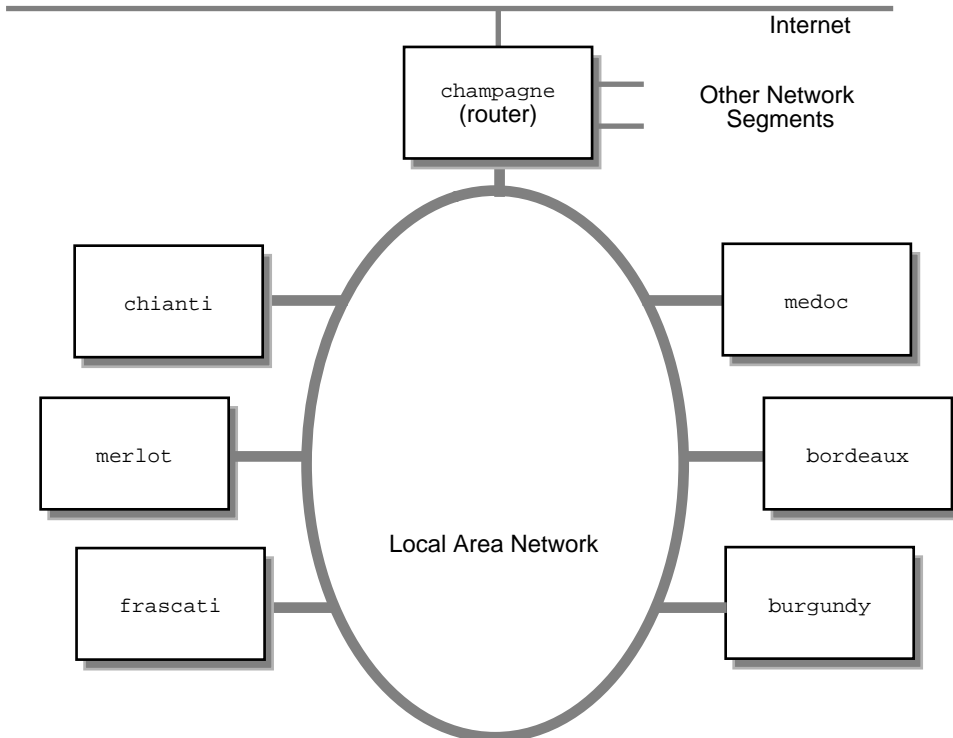

*Figure 8-4 A Local Area Network*

Figure 8-4 shows a LAN within the organization *anyco*. Each computer has a unique IP address and hostname which allows data packets to be routed correctly between them and the outside world. Subject to access privileges, the various computers are able to share applications and files. In this case *champagne* functions as a *router* and controls data movement between this segment and any others within the same organization and provides access to the Internet.

### Registering Internet addresses

Internet addresses are allocated and administered globally by the DDN/ARPANET Network Information Center (NIC). An Internet address and domain name can be obtained directly from the NIC or from a network access provider who will register one on your behalf. For further information, contact the NIC at the following address:

Email: HOSTMASTER@NIC.DDN.MIL  
Telephone: (800) 235-3155  
Postal mail: SRI International  
DDN Network Information Center  
333 Ravenswood Avenue  
EJ217  
Menlo Park, CA 94025

---

## Configuring Your SPARCbook for a TCP/IP Network

The steps required to configure your SPARCbook for a TCP/IP network are as follows:

- **Configuring a hostname and IP address**  
Many organizations appoint an individual to be responsible for the reliable operation and security of their internal networks. This individual, sometimes known as the *network administrator*, should be consulted before connecting a new machine to the network. In particular, the network administrator will be able to advise you about the correct hostname and IP address to use for your SPARCbook.
- **Configuring your SPARCbook to use DNS (optional)**  
This may not be necessary for a small network which rarely changes. However, as a network grows, the administrative burden of keeping each host up to date can be considerable. This burden is reduced on many larger networks by designating one host as a *name server*. A name server provides a name-to-address mapping service for individual hosts within its domain allowing them to obtain the address information required for communication.
- **Configure your SPARCbook to use a router (optional)**  
If your network is local and has no connection to other networks or to the Internet, this is not required. On some networks, one machine, or several machines on very large networks, will be

## Using the Network Interface

### *Configuring Your SPARCbook for a TCP/IP Network*

configured as a *router*. A router controls the passage of data packets between network segments and ensures the efficient flow of data.

- Reboot and test the system.

## Assigning a hostname and IP address

Although you may have already assigned a hostname and IP address to your system during initial system configuration, as discussed in Chapter 2, “Initial System Configuration”, you may need to change these details from time to time because your SPARCbook is a mobile system and may be connected to different networks at different locations. If this is the case, you will need to consult the network administrator responsible for all networks you wish to connect to.

### ➤ *Simple Configuration Using ifconfig*

The `ifconfig` command can be used to set the basic characteristics of the network interface, the most important of which is to associate an IP address with the interface. For example:

```
ifconfig le0 192.3.4.56 netmask 255.255.255.0 broadcast
192.3.4.255
```

### ➤ *Configuring Your SPARCbook by Editing the Hosts Files*

The `/etc/hosts` file traditionally contains the name-to-address mapping for every host on the network, including the local host itself. Whenever a new machine is added to the network, its own `/etc/hosts` file and the `/etc/hosts` file on each host already connected to the network must be updated to allow them to communicate.

The initial configuration you carried out when you first powered your SPARCbook on will have created an `/etc/hosts` file similar to the following:

```
#
# Internet host table
#
127.0.0.1          localhost
192.3.4.56        medoc loghost
```

---

**Note**

The address and hostname used here are examples only and would be substituted by your SPARCbook's address and hostname.

---

You must add an additional line for each machine that you need to communicate with on your network. To edit the `/etc/hosts` file you must be logged in as root. You can edit the file using a text editor or with `vi` at the Solaris command prompt.

Each line contains the following information:

```
ip-number hostname #comments
```

For example, the following might be the host file for the network of machines illustrated in Figure 8-4:

```
#
# Internet host table
#
127.0.0.1 localhost
192.3.4.56          medoc loghost #my new SPARCbook
#
192.3.4.10         champagne # internet router
192.3.4.54         burgundy
192.3.4.55         bordeaux
192.3.4.57         frascati
192.3.4.58         merlot
192.3.4.59         chianti
```

## Configuring your SPARCbook to use a name server

---

**Note**

You are strongly advised not to use NIS or NIS+ with your SPARCbook if you intend to use your SPARCbook as a mobile computer. Using NIS or NIS+ may prevent your SPARCbook from starting up properly if it is not connected to a network and cannot communicate with the NIS name server.

---

The SPARCbook can be configured as a *Domain Name Service* (DNS) client by creating the configuration file `/etc/resolv.conf`. This file lists the local domain name and location of name servers for the local network. For example, in the case of the network illustrated in Figure 8-4 where champagne is the name server, `/etc/resolv.conf` would be similar to the following:

## Using the Network Interface

### *Configuring Your SPARCbook for a TCP/IP Network*

```
#
# Name Server Lookup
domain anyco.com
nameserver 192.3.4.10
```

The file could contain a list of several name servers, if required.

The `/etc/hosts` file is much simpler for the DNS client and need only contain the hostname and IP address of your own system and the name server. For example, the `/etc/hosts` for a machine attached to the network in Figure 8-4 would be similar to the following:

```
#
# Internet host table
#
127.0.0.1 localhost
192.3.4.56 medoc loghost # my new SPARCbook
#
192.3.4.1 champagne # DNS name server
```

## Setting up a default router

Your SPARCbook is configured to use a router by creating the file `/etc/defaultrouter` containing the IP address of the router. For example, the `/etc/defaultrouter` file for a machine attached to the network in Figure 8-4 where champagne is the router would be similar to the following:

```
# defaultrouter
192.3.4.10
```

## Testing Your network connection

When all the necessary configuration files have been created and correctly edited, your SPARCbook should be rebooted in order for the changes to take effect and the network connection tested.

The simplest way to test connections is with the `ping` command. This is a simple utility that will indicate if the connection is working and whether or not the basic configuration is correct. The command syntax is as follows:

```
# ping hostname
```

To use `ping`, you must be logged in as root. For example, to test communications with a machine connected to the local network in Figure 8-4, you might use the following command:

```
$ su
password:
# ping chianti
chianti.anyco.com is alive
```

You can obtain more detailed output by using the `-s` option with the command.

To test the Internet connection to a company called `otherco`, you might use a command similar to:

```
# ping otherco.com
otherco.com is alive
```

---

## Sharing Filesystems

The Sun Network File System (NFS) allows you to set up distributed filesystems enabling files and applications on one host to be shared across the network by other hosts. This section provides a brief overview of how to set up a distributed filesystem using NFS.

### File Sharing and Save and Resume

➤ Many problems associated with Save and Resume arise when file sharing is being used. This is particularly true if you are running applications located on a server machine. The scenario is frequently as follows: you power off with a Save; remove your SPARCbook from the network; and then attempt a Resume with no network connection. The server machine cannot be reached and the Resume cannot complete because your SPARCbook cannot Resume the same operational state.

➤ To prevent this situation arising you should always observe the following precaution before powering off with a Save and removing your SPARCbook from the network.

Always unmount shared directories and comment out any lines in the `/etc/vfstab` file that automount an NFS filesystem by placing a `#` at the start of the line.

➤ For information about Save and Resume see Chapter 5, “Save and Resume”.

## Exporting local filesystems

To allow others to access parts of the filesystem on your SPARCbook you *export* the filesystems you wish to share. To make the whole filesystem available, you would specify the root directory, but normally you would only allow access to specific files or directories.

### ➤ *Configuring the /etc/exports file*

The `/etc/exports` file controls access by other hosts to the local filesystem and consists of a number of lines containing the mount point followed by one or more hostnames, identifying the hosts which may access the exported filesystem. This file will not exist if you have not previously used NFS to export files but can be created and edited with a text editor such as `vi`. Each line has the following syntax:

```
pathname -option,option...
```

Where:

`pathname` is the file or directory to be exported

`option` specifies the type of access to be given, such as `ro` for read-only or `rw` for read-write access.

For example, the `/etc/exports` file on `merlot` attached to the network shown in Figure 8-4 might have the following lines:

```
/usr/anywork-rw=medoc, access=chianti:burgundy, anon=-1  
/usr/anybrowse-ro
```

In this example, `medoc` has read-write access to the directory `/usr/anywork`; `chianti` and `burgundy` have read-only access; and the `anon=-1` entry prevents any anonymous accesses. The second entry allows anonymous read-only access to `/usr/anybrowse`.

### ➤ *Enabling file sharing*

To allow these directories to be shared, you can either reboot the operating system (but not with Save and Resume) or use the following commands:

```
# nfsd 8           start 8 NFS daemons  
# exportfs -a      export the specified directories  
# rpc.mountd      start the mount daemon
```



If you have added directories to an already existing `/etc/exports` file the NFS daemons will already be running and you may need only to enter the `exportfs` command.

### ➤ *Disabling file sharing*

Before disabling file sharing, check to see if any files are being shared with the `exportfs` command without arguments. This produces a list of shared directories. You can unexport directories at any time by using the `export -u` command. For example:

```
# export -u /usr/anywork      halt NFS access to /anywork
# export -ua                  halt NFS access to all directories
```

## Mounting filesystems

To share a directory that has been made available for sharing, or exported, you use the `mount` command. This allows you to attach remote filesystems to your own filesystem tree and access them as a normal part of your own filesystem. You may need to create a directory as a mount point and then mount the remote filesystem. For example, Betty Small on the machine `medoc` wishes to mount the directory `/anywork`, which resides on the machine `merlot`, and access it within her home directory `/export/home/bs` in a subdirectory called `/mywork`. The steps required would be as follows:

### ➤ *Create the new directory*

```
% mkdir /export/home/bs/mywork
```

This step is only required if the directory does not already exist. However, using an existing directory as a mount point will prevent you from accessing files already in that directory while the remote filesystem is mounted.

### ➤ *Mount the remote directory*

```
# mount merlot:/usr/anywork /export/home/bs/mywork
```

Figure 8-5 illustrates the effect of mounting the remote directory on the local directory tree. Note that although this directory has the name `/anywork` on `merlot`, accesses to the directory from the local host (`medoc`) use the name of the mount point `/mywork`. For example:

```
$ ls mywork
File_1 File_2 File_3
```

## Using the Network Interface

### Sharing Filesystems

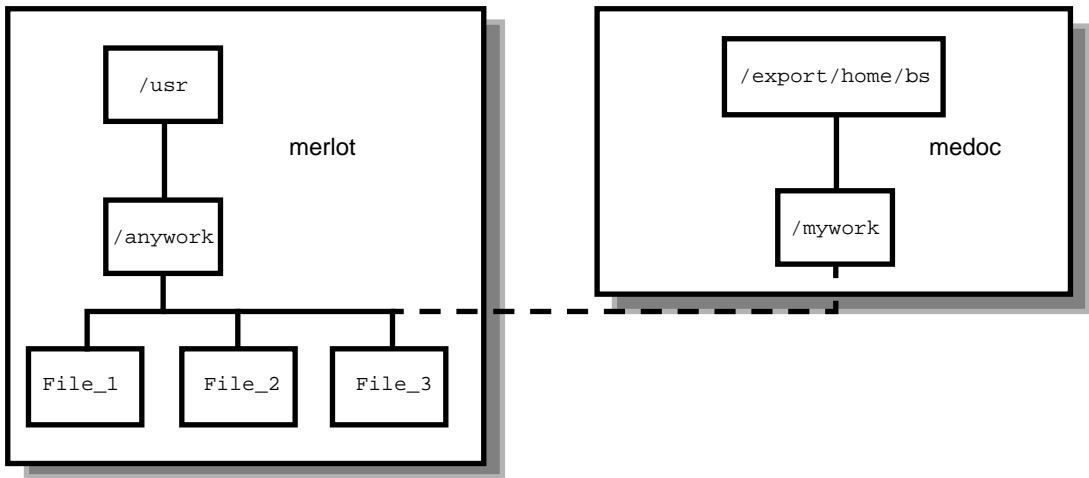

Figure 8-5 File System Mounting

### Automatic file mounting

You can specify a remote directory to be mounted automatically at boot time. To do this, you need to log in as root and add a line to the `/etc/vfstab` file using a text editor, such as `vi`.

For example, to automount `/usr/anywork` on a machine called `merlot` as `/mywork` on a machine called `medoc` (as in the previous example), the following line would be added to the `/etc/vfstab` file on `medoc`:

```
merlot:/usr/anywork - /export/home/bs/myworknfs - yes rw,hard,intr
```

Where the fields are assigned as follows:

device to mount

This is the device name for a local file system or `host:pathname` for a remote directory.

device to fsck

This specifies raw device to `fsck`. In the case of an NFS filesystem, a dash (-) should be used.

`mount point`

This is the directory where the remote filesystem is to be mounted. The directory must exist for the mount to succeed.

`FS type`

This is the type of filesystem which is normally `ufs` for a local filesystem or `nfs` for a network filesystem.

`fsck pass`

This is the number of times a filesystem checks to be carried out. In this case a dash (-) means none. This is normally 1 for the root filesystem, 2 for all other local filesystems or 0 for remotely mounted filesystems.

`mount at boot`

This specifies whether or not the filesystem is mounted automatically at boot time.

`mount options`

This field specifies mount options, such as read-only (`ro`), read-write (`rw`) and no super user privileges (`nosuid`). Other useful options for remotely mounted filesystems are `hard` and `intr` which together enable the local user to interrupt (with **Ctrl-C**) or to kill hung processes which may occur if the network link is disrupted.

## Unmounting a remote filesystem

Remote files can be unmounted using the `umount` command. For example:

```
# umount anywork
```

### Caution

---

**Unmounting is recommended whenever you have the intention of using your SPARCbook away from the current network. Always unmount remote filesystems before a Save if the filesystem is not going to be available when you Resume.**

---

---

## Executing Remote Commands

A number of commands are provided by TCP/IP which can be executed remotely on other machines on the network, subject to permissions. The most important of these commands are as follows:

<b>rcp</b>	Lets you copy files over the network between UNIX hosts.
<b>rlogin</b>	Lets you log in to remote UNIX hosts over the network on which you have an account. You may have to supply a password if the remote system has been set up to test for one.
<b>rsh</b>	Lets you execute a single command on a remote UNIX host.
<b>ftp</b>	For file transfer protocol, allows you to copy files over the network between hosts.
<b>telnet</b>	Allows you to log in to any reachable remote system on which you have an account.
<b>finger</b>	Allows to find out information about users on remote systems.

## Copying files

The syntax for copying files with `rcp` is as follows:

```
% rcp [-r] [fromsys:]filename [tosys:]filename
```

For example, to copy the file `swdemo` from the current directory on the local machine into the `/tmp` directory on the machine called `burgundy`, you would use the following command:

```
% rcp swdemo burgundy:/tmp/swdemo
```

Note that you do not need to specify the name of the local host in the command.

## **Remote program execution**

You can execute a single command on a remote machine without having to log in, provided that you have the necessary privileges. The command syntax is as follows:

```
% rsh sysname command
```

For example, to list the files in /home on the machine called burgundy you would type the following:

```
% rsh burgundy ls /home
```

## **SLIP and PPP**

When your SPARCbook is connected to a remote network via a SLIP or PPP connection, most of the commands that can be used when directly attached to the local network can still be used. This means that the network printer can be used and mail may be sent from your SPARCbook. Care should be taken when disconnecting a SLIP or PPP connection that SLIP or PPP data transfers are complete. Information will be lost if the interface is detached while a transfer is in progress.

## Using the Network Interface

### *Executing Remote Commands*

# Remote Computing

This chapter discusses how to use your SPARCbook for remote communications via a modem. It discusses how to set up the internal modem on the SPARCbook 3 Series models, how to set up PCMCIA modems on SPARCbook 3000 models, and how to use remote communications.

This chapter contains the following sections:

- Getting Connected ..... 9 - 2
- Simple Terminal Login Connection ..... 9 - 3
- Remote Network Access ..... 9 - 5
- Setting up PPP ..... 9 - 6
- Using a SLIP Connection ..... 9 - 13
- Electronic Mail ..... 9 - 14
- AT Command Set ..... 9 - 15
- Class 2 Fax Command Set ..... 9 - 21

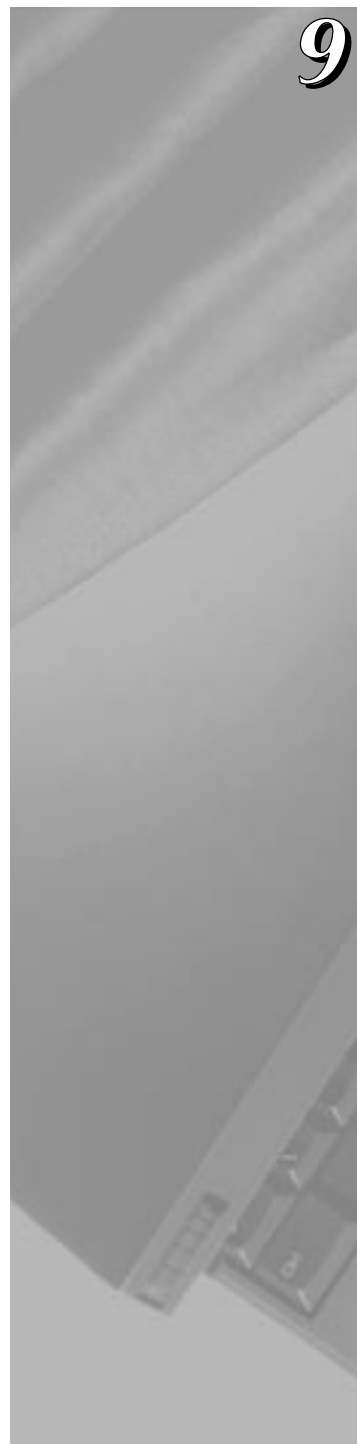

---

## Getting Connected

SPARCbook 3 models provide a built-in modem which can be used in U.S.A. and Canada. In other territories and with SPARCbook 3000 models, you can use a PCMCIA modem.

### Note

---

The SPARCbook 3 models with integral modem are approved for connection to telephone systems in the U.S.A., in accordance with FCC Part 68 rules, and in Canada. You are not permitted to connect the internal modem to the telephone systems of some other countries. In countries other than the U.S.A. and Canada, you should use one of the PCMCIA modems available from your SPARCbook supplier.

---

To use the internal modem, connect your SPARCbook 3 modem connector into the wall phone socket.

To use a PCMCIA modem, insert the card into one of the PCMCIA slots. See “Installing a PCMCIA Card” on page 10-5.

## Configuring the modem

There are no system configuration procedures necessary to use modems with the SPARCbook as the necessary device file already exist. The SPARCbook implementation of Solaris 2 also provides convenient labels for each device that can be used with the `tip` and other commands. Table 9-1 summarizes the device files and labels associated with the internal modem and PCMCIA slots.

Modem	Device	Label
Internal	<code>/dev/cua/c</code>	modem
PCMCIA 0	<code>/dev/cua/d</code>	pcm0
PCMCIA 1	<code>/dev/cua/e</code>	pcm1

*Table 9-1 Modem Device Files*



## Checking the modem is alive

You can check that the modem is alive by using the `tip` command with the appropriate label, as shown in Table 9-1.

For example, the following command opens a command line interface to the internal modem (SPARCbook 3 only):

```
% tip modem
connected
```

This allows you to control the modem directly with the AT command set. See “AT Command Set” on page 9-15.

For a PCMCIA modem in slot 0, the command would be:

```
% tip pcm0
```

To break the command interface, enter `~.` (tilde period), that is:

```
~.
[EOT]
%
```

---

## Simple Terminal Login Connection

To open a simple terminal login connection to a remote system, you can use the `tip` command. The `tip` command allows you to open an AT command interface to the modem, as described in the previous section, or to dial up remote UNIX or non-UNIX systems and to login to an interactive login session, although you may require a login account on the remote system.

For example, to dial out using a PCMCIA modem in slot 0 you could use the sequence:

```
% tip pcm0
atdt012345678
```

Where `at` informs the modem that the following sequence is a Hayes command (see “AT Command Set” on page 9-15) and the number is the number to be dialed. The number includes the tone-dial characters “t”.

## Remote Computing

### *Simple Terminal Login Connection*

Once the link is established, the actions taken depend upon the configuration of the remote machine. The `tip` utility supports the following escape sequences:

`~!` Escape to a command prompt on the local system. The connection remains in place and typing **Ctrl-D** returns you to the remote system.

`~t from [to]`

Copy a file from the specified file on the remote system to a file on the local machine. If `to` is omitted, the same file name is used.

`~%p from [to]`

Copy a file from the specified file on the local system to a file on the remote machine. If `to` is omitted, the same file name is used.

`~?` Get a summary of tilde escapes.

`~.` Terminate the connection.

---

## Remote Network Access

Your SPARCbook supports connection to a local network in the same way as any SPARC-based workstation running the same operating system (see Chapter 8, “Using the Network Interface”). In addition, it supports remote connection to a network using the built-in modem (SPARCbook 3 models only) or PCMCIA modem and a telephone line. Your SPARCbook supports two remote network connection protocols as follows:

- Serial line IP (SLIP)
- Point-to-point protocol (PPP)

Once set up, SLIP and PPP can be used to transfer Internet packets via a telephone line. All of the regular network applications can be used, although the limited bandwidth of the link may make transferring large files a lengthy process.

### Note

---

PPP is only available on Solaris 2.3 (or later); it is similar to SLIP, but includes sophisticated negotiation which improves data transfer rates and minimizes configuration overhead.

---

In order to gain access to a network using the SLIP or PPP, you must connect, via a telephone line and modem, to a computer that will function as a gateway (or *dialup server*) to your organization’s office network or to the Internet. This might be provided by your own organization or by an Internet service provider.

The server must be attached to the network with which you need to communicate and must support SLIP or PPP via the modem. You will need to consult the system administrator or service provider for advice on this.

---

## Setting up PPP

The Solaris PPP allows you to use a serial line or modem as a network interface to transfer Ethernet packets between systems. The facility queues transfer requests between your SPARCbook and remote systems and, unlike `tip`, does not create a permanent connection but calls the remote system when required to perform a task. A timeout period is set in the configuration files so that the modem hangs up automatically if there are no processes pending.

The steps required to get PPP operational on your SPARCbook are as follows:

- 1.** Load the Solaris PPP packages onto your SPARCbook, if necessary.
- 2.** Edit the `/etc/hosts` file on all machines to be connected.
- 3.** Edit the `uucp` database files for all dial-out systems.
- 4.** Edit the `/etc/passwd` and `/etc/shadow` files for a dial-in machine. You will need to consult the system administrator if this is an organization's dial-in server.
- 5.** Edit the `/etc/asppp.cf` file on each machine on the link.
- 6.** Test the link.

These steps are described on the following pages.

## Loading the PPP packages

### ➤ *Checking for the PPP Packages*

The Solaris PPP packages are not included in the Tadpole factory load of the Solaris operating system but are on the distribution CD-ROM which accompanied your SPARCbook and may have been installed already. Check whether the packages are already installed by logging on as root and entering the following command:

```
# pkginfo | grep ppp
```

If the packages are already installed, the following package information is displayed, and you can continue from the next section, “Editing the system files” on page 9-7:

SUNWappr	configuration files
SUNWappu	link manager and login service
SUNWpppk	device drivers

### ➤ *Installing the PPP Packages*

1. Connect a CD-ROM drive configured with ID 6 to the SCSI port of your SPARCbook (see Chapter 7, “Using SCSI Devices”) and load it with the Solaris distribution CD.
2. Reboot your SPARCbook, create a mount point and mount the CD-ROM as follows:

```
# cd /  
# mkdir /cdrom  
# mount -r /dev/dsk/c0t6d0s0
```

3. Install the PPP packages with the following command:

```
# pkgadd -d /cdrom/Solaris_2.5 SUNWpppk SUNWappu  
SUNWappr
```

### Note

---

If you use `pkgadd`, it is important to load the packages in the order shown in the above command. The packages can also be installed using `admintool`.

---

4. Follow the displayed instructions to complete the installation.

## Editing the system files

### ➤ *Editing the /etc /hosts File*

It is necessary to do this on your SPARCbook and on every system on a remote network with which you may need to communicate. This is necessary regardless of the name service in use because PPP starts before the name service daemons during the boot process.

You will need to consult the system administrator for the network to obtain the correct host name and IP address for your SPARCbook and other machines on the network.

## Remote Computing

### Setting up PPP

The network illustrated in Figure 9-1 shows two SPARCbooks, schooner and ketch, connected remotely via a PPP link to an organization's primary network. The machine champagne provides dial-in PPP services for the two SPARCbooks. Notice that the dial-in server has separate host names and IP addresses for PPP link and its primary network interface.

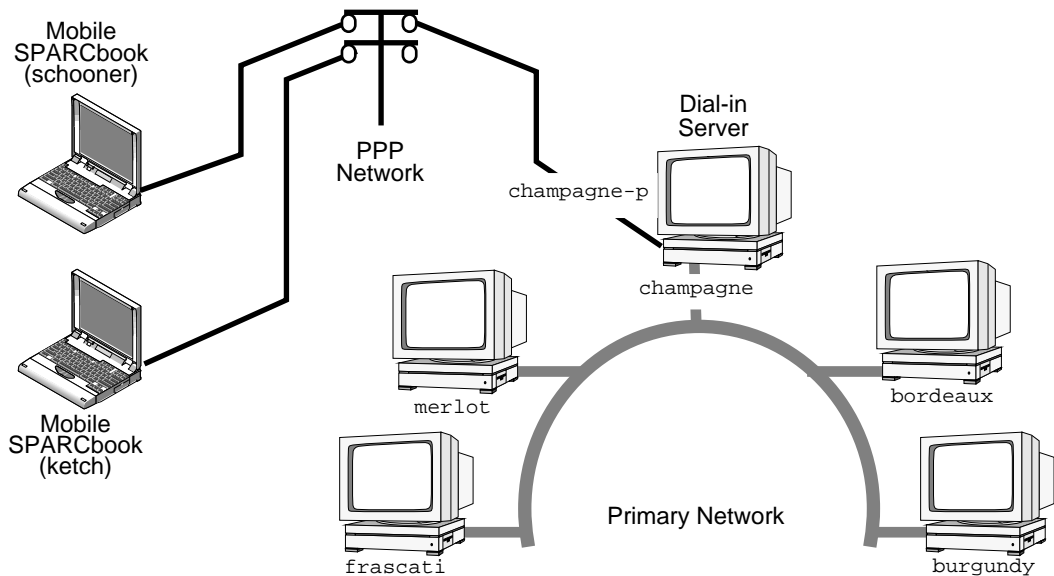

Figure 9-1 PPP Connection via a Dial-In Server

For example, to allow ketch to communicate with systems connected to the primary network, the hosts file for ketch might contain the following:

```
#
# Internet host table
#
127.0.0.1 localhost
192.3.5.21      ketch loghost #my mobile SPARCbook
#
192.3.5.10     champagne-p  # ppp router
192.3.4.54     burgundy
192.3.4.55     bordeaux
192.3.4.57     frascati
192.3.4.58     merlot
```

## Editing the UUCP database files

Before a machine can dial out over the PPP link, three `uucp` database files must exist as follows:

- `/etc/uucp/Devices`
- `/etc/uucp/Dialers`
- `/etc/uucp/Systems`

### Note

---

The SPARCbook implementation of Solaris 2.5 provides versions of the `Devices` and `Dialer` (`Devices.slip` and `Dialers.slip`) files used by NCE which already contain suitable entries for the built-in modem and supported PCMCIA modems. To make these available to PPP, copy them without the `.slip` extension as follows:

```
# cd /etc/uucp
# cp Devices.slip Devices
# cp Dialers.slip Dialers
# cp Systems.slip Systems
```

---

### ➤ *Devices*

The `/etc/uucp/Devices` file contains an entry for every modem or serial port your SPARCbook might use for `uucp` or PPP operations. The copy supplied as part of the SPARCbook load of Solaris 2.5 provides the following entries for the internal or supported PCMCIA modem:

```
# Sparcbook 3 internal modem
ACUEC   cua/c   - 38400sparcbk3
ACUEC   cua/d   - 38400sparcbk3
ACUEC   cua/e   - 38400sparcbk3
```

In the first entry, `cua/c` identifies the internal modem (for SPARCbook 3); in the second entry, `cua/d` identifies PCMCIA slot 0; and in the third entry, `cua/e` identifies PCMCIA slot 1.

### ➤ *Dialers*

The `/etc/uucp/Dialers` file contains entries describing the initialization of the modem and conversation between any modems you might use and remote systems used to establish the connection. Each

entry begins with the name assigned in the `Devices` file to the interface, in this case `sparcbk3`. The copy supplied as part of the SPARCbook load of Solaris 2.5 provides the following entry:

```
sparcbk 3 =,-, "" P_ZERO "" \M\dA\pTZ\r\c OK\r
ATE1V1X1Q0&C1&D3&R0&S1S2=255S12=255\r\c OK\r \EATDT\r\c
CONNECT \m
```

#### ➤ *Systems File*

This file contains an entry for each remote system that you may wish to communicate with, and each entry contains information about the remote system's host name, phone number, line speed and login chat script. For example:

```
champagne-p any ACUEC 38400 9=12345678 login: ketch
word: secret
```

The format of each entry is as follows:

Name	This is the host name of the remote system, which must be the same as the value for the <code>peer_system_name</code> keyword entry in the file <code>/etc/asppp.cf</code> .
Time	Defines the time at which calls can be made. The value any specifies any time. You can also specify when to call by using <code>Su</code> , <code>Mo</code> , <code>Tu</code> etc. for the days of the week and by specifying the time.
Type	This specifies the interface type, in this case <code>ACUEC</code> for a V.32bis modem.
Class	This specifies the speed of the modem, in this case <code>38400</code> bps. The modem automatically adjusts the speed if necessary.
Phone	This is the phone number required to dial the remote system. This example includes the <code>=</code> character, which causes the modem to pause for a second dial tone.
Login	This specifies the login sequence required to gain access to your account on the remote system in the form of "expect send...".



## Editing the passwd file

This step is only necessary on the dial-in server. For example, if you are configuring two stand-alone SPARCbooks to communicate via a phone line using PPP.

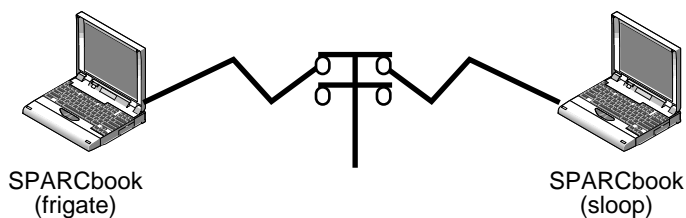

Figure 9-2 Two Standalone SPARCbooks

To configure a dial-in server, you must edit the `/etc/passwd` and `/etc/shadow` files. You must add an entry for each host authorized to log in so that when the remote host calls, your system reads its UUCP database to obtain a user name or user ID for the host initiating the call. Your SPARCbook then verifies the user information in the `/etc/passwd` file. For information about configuring these file, please refer to the *System Administration Guide*. See “Associated Documents” on page xix.

## Editing the asppp.cf file

The `/etc/asppp.cf` file provides PPP with information about the system at the other end of the PPP link. When you boot your SPARCbook, the link manager uses this information to establish and maintain communications with the remote system.

### ➤ *Dial-out Machine*

For example, the `/etc/asppp.cf` file for the SPARCbook `ketch` (see Figure 9-1) might be as follows:

```
ifconfig ipdptp0 plumb ketch champagne-p up
path
```

## Remote Computing

### Setting up PPP

```
inactivity_timeout 120
interface ipdpt0
peer_system_name champagne-p
```

The first section runs the `ifconfig` command and configures the PPP interface `ipdpt0` for a point-to-point link. The `plumb` option enables IP to recognize the interface. The line also contains the host name of the local machine (in this case `ketch`) and then the host name of the remote machine (in this case `champagne-p`). Finally, the `up` option marks the interface as operational.

The second section tells the link manager the name of the remote machine and the name of the interface used for the connection. As a minimum the `path` section must have the `interface` and `peer_system_name` entries.

#### ➤ *Dial-in Machine*

To allow dial-in, the `/etc/asppp.cf` would have similar structure to that of the dial-out machine except that in this case the destination is not included in the `ifconfig` section but is included in the `path`. For section example, the `/etc/asppp.cf` file for the SPARCbook frigate (see Figure 9-2) might be as follows:

```
ifconfig ipd0 plumb frigate up

path
    interface ipd0
    peer_system_name ridge
    peer_ip_address_sloop
```

In this case, the user of `sloop` logs in to this system as `ridge`. Note that in order for the SPARCbooks, illustrated in Figure 9-2, to be able to communicate using PPP, they would both require valid IP address and host name information about each other in their respective `/etc/hosts` files.

## Starting and stopping PPP

Solaris PPP will normally start up during the system boot process. However you can start PPP manually with the following command while logged in as root:

```
# /etc/init.d/asppp start
```

You can verify that it is running with the following command:

```
# ps -e | grep asppp
```

This should produce output which will list the `aspppd` daemon if PPP is running.

You can stop PPP manually with the following command:

```
# /etc/init.d/asppp stop
```

## Testing the link

If your modem is correctly installed and the `/etc/hosts` files, UUCP database files and PPP are all correctly edited and you have the correct dial-in access to the server machine, the link can be tested with the `ping` command. For example on the SPARCbook ketch, (see Figure 9-1) you could use the command:

```
# ping champagne-p 180
champagne-p is alive
```

Your SPARCbook should dial the remote system and then, after some delay while the connection is being established return output similar to that shown. The 180 argument, in this example, sets a timeout of 3 minutes to allow time for the connection process to complete before reporting a failure.

---

## Using a SLIP Connection

You can use the Connect panel and Location panel of the Notebook Computing Environment (NCE) to establish a SLIP connection. The Connect panel provides controls with which you can specify the configuration and routing for the SLIP connection. For example, you can choose whether to use the internal modem or a PCMCIA modem, specify the telephone number of the dialup server and specify whether to use pulse dialing or tone dialing. See “Connect Panel” and “Location Panel” in your *NCE Guide*.

You can disconnect SLIP by clicking the **Disconnect** button in the Connect panel of the Notebook Computing Environment. See “Connect Panel” in your *NCE Guide*. You should always ensure that there are no data exchanges taking place before disconnecting the modem cables.

---

## Electronic Mail

Your SPARCbook provides facilities for sending and receiving electronic mail (or email).

While working as part of a larger network of machines, the network itself normally provides email facilities. It is also possible to set up your SPARCbook as a complete stand-alone email system. In this mode it functions as a stand-alone domain on Internet and is able to send and receive mail directly to and from any other Internet user. To do this, you need to register with an Internet mail feed organization as a new Internet node. See “Registering Internet addresses” on page 8-8.

### Setting up email

Your SPARCbook is shipped ready to use existing Ethernet-based mail facilities. If you attach to a network that already provides email facilities, you need to contact your network administrator so that your name can be added to those that the mail server knows about.

In order to access the mail facilities when you are away from the network, you need to arrange for your mail to be forwarded to another machine, acting as a remote dial-in mail server. You can then use a modem to contact the remote server via a dial-in line to send and receive mail.

You will have to consult the administrator for the server to obtain an account on the remote server.

---

## AT Command Set

It is possible to control the operation of the modem directly from the command line using the Hayes-compatible AT command set. This section describes some of the more commonly used commands in the AT command set, as summarized in Table 9-2.

The command set is supported by the internal modem (SPARCbook 3 only) and by many PCMCIA modems. To respond to AT commands, the modem must be placed in Command Mode from the Solaris command line using the `tip` command:

<code>% tip modem</code>	Internal (SPARCbook 3 only)
<code>% tip pcm0</code>	PCMCIA slot 0
<code>% tip pcm1</code>	PCMCIA slot 1

When in Command Mode, the modem accepts instructions in the form of command lines returns status information in response to some of them. The modem can be instructed to perform functions such as originating or answering calls or can be configured to change its mode of operation. Modems can store two configuration profiles and four telephone numbers while powered off.

With the exception of `A/`, all command lines begin with the attention characters `AT` followed by one or more command characters and are terminated by pressing **RETURN**. Command lines may contain up to 56 characters, including A and T. All characters before the AT string and all characters that follow an errant command are ignored.

The modem can be returned to normal operation by typing in `~`. (tilde period).

## Remote Computing

### AT Command Set

CODE	DESCRIPTION
A	Go Off-hook in Answer Mode
A/	Re-execute Previous Command
AT	Attention Characters
B	Bell/CCITT Protocol
D	Dial Telephone Number
En	Command Echo
Fn	Select Line Modulation
Hn	Switch Hook Control
In	Identification
Nn	Automode
O	Return to Online
P	Set Pulse Dialing Default
Qn	Quiet Command Reset Code
Sn	Read/Write From Selected S-Register
T	Set Tone Dialing Default
V	Enable Short-form Result Code
Wn	Error Correction Message Control
X	Enable Extended Result Code Set
Y	Long Space Disconnect
&Fn	Restore Factory Configuration
&V	Display Current Configuration and Stored Profiles
&W	Store Current Configuration
&Yn	Designate a Default Profile
&Zn=x	Store Telephone Number
%Cn	Enable/Disable Data Compression
%En	Enable/Disable Auto Retrain
*B	Display Blacklisted Number
*C	Remote Configuration Password
*D	Display Delayed Numbers
*E	Exit Remote Configuration Mode
*L	Display Secure Access Directory
*P	Store Callback Password
*R	Request Remote Configuration

*Table 9-2 AT Command Set Summary*

## AT command set description

- A/**           **Re-execute Previous Command**  
This repeats the last command. It is not preceded by the AT characters or terminated by pressing **RETURN**.
- AT**           **Attention Characters**  
These characters must appear at the beginning of all command lines.
- Bn**           **Bell/CCITT Protocol**  
This command selects the communication standard:  
n = 0       CCITT operation  
n = 1       Bell
- Dn**           **Dial Telephone Number**  
This command causes the modem to dial up a remote modem. The following modifiers may be added:  
L           Redial last number  
P           Pulse Dialing  
T           Touch-tone Dialing  
R           Originate Call in Answer Mode  
W           Wait for dial tone for a time defined by S6  
,           Delay dial sequence for a time defined by S8  
@           Wait for Quiet for a time defined by S7  
!           Go On-hook for a time defined by S29  
;           Return to Command Mode  
S=n        Dial a Stored Number
- En**           **Echo Command Characters**  
This controls whether the modem echoes command characters back to the host:  
n = 0       Disable Character Echo  
n = 1       Enable Character Echo
- Fn**           **Select Line Modulation**  
This selects line modulation:  
n = 0       Auto Dial mode  
n = 1       V.21 or bell 103 (according to Bn)  
n = 2       Reserved

## Remote Computing

### AT Command Set

n = 3 V.23  
n = 4 V.22 at 1200 bps  
n = 5 V.22 bis  
n = 6 V.32 bis at 4800 bps  
n = 7 V.32 bis at 7200 bps  
n = 8 V.32 bis at 9600 bps  
n = 9 V.32 bis at 12000 bps  
n = 10 V.32 bis at 14400 bps

#### **Hn Switch Hook Control**

n = 0 Go on-hook (hang up)  
n = 1 Go off-hook to access the telephone line

#### **In Identification**

This causes the modem to respond with identification codes:

n = 0 Request Product Code  
n = 1 ROM Checksum  
n = 2 Return OK Response  
n = 3 Manufacturers ID  
n = 4 Configuration Mode  
n = 33 Sierra ID

#### **O Return to Online**

This command returns to the modem to the Data Mode.

#### **Qn Command Response Control**

This controls whether the modem provides responses to commands:

n = 0 Return Response  
n = 1 Do Not Send Response

#### **Sr=n Change Register Value**

This selects an S register and changes its contents:

r = S register  
n = New Contents

#### **Sn? Read S Register**

This returns the contents of an S register

n = S-register



<b>Vn</b>	<b>Response Format</b> This command is used to select the format of response made by the modem to the host: n = 0      Single Digit Response n = 1      Extended Response
<b>Xn</b>	<b>Select Extended Response Set</b>
<b>&amp;Fn</b>	<b>Fetch Factory Configuration</b> This recalls the factory settings of the modem. n = 0      Recall factory profile 0 n = 1      Recall factory profile 1
<b>&amp;V</b>	<b>Display Current Configuration and Stored Profiles</b> This displays the currently active configuration, the stored profiles and first four stored telephone numbers.
<b>&amp;Wn</b>	<b>Store Current Configuration</b> Store the currently active configuration, including S registers, as a profile n (0 or 1).
<b>&amp;Yn</b>	<b>Designate a Default Profile</b> Selects the profile used after a hardware reset.
<b>&amp;Zn=x</b>	<b>Store Telephone Number</b> The modem can store up to 20 numbers: n = Number memory 0 - 19 x = Dial string of up to 40 characters
<b>%Cn</b>	<b>Enable/Disable Data Compression</b> n = 0      Disable data compression n = 1      Enable MNP 5 data compression n = 2      Enable V.42 bis data compression n = 3      Enable V.42 bis and MNP 5 compression
<b>%En</b>	<b>Enable/Disable Auto Retrain</b> This controls whether the modem automatically monitors the line quality and requests a retrain when needed: n = 0      Disable auto retrain n = 1      Enable auto retrain

- \*B            Display Blacklisted Numbers**  
This causes the modem to return a list of blacklisted numbers.
- \*C            Remote Configuration Password**  
This instructs the modem to store a password. By supplying a matching password, a remote modem may reconfigure the local modem supplied by a remote modem.
- \*D            Display Delayed Numbers**  
This causes the modem to send a list of delayed numbers and the delay associated with each.
- \*E            Exit Remote Configuration Mode**  
This causes a remote modem to exit remote configuration mode and transmit OK onto the telephone line.
- \*L            Display Callback Directory**  
This causes the modem to supply a list of all callback directory entries.
- \*P            Store Callback Password**  
This causes the modem to store a password and to store or delete a corresponding telephone number. The password is used to match that supplied by a remote modem when secure access is used. The number is used to dial back the remote modem.
- \*R            Request Remote Configuration**  
This causes the modem to attempt to place a remote modem into remote configuration mode. This is only possible if the local modem is in the online command mode and is connected to the remote modem by an MNP error corrected link.

## Class 2 Fax Command Set

The SPARCbook 3's internal modem is able to execute extended Class 2 Fax Commands, as summarized in Table 9-3. These commands must be preceded by the AT characters and terminated with a semicolon (;) or **Return**.

COMMAND	FUNCTION
<b>Service Class ID</b>	
+FCLASS=	Service Class
<b>Class 2 Action Commands</b>	
D	Originate a Call
A	Answer a Call
+FDT=	Data Transmission
+FET=N	Transmit Page Punctuation
+FDR	Begin or Continue Phase C Receive Data
+FK	Session Termination
<b>Class 2 DCE Responses</b>	
+FCON	Facsimile Connection Response
+FDCS	Report Current Session
+FDIS	Report Remote Identification
+FCFR	Indicate Confirmation to Receive
+FTSI	Report the Transmit Station ID
+FCSI	Report the Called Station ID
+FPTS	Page Transfer Status
+FET	Post Page Message Response
+FHNG	Call Termination with Status
<b>Class 2 Session Parameters</b>	
+FMFR?	Identify Manufacturer
+FMDL?	Identify Model
+FREX?	Identify Revision
+FDCC=	DCE Capabilities Parameters
+FDIS=	Current Sessions Parameters
+FDCS=	Current Sessions Results
+FLID=	Local ID String
+FCR	Capability to Receive
+FPTS=	Page Transfer Status
+FCR=	Capability to Receive
+FAA	Adaptive Answer
+FBUF?	Buffer Size (Read Only)
+FPHCTO	Phase C Time Out
+FAXERR	Fax Error Value
+FBOR	Phase C Data Bit Order

*Table 9-3 Class 2 Fax Command Summary*

---

# FAXtool

With FAXtool you can send and receive faxes using the internal modem (SPARCbook 3 only) or PCMCIA modem. You can specify an ASCII or a PostScript file, and to send it by fax to a specified destination. FAXtool also provides the facilities to send more than one file (for example, a PostScript header page and ASCII text) as a single fax.

### Note

---

FAXtool uses the internal modem or PCMCIA. Before using FAXtool, you need to connect the modem interface to the telephone line.

---

You can start FAXtool within OpenWindows by selecting the **FAXtool...** option from the **Workspace, Programs** menu.

The main FAXtool window contains a list of fax messages and denotes whether they are queued to be sent, have been sent or have been received. It also provides status and error information during fax transactions.

## Sending a fax

To send a fax with the main FAXtool window open, select the **Transmit** button, and the Send Fax window opens. The Send Fax window shows a list of the currently available fax numbers. When you first start up the FAXtool, this box is blank. Send a fax as follows:

- 1.** Select a fax number from the fax numbers available, or select the **Fax Number** field and enter the required fax number.
- 2.** Type the name of the file to send in the **File Name** field. You can specify multiple file names on the line, separated by spaces.
- 3.** If you want to include a separate header page, type the name of the file containing the header you want to use. If you do not want to include a header file, this field should be blank (see the note below).
- 4.** Select **Send**.

**Note**

---

It is a legal requirement in the United States of America for a fax message to identify the sender, either on a header page or on the message pages. Please refer to “FCC Part 68 Modem Information” on page iv.

---

If the fax is only partly transmitted or if the remote number is busy, FAXtool will retry for a preset number of attempts and then, if still unsuccessful, cancel the operation.

For further information about FAXtool, refer to the SunSoft Solaris documentation.

## Remote Computing

*FAXtool*

# PCMCIA Interface

This chapter discusses how to use the PCMCIA interface to add memory or I/O facilities to your SPARCbook using industry-standard credit card-sized PCMCIA cards.

This chapter discusses how to use PCMCIA cards with the SPARCbook and contains the following sections:

- Introduction to PCMCIA ..... 10 - 2
- The PCMCIA Port ..... 10 - 4
- Installing a PCMCIA Card ..... 10 - 5
- Removing a PCMCIA Card ..... 10 - 6

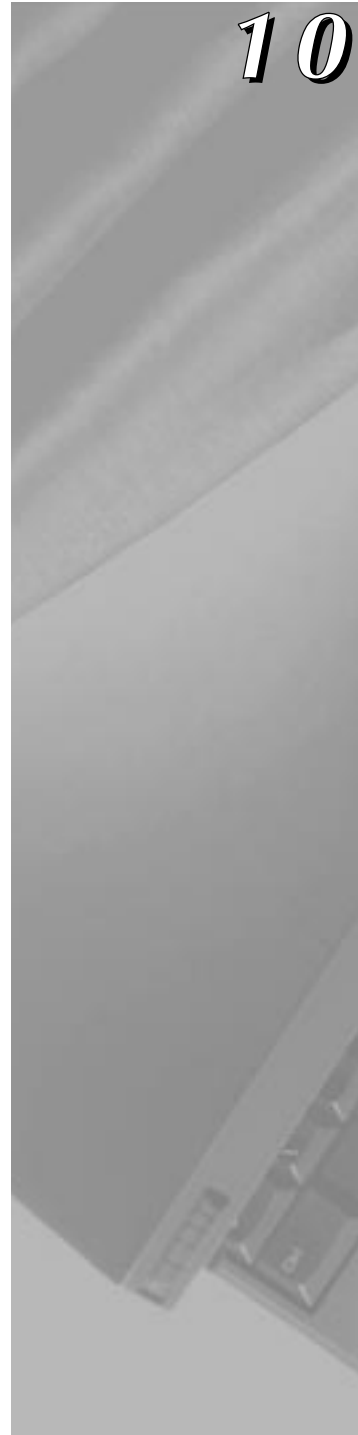

---

## Introduction to PCMCIA

The PCMCIA (PC Memory Card Interface Association) standard defines the physical dimensions, electrical interface characteristics and software architecture of cards and slots that conform to the standard. This means that a wide range of standard cards are available from a variety of manufacturers to provide either data storage or peripheral expansion.

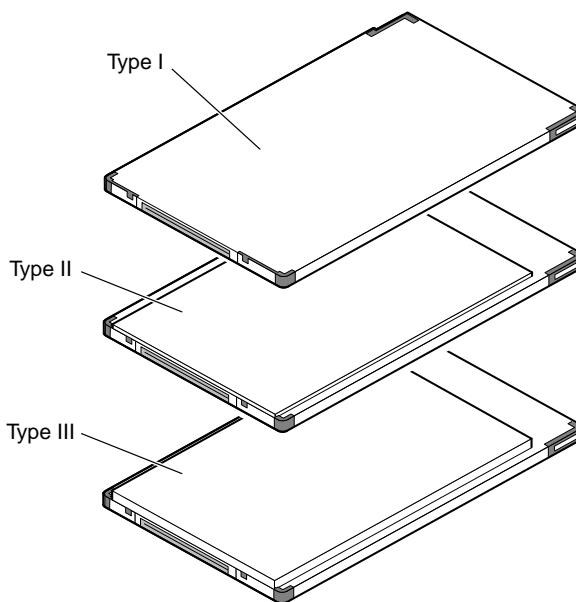

*Figure 10-1 PCMCIA Memory Cards and Peripheral Adapters*

The PCMCIA standard defines cards of three thicknesses; each is about the same size as a credit card, uses a similar 68-pin connector and has a 3.3 mm thickness around its edge. The three types differ in the thickness of the center section, as illustrated in Figure 10-1. The center section of a Type I card is 3.3 mm thick; Type II cards are 5 mm thick; and Type III cards are 10.5 mm thick. The PCMCIA port in your SPARCbook 3 can accommodate two Type I or II cards or one Type III card.



Because PCMCIA cards and the PCMCIA interface in your SPARCbook are designed to an industry standard, you can easily move cards between different computers. Some of the devices available on PCMCIA cards are:

- **Memory cards**  
These include FLASH, SRAM and combined FLASH and SRAM cards. PCMCIA memory cards cannot be used to expand the main memory of your SPARCbook but should be viewed as a form of solid state hard disk. You can access the data on a PCMCIA memory card by mounting the card on your file system.
- **Modem and Fax/Modem cards**  
These include a wide range of cards which can be used to equip a SPARCbook 3000 with a modem or can be used with a SPARCbook 3 if you are traveling in territories where the built-in modem cannot be connected to the public telephone network.
- **Interface cards**  
These include network interface, scanner interface, and frame grabber cards.
- **Hard disk drives**  
These include a range of different capacity products suitable for filesystem use which can be formatted and mounted like a conventional drive. These are particularly useful for rapid system configuration or for software distribution.

You should consult your supplier for information about the PCMCIA cards available for your SPARCbook.

**Note**

---

Many PCMCIA cards are supplied with software and instructions which assume they are to be used with a PC or PS/2 compatible computer. Follow the instructions given in this guide and in the *NCE User Guide* (see “Associated Documents” on page -xix), on how to install and configure a PCMCIA card to operate with your SPARCbook.

---

---

## The PCMCIA Port

Your SPARCbook provides two PCMCIA slots, arranged one above the other within a small opening. Slot 1 is nearest the keyboard top, and Slot 0 (zero) is furthest from the keyboard top. The PCMCIA port is illustrated in Figure 10-2.

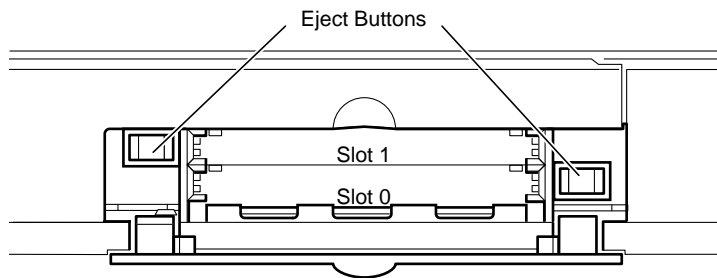

*Figure 10-2 The PCMCIA Slots*

### Removing the PCMCIA flap

The PCMCIA port's flap can be removed for convenience. This is useful if you wish to install an interface card, such as a modem, which uses a connecting cable. The door is retained by clips at its hinges. See Figure 10-3.

To remove the PCMCIA port flap:

- 1.** Open the door to an angle of about 60 degrees.
- 2.** Pull firmly to release the hinge pins from the hinge clips.

To replace the PCMCIA port flap:

- 1.** Locate the hinge pins so that they both touch the hinge clips, with the door at an angle of about 60 degrees.
- 2.** Apply a steady but firm pressure until the hinge pins clip into place under the springs.

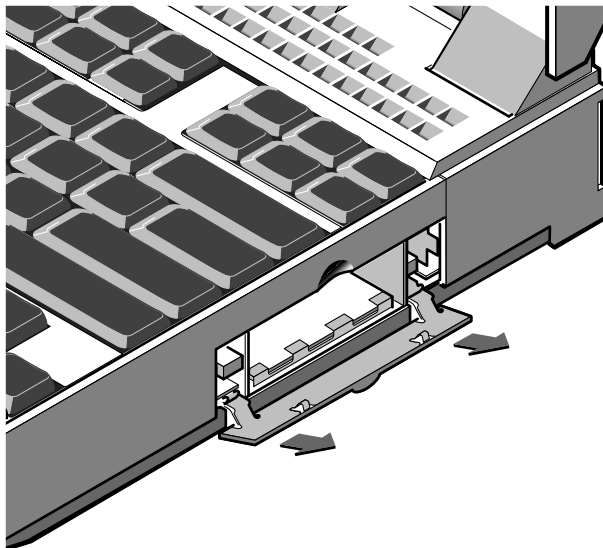

Figure 10-3 The PCMCIA Flap

---

## Installing a PCMCIA Card

### Caution

---

You do not need to power your SPARCbook off before inserting or removing a *single* PCMCIA card. However, to prevent data loss or corruption when inserting or removing a second card, you must ensure that either your SPARCbook is powered down or that there are no operations in progress with the card that is already installed.

---

To install a PCMCIA card, proceed as follows:

1. Open the PCMCIA port door. (You can remove the door if you wish, as previously described.)
2. Insert your PCMCIA card into the slot with the 68-pin connector end in first, taking care to align it correctly in the card guides.
3. Push on the PCMCIA card firmly, and it will click into position.

## PCMCIA Interface

### Removing a PCMCIA Card

---

#### Note

PCMCIA cards are keyed to be fitted one side up only. If your PCMCIA card will not engage with the connector properly, remove it and check that it is the right way up.

---

Your SPARCbook automatically detects when you insert a PCMCIA card, and in some cases, automatically configures it ready for use. You can monitor and change the configuration process using the PCMCIA panel of the Notebook Computing Environment and also add configuration profiles for PCMCIA cards that have not been predefined. See “PCMCIA Panel” in your *NCE User Guide*.

PCMCIA modem cards can also be controlled via the Modem panel of the Notebook Computing Environment. See “Modem Panel” in your *NCE Guide*.

---

## Removing a PCMCIA Card

Before removing a PCMCIA card from your SPARCbook, you should disable it using the PCMCIA panel of the Notebook Computing Environment. See “PCMCIA Panel” in your *NCE User Guide*.

---

#### Caution

**You do not need to power your SPARCbook off before inserting or removing a *single* PCMCIA card. However, before inserting or removing a second card, you must ensure that either your SPARCbook is powered down, or that there are no operations in process with the card that is already installed. Failure to observe these precautions can result in data loss or corruption.**

---

To remove a PCMCIA card, press the ejector button for the PCMCIA card you wish to remove. The ejector button for slot 0 is located inside the PCMCIA port toward the rear of the SPARCbook. The ejector button for slot 1 is located inside the PCMCIA port toward the front of your SPARCbook.

---

## Using PCMCIA Cards

Your SPARCbook provides software drivers for a range of Hayes-compatible modem cards, Ethernet cards, memory cards and hard disks. Some less commonly used cards may require specific software driver support for Solaris.

### Modem cards

Information about using PCMCIA modems with your SPARCbook is provided in Chapter 9 “Remote Computing”.

### Network interface cards

PCMCIA Ethernet cards can be used with your SPARCbook in addition to the built-in interface or with the built-in interface disabled.

To use your SPARCbook with more than one network interface (if, for example, your SPARCbook is going to be used as a router), you must assign a separate IP address and hostname for each interface. There must be an entry for each interface to be used in the `/etc/hosts` file. See “Assigning a hostname and IP address” on page 8-10. See also “Remote Network Access” on page 9-5 for information about using remote network access via a modem.

In addition, each network interface has associated with it a file in the `/etc` directory which contains the host name for that port. These files have the following names:

<code>/etc/le0</code>	Built-in interface
<code>/etc/pcelx0</code>	PCMCIA slot 0
<code>/etc/pcelx1</code>	PCMCIA slot 1

To use a PCMCIA Ethernet card and not the built-in card, it is necessary to reconfigure your SPARCbook by entering the `sys-unconfig` command. This begins a process which is similar to that described in “Network information” on page 2-3.

## Memory cards

Memory cards are used as solid state disks and can be formatted and mounted. For example, to format an SRAM card with a MS-DOS filesystem the following command would be used:

```
# fdformat -t dos /dev/dsk/c2d0s0      (slot 0)
# fdformat -t dos /dev/dsk/c2d1s0      (slot 1)
```

To mount the card, the following command could be used:

```
# mount -F pcfs /dev/dsk/c2d0s0:c /pcfs (slot 0)
# mount -F pcfs /dev/dsk/c2d1s0:c /pcfs (slot 1)
```

Before removing the card, you should select the **Eject** button in the NCE PCMCIA panel. This executes a series of commands defined in the NCE PCMCIA Eject Script.

PC Flash cards are used in a similar way but use different device files. These are as follows:

```
/dev/dsk/c3d0s0      (slot 0)
/dev/dsk/c3d1s0      (slot 1)
```

---

### Note

SRAM and PC Flash cards can only be formatted as 1.4MB devices by Solaris. To achieve their full capacity, you can format them with a PC and mount them with the commands shown above.

---

## Hard disks

---

### Note

Because of its physical thickness, a PCMCIA hard disk must be installed in slot 0. It occupies both slots and so prevents a second PCMCIA card being fitted in slot 1.

---

A PCMCIA hard disk is used in a very similar way to a conventional hard disk. It can be formatted, have a file system created on it and can be mounted in the conventional way.

Your SPARCbook supports “hot plugging” of a PCMCIA hard disk.

An example of formatting a hard disk and creating and mounting a file system is provided in “Configuring an External Hard Disk – Worked Example” on page 7-6. The main differences are that you do not have to set a SCSI ID and that the disk slices for the PCMCIA disk appear at `/dev/dsk/c1d0s[n]`.

For example to mount partition 6 of a formatted PCMCIA hard disk onto a UNIX filesystem, the following command would be used:

```
# mount -F ufs /dev/dsk/c1d0s6 /mnt
```

**Note**

---

It is not possible to make a PC file system on the hard disk with Solaris. The disk must be formatted on a PC and then it can be mounted with the following command:

```
# mount -F pcfs /dsk/c1d0s2:c /pcfs
```

---

**PCMCIA Interface**  
*Using PCMCIA Cards*



# Using Displays

This chapter describes how to use your SPARCbook's sophisticated display interface to drive the built-in display and external high resolution CRT displays.

This chapter contains the following sections:

- SPARCbook Display Interface Overview ..... 11 - 2
- Display Interface Operating Modes ..... 11 - 3
- Pan and Zoom ..... 11 - 4
- Color Mapping ..... 11 - 6
- Simultaneous Display Operation ..... 11 - 7
- Connecting an External Display ..... 11 - 8
- Configuring the Display Interface Using NCE ..... 11 - 9
- Configuring the Display Interface at the Command Prompt 11 - 11
- Adding to the Display Types List ..... 11 - 14
- Display Timing Parameters ..... 11 - 16

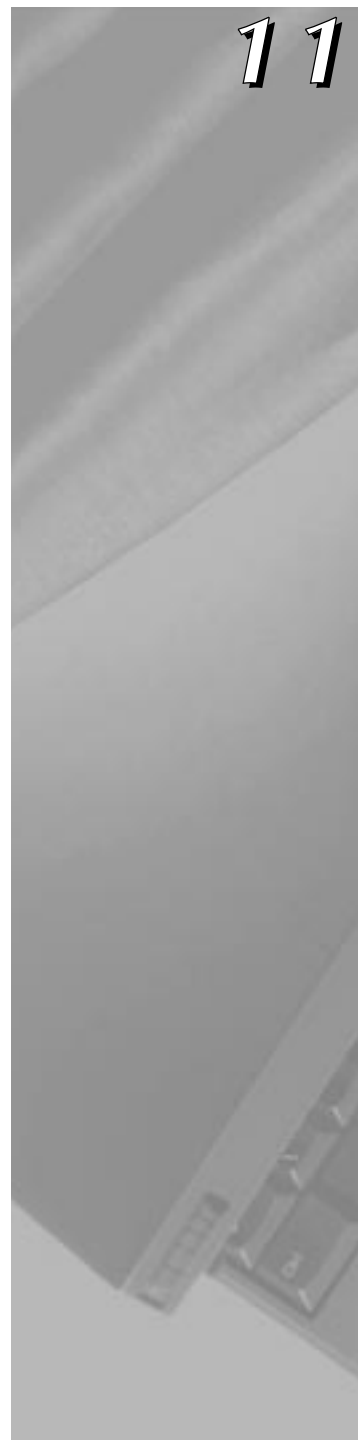

## SPARCbook Display Interface Overview

Picture information is stored in 2Mbytes of dedicated VRAM (video RAM) which provides the SPARCbook's *physical frame buffer*. The resolution of the physical display can be set in software, allowing you to use external displays of up to 800 x 600 in 32-bit color or up to 1600 x 1200 in 8-bit color (256 simultaneous colors).

On the SPARCbook, applications running under the Solaris operating system do not interact directly with the physical frame buffer but use the standard Xserver interface to set the display interface's operating parameters. One feature that makes the SPARCbook unique is that the Xserver resolution can be set independently of the display resolution, as illustrated in Figure 11-1, providing applications with an *emulated frame buffer*.

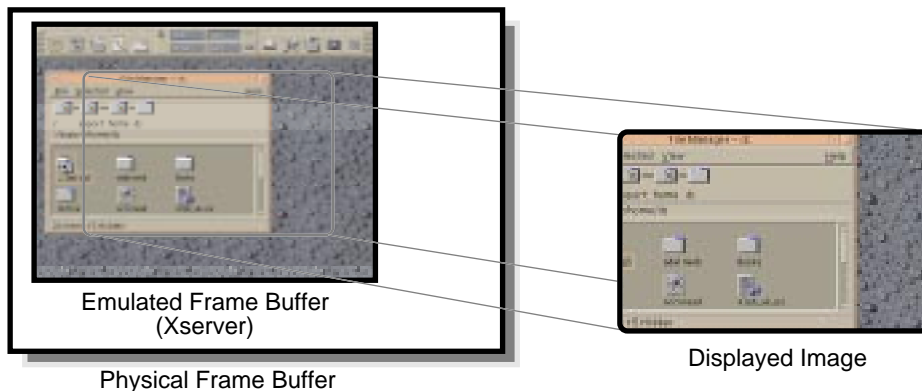

Figure 11-1 Xserver and Display Resolution

For example, you could set the Xserver to drive a 1024 x 768 pixel display and configure the SPARCbook to drive a 800 x 600 display. The application would only be aware of the 1024 x 768 pixel emulated frame buffer. You could then use the SPARCbook's pan and zoom features to move around the image in the emulated frame buffer.

The Xserver's operating parameters can be set from the Solaris command prompt or by using the Display panel provided by NCE.

---

## Display Interface Operating Modes

The display interface provides two operating modes:

- Native mode which provides accelerated graphics.
- Emulated mode which provides pan and zoom facilities.

When you set the display type in the NCE Display panel, the native mode is selected by default, with the Xserver set to the same resolution as the physical display.

### Native mode

Native mode is selected when Xserver resolution has the same resolution as the physical display. Pixels within the physical frame buffer are mapped directly onto the display by the interface hardware, allowing the P9100 graphics chip to operate at a higher speed. For this reason, native mode can be considered to provide *accelerated graphics*; the two terms can be used interchangeably for the SPARCbook.

For example, if you enable an external display of 1024 x 768 pixels and have the Xserver resolution set to 1024 x 768 pixels, then your system operates in native mode with accelerated graphics.

### Emulated mode

Emulated mode is selected when the Xserver resolution and display resolution are set to different resolutions. This mode does not support accelerated graphics but enables the display to simulate a much larger display, allowing a whole 1600 x 1200 image, for example, to be viewed on an 800 x 600 display by panning and zooming.

Applications operate independently of the physical display's resolution because they are only aware of the emulated frame buffer's resolution. This mode should be used if an application requires specific Xwindows resolution in order to operate.

---

## Pan and Zoom

When using emulated frame buffer mode, you can use the SPARCbook's pan and zoom facilities.

### Display panning

When the image in the emulated frame buffer is larger than the physical display area, (if, for example, you have zoomed in on the image), you can pan to the parts of the image that are hidden beyond the edge of the display.

To pan the display, move the cursor to the edge of the display, toward the part of the image that you wish to see. For example, if the part of the image that you want to see is to the left of the display, move the cursor to the left edge, and continue trying to move the cursor to the left.

### Display zoom

Depending on the selected emulated frame buffer resolution and physical display resolution, your SPARCbook provides two or three zoom levels, as illustrated in Figure 11-2.

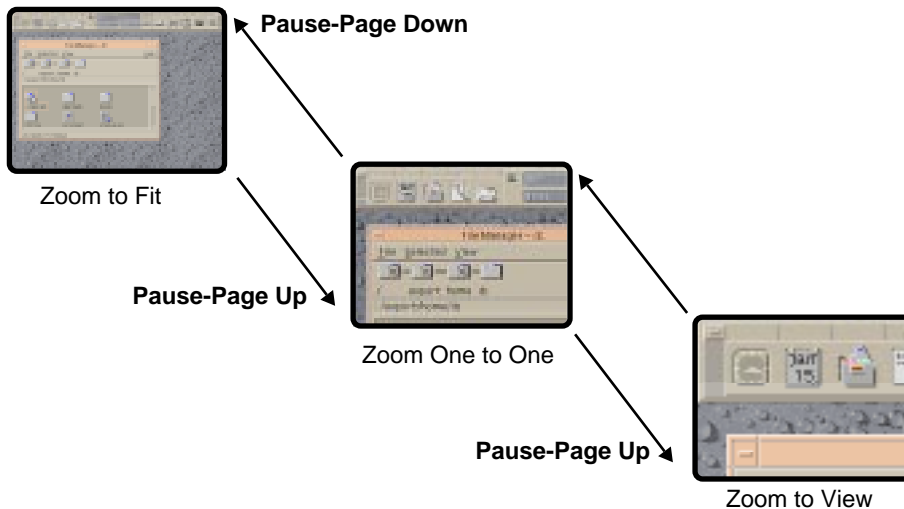

Figure 11-2 Zoom Levels

You can step between these levels by using the following key combinations:

- **Pause-Page Up** to zoom in
- **Pause-Page Down** to zoom out

The three zoom levels are described as follows:

- **Zoom to Fit**

With the zoom-to-fit view, four pixels from the image in the emulated frame buffer are merged into one pixel on the display. This reduces the size of the image to one quarter of the actual size so that you can view the whole image. Objects may appear very small on some displays. This view becomes practical when using a video projector or large format display. The zoomed out image cannot be panned.

The zoom-to-fit view may leave large blank borders around the image if, for example, you display a 1024 x 768 image on a 800 x 600 display. In this case, the quarter-size image would only occupy the center 256 x 192 pixels on the display.

---

**Note**

When you start OpenWindows or CDE with an emulated frame buffer image larger than the display, the internal display is automatically zoomed to fit so that you can view the whole image. This may leave large blank borders around the image which does not indicate a system fault. Press **Pause-Page Down** and the image will be zoomed to fill the display.

---

- **One to One**

With the one-to-one view, one pixel in the emulated frame buffer image is displayed as one pixel on the display. If the emulated frame buffer contains an image that is larger than the physical display, you can view hidden parts of the image by panning.

- Zoom to view

With zoom to view, one pixel in the emulated frame buffer image is expanded to four pixels on the display resulting in an image that is four times the size of the original. This displays a smaller part of the stored image but in greater detail, although objects may look ragged. This view is most useful when used with large format public displays when you want an audience to focus on a particular area of detail. You can view hidden parts of the image by panning.

---

## Color Mapping

Each pixel on the display can be represented in video memory by 8 bits, 16 bits or 32 bits. The number of bits in each pixel determines the range of colors that it can display. When 8 bits per pixel are used, the pixel data is used to select an entry in a 24-bit color palette to obtain an 8-bit intensity value for each of the red, green and blue color channels. Thus, you get 256 colors displayed simultaneously from a palette of 16,777,216.

When 16- and 32-bits per pixel are used, the pixel data controls directly the intensity of the red, green and blue video channels. These modes are referred to as *true color* modes for this reason. With 16 bits per pixel, 5 bits are used to control the intensity of red, 6 bits for green and 5 bits for blue. The 32-bit depth uses 8 bits for each of the red, green and blue channels; the upper 8 bits of the 32-bit word are unused.

## Setting the color mode

The color mode can be set by using the Display Editor in the NCE Display Panel. See “Configuring the Display Interface Using NCE” on page 11-9. You can also use the `fbconfig` command at the Solaris command prompt. See “Configuring the Display Interface at the Command Prompt” on page 11-11.

## Resolution limitations

The SPARCbook provides 2 MBytes of video memory. This imposes a limit on the resolution of the physical display that can be supported by the SPARCbook. The total number of bytes required to drive a display (which can be calculated by multiplying the horizontal resolution, the vertical resolution and number of bytes per pixel) must be equal to or less than the physical frame buffer size.

Table 11-1 shows number of colors and the maximum resolution supported for 8-, 16- and 32-bits per pixel video.

<b>Bits/Pixel</b>	<b>Colors</b>	<b>Maximum Resolution</b>
8	256 from 16777216	1600 x 1200
16	65536	1152 x 900
32	16777216	800 x 600

*Table 11-1 SPARCbook Color/Resolution*

---

## Simultaneous Display Operation

The internal display can be used simultaneously with an external display if they both have the same resolution. For example, a SPARCbook system fitted with a 1024 x 768 XGA display can drive an external 1024 x 768 display at the same time. This is possible because the hardware timing is similar for both displays.

Because the Xserver resolution is independent of the physical display resolution, simultaneous display operation supports both native and emulated frame buffer mode, with pan and zoom facilities available on both displays.

## Connecting an External Display

Using an external display involves connecting it to the VGA-type connector located on the I/O panel and then entering a command or using NCE to configure the display interface for the electrical characteristics of the monitor. The connector's position is illustrated in Figure 11-3.

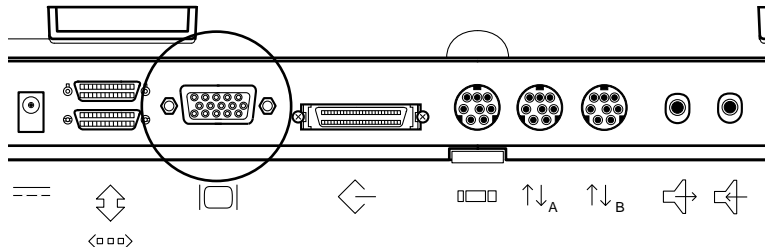

Figure 11-3 Display Interface Connector

The Sun monitor cable adapter allows you to connect Sun monitors to your SPARCbook. The monitor adapter cable is illustrated in Figure 11-4.

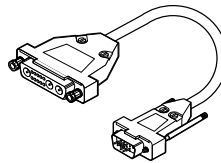

Figure 11-4 Sun Monitor Adapter Cable

Connect an external monitor as follows:

1. Connect the monitor cable to the monitor.
2. Connect the monitor video cable to your SPARCbook using the adapter illustrated above if required.
3. Connect the monitor to a grounded power outlet and apply power.
4. Configure the display interface for your display, as described below.



---

## Configuring the Display Interface Using NCE

### Note

---

Any changes made to the Xserver configuration only take effect when the Xserver is next started up. This means that if you make changes while operating within the OpenWindows or CDE desktop environments, you must exit and re-enter OpenWindows or CDE before the change takes effect. See the next section.

---

The display interface can be configured using the NCE Display panel or by using commands at the Solaris command prompt. In either case, changes that are made do not take effect until the next time the Xserver is started up. This particularly applies to the NCE Display panel which operates under OpenWindows or CDE. You must exit and re-enter the desktop environment from the Solaris command prompt.

### Using the NCE Display Panel

The NCE Display panel provides an easy-to-use method of reconfiguring the display interface. It provides a list of predefined display types. When a display is chosen from the list, the Xserver is automatically set to the same resolution, enabling native mode by default (see “Native mode” on page 11-3). However, the Display panel gives you the option of selecting a different Xserver resolution to the physical display, allowing you to select emulated mode (see “Emulated mode” on page 11-3).

### Note

---

**Applications are only aware of the Xserver resolution.** Selecting a display from display type list affects the operation of the display interface hardware while setting the Xserver resolution provides compatibility with applications.

---

Configure a display with the Display panel as follows:

1. Connect your external display to your SPARCbook and power them both on.

## Using Displays

### Configuring the Display Interface Using NCE



2. Enter the CDE or OpenWindows desktop environment.
3. Launch the NCE application.
4. Click on the Display panel icon in the NCE Main Window toolkit. The Display Panel is displayed.



Figure 11-5 NCE Display Panel

5. From the **Display Types** list, select the required display type for your physical display; for example, VESA 1024 x 768. The Xserver Resolution changes to correspond, enabling accelerated graphics.
6. If required to support your particular applications, select a different Xserver resolution from the **Xserver Resolution** pull down menu.

#### Note

---

Selecting a lower Xserver resolution than the physical display resolution will result in blank borders around the image on the display.

---

7. Click the **Test** button. This causes the SPARCbook to temporarily switch to the new display setting.
8. If the display test shows that your selection works, click on **Apply**.

9. To make the change take effect, restart the Xserver. To do this, exit and re-enter the desktop environment.

In CDE, click on the **Exit** button in the CDE Front Panel and return to the login window.

In the OpenWindows desktop environment, press **F1-Alt-Delete** on the keyboard or choose **Exit** from the OpenWindows desktop menu.

---

## Configuring the Display Interface at the Command Prompt

This section describes how to set the Xserver resolution using the `openwin` command and the physical display resolution using the `fbconfig` command.

### Setting the Xserver resolution

The Xserver resolution can be set at the Solaris command prompt using the `openwin` command with SPARCbook specific options.

Different command syntax are required under Solaris 2.4 and 2.5, as outlined below.

#### ↳ *Under Solaris 2.4*

Using the following command syntax:

```
$ openwin -noport -native -width 1024 -height 768
```

This sets a SPARCbook operating with a 1024 x 768 display to native mode and ignores any NCE parameters.

The following command options are valid:

- noport      The Xserver does not take parameters from NCE.
- zoomc      Center the cursor for zoom in.
- width      Specify the emulated frame buffer width in the range 640 to 1600 pixels.

## Using Displays

### *Configuring the Display Interface at the Command Prompt*

- `-height` Specify the emulated frame buffer height in the range 480 to 1600 pixels.
- `-sunfb` Predefined emulated frame buffer resolution. It provides shorthand for `-width 1152 -height 900`.
- `-maxfb` Sets the emulated frame buffer width and height to double the built-in screen.
- `-noescape` Disables exit on the **F1-Alt-Delete** key sequence.
- `-noautoswitch`  
Prevents automode switching such as reverting to the built-in screen.

#### ☞ *Solaris 2.5*

Solaris 2.5 uses the standard `Xsun(1)` binary which means that it is no longer possible to use the Tadpole extra command options described above. The options described for Solaris 2.4 are still available but must be passed into the Xserver using the `TADXOPTIONS` environmental variable.

For example, you could use the command:

```
% TADXOPTIONS="-maxfb" openwin
```

This starts the OpenWindows desktop environment with the Xserver resolution set to 1600 x 1200 pixels.

## Setting up the display interface hardware

The display interface hardware can be configured from the Solaris command prompt with the `fbconfig` command.

The purpose of the command is to create, select, list and delete mode settings in the system's video parameter table which is held in the kernel. At boot time, the kernel table is initialized with entries for the SPARbook's built-in display.

Mode 0 is for the built-in display only, and Mode 1 is for simultaneous display mode. Additional entries are constructed for 16-bit and 32-bit color operation.

Other configurations can be defined using the command options `-n` to create a new mode, `-c` to copy an existing mode for modification or `-f` to create a configuration file.

To provide a standard set of external video modes, the boot time startup script `/etc/init.d/nce` reads a set of mode definitions from the file `/etc/fbconfigurations`. The NCE server rewrites this file at startup and also when instructed by the NCE display panel or when the `-S` option is used.

The `fbconfig` command has the following options:

- `-F dev` Use `dev` as the frame buffer device name instead of the default `/dev/fb`.
- `-v` Verbose report detailing all timing parameters and flag settings.
- `-N` Print the number of the current mode.
- `-l` List all modes currently set up.
- `-m mode` Change to `mode`. The new mode will not take effect until the next time the Xserver is started.
- `-I` Change to the default setting immediately. This change will only take place the next time the Xserver is started.
- `-n mode` Create the new mode with given label. The label option `-L` is compulsory.
- `-L label` Give the new mode `label`.

In addition, the optional `flags` field is a string of characters from the following set:

- `c` Composite sync. This option combines horizontal and vertical sync signals on one wire, as required for most Sun monitors.
- `g` Composite sync on green. This option combines both sync signals onto the green video channel.

## Using Displays

### Adding to the Display Types List

- p Enable blanking pedestal to enhance the difference between black and blanked pixels.
- h Enable positive vertical sync pulse.
- v Enable positive vertical sync pulse.
- i Enable the built-in display and external display simultaneously. **Use this option with extreme caution as the wrong timing parameters may damage the built-in display.**
- r Set the read-only flag on the mode. Once the read-only bit is set on a mode, only a system reboot will clear it.
- N Set the pixel depth of the new mode.
- d *mode* Delete *mode*. Delete is refused if the mode is marked as read-only or if the mode is in operation.
- c *mode* Define new *mode* as a copy of existing mode.
- D *mode* Set the pixel depth of the mode.
- e *state* Set external display drive to state where 0 is off and 1 is on. This only works if the current mode is driving the built-in display, such as mode 0 or new modes with the *i* flag set.
- S Save the current mode in `/etc/fbconfigurations`. This option can be used alone or with any other option. NCE writes the current kernel list of display modes to this file so that they are available after a reboot.

---

## Adding to the Display Types List

You can add to the Display Types list by using the `fbconfig` command or Display Editor from the NCE Display panel. The Display Editor appears when you select **Edit** or **Create** from the Display panel.

**Note**

For a brief explanation of display interface hardware parameters, see “Display Timing Parameters” on page 11-16.

Table 11-2 shows an example set of video timing parameters as presented in a manufacturer’s specification for an actual monitor.

Display Manufacturer’s		NCE Equivalent Field	Unit
Parameter	Specification		
Pixel Rate	100000	Pixel Clock Frequency	KHz
Horizontal frequency	68.68	-	KHz
Vertical frequency	75	-	Hz
Horizontal resolution	1152	Horizontal Resolution	Pixels
Vertical resolution	900	Vertical Resolution	Lines
HPeriod	1456	-	Pixels
HBlanking	304	See below	Pixels
HSync delay	32	Horizontal Front Porch	Pixels
HSync width	128	Horizontal Sync Width	Pixels
VPeriod	915	-	Lines
VBlanking	45	See below	Lines
VSync delay	3	Vertical Front Porch	Lines
VSync width	3	Vertical Sync Width	Lines

*Table 11-2 Example Display Parameters*

Using the manufacturer’s parameters, the horizontal and vertical back porches can be calculated in the following way:

$$\begin{aligned} \text{Horizontal Back Porch} &= \text{HBlanking} - \text{HSync delay} - \text{HSync width} \\ &= 144 \text{ pixels} \end{aligned}$$

$$\begin{aligned} \text{Vertical Back Porch} &= \text{VBlanking} - \text{VSync delay} - \text{VSync width} \\ &= 39 \text{ lines} \end{aligned}$$

The most convenient way to create a new display definition is to edit an existing one by changing the name and modifying any of the characteristics as necessary. For example, you may need only to change the sync signals from being separate horizontal and vertical signals to being combined onto the green video channel.

## Display Timing Parameters

The hardware timing parameters for a display are derived from the time taken to output one pixel, which is controlled by the pixel clock (or dot clock), from the time it takes to scan one line and from the time it takes to scan the whole display.

The display interface generates two synchronization signals. One for horizontal (line) and one for vertical (frame) synchronization. These signals may be supplied to the display on separate wires, combined onto one *composite* sync on one wire, or combined with the green video channel (*sync on green*).

Typical characteristics for horizontal and vertical synchronization and blanking signals are illustrated in Figure 11-6.

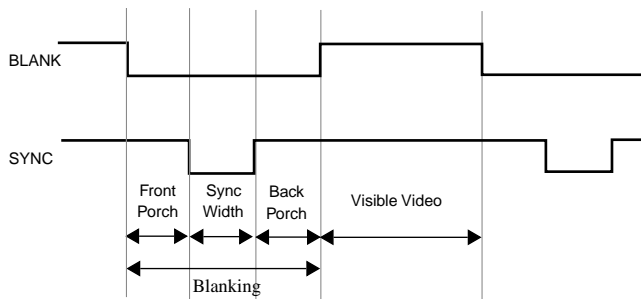

Figure 11-6 Video Timing Signals

The waveforms for the horizontal and vertical sync signals are similar in shape but differ in that the horizontal parameters are measured in pixels or dots while the vertical parameters are measured in lines. So, for example, a 1024 x 768 display would have 1024 visible dots horizontally and 768 visible lines vertically.

The total time for the horizontal and vertical sync signals include the horizontal and vertical *blanking periods* when the electron beam is switched off, during which time the display prepares to display the next



line or next frame. The blanking periods include the time taken by synchronization pulses and by front and back *porches*. The porches are used to adjust the position of the video image on the display.

The way that the timing signals affect the image on the display is shown in Figure 11-7.

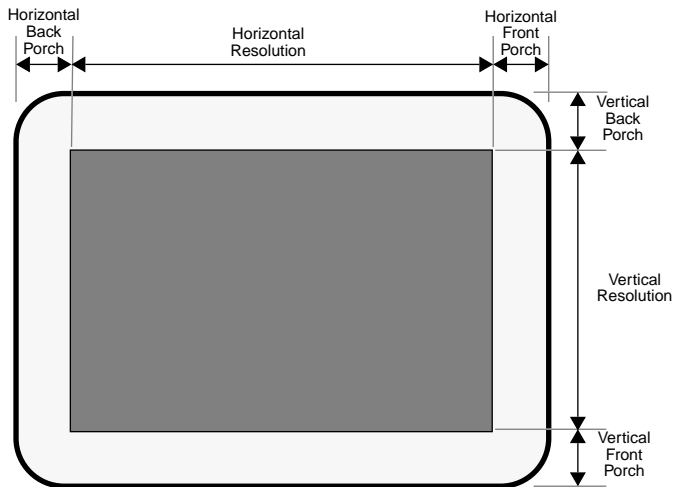

*Figure 11-7 Video Timing Parameters on the Displayed Image*

## **Using Displays**

### *Display Timing Parameters*

# Serial, Parallel and Audio I/O

This chapter describes how to use the serial, parallel and audio interfaces.

It contains the following sections:

- Using Serial Devices ..... 12 - 2
- Using Parallel Devices ..... 12 - 3
- Using Audio Equipment ..... 12 - 4

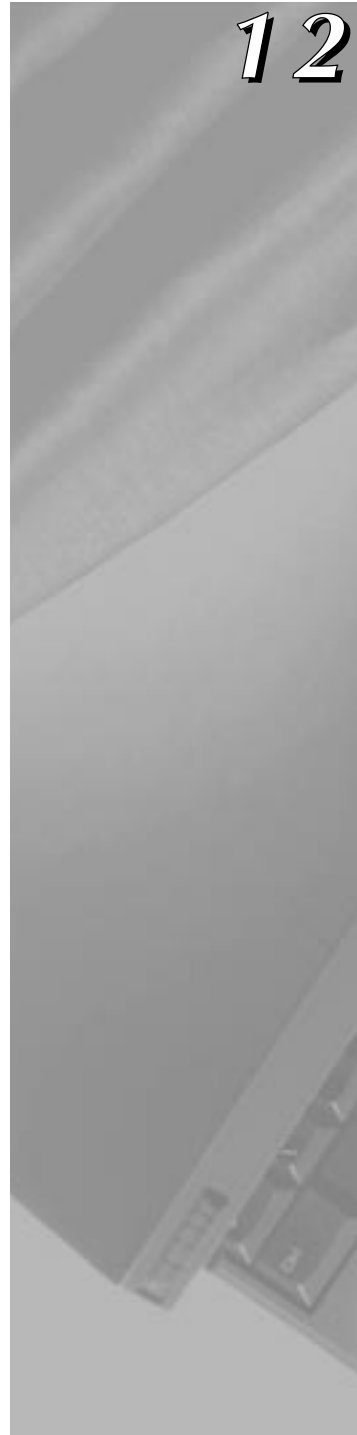

---

## Using Serial Devices

You can connect a variety of serial devices to your SPARCbook via either of the serial ports located on the I/O panel, such as terminals, modems and scanners.

The serial ports provide 8-pin min-DIN connectors. Pinout information for these is provided in “Serial Ports” on page B-5.

### Configuring serial connections

To configure a serial port for a terminal or modem from within the OpenWindows or CDE desktops, login as root and use admintool as follows:

1. Launch admintool from within a cmdtool window with the following command:

```
# admintool
```

2. From the **Browse** menu, select **Serial Ports**. The Serial Ports menu is displayed:



Figure 12-1 Admintool: Serial Ports Window

Ports **a** and **b** are the serial ports on the I/O panel of your SPARCbook that are configured by default for terminal connection.

3. To edit a port's configuration, double-click the associated entry's line. A Modify Serial Port window is displayed.

4. Use this window to edit the parameters, such as baud rate and terminal type, for the port to suit your external device and application and then click on **Apply** to save the changes. You will need to consult the documentation for your serial device for information about the serial interface requirements.

For a more detailed guide to configuring serial devices, see the SunSoft Solaris documentation. (See “Associated Documents” on page xix.)

---

## Using Parallel Devices

You can connect a range of devices to the parallel port on the rear of your SPARCbook, including printers and scanners. The parallel port provides a 26-pin mini D-type connector. Pinout information is provided in “Parallel Port Connector” on page B-2. A cable adapter, as illustrated in Figure 12-2, is available which allows connection to cables equipped with a 25-pin D-type connector.

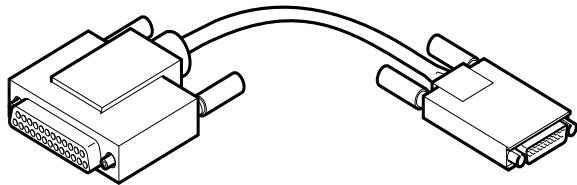

*Figure 12-2 Parallel Cable Adapter*

## Configuring parallel devices

For information about configuring parallel devices, refer to your SunSoft Solaris documentation. (See “Associated Documents” on page xix.)

---

### Using Audio Equipment

The audio interface of your SPARCbook comprises stereo line-input, stereo line-output, stereo headphones sockets, a built-in mono microphone, and a built-in mono speaker.

Access to the line-input, line-output and headphone channels is via three 3.5 mm stereo jack sockets on the I/O panel.

### Adjusting the audio input and outputs

The OpenWindows Audiotool allows you to record and play back audio files and provides controls to adjust the input level of the microphone, line-input and the volume of the speaker and line-output.



*Figure 12-3 OpenWindows Audiotool*

For more information about Audiotool, please refer to your Solaris documentation.

### Using the built-in microphone and speaker

The built-in microphone and speaker provide an audio input and output of limited quality, suitable for voice or telephony applications. These can be used with Audiotool or with other voice-based applications.

## **External audio sources and outputs**

The line-input allows you to connect devices such as an audio CD player directly to your SPARCbook. Devices which require a more sensitive input, such as a stereo microphone or a mixing desk, may require a suitable preamplifier.

The line-output provides a suitable input for a PA amplifier or for active or multimedia speakers (speakers that contain their own amplifier). The audio output can be adjusted to provide CD-quality sound reproduction.

## **Serial, Parallel and Audio I/O**

*Using Audio Equipment*



# Installing and Using Applications

This chapter provides details about running third-party applications, and outlines any limitations that may apply.

This chapter contains the following sections:

- Third-party Application Support ..... 13 - 2
- Methods of Installing Applications ..... 13 - 3
- Legibility of Text on a Small Screen ..... 13 - 4
- Customizing the Operating System ..... 13 - 5

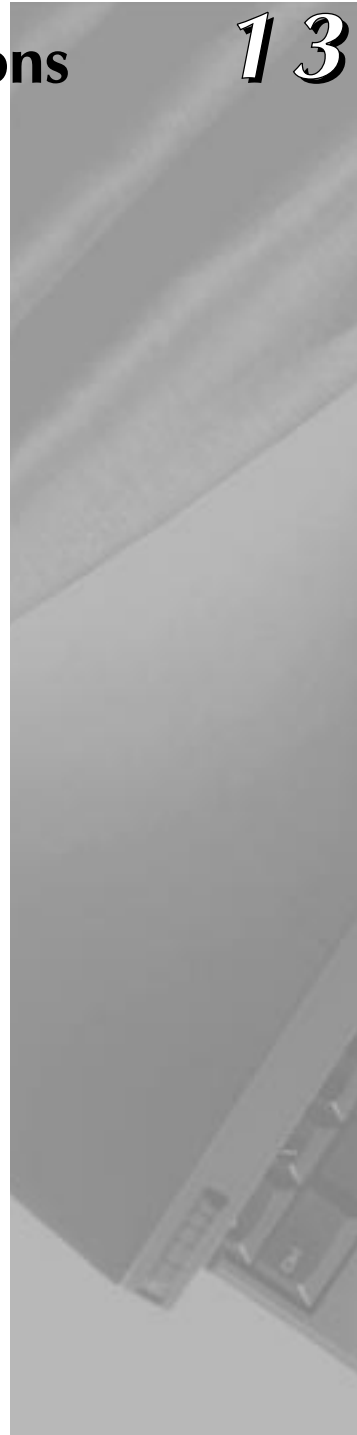

## Third-party Application Support

Because it uses a standard SPARC processor architecture and the Solaris operating system, the SPARCbook provides the same level of support for several thousand software applications as a conventional desktop SPARCstation. Applications that meet the SPARC Compliance Definition (SCD) will run on your SPARCbook.

Many third-party applications that have been tested on SPARCbook, include FrameMaker (Frame Technology Corp), Lotus 1-2-3 (Lotus Corp), Wingz (Informix Corp), WordPerfect (WordPerfect Corp), Write Draw & Paint (Island Graphics) and 20-20 (Access).

In general, all third-party X or OpenWindows applications written for SPARCstation and compatible workstations will run on the SPARCbook with very few limitations as follows:

- Applications use either Xwindows as their graphics system or must be written for OpenWindows. The operating system uses Xwindows Release 4 and OpenWindows Version 3.3, but you can run earlier Xwindows or OpenWindows applications directly on the SPARCbook. Older SunView applications are not supported.
- Applications that require the existence of Sun specific hardware, such as attached SBus hardware, or that make direct calls into undocumented device driver interfaces in the Sun kernel, will not run on the SPARCbook.
- Applications that use Sun or other vendor specific hardware (such as IDPROMs) for licensing may not run on the SPARCbook.

---

## Methods of Installing Applications

Software installation on the SPARCbook is carried out in a conventional manner. Programs can be installed to run locally or can be run on a network server. However, due to the mobile nature of the SPARCbook, which may mean it is operated without a network connection from time to time, it is advisable to install applications onto your SPARCbook's own hard disk and then run them locally.

You can install applications from a locally connected drive or from a network server. In addition, application vendors are increasingly using the world wide web to distribute their products.

Applications can be installed using one of the following methods:

- From a locally connected CD-ROM, tape or floppy drive
- From a network server
- From a remote website

For specific information about installing SPARC applications onto SPARCbook, refer to the documentation supplied with the application and to the SunSoft documentation (see "Associated Documents" on page xix).

---

## Applications and Graphics Interfaces

The SPARCbook uses a standard Xserver interface to set the display interface's operating parameters. In addition to supporting the built-in display, the SPARCbook can be set up to support a wide range of external displays. Also, the SPARCbook's unique emulated frame buffer feature allows the Xserver resolution to be set independently of the physical resolution of the display. Applications operate independently of the physical display's resolution because they are only aware of the Xserver's resolution.

## Installing and Using Applications

### *Legibility of Text on a Small Screen*

For example, your application may require a 1024 x 768 resolution display, while you have a built-in display with a 800 x 600 pixel resolution. The emulated frame buffer means that you can set the Xserver resolution to 1024 x 768 to support the application but set the display hardware to drive the internal 800 x 600 display. See “Display Interface Operating Modes” on page 11-3.

When using an emulated frame buffer, part of the displayed image may extend beyond the edge of the screen. The SPARCbook’s pan and zoom facilities can be used to move around the image and overcome this effect. See “Pan and Zoom” on page 11-4.

---

## Legibility of Text on a Small Screen

When using some display resolutions, you may find that text elements within windows and menus become very small. Both OpenWindows and CDE allow you to increase the size of text used in windows, menus and alert messages.

- *Changing Text Size in OpenWindows*  
To change the font size used in OpenWindows, select **Workspace Properties** from the Workspace menu and then select Fonts from the Category menu. Within the fonts category window, select the required font style and size.
- *Changing Text Size in CDE*  
To change the font size used in CDE, select the Style Manager icon from the Front Panel and then select the Font icon from the Style Manager window. In the Font window, select the required font size and then click **OK**.

The change takes effect immediately for applications launched after the change is made. However, to make the change take effect for CDE itself, you must exit and then re-enter CDE.

---

## Customizing the Operating System

The SPARCbook preload of Solaris 2 is a standard Sun end user product with additional packages to support the Notebook Computing Environment software (including Save and Resume). Many of the facilities available on the complete Solaris operating system CD-ROM are not required by every user or are only occasionally needed. To save disk space, some less used facilities are not installed during the factory install process.

This section explains how to add facilities to your system by installing packages from the Tadpole distribution CD supplied with your SPARCbook or from the SunSoft Solaris CD. The instructions should be read in conjunction with your SunSoft Solaris documentation.

### Installing Packages

The basic procedure for adding packages is as follows:

- Connect a CD-ROM drive, either directly to your SPARCbook or to a server, containing the Tadpole or SunSoft distribution CD. Consult the system administrator, if required, for advice on using the CD-ROM with a server.
- Create the necessary device file (`/dev/dsk/c0t6dos0`), if it does not already exist, to read the CD-ROM. The device file can be created at boot time or without powering down, as described below.
- Mount the CD-ROM onto your file system.
- Use the `pkgadd` command to install the required packages.

#### ➤ *Connecting the CD-ROM*

Connect the CD-ROM to your SPARCbook's SCSI port with a target SCSI ID of 6, see Chapter 7 "Using SCSI Devices".

#### ➤ *Creating the Device Files – Boot Time*

To create the special device files during boot time, use the following procedure:

## Installing and Using Applications

### Customizing the Operating System

1. Press the power on button.
2. When the OpenBoot start-up screen is displayed, press **Pause-A**.



```
Tadpole S3 SPARCbook, keyboard present
ROM Rev 2.15 V1.00
32 MB memory installed, Serial #10683270
Ethernet address 0:0:83:a3:3:86, Host ID: Host ID:
80a30386
```

```
Initializing memory -
Type help for more information
ok
```

3. Enter the following commands:

```
ok create no-resume?
ok boot -r
```

The `-r` option causes the SPARCbook to carry out hardware reconfiguration. In this example, the SPARCbook detects the external CD-ROM at target ID 6 and creates the necessary special file `/dev/dsk/c0t6d0s0` to allow the CD-ROM's filesystem(s) to be accessed.

#### ➤ *Creating Device Files – On a Live System*

It may be necessary to add an external CD-ROM drive to a SPARCbook without powering the system down in order to allow uninterrupted access to available SPARCbook filesystems.

In this case, the device file described above can be created as follows:

1. Become superuser.
2. Enter the following commands:

```
# drvconfig -i sd
# disks
```

#### ➤ *Create the Mount-Point and Mount Your CD-ROM*

To do this, login as root and enter the following commands:

```
# cd /
# mkdir /cdrom
# mount -r /dev/dsk/c0t6d0s0 /cdrom
```

#### ➤ *Installing the Packages*

The `pkgadd` command is used to install the required packages. For example, to add a package to a Solaris 2.5.1 release, type:

```
# pkgadd -d /cdrom/Solaris_2.5.1 packageA
```

Follow the displayed instructions to complete the installation procedure.

You can add several packages at one time by specifying the required package names separated with a space. For example:

```
# pkgadd -d /cdrom/Solaris_2.5.1 packageA  
packageB
```

---

### Note

The name of the directory `Solaris_2.5.1` differs between versions of the operating system. You can ascertain the correct name by listing the contents of the CD-ROM. That is: `ls /cdrom.`

---

## Displaying Package Information

To display information about all packages that are already installed on your SPARCbook, type:

```
# pkginfo
```

Information about the installed packages is displayed on your screen.

Alternatively, to display information about specific packages, you can pipe the output of `pkginfo` into a `grep` command. For example, the following command could be used to display the NCE packages installed on your SPARCbook:

```
# pkginfo | grep nce
```

## Removing Packages

To remove packages, use the `pkgrm` command. For example:

```
# pkgrm packageA
```

You can remove several packages at one time, by specifying the package names separated with spaces. For example:

```
# pkgrm packageA packageB packageC
```

---

## Memory Usage and Swap Space

The Solaris operating system uses *virtual memory* to allow several applications to run simultaneously when they would otherwise require more memory than is physically present in the system. To support this feature, one of the disk partitions on the boot disk is assigned to provide your SPARCbook with ‘swap space’. This allows parts of programs that are not running at any given moment to be stored (or *swapped*) temporarily on to the hard disk while active applications are running in main memory. The effect of this is to make your SPARCbook’s memory appear to be much larger than it really is.

The `swap` partition created by the “factory install” on your SPARCbook’s removable hard disk drive is large enough to allow a reasonable number of tools and applications to be used simultaneously. Table 13-1 shows the sizes used for the `swap` partition for the different memory capacities. See also “Boot Disk Partitions” on page 6-5.

Memory (MB)	swap size (MB)
16	32
32	64
64	96
128	128
256	256

Table 13-1 Factory Configured Swap Partition Sizes

### Using swap space efficiently

All applications require a certain amount of memory to be available before they will start up. Your SPARCbook’s memory can soon be used up if you start up many applications and leave them all running on the OpenWindows or CDE workspace. Typically, if you are running one or two applications together with a Mail Tool, a clock and a File Manager



you would have no problems. However, if you run a large number of complex applications you are likely to run out of memory and swap space.

To minimize your memory and swap usage bear the following points in mind:

- Minimize the number of DeskSet tools in use. The tools use large amounts of memory. For example, if you only use the Calendar Manager occasionally, call it up from the Workspace menu when you need it rather than leaving it as an icon on your workspace.
- Avoid using tools that use memory continuously or often. For example, the performance meter tool runs every second. Similarly, if you enable the second hand on the clock, the clock program must run every second.
- Keep your mail in mailfiles if you have more than a few messages. Each message that appears when you open your mail file takes memory.
- Keep tools iconified if you are not using them, but do not want to quit them. For example, the performance meter and the File Manager tools are suspended when they are iconified, freeing up memory (but not swap space) for other processes.
- Arrange tools on the screen so they do not overlap. This reduces repainting by the Window Manager.
- If you are using the multi-browser in the Calendar Manager, quit it when you are finished rather than iconizing it, it is almost as quick to restart it from the Calendar Manager as it is to open it from the icon.
- Avoid using a background image for the main background, plain backgrounds use less memory.
- Avoid using PostScript applications at the same time as OpenLook applications.

## Installing and Using Applications

### *Memory Usage and Swap Space*

- Do not try and run too many applications at once. You may have to reduce the number of different applications active or on the DeskTop if you want to run a new large application.

## Checking swap space usage

You can find out how much swap space you are using at any time by using the following command:

```
% swap -l
```

This prints out the amount of swap space available and in use.

## Adding swap space

You can create and add additional swap space without reformatting the disk. For example, the following steps create a 16Mbyte file for use as extra swap space (you will need to be superuser or logged in as root to do this) as follows:

1. Create a swap file using the following commands:

```
# mkdir /swap
# cd /swap
# mkfile 16m SWAPFILE      Make a 16Mbyte file
```

2. Add the swap file to the system by edityou should add lines such as the following to the file `/etc/vfstab`:

```
/swap/SWAPFILE          - - swap - no - no -
```

3. Restart your SPARCbook using a full system startup

# Backup and Restore

This chapter describes the backup and restore facilities provided as part of the SPARCbook implementation of Solaris. In particular it provides an example of how to use `ufsdump` and `ufsrestore` to backup and restore filesystems.

The following topics are covered:

- Overview ..... 14 - 2
- File Backup Facilities ..... 14 - 3
- Backing Up Filesystems ..... 14 - 4
- Restoring Filesystems ..... 14 - 6
- Re-installing the Operating System from CD-ROM ..... 14 - 8

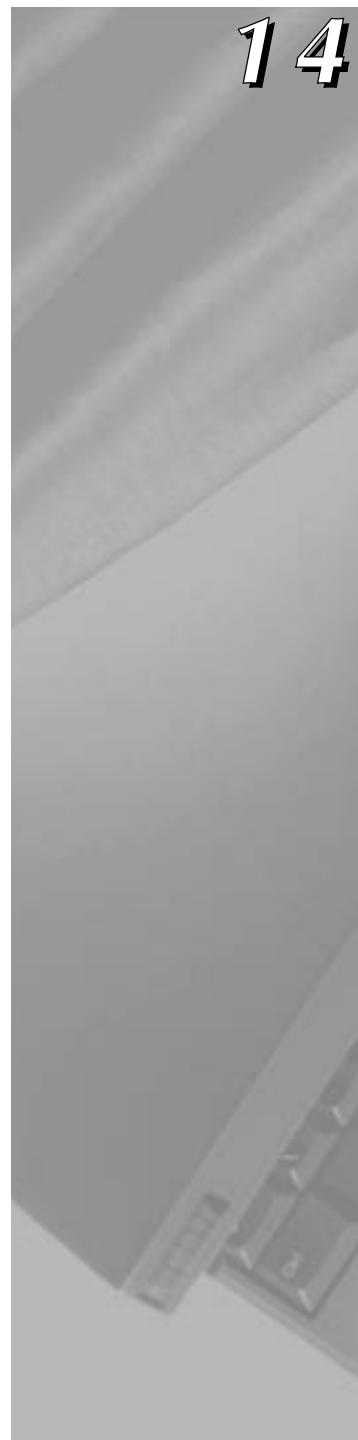

## Overview

System hangs and hard disk problems are hazards even with the most reliable computer systems, including your SPARCbook. Problems may be caused by operator error or by software or hardware failures. However reliable the software and hardware is, there is always a risk that you may lose valuable data. In the case of your SPARCbook, the hard disk can be removed very easily giving rise to the additional risks of losing or damaging a disk while it is not fitted in the system. For these reasons, it is vital to maintain regular backups of your work and of essential system configuration files.

## Backup strategies

SPARCbook usage and filesystem structures vary widely from system to systems, which means that your backup strategy must be appropriate for your individual needs. You should consult the system administrator for your organization who will be able to advise you on the best strategy for you and the facilities available. The following observations may help in devising your strategy.

- Your SPARCbook runs the standard Solaris operating system with backup capabilities identical to those of a conventional desktop system, including `tar`, `cpio` and `ufsdump`.
- The preloaded operating system is supplied on a CD-ROM and can be re-installed very easily. The installation process automatically configures your hard disk for you but provides no protection for work or applications directories.
- Consider also how cumbersome different media and drives are to carry around with your SPARCbook and whether you are able to power any external drives in a different country. The Tadpole removable hard disk adapter and Tadpole SCSI floppy disk drive provide light-weight options that are powered by your SPARCbook.

## Further information

The Solaris operating system contains many facilities for automated backup in a large networked environment. This guide can only describe very basic backup and restore facilities. For a complete description of the backup and restore capabilities of Solaris you will need to refer to SunSoft's publications. See "Associated Documents" on page xix.

---

## File Backup Facilities

For most purposes, `tar` and `cpio` are adequate for saving important files to tape or floppy. They are sufficient to save small amounts of data and have the advantage of allowing you to back up both local and remote filesystems mounted via NFS.

For example, the `tar` command could be used to make a backup of your `/export/home` directory to tape as follows:

```
$ tar cvf /dev/rmt/0 /export/home
```

As another example, to save the file `mywork` to a floppy disk using the Tadpole SCSI floppy disk drive, the command would be as follows (the disk must be formatted, see "Formatting a Floppy Disk" on page 7-14):

```
$ tar cf /dev/diskette mywork
```

To list the contents of the archive on the floppy in the form displayed by `ls -l`, the command would be:

```
$ tar tvf /dev/diskette
```

To extract the archive from the floppy the command would be:

```
$ tar xvf /dev/diskette mywork
```

For further information about `tar` and `cpio`, please consult the SunSoft Solaris documentation.

---

## Backing Up Filesystems

To make backups of a complete filesystem (or single disk partition), the `ufsdump` command provides an alternative. The general syntax for the command is as follows:

```
# ufsdump options arguments filesystem
```

Where `options` is a list of options to be used for this backup and `arguments` is a list of arguments that correspond to the list of options in the *same order*.

### Caution

---

**It is important to supply the arguments in the same order as their corresponding options. For example:**

```
ufsdump 0sd s-arguments d-arguments filesystems
```

**Failing to observe the correct order could completely destroy the filesystem being backed up.**

---

For example, to create backup of a disk partition on a 5.0 Gbyte tape unit 0, the following command would be used:

```
# ufsdump 0fu /dev/rmt/0 /dev/rdisk/c0t0d0sn
```

`0fu` is a list of options. `0` specifies the backup level, in this case a full backup; `u` specifies that the `/etc/dumpdates` file should be updated with a record of this backup; and `f` specifies that the dump is to be directed to something other than the default device.

`/dev/rmt/0` is the device to which the archive is to be directed. This argument corresponds to the `f` option.

`/dev/rdisk/c0t0d0sn`

is the raw disk device being backed up where `n` is the disk slice. See “Boot Disk Partitions” on page 6-5.

## Backing up partitions to tape

To make backups of the individual disk partitions on your removable hard disk drive, the following sequence of commands could be used, one for each partition to be backed up:

```
# ufsdump 0cfb /dev/rmt/0n 64 /           (slice 0)
# ufsdump 0cfb /dev/rmt/0n 64 /var       (slice 3)
# ufsdump 0cfb /dev/rmt/0n 64 /opt      (slice 5)
# ufsdump 0cfb /dev/rmt/0n 64 /usr      (slice 6)
```

The options used in these examples specify a level 0 or full backup, using a cartridge tape at `/dev/rmt/0n`, where `n` specifies the “no rewind”. The no rewind is most important for this type of backup scenario to prevent each subsequent dump from overwriting the last. In this case, the argument `/dev/rmt/0n` corresponds with the `f` option, and the `64` argument corresponds with the `b` (block size) option.

### Caution

---

It is important to restore the partitions in the same order they were backed up.

---

## Making a complete tape backup – worked example

This example creates a tape backup of the backup partition of your removable hard disk drive. This is special partition that spans the whole drive to make backing up the entire contents of the removable hard disk drive more convenient.

1. Connect a tape drive to your SPARCbook at ID 5.
2. Power on the external drives and your SPARCbook.
3. When the OpenBoot greeting is displayed, press **Pause-A** on the keyboard. The OpenBoot `ok` prompt is displayed.
4. Boot the SPARCbook with the following command:  

```
ok create no-resume?
ok boot -r
```
5. Log in as root.

## Backup and Restore

### Restoring Filesystems

6. At the Solaris command prompt, type the appropriate `ufsdump` command. For example, to create a full backup of the entire disk `c0t0d0` on a 5.0 Gbyte tape unit 0:

```
# ufsdump 0cfb /dev/rmt/0n /dev/rdisk/c0t0d0s2
```

## Backing up onto an external hard disk

Disk partitions can also be backed up to another locally connected disk drive with the `ufsdump` command (see “Configuring an External Hard Disk – Worked Example” on page 7-6 for information about configuring an external disk drive). The disk in that example had one large filesystem called `/external` mounted on `root`.

For example, to backup each partition in turn to an external hard disk, the commands would have the following form:

```
# ufsdump 0f /external/usr_arch_ddmmyy /usr
```

Where:

```
/usr_arch_ddmmyy
```

is the name of the dump file. The `_arch` element used in this example is an arbitrary reminder to the user at a future date that this is an archive, and `ddmmyy` provides an arbitrary date stamp.

---

## Restoring Filesystems

Filesystems can be restored from a `ufsdump` archive using the `ufsrestore` command.

### Caution

---

**It is important to restore the partitions in the same order they were backed up. See the example in “Backing up partitions to tape” on page 14-5.**

---

Carry out the restore procedure as follows:

1. Connect the backup drive to your SPARCbook. A tape drive should be connected at SCSI ID 5 or an external hard disk drive at SCSI ID 0, 1 or 2.



2. Power on your SPARCbook and external drive.
3. If you are using a tape device, ensure that the backup tape is rewound by logging in as root and entering the following command at the Solaris prompt (assuming that the backup device used was `/dev/mnt/0n`):  

```
# mt -f /dev/rmt/0n rewind
```
4. Reset your SPARCbook by entering the following commands:  

```
# sync  
# halt
```
5. Boot the SPARCbook with the following command:  

```
ok boot -r
```
6. Log in as root and then at the Solaris prompt, restore each partition in turn with the following sequence of commands:

---

**Note**

This example restores the partitions in the order they were backed up in “Backing up partitions to tape” on page 14-5.

---

```
# cd /  
# umount /mnt  
# mount /dev/dsk/c0t3d0s0 /mnt  
# ufsrestore -rf /dev/rmt/0n
```

To restore the `root` filesystem to your hard disk.

```
# cd /  
# umount /mnt  
# mount /dev/dsk/c0t3d0s3 /mnt  
# ufsrestore -rf /dev/rmt/0n
```

To restore the `var` filesystem to your hard disk.

```
# cd /  
# umount /mnt  
# mount /dev/dsk/c0t3d0s5 /mnt  
# cd /mnt  
# ufsrestore -rf /dev/rmt/0n
```

To restore the `opt` filesystem to your hard disk.

```
# cd /  
# umount /mnt  
# mount /dev/dsk/c0t3d0s6 /mnt
```

## Backup and Restore

### Re-installing the Operating System from CD-ROM

```
# cd /mnt
# ufsrestore -rf /dev/rmt/0n
```

This restore the `usr` filesystem to your hard disk.

7. At the Solaris prompt, enter the command:

```
# cd /
# umount /mnt
```

8. Reset your SPARCbook by pressing **Pause-R**.

---

## Re-installing the Operating System from CD-ROM

The Solaris operating system can be re-installed on your hard disk from the supplied Tadpole CD-ROM. You might do this to configure a new hard disk drive, to recover from a serious operating system problem or following a memory upgrade.

When you install Solaris from the Tadpole CD-ROM you can choose to configure the hard disk's partition map to suit your own preference or you can follow the default option. Table 14-1 shows a partition map for a hard disk installed from the CD using the default options except for the `var` partition which was selected explicitly. The resulting partition map differs from the factory installed partition map shown in "Boot Disk Partitions" on page 6-5. the .

Partition		Tag	Approximate Size (MB)
SPARCbook 3	SPARCbook 3000		
dsk/c0t3d0s0	dsk/c0t0d0s0	/	25
dsk/c0t3d0s1	dsk/c0t0d0s1	swap	1 - 2 x size of DRAM
dsk/c0t3d0s2	dsk/c0t0d0s2	backup	Disk size
dsk/c0t3d0s3	dsk/c0t0d0s3	var <sup>a</sup>	100
dsk/c0t3d0s4	dsk/c0t0d0s4	save	Same size as DRAM
dsk/c0t3d0s5	dsk/c0t0d0s5	/opt	30
dsk/c0t3d0s6	dsk/c0t0d0s6	/usr	120
dsk/c0t3d0s7	dsk/c0t0d0s7	/export/home	Remainder of disk

Table 14-1 Solaris Installer Configured Partition Map

- a. If selected

Restoring the complete factory installation from CD-ROM involves the following steps:

- Loading a version of the Solaris operating system from the Tadpole CD-ROM supplied with your SPARCbook.
- Rebooting your SPARCbook.

### Caution

---

The Solaris install program will destroy all of the data on your hard disk. Before installing Solaris onto a previously used disk, make backups of all filesystems so that you can recover your data afterwards. See “Backing Up Filesystems” on page 14-4.

---

### ➤ Loading Solaris

1. Connect the CD-ROM drive to your SPARCbook at SCSI ID 6.
2. Power up your SPARCbook and external drive and when the OpenBoot greeting is displayed, press **Pause-A** on the keyboard. The OpenBoot `ok` prompt is displayed.
3. Boot the SPARCbook with the following command:  

```
ok create no-resume?  
ok boot cdrom
```
4. After a considerable delay, the Solaris installer window is displayed. Follow the displayed instructions to install Solaris.
5. When the Solaris installation is complete, restore your data and configuration files into the newly created filesystems from backups created before starting out the install process. Alternatively, you can configure a new hard disk for your SPARCbook as described in Chapter 2 “Initial System Configuration”.

## **Backup and Restore**

*Re-installing the Operating System from CD-ROM*

# System Upgrades

This chapter discusses how to carry out upgrades to your SPARCbook. The user installed upgrades covered allow you to add larger hard disk drives and more DRAM to your SPARCbook.

This chapter provides the following sections:

- Overview ..... 15 - 2
- Upgrading the Hard Disk Drive ..... 15 - 2
- Upgrading the Main Memory ..... 15 - 3

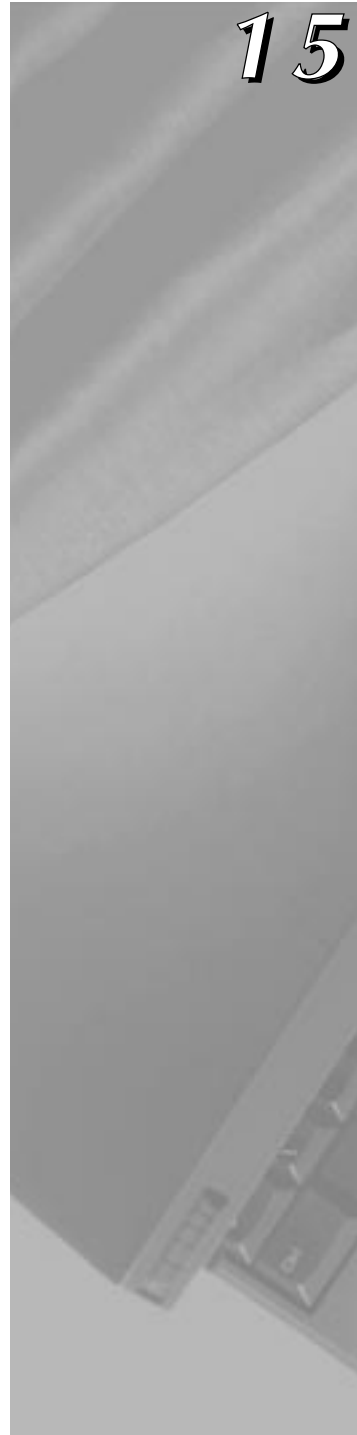

### Overview

The modular design of the SPARCbook enables the end user to carry out system upgrades by adding a larger hard disk and more main memory. Neither of these operations require the use of tools or other special equipment, but you will need a CD-ROM drive and the Tadpole or SunSoft Solaris CD.

---

### Upgrading the Hard Disk Drive

The removable hard disk drive makes it easy for you to carry out disk upgrades by installing larger capacity drives as they become available. Disks can be obtained from your SPARCbook supplier either blank or preloaded with the Solaris Operating System.

You can install Solaris onto a blank disk as described in “Re-installing the Operating System from CD-ROM” on page 14-8.

For preloaded disk, see “Configuring a boot disk” on page 6-8 for information about configuring a removable hard disk drive as a boot disk for your system.

---

## Upgrading the Main Memory

The main memory in your SPARCbook is provided by two single inline memory modules (SIMMS) that can be changed without the use of tools or other special equipment.

The process of upgrading your system's memory consists of two basic steps:

- Fitting the new memory modules.
- Reconfiguring the disk partitions to support the increased memory size. This is necessary if you wish to use the Save and Resume feature.

Reconfiguring the hard disk is a complex procedure with which you may require the assistance of an experienced system administrator. An alternative is to re-install the Solaris operating system from the Tadpole CD (after making a complete backup of all important files on your system). The Tadpole install program partitions the drive automatically for the new memory size. However, this can be a very time-consuming procedure.

### Fitting new SIMMs

#### **Caution**

---

Always fit an identical pair of SIMMs (for example, two 64MB SIMMs). Other combinations will not operate.

To avoid damaging your SPARCbook, observe antistatic precautions when replacing the SIMMs. Use the grounding wrist strap supplied with the upgrade kit and do not remove the new SIMMs from their antistatic bag until you are ready to fit them.

Before replacing the SIMMS, make backups of any important files and then power off using a system shutdown (see "Powering off using a system shutdown" on page 1-7). The SPARCbook recognizes when the memory capacity of your computer has changed but this can result in data loss if you use Save to power off your computer before you change the memory modules.

---

## System Upgrades

### Upgrading the Main Memory

The SPARCbook 3TX and SPARCbook 3000 models can be fitted with up to 256MB of DRAM. Other SPARCbook 3 models can be fitted with up to 128MB. The memory is contained on two identical SIMMs providing the upgrade capacities shown in Table 15-1.

Upgraded Capacity (MB)	SIMMs (MB)
32	2 x 16
64	2 x 32
128	2 x 64
256 <sup>a</sup>	2 x 128

*Table 15-1 Permissible Memory Capacities*

- a. The 256MB memory option is not available as user installed upgrade. For information about obtaining a 256MB upgrade contact your supplier or Tadpole Customer Support.

#### ☞ *Preparing to Remove the SIMMs*

- 1.** Ensure that your SPARCbook is powered off by carrying out a system shutdown, as described in “Powering off using a system shutdown” on page 1-7, and is not connected to an external power supply unit.
- 2.** Close the lid and place your computer upside down on a level surface.
- 3.** Remove the battery cover and battery.
- 4.** Placing the forefinger of the left hand on the L symbol and the forefinger of the right hand on the R symbol on the SIMM cover (see Figure 15-1), gently pull the SIMM cover toward yourself with your forefingers until the rearmost row of clips disengage from the base casting. Then, with your thumbs, press the cover towards the rear of the unit until the clips (normally) located beneath the battery disengage.



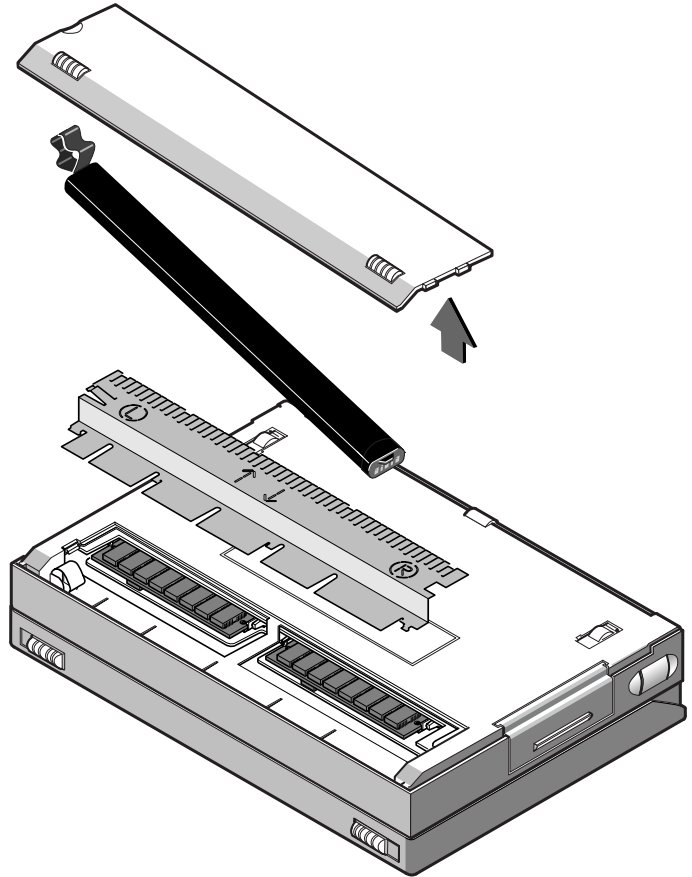

*Figure 15-1 Removing the Battery Cover, Battery and SIMM Cover*

➤ **Removing the SIMMs**

- 1.** Ensure that you are wearing the grounding wrist strap and that it is grounded as described by the supplied documentation.
- 2.** Gently press the latches of the first SIMM socket outward until the SIMM pops up (see Figure 15-2, views A and B). This frees the SIMM for removal.
- 3.** Remove the SIMM and place it in an antistatic bag.
- 4.** Repeat for the second SIMM.

## System Upgrades

### Upgrading the Main Memory

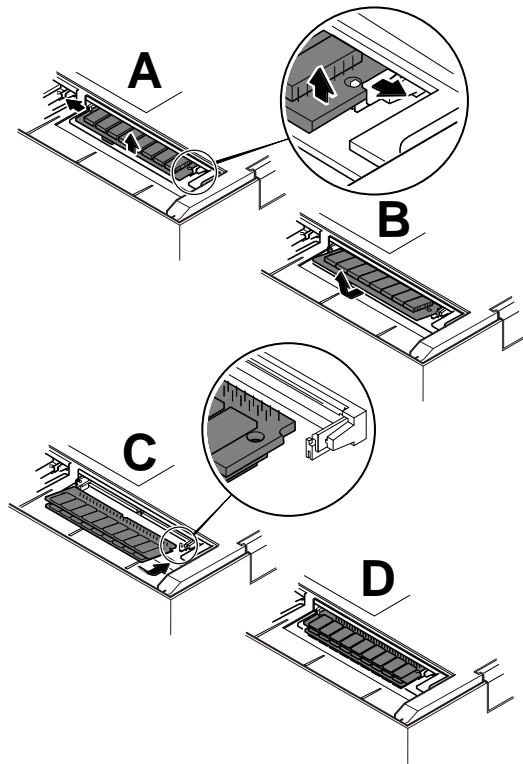

Figure 15-2 Removing and Replacing the SIMMs

#### ➤ Fitting SIMMs

1. Ensure that you are wearing the grounding wrist strap and that it is grounded as described by the supplied documentation.
2. Remove the first new SIMM from its antistatic bag.
3. Hold the SIMM so that its contact edge points away from you and the cut-out edge is on the right. Then, place the SIMM's contact edge against the SIMM connector (see Figure 15-2 views C and D).
4. With the contacts in position, gently press the SIMM downwards until the latches click into place.
5. Repeat steps 3 and 4 with the second SIMM.

6. Replace the SIMM cover.
7. Replace the battery and battery cover.

☞ *Checking the SIMMs*

1. Power your SPARCbook on.
2. When the OpenBoot greeting is displayed, press **Pause-A**.
3. Check that the new memory capacity is correctly reported on the display.
4. Power off by pressing **Pause-O**.

## Repartitioning the hard disk drive – worked example

### Caution

---

The example provided here assumes that the hard disk uses the default partition map created by the “factory load”. See “Boot Disk Partitions” on page 6-5.

Be sure to backup all important program and data files before making any changes to the disk partitions as the process will destroy data on the disk drive.

---

The steps required to reconfigure the partition map on your hard disk are as follows.

- Connect a CD-ROM and backup device to your SPARCbook and power on.
- Check that there is adequate free space on your internal hard disk.
- Create a full backup of the disk partitions. See “Backing Up Filesystems” on page 14-4.
- Repartition the hard disk drive using the `format` utility.
- Make and check the new filesystem(s).
- Restore the data from your backup. See “Restoring Filesystems” on page 14-6.

## System Upgrades

### Upgrading the Main Memory

This section provides a worked example as a guide to carrying out this part of the upgrade. It is assumed that a SPARCbook 3000 with 64MB of DRAM and a 3GB hard disk drive is being fitted with a memory upgrade to 128MB. It is also assumed that the hard disk has the factory installed partitions shown in “Boot Disk Partitions” on page 6-5.

#### Why Repartition the SPARCbook's Hard Disk

➤ The boot disk is organized into a number of partitions when the drive is formatted, each with a designated function. The layout of these partitions on the disk can vary, but the default (factory installed) partition map for a SPARCbook is shown below. See also “Boot Disk Partitions” on page 6-5.

➤ The diagram does not represent the partitions to scale but does show how the partitions are organized contiguously and without overlaps. The exception to this is the backup partition which occupies the whole disk and overlaps all the other partitions.

➤ The save partition must be the same size as the memory capacity of the system.

This is because the Save and Resume feature copies the contents of the main memory to an equal sized area of the hard disk before powering your SPARCbook down and uses this information to Resume the next time you power on (see

“How Save and Resume Functions” on page 5-2). Therefore, if you increase the memory, you must increase the save partition's size.

➤ You increase the size of the save partition by taking space from partitions with spare (or free) space, using the format utility. For example, if the opt partition (or /export/home if present in your partition map) has sufficient free space, you reduce its size and then add the freed up space to the save partition.

➤ The swap partition is used by the operating system to store applications that are running in the background. Therefore, an increase in the size of the main memory may require an increase in the size of the swap partition.

➤ The swap partition can be increased in size by taking free space from other partitions in the same way as for the save partition, or by creating a swap filesystem and mounting it as described in “Adding swap space” on page 13-10.

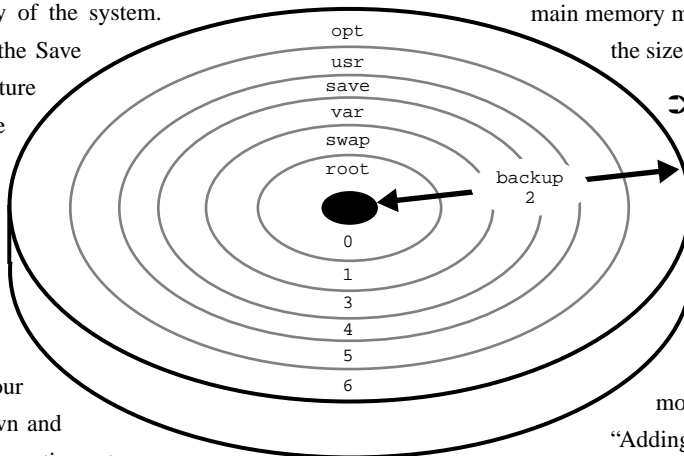

In this example, space is taken from the `opt` partition and added to the `save` and `swap` partitions. Table 15-2 shows the space that would be taken from `opt` to perform various memory upgrades on a SPARCbook, with this example shaded.

Memory Capacity (MB)		Free Space Required	
Before Upgrade	After Upgrade	MB	KB
32	64	64	65536
	128	160	163840
64	128	96	98304

*Table 15-2 Additional Disk Space Requirements*

Table 15-3 shows the recommended sizes for the swap partition for the different memory capacities. These are used to calculate the free space requirements shown in Table 15-2.

Memory (MB)	swap size (MB)
16	32
32	64
64	96
128	128

*Table 15-3 Recommended Swap Partition Sizes*

In this example, the upgrade from 64MB to 128MB requires a total of 96MB free space to provide an additional 64MB for the `save` and 32MB for the `swap` partitions.

**Note**

---

No examples are shown for upgrading to 256MB because this is a return to factory upgrade.

---

## System Upgrades

### Upgrading the Main Memory

#### ➤ *Checking for Free Space*

1. To check how much free space is available in `/export/home` enter the following command:

```
# df -k /opt
Filesystem      kbytes used  avail  capacity Mounted on
/dev/dsk/c0t0d0s5 2471936 494388 1977548 20%      /opt
```

In this example, the available disk space = 1977548 Kbytes.

#### Note

---

The `df -k` command displays the disk space usage and availability information in KBytes. Note that 1MB = 1024 Kbytes.

---

2. Subtract the additional disk space required (see Table 15-2) from the available free space. In this example a 64MB to 128MB upgrade:

$$1977548 - 98304 = 1879244$$

The result shows that there is sufficient space on this hard disk for the upgrade to succeed.

However, if there is not sufficient space (that is, result is a small or negative value), you will have to use a larger hard disk and load the operating system from the Tadpole or Sunsoft CDs or remove unwanted files from `/opt`.

#### ➤ *Calculating the New Partition Sizes*

Before you can repartition the drive, you need to calculate the new size of the `swap`, `save` and `home` partitions. Partition sizes are expressed in cylinders and blocks.

To calculate the number of blocks per cylinder, multiply the `hd` size by the `sec` size which are shown when you first issue the `format` command. In this example, `hd` = 8, and `sec` = 64 (see the `format` command on page 15-12):

$$1 \text{ cylinder} = 8 \times 64 = 512 \text{ blocks}$$

This drive has blocks of 512 bytes each so that one cylinder contains 262144 bytes:

Total number of bytes/cylinder =  $512 \times 512 = 262144$  bytes

This means that 4 cylinders on this drive provide 1MB of storage so that multiplying the size of a partition in MB by four gives its size in cylinders.

In this example 96MB must be removed from home, 64MB added to save and 32MB added to swap.

Adding space to the swap and save partitions means that the start cylinders for all subsequent partitions must be moved up by a corresponding amount. In this example, all partitions other than the root, backup and usr partitions must be moved, as illustrated in Figure 15-3.

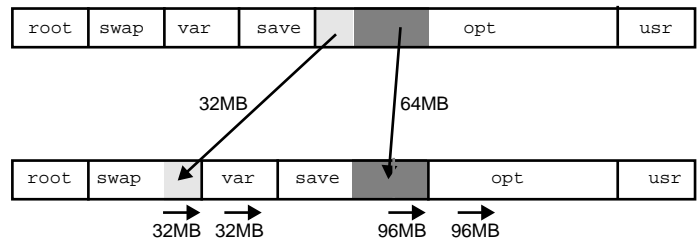

*Figure 15-3 Reassigning the Free Space*

## Repartitioning the drive

### ☞ *Preparing to Repartition the Drive*

Boot your SPARCbook from the Tadpole CD as follows:

1. Power up your SPARCbook with the CD-ROM drive containing the Tadpole CD connected to the SCSI port.
2. Press **Pause-A** when the SPARCbook greeting is displayed. The OpenBoot ok prompt is displayed.
3. At the ok prompt, type the following command:

```
ok boot cdrom
```

The SPARCbook boots from the CD-ROM. It takes several minutes for the boot process to complete before an OpenWindows desktop is displayed.

4. Ignoring the Solaris Installation window, select Command Tool from the Workspace Utilities menu (click and hold the mouse menu button on the desktop to display the Workspace menu and then go into Utilities). A Command Tool window is displayed. Use this to enter the commands described below.

#### ☞ Listing the Existing Disk Partitions

List the partitions as follows:

1. Enter the format command:

```
# format
Searching for disks...done

AVAILABLE DISK SELECTIONS:
0. c0t0d0 <IBM-DLGA-23080 cyl 11747 alt 2 hd 8 sec 64>
/iommu@0,...
```

2. Specify a disk from the AVAILABLE DISK SELECTIONS list. In this example, the only disk available is disk 0:

```
Specify disk (enter its number):0
selecting c0t0d0:
[disk formatted]
```

3. From the format menu, select partition:

```
format> partition
```

4. From the partition menu, select print:

```
partition> print
```

Part	Tag	Flag	Cylinders	Size	Blocks
0	root	wm	0 - 505	126.50MB (506/0/0)	259072
1	swap	wu	506 - 889	96.00MB (384/0/0)	6014464
2	backup	wm	0 - 11746	2.87GB (11746/0/0)	1582080
3	var	wm	890 - 1329	110MB (440/0/0)	225280
4	unassigned	wu	1330 - 1585	64.00MB (256/0/0)	262144
5	opt	wm	1586 - 11261	2.42GB (9676/0/0)	4943872
6	usr	wm	11262 - 11741	120.00MB (480/0/0)	256000
7	unassigned	wm	0	0 (0/0/0)	

#### Note

---

The save partition is partition 4 and may be shown as “unassigned”, although there are specifications for the start cylinder and number of cylinders used. The partition map above shows a system with a “factory installed” partition map (see “Boot Disk Partitions” on page 6-5).

---



If the partition map on your SPARCbook is similar to this, you can re-organize the partitions following this example. An alternative is to backup the system and reload from the Tadpole or Sunsoft CD after changing the SIMMs. Refer to Chapter 14 “Backup and Restore” for more information on how to back up and reload the system.

Make a note of the start cylinder and number of cylinders used for each partition to be changed. The number of cylinders is shown in the Blocks column as (cylinders/0/0). In this example, the swap and save partition are being increased in size so that the start cylinder for all subsequent partitions must move up by a corresponding amount.

Partition to Change		Old Values (Cylinders)			Size Change (Cylinders)	New Values (Cylinders)		
		Start	End	Used		Start	End	Used
1	swap	506	889	384	+128 <sup>a</sup>	506	1017	512
3	var	890	1329	440	0	1018	1457	440
4	save	1330	1585	256	+256 <sup>b</sup>	1458	1969	512
5	opt	1586	11261 <sup>c</sup>	9676	-384	1970	11261	9292
6	usr	11262 <sup>c</sup>	11742	480	0	1162	11742	480

*Table 15-4 Summary of Partition Changes*

- a. From Table 15-2.
- b. Increases to the same size as the new memory capacity of the SPARCbook.
- c. This number will be different for each drive.

Using the information displayed by the `partition>print` command, Table 15-4 shows the values that must be used for this example 64MB to 128MB memory upgrade.

### ➤ Changing the Partition Map

Change the partition map as follows:

#### Caution

---

Ensure that backups of all data on all partitions being changed exist before you continue. See “Backing Up Filesystems” on page 14-4.

---

#### 1. From the format menu, select partition:

```
format> partition

PARTITION MENU:
0      - change '0' partition
1      - change '1' partition
2      - change '2' partition
3      - change '3' partition
4      - change '4' partition
5      - change '5' partition
6      - change '6' partition
7      - change '7' partition
select - select a predefined table
modify - modify a predefined partition table
name   - name the current table
display - display the current table
label  - write partition map and label to the disk
quit
```

#### 2. Change each partition in turn as follows (using the values from Table 15-4 in this example):

```
partition> 1

Part Tag      Flag  Cylinders   Size      Blocks
1  swap      wu    506 - 889   96.00MB (384/0/0) 6014464

Enter partition id tag[swap]:<RETURN>
Enter partition permission flag [wu]:<RETURN>
Enter new starting cyl[506]:<RETURN>
Enter partition size [6014464b, 384c, 96.00mb]:512c

partition> 3

Part Tag      Flag  Cylinders   Size      Blocks
3  var       wm    890 - 1329  110MB (440/0/0) 225280

Enter partition id tag[var]:<RETURN>
Enter partition permission flag [wm]:<RETURN>
Enter new starting cyl[890]:1018
Enter partition size [225280b, 440c, 110.00mb]:<RETURN>

partition> 4

Part Tag      Flag  Cylinders   Size      Blocks
4  unassignedwu 1330 - 1585 64.00MB (256/0/0) 262144
```

```
Enter partition id tag[unassigned]:<RETURN>
Enter partition permission flag [wu]:<RETURN>
Enter new starting cyl[1330]:1458
Enter partition size [262144b, 256c, 64.00mb]:512c
```

```
partition> 5
```

```
Part Tag      Flag  Cylinders  Size  Blocks
5     opt      wm     1586 -11261 2.42GB (9676/0/0) 4943872
```

```
Enter partition id tag[home]:<RETURN>
Enter partition permission flag [wm]:<RETURN>
Enter new starting cyl[2086]:1992
Enter partition size [4943872b, 9656c, 125.00mb]:9277
```

3. When you have changed all of the the partitions, use the `label` command to write the new partition map to the disk:

```
partition>label
```

4. Quit from the partition and format menus:

```
partition> quit
format> quit
#
```

### ➤ *Making and Checking New Filesystems*

1. To make and then check new filesystems for the changed partitions, enter the following sequence of commands:

```
# newfs /dev/rdisk/c0t0d0s1
# fsck /dev/rdisk/c0t2d0s1

# newfs /dev/rdisk/c0t0d0s3
# fsck /dev/rdisk/c0t2d0s3

# newfs /dev/rdisk/c0t0d0s4
# fsck /dev/rdisk/c0t2d0s4

# newfs /dev/rdisk/c0t0d0s5
# fsck /dev/rdisk/c0t2d0s5

# newfs /dev/rdisk/c0t0d0s6
# fsck /dev/rdisk/c0t2d0s6
```

### ➤ *Completing the Upgrade*

The final step is to restore your backed up data to the new partitions. See “Restoring Filesystems” on page 14-6.

When all of the above steps are complete, reboot your SPARCbook from the internal hard disk by pressing **Pause-R**.

## **System Upgrades**

*Upgrading the Main Memory*

# Problem Solving and Support

This chapter provides information about solving common problems that may arise with your SPARCbook. It describes how to obtain technical assistance, provides a problem solving checklist, describes how to use the OpenBoot diagnostics software, and how to solve some common software problems.

This chapter contains the following information:

- Getting Further Help . . . . . 16 - 2
- Problem Solving Checklists . . . . . 16 - 3
- Using the OpenBoot Diagnostics . . . . . 16 - 8
- Software Problems . . . . . 16 - 11
- Resetting Your SPARCbook . . . . . 16 - 14

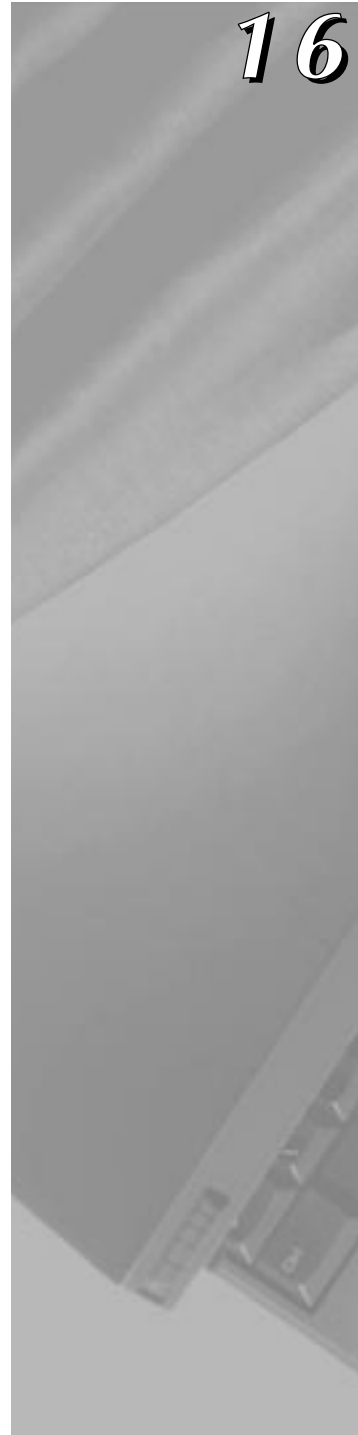

---

### Getting Further Help

If you are unable to diagnose the problem yourself, you can obtain technical support from your system administrator, from your SPARCbook supplier, or from Tadpole Customer Support.

Contacting Customer Support	
⇒	Customer Support can be contacted by telephone or Email.
⇒ Telephone:	US: 1 800 232-1881 UK and Europe: +44 1223 428 200
⇒ Email:	US: support@tadpole.com UK and Europe: support@tadpole.co.uk
⇒	In addition technical support information is provided on our website at the following URL:
	<a href="http://www.tadpole.com">http://www.tadpole.com</a>

When calling about a technical difficulty, please be ready to provide the following information. This will assist us in finding a solution to your problem as quickly as possible:

- Machine model and serial number (from the base of the unit).
- Machine configuration (what peripherals are connected).
- For networking problems, a brief description of your network.
- A description of the problem and any steps you have taken to solve it. See “Problem Solving Checklists” on page 16-3.
- Any warning messages or output you have observed.
- Any codes displayed in the status display.

## Problem Solving Checklists

### Startup problems

Possible Cause	What to Check or Action to Take
<b>⤷ No startup beep, main display is blank, status display is blank, green LED is not lit</b>	
The battery is not installed or is installed incorrectly.	Check that the battery is correctly installed. See “Installing the Battery” on page 1-3.
The battery is not the correct type (may have been swapped with one from an early SPARCbook 3 model).	Check that the battery is marked as a Tadpole “Series 2” type. Earlier SPARCbook 3 and SPARCbook 3LC models used a different (smaller) battery, which is not compatible with later SPARCbook 3 or SPARCbook 3000 models.
The battery is discharged.	Power your SPARCbook from the AC adapter (will also recharge the battery).
The AC adapter is faulty.	Try another Tadpole AC adapter to verify this. Contact Customer Support for assistance if the AC adapter appears to be faulty.
<b>⤷ SPARCbook fails to boot operating system, main display OK, status display OK</b>	
Removable hard disk drive is not fitted.	Check that the removable hard disk drive is fitted. If not: <ol style="list-style-type: none"> <li><b>1.</b> Press <b>Pause-A</b> to display OpenBoot prompt.</li> <li><b>2.</b> Press <b>Pause-O</b> to power down.</li> <li><b>3.</b> Fit the removable hard disk drive.</li> <li><b>4.</b> Press power-on button.</li> </ol>
SCSI ID conflict.	SPARCbook 3 models: check that the removable hard disk drive has a SCSI ID set to 3 and that no external drives use this ID. See “Setting the SCSI ID for the RHDD” on page 6-7.  SPARCbook 3000 models: check that external drives are <b>not</b> set to SCSI ID 0. See “SCSI IDs” on page 7-4.

## Problem Solving and Support

### Problem Solving Checklists

Possible Cause	What to Check or Action to Take
<p>You have your SPARCbook configured to use NIS or NIS+ but restarted while no longer connected to the network.</p> <p>This means your SPARCbook is looking for a name server to which it has no connection.</p>	<p>Reset and restart your SPARCbook as follows:</p> <ol style="list-style-type: none"><li>1. Press <b>Pause-R</b>.</li><li>2. When the OpenBoot welcome message is displayed, press <b>Pause-A</b>. The OpenBoot ok prompt is displayed.</li><li>3. At the ok prompt, enter the following commands: <pre>ok create no-resume? ok boot -r</pre></li></ol> <p>See “Configuring your SPARCbook to use a name server” on page 8-11.</p>

## Save and Resume problems

Possible Cause	What to Check or Action to Take
<b>▷ SPARCbook fails to Resume</b>	
<p>The removable hard disk drive does not have usable Resume data in the save partition.</p>	<p>Carry out a full system startup. See “Using Full System Startup” on page 1-8.</p>
<p>Removable hard disk drive is not fitted.</p>	<p>Check that removable hard disk drive is fitted. If not:</p> <ol style="list-style-type: none"><li>1. Press <b>Pause-A</b> to display OpenBoot prompt.</li><li>2. Press <b>Pause-O</b> to power down.</li><li>3. Fit the removable hard disk drive.</li><li>4. Press power-on button.</li></ol>
<p>SCSI ID conflict</p>	<p>SPARCbook 3 models: check that the removable hard disk drive has a SCSI ID set to 3 and that no external drives use this ID. See “Setting the SCSI ID for the RHDD” on page 6-7.</p>



Possible Cause	What to Check or Action to Take
<p>There has been a hardware change since the last Save.</p>	<p>Your SPARCbook could be attempting to Resume to a filesystem on an external disk that is not there.</p> <p>Reconnect the external drive and try again or carry out a full system startup. See “Using Full System Startup” on page 1-8.</p> <hr/> <p>Your SPARCbook is trying to Resume to a network filesystem but is not connected to the same network.</p> <p>Reconnect the external drive or carry out a full system startup. See “Using Full System Startup” on page 1-8.</p>
<p>Your are using a disk from a SPARCbook with a larger memory capacity.</p> <p>This means that there is not enough memory to Resume the operations Saved on the larger system</p>	<p>Save and Resume between different SPARCbooks works only if they have the same memory capacity. See “How Save and Resume Functions” on page 5-2.</p> <p>Use standard Solaris shutdown and startup. See “Using Full System Startup” on page 1-8.</p>
<p>The disk partitions have been changed and there is no <code>save</code> partition.</p> <hr/> <p>Memory has been upgraded and the <code>save</code> partition has not been increased in size.</p>	<p>Create a save partition on the hard disk if you wish to use Save and Resume. See “Why Repartition the SPARCbook’s Hard Disk” on page 15-8.</p>
<p>You have connected an external hard disk with a lower SCSI ID which also has a <code>save</code> partition.</p>	<p>This problem arises when you attempt to boot your SPARCbook with two bootable hard disks attached and your SPARCbook was previously powered down with a Save.</p> <p>Use a system shutdown to power off, as described in “Powering off using a system shutdown” on page 1-7, and a conventional system startup as described in “Using Full System Startup” on page 1-8.</p>

**Network problems**

Possible Cause	What to Check or Action to Take
<p>➤ <b>You are unable to communicate over the network</b></p>	
<p>Faulty transceiver or transceiver cable.</p>	<p>Check basic Ethernet communication using the <code>ping</code> command. For example:</p>
<p>Bad connection to Ethernet cable or unterminated Ethernet cable.</p>	<p style="text-align: center;"><code># ping systemname</code></p> <p>If the communications path is operating a message will be returned:</p> <p style="text-align: center;"><code>systemname is alive</code></p>
<p>Entry for remote system not in local <code>/etc/hosts</code> or entry for your system not in remote <code>/etc/hosts</code>.</p>	<p>If there is a hardware or a configuration problem there will be no response. The command will time-out after a while, but you may terminate it with the <b>Ctrl-C</b> interrupt command. If <code>ping</code> fails there may be a basic hardware or software configuration problem and you should check the hardware interfaces and the basic software setup.</p>
<p>Cannot find name server or name service configuration files or they contain incorrect information.</p>	<p>Ask for help from an experienced network administrator about specific configuration requirements for you location.</p> <p>See “Configuring Your SPARCbook for a TCP/IP Network” on page 8-9.</p>
<p>Internet addresses incorrect or duplicated.</p>	<p>See “Configuring your SPARCbook to use a name server” on page 8-11.</p>
<p>No write permission to requested resources.</p>	

## Other hardware problems

Possible Cause	What to Check or Action to Take
<b>↳ Display Problems</b>	
External display blank.	External display interface not enabled. Use NCE Display Panel to enable the external display.  See “Connecting an External Display” on page 11-8.
Small image displayed in center of screen with large blank borders.	You are using a virtual frame buffer on a display with a higher resolution. This is not a fault condition.  Zoom in on the image by pressing <b>Pause-PageDown</b> . See “Pan and Zoom” on page 11-4.
Garbled display.	Wrong display timing parameters set. Use NCE Display Panel to correctly configure the display interface. See “Configuring the Display Interface Using NCE” on page 11-9.
<b>↳ I/O Problems</b>	
External keyboard or mouse does not work.	Check that the external mouse or keyboard are compatible types and are connected to the combined Keyboard and Mouse port using the correct Sun-compatible cable.  Check if the keyboard and SPARCbook are communicating by using the command <code>kbconfig -r</code> . The keyboard LEDs should light.  In the case of an optical mouse you can see if it is powered by checking to see if the red LED on the underside of the mouse is illuminated.

---

# Using the OpenBoot Diagnostics

OpenBoot is an industry standard (IEEE1275) ROM-based firmware implementation that controls your SPARCbook between the time it is powered on and the Solaris operating system takes control. During this time OpenBoot carries out the hardware testing and initialization before booting the operating system.

OpenBoot also provides a user interface and programming language, based on Forth, which can be used to perform diagnostics and change user-configurable options stored in NVRAM.

## Displaying the OpenBoot user interface

Display the OpenBoot user interface as follows:

1. Power on your SPARCbook.
2. When the OpenBoot start-up screen is displayed, press **Pause-A**. The OpenBoot ok prompt is displayed.



```
Tadpole S3 SPARCbook, keyboard present
ROM Rev 2.15 V1.00
32 MB memory installed, Serial #10683270
Ethernet address 0:0:83:a3:3:86, Host ID:80a30386
```

```
Initializing memory -
Type help for more information
ok
```

## Checking SCSI devices

To check whether your SPARCbook can communicate with SCSI devices, enter the following command:

```
ok probe-scsi
```

This produces a list of SCSI devices attached to your SPARCbook.

On SPARCbook 3 models, the list should include the internal disk (if fitted) at target 3, and any external SCSI devices. On SPARCbook 3000 models, only external drives are listed.

If your SPARCbook does not list any connected SCSI devices, then either the connection or device may be faulty. To test the SPARCbook's internal SCSI hardware, use the following commands:

```
ok setenv diag-switch? true
ok test scsi
```

If the SCSI chip is functioning correctly, messages similar to the following are displayed.

```
Dma register test -- succeeded
Esp register test -- succeeded
Dma read test -- succeeded
Dma write test -- succeeded
ok
```

Disable diagnostics again using the following command:

```
ok setenv diag-switch? false
```

## Checking the network interface

As a check to see whether your SPARCbook's Ethernet hardware and connection to the Ethernet media are functioning correctly, enter the following command:

```
ok watch-net
Using AUI Ethernet Interface
Lance register test -- succeeded.
Internal loopback test -- succeeded.
External loopback test -- succeeded.
Looking for Ethernet packets.
'.' is a good packet. 'X' is a bad packet.
Type any key to stop.
.....
```

A series of periods ( . . . ) should be printed rapidly across the screen if the internal hardware and Ethernet connection are functioning correctly. If you are still having network problems, you should check your operating system network configuration. See "Network problems" on page 16-6.

### Full system hardware selftest

Carrying out a full system selftest with OpenBoot entails the following basic steps:

- Connecting an ASCII terminal to one of the serial ports on the rear of your SPARCbook.
- Configuring OpenBoot to enable diagnostics and terminal I/O.
- Entering the selftest command.

#### ➤ *Connecting an ASCII terminal*

You can connect an ASCII terminal to either of the serial ports. See “Using Serial Devices” on page 12-2.

The terminal should be configured for 9600 baud operation, 8 bits, no parity and no handshaking.

#### ➤ *Enabling Terminal I/O*

Enter the following commands to configure OpenBoot to enable diagnostics. Use the serial channel as the input and output devices and to inhibit auto-booting:

```
setenv diag-switch? true
setenv output-device ttya
setenv input-device ttya
setenv auto-boot? false
```

#### Note

---

The last command will prevent your SPARCbook from automatically booting the operating system when you power on (the normal mode of operation). You must reverse these commands, as described below, to re-enable normal start-up operation.

---

Now reset your SPARCbook by pressing **Pause-R**. Your SPARCbook should display a long sequence of messages on the terminal followed by the `ok` prompt. If the `ok` prompt is not displayed, try pressing **Return** on the terminal’s keyboard a few times. If it is still not displayed, press **Pause-A** on the SPARCbook’s keyboard type and then:

```
ttya io
```

If the `ok` prompt still does not appear, contact customer support or your supplier for assistance.

➤ *Carrying out the Hardware Selftest*

To test the internal devices, type:

```
ok test-all
```

The results of the tests will be displayed on the terminal. If any devices fail, contact your supplier for further assistance.

➤ *Re-enabling Normal Operation*

To re-enable normal operation, enter the following commands:

```
setenv diag-switch? false
setenv output-device display
setenv input-device keyboard
setenv auto-boot? true
```

To make the changes take effect, press **Pause-O** to power down and then press the power-on button to power on again.

---

## Software Problems

The operating system controls the peripherals and is, therefore, a critical component in enabling the SPARCbook to operate correctly. For example, a minor error in a network configuration file can completely prevent the network interface from operating.

This section provides some information on common software problems and gives brief advice about possible remedies in each case. By its very nature it cannot be complete and situations may arise where you need the help of an experienced system administrator or Tadpole Customer Support. See “Getting Further Help” on page 16-2.

### Stopping processes

To stop the processes that use keyboard input, press the interrupt character **Ctrl-C**. This normally causes a program to exit. However, not all programs recognize or act on the interrupt in which case you need to *kill* the process in order to halt it, as described in the next section.

### Killing a program

Before killing a process, you must know its process ID number (PID). To determine this, display a summary of all user processes with the following command:

```
# ps -ef
```

Make a note of the PID of the program you wish to kill. For example, the following output shows a program called demo running with a PID of 718:

PID	TTY	TIME	COMD
678	p2	0:00	sh
713	p2	0:05	sh
718	p2	0:32	demo
728	p2	0:01	ps

To kill the demo process, you would type:

```
# kill -9 718
```

The `-9` specifies that the process should be killed regardless of what it is doing. If you do not own the process, you will need to become superuser to carry out this step.

### Operating system panic

If there is a hardware or a software fault, the operating system may panic. This occurs when the operating system encounters a problem so serious it cannot continue to run the machine. If the system does panic, a message will be printed on the screen saying so, together with as much information as the operating system is able to gather about the cause. You should record the information for subsequent use by Customer Support. See “Getting Further Help” on page 16-2.

The system may be able to reboot automatically or may require a reset, as described below.

### Failing program

Programs can fail to run for a variety of reasons, some of which are as follows:

- Corrupt program



- The disk copy of the program has been corrupted.
- Shared library inconsistency  
The program was compiled with a shared library that is incompatible with the SPARCbook. Use the `ldd` utility to determine what libraries a program is loading. This problem can only be resolved by relinking the application with the shared libraries.
- Program Error  
A programming fault can cause a segmentation violation if, for example, a program attempts to write to an illegal or protected address.
- Out of Swap Space or Memory Space  
A message may sometimes be printed on the console if either of these conditions occur. If you are running OpenWindows the server may suddenly exit, returning you into the terminal interface. See “Memory Usage and Swap Space” on page 13-8.
- Memory failure  
There has been a memory error (hardware) during program execution.

The Solaris operating system includes the `trace` utility that allows you to monitor the system calls made by a process. This can be used by an experienced UNIX programmer to track down the cause of a problem. In addition, experienced UNIX programmers may be able to use the `crash`, `adb` or `dbx` debugger utilities provided to determine the cause of a core dump.

## Warning messages

The Solaris operating system often prints system information in the form of warnings. This does not necessarily mean there is anything wrong, but it is helpful to understand which messages may be an indication of a problem and which are there for information.

Warning messages are generally displayed in the console window but may also be displayed in a command tool or application window.

Some messages may indicate that the system has run out of resources and require attention. For example, a program may fail to start or may print a message such as:

```
        out of swap space
or      out of memory
or      FS full on /dev/c0t0d0s6
```

```
        : cannot write %xyx
```

As a rule you should exit the offending program in this. It may be prudent to reboot the operating system after such an event because applications and the operating system do not always recover from resource failures gracefully.

If you run out of disk space you must either move files to a different filesystem, or to a networked server, or you must remove them.

---

## Resetting Your SPARCbook

If the operating system has panicked, or the keyboard appears to have locked up and all other remedies have failed, you may have to reset the SPARCbook.

A reset should only be used as a last resort because the operating system will have open files and unflushed buffers which will have to be repaired when the system is rebooted.

To reset the system press the **Pause-R**.

After a reset, your SPARCbook performs a complete Solaris reboot and run the automatic filesystem check program (`fsck`). After completing the `fsck`, the system either automatically reboots, or may complete a single user start-up sequence and issue the `#` prompt.

In the latter case type **Ctrl-D** to continue the normal boot sequence.

# Technical Specifications

This appendix provides detailed technical specifications for the SPARCbook 3 GX and TX (S3GX and S3TX) and SPARCbook 3000 ST and XT models (S3000ST and S3000XT).

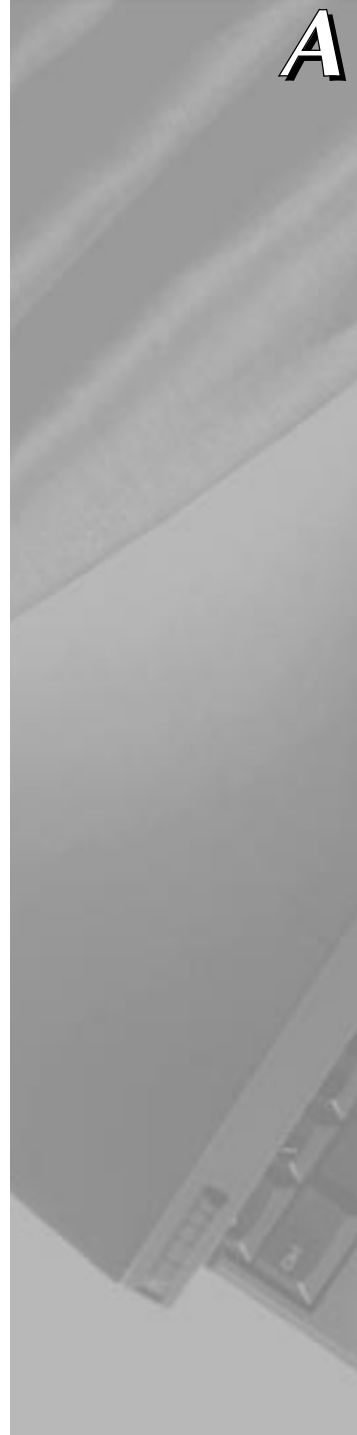

## Technical Specifications

Feature	Model			
	S3GX	S3TX	S3000 ST	S3000 XT
<b>☞ CPU</b>				
<b>Processor</b>	MicroSPARC II	TurboSPARC		
<b>Clock Speed</b>	110MHz	170MHz		
<b>Level 2 Cache</b>	-	256KB		
<b>System Performance</b>		3.5 SPECint95, 3.0 SPECfp95		
<b>☞ Memory</b>				
<b>DRAM</b>	16 - 128MB	16 - 256MB		
	With parity error protection at 1 bit per 32-bit word User installable SIMMs (up to 128MB; 256MB factory installed upgrade)			
<b>Video RAM</b>	2 MB			
<b>SRAM</b>	8 KB, Battery backed			
<b>EEPROM</b>	1 Kbit, Serially accessed			
<b>Monitor ROM</b>	512 Kbyte, Sectored Flash			
<b>☞ Storage</b>				
<b>Hard Disk Drive</b>	2.5 inch SCSI		2.5 inch IDE	
	Contained in user-removable module			
<b>☞ Internal Display</b>				
<b>Type</b>	TFT color			
<b>Size</b>	10.4 inch		12.1 inch	
<b>Resolution</b>	800 x 600			1024 x 768
<b>Colors</b>	up to 16,777,216			
<b>☞ Internal Peripherals</b>				
<b>Keyboard</b>	Lexmark Model M6 84-key notebook keyboard Country specific keyboard layout, according to order			
<b>Pointing Device</b>	Pointing stick and 3-button mouse incorporated in keyboard			
<b>Status Indicators</b>	Power On LED (green) Battery warning LED (orange) 2 line, 16 character status display			

Feature	Model			
	S3GX	S3TX	S3000 ST	S3000 XT
<b>↻ Interfaces</b>				
<b>External Display</b>	640 x 480 (VGA) to 1280 x 1024 Up to 16,777,216 simultaneous colors, depending upon resolution			
<b>Ethernet</b>	IEEE802.3 AUI interface 26-pin high density mini-D type connector			
<b>SCSI-2</b>	8-bit fast interface, synchronous transfers up to 10 MB/s 50-pin mini-D type SCSI-2 connector			
<b>Parallel</b>	8-bit bidirectional 26-pin high density mini-D type connector			
<b>Serial Ports</b>	2x serial ports RS232 synchronous or asynchronous operation 8-pin mini-DIN connector			
<b>Mouse/Keyboard</b>	Combined keyboard and mouse port 6-pin mini-DIN connector Supports Sun Type 4 or Type 5 compatible keyboards and mouse.			
<b>Modem</b>	V32bis, Send/Receive Fax V42bis compression		Not applicable to SPARCbook 3000 models	
<b>ISDN</b>	Terminal equipment (TE 2B + D) interface 8-pin RJ45 socket			
<b>Audio</b>	16-bit stereo (CD quality) Stereo headphone output Stereo line-level outputs Stereo line-level inputs Built-in mono mic (for speech quality audio input)			
<b>PCMCIA</b>	PCMCIA 2.0 interface Two Type I/II cards or one Type III card Hot swap			
<b>↻ Power</b>				
<b>Internal Battery</b>	Rechargeable 12V 1.8 AH NiMH Approx. 1.5 hours operation, depending upon power management measures			
<b>Power Supply / Battery Charger</b>	Input: 100-240 V a.c. 50-60 Hz Output: 12 V 5 A d.c.			

## Technical Specifications

Feature	Model			
	S3GX	S3TX	S3000 ST	S3000 XT
<b>Case</b>				
<b>Base Casting Material</b>	Magnesium alloy AZ91			
<b>Headshell</b>	Magnesium alloy AZ91		PC/ABS GE6200	
<b>Palm Rest Material</b>	Not applicable		Elastofoam / Isocyanate	
<b>Dimensions</b>	11.8 x 8.5 x 2.0 inches 300 x 216 x 51 mm		11.8 x 10.27 x 2.0 inches 300 x 261 x 51 mm	
<b>Weight</b>	7.0 lb (3.15 kg) including battery		8.0 lb (3.62 kg) including battery	
<b>Approvals</b>	FCC class B UL EN60950 CE			
<b>Environmental</b>				
<b>Temperature</b>	Operational: 5 - 35°C (41 - 95°F) Stored: -20 - 60°C (-4 - 140°F)			
<b>Vibration</b>	Operational: 3g Stored: 5g			
<b>Humidity</b>	Operational: 8-80% RH			

# Connector Reference

This appendix provides details of the connector pin assignments for the interfaces on the I/O panel.

The connectors detailed are as follows:

- DC In ..... B - 2
- Parallel Port Connector ..... B - 2
- Ethernet ..... B - 3
- Video ..... B - 3
- SCSI ..... B - 4
- Keyboard/Mouse ..... B - 5
- Serial Ports ..... B - 5
- ISDN ..... B - 5
- Modem (SPARCbook 3 Models Only) ..... B - 6

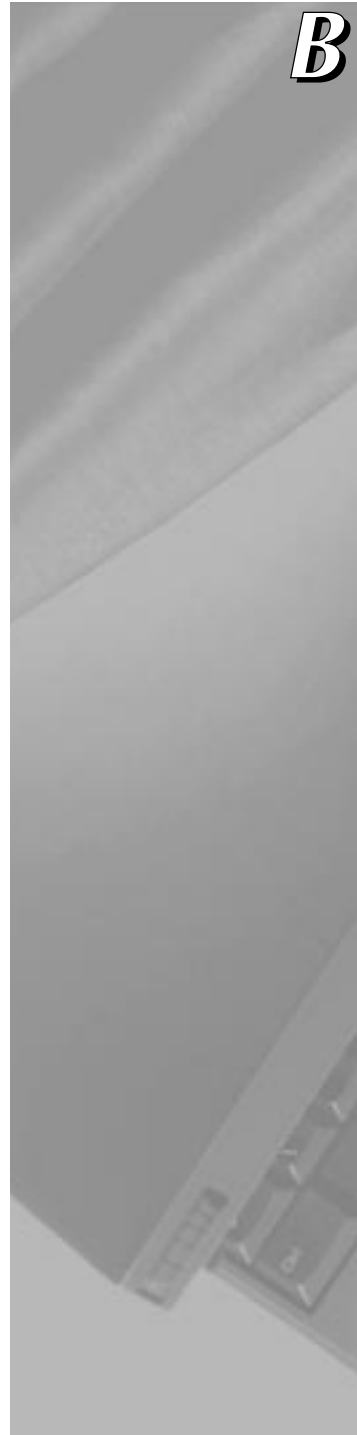

## DC In

Connector	Pin	Signal
	1	+12 V
	2	0 V

## Parallel Port Connector

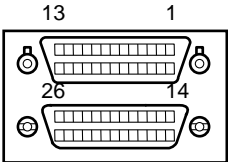
Connector <sup>a</sup>	Pin	Signal	Pin	Signal
	1	/STROBE	14	/AUTOFEED
	2	DATA (0)	15	/ERROR
	3	DATA(1)	16	/INIT
	4	DATA(2)	17	/SELECT_IN
	5	DATA(3)	18	Signal Ground
	6	DATA(4)	19	Signal Ground
	7	DATA(5)	20	Signal Ground
	8	DATA(6)	21	Signal Ground
	9	DATA(7)	22	Signal Ground
	10	/ACK	23	Signal Ground
	11	/BUSY	24	Signal Ground
	12	PE	25	Signal Ground
	13	SLCT	26	Signal Ground

a. The upper connector of a double-stacking pair

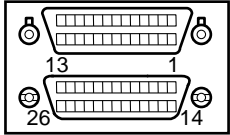

## Ethernet

Connector <sup>a</sup>	Pin	Signal	Pin	Signal
	1	TRANSMIT DATA-	14	TRANSMIT DATA+
	2	RECEIVE DATA+	15	RECEIVE DATA-
	3	COLLISION-	16	COLLISION+
	4	+12V	17	Signal Ground
	5	Not connected	18	Not connected
	6	Not connected	19	Not connected
	7	Not connected	20	Not connected
	8	Not connected	21	Not connected
	9	Not connected	22	Not connected
	10	+5 V	23	Signal Ground
	11	+5V	24	Signal Ground
	12	Not connected	25	Not connected
	13	+5V	26	Signal Ground

a. The lower connector of a double-stacking pair.

## Video

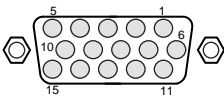
Connector	Pin	Signal	Pin	Signal
	1	RED	9	Not Connected
	2	GREEN	10	Signal Ground
	3	BLUE	11	DISPLAYID(0)
	4	DISPLAYID(2)	12	DISPLAYID(1)
	5	Signal Ground	13	HSYNC
	6	Signal Ground	14	VSYNC
	7	Signal Ground	15	DISPLAYID(3)
	8	Signal Ground		

# SCSI

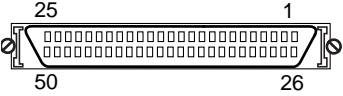
Connector	Pin	Signal	Pin	Signal
	1	Signal Ground	26	SCSI D (0)
	2	Signal Ground	27	SCSI D (1)
	3	Signal Ground	28	SCSI D (2)
	4	Signal Ground	29	SCSI D (3)
	5	Signal Ground	30	SCSI D (4)
	6	Signal Ground	31	SCSI D (5)
	7	Signal Ground	32	SCSI D (6)
	8	Signal Ground	33	SCSI D (7)
	9	Signal Ground	34	SCSI D(PARITY)
	10	Signal Ground	35	Signal Ground
	11	Signal Ground	36	Signal Ground
	12	Not Used	37	Not Used
	13	Not Used	38	SCSI TERMPWR
	14	Not Used	39	Not Used
	15	Signal Ground	40	Signal Ground
	16	Signal Ground	41	/SCSI ATN
	17	Signal Ground	42	Signal Ground
	18	Signal Ground	43	/SCSI BSY
	19	Signal Ground	44	/SCSI ACK
	20	Signal Ground	45	/SCSI RST
	21	Signal Ground	46	/SCSI MSG
	22	Signal Ground	47	/SCSI SEL
	23	Signal Ground	48	/SCSI CD
	24	Signal Ground	49	/SCSI SREQ
	25	Signal Ground	50	/SCSI IO

## Keyboard/Mouse

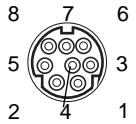
Connector	Pin	Signal	Pin	Signal
	1	0V	5	Keyboard Tx
	2	0V	6	Keyboard Rx
	3	5V	7	Mouse Tx
	4	Mouse Rx	8	5V

## Serial Ports

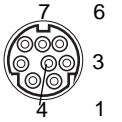
Connector	Pin	Signal	Pin	Signal
	1	DTR	5	RECEIVE DATA
	2	CTS	6	RTS
	3	TRANSMIT DATA	7	DCD
	4	Chassis Ground	8	TX CLOCK

## ISDN

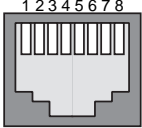
Connector	Pin	Signal	Pin	Signal
	1	Not Connected	5	TE IN-
	2	Not Connected	6	TE OUT-
	3	TE OUT+	7	Not Connected
	4	TE IN+	8	Not Connected

## Connector Reference

*Modem (SPARCbook 3 Models Only)*

---

### Modem (SPARCbook 3 Models Only)

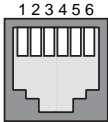
Connector	Pin	Signal	Pin	Signal
	1	Not Connected	4	TIP
	2	Not Connected	5	Not Connected
	3	RING	6	Not Connected

# Customer Support Information

All Tadpole products are rigorously tested before dispatch to the customer. However, if your system develops a serious fault it may need to be returned to the factory for repair. This appendix tells you what to do in this event.

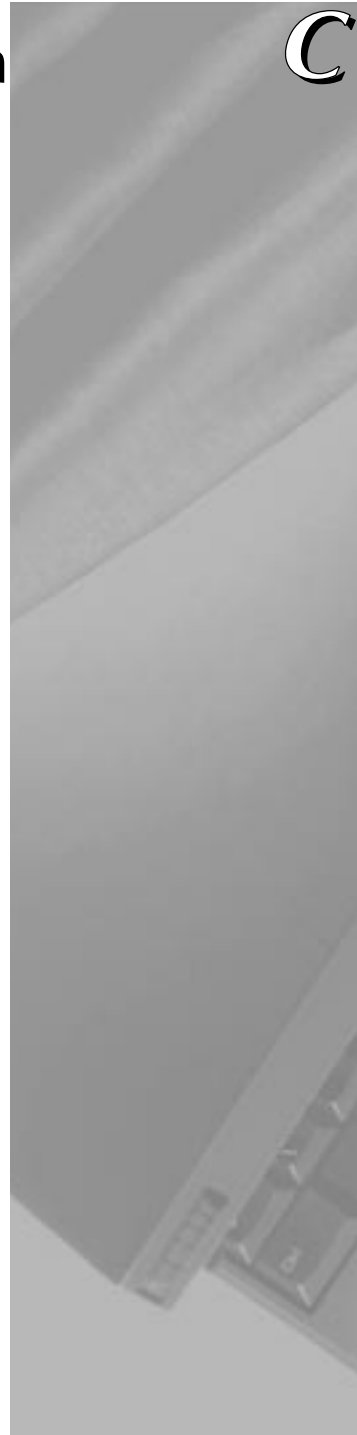

---

# What to do if You Suspect a Fault

If you suspect that your system is faulty, please take the following steps:

- 1.** Contact your Tadpole Customer Service representative for assistance. If a factory repair is necessary, your Tadpole Customer Service representative will issue you with a Materials Returns Authorization (MRA) number and arrange for your system to be collected.
- 2.** Fill out the System Details, Contact Details, and Fault Details sections in the form opposite.
- 3.** Remove the battery from the system and it, along with a filled out copy of the form, into its original packaging for transportation. If the original packaging is no longer available, we require that a strong carton be used with a minimum of 5 cm (2") of polystyrene or equivalent packing surrounding the system within the carton. The system must not be free to move within the carton.

### Contacting Customer Services

#### United States/Canada

Phone:  
(800) 232-1881

Email: support@tadpole.com

#### United Kingdom/Europe

Phone:  
+44 1223 428200

Email:  
support@tadpole.co.uk

---

## Conditions

- *MRA Numbers*  
You must have an MRA number before returning products for repair. Any carriage charges arising from products that are shipped without an MRA number will be presented for your settlement.
- *Packaging*  
Failure to follow steps 3 and 4 overleaf may invalidate any warranty. Tadpole Technology cannot be held liable for any damage occurring during in transit.

**Field Returns Form****Contact details**

MRA Number: \_\_\_\_\_ User: \_\_\_\_\_

Company: \_\_\_\_\_ Phone Number: \_\_\_\_\_

Fax Number: \_\_\_\_\_ Email: \_\_\_\_\_

Pickup Address: \_\_\_\_\_

Delivery Address (if different): \_\_\_\_\_

\_\_\_\_\_

\_\_\_\_\_

**System details**

Serial Number: \_\_\_\_\_ Model: \_\_\_\_\_

*The serial number is shown on the base of the unit and is displayed on screen during system bootup.*

Disk Size: \_\_\_\_\_ DRAM Size: \_\_\_\_\_

Operating System: \_\_\_\_\_ Version: \_\_\_\_\_

Root Password: \_\_\_\_\_

*If you do not wish to divulge your password, please ensure that it is disabled before returning your system. Please also ensure that any disk security is disabled. Give clear details of any additional software security you may have installed.*Do you require us to make a backup copy of your disk  Y/N

Reseller (if applicable): \_\_\_\_\_

Warranty Contract Number (if applicable): \_\_\_\_\_

**Fault details***Please supply a detailed description of the problem including: the operating system and version in use; any applications running; any displayed error messages; and any peripherals (e.g. disk drives, displays) in use. when the fault occurred**Continue on another sheet of paper if required*

## **Customer Support Information**

*Conditions*



# Index

## A

- AC adapter, connecting 1-5
- accelerated graphics 11-3
- accessing the internet 8-7
- actions on battery warning 4-3
- adding display types 11-14
- adding swap space 13-10
- amber LED, battery charger 4-7
- applications, installing 13-3
- applications, third party 13-2
- approvals A-4
- associated documents xix
- AT command set 9-15
- attaching an external battery pack 4-9
- audio interface 3-8
- AUI 8-2
- automatic file mounting 8-16
- automatic Save 5-5

## B

- Back Porches, calculating 11-15
- backing up
  - filesystems 14-4
- backing up onto an external hard disk 14-6
- backing up partitions to tape 14-5
- backup and restore 14-1
- battery
  - behavior 4-5
  - conditioning 4-5
  - exhaustion 4-5
  - replacing 4-5
  - safety features 4-4
  - self discharge 4-5
- battery charger 4-6
  - amber LED 4-7
  - using 4-7
- battery charger, green LED 4-7

- battery charging 4-2
- battery charging, external 4-10
- battery life, maximizing 4-4
- battery low warning LED 3-3, 4-3
- Battery status 4-2
- battery status 3-16
- battery, installing 1-3
- boot disk
  - model differences 6-5
  - partitions 6-5, 15-8
- boot disk, command 5-4
- boot disk, configuring 6-8
- boot disk, partition sizes 6-5
- boot failure 16-3
- brightness, adjusting 3-12
- built-in display
  - brightness 3-11, 3-12
  - viewing angle 3-11
- built-in keyboard 3-11, 3-14
- built-in pointing device 3-3, 3-15

## C

- canceling save, keyboard command 3-12
- car adapter 4-12
  - connecting 4-12
  - disconnecting 4-14
  - green LED 4-12
  - safety 4-12
  - using during engine starts 4-14
- caring for your SPARCbook 1-2
- case, specifications A-4
- changing the partition map 15-14
- charging time, external battery 4-10
- charging, internal battery 4-6
- checking a modem 9-3
- checking filesystems 7-10
- checking for free space 15-10

- checking new filesystems 15-15
- checking new SIMMs 15-7
- checking SCSI devices 16-8
- checking swap space usage 13-10
- checking the network interface 16-9
- class 2 fax command set 9-21
- classes of address, IP 8-5
- client 8-2
- clock speed A-2
- color LCD display 3-3
- color mapping 11-6
- color mode 11-6
- communications, remote 9-1
- complete tape backup 14-5
- completing a memory upgrade 15-15
- Compose 3-12
- configuring a boot disk 6-8
- configuring a modem 9-2
- configuring the /etc/exports file 8-14
- configuring the display interface 11-9
- connecting
  - AC adapter 1-5
  - ASCII terminal 16-10
  - audio equipment 12-4
  - car adapter 4-12
  - external display 11-8
  - external keyboards 1-10
  - external mouse 1-10
  - floppy disk drive 7-12
  - hard disk drive adapter 6-9
  - internal modem 9-5
  - modem 9-2
  - SCSI devices 7-3, 7-6
  - SLIP 9-13
  - to the network 8-3
- connecting a charger 4-6
- connecting the AC adapter 1-5
- connectors
  - DC-In 3-5
  - external battery 3-5
  - rear panel 3-7
- contacting Customer Support 16-2

- CPU specification A-2
- create no-resume?, command 5-4
- creating a mount point 7-10
- creating display types 11-14
- creating filesystems 7-10, 15-15
- creating special files 7-6
  - floppy 7-13

## D

- daisy chain 7-3
- DC-In active symbol 3-17
- DC-In connector 3-5, B-2, C-2
- default router, setting up 8-12
- defining external displays 11-14
- device files, modem 9-2
- diagnostics 16-8
- dimensions, unit A-4
- direct attachment, external battery 4-9
- disabling file sharing 8-15
- disabling Save and Resume 5-7
- disk activity symbol 3-17
- disk partitions
  - boot disk 6-5
  - mount points 6-5
- disk partitions and memory upgrades 6-6
- display
  - panning 11-4
  - zooming 11-4
- display interface hardware, setting up 11-12
- display interface, overview 11-2
- display parameters
  - described 11-16
- display resolution limitations 11-7
- display types
  - creating 11-14
- display, built-in 3-3
- Document summary xvi
- domain 8-2

## E

- editing the hosts files 8-10
- editing the passwd file 9-11

- Electrical Safety Notice v
- electronic mail 9-14
- Email addresses, Tadpole 16-2
- emulated frame buffer 11-2
- emulated framebuffer 11-3
- enabling file sharing 8-14
- enabling Save and Resume 5-8
- ensuring reliable SCSI operations 7-2
- entering Openboot 3-12
- Environmental Notice vi
- Ethernet
  - cables 8-3
  - interface 3-8
- example
  - repartitioning the hard disk 15-7
  - tape backup 14-5
- exhausted battery 4-5
- exporting local filesystems 8-14
- Ext. Battery, status message 4-3
- external battery pack 4-8
  - attaching 4-9
  - charging 4-10
  - charging time 4-10
  - connector 3-5
  - detaching 4-11
  - extension cord 4-10, 4-11
  - main components 4-8
- external keyboards 1-10
  - connector 3-8
- external mouse 1-10
- external mouse connector 3-8

## F

- failing boot 16-3
- failing program 16-12
- failure to Resume 16-4
- fax commands 9-21
- FAXtool 9-22
- FCC Class B Notice iii
- FCC Part 68 Modem Information iv
- file mounting, automatic 8-16
- file sharing, disabling 8-15

- file sharing, enabling 8-14
- filesystems
  - backing up 14-4
  - checking 15-15
  - creating 15-15
  - creating and checking 7-10
  - exporting 8-14
  - mounting 7-10, 8-15
  - network sharing 8-13
  - restoring 14-6
- fitting new SIMMs 15-3
- fitting SIMMs 15-6
- floppy
  - formatting 7-14
  - inserting and ejecting 7-14
  - using for raw storage 7-16
- floppy disk drive
  - connecting 7-12
  - SCSI ID 7-12
- Front Porch 11-15
- full system startup 1-8
- function keys 3-11

## G

- getting help 16-2
- green LED 3-3
- green LED, battery charger 4-7
- green LED, car adapter 4-12

## H

- hard disk
  - removing 6-3
- hard disk drive, specification A-2
- hard disk drive, upgrading 15-2
- hardware problems, general 16-7
- hardware selftest 16-10, 16-11
- headphones 3-8
- host name 2-3
- hostnames 8-2, 8-10
- how Save and Resume functions 5-2

## I

- I/O panel 3-5, 3-7
- I/O panel connectors 3-8
  - Ethernet 3-8
  - modem 3-9
  - serial 3-8
  - video 3-8
- icons
  - I/O panel 3-8
  - status display 3-17
- inserting a removable hard disk drive 6-10
- inserting and ejecting a floppy 7-14
- installing applications 13-3
- installing the battery 1-3
- Int. Battery status message 4-2
- interfaces, specifications A-3
- internal battery 4-4
  - operating on 4-4
- internal display, specification A-2
- internal modem 3-9, 9-21
  - AT command set 9-15
- Internet 8-2
  - addresses 8-4
- Internet access 8-7
- Internet address 2-3
- Internet addresses, registering 8-8
- Internet Protocol 8-4
- IP addresses 8-6, 8-10
- ISDN connector 3-9, B-5

## K

- keyboard angle 3-6
- keyboard commands 3-12
- keyboard port 3-8
- keyboard, built-in 3-11
- killing a program 16-12

## L

- LAN active symbol 3-17
- latches 3-3
- LEDs

- battery low 3-3
  - green 3-3
  - orange 3-3
  - Power ON 3-3

- left function 3-11
- Left function keys 3-12
- legs 3-6
- level 2 cache A-2
- listing the disk partitions 15-12
- loading PPP packages 9-6
- low battery Save 5-5

## M

- machine identification label 3-6
- machine status 3-16
- mail, electronic 9-14
- main memory upgrade 15-3
- making filesystems 15-15
- maximizing battery life 4-4
- memory configuration A-2
- memory upgrade, completing 15-15
- memory upgrades and disk partitions 6-6
- model differences, boot disk 6-5
- modem 9-5
  - connector B-6
- modem device files 9-2
- modem, internal 3-9
- mount point, creating 7-10
- mounting a filesystem 7-10
- mounting a floppy onto a filesystem 7-15
- mounting a remote directory 8-15
- mounting filesystems 8-15
- mouse connector 3-8, B-5

## N

- name server, using 8-11
- name service 2-3
- native mode 11-3
- NCE
  - starting 1-9
- network connection, testing 8-12
- Network File System (NFS) 8-2

- Network information 2-3
- Network Information Service (NIS) 8-2
- network interface 8-1
- network names 8-6
- network problems 16-6
- network sharing 8-13
- networks
  - PPP 8-19
  - remote 9-15
  - SLIP 8-19
  - terminology 8-2
- numeric keypad 3-13

## O

- one to one 11-5
- OpenBoot diagnostics 16-8
- OpenBoot user interface 16-8
- Openboot, entering 3-12
- OpenWindows, quitting 3-12
- operating system panic 16-12
- orange LED 3-3
- OS status 3-16

## P

- packages (Solaris 2) 13-5
  - removing 13-7
- panning 11-4
- parallel 3-8
- parallel connector B-4
- parallel devices 12-3
- parallel port 3-8
- partition changes, example summary 15-13
- partition sizes, boot disk 6-5
- partitions
  - backing up 14-5
  - boot disk 15-8
  - calculating sizes 15-10
  - listing 15-12
- Pause-Page Down 11-5
- Pause-Page Up 11-5
- PCMCIA
  - adapters 10-2

- memory cards 10-2
  - port 3-3, 10-4
- PCMCIA active symbol 3-17
- PCMCIA cards
  - installing 10-5
  - removing 10-6
- PCMCIA Interface 10-1
- pinouts, connectors B-2, C-2
- Pointing Stick 3-3
- point-to-point protocol 9-5
- power management 4-2
- power off, using shutdown 5-6
- Power ON
  - button 3-3
  - LED 3-3
- Powering off 1-7
- powering off using save 5-3
- powering on 1-6
- PPP 8-19, 9-5
- PPP, setting up 9-6
- PPP, testing a link 9-13
- preparing to remove the SIMMs 15-4
- preparing to repartition the drive 15-11
- problem solving checklists 16-3

## Q

- quit OpenWindows, command 3-12

## R

- rear panel 3-5
- recommended swap partition sizes 15-9
- recovering from failed Resume 5-4
- re-enabling normal operation 16-11
- re-installing the operating system 14-8
- remote
  - communications 9-1
  - networks 9-15
- remote commands 8-18
- remote computing 9-1
- remote copying files 8-18
- remote network access 9-5
- remote program execution 8-19

- removable hard disk 3-5, 6-1
  - care of 6-4
  - overview 6-2
- removable hard disk drive adapter 6-9
- removable hard disk drive, security 6-12
- removable hard disk type, SPARCbook 3 6-6
- removable hard disk type, SPARCbook 3000 6-6
- removable hard disks, additional 6-7
- removing an removable hard disk drive 6-11
- removing the hard disk 6-3
- removing the SIMMs 15-5
- repartitioning the hard disk 15-7, 15-8
- reset 3-12
- resetting the SPARCbook 16-14
- restoring filesystems 14-6
- Resume failure 16-4
- right function 3-11
- Right function keys 3-12

**S**

- safety features, battery 4-4
- safety information, car adapter 4-12
- Save
  - automatic 5-5
  - canceling 3-12
  - keyboard command 3-12
  - on battery low 5-5
  - on inactivity 5-5
- Save and Resume 1-7, 5-1
  - enabling and disabling 5-7
  - ensuring reliable operation 5-3
  - functional description 5-2
  - using 6-2
- Save and Resume and file sharing 8-13
- Save and Resume and security 5-6
- Save and Resume failure, recovery 5-4
- save and swap partitions sizes 6-6
- save partition 6-5, 15-8
- save, partition 5-2
- SCSI 3-8
- SCSI daisy chain 7-3
- SCSI devices
  - checking 16-8
  - connecting 7-3
  - special files 7-5
- SCSI devices, overview 7-2
- SCSI ID 7-6
- SCSI ID for the removable hard disk drive 6-7
- SCSI ID, floppy disk drive 7-12
- SCSI IDs 7-4
- SCSI port 3-8
- SCSI termination
  - floppy disk drive 7-13
- SCSI terminator 6-11
- SCSI terminators 7-4
- security
  - removable hard disk drive 6-12
- self discharge, battery 4-5
- Sending a fax 9-22
- serial devices 12-2
- serial interface 3-8
- serial line IP (SLIP) 9-5
- server 8-3
- setting the Xserver resolution 11-11
- setting up PPP 9-6
- SIMMs
  - fitting 15-6
  - removing 15-5
- SIMMs, checking 15-7
- SIMMs, fitting 15-3
- SIMMs, preparing to remove 15-4
- simultaneous display operation 11-7
- single SCSI devices, overview 7-2
- Sleep 5-5
- SLIP 8-19, 9-13
- software problems 16-11
- sound, adjusting 3-12
- SPARC Compliance Definition 13-2
- SPARCbook 3, removable hard disk type 6-6
- SPARCbook 3000, removable hard disk type 6-6
- special function keys 3-12
- stand-alone charging, external battery 4-11
- starting and stopping PPP 9-12
- starting NCE 1-9

- startup problems 16-3
- startup, full system 1-8
- status display 3-3, 3-16, 4-2
- status message
  - Ext. Battery 4-3
  - Int. Battery 4-2
- stopping processes 16-11
- Sun monitors 11-8
- superuser password 2-4
- swap partition 15-8
- swap partiton, recommended sizes 15-9
- swap space 13-8
- swap space, adding 13-10
- symbols
  - I/O panel 3-8
  - status display 3-17
- system administrator 8-4
- system configuration 2-2
- system files, editing 9-7
- system reset 3-12
- system shutdown 1-7
- system shutdown (using Save) 3-12
- system upgrades, overview 15-2

## **T**

- Tadpole Email addresses 16-2
- Tadpole SCSI floppy disk drive 7-11
- target ID 7-4
- TCP/IP 8-3
- TCP/IP Networking 8-9
- TCP/IP networking, overview 8-4
- technical Specifications A-1
- terminal I/O 16-10
- terminal login connection 9-3
- terminator switch, removable hard disk drive adapter 6-12
- testing a PPP link 9-13
- testing devices 16-11
- testing Your network connection 8-12
- thick wire Ethernet 8-3
- thin wire Ethernet 8-3
- Time zone 2-4

- TTY ports 3-8
  - pinout B-5
- twisted pair Ethernet 8-3
- Typographical conventions xx

## **U**

- unit dimensions A-4
- unmounting a remote directory 8-17
- unmounting a remote filesystem 8-17
- upgrade, main memory 15-3
- upgrading the hard disk drive 15-2
- URL, Tadpole Technology 16-2
- user account 2-5
- user ID 2-7
- user name 2-7
- using 1-7
- using a battery charger 4-7
- using a mouse 1-10
- using a name server 8-11
- using an external keyboard 1-10
- Using different screen environments 1-9
- using ifconfig 8-10
- using Save 1-7
- using Save and Resume 6-2
- using SCSI devices 7-1
- using swap space efficiently 13-8
- UUCP database files 9-9

## **V**

- vehicle adapter 4-12
- video connector B-3
- video port 3-8
- video timing signals 11-16
- virtual framebuffer 11-3
- volume, adjusting 3-12

## **W**

- WAN active symbol 3-17
- warning messages 16-13
- warning, battery low 4-3
- worked example

system configuration 2-2

## **X**

Xserver and display resolution 11-2

Xserver resolution 11-2, 11-3

## **Z**

Zoom to Fit 11-5

zoom to view 11-6

zooming 11-4

    keyboard commands 3-12