

UltraBook I70/200

Hardware User's Guide



431105801A

Please contact RDI Computer at:

RDI Computer Corporation
2300 Faraday Avenue
Carlsbad, CA 92008
Phone (760) 929-0992
FAX (760) 929-9702
email: info@rdi.com
<http://www.rdi.com>

For RDI Customer Service:
2308 Faraday Avenue
Carlsbad, CA 92008
7:00 AM to 6:00 PM PST
Phone 1-800-734-7030
or (760) 929-0992
FAX (760) 931-5981
email: support@rdi.com

UltraBook User's Guide, Copyright 1997 RDI Computer Corporation.

All rights reserved.

September 1997

RDI Part# 431105801, Revision A

Printed in the United States of America

UltraBook, Colorplus, Peripheral Expansion Unit, and PXU are trademarks of RDI Computer Corporation.

Sun, Sun Microsystems, NFS, the Sun Logo, DeskSet, Solaris, SunOS, SunView, OpenWindows, Sun-4, and Sun-5, are trademarks or registered trademarks of Sun Microsystems, Inc. SPARC trademarks, including the SCD Compliant Logo, are trademarks or registered trademarks of SPARC International, Inc. SPARC is licensed exclusively to Sun Microsystems, Inc. TurboSPARC is licensed exclusively to Fujitsu, Microelectronics Inc. Products bearing SPARC trademarks are based upon the architecture developed by Sun Microsystems, Inc. UNIX and OpenLook are registered trademarks of Unix System Laboratories.

Ethernet is a trademark of Xerox Corporation. Apple and PowerBook is a registered trademark of Apple Corporation. All other product names mentioned herein are trademarks or registered trademarks of their respective owners.

Table of Contents

Preface		xiii
Conventions in this User's Guide		xiii
Procedures		xiii
Notes		xiii
Warnings and Cautions		xiv
Keyboard Conventions		xiv
Screen Messages		xiv
Variables		xiv
Supplemental Documentation		xv
Chapter 1	Introducing UltraBook	1-1
Introducing UltraBook Components		1-1
Introducing UltraBook Features		1-2
Chapter 2	Quick Start	2-1
Check the ambient air temperature		2-1
Open the UltraBook		2-2
Install the Lithium-Ion batteries		2-2
Plug in the AC power adapter		2-3
Open the UltraBook back and side panels		2-4
Turn the power switch on		2-5
View the initial system screens		2-6
Log on to the system		2-7
Chapter 3	Using UltraBook	3-1
Setting Up		3-1
Opening the Display Cover		3-1
Providing Power		3-3
Operating UltraBook		3-7
Starting UltraBook		3-7
Shutting UltraBook Down		3-9
Using Halt		3-11
Moving UltraBook		3-11

Restarting UltraBook	3-11
Using UltraBook Features.	3-13
Removing Hard Disk Drives.	3-13
Recording with the External Microphone	3-15
Ejecting PCMCIA Cards.	3-16
Terminating Devices Attached to the SCSI Port	3-16
Using an External Keyboard or Pointing Device	3-16
Using an External Display.	3-16
Connecting an Ethernet Cable.	3-17
Using the Serial/Parallel Port	3-17
Upgrading Memory (RAM).	3-19

Chapter 4	Troubleshooting	4-1
------------------	------------------------	------------

Starting and Booting	4-1
Battery Operation	4-4
SCSI Port	4-5
Ethernet	4-5
Serial Ports.	4-6
External Video Port	4-6
External Keyboard/Mouse Port.	4-7
Customer Service and Support	4-7

Appendix A:	Low Battery Shutdown	A-1
--------------------	-----------------------------	------------

Overview	A-1
Battery Status.	A-2
Duration	A-2
System Actions	A-2
Actions You can Perform	A-2

Appendix B:	NVRAM Settings	B-1
--------------------	-----------------------	------------

Appendix C:	External Monitor Matrix	C-1
--------------------	--------------------------------	------------

Index

Notice Disclaimer of Warranty

RDI Computer Corporation makes no representations or warranties with respect to this manual, and shall not be liable for technical or editorial omissions made herein; nor incidental or consequential damages resulting from the furnishing, performance, or use of this manual. Further, RDI Computer Corporation reserves the right to make changes in the specifications of the product described within this manual at any time without notice and without obligation of RDI Computer Corporation to notify any person of such revision or changes.

Copyright Notice

All rights reserved. No part of this publication may be reproduced, stored in a retrieval system, or transmitted, in any form or by any means, electronic, mechanical, photocopying, recording, or otherwise, without the prior written permission of RDI Computer Corporation. No patent liability is assumed with respect to the use of the information contained herein. While every precaution has been taken in the preparation of this publication, RDI Computer Corporation assumes no responsibility for errors or omissions. Nor is any liability assumed for damages resulting from the use of the information contained herein. Further, this publication and features described herein are subject to change without notice.

FCC Compliance Statement

This equipment has been tested and found to comply with the limits for a class B digital device, pursuant to Part 15 of the FCC Rules. These limits are designed to provide reasonable protection against harmful interference when the equipment is operated in a commercial environment. This equipment generates, uses, and can radiate radio frequency energy and, if not installed and used in accordance with the instructions, may cause harmful interference to radio and television reception. However, there is no guarantee that interference will not occur in a particular installation.

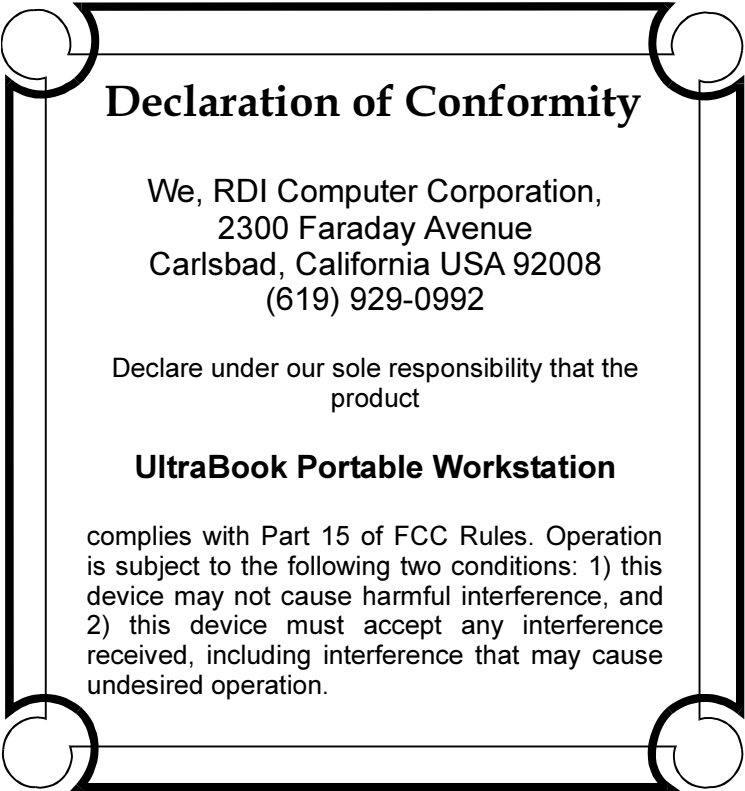

Declaration of Conformity

We, RDI Computer Corporation,
2300 Faraday Avenue
Carlsbad, California USA 92008
(619) 929-0992

Declare under our sole responsibility that the
product

UltraBook Portable Workstation

complies with Part 15 of FCC Rules. Operation is subject to the following two conditions: 1) this device may not cause harmful interference, and 2) this device must accept any interference received, including interference that may cause undesired operation.

If this equipment does cause interference to radio and television reception, which can be determined by turning the equipment off and on, the user is encouraged to try to correct the interference by one or more of the following measures:

- Reorient or relocate the receiving antenna. Increase the separation between the equipment and receiver.
- Connect the equipment into an outlet on a circuit different from that to which the receiver is connected.
- Consult the dealer or an experienced radio/TV technician for help.

Shielded Cables

Connections between the UltraBook workstation and peripherals must be made using shielded cables in order to maintain compliance with FCC radio frequency emission limits.

The connection of nonshielded equipment interface cable to this equipment will invalidate the FCC Certification of this device and may cause interference levels that exceed the limits established by the FCC for this equipment. It is the responsibility of the user to obtain and use a shielded equipment interface cable with this device. If this equipment has more than one interface connector, do not leave cables connected to unused interfaces.

Changes or modifications not expressly approved by the manufacturer could void the user's authority to operate the equipment.

Modifications

Modifications to this device not approved by RDI Computer Corporation may void the authority granted to the user by the FCC to operate this equipment.

DOC Class B Notice

This digital apparatus does not exceed Class B limits for radio noise emission for a digital apparatus as set out in the Radio Interference Regulations of the Canadian Department of Communications.

Avis

Le présent appareil numérique ne met pas de bruits radioélectriques dépassant les limites applicables aux appareils numériques de la classe B prescrites dans le Règlement sur le brouillage radioélectrique édicté par le ministère des Communications du Canada.

Safety Precautions



WARNING: Hazardous voltages are present inside the UltraBook workstation. To reduce the risk of electrical shock and/or personal injury, follow the operating and installation instructions carefully.



WARNING: Do not attempt to recharge alkaline or other non-rechargeable batteries with the UltraBook workstation's AC adapter/charger. Alkaline batteries cannot be recharged. Attempting to recharge alkaline batteries may cause personal injury and/or damage to the UltraBook workstation.



WARNING: To prevent fire, shock hazard, or damage to the equipment, do not expose the UltraBook workstation to rain or moisture. Do not immerse the UltraBook workstation in water. If water has entered the UltraBook workstation cabinet, do not use the workstation until it has been inspected by an BDI-



WARNING: Do not dispose of UltraBook batteries in fire. Disposal of UltraBook batteries in fire may cause personal injury.



WARNING: All service and upgrades to the UltraBook workstation must be performed by a trained technician only. Otherwise, you may encounter personal injury and/or damage your workstation.

Sicherheitshinweise



WARNUNG: Beim Betrieb der UltraBook Workstation treten hohe Spannungen innerhalb des Gehäuses auf. Bitte befolgen Sie auf jeden Fall die Bedienungs- und Installationsanweisungen um jegliches Risiko einer Verletzung oder eines Personenschadens zu vermeiden.



WARNUNG: Versuchen Sie auf keinen Fall, Ihre UltraBook Workstation mit Trockenbatterien (Primärzellen) zu betreiben oder solche mit dem Netz/Ladegerät zu laden. Versuche dieser Art können Personen- oder Sachschaden zur Folge haben.



WARNUNG: Betreiben Sie Ihre UltraBook Workstation nicht bei feuchten oder nassen Umgebungsbedingungen. Falls Wasser oder Feuchtigkeit in das Gehäuse eingedrungen ist, sollten Sie Ihr Gerät vor Wiederinbetriebnahme von einem qualifizierten Servicetechniker überprüfen lassen.

Important Safety Instructions

Important Safety Instructions

The following instructions pertain to the risk of fire, electric shock or bodily injury. Please read all of these instructions carefully.

1. Save these instructions for later use.
2. Follow all of the instructions and warnings marked on this workstation or included in this manual.
3. Do not use this workstation in unstable or unsupported conditions.
4. The workstation may fall, causing serious damage to the workstation and others around.
5. Slots and openings in the cabinet are for ventilation. To ensure reliable operation of the workstation, and to protect it from overheating, these openings must not be blocked or covered. Don't use this workstation on a bed, sofa, rug or other similar surface. This workstation should never be placed near an oven, a radiator, or heat register. This workstation should not be placed in a built-in installation unless proper ventilation is provided.
6. Never push objects of any kind into the workstation cabinet openings as they may touch dangerous voltage points or short out parts that could result in a fire or electrical shock. Keep liquids of any kind away from the workstation.
7. This workstation should only be connected to the AC power source indicated on your workstation system's information label. If you are not sure of the type of AC power available, consult your dealer or local power company. Only connect this workstation to a power outlet matching the power requirements of this workstation.
8. Do not allow anything to rest on the power cord. Do not locate this workstation where people will walk on the cord.

9. If you have to use an extension cord with this workstation, make sure that the total amperage rating of all equipment plugged into it does not exceed the amperage rating of the extension cord. Also, make sure that the total of all workstations plugged into the main AC power outlet does not exceed 15 amps.
10. Unplug your workstation from the main electrical power outlet before cleaning. Do not use liquid cleaners or aerosol cleaners. Use a damp cloth for cleaning.
11. Do not use this workstation near water.
12. This product is equipped with a 3-wire grounding-type plug, a plug having a third (grounding) pin. As a built-in safety feature, this plug will only fit into a grounding-type power outlet. If you are unable to insert or replace your obsolete outlet, contact your electrician to replace your obsolete outlet. Do not defeat the purpose of the grounding-type plug.

Battery Warning Instruction



WARNING: *Danger of explosion if battery is in correctly replaced. Replace only with the same or equipment type recommended by the manufacturer. Dispose of used batteries according to the manufacturer's instructions.*



ATTENTION: *Il y a danger d'explosion s'il y a remplacement incorrect de la batterie. Remplacer uniquement avec une batterie de meme type ou d'un type recommande par le constructeur. Mettre au rebut les batteries usagees conformement aux instructions du fabricant.*



VORSICHT: *Explosionsgefahr bei unsachgemäßem Austausch der Batterie. Ersatz nur durch denselben oder einen vom Hersteller empfohlenen ähnlichen Typ. Entsorgung gebrauchter Batterien nach Angaben des Herstellers.*

Earthed Socket Instruction



Caution: *Only connect this equipment to an earthed socket outlet. Apparaten ma kun tilkobles jordet stikkontakt. Apparaten skall anslutas till jordat nätuttag. Laite on liitettävä suojäkosketuspistoraassian.*



ATTENTION: *Debrancher avant d'ouvrir.*



ATENCION: *Desconecte fuerza electrica antes del servicio.*

Wichtige Sicherheitsvorschriften. Unbedingt beachten.

Die nachfolgenden Anweisungen betreffen die Gefahr von Verletzungen durch elektrische Spannung, Feuer und mechanische Einwirkung. Bitte lesen sie diese Anweisungen sorgfältig.

1. Beachten Sie alle Hinweise, die am Gerät selbst angebracht oder in den zugehörigen Handbüchern vermerkt sind.
2. Stellen Sie das Gerät an einem sicheren, stabilen Arbeitsplatz auf.
3. Am Gerät angebrachte Öffnungen (Schlitze und sonstige Öffnungen) dienen der Belüftung des Gerätes. Um ein zuverlässiges Arbeiten des Gerätes zu gewährleisten und um Überhitzung zu vermeiden, müssen diese Öffnungen unbedingt freigehalten werden. Betreiben Sie das Gerät nie auf Betten, Sofas oder anderen, weichen Unterlagen.

4. Stecken Sie keine Gegenstände (Schraubenzieher, Büroklammern, etc.) in die Öffnungen. Sie würden damit Kurzschlüsse herbeiführen, die zur Zerstörung des Gerätes führen, sich der Gefahr eines Stromschlages aussetzen oder das Gerät in Brand setzen.
5. Das Gerät darf nur an vorschriftsmässige Steckdosen mit der auf dem Gerät angegebenen Netzspannung angeschlossen werden. Wenn Sie nicht sicher sind, welche Netzspannung richtig ist, wenden Sie sich an den Lieferanten des Gerätes oder an das zuständige Elektrizitätswerk.. Bitte nur an genügend stark abgesicherte Steckdosen anschliessen, die der Leistungsaufnahme des Gerätes entsprechen.
6. Auf das Netzanschlusskabel dürfen keine Gegenstände gestellt werden.
7. Legen Sie das Netzkabel so, dass niemand darauftreten oder darüber stolpern kann.
8. Wenn Sie Verlängerungskabel benützen, müssen Sie sicher sein, dass die gesamte Leistungsaufnahme nicht grösser ist, als das Verlängerungskabel zulässt. Der gesamte Stromverbrauch aller angeschlossenen Geräte darf nicht mehr als 15A betragen.
9. Wenn Sie das Gerät reinigen, muss das Netzkabel aus der Steckdose gezogen werden.
10. Das Gerät dürfen Sie nicht in der Nähe von Wasserleitungen benutzen.

Wartung der Workstation

Wenn Ihre Workstation nicht ordnungsgemäss arbeitet, dürfen Sie nur die Einstellungen vornehmen, die im Handbuch genannt werden. Andere Einstellungen oder Veränderungen können den Rechner beschädigen oder zerstören. Umfangreiche und kostspielige Reparaturen würden notwendig werden, um das Gerät wieder betriebsfähig zu machen.

Ziehen Sie den Netzstecker aus der Steckdose und verständigen Sie den zuständigen Kundendienst bei folgenden Störungen:

1. Netzkabel ist defekt oder stark abgenutzt.
2. Flüssigkeit ist in das Gerät gelangt.
3. Das Gerät war Regen oder Leitungswasser ausgesetzt.
4. Das Gerät ist heruntergefallen oder das Gerhäuse ist beschädigt.
5. Das Gerät arbeitet nicht mehr richtig.

Achtung!

Wenn Sie das Gerät öffnen müssen (Abnahme der verschraubten Haube), ist unbedingt folgendes zu beachten:

1. Das Netzkabel muss aus der Steckdose gezogen werden und zwar bevor Sie das Gerät öffnen.
2. Die Haube muss wieder montiert und verschraubt werden. Erst dann darf das Netzkabel wieder eingesteckt werden.

Warranty Policy Terms and Conditions

RDI Computer Corporation (hereafter "RDI") warrants its products to perform in accordance with published specifications at the time of shipment. This warranty insures that all RDI products are free from defects in material and workmanship when used under the condition described below:

RDI's products, including the UltraBook, PowerScreen, PXU (Peripheral Expansion Unit) and MAX are designed for commercial use and not for use in "rugged" or harsh environments. Using the product in an environment considered by RDI as "non-commercial" and/or outside the environmental specifications, invalidates the product warranty. If in any doubt, contact RDI Customer Service at (800) 734-7030 or (619) 929-0992 for further clarification.

Warranty Period

Every RDI product is covered by a one year warranty starting from the original date of shipment from RDI. Extended warranties for additional years may be purchased as an option. (See Extended Warranty Program section)

Coverage and Limitations

If in RDI's opinion the product malfunctions at anytime during the stated warranty period, RDI will cover all defects in material and workmanship in the product. Coverage under this policy shall not include:

- Any product not distributed by RDI or an Authorized RDI dealer.
- Any product in which the serial number has been defaced, modified, or removed.
- Inspection and testing by RDI resulting in no defects found.
- Removal and maintenance of accessories, attachments, machines, or other devices (RDI and non-RDI) not covered by this agreement.
- Internal peripherals (i.e. hard disk) and options (i.e. memory) not supplied by RDI.
- Repair, maintenance and adjustment of RDI product required due to, but not limited to, neglect, misuse (including repair or maintenance by parties other than RDI or its authorized representatives), abuse, usage not in accordance with product specifications and instructions, accident, unauthorized alterations, repairs or modifications, damage caused by internal and/or external peripherals and options not supplied by RDI, improper environment (including lightning, static electricity, fire or extreme temperatures), or acts of God.
- Service necessitated to comply with requirements of regulations of any Governmental body or agency arising after the date of purchase.
- Any software component of any product.
- Data recovery due to hard disk drive failure or motherboard failure .Limitation of Implied Warranties

All implied warranties, including warranties of merchantability and fitness for a particular purpose, are limited in duration to the length of the specific product warranty. RDI, at its sole discretion, may replace the product in whole or in part with comparable equipment and may use re-manufactured and refurbished parts and modules in performing service. Replacement parts and modules shall become the end-user's property; the replaced parts shall become the property of RDI. RDI shall have no obligation to return replaced parts. In no event shall RDI be liable for any delay in rendering service under this warranty. RDI's maximum liability under this warranty shall be limited to the replacement portion of the product under dispute with comparable equipment.

Exclusion of Damages

RDI's liability for any defective product is limited to the repair or replacement of the product at its option. RDI shall have no liability or responsibility to the end-user or any other person or entity with respect to any liability for damage to other property, including software, caused by any defects in the product, damages based upon inconvenience, loss of use of the product, loss in time, loss of data, loss of business, commercial loss, or any other damages, whether incidental, consequential or otherwise. In no event shall RDI be liable for loss of profits or any indirect, special, or consequential damages arising out of any breach of this warranty policy. State laws vary the end-user's rights under this warranty policy.

Warranty Service

Products requiring repair must be shipped prepaid to a RDI repair facility~ A Return Material Authorization (RMA) number must be issued by RDI Customer Service prior to any warranty return shipment. The product to be serviced must be accompanied by your assigned RMA number, dated proof of purchase, your name, address, and description of the problem as well as all interconnecting cables, cords, and supplements originally supplied with the product. All non-RDI equipment, accessories, attachments, modifications, programs, data and storage media must be removed from the product before it is delivered for service. RDI shall not be responsible for items that are not removed.

If you have any questions, or require an RMA number, please contact RDI Customer Service at: Phone: (800) 734-7030 or (619) 929-0992, Fax: (619) 931-5981 or Email: support@rdi.com.

Extended Warranty Program

RDI Computer Corporation offers extended warranties for the UltraBook, PowerScreen, PXU and MAX products for subsequent years after the initial one year warranty has expired. End-users are offered the option to purchase an extended warranty at time of purchase of their system or anytime thereafter. When an RDI product is under its original warranty, the end-user may purchase an extended warranty to commence from the date the original warranty expires. When the RDI product is beyond the original warranty period, end-users wishing to begin an extended warranty program must send the RDI system to the RDI Customer Service Department for a Serviceability Inspection (SI). The end-user will be responsible for all shipping charges~ The inspection will be performed at no charge. Should a system not pass the SI, the customer will be contacted to authorize the repairs and will be invoiced at Time and Materials charges before commencing the extended warranty program.

Extended Warranty Period

RDI offers second and third year warranty options. The extended warranty covers repair and service charges for one or two 12-month periods from either the time of purchase of the extended warranty or the date the original warranty expires (where an end-user purchases the service contract at the time of system purchase or during the initial 12 month warranty period). The purchase of the second year warranty is required prior to the purchase of the third year extended warranty.

Placing Orders

Extended warranties may be purchased at the time the system order is placed, during the warranty period, or after the initial warranty expires. To place an order for an extended warranty, please fill out the Extended Warranty Order Form attached to this document and include your purchase order or check - made payable to RDI Computer Corporation. If you have any questions, please contact RDI Sales at (800) 734-5483 or Fax (619) 931-1063 or Customer Service at (800) 734-7030 or Fax to (619) 931-5981 or email: support@rdi.com.

Time and Materials Service

For end-users who do not choose the extended warranty option, RDI Customer Service provides time and materials repairs. The hourly labor rate is \$125 per hour and a minimum two hour charge is assessed for any time and materials repairs. Charges thereafter are assessed at half-hour intervals. Time and materials repairs occur on a best effort basis. Turn-around time for time and materials repairs is based on material availability.

Welcome to the UltraBook User's Guide. This manual contains valuable information about using your new UltraBook. The Preface describes:

- Conventions used in this guide.
- Supplemental documentation.

Conventions in this User's Guide

The following conventions are used in this User's Guide:

Procedures

Procedures are numbered.

Example:

1. Turn on your workstation.

Notes

Notes precede information that requires special attention.

Example:

Note:

For your convenience, you can use your UltraBook on-board LCD or attach an external monitor.

Warnings and Cautions

Information of a hazardous nature is shown as indented and preceded by warning/caution icon.

Example:



Warning: *Disconnect all AC power and remove the battery prior to performing any cleaning and maintenance. Personal injury and equipment damage could result if a power source is connected to the UltraBook during cleaning or maintenance.*

Warnings are in italics to highlight conditions of potential personal injury. Cautions point out possible equipment damage.

Keyboard Conventions

Keyboard keys are shown in upper-case type.

1. Type Search and press the Enter key to have the system search for bootable devices.

Screen Messages

Screen messages appear in

Courier

 type within a box.

Example:

After the UltraBook passes its self-test, the following initial message appears:

```
UltraBook
ROM Rev. x.xx, xx, Serial #xxxxxxx
xxMB memory installed, Keyboard Present
Ethernet address x:x:xx:x:x:xx, Host ID: xxxxxxxx
```

Variables

Variables appear as an italicized x. For example, the x's in the screen on the previous page are variables because the values shown for ROM Rev., serial number, Ethernet address, and host ID will vary from system to system.

Supplemental Documentation

This User's Guide is a quick information guide taken from the UltraBook System Reference Set. Additional information can be found in that reference set.

For more information about the Solaris operating system, refer to the Solaris installation guides found in the UltraBook System Reference Set and in the following on-line documents accompanying the operating system:

- “Open Windows 3.X User's Guide”
- “OpenWindows 3.X DeskSet Reference Guide”
- Common Desktop Environment (CDE) online help

Notes

1

Introducing UltraBook

Before using your UltraBook portable workstation, it is important to review the following topics covered in Chapter 1:

- Unpacking your components.
- A list of UltraBook features.

Introducing UltraBook Components

As you unpack your UltraBook, check the shipping carton and the components inside it for damage. Figure 1-1 shows the items you should find in your shipping carton.

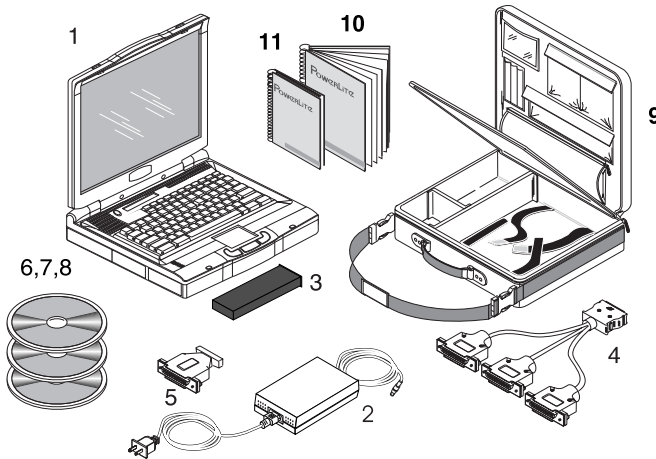

Figure 1-1 UltraBook Components

If either the shipping carton is damaged or the UltraBook components are missing or damaged, please contact your shipper or dealer immediately.

Each carton contains:

1. UltraBook portable workstation
2. AC adapter and power cord
3. Rechargeable battery pack
4. I/O break-out cable
5. J13W3-to-VGA adapter
6. Solaris 2.x or higher compact disc
7. VWA compact disc
8. Manual compact disc
9. Carrying case
10. UltraBook User's Guide (this manual)
11. Operating System Installation Guide
12. SCSI adapter (not shown)

Optional UltraBook Accessories:

- Optional external floppy drive (not shown)
- Optional CD-ROM drive (not shown)
- Optional fax/modem PCMCIA card (not shown)

Introducing UltraBook Features

Your new UltraBook includes the following features:

- A SPARC-compatible motherboard, running at 167 or 200 MHz (depending on your configuration) with a 16 KB data cache, 16 KB instruction cache, and 512 KB secondary cache

- 32 MB of high-speed RAM, upgradeable to 512 MB
- One of the following active matrix color LCD displays
 - 12.1 inch with 1024 x 768 resolution, supporting a 256K-color palette and 64-shades of gray
 - 14.1 inch with 1024 x 768 resolution, supporting a 256K-color palette and 64-shades of gray
- A full-size 98-key SUN Type-5 compatible keyboard with 12 function keys
- An integrated three-button GlidePoint touchpad
- A status LCD that displays system status icons
- Up to three removable hard disk drives (HDD's) of varying capacity

Note:

Depending on your configuration, you may have two removable HDDs and one removable battery.

- Audio input and output jacks that support:
 - Headphones, for private listening
 - Line Out, for connection to external stereophonic devices
 - Line In, for connection to external audio sources
 - Microphone, for connection to an external microphone
- Internal microphone and monophonic speaker

- PCMCIA Type III slot (also supports type I and type II cards)
- A connector for a low-profile external floppy disk drive
- A 68-pin Fast/Wide SCSI port
- A serial port for connecting external serial devices (such as a keyboard or mouse)
- A port for connecting an AC power adapter
- A docking port so that you can connect your UltraBook to an expansion dock
- A J13W3 port for attaching an optional external monitor
- A standard RJ45 port that supports both 10-Base T and 100-Base X twisted pair Ethernet connections
- A single 50-pin port and I/O break-out cable (supplied) that supports two serial and one parallel cable for connecting industry-standard serial and Centronics devices

For more information about the features listed here, see Chapter 2 of the UltraBook Hardware Reference Guide.

For tips on using the features listed here, see Chapter 3 of this guide.

2

Quick Start

Quick-start provides a brief, pictorial introduction to get you started. Refer to Chapter 3, UltraBook Operation, for more detailed information.

For more detailed hardware descriptions and theories of operation, see the UltraBook Hardware Reference Guide.

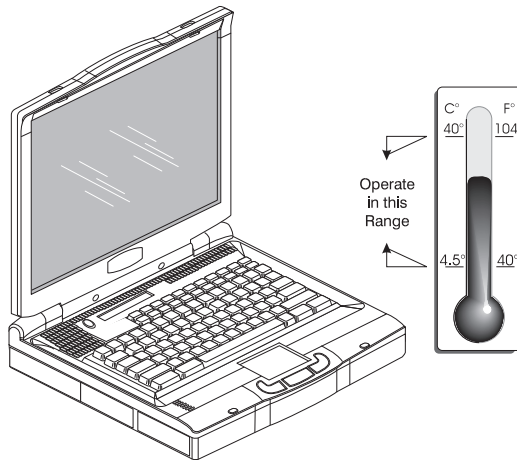

Step 1 Check the ambient air temperature.



Caution: If your workstation has been exposed to temperature extremes (variations of more than 10 degrees of temperature or 10 percentage points of humidity), you will need to stabilize the workstation's temperature. Let your UltraBook adjust to room temperature before proceeding. As shown in Step 1, the operating temperature range is 0 to 40° C.

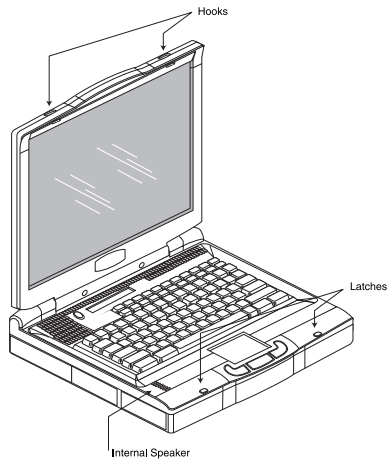

Step 2 Open the UltraBook

Open the UltraBook display screen by sliding the display cover latches as shown in Step 2.

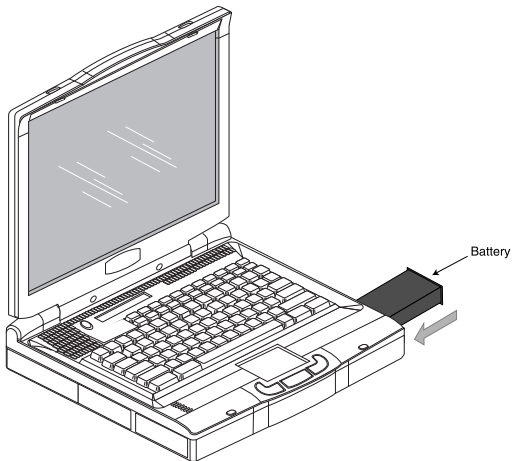

Step 3 Install the Lithium-Ion batteries.

If you have turned on the UltraBook, power down the UltraBook and turn it off. Insert the battery pack in the bay. Push in until you hear it click into place. The battery bay is located on the same side of the unit as the PCMCIA and SCSI ports.



Warning: Never use alkaline batteries with the UltraBook. Alkaline batteries cannot be recharged and may explode if you try to recharge them.



Warnung: Versuchen sie auf keinen Fall, Ihre UltraBook workstation mit Trockenbatterien (Primarzellen) zu betreiben oder solche mit dem Netz/Ladegerat zu laden. Versuche dieser Art können Personen-oder Sachschaden zur Folge Haben.

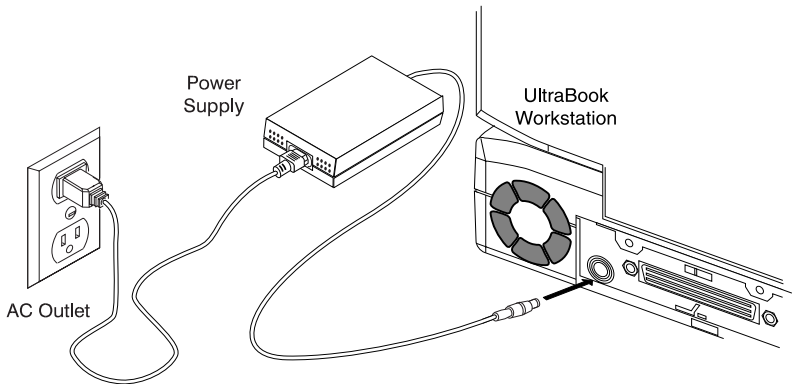

Step 4 Plug in the AC power adapter.

Step 4 shows connecting the AC adapter for AC power operation. The battery need not be installed for AC operation.

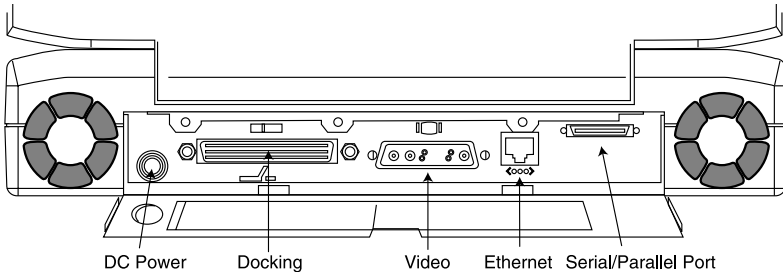

Step 5 Open the UltraBook back and side panels.

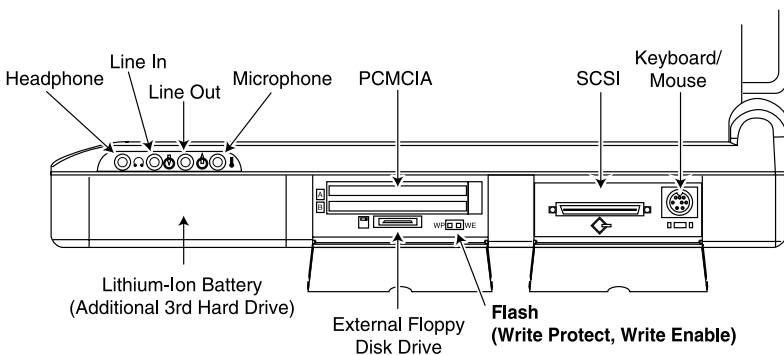

Step 5 continued.

Step 5 shows the back panel. Although the UltraBook is completely self-contained, the back panel provides access for connecting the workstation to a wide variety of external devices, including Ethernet networks. Lower the cover plate and connect the external device

to the appropriate connector. For serial or parallel connections, use the supplied I/O break-out cable. For Fast/Wide SCSI connections, use the SCSI port shown in Step 5. See Chapter 3 for more on connections.

Turn on all external devices, then turn on your UltraBook, as shown in Step 6.

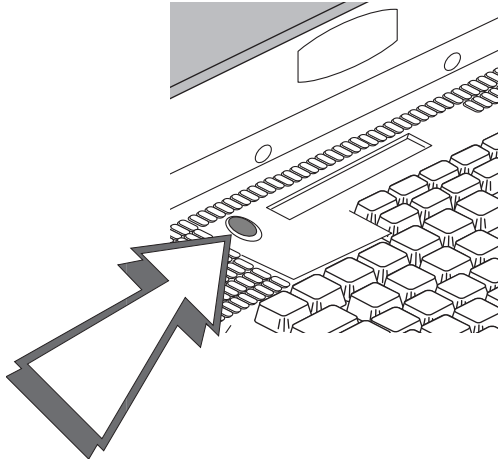

Step 6 Turn the power switch on.

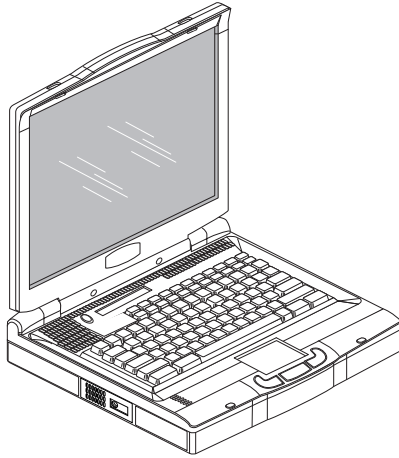

Step 7 View the initial system screens.

After the self-tests have been successfully completed, an initial message appears. Then system messages scroll as the operating system loads.

If the system is booted with the factory software load intact, the Common Desktop Environment (CDE) login banner appears. Login at this time and follow the prompts.

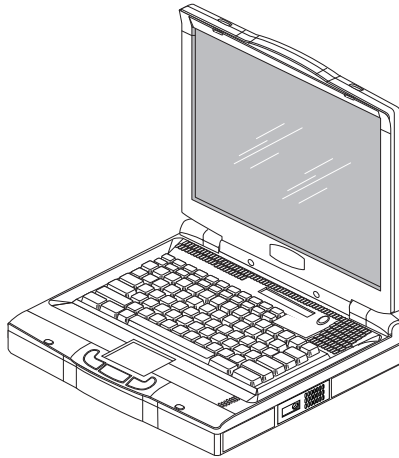

Step 8 Log on to the system

Note:

If the factory software load is altered, the CDE may not appear. If this is the case, after the last system message, the screen displays the login prompt and you can log into the system. At this point, you may start your application.

Notes

3

Using UltraBook

This chapter provides valuable information on using the UltraBook. A few minutes spent here will ensure you get the most out of UltraBook.

Setting Up

The UltraBook is designed to provide many years of error-free operation. The workstation will last longer by following these guidelines:

- Position the UltraBook so you can easily access the connectors on the back and side panels.
- The area should be free of obstructions, allowing you to open the display screen completely, without hindrance.
- Adequate ventilation is required for the UltraBook. Do not cover or block the ventilation slots or fans on the case.



Never spray or directly apply strong cleaners or solvents directly to the UltraBook case or LCD.

Opening the Display Cover

The display is located on the inside of the top cover. When you are not using the UltraBook, the cover should remain closed. This protects the display against damage.

To open the display cover:

1. Slide the two display cover hooks outward to the left and right sides of the unit (see Figure 3-1).
2. Gently raise the cover to its full, upright position.

You can adjust the screen up to 27 degrees from vertical for a better viewing angle. Use the backlight intensity keys on the integral keyboard to adjust the brightness of the backlight to achieve the best viewing conditions.

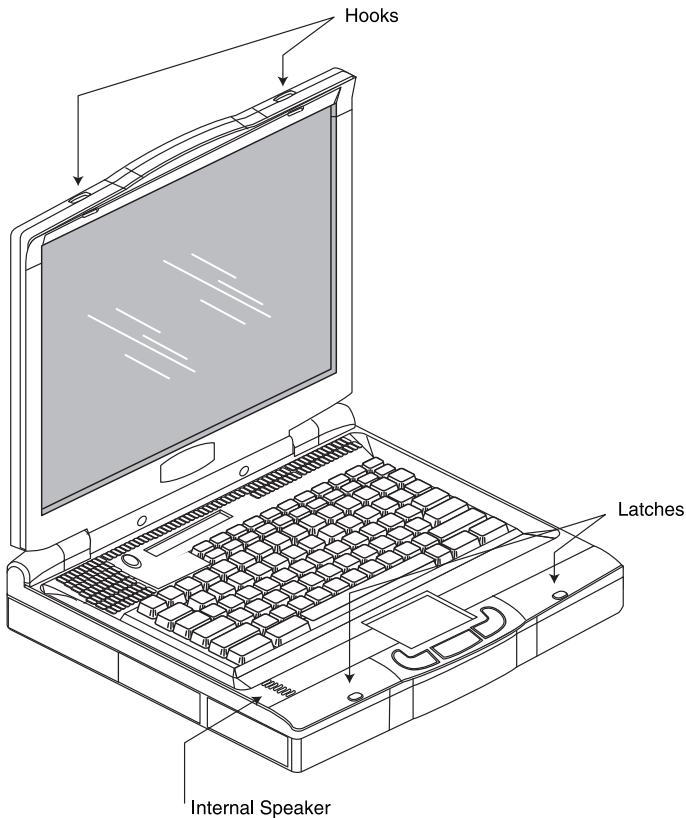

Figure 3-1 Raising the Display Cover

To close the display cover:

1. Gently pull the cover forward and down.
2. Carefully press the back of the cover down toward the keyboard until both case latches “click” into their closed positions.

At this point, you can connect the UltraBook to your selected optional equipment and power up the workstation.

Providing Power

The UltraBook can operate from a rechargeable Lithium-Ion battery pack or an AC power adapter.

See Using Batteries for installation instructions.

Using an AC adapter

You may use AC power to operate the UltraBook. The battery need not be installed for AC operation.

To power the UltraBook from AC power:

1. Locate the UltraBook near a grounded AC outlet.
2. Make sure the outlet is not controlled by a wall switch, which can cause the workstation to be turned off accidentally.
3. Be sure the power switch is in the OFF position before connecting the AC adapter. Never connect the AC adapter with the power switch in the ON position.



Warning: *Use only the supplied AC adapter with the UltraBook. Do not use an AC adapter designed for use with another product.*

4. Plug the polarized connector from the AC adapter into the power input socket on the UltraBook (see Figure 3-2). Then plug the AC cable plug into a nearby AC outlet.

A green LED lights on the front of the AC adapter when the adapter is in use.

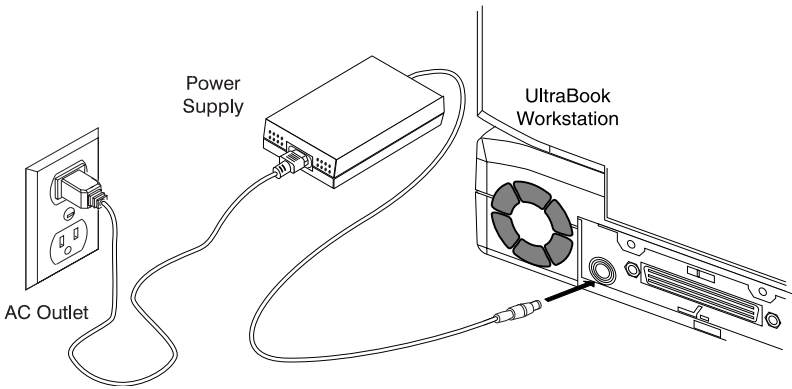

Figure 3-2 Connecting to AC Power

5. After installing a new battery pack, use the AC adapter to recharge the battery pack. It takes about three hours to recharge a new battery when the UltraBook is turned off. After fully charging the battery pack, you can operate the UltraBook for about one hour, depending on your configuration and application.

Note:

The AC adapter can be plugged into a 90 – 264-Volt source at 47 – 63 Hz. The AC adapter will automatically adjust to the AC input voltage and frequency. The only requirement is that the AC adapter/charger must correctly fit the AC outlet.

Using Batteries

Note:

UltraBook includes three device bays, which may be occupied by one of several devices. If the device bay on the right side of the unit (the same side as the PCMCIA and SCSI ports) is occupied by a hard disk drive, you will not be able to run UltraBook on battery power.

To install the battery pack:

1. If you have turned on the UltraBook, power down the UltraBook and turn it off.
2. Insert the battery pack in the bay. Push in until you hear it click into place. The battery bay is located in the same side of the unit as the PCMCIA and SCSI ports.

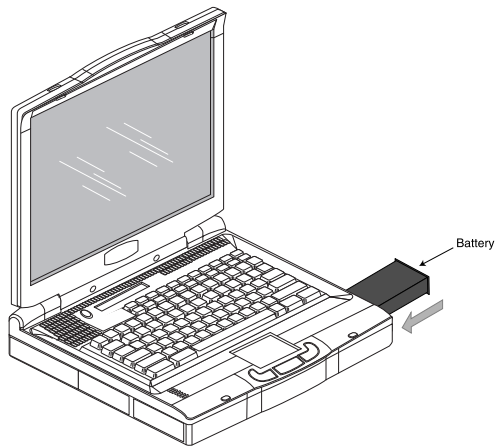

Figure 3-3 Installing the Battery Pack

To remove the battery pack:

1. Power down the UltraBook and turn it off.
2. Turn the UltraBook over.

3. Press the battery latch (see Figure 3-4) away from the battery.

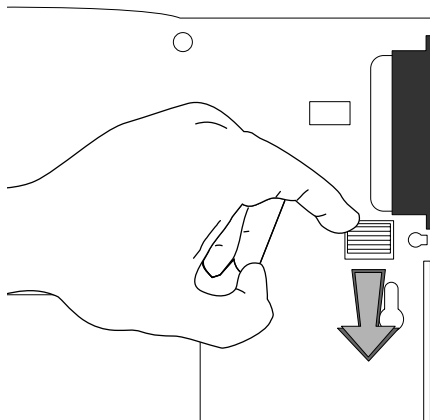

Figure 3-4 Removing the Battery Pack

4. Grasp the battery's faceplate and gently pull it out of the battery bay.

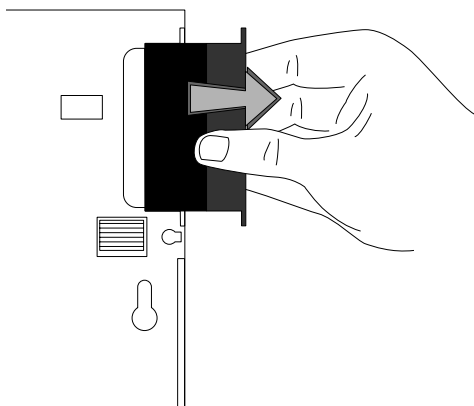

Figure 3-5 Removing the Battery Pack (cont'd)

Operating UltraBook

Before turning on your UltraBook workstation and beginning your day, you will need to prepare the workstation. This includes acclimating the workstation to its environment and starting its operating system.

Starting UltraBook

To ensure long life and ease of operation, you need to follow a few general guidelines when starting up and shutting down your UltraBook workstation.



Warning: *Failure to start up and shut down the UltraBook workstation properly can damage important system files and may affect your product warranty.*

To start the UltraBook:

1. Make sure the UltraBook is at room temperature before powering up. This is particularly important when the workstation is brought from a very cold environment into a warm room. In such cases, moisture can condense on and inside the workstation and cause problems. Allow at least two hours for the UltraBook's temperature to stabilize after bringing it from a very cold or very warm environment before proceeding.
2. If you will be using UltraBook on an Ethernet network, contact the person responsible for your computer network (the Network Administrator) to obtain the following applicable information:
 - A host name that does not duplicate an existing host name
 - A four digit Internet address
 - An optional Network Information Service (NIS) domain name
 - A user account and password if using NIS

- An Ethernet cable
3. Connect the Ethernet cable to the 10-Base T/100-Base X Ethernet connector.
 4. Make sure that all cables attached to peripherals (such as printers, mouse, monitor, or SCSI devices) are securely plugged into the correct connectors. Pay particular attention to the two serial ports: check that the device intended for attachment to port A is not accidentally plugged into port B.
 5. Make certain that each device is plugged into an AC outlet or power strip. External peripherals such as monitors and SCSI devices require their own power cords.
 6. If SCSI devices are connected to the UltraBook, install an active SCSI bus terminator on the last SCSI device only; otherwise you may experience erratic performance.

Note:

For more information on termination and configuration devices, refer to *Terminating Devices Attached to the SCSI Port* later in this chapter and your SCSI device documentation.



Caution: External devices can have a maximum SCSI bus length of 2 meters and must have active termination installed at the last device on the external bus.

7. Power up peripherals such as SCSI devices or a monitor before powering-up the UltraBook. Refer to the instructions that came with the peripherals for more information about starting order.
8. Use the UltraBook's power switch to turn on your workstation.

The UltraBook begins its self-test diagnostics and starts to boot. It is normal for the screen to be blank for up to 20 seconds before displaying the following initial message:

```
UltraBook
ROM Rev.x.xx, Serial #xxxxxxx
xx MB memory installed, Keyboard Present
Ethernet address x:x:xx:x:x:xx, Host ID: xxxxxxxx
```

A variety of system messages will be displayed on the screen as the Sun OS continues to boot. After the last system message, the screen will display the “hostname console login” prompt.

```
hostname console login:
```

If the UltraBook does not respond when the power switch is turned on, refer to Chapter 4 of this guide for troubleshooting suggestions.

Note:

After powering-up the UltraBook for the first time, you are ready to configure your workstation.

Shutting UltraBook Down

Before turning off your UltraBook for the day, you will need to shut down its operating system and power down any peripheral devices you have connected to the UltraBook.



Warning: *DO NOT simply turn off the power to your workstation as this can damage or destroy critical operating system files and data. Failing to properly shut down the operating system and workstation can also damage attached peripheral devices as well as the workstation itself.*

To shut down the operating system:

1. Save your work.
2. Log out from the system by typing

LOGOUT

and pressing Enter.

3. At the “hostname console login” prompt, log in as:

ROOT

4. Enter the root password at the “Password” prompt, and press Enter.
5. For UltraBook Systems running Solaris 2.X, type the following command:

`/usr/sbin/shutdown -y -i 0`

and press Enter.

Note:

For additional information on shutting down the system under Solaris 2.X, see the Solaris manual page for shutdown, init, and halt.

6. Power-down all peripherals, such as SCSI devices or a monitor first.
7. Turn off the UltraBook.

Note:

The hard disk automatically parks the heads and spins down.

Using Halt

In some cases, the system may not accept the “halt” command. If this occurs, type `/usr/sbin/halt` (for Solaris 2.X) and press Enter. The program responds by displaying the following series of messages:

```
Syncing file system... done
Halted
Program terminated
OK
```

Moving UltraBook

1. If you want to move the UltraBook after powering down, disconnect all cables and connectors (including the AC adapter cable) from the UltraBook.
2. Close and latch the rear panel cover, then fold the display cover down and close and latch the case.
3. You can now move the UltraBook to a new location, reconnect, and restart.

Note:

If you move the UltraBook to a different network, or move to standalone operation, you should run “Admintool” from OpenWindows before moving the workstation. Doing this lets you select the correct configuration for the new network and will enable the system to boot correctly after being moved.

Restarting UltraBook

Restarting a UltraBook that has been halted and powered down is a simple procedure.

To restart the UltraBook:

1. Verify that cables from all connected peripheral devices, such as SCSI devices or an external monitor, are connected to the appropriate connectors on the back of the UltraBook.

2. Power-up the peripherals before powering-up the UltraBook (see the peripheral manuals for more information).
3. Turn on the UltraBook.

The UltraBook begins its self-test diagnostics and starts to boot. It is normal for the screen to be blank for up to 20 seconds before displaying the following initial message:

```
UltraBook
ROM Rev.x.xx, Serial #xxxxxxx
xx MB memory installed, Keyboard Present
Ethernet address x:x:xx:x:x:xx, Host ID: xxxxxxxx
```

Various system messages will appear on the screen during the boot process. After the last system message, the screen will display the “hostname console login” prompt, where “host name” is the one you entered when you configured the UltraBook:

```
hostname console login:
```

4. Enter your user ID at the “hostname console login” prompt and press Enter.

The following prompt appears:

```
Password:
```

5. Enter your password at the “Password” prompt and press Enter.

Note:

Depending on your configuration and applications, the Lithium-Ion battery pack provides up to one hour of continuous-use operation from a full charge.

When the battery reaches the end of its charge, a “low battery” message appears on the Console and the UltraBook beeps. You must switch to AC power or power-down the workstation. For more on the low battery shutdown procedure, refer to Appendix A of this guide, Low Battery Shutdown.

Note:

When powering down the workstation, follow the shut-down procedures found in Shutting UltraBook Down. Otherwise, files on the system may become corrupt.



Caution: Do not allow the UltraBook batteries to fully discharge while operating the workstation from battery power. Corrupt files may result.

The battery pack can be recharged from AC power in about 2.5 hours. The system’s Lithium-Ion battery charges whether the system is on or off, provided the unit is connected to an external power source.

Using UltraBook Features

This section contains operational tips and other information unique to the UltraBook feature set. For more detailed information on a listed feature, refer to Chapter 2 of the Hardware Reference Guide.

Removing Hard Disk Drives

The UltraBook comes equipped with up to three removable hard disk drives.

To remove a hard disk drive:

1. Power down the UltraBook and turn it off.
2. Turn the UltraBook over.

3. Press the hard disk drive latch (see Figure 3-6) away from the drive.

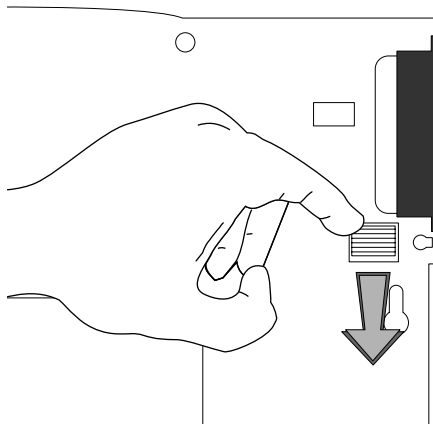

Figure 3-6 Removing the Hard Disk Drive

4. Grasp the drive's faceplate and gently pull it out of the drive bay.

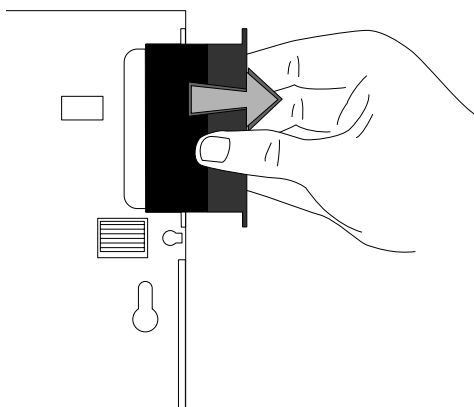
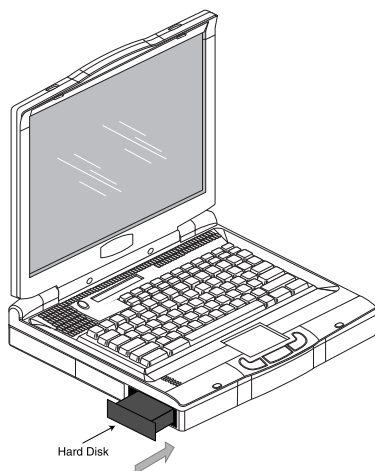

Figure 3-7 Removing the Hard Disk Drive (cont'd)

To insert a hard disk drive:

1. Insert the drive into the drive bay.

**Figure 3-8 Installing a Hard Disk Drive**

2. Press gently until you hear the drive click into place.

Recording with the External Microphone**To use this microphone to record:**

1. Make sure the recording source is sufficiently close to the microphone (1 to 2 ft).
2. Unplug any external audio input devices connected to the UltraBook.

Note:

If you connect an external audio input device, the UltraBook's internal microphone is disabled until you remove the external audio input device.

Ejecting PCMCIA Cards

The eject button work each slot independently. To eject a card, push the applicable PCMCIA eject button. The card will release and slide out.

Terminating Devices Attached to the SCSI Port

Due to termination requirements and bus loading, follow the configuration guidelines discussed in this section.

Daisy-chained SCSI devices-termination must occur after the last SCSI device. Check the SCSI device manual to see if the device is to be powered on before the restarting of the UltraBook.

External SCSI devices-use an active terminator with the appropriate connector.

SCSI Bus-External devices can have a maximum SCSI bus length of 2 meters and must have active termination installed at the last device on the external bus.

Using an External Keyboard or Pointing Device

- When the UltraBook is on and an external keyboard is connected, the system returns to OBP. Typing go and pressing Enter returns you to the Sun operating system.
- An external keyboard and the on-board keyboard can both be used for typing, along with a single pointing device (mouse, GlidePoint, or touchpad).
- The integrated GlidePoint/touchpad is disabled whenever an external pointing device is used.

Using an External Display

To connect an external monitor:

1. Start with the UltraBook properly shut down and powered off.

2. To connect a Sun-type external monitor, connect it directly to the UltraBook's external video port without using the J13W3-to-VGA adapter to the other end of the adapter. Refer to Appendix C, External Monitor Matrix, for more information.
3. For other monitors, attach a J13W3-to-VGA adapter to the UltraBook's external video port. Then connect the external monitor to the other end of the adapter. Refer to Appendix C: External Monitor Matrix, for more information.

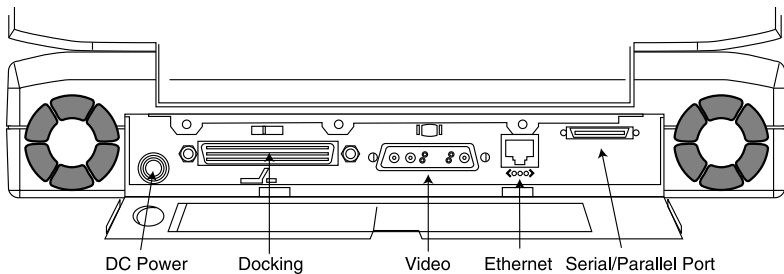

Figure 3-9 UltraBook Rear Access port

Connecting an Ethernet Cable

To connect the UltraBook to an Ethernet network:

1. With the UltraBook turned off, set it on a work surface near the Ethernet twisted-pair cable or transceiver/MAU.
2. Attach a twisted-pair cable to the UltraBook's 10-Base T/100-Base X Ethernet connector (see Figure 3-9).

Using the Serial/Parallel Port

The UltraBook back panel has a 50-pin connector housing two serial ports and a parallel port (see Figure 3-10).

To access serial and parallel ports:

1. Turn off the UltraBook and the serial devices you will be connecting to it.
2. Connect the male end of the I/O break-out cable to the UltraBook's 50-pin connector on the rear panel (see Figure 3-9).
3. The other end of the I/O break-out cable has two 25-pin connectors for attaching serial devices and a parallel connector for attaching parallel devices (see Figure 3-10). Make the appropriate serial and parallel connections.

For a list of pin assignments for the UltraBook connector and I/O break-out cable, refer to the UltraBook Hardware Reference Guide, Appendix B.

The two serial ports are designated A and B on the I/O break-out cable. When you connect serial devices to the I/O break-out cable, make sure the device intended for port A is plugged into the port A connector and the device for port B is plugged into the port B connector.

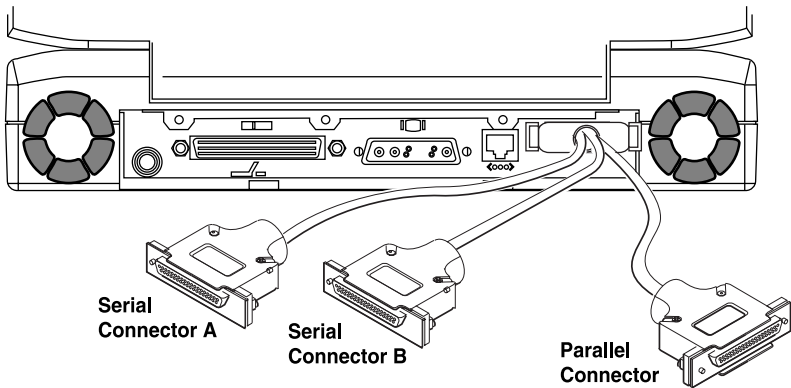

Figure 3-10 Serial and Parallel Connections

Upgrading Memory (RAM)

UltraBook can support up to 512 MB of random access memory (RAM). To upgrade RAM, add or replace RAM modules, available from RDI or authorized dealers in 16MB, 32MB, 64MB, 128MB, and 256MB sizes.



Warning: *Be sure to wear the grounding strap supplied in the memory upgrade packet when upgrading memory. If you do not, you may damage the UltraBook and risk voiding your warranty.*

To upgrade memory:

1. Power down the UltraBook and turn it off.
2. Turn the UltraBook over.

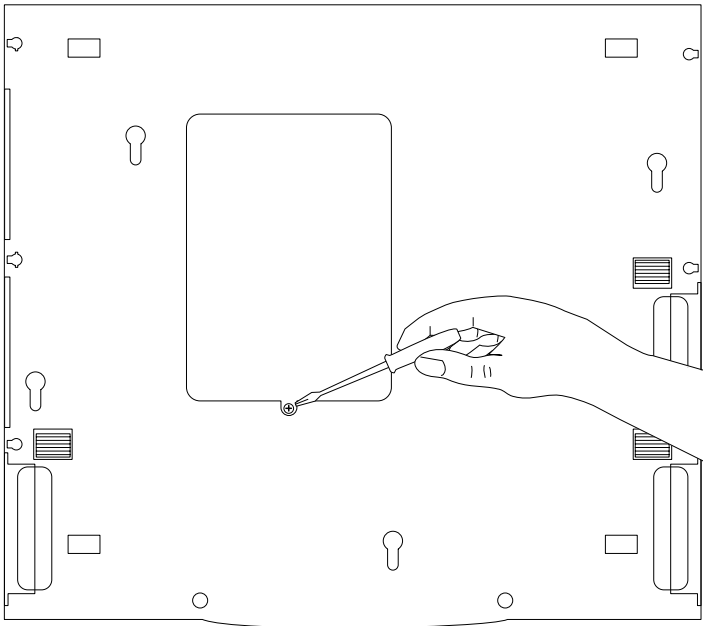

Figure 3-11 Removing the Memory Cover

3. Using a small Phillips screwdriver, remove the memory access cover as shown in Figure 3-11.
4. *If you are adding a new memory module*, insert it in the available slot (see Figure 3-12), pressing gently but firmly until it is fully seated.

If you are replacing existing modules, remove them first by tugging gently upward on the straps until they are fully disconnected from the slot. Then insert the new modules as described above.

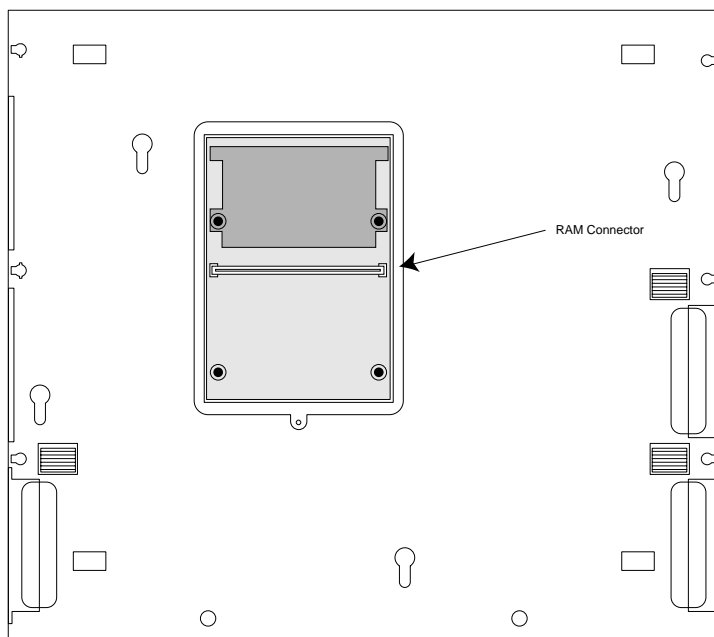

Figure 3-12 Installing the Memory Module

Note:

You must install memory modules in equivalent pairs. For example, to obtain a memory configuration of 32 MB, you must install two memory modules of 16 MB each.

5. Replace the memory cover screw.

Notes

4

Troubleshooting

In the unlikely event you should encounter a situation that requires corrective action, use the suggestions in this chapter to diagnose and correct the problem. To contact Customer Service and Support, refer to page 4-7.

To help you find the relevant information quickly, refer to the following Quick Fix Table

Table 4-1. Quick Fix Table

If You Have a Problem with ...	See
Starting and Booting	4-1
Battery Operation	4-4
SCSI port	4-5
Ethernet	4-5
Serial Ports	4-6
External video port	4-6
External keyboard/mouse port	4-7

Starting and Booting

1. The UltraBook will not power up from the AC adapter.
 - a. Be sure that the power-on icon  is displayed on the Status LCD.
 - b. Make certain that the AC adapter is securely plugged into the UltraBook's power input socket and the AC outlet.
 - c. Use a lamp to test if power is available at the outlet.
2. The UltraBook will not power-up from the battery.

- a. Be sure that the power-on icon  is displayed on the Status LCD.
 - b. Make certain that the battery pack is correctly installed in the battery compartment. Refer to Chapter 3 and the UltraBook Hardware Reference Guide for complete information.
3. The UltraBook will not access the Ethernet.
 - a. Make sure the server is properly operating and the Ethernet link is functioning.
 - b. If you use a transceiver or twisted-pair cable, make sure it is securely plugged into the UltraBook connector.
 - c. If this is a new network node, check the workstation's operating system to see if it is correctly configured for the network.
4. The UltraBook will not boot from the hard disk drive.
 - a. If the hard drive activity icon indicator does not display, indicating a hard disk problem exists, contact RDI Customer Service and Support at RDI's voice telephone number 1 800 734-7030 or Fax telephone number (760) 931-5981.
 - b. If the hard drive activity icon indicator displays but the UltraBook fails to boot, boot from the RDI CD ROM and restore the boot file. If this fails the boot files may be corrupted and you may have to reload the operating system.
 - c. If the hard drive activity icon indicator displays but the UltraBook fails to boot, boot off the CD ROM for further diagnostics.

5. The UltraBook halts during boot and displays the following messages:

```
boot device:/PCI Bus/1e0,00000 File andargs:
lost carrier (transceiver cable problem?)
ARP/RARP send failed.
Check Ethernet cable and transceiver.
Lost carrier (transceiver cable problem?)
ARP/RARP send failed.
Check Ethernet cable and transceiver.
```

- a. The UltraBook is trying to boot from an Ethernet server that is either not connected or unavailable. Hold down the Stop key and press A.
 - b. If the “>” prompt is displayed, type: b disk.
 - c. If “OK” prompt is displayed, type: boot disk.
 - d. If the last two have not worked, type: set-defaults to set the workstation to the default, then try steps B or C once more.
6. The UltraBook stops booting for several minutes and displays the following message:

```
Starting RPC and net services:
```

The system then displays one of the following error messages:

```
1e0: no carrier transceiver cable problem
```

-OR-

```
NIS: server not responding to domain "???" ; still trying
```

- a. The UltraBook is configured to use the NIS server that is not connected or is unavailable. Hold down the Stop key and press A.
- b. If the “>” prompt appears, type: b -s.

- c. If the “OK” prompt appears, type: boot -s. Several system messages appear, followed by the “#” prompt (the single user prompt).
 - d. At the “#” prompt, type exit and press Enter.
7. The UltraBook halts during boot and displays this message:

MEMORY NOT ALIGNED

- a. The lithium battery in the NVRAM chip has failed. Contact RDI Customer Service and Support at 1-800 734-7030. This part must be replaced by an RDI-trained service technician.

Battery Operation

1. Low battery warning occurs when the workstation is started or shortly after power-up.
 - a. Connect the AC adapter and recharge the batter for 2.5 hours, then try using the UltraBook again.
 - b. If recharging fails to correct the problem, test the AC adapter by removing the battery pack from the UltraBook and trying to operate from the adapter only.
 - c. If the AC adapter is working and the battery still fails to hold a charge, replace the battery pack.

Replacement battery packs can be obtained from an UltraBook representative.

Refer to Appendix B for more information.



Warning: *Never use alkaline batteries in the UltraBook. This can be very hazardous and severe damage may occur to the workstation.*



Warnung: UltraBook wird mit einem aufladbaren nickel cadmium akku ausgeliefert. Versuchen sie auf keinen fall, ihre UltraBook workstation mit trockenbatterien (primarzellen) zu betreiben oder solche mit dem können personen-oder sachsaden zur folge haben.

SCSI Port

1. External SCSI device fails to function.
 - a. Make certain active termination is installed on the last connected SCSI device. Otherwise, you may experience erratic performance.
 - b. Make sure the SCSI device is connected to an AC outlet and energized.
 - c. Make sure the SCSI cable is properly connected and functioning.

Ethernet

1. The UltraBook fails to access Ethernet.
 - a. The UltraBook must be connected to a functioning Ethernet network while powered-down. Once connected, the workstation can be powered-up.
 - b. If you access the twisted-pair connector, make sure the twisted-pair cable is securely connected to the UltraBook connector.
 - c. Type **config hme0** and press Enter to verify the Ethernet connection. Your display should show a list of active flags, one of which must be “up”. You should also see your Internet address.

- d. Type `ping-s <hostname>` and press **Enter** to verify your connection to the host. The display should show the following information continuously:
 - “64 bytes returned”
 - Your Internet address
 - One ICMP sequence number
 - The round-trip time it takes data to travel from the workstation to the host and back

If `<hostname>` is not in your host file, use an IP address.

To stop this information from scrolling, hold down the **Ctrl** key and press **C**.

Serial Ports

1. Serial device fails to function.
 - a. Check that the device is connected to the correct serial port. Verify the port assignment by connecting the device cable to the other serial port and retrying the serial port.
 - b. Port parameters may be configured incorrectly for the application or attached device. Refer to the manual that came with your application or device for more information.

External Video Port

1. External monitor display remains blank.
 - a. Check the monitor connection to the Ultra-Book. If you use an external monitor, be sure a **J13W3-to-VGA** adapter is used between the external monitor and the Ultra-Book external monitor connector.

- b. Check Appendix D for the correct combination of external monitor and OBP commands. UltraBook will support only select monitor resolution and refresh rates. Check the external monitor manual to make sure the monitor is compatible with the UltraBook output.
- c. Be sure to provide the correct PCI-Bus-probe-list parameters to enable or disable the external monitor. Refer to Appendix C.

External Keyboard/Mouse Port

1. The external keyboard or mouse fails to work.
 - a. Make sure that the external keyboard or mouse is securely plugged into the appropriate UltraBook connector.

Customer Service and Support

If the troubleshooting information in this chapter does not resolve the problem, you may contact RDI's Customer Service and Support staff.

RDI Customer Service:
7:00 AM to 6:00 PM PST
Phone 1-800 734-7030
Fax (760) 931-5981
Email: support@rdi.com

Before you call, have the UltraBook serial number nearby. This number appears on the bottom of the UltraBook.

If you received an error message, it will also help if you write down the following information:

1. Serial number of your system.
2. The exact description of the problem.
3. The task you were performing when you encountered the problem.

4. The command you typed when the error occurred. You may want to check the command line to make sure you did not make a mistake.
5. The directory you were in. You can use “pwd” to obtain this information.
6. The account you were using. You can use “whoami” to obtain this information.
7. Version of the operating system you are using. You can use “uname -a” to obtain this information.

A

Low Battery Shutdown

This appendix describes the UltraBook's low battery shutdown sequence.

Overview

The UltraBook battery is uniquely designed to provide the longest possible duration. As with any battery, however, prolonged use requires the battery to be recharged. Typically, battery power lasts up to one hour, depending on your configuration and applications.

To prolong battery use, use the dimming keys on the keyboard to reduce the intensity of, and the power consumed by, the LCD.

As battery power decreases, the UltraBook performs a sequence of events, described in table A-1. During this sequence, the UltraBook provides constant messages and an audible alarm informing you of the battery's current status. If you have the Common Desktop Environment or OpenWindows running, the PowerTool dialog appears, displaying current battery information. If you desire, you can use the PowerTool to turn off the alarm. For more information, refer to "Understanding the PowerTool GUI" in the Maintenance chapter of the Hardware Reference Guide.

Note:

The Duration column in Table A-1 reflects approximate times during typical operating activities and conditions.

Table A-1 UltraBook Low Battery Shutdown

Battery Status	Duration	System Actions	Actions You can Perform
Fully charged	Up to 1 hour	None	None required
Low battery condition	10 - 15	<p>Warning message displayed on the Console.</p> <p>Audible warning sounds.</p> <p>If OpenWindows is running, PowerTool window pops up, displaying battery capacity.</p>	<p>Attach AC adapter, or save and begin exiting processes.</p> <p>To complete jobs currently running, use dimmer switch to lower the LCD intensity and save battery power.</p> <p>Use the PowerTool to turn off the alarm, if desired.</p> <p>Use the PowerTool to turn off the alarm, if desired.</p>
Critical battery condition	2 minutes	Power management daemon starts system shutdown sequence, after which it enters PROM Monitor (OBP).	Solaris shutdown cannot be interrupted. Attaching AC adapter will still require you to boot the UltraBook after the shutdown.
Power Shutdown	1-2 minutes	System remains in OBP until battery power is exhausted, causing automatic power shutdown.	Connect the AC adapter and reboot the UltraBook.

B

NVRAM Settings

Table B-1 lists the UltraBook NVRAM settings. When you receive your UltraBook, the factory-preset values are configured to their default settings using the “set-defaults” command.

Table B-1 NVRAM Settings

Parameter	Values	Default Value
tpe-link-test?	true/false	true
output-device	screen/ttya	screen
input-device	keyboard/ttya	keyboard
pci-bus-probe-list	40123	40123
keyboard-click?	true/false	<no default>
keymap		<no default>
ttyb-rts-dtr-off	true/false	false
tya-ignore-cd	true/false	true
tya-rts-dtr-off	true/false	false
tya-ignore-cd	true/false	true
ttyb-mode	9600, 8 n 1	9600, 8 n 1
tya-mode	9600, 8 n 1	9600, 8 n 1
fcode-debug?	true/false	false
auto-boot?	true/false	true
watchdog-reboot?	true/false	false
diag-file		<no default>
diag-device	disk/net	net
boot-file		<no default>
local-mac-address?	true/false	false
monitor-type	1-7	7
screen-#rows	34	34
screen-#columns	80	80
selftest-#megs	1-80	1
scsi-initiator-id	7	7
use-nvramc?	true/false	false
nvramc		<no default>
sunom-compat?	true/false	false

Table B-1 NVRAM Settings

Parameter	Values	Default Value
security-mode	none/command/full	none
security-password		<no default>
security-#badlogins	n/a	0
oem-logo		<no default>
oem-logo?	true/false	false
oem-banner		<no default>
oem-banner?	true/false	false
hardware-revision		<no default>
last-hardware-update		<no default>
testarea		0
mfg-switch?	true/false	false
diag-switch?	true/false	false

C

External Monitor Matrix

The UltraBook is delivered with either a 1024 x 768 pixel resolution 12.1 inch or 14.1 inch Liquid Crystal Display (LCD). It also has the option to drive the external monitors. In some combinations, the UltraBook can drive both the LCD and an external monitor simultaneously. This list charts the various combinations and the OBP commands to activate them.

UltraBook LCD Resolution	External Monitor Resolution	OBP Command
LCD Only Operation		
1024x768 60Hz (256K Colors) 1024x768 60Hz (256K Colors)		lcd-only When no external monitor is connected
	Auto-Sensing with Sun Monitors	Automatically selected at boot, or use OBP commands to select resolution
Off	Type 2 1280x1024 76Hz	1280-fastmon
Off	1280x1024 60Hz	1280-mon
Off	Type 3 1152x900 66Hz	1152-mon
Off	Type 4 1152x900 66Hz	1152-mon
1024x768 60Hz	Type 5 1024x768 60Hz	lcd+monitor

UltraBook LCD Resolution	External Monitor Resolution	OBP Command
Simultaneous Operation		
	Non Auto-Sensing with VGA Monitor and J13W3 adapter	System defaults to 1024x768 LCD, use OBP command to select resolution
Off	1280x1024 76Hz	1280-fastmon
Off	1280x1024 60Hz	1280-mon
Off	1152x900 66Hz	1152-mon
1024x768 60 Hz 1024x768 60 Hz (simultaneous display)	1024x768 60Hz 1024x768 60Hz	lcd+monitor monitor-on

Note:

Simultaneous display is supported in 1024x768 mode for the Proxima Ovation 944 LCD projection panel, using the Proxima VGA cable.

Changing Resolutions

Changing the display resolution is best done during the boot sequence, either during start-up or rebooting specifically to change the resolution.

1. To enter the command string, press “Stop” and “A” together during the boot sequence, right after the memory test and before the hard disk begins accessing.

The workstation will then be in “Open Boot PROM” (OBP) mode.

Note:

You can now execute OBP commands. Enter the command for the desired resolution corresponding to the type of display you have.

2. After entering the command string, type **go** or **boot**, depending on any messages given at the command line.

3. Press **Enter** to resume using the Ultra-Book.

Notes

A

- AC adapter 1-4
 - no power 4-1
 - plugging in 2-3
 - recharging battery with 3-4
 - using 3-3
- adjusting backlight 3-2
- adjusting screen angle 3-2
- alkaline battery (DO NOT USE) 2-3
- ARP/RARP send failed 4-3
- audio 1-3
- auto-boot? B-1

B

- back panel, opening 2-4
- backlight intensity 3-2
- battery 3-5
 - alkaline (DO NOT USE) 2-3
 - installing 2-2, 3-5
 - life of A-2
 - low battery notice 3-13
 - low warning A-1
 - low warning on startup 4-4
 - no power 4-1
 - recharging 3-4
 - removing 3-5
 - troubleshooting 4-4
 - using 3-4
- blank external monitor 4-6
- boot 3-9, 4-1
 - hard disk drives and 4-2
 - memory not aligned 4-4
- boot-file B-1
- bus terminator 3-8

C

- cable
 - connecting 3-17
 - Ethernet 3-8
- cache 1-2
- cautions xiv
- CDE 2-7
- changing resolution C-2
- cleaners and solvents 3-1
- closing
 - display cover 3-3
- conventions xiii, xiv
- warnings xiv
- cover
 - closing 3-3
- critical battery A-2
- customer support 4-7

D

- daisy-chained SCSI devices,
 - terminating 3-16
- data cache 1-2
- diag-device B-1
- diag-file B-1
- diagnostics 3-9
- diag-switch? B-2
- display 1-3, 3-16
 - adjusting angle 3-2
 - changing resolution C-2
 - closing cover 3-3
 - external C-1
 - opening cover 3-1
 - troubleshooting 4-6
- docking port 1-4
- domain name 3-7
 - password 3-7
 - user name 3-7

E

ejecting PCMCIA cards . . . 3-16
Ethernet 3-7, 4-5
 cable 3-8
 connecting cable 3-17
 Internet address 3-7
 no access 4-2
 RJ45 port 1-4
 troubleshooting 4-5
 user name and password .
 3-7

external 3-16
 display 3-16
 mouse 3-16
external floppy disk drive . . 1-4
external monitor 4-6, C-1
 changing resolution . . C-2
 J13W3 port 1-4
 troubleshooting 4-6
external peripherals
 turning on 3-8
external SCSI devices, termi-
 nating 3-16

F

failure to boot 4-2
fast/wide SCSI
 SEE SCSI
fcode-debug B-1
floppy disk drive
 external 1-4
fully charged battery A-2

H

halt 3-11
hard disk drives 1-3, 3-15
 installing 3-15
 no boot 4-2
 removing 3-13
hardware-revision B-2
hostname 3-7

I

initial screens, viewing. . . . 2-6
input-device B-1
installing 3-15
 AC adapter 2-3
 battery 2-2, 3-5
 RAM 3-19
Internet address 3-7

J

J13W3 port 1-4
jacks 1-3

K

keyboard xiv, 1-3, 3-16
 external 3-16
 external keyboard and 3-16
 serial port for 1-4
 troubleshooting 4-7
keyboard-click? B-1
keymap B-1

L

last-hardware-update B-2
life of battery A-2
lithium-ion battery
 SEE battery
local-mac-address? B-1
logging in 2-7, 3-9
logging out 3-10
lost carrier 4-3
low battery A-2
low battery warning 3-13
 on startup 4-4
 shutdown A-1

M

memory 1-3
 not aligned 4-4
 upgrading 3-19
mfg-switch? B-2
microphone 1-3
 recording with 3-15
monitor-type B-1

motherboard 1-2

mouse
SEE touchpad

moving UltraBook 3-11

N

network
connecting Ethernet cable
3-17
no access 4-2
troubleshooting 4-5

NIS domain name 3-7

no carrier 4-3

notes xiii

NVRAM B-1
battery failure 4-4

nvrnmc B-1

O

oem-banner B-2

oem-banner? B-2

oem-logo B-2

oem-logo? B-2

opening
back panel 2-4
side panel 2-4
UltraBook 3-1

opening UltraBook 2-2

operating system, shutting
down 3-10

output-device B-1

P

parallel port 3-17

password 3-7

pci-bus-probe-list B-1

PCMCIA 1-4
ejecting cards 3-16

plugging in AC adapter 2-3

power adapter
SEE AC adapter

power shutdown A-2

power switch 2-5

R

RAM 1-3
upgrading 3-19

recharging battery 3-4

recording with external microphone 3-15

removing 3-5
hard disk drives 3-13
PCMCIA cards 3-16

resolution, changing C-2

restarting UltraBook 3-11

RJ45 port 1-4

S

screen messages xiv

screen-#columns B-1

screen-#rows B-1

SCSI 1-4
bus terminator 3-8
terminating devices 3-16
troubleshooting 4-5

SCSI bus, terminating 3-16

scsi-initiator-id B-1

secondary cache 1-2

security-#badlogins B-2

security-mode B-2

security-password B-2

self-test 3-9

selftest-#megs B-1

serial port 1-4, 3-17, 4-6
troubleshooting 4-6

server not responding 4-3

service 4-7

shutting UltraBook down 3-9
operating system shut-
down 3-10

side panel, opening 2-4

solvents and cleaners 3-1

speaker 1-3

starting 4-1

starting UltraBook 3-7, 3-8
again 3-11

- logging in 3-9
- low battery warning . . . 4-4
- no Ethernet 4-2
- no power 4-1
- SCSI bus terminators . 3-8
- temperature 3-7
- status LCD 1-3
- sunom-compat B-1
- support 4-7

T

- technical support 4-7
- temperature 2-1, 3-7
- terminating
 - SCSI devices 3-16
- testarea B-2
- touchpad 1-3
 - external mouse and . . 3-16
- tpe-link-test? B-1
- Troubleshooting
 - battery 4-4
 - troubleshooting 4-5, 4-6
 - external keyboard/
 - mouse 4-7
 - starting and booting . . 4-1
 - troubleshooting

- SCSI 4-5
- ttya-ignore-cd B-1
- ttya-mode B-1
- ttya-rts-dtr-off B-1
- ttyb-mode B-1
- ttyb-rts-dtr-off B-1
- turning on peripherals 3-8
- turning on UltraBook 2-5

U

- upgrading RAM 3-19
- use-nvramc? B-1
- user name 3-7

V

- variables xiv
 - conventions xiv
- ventilation 3-1
- viewing
 - initial screens 2-6

W

- warning
 - low battery 3-13
- warnings xiv
- watchdog-reboot? B-1