



IBM **@**server Certification Study Guide - pSeries AIX System Support

Developed specifically for the purpose
of preparing for AIX certification

Makes an excellent companion
to classroom education

For AIX professionals

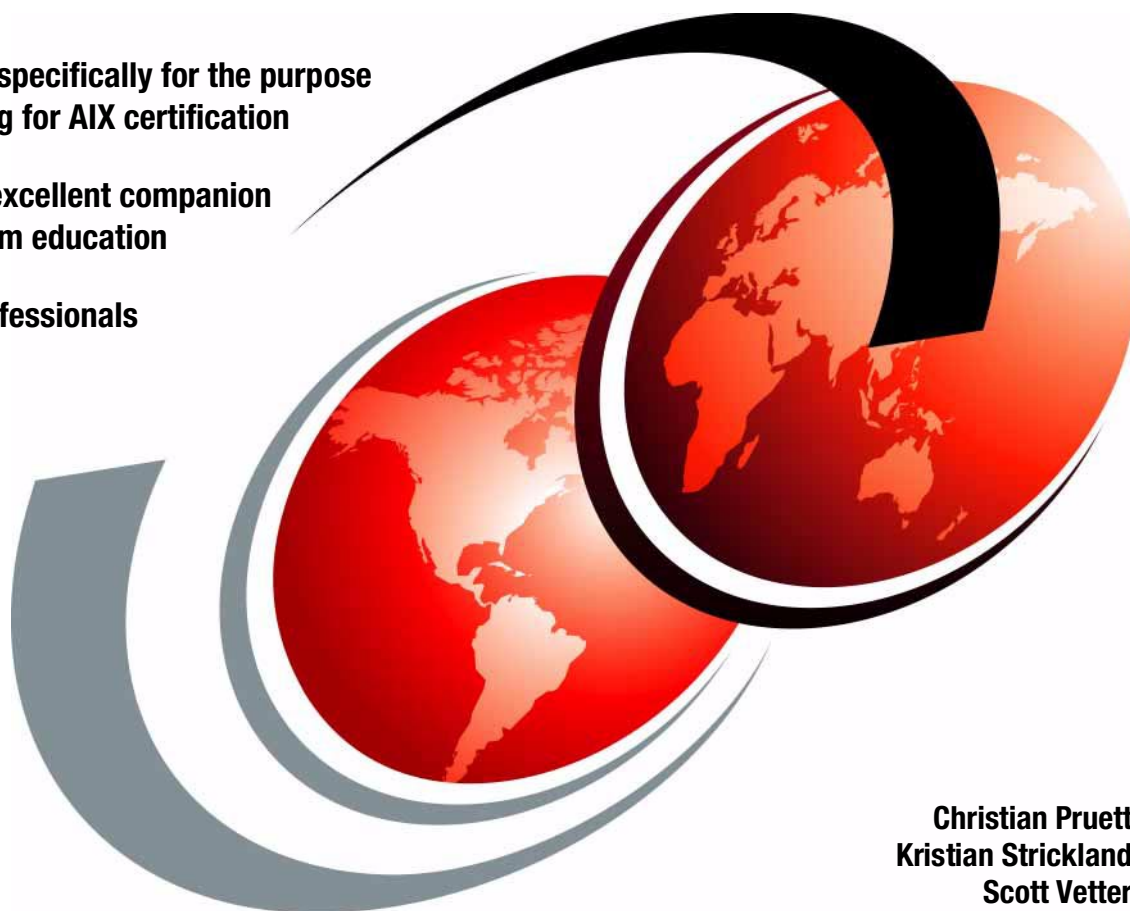

Christian Pruett
Kristian Strickland
Scott Vetter

ibm.com/redbooks

Redbooks



International Technical Support Organization

**IBM @server Certification Study Guide -
pSeries AIX System Support**

December 2001

Take Note! Before using this information and the product it supports, be sure to read the general information in “Special notices” on page 427.

First Edition (December 2001)

This edition applies to AIX 5L for POWER Version 5.1, program number 5765-E61 and subsequent releases running on an RS/6000 or pSeries server and is based on information available in October 2001.

Comments may be addressed to:
IBM Corporation, International Technical Support Organization
Dept. JN9B Building 003 Internal Zip 2834
11400 Burnet Road
Austin, Texas 78758-3493

When you send information to IBM, you grant IBM a non-exclusive right to use or distribute the information in any way it believes appropriate without incurring any obligation to you.

© Copyright International Business Machines Corporation 2001. All rights reserved.

Note to U.S Government Users – Documentation related to restricted rights – Use, duplication or disclosure is subject to restrictions set forth in GSA ADP Schedule Contract with IBM Corp.

Contents

Figures	xi
Tables	xv
Preface	xvii
The team that wrote this redbook	xix
Special notice	xix
IBM trademarks	xx
Comments welcome	xx
Chapter 1. Certification overview	1
1.1 pSeries AIX System Support (Test 199)	2
1.1.1 Recommended prerequisites	2
1.1.2 Registration for the certification exam	2
1.1.3 Certification exam objectives	2
1.1.4 Additional topics	5
1.2 Certification education courses	6
1.3 Education on CD-ROM: IBM AIX Essentials	10
Chapter 2. System installation and maintenance	11
2.1 System installation	12
2.1.1 New and complete overwrite installation	12
2.1.2 Migration installation	12
2.1.3 Preservation installation	13
2.1.4 Alternate disk installation	13
2.1.5 64-bit kernel installation	14
2.2 The lppchk command: verifying installed software	15
2.3 The installp command	17
2.3.1 The smit.log file	19
2.4 Determining maintenance levels	20
2.5 Modification update using update_all from SMIT	21
2.5.1 Downloading maintenance levels using FixDist	21
2.5.2 Invoking the smit update_all fast path	23
2.6 Finding a fileset that contains a given command	23
2.7 Quiz	24
2.7.1 Answers	26
2.8 Exercises	27
Chapter 3. System initialization and boot	29

3.1	System initialization	30
3.2	The /etc/inittab file	30
3.2.1	The telinit command	35
3.3	Initialization support	35
3.3.1	Using the bootlist command	35
3.3.2	Locating boot logical volumes	37
3.3.3	Accessing a system that will not boot	37
3.3.4	Common boot time LED codes	41
3.4	Quiz	44
3.4.1	Answers	46
3.5	Exercises	46
Chapter 4. Hardware installation and configuration management		47
4.1	Finding out about your system	48
4.1.1	Using the lscfg command	50
4.1.2	Using the lsdev command	50
4.1.3	Using the lsattr command	51
4.1.4	Examples	53
4.2	Adapter and device configuration	54
4.3	Displaying installed devices	54
4.4	Configuring new devices	56
4.4.1	PCI device configuration	57
4.4.2	ISA device configuration	58
4.4.3	128-port asynchronous adapter considerations	63
4.5	Adding a TTY device	66
4.6	Adding a tape drive	67
4.7	Quiz	69
4.7.1	Answers	70
4.8	Exercises	70
Chapter 5. Object Data Manager		71
5.1	ODM commands	73
5.2	Example of an object class for an ODM database	73
5.3	Quiz	74
5.3.1	Answers	75
5.4	Exercises	75
Chapter 6. Storage management, LVM, and file systems		77
6.1	Logical volume storage concepts	78
6.1.1	Limitations of logical volume storage	79
6.2	Managing physical volumes	79
6.2.1	Configuring a physical volume	79
6.2.2	Making an available disk a physical volume	81
6.2.3	Modifying physical volume characteristics	81

6.2.4	Removing physical volumes	82
6.2.5	Listing information about physical volumes	82
6.2.6	Migrating the contents of a physical volume	87
6.3	Managing volume groups	92
6.3.1	Adding a volume group	92
6.3.2	Modifying volume group characteristics	94
6.3.3	Importing and exporting a volume group	96
6.3.4	Varying on and varying off a volume group	98
6.3.5	Monitoring volume groups	100
6.3.6	Reorganizing a volume group	102
6.3.7	Synchronizing a volume group	103
6.3.8	Moving a logical volume within a volume group	104
6.3.9	Extending a volume group to a defined physical volume	116
6.4	Managing logical volumes	121
6.4.1	Adding a logical volume	122
6.4.2	Removing a logical volume	125
6.4.3	Reducing the size of a logical volume	131
6.4.4	Increasing the size of a logical volume	132
6.4.5	Copying a logical volume	132
6.4.6	Listing logical volumes	135
6.4.7	Logical volume size	136
6.4.8	Other logical volume characteristics	136
6.5	Managing journaled file systems	140
6.5.1	Characteristics of the journaled file system	141
6.5.2	Characteristics of the enhanced journaled file system	142
6.5.3	Creating a file system	143
6.5.4	Mounting a file system	147
6.5.5	Removing a file system	151
6.5.6	Increasing the size of a file system	153
6.5.7	Checking file system consistency	155
6.5.8	Initializing the JFS log device	157
6.5.9	How to add additional JFS logs	158
6.6	Troubleshooting file system problems	161
6.6.1	Recovering from super block errors	162
6.6.2	Cannot unmount file systems	162
6.6.3	When the df command hangs	163
6.6.4	Deleting an application file that is locked	165
6.6.5	Full file systems	165
6.7	Summary of LVM commands	165
6.7.1	PV commands	165
6.7.2	VG commands	166
6.7.3	LV commands	166
6.7.4	File system commands	167

6.8 Quiz	167
6.8.1 Answers	169
6.9 Exercises	170
Chapter 7. SMIT fast path commands	171
7.1 Summary of SMIT fast path commands	173
7.2 Quiz	178
7.2.1 Answers	178
7.3 Exercises	178
Chapter 8. Problem determination	181
8.1 Boot logging facility	182
8.2 Error logging facility	185
8.2.1 Software service aids package	186
8.2.2 Managing the error log	187
8.3 System dump facility	194
8.3.1 Managing a dump device	195
8.3.2 System initiated dump	197
8.3.3 User initiated dump	200
8.4 Quiz	206
8.4.1 Answers	209
8.5 Exercises	209
Chapter 9. System backup and restore	211
9.1 Saving information	212
9.2 The data layout of a mksysb tape	214
9.3 Verifying system backups	215
9.3.1 Using SMIT to verify a tape	216
9.3.2 Using restore to verify a tape	217
9.4 Saving user data	219
9.4.1 Backing up user data	219
9.4.2 Backing up user volume groups	221
9.4.3 Backing up raw logical volumes	222
9.5 Restoring information	222
9.5.1 Restoring rootvg	223
9.5.2 Restoring a non-rootvg volume group	224
9.5.3 Restoring a file system	224
9.5.4 Errors with restoring data	225
9.5.5 Block size determination	225
9.6 Quiz	226
9.6.1 Answers	229
9.7 Exercises	229
Chapter 10. System performance	231

10.1	Using the topas command	232
10.2	Using the vmstat command	234
10.2.1	Paging activity statistics	235
10.2.2	CPU statistics	235
10.2.3	Determining the I/O for persistent storage	236
10.3	Using the iostat command	237
10.3.1	CPU statistics	238
10.3.2	Disk statistics	239
10.4	Using the vmtune command	242
10.5	Controlling resource usage	244
10.5.1	Using the nice and renice commands	244
10.5.2	Workload Manager	244
10.6	Logical volume performance	245
10.6.1	Logical volume fragmentation	245
10.6.2	Tuning a system for sequential I/O	246
10.7	Paging space management	247
10.7.1	Low paging space	247
10.7.2	Paging space tips	248
10.7.3	Managing default paging space (hd6)	248
10.7.4	Dynamically deactivating paging space	252
10.8	Quiz	253
10.8.1	Answers	258
10.9	Exercises	259
Chapter 11. Networking		261
11.1	Adapters, interfaces, and configuration problems	262
11.1.1	Adding a network adapter	262
11.1.2	Removing a network adapter	263
11.1.3	Adapter and interface configuration problems	265
11.2	TCP/IP	272
11.2.1	TCP/IP initialization	272
11.2.2	Starting and stopping TCP/IP daemons	273
11.2.3	The inetd daemon	274
11.2.4	Errors with the inetd daemon and subservers	275
11.3	IP addressing, gateways, and subnetting	276
11.3.1	IP addresses	277
11.3.2	Gateways	280
11.3.3	Subnets	283
11.3.4	Problems with incorrect subnet masks	284
11.4	Network configuration files	287
11.4.1	/etc/resolv.conf	287
11.4.2	/etc/hosts	288
11.4.3	/etc/netsvc.conf	289

11.4.4	\$HOME/.netrc	289
11.4.5	\$HOME/.forward	290
11.4.6	/etc/hosts.equiv and \$HOME/.rhosts	290
11.5	Exporting X-Windows and graphical applications	290
11.5.1	Failing to start an X-Windows application	291
11.5.2	Setting up the DISPLAY environment variable	293
11.6	Advanced network configuration options	293
11.6.1	The ARP cache	293
11.6.2	Detecting network bottlenecks	295
11.6.3	The no command	297
11.6.4	Network tuning	299
11.7	Quiz	304
11.7.1	Answers	308
11.8	Exercises	308
Chapter 12.	Printers	311
12.1	The printer colon files	312
12.2	Remote printing	312
12.2.1	The /etc/hosts.lpd file	313
12.2.2	Controlling the lpd daemon	314
12.3	Virtual printers	315
12.3.1	Files used with virtual printers	315
12.3.2	Key commands	315
12.3.3	Creating a virtual printer	316
12.4	Troubleshooting remote printing problems	319
12.4.1	0781-374 error message	319
12.4.2	0781-202 error message	320
12.4.3	How to run a remote trace	321
12.5	Filters	327
12.5.1	AIX filters	327
12.6	Clearing and preventing queue hangs in AIX	330
12.6.1	Summary	332
12.7	Flushing a print job	333
12.8	Holding and releasing print jobs	333
12.9	Troubleshooting printing problems	334
12.9.1	qdaemon will not start	334
12.9.2	Cannot add printer queue	334
12.9.3	Full file systems	335
12.10	Setting default printers	335
12.10.1	Using smitty qdefault fast path	335
12.10.2	The LPDEST environment variable	336
12.11	Quiz	338
12.11.1	Answers	340

12.12 Exercises	340
Chapter 13. Asynchronous Point-to-Point Protocol.	341
13.1 Configuring an asynchronous PPP server	343
13.2 Setting up the PPP control link	343
13.3 Assigning the PPP IP addresses	345
13.4 Adding a PPP login user.	348
13.4.1 Adding the TTY port	349
13.4.2 Configure the dial-in modem	350
13.4.3 Start the PPP control daemon.	351
13.5 AIX PPP client	352
13.5.1 Configuring an AIX PPP client	352
13.5.2 Create the chat dialog	353
13.6 Quiz	354
13.6.1 Answers	355
13.7 Exercises	355
Chapter 14. The cron daemon and crontab	357
14.1 The at command	358
14.1.1 Location of the spool area directory for the at command	359
14.2 Location of crontab files	359
14.3 Verifying job runs	360
14.4 Crontab file record format.	362
14.5 Scheduling job runs	362
14.6 Allowing access to the crontab command.	364
14.7 Creating and updating the crontab file	365
14.8 Verifying job schedules	366
14.9 Checking the time of the crontab file.	366
14.10 Removing the crontab file	367
14.11 Using crontab to append to a user's cron file	367
14.12 Quiz	368
14.12.1 Answers	370
14.13 Exercises	370
Chapter 15. Editing and viewing files and strings	371
15.1 The vi file editor	372
15.1.1 Editor limitations with vi	372
15.1.2 Editing modes in vi	372
15.1.3 The vi command flags	373
15.1.4 Editor subcommands in vi	374
15.2 Editing a file using the vi editor.	381
15.2.1 Inserting text using the vi editor	381
15.2.2 Changing text using the vi editor.	384
15.3 Viewing files and string settings	387

15.3.1 Using the pg command to view files	390
15.3.2 Using the view command to view files	394
15.3.3 Using the echo command	395
15.3.4 Using the file command to determine a file type	397
15.3.5 Using the strings command in object or binary files	398
15.4 Quiz	401
15.4.1 Answers	402
15.5 Exercises	402
Chapter 16. The shell and shell scripts	403
16.1 The Korn shell or POSIX shell	404
16.2 Bourne shell	404
16.3 C shell	404
16.4 Restricted shell	405
16.5 Setting the shell environment	405
16.5.1 The /etc/profile file	406
16.5.2 The /etc/environment file	407
16.5.3 The .profile file	409
16.5.4 The .env file	410
16.5.5 Changing your environment from the command line	410
16.6 Creating and running a shell script	412
16.6.1 General script remarks	412
16.6.2 Creating a script	413
16.6.3 Testing shell scripts	419
16.7 Quiz	421
16.7.1 Answers	422
16.8 Exercises	422
Related publications	423
IBM Redbooks	423
Other resources	423
Referenced Web sites	424
How to get IBM Redbooks	424
IBM Redbooks collections	425
Special notices	427
Abbreviations and acronyms	431
Index	439

Figures

2-1	Sample lppchk -v command output	17
2-2	Sample smit.log output for failed installation	19
2-3	Sample oslevel command output.	20
2-4	Select base maintenance levels in FixDist.	21
2-5	Select AIX 431 maintenance level in FixDist	22
2-6	Estimated size of files to be downloaded.	22
2-7	Using SMIT update_all to upgrade modification level	23
3-1	Example /etc/inittab file	34
3-2	BOS installation and maintenance screen.	38
3-3	Maintenance screen.	39
3-4	Warning screen	39
3-5	Access a Root Volume Group screen	40
3-6	Volume Group Information screen	40
3-7	Exhibit for question 1	45
4-1	Finding out the hardware platform type	49
4-2	List Devices SMIT screen	55
4-3	smitty lsdev output	56
4-4	Checking ISA device support.	58
4-5	Finding out currently defined devices	59
4-6	Finding out current resource settings using lsresource	60
4-7	Finding out current resource settings using lsattr	60
4-8	smitty isa command	61
4-9	Add an ISA Adapter screen	61
4-10	Add a Multiport Model 2 Adapter screen	62
4-11	ISA adapter resource conflict.	63
4-12	128-port asynchronous adapter connection combinations	64
4-13	RAN numbering	65
4-14	Add a TTY screen	66
4-15	Selecting the new tape drive type	68
4-16	Setting characteristics of a new tape drive device	68
6-1	Relationship between logical storage components	78
6-2	Status and characteristics of hdisk1 by physical partitions	86
6-3	Physical partition allocation by disk region	87
6-4	migratepv does not work across volume groups	88
6-5	smitty migratepv command	91
6-6	smitty mkvg command	93
6-7	smitty varyonvg command	99
6-8	smitty varyoffvg command	100

6-9	lsvg rootvg command	101
6-10	lsvg -l rootvg command	101
6-11	lsvg -p vname command	102
6-12	Logical Volume Manager menu	106
6-13	Logical Volumes menu.	107
6-14	Remove a Logical Volume menu	108
6-15	Remove a Logical Volume - confirmation screen	108
6-16	Remove a Logical Volume - Command Status screen	109
6-17	Logical Volume Manager menu	109
6-18	Volume Groups menu	110
6-19	Remove a Volume Group menu	110
6-20	Remove a Volume Group - confirmation screen	111
6-21	Remove a Volume Group - Command Status screen	112
6-22	Volume Groups menu	113
6-23	Set Characteristics of a Volume Group menu	113
6-24	Add a Physical Volume to a Volume Group menu	114
6-25	Add a Physical Volume to a Volume Group - confirmation screen	114
6-26	Add a Physical Volume to a Volume Group - Command Status	115
6-27	Volume Groups menu	117
6-28	Set Characteristics of a Volume Group menu	118
6-29	Add a Physical Volume to a Volume Group menu	118
6-30	Add a Physical Volume to a Volume Group - confirmation screen	119
6-31	Add a Physical Volume to a Volume Group - Command Status	120
6-32	Add a Physical Volume to a Volume Group - Command Status	121
6-33	Mapping of LP to PP for mirrored and non-mirrored data	122
6-34	Selecting the volume group to hold the new logical volume	124
6-35	Setting characteristics of the new logical volume	125
6-36	Journalled File Systems menu	128
6-37	File System Name submenu	128
6-38	Original characteristics of a journaled file system	129
6-39	New characteristics of a journaled file system	129
6-40	smitty jfs Command Status screen	130
6-41	smitty cplv command	133
6-42	Selecting source and destination logical volumes	134
6-43	Logical volume listing.	135
6-44	Logical volume attributes.	136
6-45	Physical partition mapping.	137
6-46	smitty crjfs command	144
6-47	Selecting the volume group to hold the new file system	144
6-48	Setting characteristics of the new file system	145
6-49	smitty crjfs results	146
6-50	File tree view before mounting.	147
6-51	File tree view after mounting	147

6-52	smitty mount command	149
6-53	Mount a File System screen	149
6-54	Selecting the mount point	150
6-55	smitty rmjfs command	152
6-56	Selecting the file system to remove	153
6-57	smitty chjfs command	154
6-58	Setting new characteristics of a file system	155
6-59	Add a Logical Volume screen	159
6-60	Add a Logical Volume characteristics screen	160
6-61	Add a Logical Volume - Command Status screen	160
7-1	System Management menu	172
8-1	Error logging subsystem overview	186
8-2	Sample errpt command output	188
8-3	Clean the error log menu	189
8-4	Successful system dumps - LED codes	195
8-5	System Dump menu	197
8-6	Unexpected system halt - Three-digit display string	198
8-7	Method of user initiated system dump	201
9-1	Flowchart for saving information	213
9-2	Layout of a mkysyb tape	214
9-3	List Files in a System Image menu	216
9-4	Flowchart for restoring information	223
10-1	topas command output	232
10-2	vmstat output example with disk activity	234
10-3	Enabling the disk I/O history	240
10-4	smitty swapoff command	252
11-1	Token Ring Adapter submenu	266
11-2	Change/Show Characteristics of a Token Ring Adapter menu	267
11-3	RING speed submenu	267
11-4	Ethernet Adapter submenu	268
11-5	Change/Show Characteristics of an Ethernet Adapter menu	269
11-6	Media Speed submenu	269
11-7	Minimum Configuration & Startup menu for CABLE type	270
11-8	Your CABLE Type submenu	271
11-9	Change/Show Characteristics of the PTY menu	276
11-10	Network monitoring by topas	297
12-1	Remote print request	313
12-2	smitty mkpq command screen	317
12-3	Add a Standard Remote Print Queue screen	318
12-4	lsvirprt command output screen	318
12-5	smitty chvirprt command screen	319
12-6	0781-202 error message	320
12-7	Content of /etc/hosts.lpd	320

12-8	Set System's Default Print Queue screen	335
13-1	Link Configuration screen	345
13-2	PPP IP Configuration	346
14-1	Sample /var/spool/cron/crontabs directory content	359
14-2	A sample /var/spool/cron/crontabs/root file	360
14-3	Sample output of the atq command	361
14-4	Creating the cron.allow file.	364
14-5	crontab -e command using the vi editor.	365
14-6	crontab entry created by the user deploy.	365
14-7	Using the crontab -l command	366
14-8	The crontab -v command.	366
14-9	A saved copy of the crontab file.	367
14-10	Creating the crontab file using an existing file	367
15-1	Image of yourfile opened by vi editor	382
15-2	The pg -s command with highlighted prompt	394

Tables

2-1	Command flags for lppchk	16
2-2	Command flags for installp	17
3-1	bootlist command flags	36
3-2	Common startup LEDs and solutions	41
4-1	lscfg command flags	50
4-2	lsdev command flags	51
4-3	lsattr command flags	51
4-4	RAN activity codes	65
5-1	ODM concepts	72
6-1	Limitations for logical volume storage management	79
6-2	reorgvg command flags	103
6-3	Key flags for the syncvg command	104
6-4	mkiv command flags	123
6-5	rmlv command flags	126
6-6	Allowable nbpi values	141
6-7	Journalled file system differences	142
6-8	fsck command flags	156
8-1	Command flags for alog	182
8-2	Common flags for errpt	190
8-3	Crash codes	198
8-4	System dump codes	199
8-5	Common flags for pax	203
8-6	Common flags for snap	205
9-1	Common tctl subcommands	217
9-2	Command flags for restore	218
9-3	Command flags for backup	220
9-4	Command flags for savevg	221
10-1	topas command flags	232
10-2	topas command screen subcommands	233
10-3	vmtune command flags and flag descriptions	242
11-1	Command parameters for ifconfig	264
11-2	IPv4 address classes	277
11-3	Command flags for netstat	277
11-4	Subnetting reference chart for class B addresses	283
11-5	Command flags for arp	294
11-6	Command flags for spray	295
11-7	Command flags for no	297
12-1	Flags for the iptrace command	321

12-2	Control file format	326
12-3	AIX filters	327
14-1	Default cron record in the /etc/inittab file	357
14-2	Sample crontab entries for scheduling a running of a program	363
15-1	The vi editor flags	373
15-2	The cat command flags and flag descriptions	388
15-3	The pg command flags and flag descriptions	391
15-4	Subcommands for pg	391
15-5	Table of flags for the view command	394
15-6	Escape conventions used with the echo command	395
15-7	The file command flags and flag descriptions	397
15-8	The strings command flags and flag descriptions	398

Preface

The AIX and IBM @server pSeries Certifications offered through the Professional Certification Program from IBM are designed to validate the skills required of technical professionals who work in the powerful and often complex environments of AIX and IBM @server pSeries. A complete set of professional certifications are available. They include:

- ▶ IBM Certified AIX User
- ▶ IBM Certified Specialist - AIX System Administration
- ▶ IBM Certified Specialist - AIX System Support
- ▶ IBM Certified Specialist - Business Intelligence for RS/6000
- ▶ IBM Certified Specialist - Domino for RS/6000
- ▶ IBM @server Certified Specialist - pSeries AIX System Administration
- ▶ IBM @server Certified Specialist - pSeries AIX System Support
- ▶ IBM @server Certified Specialist - pSeries Solution Sales
- ▶ IBM Certified Specialist - RS/6000 Solution Sales
- ▶ IBM Certified Specialist - RS/6000 SP and PSSP V3
- ▶ RS/6000 SP - Sales Qualification
- ▶ IBM Certified Specialist - Web Server for RS/6000
- ▶ IBM @server Certified Specialist - pSeries HACMP for AIX
- ▶ IBM Certified Advanced Technical Expert - RS/6000 AIX

Each certification is developed by following a thorough and rigorous process to ensure the exam is applicable to the job role, and is a meaningful and appropriate assessment of skill. Subject Matter Experts who successfully perform the job, participate throughout the entire development process. These job incumbents bring a wealth of experience into the development process, thus making the exams much more meaningful than the typical test, which only captures classroom knowledge. These experienced Subject Matter Experts ensure the exams are relevant to the real world and that the test content is both useful and valid. The result is a certification of value, which appropriately measures the skill required to perform the job role.

This redbook is designed as a study guide for professionals wishing to prepare for the certification exam to achieve: IBM @server Certified Specialist - pSeries AIX System Support.

The system support certification validates a broad scope of AIX problem determination and resolution skills and the ability to perform general AIX software system maintenance. The certification is applicable to AIX support professionals who conduct the AIX problem determination and resolution activities needed to successfully support system administrators, customers, and/or clients in an AIX environment, in order to maintain system reliability.

This redbook helps AIX support professionals seeking a comprehensive and task-oriented guide for developing the knowledge and skills required for the certification. It is designed to provide a combination of theory and practical experience needed for a general understanding of the subject matter. It also provides sample questions that will help in the evaluation of personal progress and provide familiarity with the types of questions that will be encountered in the exam.

This redbook will not replace the practical experience you should have, but is an effective tool that, when combined with education activities and experience, should prove to be a very useful preparation guide for the exam. Due to the practical nature of the certification content, this publication can also be used as a desk side reference. So, whether you are planning to take the pSeries AIX System Support certification exam, or if you just want to validate your AIX system support skills, this redbook is for you.

For additional information about certification and instructions on How to Register for an exam, visit our Web site at:

<http://www.ibm.com/certify>

The team that wrote this redbook

This redbook was produced by a team of specialists from around the world working at the International Technical Support Organization, Austin Center.

Christian Pruett is an RS/6000 and IBM @server pSeries IT Specialist at IBM Global Services in Boulder, Colorado. He has been working for IBM since July 1999. He has a Bachelor's degree in History from Colorado State University. He is an IBM @server Certified Specialist in pSeries AIX System Administration and pSeries AIX System Support. His areas of expertise include RS/6000 and IBM @server pSeries systems, RS/6000 and IBM @server pSeries hardware, and AIX installation and system recovery. Currently, he is an account lead for the AIX Standalone Support team at the IGS NA West GeoPlex Center.

Kristian Strickland is a System Support Specialist in Moncton, New Brunswick, for Co-op Atlantic, a dynamic Atlantic Canadian co-operative wholesaler. He has been involved professionally in system administration and support since 1995. He holds a Bachelor of Science degree in Math and Computer Science from St. Francis Xavier University, and is an IBM @server Certified Specialist in pSeries AIX System Administration and pSeries AIX System Support. His areas of expertise include AIX and Compaq's OpenVMS operating systems.

Thanks to the following people for their contributions to this project:

International Technical Support Organization, Austin Center

Wade Wallace

IBM Texas and Atlanta

Darin Hartman and Shannan L. DeBrule

IBM Germany

Volker Haug

Special notice

This publication is intended to help IBM business partners, technical professionals, and customers of IBM prepare for the pSeries AIX System Support exam as part of the IBM @server Certified Specialist program. The information in this publication is not intended as the specification of any programming interfaces that are provided by AIX 5L Version 5.1. See the PUBLICATIONS section of the IBM Programming Announcement for AIX 5L Version 5.1 for more information about what publications are considered to be product documentation.

IBM trademarks

The following terms are trademarks of the International Business Machines Corporation in the United States and/or other countries:

AFP™	AIX®
AIX 5L™	AIXwindows®
DFS™	Domino™
e (logo)® 	HACMP/6000™
IBM.COM™	IBM ®
Language Environment®	Micro Channel®
Perform™	PowerPC®
PowerPC Reference Platform®	pSeries™
PTX®	Redbooks™
Redbooks Logo 	RISC System/6000®
RS/6000®	Sequent®
SP™	Versatile Storage Server™

Comments welcome

Your comments are important to us!

We want our IBM Redbooks to be as helpful as possible. Send us your comments about this or other Redbooks in one of the following ways:

- ▶ Use the online **Contact us** review redbook form found at:
ibm.com/redbooks
- ▶ Send your comments in an Internet note to:
redbook@us.ibm.com
- ▶ Mail your comments to the address on page ii.



Certification overview

This chapter provides an overview of the skill requirements for obtaining an IBM @server Certified Specialist - pSeries AIX System Support certification. The following chapters are designed to provide a comprehensive review of specific topics that are essential for obtaining the certification.

1.1 pSeries AIX System Support (Test 199)

This certification validates a broad scope of AIX problem determination and resolution skills, and the ability to perform general AIX software system maintenance. The certification is applicable to support professionals who conduct AIX problem determination and resolution activities needed to successfully support system administrators, customers, and clients in an AIX environment, in order to maintain system reliability.

To attain the IBM @server Certified Specialist - pSeries AIX System Support certification, candidates must pass one exam: Test 199: pSeries AIX System Support.

1.1.1 Recommended prerequisites

The following are the recommended prerequisites for this certification.

- ▶ A minimum of six months experience providing AIX Support in Version 4 and 5 environment(s). Note: Exam 199 contains AIX content up to and including AIX 5L Version 5.1.
- ▶ One to two years general AIX or UNIX experience.
- ▶ Training in system administration and advanced system administration, or equivalent experience.
- ▶ Training in TCP/IP and AIX Performance Tuning, or equivalent experience.

1.1.2 Registration for the certification exam

For information about how to register for the certification exam, please visit the following Web site:

<http://www.ibm.com/certify>

1.1.3 Certification exam objectives

The following objectives were used as a basis when the certification exam was developed. Some of these topics have been regrouped to provide better organization when discussed in this publication.

System recovery

The following are the system recovery topics.

- ▶ Use LED output to isolate boot failure problems, such as 223-229 and 551.

- ▶ Access rootvg in maintenance mode using boot media to repair or restore file system (**fsck**, missing files).
- ▶ Reset bootlist.
- ▶ Differentiate between AIX and firmware LED codes.
- ▶ Determine whether a system hang is resource or OS related.
- ▶ Force and capture dump data for a system hang.
- ▶ Use **crash** LEDs to determine if **crash** is due to hardware or software.
- ▶ Use the **snap** command.
- ▶ Examine **errlog** entries.

Disk management

The following are the disk management topics.

- ▶ Answer questions from clients on how to create or remove drives.
- ▶ Answer questions from clients on how to create/extend or remove paging space.
- ▶ Answer questions from clients on how to migrate data from one PV to another.
- ▶ Perform storage management activities (disk striping, multiple JFS log devices, and so on).
- ▶ Troubleshoot file system errors (identify missing file space, check order of mounting, **fsck**, and so on).
- ▶ Troubleshoot disk error (after improper removal, identify missing physical volume, **synchlvodm**, and other tasks).
- ▶ Understand the JFS2 and Volume Groups layout.

Devices

The following topics are related to devices.

- ▶ Answer questions from clients on how to add, delete and/or modify devices.
- ▶ Answer questions from clients on how to configure network devices (SSA loops, SCSI devices, modems, PPP communications, TTYs, asynchronous controllers, and so on).
- ▶ Troubleshoot problems related to adding, deleting, and modifying devices.
- ▶ Troubleshoot problems related to configuring network devices.
- ▶ Troubleshoot print jobs not completing or dropping characters.
- ▶ Be able to select a print subsystem.

Performance

The following are the performance related topics.

- ▶ Troubleshoot performance problems based on system configuration.
- ▶ Use AIX commands to identify CPU, RAM, and paging bottlenecks.
- ▶ Use AIX commands to identify I/O bottlenecks.
- ▶ Use AIX commands to identify network bottlenecks.
- ▶ Correct CPU, RAM, and paging shortages.
- ▶ Correct network bottlenecks.
- ▶ Optimize disk resources.
- ▶ Tune the AIX kernel.

Networking

The following are the networking related topics.

- ▶ Troubleshoot host name problems (for example, not expected value).
- ▶ Troubleshoot when there is a problem communicating to other machines on the network.
- ▶ Troubleshoot when the system is not forwarding packets.
- ▶ Set up default route and routing strategy when network traffic is not reaching destination.
- ▶ Troubleshoot when the interface has a proper IP address but cannot **ping** another host.
- ▶ Check/set TCP tuning values for improved network performance.
- ▶ Troubleshoot the inability to **telnet** or **rlogin** to a machine.
- ▶ Use different network troubleshooting commands to determine why a client cannot **telnet** beyond the default gateway.
- ▶ Debug problems when trying to **ping/telnet/rsh** to other systems.
- ▶ Add and remove interfaces (**ifconfig**, **detach**, **rmdev**, and so forth).

Scripts and shells

The following topics are related to scripts and shells.

- ▶ Verify proper script syntax.
- ▶ Check critical system scripts and what they start and control, for example, **/etc/rc**, **etc/rc.net**, **importvg**, to name a few.

Graphics

The following are the graphics related topics.

- ▶ Troubleshoot system hangs when trying to start the desktop.
- ▶ Troubleshoot the error `unable to open display`.

System configuration

The following topics are related to system configuration.

- ▶ Modify the ODM (`odmadd`, `odmdelete`).
- ▶ Examine the `cron` log files.
- ▶ Set and change environment variables.
- ▶ Use common `vi` manipulation subcommands to edit the `ksh` script.
- ▶ Use commands for viewing different file types (`ascii = cat`, `view`, `more pg: binary=strings`, and so forth).

Backup and restore

The following topics are related to backup and restore.

- ▶ Explain the usage and limitations of various backup methods to the customer (for example, `backup`, `mksysb`, `tar`, `CPIO`, and `remote backup`).
- ▶ Troubleshoot backup and restore failures.
- ▶ Instruct customer on how to restore.

Installation

The following topics are related to installation.

- ▶ Answer questions from clients regarding when to use migrate and when to preserve install.
- ▶ Determine how to select the boot kernel.
- ▶ Locate and analyze `installp` log files.
- ▶ Navigate through SMIT menus to perform different installs.
- ▶ Force overwrite when you suspect the corruption of a fileset.
- ▶ Check and verify system installation integrity (`lppchk`, `ls1pp`, `oslevel`, and so forth).
- ▶ Clone systems using `mksysb`.

1.1.4 Additional topics

- ▶ Explain the advantages of the 64-bit kernel.

1.2 Certification education courses

Courses and publications are offered to help you prepare for the certification tests. These courses are recommended, but not required, before taking a certification test.

At the time of the writing of this guide, the following courses are available. For a current list, please visit the following Web site:

<http://www.ibm.com/certify>

AIX Support Certification Test Preparation Workshop	
Course number	Q1825 (USA)
Course duration	Two days
Course abstract	This two-day workshop will provide a knowledgeable AIX professional with a review of AIX concepts necessary for the AIX Support Certification exam. A pretest is used to help identify student's readiness and assist in areas of selected study. The lecture and discussion-oriented workshop will cover a variety of topics to help the student refresh their knowledge and improve understanding of concepts to increase their confidence for the exam. Students will also be given an out-of-class reading assignment. The classroom will contain lab equipment for those students who desire hands-on activities. The AIX Support Certification exam will be available at the end of the second day.
Course content	<ul style="list-style-type: none">•System Initialization and Boot•Hardware Installation and Device Configuration•Problem Determination•System Installation and Maintenance•Printers•Storage Management and LVM•Networking•Paging Space•System Resource Controller•System Performance•System Backup and Restore•Cron Daemon

AIX Version 4 System Administration 1: Implementation	
Course number	Q1214 (USA); AU14 (Worldwide)
Course duration	Five days
Course abstract	Learn the basic system administration skills to support AIX RS/6000 running the AIX Version 4 operating system. Build your skills in configuring and monitoring a single CPU environment. Administrators who manage systems in a networked environment should attend additional LAN courses.
Course content	<ul style="list-style-type: none"> ▶ Install the AIX Version 4 operating system, software bundles, and filesets. ▶ Perform a system startup and shutdown. ▶ Understand and use AIX system management tools. ▶ Configure ASCII terminals and printer devices. ▶ Manage physical and logical volumes. ▶ Perform file systems management. ▶ Create and manage user and group accounts. ▶ Use backup and restore commands. ▶ Use administrative subsystems, including cron, to schedule system tasks, and security to implement customized access of files and directories.

AIX Version 4 Advanced System Administration II: Problem Determination	
Course number	Q1216 (USA); AU16 (Worldwide)
Course duration	Five days
Course abstract	Learn how to identify possible sources of problems on stand-alone configurations of the RS/6000 and perform advanced system administration tasks.
Course content	<ul style="list-style-type: none"> ▶ Identify the different RS/6000 models and architects. ▶ Explain the ODM purpose for device configuration. ▶ Interpret system initialization and problems during the boot process. ▶ Customize authentication and set up ACLs. ▶ Identify the TCB components, commands, and their use. ▶ Obtain a system dump and define saved data. ▶ Identify the error logging facility components and reports. ▶ List ways to invoke diagnostic programs. ▶ Customize a logical volume for optimal performance and availability. ▶ Manage a disk and the data under any circumstance. ▶ Use the standard AIX commands to identify potential I/O, disk, CPU, or other bottlenecks on the system. ▶ Customize SMIT menus and define how SMIT interacts with the ODM. ▶ Define the virtual printer database and potential problems. ▶ List the terminal attributes and create new terminfo entries. ▶ Define the NIM installation procedure.

AIX Version 4 Configuring TCP/IP and Accessing the Internet	
Course number	Q1107 (USA); AU07 or AU05 (Worldwide)
Course duration	Five days
Course abstract	<ul style="list-style-type: none"> ▶ Learn how to perform TCP/IP network configuration and administration on AIX Version 4 RS/6000 systems. Learn the skills necessary to begin implementing and using NFS, NIS, DNS, network printing, static and dynamic routing, SLIP and SLIPLOGIN, Xstations, and the Internet.
Course contents	<ul style="list-style-type: none"> ▶ Describe the basic concepts of TCP/IP protocols and addressing. ▶ Explain TCP/IP broadcasting and multicasting. ▶ Configure, implement, and support TCP/IP on an IBM RS/6000 system. ▶ Use networking commands for remote logon, remote execution, and file transfer. ▶ Configure SLIP and SLIPLOGIN. ▶ Use SMIT to configure network printing. ▶ Connect multiple TCP/IP networks using static and dynamic routing. ▶ Implement DNS, NFS, and NIS. ▶ Perform basic troubleshooting of network problems. ▶ Configure an Xstation in the AIX environment. ▶ Explain how to access Internet services. ▶ Understand and support TCP/IP. ▶ Plan implementation of NFS. ▶ Support LAN-attached printers. ▶ Support AIX networking. ▶ Determine network problems. ▶ Implement a network file system.

1.3 Education on CD-ROM: IBM AIX Essentials

The new IBM AIX Essentials series offers a dynamic training experience for those who need convenient and cost-effective AIX education. The series consists of five new, content-rich, computer-based multimedia training courses based on highly acclaimed, instructor-led AIX classes that have been successfully taught by IBM Education and Training for years.

To order, and for more information and answers to your questions:

- ▶ In the U.S., use the online form at the following URL:
<http://www.ibm.com/services/learning/spotlight/pseries/cdrom.html>
- ▶ Outside the U.S., contact your IBM Sales Representative, or contact an IBM Business Partner.



System installation and maintenance

One of the most primary of support roles is the installation of a new software image or updating an existing one. In this chapter, the most common ways of performing these tasks are discussed.

2.1 System installation

There are three types of installation methods:

- ▶ New and complete overwrite
- ▶ Migration install
- ▶ Preservation install

The following sections describe system installation in more detail.

2.1.1 New and complete overwrite installation

The new and complete overwrite installation overwrites all data on the selected destination disk. The only times to use the new and complete overwrite installation method are:

- ▶ If you have a new machine. In this case, the hard disk or disks on which you are installing the BOS are empty.
- ▶ If your root volume group has become corrupted and you do not have a backup to restore it. This can be indicated by serious ODM problems and hangs for `lslpp` and `oslevel` commands. The only choice would then be to install onto a hard disk that contains an existing root volume group that you wish to completely overwrite.
- ▶ You want to reassign your hard disks to make rootvg smaller.

After the installation is complete, you will have to configure your system using the Configuration Assistant application, SMIT, or the command line.

2.1.2 Migration installation

Use the migration installation method to upgrade AIX to a different version or release while preserving the existing root volume group.

The following describes some traits of a migration installation:

- ▶ During a migration installation, the installation process determines which optional software products must be installed on AIX 5L. Previous versions of AIX software that exist on the system are replaced by new software in AIX 5L Version 5.1.
- ▶ This method preserves all file systems except `/tmp`, as well as the root volume group, logical volumes, and system configuration files. In most cases, user configuration files from the previous version of a product are saved.
- ▶ Non-software products remain on the system.

- ▶ When migrating from Version 3.2, all files in `/usr/lib/drivers`, `/usr/lib/microcode`, `/usr/lib/methods`, and `/dev` are removed from the system, so software support for non-IBM device drivers must be reinstalled.

2.1.3 Preservation installation

Use the preservation installation method when a version of BOS is installed on your system and you want to preserve user data in the root volume group.

The following describes some traits of a preservation installation:

- ▶ The `/etc/preserve.list` file contains a list of system files to be copied and saved during a preservation BOS installation. The `/etc/filesystems` file is listed by default. Add the full path names of any additional files that you want to save during the preservation installation to the `/etc/preserve.list` file. You must create the `/etc/preserve.list` file on an AIX Version 3.1 machine. On an AIX Version 4.1 or later system, this file already exists on your system and can be directly edited.
- ▶ Ensure that you have sufficient disk space in the `/tmp` file system to store the files listed in the `/etc/preserve.list` file.
- ▶ This method overwrites the `/usr`, `/tmp`, `/var`, and `/` (root) file systems by default, so any user data in these directories is lost. These file systems are removed and recreated, so any other LPPs or filesets that you installed on the system will also be lost. Think of a preservation install as an overwrite installation for these file systems. System configuration must be done after doing a preservation installation.

2.1.4 Alternate disk installation

Alternate disk installation, available in AIX Version 4.3 and later versions, allows for system installation on a system while it is still up and running, which decreases install or upgrade downtime considerably.

The process works by either cloning the existing operating system (OS) to a secondary hard disk or installing a new OS to a secondary hard disk. In the case of cloning the existing OS, this is usually done for a migration installation on the second hard disk. In the case of installing a new OS to the second hard disk, this can be accomplished from installation media, `mksysb`, or a NIM image. Then, once the installation is complete, the system is instructed to use the OS on the secondary hard disk, and the system is rebooted for the changes to take effect.

Alternate disk installation requires some filesets to be installed before you are able to use the alternate disk installation functions. The `bos.alt_disk_install.boot_images` filesets must be installed for alternate disk **mksysb** installation if Network Install Management (NIM) is not being used. And, the `bos.alt_disk_install.rte` fileset must be installed to clone rootvg.

Note: Alternate disk installation from a **mksysb** or NIM image may require the installation of additional filesets during the installation process. There may be certain adapters, kernels, or other features on a system that require filesets not found in the **mksysb** or NIM image. If these filesets are not installed, the system may respond erratically.

To prevent these problems, ensure that your **mksysb** or NIM image has all the adapter, kernel, and other feature filesets on it. Or, ensure that all necessary filesets are installed on the secondary hard disk from install media before rebooting the system.

2.1.5 64-bit kernel installation

AIX 5L Version 5.1 allows you to install a 64-bit kernel as well as the previously available 32-bit kernel during installation.

Note: The `bootinfo -y` command will identify the type of system hardware you have, either 32-bit or 64-bit. If the command returns a 32, you cannot use the 64-bit kernel.

If your system has 64-bit processors, the 64-bit kernel is automatically installed with the Base Operating System (BOS). However, it is not mandatory to run the 64-bit kernel on a system with 64-bit processors. Some products and devices that can be used in systems with 64-bit processors do not support the 64-bit kernel yet. Unless your system environment requires a 64-bit kernel, chances are that you will not need to enable it during system installation.

Note: Enabling or disabling the 64-bit kernel does not affect the 64-bit application environment. The 64-bit application environment is supported under the 32-bit and 64-bit kernel.

If you want to enable the 64-bit kernel during installation, set the 64-bit Kernel and JFS2 option to yes during the BOS installation in the Advanced Options menu. When the system boots up for the first time after installation, it will then be running the 64-bit kernel.

If you want to enable the 64-bit kernel after system installation, you will need to instruct the system to use the 64-bit kernel information stored in the `/usr/lib/boot` directory. There are three kernels available in the `/usr/lib/boot` directory:

unix_up 32-bit kernel for uniprocessor systems
unix_mp 32-bit kernel for multiprocessor systems
unix_64 64-bit kernel for 64-bit processor systems

The following example provides the commands to run to enable the 64-bit kernel after system installation:

```
# ln -sf /usr/lib/boot/unix_64 /unix
# ln -sf /usr/lib/boot/unix64 /usr/lib/boot/unix
# bosboot -ad /dev/ipldevice
# shutdown -r
```

After the system has rebooted, it will be running the 64-bit kernel. To reactivate the 32-bit kernel, follow the same procedure, substituting `unix_up` or `unix_mp` for `unix_64`, depending on your system type.

Hardware multithreading

On select RS/6000 and @server pSeries systems, you can enable hardware multithreading (HMT) after installing AIX 5L Version 5.1. Hardware multithreading is a process that alters the ways in which processors handle data passing through them.

To enable HMT, run the **bosdebug** command as follows and reboot the system:

```
# bosdebug -H on
```

To disable HMT, run the **bosdebug** command as follows and reboot the system:

```
# bosdebug -H off
```

If HMT is not available on your hardware platform, you will receive the following error after running the **bosdebug** command:

```
# bosdebug -H on
HMT not supported on this system.
```

2.2 The **lppchk** command: verifying installed software

The **lppchk** command verifies that files for an installable software product (fileset) match the Software Vital Product Data (SWVPD) database information for file sizes, checksum values, or symbolic links.

The syntax of the **lppchk** command is as follows:

```
lppchk { -c [ u ] | -f | -l [ u ] | -v } [ -m [ 1 | 2 | 3 ] ] [ -O { [ r ] [ s ] [ u ] } ] [ ProductName [ FileList ... ] ]
```

Table 2-1 provides a list of common command flags and their descriptions for the **lppchk** command.

Table 2-1 Command flags for lppchk

Flag	Description
-c	Performs a checksum operation on the FileList items and verifies that the checksum and the file size are consistent with the SWVPD database.
-f	Checks that the FileList items are present and the file size matches the SWVPD database.
-l (lowercase L)	Verifies symbolic links for files as specified in the SWVPD database.
-m [1 2 3]	Displays three levels of information. The levels are as follows: 1 - Error messages only (default). 2 - Error messages and warnings. 3 - Error messages, warnings, and informational messages.
-O {[r][s][u]}	Verifies the specified parts of the program. This flag is not needed with stand-alone systems because without this option all parts are verified by default. The flags specify the following parts: r Indicates the / (root) part is to be verified. s Indicates the /usr/share part is to be verified. u Indicates the /usr part is to be verified.
-u	Updates the SWVPD with new checksum or size information from the system when the system information does not match the SWVPD database. This flag sets symbolic links that are found to be missing. This flag is valid with only the -c or -l flag.
-v	Verifies that the / (root), /usr, and /usr/share parts of the system are valid with each other.

Note: Only one of the -c, -f, -l, and -v flags can be specified with each use of the **lppchk** command.

The installation of the bos.dosutil fileset is interrupted. An example of the **lppchk -v** command is shown in Figure 2-1 on page 17 before and after the inconsistency is cleaned up.

```

# lppchk -v
lppchk: The following filesets need to be installed or corrected to bring
the system to a consistent state:

bos.dosutil 4.3.0.0                (APPLYING)

# installp -C

installp: Cleaning up software for:
bos.dosutil 4.3.0.0

Installation Summary
-----
Name                               Level      Part      Event      Result
-----
bos.dosutil                         4.3.0.0   USR       CLEANUP    SUCCESS
# lppchk -v
# █

```

Figure 2-1 Sample lppchk -v command output

2.3 The installp command

The **installp** command is used to install, update, and perform maintenance tasks on software. The **installp** command has a large number of flags, as shown in Table 2-2.

Table 2-2 Command flags for installp

Flag	Description
-a	Applies one or more software products or updates. This is the default action. This flag can be used with the -c flag to apply and commit a software product update during installation.
-B	Indicates that the requested action should be limited to software updates.
-C	Cleans up after an interrupted installation and attempts to remove all incomplete pieces of the previous installation.
-c	Commits applied updates to the system.
-d <i>Device</i>	Specifies on what device the installation media can be found.
-F	Forces the installation of a software product even if there exists a previously installed version of the software product that is the same version as or newer than the one being installed.

Flag	Description
-f <i>ListFile</i>	Reads the names of the software products from <i>ListFile</i> . If <i>ListFile</i> is a - (dash), it reads the list of names from the standard input. Output from the <code>installp -l</code> command is suitable for input to this flag.
-g	When used to install or commit, this flag automatically installs or commits, respectively, any software products or updates that are requisites of the specified software product. When used to remove or reject software, this flag automatically removes or rejects dependents of the specified software.
-L	Displays the contents of the media by looking at the table of contents (.toc) and displaying the information in colon-separated output. This flag is used by SMIT to list content of the media.
-l (lowercase L)	Lists all the software products and their separately installable options contained on the installation media to the standard output. No installation occurs.
-N	Overrides saving of existing files that are replaced when installing or updating. This flag is valid only with the -ac flags.
-p	Performs a preview of an action by running all pre-installation checks for the specified action. This flag is only valid with apply, commit, reject, and remove (-a, -c, -r, and -u) flags.
-r	Rejects all software updates that are currently applied but not committed.
-u	Removes the specified software product and any of its installed updates from the system. Removal of any bos.rte fileset is never permitted.
-V <i>Number</i>	Specifies the verbose option that can provide up to four levels of detail for pre-installation output, including SUCCESSES, WARNINGS, and FAILURES.
-v	Verifies that all installed files in the fileset have the correct checksum value after installation. Can be used with the -a and -ac flags to confirm a successful installation. If any errors are reported by this flag, it may be necessary to reinstall the software.
-X	Attempts to expand any file systems where there is insufficient space to do the installation.

By default, the output of the `installp` command goes to stdout and stderr, and a copy of the last interaction is stored in `/var/adm/sw/installp.summary`.

2.4 Determining maintenance levels

The `oslevel` command reports the level of the operating system using a subset of all filesets installed on your system. The `oslevel` command also prints information about maintenance levels, including which filesets are not at a specified maintenance level. The optional flags for this commands are:

- l Level** Lists filesets at levels earlier than the maintenance level specified by the Level parameter.
- g** Lists filesets at levels later than the current maintenance level.
- q** Lists names of known maintenance levels that can be specified using the -l flag.

The sample output in Figure 2-3 shows that the operating system level is at 4.3.0.0, only 4.3.0.0 can be specified with the -l flag, there are no filesets at levels later than 4.3.0.0, and the filesets that are at levels earlier than 4.3.0.0.

```
# oslevel
4.3.0.0
# oslevel -q
Known Maintenance Levels
-----
4.3.0.0
# oslevel -g
# oslevel -l 4.3.0.0
Fileset                               Actual Level    Maintenance Level
-----
X11.msg.en_US.Dt.helpmin              4.2.0.0         4.3.0.0
X11.msg.en_US.Dt.rte                  4.2.0.0         4.3.0.0
X11.msg.en_US.apps.aixterm            4.2.0.0         4.3.0.0
X11.msg.en_US.apps.clients            4.2.0.0         4.3.0.0
X11.msg.en_US.apps.custom             4.2.0.0         4.3.0.0
X11.msg.en_US.apps.pm                 4.2.0.0         4.3.0.0
X11.msg.en_US.apps.rte                4.2.0.0         4.3.0.0
X11.msg.en_US.base.common             4.2.0.0         4.3.0.0
X11.msg.en_US.base.rte                4.2.0.0         4.3.0.0
X11.msg.en_US.motif.lib               4.2.0.0         4.3.0.0
X11.msg.en_US.motif.mwm               4.2.0.0         4.3.0.0
X11.msg.en_US.vsm.rte                 4.2.0.0         4.3.0.0
printers.msg.en_US.rte                4.2.0.0         4.3.0.0
# █
```

Figure 2-3 Sample `oslevel` command output

2.5 Modification update using update_all from SMIT

You can use the SMIT fast path `smit update_all` to update currently installed software to a modification level or apply all updates to currently installed software. You can either use the installation CD-ROMs or download the maintenance-level fixes using the FixDist package.

2.5.1 Downloading maintenance levels using FixDist

The following describes a procedure to download the AIX Version 4.3.1 base maintenance level using the FixDist package:

1. Double-click to select Base Maintenance Levels in FixDist, as shown in Figure 2-4.

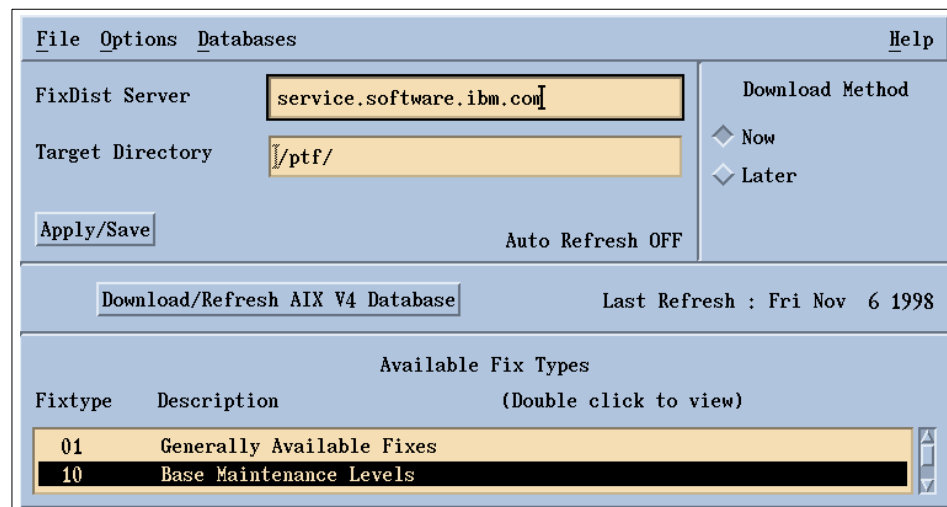

Figure 2-4 Select base maintenance levels in FixDist

2. Select AIX 431 Maintenance Level, then click OK, as in Figure 2-5 on page 22.

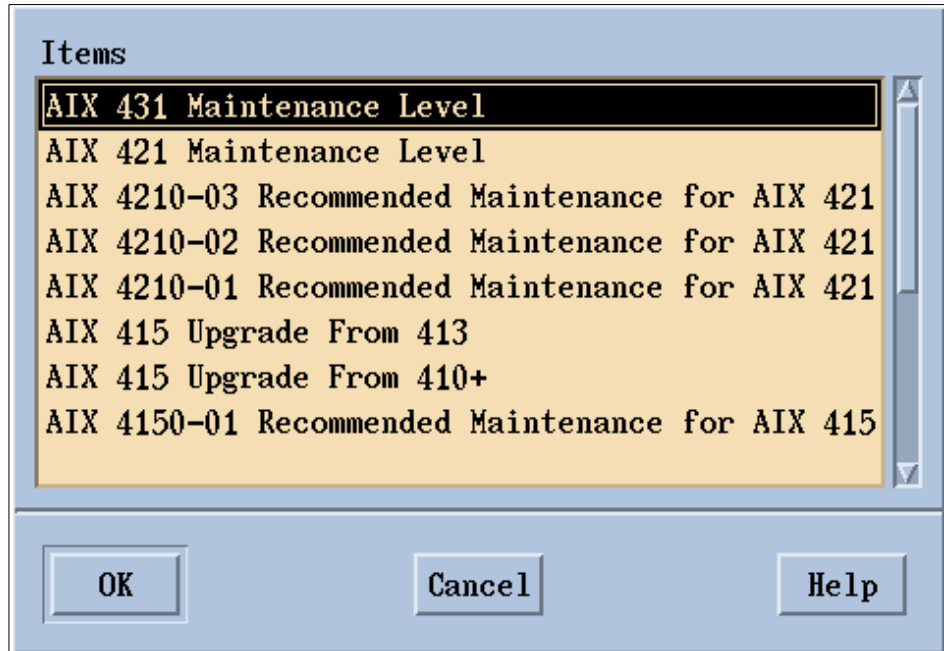

Figure 2-5 Select AIX 431 maintenance level in FixDist

3. Ensure that you have sufficient disk space to store the files to be downloaded as indicated by FixDist (shown in Figure 2-6) and select Start Download.

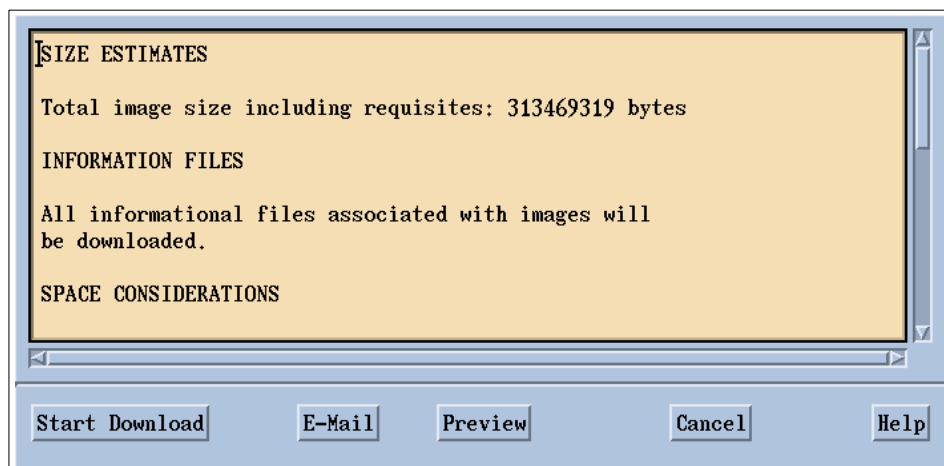

Figure 2-6 Estimated size of files to be downloaded

4. Check the ptfload.log file to ensure that all files are transferred successfully.

- The stacklist file will show you what fixes have been downloaded. You should see all the backup format files (BFF) with the fix level 4.3.1.0.

2.5.2 Invoking the smit update_all fast path

Back up your system (as described in Chapter 9, “System backup and restore” on page 211) and then use the SMIT fast path `smit update_all` and specify the download directory for INPUT device/directory for software, as shown in Figure 2-7.

```

Update Installed Software to Latest Level (Update All)

Type or select values in entry fields.
Press Enter AFTER making all desired changes.

                                [Entry Fields]
* INPUT device / directory for software      /ftp
* SOFTWARE to update                        _update_all
PREVIEW only? (update operation will NOT occur) no      +
COMMIT software updates?                   yes      +
SAVE replaced files?                       no      +
AUTOMATICALLY install requisite software?  yes      +
EXTEND file systems if space needed?       yes      +
VERIFY install and check file sizes?      no      +
DETAILED output?                          no      +
Process multiple volumes?                 yes      +

F1=Help      F2=Refresh      F3=Cancel      F4=List
F5=Reset     F6=Command     F7=Edit       F8=Image
F9=Shell     F10=Exit       Enter=Do

```

Figure 2-7 Using SMIT `update_all` to upgrade modification level

If you are using the AIX Version 4.3 installation CD-ROMs, enter `/dev/cd0` for the INPUT device/directory for the software field. You may need to replace Volume 1 of the AIX Version 4.3 installation CD-ROMs with Volume 2 and then switch back to Volume 1 again, depending on what filesets you have installed on the 4.3.0.0 system. The swapping of CD-ROMs is normal.

2.6 Finding a fileset that contains a given command

It is a common task to upgrade a single component, but it is difficult to determine what fileset requires the update. This section describes a process to accomplish this.

Suppose a user suspects that there is a problem with the `nfsd` program. The system administrator wants to download the latest fix level of the fileset. The following steps are planned:

1. Find out the full path of the `nfsd` program using the `whence` command.
2. Find out which fileset the `nfsd` program belongs to using the `ls1pp -w` command.
3. Find out the maintenance level of the fileset installed on the system using the `ls1pp -l` command to ensure that a fileset with a higher fix level is to be downloaded.

The following is an example using `nfsd`:

```
# whence nfsd
/usr/sbin/nfsd
# ls1pp -w /usr/sbin/nfsd
File                               Fileset                               Type
-----
/usr/sbin/nfsd                     bos.net.nfs.client                    File
# ls1pp -l bos.net.nfs.client
Fileset                             Level  State  Description
-----
Path: /usr/lib/objrepos
bos.net.nfs.client                  4.3.2.0  COMMITTED  Network File System Client

Path: /etc/objrepos
bos.net.nfs.client                  4.3.2.0  COMMITTED  Network File System Client
#
```

If you already know a fileset and would like to determine what the contents are, use the `ls1pp -f bos.net.nfs.client` command.

2.7 Quiz

The following certification assessment questions help verify your understanding of the topics discussed in this chapter.

1. Using SMIT, a support specialist is installing a PTF to correct a problem. The installation has failed. Where would the support specialist look to troubleshoot the cause of the installation failure?
 - A. `/smit.log`
 - B. `/image.data`
 - C. `/tmp/bos/smit.log`
 - D. `/var/adm/ras/bosinstlog`

2. A customer has asked a support specialist which fileset to install in order to use the **qprt** command. The support specialist is certain the fileset is in either printers.rte. or bos.rte.printers. Which command could the support specialist run against each fileset to verify which fileset contains this executable?
 - A. **ls1pp -f**
 - B. **ls1pp -c**
 - C. **lppchk -c**
 - D. **lppchk -f**
3. An owner of a pSeries 680 would like to install AIX 5L and use JFS2 for the rootvg file systems. Which of the following methods are available to perform this task?
 - A. Advise the customer that rootvg cannot contain a JFS2.
 - B. Enable JFS2 by setting the ENHANCEDJFS environment variable to YES.
 - C. Run the **migratefs** command on each of the file systems after the installation.
 - D. Select the Enable 64-bit Kernel and JFS2 advanced install option at installation time.

The following are additional questions created by the authors to further test your understanding of the topics.

1. A technical specialist working on an RS/6000 Model 397 running AIX 4.3.1 determines that the system needs to be reinstalled with the same version of the operating system. What is the best method to perform the reinstallation without erasing /home and /data, a file system used to store project data?
 - A. Reinstall bos.rte from the installation media.
 - B. Perform a preservation installation from a **mksysb**.
 - C. Perform a migration installation from the installation media.
 - D. Perform a preservation installation from the installation media.
2. The support specialist is installing the latest fixes for the bos.rte.tty fileset using SMIT. There is an error during the installation of the APAR. Where is the installation log file located?
 - A. **\$HOME/smit.log**
 - B. **/intallp.log**
 - C. **/tmp/bos/bosinst.log**
 - D. **/var/adm/ras/install.log**

3. The marketing department has requested that their RS/6000 server be upgraded from 4.2.0 to 4.2.1. Using the 4.2.1 installation CD-ROM, which of the following commands would the system administrator use to accomplish this task?
 - A. `smit update_all`
 - B. `smit easy_install`
 - C. `smit update_latest`
 - D. `smit maintain_software`
4. Which of the following commands can be run to find the release of the operating system on an RS/6000?
 - A. `oslevel`
 - B. `oslevel -release`
 - C. `lslpp -ah bos.obj`
 - D. `lslpp -l bos.obj`

2.7.1 Answers

The following answers are for the assessment quiz questions.

1. A
2. A
3. D

The following answers are for the additional quiz questions.

1. D
2. A
3. A
4. A

2.8 Exercises

The following exercises provide sample topics for self study. They will help ensure comprehension of this chapter.

1. On a test system that does not affect any users, perform a new and complete overwrite installation.
2. On a test system that does not affect any users, perform a migration install to upgrade AIX to the next release level. Note what data is saved and what data is removed.
3. On a test system that does not affect any users, perform a **smit update_all** to upgrade AIX to the next modification level.
4. On a test system that does not affect any users, perform a preservation install to reinstall the same version, release, and modification level of the operating system. Note what data is saved and what data is removed.
5. Use the various flags of the **lppchk** command to verify the checksum, the file sizes, the symbolic links, and the requisites of the software products installed.
6. Check the `$HOME/smit.log` for the **installp** command output log.
7. Use the various flags of the **oslevel** command to show the level of the operating system, the known maintenance levels of the operating system installed on the system, the lists at levels earlier than the specified level parameter, and the filesets at levels later than the current maintenance level.
8. Use the **ls1pp** command to find out which fileset is used to package a given command.



System initialization and boot

A support specialist must understand the system initialization process, common startup errors, and how to customize the startup of software. This chapter introduces the concepts needed to better understand this process.

3.1 System initialization

During system startup, after the root file system has been mounted in the pre-initialization process, the following sequence of events occurs:

1. The **init** command is run as the last step of the startup process.
2. The **init** command attempts to read the `/etc/inittab` file.
3. If the `/etc/inittab` file exists, the **init** command attempts to locate an `initdefault` entry in the `/etc/inittab` file.
 - a. If the `initdefault` entry exists, the **init** command uses the specified run level as the initial system run level.
 - b. If the `initdefault` entry does not exist, the **init** command requests that the user enter a run level from the system console (`/dev/console`).
 - c. If the user enters an S, s, M, or m run level, the **init** command enters the maintenance run level. These are the only run levels that do not require a properly formatted `/etc/inittab` file.
4. If the `/etc/inittab` file does not exist, the **init** command places the system in the maintenance run level by default.
5. The **init** command rereads the `/etc/inittab` file every 60 seconds. If the `/etc/inittab` file has changed since the last time the **init** command read it, the new commands in the `/etc/inittab` file are executed.

3.2 The `/etc/inittab` file

The `/etc/inittab` file controls the initialization process.

The `/etc/inittab` file supplies the script to the **init** command's role as a general process dispatcher. The process that constitutes the majority of the **init** command's process dispatching activities is the `/etc/getty` line process, which initiates individual terminal lines. Other processes typically dispatched by the **init** command are daemons and the shell.

The `/etc/inittab` file is composed of entries that are position-dependent and have the following format:

```
Identifier:RunLevel:Action:Command
```

Each entry is delimited by a newline character. A backslash (`\`) preceding a newline character indicates the continuation of an entry. There are no limits (other than maximum entry size) on the number of entries in the `/etc/inittab` file. The maximum entry size is 1024 characters.

The entry fields are:

Identifier	A one to fourteen character field that uniquely identifies an object.
RunLevel	<p>The run level at which this entry can be processed.</p> <p>The run level has the following attributes:</p> <ul style="list-style-type: none">– Run levels effectively correspond to a configuration of processes in the system.– Each process started by the init command is assigned one or more run levels in which it can exist.– Run levels are represented by the numbers 0 through 9. For example, if the system is in run level 1, only those entries with a 1 in the run-level field are started.– When you request the init command to change run levels, all processes without a matching entry in the run-level field for the target run level receive a warning signal (SIGTERM). There is a 20-second grace period before processes are forcibly terminated by the kill signal (SIGKILL).– The run-level field can define multiple run levels for a process by selecting more than one run level in any combination from 0 through 9. If no run level is specified, the process is assumed to be valid at all run levels.– There are three other values that appear in the run-level field, even though they are not true run levels: a, b, and c. Entries that have these characters in the run level field are processed only when the telinit command requests them to be run (regardless of the current run level of the system). They differ from run levels in that the init command can never enter run level a, b, or c. Also, a request for the execution of any of these processes does not change the current run level. Furthermore, a process started by an a, b, or c command is not killed when the init command changes levels. They are only killed if their line in the <code>/etc/inittab</code> file is marked off in the action field, their line is deleted entirely from <code>/etc/inittab</code>, or the init command goes into single-user mode.
Action	<p>Tells the init command how to treat the process specified in the process field. The following actions are recognized by the init command:</p> <p>respawn If the process does not exist, start the process. Do not wait for its termination (continue scanning the <code>/etc/inittab</code> file). Restart the process when it dies. If</p>

- the process exists, do nothing and continue scanning the `/etc/inittab` file.
- wait** When the `init` command enters the run level that matches the entry's run level, start the process and wait for its termination. All subsequent reads of the `/etc/inittab` file, while the `init` command is in the same run level, will cause the `init` command to ignore this entry.
- once** When the `init` command enters a run level that matches the entry's run level, start the process, and do not wait for termination. When it dies, do not restart the process. When the system enters a new run level, and the process is still running from a previous run level change, the program will not be restarted.
- boot** Process the entry only during system boot, which is when the `init` command reads the `/etc/inittab` file during system startup. Start the process, do not wait for its termination, and when it dies, do not restart the process. In order for the instruction to be meaningful, the run level should be the default or it must match the `init` command's run level at boot time. This action is useful for an initialization function following a hardware reboot of the system.
- bootwait** Process the entry the first time that the `init` command goes from single-user to multi-user state after the system is booted. Start the process, wait for its termination, and when it dies, do not restart the process. If the `initdefault` is 2, run the process right after boot.
- powerfail** Execute the process associated with this entry only when the `init` command receives a power fail signal (SIGPWR).
- powerwait** Execute the process associated with this entry only when the `init` command receives a power fail signal (SIGPWR), and wait until it terminates before continuing to process the `/etc/inittab` file.
- off** If the process associated with this entry is currently running, send the warning signal (SIGTERM), and wait 20 seconds before terminating the process with the kill signal (SIGKILL). If the process is not running, ignore this entry.

ondemand Functionally identical to `respawn`, except this action applies to the `a`, `b`, or `c` values, not to run levels.

initdefault An entry with this action is only scanned when the `init` command is initially invoked. The `init` command uses this entry, if it exists, to determine which run level to enter initially. It does this by taking the highest run level specified in the run-level field and using that as its initial state. If the run level field is empty, this is interpreted as `0123456789`; therefore, the `init` command enters run level 9. Additionally, if the `init` command does not find an `initdefault` entry in the `/etc/inittab` file, it requests an initial run level from the user at boot time.

sysinit Entries of this type are executed before the `init` command tries to access the console before login. It is expected that this entry will only be used to initialize devices on which the `init` command might try to ask the run level question. These entries are executed and waited for before continuing.

Command A shell command to execute. The entire command field is prefixed with `exec` and passed to a forked `sh` as `sh -c exec command`. Any legal `sh` syntax can appear in this field. Comments can be inserted with the `#` comment syntax.

The `getty` command writes over the output of any commands that appear before it in the `/etc/inittab` file. To record the output of these commands to the boot log, pipe their output to the `alog -tboot` command.

The `stdin`, `stdout`, and `stderr` file descriptors may not be available while `init` is processing `inittab` entries. Any entries writing to `stdout` or `stderr` may not work predictably unless they redirect their output to a file or to `/dev/console`.

The following commands are the only supported methods for modifying the records in the `/etc/inittab` file:

chitab Changes records in the `/etc/inittab` file.

lsitab Lists records in the `/etc/inittab` file.

mkitab Adds records to the `/etc/inittab` file.

rmitab Removes records from the `/etc/inittab` file.

An example of /etc/inittab entries is shown in Figure 3-1.

```
:
: Note - initdefault and sysinit should be the first and second entry.
:
init:2:initdefault:
brc::sysinit:/sbin/rc.boot 3 >/dev/console 2>&1 # Phase 3 of system boot
powerfail::powerfail:/etc/rc.powerfail 2>&1 | alog -tboot > /dev/console # Power
Failure Detection
rc:2:wait:/etc/rc 2>&1 | alog -tboot > /dev/console # Multi-User checks
fbcheck:2:wait:/usr/sbin/fbcheck 2>&1 | alog -tboot > /dev/console # run /etc/fi
rstboot
srcmstr:2:respawn:/usr/sbin/srcmstr # System Resource Controller
rctcpip:2:wait:/etc/rc.tcpip > /dev/console 2>&1 # Start TCP/IP daemons
rcdce:2:wait:/etc/rc.dce all >/dev/console 2>&1 #Start DFS deaemons
rccm:2:wait:/usr/bin/cm setsetuid /usr/prod/bin/* -state on >/dev/console 2>&1
dceuptd:2:wait:/etc/rc.dce_update >/dev/console 2>&1 #Start DCE update script
lafsf:2:once:/usr/vice/etc/lafsf
rcnfs:2:wait:/etc/rc.nfs > /dev/console 2>&1 # Start NFS Daemons
cron:2:respawn:/usr/sbin/cron
piobe:2:wait:/usr/lib/lpd/pio/etc/pioinit >/dev/null 2>&1 # pb cleanup
qdaemon:2:wait:/usr/bin/startsrc -sqdaemon
writesrv:2:wait:/usr/bin/startsrc -swritesrv
uprintfd:2:respawn:/usr/sbin/uprintfd
logsymp:2:once:/usr/lib/ras/logsymptom # for system dumps
pmd:2:wait:/usr/bin/pmd > /dev/console 2>&1 # Start PM daemon
dt:2:wait:/etc/rc.dt
cons:0123456789:respawn:/usr/sbin/getty /dev/console
imnss:2:once:/usr/IMNSearch/bin/imnss -start imnhelp >/dev/console 2>&1
httpdlite:2:once:/usr/IMNSearch/httpdlite/httpdlite -r /etc/IMNSearch/httpdlite/
httpdlite.conf >/dev/console 2>&1
i4ls:2:wait:/etc/i4ls.rc > /dev/null 2>&1 # Start i4ls
# █
```

Figure 3-1 Example /etc/inittab file

Order of /etc/inittab entries

The base process entries in the /etc/inittab file is ordered as follows:

- ▶ 1 - initdefault
- ▶ 2 - sysinit
- ▶ 3 - Powerfailure Detection (powerfail)
- ▶ 4 - Multiuser check (rc)
- ▶ 5 - /etc/firstboot (fbcheck)
- ▶ 6 - System Resource Controller (srcmstr)
- ▶ 7 - Start TCP/IP daemons (rctcpip)
- ▶ 8 - Start NFS daemons (rcnfs)
- ▶ 9 - cron
- ▶ 10 - pb cleanup (piobe)
- ▶ 11 - getty for the console (cons)

The System Resource Controller (SRC) has to be started near the beginning of the `etc/inittab` file since the SRC daemon is needed to start other processes. Since NFS requires TCP/IP daemons to run correctly, TCP/IP daemons are started ahead of the NFS daemons. The entries in the `/etc/inittab` file are ordered according to dependencies, meaning that if a process (process2) requires that another process (process1) be present for it to operate normally, then an entry for process1 comes before an entry for process2 in the `/etc/inittab` file.

3.2.1 The `telinit` command

The `telinit` command directs the actions of the `init` process (process ID 1) by taking a one-character argument and signaling the `init` process to perform the appropriate action. In general, the `telinit` command sets the system at a specific run level. The following arguments serve as directives that the `telinit` command passes to the `init` process:

- 0-9** Tells the `init` process to put the system in one of the run levels 0-9.
- S,s,M,m** Tells the `init` process to enter the maintenance mode.
- a,b,c** Tells the `init` process to examine only those records in the `/etc/inittab` file with a, b, or c in the run-level field.
- Q,q** Tells the `init` process to re-examine the entire `/etc/inittab` file.
- N** Sends a signal that stops processes from being respawned.

3.3 Initialization support

Generally, if you encounter a problem in the booting process, you receive a three-digit LED error code. In this section, several software problems are discussed along with their possible solutions.

3.3.1 Using the `bootlist` command

You can change the way your system looks up devices to find its boot code. The `bootlist` command displays and alters the list of boot devices available to the system. The general syntax of the command is as follows:

```
bootlist [ { -m Mode } [ -r ] [ -o ] [ [ -i ] | [ [ -f File ]  
[ Device [ Attr=Value ... ] ... ] ] ]
```

The most common flags used with the **bootlist** command are given in Table 3-1.

Table 3-1 *bootlist* command flags

Flag	Description
-m <i>mode</i>	Specifies which boot list to display or alter. Possible values for the mode variable are normal, service, both, or prevboot.
-f <i>File</i>	Indicates that the device information is to be read from the specified file name.
-i	Indicates that the device list specified by the -m flag should be invalidated.
-o	Displays bootlist with -m flag. Applies only to AIX Version 4.2 or later.
-r	Indicates to display the specified bootlist after any specified alteration is performed.

The **bootlist** command allows the user to display and alter the list of possible boot devices from which the system may be booted. When the system is booted, it will scan the devices in the list and attempt to boot from the first device it finds containing a boot image. This command supports the updating of the following:

- Normal boot list** The normal list designates possible boot devices for when the system is booted in normal mode.
- Service boot list** The service list designates possible boot devices for when the system is booted in service mode.
- Previous boot device** This entry designates the last device from which the system booted. Some hardware platforms may attempt to boot from the previous boot device before looking for a boot device in one of the other lists.

Support of these boot lists varies from platform to platform, and some platforms do not have boot lists. When searching for a boot device, the system selects the first device in the list and determines if it is bootable. If no boot file system is detected on the first device, the system moves on to the next device in the list. As a result, the ordering of devices in the device list is extremely important.

In order to display a boot list (Version 4.2 or later), use the command:

```
# bootlist -m normal -o
fd0
cd0
hdisk0
```

If you want to make changes to your normal boot list, use the command:

```
# bootlist -m normal fd0 hdisk0 cd0
```

or create a file containing the list of fd0 hdisk0 cd0 (separated by whitespace or one device per line) and use the command:

```
# bootlist -m normal -f filename
```

This will change the normal bootlist to indicate that when the system is booted, it will first attempt to boot from the floppy disk. If it can not find a boot image on the floppy disk, it will look to hdisk0, then search the CD-ROM, otherwise, it will give an LED code and wait for user intervention.

3.3.2 Locating boot logical volumes

You must know where boot logical volumes (BLV) are located in order to include them in the boot list. Use the following procedure to locate BLVs:

1. Use the **lsvg** command to identify volume groups:

```
# lsvg
rootvg
co-opvg
```

2. Use the **lsvg -l** command with the **grep** command to search for the string *boot* in all of the volume groups listed in step 1:

```
# lsvg -l rootvg | grep boot
hd5          boot          1      1      1      closed/syncd  N/A
# lsvg -l co-opvg | grep boot
#
```

3. Use the **lslv -l** command with each BLV found in step 2 to find out on which physical volumes they are located:

```
# lslv -l hd5
hd5:N/A
PV          COPIES          IN BAND          DISTRIBUTION
hdisk0      001:000:000    100%             001:000:000:000:000
```

In this case, only hdisk0 can be included in the boot list.

3.3.3 Accessing a system that will not boot

If you are unable to boot your system, the first step is to access the system and see what is the probable cause of the failure. This procedure enables you to get a system prompt so that you may attempt to recover data from the system or perform corrective action that will enable the system to boot from the hard disk.

In order to access the system:

1. Turn the system key (if present) to the Service position or alternatively press F5 on a PCI based system to boot from the tape/CD-ROM/DVD-RAM drive (during step 4).
2. Turn on all attached external devices, such as terminals, CD-ROM or DVD-RAM drives, tape drives, monitors, and external disk drives before turning on the system unit. Turn on the system unit to allow the installation media to be loaded.
3. Insert Volume 1 of the installation media into the tape, CD-ROM, or DVD-RAM drive, and power the system unit off.
4. Turn the system unit power switch to the On position. When booting from alternate media, a screen will appear (before Figure 3-2) asking you to press a function key (such as F1) to select the proper display as the system console. Each display on the system will receive a function key number in order to identify it as the system console. The system begins booting from the installation media. After several minutes, c31 is displayed in the LED (if your system has an LED; otherwise, a screen similar to the one in Figure 3-2 is shown).

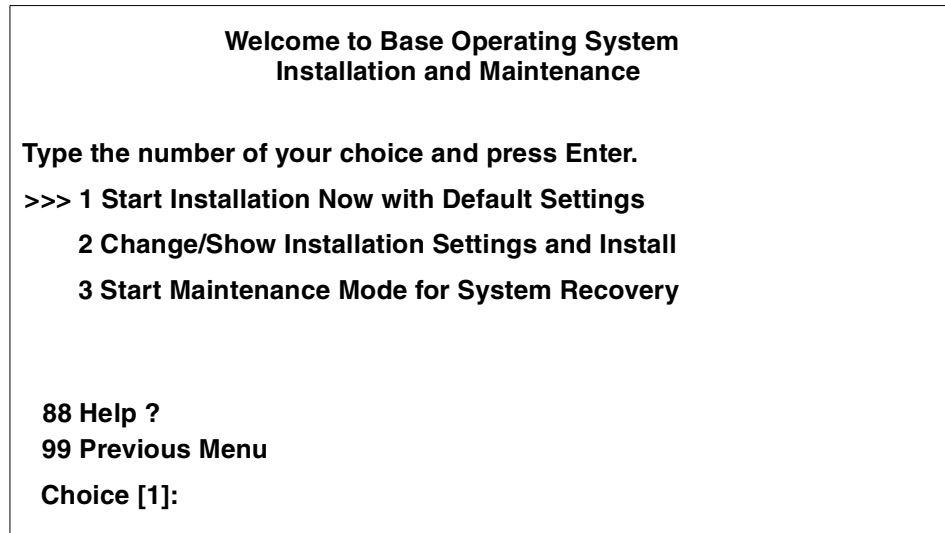

Figure 3-2 BOS installation and maintenance screen

5. Select option 3, Start Maintenance Mode for System Recovery, and press Enter. A screen similar to the one in Figure 3-3 on page 39 is shown.

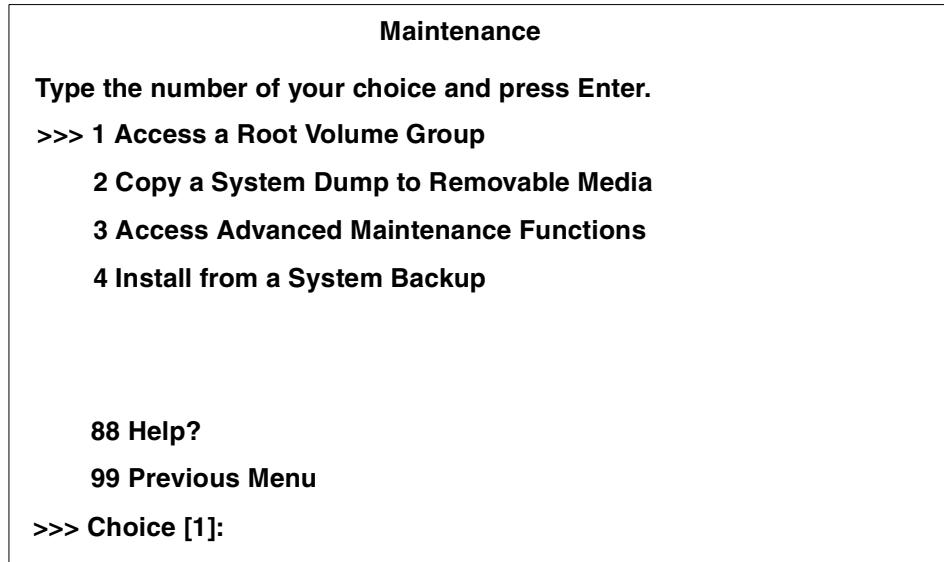

Figure 3-3 Maintenance screen

6. Enter 1, Access a Root Volume Group. A screen similar to the one in Figure 3-4 is shown.

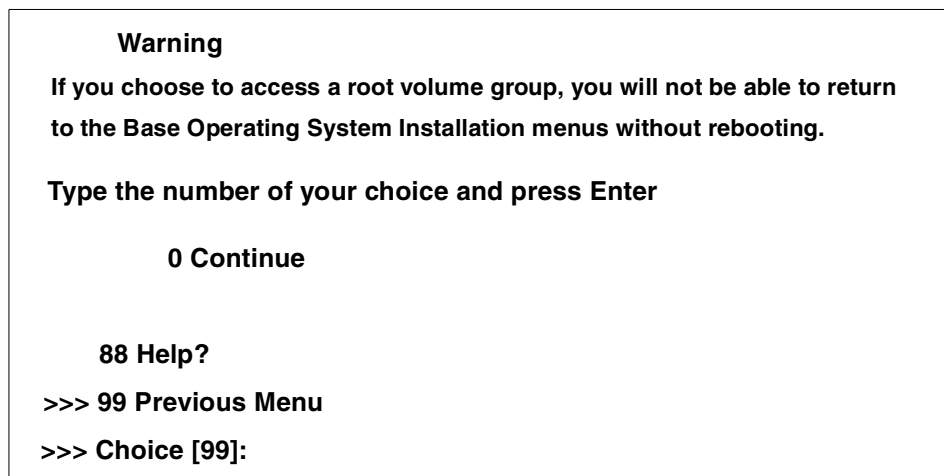

Figure 3-4 Warning screen

7. Enter a 0 and press Enter. A screen similar to Figure 3-5 on page 40 is shown.

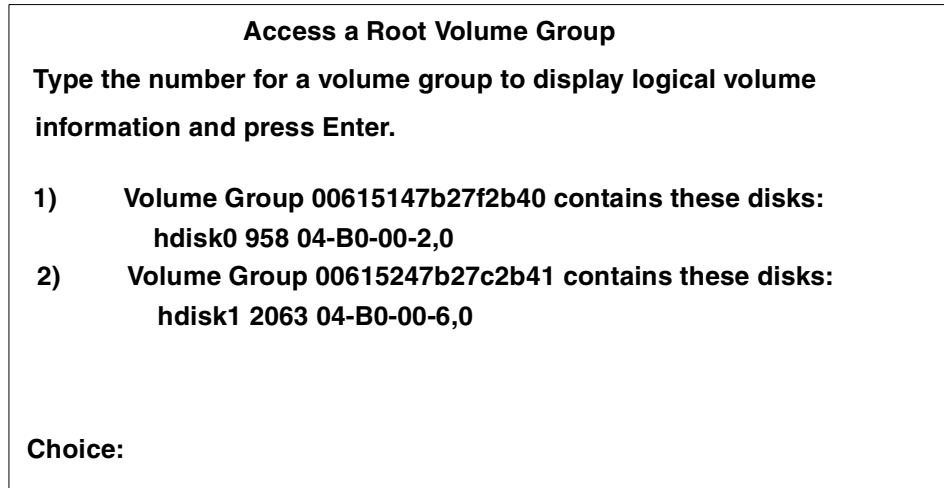

Figure 3-5 Access a Root Volume Group screen

8. Select the volume group whose logical volume information you want to display. This is important, because rootvg will have hd5, that is, the boot logical volume. Enter the number of the volume group and press Enter. A screen similar to Figure 3-6 is shown.

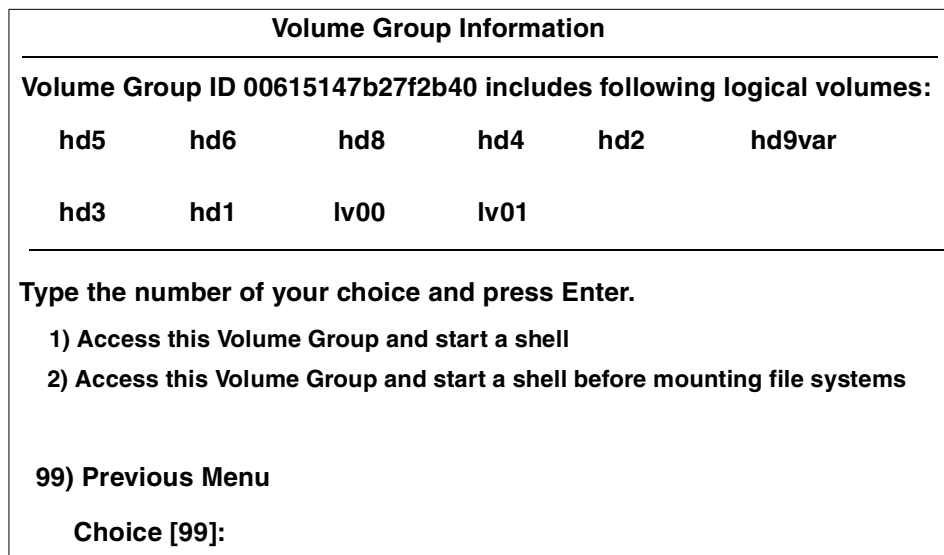

Figure 3-6 Volume Group Information screen

9. Select one of the options from the Volume Group Information screen and press Enter. Each option does the following:
 - Choice 1** Selecting this choice imports and activates the volume group and mounts the file systems for this root volume group before providing you with a shell and a system prompt.
 - Choice 2** Selecting this choice imports and activates the volume group and provides you with a shell and system prompt before mounting the file systems for this root volume group.
 - Choice 99** Entering 99 returns you to the Access a Root Volume Group screen.

After either choice 1 or 2 is selected and processed, a shell and system prompt are displayed.
10. Take appropriate measures to recover data or take action (such as using the **bosboot** command) to enable the system to boot normally.

3.3.4 Common boot time LED codes

During system initialization, servers with operator panel displays will show LED codes that provide information about the status of the boot process. Some codes are checkpoints that indicate which point in the boot process the server has reached. These codes depend on the type of server.

For example, on a server with a four character display, E1F1 indicates that the system-defined console has been activated, whereas FF1 indicates this on a server with a three character display. Codes in the form of Fxx, where xx is a hexadecimal number, are generally related to firmware.

Other codes indicate that a fault has been detected. The most common LED codes that indicate boot problems and how to get around them to getting your system up and running again are given in Table 3-2.

Table 3-2 Common startup LEDs and solutions

LED 201 - Damaged boot image
<ol style="list-style-type: none"> 1. Access your rootvg by following the procedure described in Section 3.3.3, "Accessing a system that will not boot" on page 37. 2. Check / and /tmp file systems. If they are almost full, create more space. 3. Determine the boot disk by using the command lslv -m hd5. 4. Re-create boot image using bosboot -a -d /dev/hdiskn. 5. Check for CHECKSTOP errors in the error log. If such errors are found, it is probably failing hardware. 6. Shutdown and restart the system.

LED 223-229 - Invalid boot list

1. Set the key mode switch to service (F5 for systems without keylock) and power up the machine.
2. If display continues normally, change the key mode switch to Normal and continue with step 3. If you do not get the prompt, go to step 4.
3. When you get the login prompt, login and follow the procedure described in Section 3.3.1, "Using the bootlist command" on page 35 to change your bootlist. Continue with step 7.
4. Follow the procedure in Section 3.3.3, "Accessing a system that will not boot" on page 37 to access your rootvg and continue with step 5.
5. Determine the boot disk by using the command `lslv -m hd5`.
6. Change the bootlist following the procedure given in Section 3.3.1, "Using the bootlist command" on page 35.
7. Shutdown and restart your system.

LED 551, 555, and 557 - Corrupted file system, corrupted JFS log, and so on.

1. Follow the procedure described in Section 3.3.3, "Accessing a system that will not boot" on page 37, to access the rootvg before mounting any file systems (Option 2 on the Maintenance screen).
2. Verify and correct the file systems as follows:

```
fscck -y /dev/hd1  
fscck -y /dev/hd2  
fscck -y /dev/hd3  
fscck -y /dev/hd4  
fscck -y /dev/hd9var
```
3. Format the JFS log again by using the command:

```
/usr/sbin/logform /dev/hd8
```
4. Use `lslv -m hd5` to find out the boot disk.
5. Recreate boot image by using the command:

```
bosboot -a -d /dev/hdiskn
```

Where *n* is the disk number of the disk containing boot logical volume.

LED 552, 554, and 556 - Super block corrupted and corrupted customized ODM database

1. Repeat steps 1 through 2 for LEDs 551, 555, and 557.
2. If **fsck** indicates that block 8 is corrupted, the super block for the file system is corrupted and needs to be repaired. Enter the command:

```
dd count=1 bs=4k skip=31 seek=1 if=/dev/hdn of=/dev/hdn
```

where *n* is the number of the file system.
3. Rebuild your JFS log by using the command:

```
/usr/sbin/logform /dev/hd8
```
4. If this solves the problem, stop here; otherwise, continue with step 5.
5. Your ODM database is corrupted. Restart your system and follow the procedure given in Section 3.3.3, "Accessing a system that will not boot" on page 37 to access rootvg with Choice 2.
6. Mount the root and usr file system as follows:

```
mount /dev/hd4 /mnt  
mount /usr
```
7. Copy the system configuration to a back up directory:

```
mkdir /mnt/etc/objrepos/backup  
cp /mnt/etc/objrepos/Cu* /mnt/etc/objrepos/backup
```
8. Copy the configuration from the RAM file system as follows:

```
cp /etc/objrepos/Cu* /mnt/etc/objrepos
```
9. Unmount all file systems by using the **umount a11** command.
10. Determine bootdisk by using the **lslv -m hd5** command.
11. Save the clean ODM to the boot logical volume by using the command:

```
savebase -d/dev/hdiskn
```
12. Reboot, if system does not come up, and reinstall BOS.

LED 553 - Corrupted /etc/inittab file

1. Access the rootvg with all file systems mounted by following the procedure described in Section 3.3.3, "Accessing a system that will not boot" on page 37.
2. Check for free space in /, /var and /tmp by using the **df** command.
3. Check the /etc/inittab file and correct the inittab problems if there is one empty inittab file, missing inittab file, or wrong entry in inittab file.
4. Check problems with:
 - /etc/environment file
 - /bin/sh
 - /bin/bsh
 - /etc/fsock
 - /etc/profile
 - /.profile
5. Shut down the system and reboot.

3.4 Quiz

The following certification assessment questions help verify your understanding of the topics discussed in this chapter.

1. During bootup, the support specialist notices LEDs alternating between 223 and 229. This indicates an invalid boot device. Assuming no hardware failures, which of the following commands should be used next in order to determine the boot device once in a maintenance shell?
 - A. **lslv -m hd5**
 - B. **lspv -m hd5**
 - C. **bosboot -a -d hd5**
 - D. **bootlist -m normal hd5**
2. After a power failure, the system attempts to reboot but hangs on 557. This indicates file system corruption. Which of the following actions should be taken to recover?
 - A. Restore /etc/filesystems from **mksysb**.
 - B. Execute **chfs -a size=+1** against all file systems in rootvg.
 - C. From a maintenance shell, run **lppchk -v** against all filesets installed.
 - D. From a maintenance shell, run **fsck -y** against all file systems in rootvg.

The following are additional questions created by the authors to further test your understanding of the topics.

Figure 3-7 is an exhibit pertaining to question 1.

```
init:2:initdefault:
brc::sysinit:/sbin/rc.boot 3 >/dev/console 2>&1 # Phase 3 of system
boot
powerfail::powerfail:/etc/rc.powerfail 2>&1 | alog -tboot >
/dev/console # Power Failure Detection
rc:2:wait:/etc/rc 2>&1 | alog -tboot > /dev/console # Multi-User checks
fbcheck:2:wait:/usr/sbin/fbcheck 2>&1 | alog -tboot > /dev/console #
run /etc/firstboot
srcmstr:2:respawn:/usr/sbin/srcmstr # System Resource Controller
rctcpip:2:wait:/etc/rc,tcPIP > /dev/console 2>&1 # Start TCP/IP daemons
rcnfs:2:wait:/etc/rc.nfs > /dev/console 2>&1 # Start NFS Daemons
cron:2:respawn:/usr/sbin/cron
pio:2:wait:/usr/lib/lpd/pio/etc/pioinit >/dev/null 2>&1 # pb cleanup
sqdaemon:2:wait:/usr/bin/startsrc -sqdaemon
writesrv:2:wait:/usr/bin/startsrc -swritesrv
uprintfd:2:respawn:/usr/sbin/uprintfd
logsymp:2:once:/usr/lib/ras/logsymptom # for system dumps
pmd:2:wait:/usr/bin/pmd > /dev/console 2>&1 # Start PM daemon
diagd:2:once:/usr/lpp/diagnostics/bin/diagd >/dev/console 2>&1
dt:2:wait:/etc/rc.dt
cons:0123456789:respawn:/usr/sbin/getty /dev/console
cfgmceh:2:once:/usr/lib/methods/cfgmceh >/dev/null 2>&1 # Configure
Machine Check Error Handler
infod:2:once:startsrc -s infod
browser:2:respawn:/usr/lpp/xlc/browser/pdnscd
```

Figure 3-7 Exhibit for question 1

1. After booting, NFS is not available. Based on the exhibit, what can be concluded?
 - A. etc/rc.nfs is corrupted.
 - B. The /var file system is corrupted.
 - C. The TCP/IP initialization is incorrect.
 - D. The start NFS call should read "rcnfs:1:wait:/etc/rc.nfs > /dev/console 2>&1.

2. During bootup, the system administrator notices that the system is hung at LED 553. This most commonly indicates:
 - A. A corrupted `/etc/inittab`.
 - B. The system could not complete a network boot.
 - C. The system could not vary on the root volume group.
 - D. The configuration manager could not locate a valid boot device.

3.4.1 Answers

The following answers are for the assessment quiz questions.

1. A
2. D

The following answers are for the additional quiz questions.

1. C
2. A

3.5 Exercises

The following exercises provide sample topics for self study. They will help ensure comprehension of this chapter.

1. Locate the boot devices on your systems.
2. Comment out tasks started in `/etc/inittab` and experience the error messages caused by errors generated like this.



Hardware installation and configuration management

Configuration management involves adding new devices to the system, their configuration, troubleshooting, and solutions to problems that result. The RS/6000 and pSeries systems include support for several buses, such as the Peripheral Component Interconnect (PCI), as well as new devices that are different from the ones that are supported on the microchannel-based RS/6000 systems.

AIX system configuration architecture and methodology uses information stored in the Object Data Manager (ODM) database to configure devices. The configuration of devices that do not support automatic configuration, for example, non-native ISA devices, must be performed manually. This chapter includes step-by-step procedures on how to configure devices on the PCI-based RS/6000 and pSeries servers.

4.1 Finding out about your system

RS/6000 and pSeries servers are available in a variety of models. A pSeries system can be single processor or multiprocessor. Models comply to a number of architecture specifications, such as Micro Channel, PowerPC Reference Platform (PREP), Common Hardware Reference Platform (CHRP), and RS/6000 Platform Architecture (RPA).

The hardware platform type is an abstraction that allows machines to be grouped according to fundamental configuration characteristics, such as the number of processors and/or I/O bus structure. Machines with different hardware platform types will have basic differences in the way their devices are dynamically configured at boot time. Currently available hardware platforms, which are able to be differentiated by software, in RS/6000 and pSeries families, are:

- rs6k** Micro Channel-based uni-processor models
- rs6ksmp** Micro Channel-based symmetric multiprocessor models
- rspc** ISA-bus models
- chrp** PCI-bus models

In order to determine the hardware platform type on your machine, enter the following command:

```
bootinfo -p
```

This will return rs6k, rs6ksmp, rspc, or chrp as output.

You can also use the **1scfg** command to determine the type of hardware platform you have. The **1scfg** command provides output similar to Figure 4-1 on page 49.

INSTALLED RESOURCE LIST

The following resources are installed on the machine.
+/- = Added or deleted from Resource List.
* = Diagnostic support not available.

Model Architecture: chrp
Model Implementation: Multiple Processor, PCI bus

+ sysplanar0	00-00	System Planar
+ mem0	00-00	Memory
+ proc0	00-00	Processor
+ L2cache0	00-00	L2 Cache
* pmc0	00-00	Power Management Controller
+ proc1	00-01	Processor
+ proc2	00-02	Processor
+ proc3	00-03	Processor
* pci0	00-f8400000	PCI Bus
* isa0	10-78	ISA Bus
+ fda0	01-D1	Standard I/O Diskette Adapter
+ fd0	01-D1-00-00	Diskette Drive
* siokma0	01-K1	Keyboard/Mouse Adapter
+ sioka0	01-K1-00	Keyboard Adapter

Figure 4-1 Finding out the hardware platform type

It is important to know what kind of system you have and what its capabilities are if you decide to use your system for special purposes, such as a Web server, a CATIA workstation, or for running heavy database applications.

Web servers require fast networking connections, CATIA workstations require a powerful graphics adapter, and database applications require large responsive disk drives.

You can determine a specific subset of the configuration of your systems using the following commands:

- lscfg** Displays configuration, diagnostic, and vital product data (VPD) information about the system.
- lsdev** Displays devices in the system and their characteristics.
- lsattr** Displays attribute characteristics and possible values of attributes for devices in the system.

There are also device-specific and class-specific commands that you can use to find out detailed information about your system. A sample of these commands include **bindprocessor**, **ifconfig**, **lspv**, and **lslpp**.

4.1.1 Using the lscfg command

You can use the **lscfg** command to display summary or detailed data about devices. If you run the **lscfg** command without any flags, it displays the name, location, and description of each device found in the current Customized VPD object class that is a child device of the sys0 object. Information on a specific device can be displayed with the **-l** flag.

You can also use the **lscfg** command to display vital product data (VPD), such as part numbers, serial numbers, and engineering change levels from either the Customized VPD object class or platform specific areas. Not all devices contain VPD data.

The general command syntax of the **lscfg** command is as follows:

```
lscfg [ -v p ] [ -l Name ]
```

Some of the most commonly used flags with the **lscfg** command are given in Table 4-1.

Table 4-1 *lscfg* command flags

Flag	Description
-l <i>Name</i>	Displays device information for the named device.
-p	Displays the platform-specific device information. This flag only applies to AIX Version 4.2.1 or later.
-v	Displays the VPD found in the Customized VPD object class. Also, on AIX Version 4.2.1 or later, displays platform specific VPD when used with the -p flag.

4.1.2 Using the lsdev command

You can use the **lsdev** command to display information about devices in the device configuration database. You can use this command to display information from either the Customized Devices object class in ODM using the **-C** flag or the Predefined Devices object class in ODM using the **-P** flag.

The general command syntax of the **lsdev** command is as follows:

```
lsdev -C [ -c Class ] [ -s Subclass ] [ -t Type ] [ -f File ]  
[ -F Format | -r ColumnName ] [ -h ] [ -H ] [ -l Name ] [ -S State ]  
lsdev -P [ -c Class ] [ -s Subclass ] [ -t Type ] [ -f File ]  
[ -F Format | -r ColumnName ] [ -h ] [ -H ]
```

Some of the most commonly used flags with the **lsdev** command are given in Table 4-2.

Table 4-2 *lsdev* command flags

Flag	Description
-C	Lists information about a device that is in the Customized Devices object class. The default information displayed is name, status, location, and description. This flag cannot be used with the -P flag.
-c <i>Class</i>	Specifies a device class name. This flag can be used to restrict output to devices in a specified class.
-H	Displays headers above the column output.
-h	Displays the command usage message.
-P	Lists information about a device that is in the Predefined Devices object class. The default information displayed is class, type, subclass, and description. This flag cannot be used with the -C, -l, or -S flags.
-S <i>State</i>	Lists all devices in a specified state as named by the State parameter.

4.1.3 Using the lsattr command

You can use the **lsattr** command to display information about the attributes of a given device or kind of device. If you do not specify the device's logical name (-l *Name*), you must use a combination of one or all of the -c *Class*, -s *Subclass*, and -t *Type* flags to uniquely identify the predefined device. The general syntax of the **lsattr** command is as follows:

```
lsattr { -D [ -O ] | -E [ -O ] | -F Format } -l Name [ -a Attribute ]
... [ -f File ] [ -h ] [ -H ]
lsattr { -D [ -O ] | -F Format } { [ -c Class ] [ -s Subclass ] [ -t Type ] }
[ -a Attribute ] ... [ -f File ] [ -h ] [ -H ]
lsattr -R { -l Name | [ -c Class ] [ -s Subclass ] [ -t Type ] } -a Attribute
[ -f File ] [ -h ] [ -H ]
```

The flags commonly used with the **lsattr** command are given in Table 4-3.

Table 4-3 *lsattr* command flags

Flag	Description
-D	Displays the attribute names, default values, descriptions, and user-settable flag values for a specific device when not used with the -O flag. The -D flag displays only the attribute name and default value in colon format when used with the -O flag.

Flag	Description
-E	Displays the attribute names, current values, descriptions, and user-settable flag values for a specific device when not used with the -O flag. The -E flag only displays the attribute name and current value in colon format when used with the -O flag. This flag cannot be used with the -c, -D, -F, -R, -s, or -t flags.
-F <i>Format</i>	Displays the output in a user-specified format.
-a <i>Attribute</i>	Displays information for the specified attributes of a specific device or kind of device.
-c <i>Class</i>	Specifies a device class name. This flag cannot be used with the -E or -l flags.
-f <i>File</i>	Reads the needed flags from the File parameter.
-H	Displays headers above the column output. To use the -H flag with either the -O or the -R flags is meaningless; the -O or -R flag prevails.
-l <i>Name</i>	Specifies the device logical name in the Customized Devices object class whose attribute names or values are to be displayed.
-O	Displays all attribute names separated by colons and, on the second line, displays all the corresponding attribute values separated by colons.
-R	<p>Displays the legal values for an attribute name. The -R flag cannot be used with the -D, -E, -F, and -O flags, but can be used with any combination of the -c, -s, and -t flags that uniquely identifies a device from the Predefined Devices object class or with the -l flag. The -R flag displays the list attribute values in a vertical column as follows:</p> <p>Value1 Value2 . . ValueN</p> <p>The -R flag displays the range attribute values as x...n(+i) where <i>x</i> is the start of the range, <i>n</i> is the end of the range, and <i>i</i> is the increment.</p>
-s <i>Subclass</i>	Specifies a device subclass name. This flag can be used to restrict the output to devices for a specified subclass. This flag cannot be used with the -E or -l flags.
-t <i>Type</i>	Specifies a device type name. This flag can be used to restrict the output to that of devices of a specified class. This flag cannot be used with the -E or -l flag.

When displaying the effective values of the attributes for a customized device, the information is obtained from the Configuration Database, not the device. Generally, the database values reflect how the device is configured unless it is reconfigured with the **chdev** command using the **-P** or **-T** flag. If this has occurred, the information displayed by the **lsattr** command might not correctly indicate the current device configuration until after the next system boot.

If you use the **-D** or **-E** flags, the output defaults to the values for the attribute's name, value, description, and user-settable strings unless also used with the **-O** flag. The **-O** flag displays the names of all attributes specified separated by colons. On the next line, the **-O** flag displays all the corresponding attribute values separated by colons. The **-H** flag can be used with either the **-D**, **-E**, or **-F** flags to display headers above the column names. You can define the format of the output with a user-specified format where the format parameter is a quoted list of column names separated by non-alphanumeric characters or white space using the **-F** *Format* flag.

4.1.4 Examples

In order to find out the number of processors you have, use one of the following commands:

- ▶ **lscfg | grep proc | wc -l**
- ▶ **lsdev -Cc processor | wc -l**
- ▶ **bindprocessor -q**

The **-q** flag of the **bindprocessor** command lists the available logical processor numbers.

To learn more about a particular processor, use the following **lsattr** command:

```
# lsattr -EH -l proc0
attribute value      description      user_settable
state      enable      Processor state False
type      PowerPC_604 Processor type  False
frequency 332000000  Processor Speed False
```

To find out how much memory is installed, use the following **lsattr** command:

```
# lsattr -E1 sys0 | grep realmem
realmem      524288      Amount of usable physical memory in Kbytes False
```

To find out if device driver software for the 14100401 class of adapters (gigabit Ethernet) is installed, use the **lslpp** command as follows:

```
# lslpp -l | grep 14100401
devices.pci.14100401.diag 5.1.0.0 COMMITTED Gigabit Ethernet-SX PCI
```

```
devices.pci.14100401.rte 5.1.0.0 COMMITTED Gigabit Ethernet-SX PCI
devices.pci.14100401.rte 5.1.0.0 COMMITTED Gigabit Ethernet-SX PCI
```

To find out if adapter ent1 supports the jumbo frames transmission setting, use the **lsattr** command as follows:

```
# lsattr -EHl ent1 -a jumbo_frames
attribute      value description          user_settable

jumbo_frames no      Transmit jumbo frames True
```

This example shows that ent1 supports jumbo frames but the option is currently not enabled.

4.2 Adapter and device configuration

PCI-based RS/6000 and pSeries servers support attachment of devices using the following bus types:

- ▶ SCSI
- ▶ PCI
- ▶ ISA

Devices on PCI-based RS/6000 or pSeries systems might be of two types: native devices, such as the integrated SCSI controller and the serial controller or attached (non-native) devices, such as the supported PCI or ISA adapters.

The device information required to configure the integrated devices is contained in the firmware and is passed to the operating system through the residual data written to NVRAM. Thus, integrated devices are configured automatically to AIX after system reboot. Attached PCI devices and adapters are configured automatically at system start-up, provided required device drivers are installed on the system. However, ISA adapters have to be configured manually.

4.3 Displaying installed devices

In order to display devices that are either supported or defined on your system, you can either use the **lsdev** command or use the SMIT fast path as follows:

1. **smitty lsdev**

A screen similar to the one shown in Figure 4-2 on page 55 will be shown.

```

                                List Devices

Move cursor to desired item and press Enter.

List All Supported Devices
List All Defined Devices
Show Characteristics of a Supported Device
Show Characteristics of a Defined Device

F1=Help           F2=Refresh       F3=Cancel       F8=Image
F9=Shell         F10=Exit        Enter=Do

```

Figure 4-2 List Devices SMIT screen

2. Select List All Defined Devices (the `l sdev -C` command is run in the background).
3. Press Enter.

A list of all the devices that are either in the Defined or in the Available state are listed. An output similar to Figure 4-3 on page 56 is shown.

```

COMMAND STATUS
Command: OK          stdout: yes          stderr: no
Before command completion, additional instructions may appear below.

[TOP]
io0      Defined          Asynchronous I/O
bus0     Available 00-00  PCI Bus
bus1     Available 04-A0  ISA Bus
cd0      Available 04-B0-00-3,0 SCSI Multimedia CD-ROM Drive
copied   Defined          Logical volume
en0      Available          Standard Ethernet Network Interface
ent0     Available 04-D0  IBM PCI Ethernet Adapter (22100020)
et0      Defined          IEEE 802.3 Ethernet Network Interface
fd0      Available 01-C0-00-00 Diskette Drive
fda0     Available 01-C0  Standard I/O Diskette Adapter
fslv00   Defined          Logical volume
gxme0    Available          Graphics Data Transfer Assist Subsystem
[MORE...59]

F1=Help          F2=Refresh          F3=Cancel          F6=Command
F8=Image         F9=Shell            F10=Exit           /=Find
n=Find Next

```

Figure 4-3 smitty lsdev output

Note: The predefined ODM database contains default characteristics for devices. These devices may not exist on the system, but have device support loaded. For example, if a tape drive was detected at the installation time, there will be a number of types of tape drives in the list, but if, on the other hand, no multiprotocol adapter was found, no such support will be added to the predefined database. Use the `lsdev -P` command to see a list of supported devices.

4.4 Configuring new devices

Depending on the kind of device you plan to configure, you will go through a different sequence of configuration steps. PCI device configuration and ISA device configuration differs considerably. The following sections discuss the various configuration approaches.

4.4.1 PCI device configuration

If you add a new PCI or SCSI device to your system, the system will automatically configure the device (provided no conflict is found in case of SCSI devices, for example, the same SCSI ID for two different SCSI devices) at system restart or by using the `cfgmgr` command, provided the required device drivers are installed.

When using PCI adapters, the slot number is as important as it is in microchannel devices. If you change the adapter from slot A to slot B, the original adapter information for slot A will be kept in the defined state, and a new definition will be created for slot B and a new device will be configured.

Hot-plug PCI slots and adapters

Newer models of RS/6000 and IBM @server pSeries servers have PCI slots that are hot-plug enabled, which allows most PCI adapters to be removed, added, or replaced without powering down the system. This function enhances system availability and serviceability.

The function of hot-plug is not only provided by the PCI slot, but also by the function of the adapter. Most adapters are hot-plug, but some are not. Be aware that some adapters must not be removed when the system is running, such as the adapter with the operating system disks connected to it or the adapter that provides the system console. Refer to the *PCI Adapter Placement Reference Guide*, SA38-0538 for further information.

To manage hot-plug PCI adapters, it is important to turn off slot power before adding, removing, or replacing the adapter, which is done by the operating system. The following methods can be used to manage hot-plug PCI slots in AIX:

- ▶ Command line:
 - `lsslot`: List slots and their characteristics
 - `drslot`: Dynamically reconfigures slots
- ▶ SMIT
- ▶ Web-based System Manager

To add a hot-plug PCI adapter, use the `drslot` command to set the slot first into the Identify state to verify the right slot was selected. After pressing Enter, the slot changes its state to the Action state. Then, add the adapter to the system. When finished, press Enter again to turn on the slot power. The adapter is now integrated into the system and can be configured using AIX `cfgmgr`.

Before adapters can be removed, they must be deconfigured in AIX. The adapter must be in a defined state or removed from the ODM.

4.4.2 ISA device configuration

Devices like PCI or Micro Channel integrated devices, such as SCSI controllers, and integrated ISA devices, such as keyboard, mouse, and audio, are self configuring. However non-integrated ISA devices, such as adapters plugged into ISA slots, should be configured manually.

In the case of ISA devices, five resources should be managed before your system can run smoothly. These five resources are:

- ▶ Bus I/O ranges
- ▶ Bus memory address ranges
- ▶ System interrupts (IRQ)
- ▶ Direct Memory Access (DMA) channels
- ▶ Bus memory DMA address ranges

These settings must be different for all ISA adapters to avoid conflicts; otherwise, you will not be able to use the adapter. If these resources cannot be dynamically set, they must be set by adjusting switches or jumpers on the adapter. In case the adapter does not have switches, you may need a System Management Services (SMS) disk to configure the adapter.

The first step is to install the device drivers for ISA adapters, if you have not already done so. In order to check whether device support for ISA has been installed, use the **lsdev** command, as shown in Figure 4-4.

```
# lsdev -Pc adapter -s isa
adapter tokenring isa IBM 16/4 PowerPC Token-Ring Adapter (isa)
adapter portmaster isa Multiport Model 2 Adapter
adapter ethernet isa IBM ISA Ethernet Adapter
adapter articmpx isa X.25 CoProcessor/1 Adapter
adapter pcxr isa IBM 8-Port Async, EIA-232 (ISA)
adapter pc8s isa IBM 8-Port EIA-232/RS-422A (ISA) Adapter
adapter cxia isa IBM 128-Port Async, EIA-232 (ISA)
```

Figure 4-4 Checking ISA device support

This provides you with a list of all the adapters that have been defined in the predefined ODM database. If you see a blank display when you run this command, you need to install the support for ISA adapters.

Installing device drivers for ISA devices

In order to install device drivers support for ISA devices, use the SMIT fast path `smitty devinst_isa` and follow these steps:

1. On the Install Additional Device Software screen, enter the device or directory where the ISA device software is located.
2. Select the `devices.isa` fileset in the SOFTWARE to install field. By default, it is already entered in the field.
3. The device support for ISA devices will be installed once the command finishes execution.

You could also use the SMIT fast path `smitty devinst`. This command allows you to install any type of additional device software, and does not preselect a specific device type. You have to specify the filesets to install using the SOFTWARE to install field.

Recording settings of already configured ISA adapters

ISA devices may not work properly if there are clashes in their settings, such as IRQ or bus I/O ranges. It is best to note all the settings of any ISA devices already present in your system. In order to do that, issue the following command:

```
lsdev -Cc adapter -s isa
```

This command will show you all the ISA devices that are already configured with your system. The output of this command will be similar to what is shown in Figure 4-5.

```
# lsdev -Cc adapter -s isa
cxia0 Available 01-01 IBM 128-Port Async, EIA-232 (ISA)
apm0 Available 01-02 4-Port Selectable Multiport Model 2 Adapter
# █
```

Figure 4-5 Finding out currently defined devices

Once you have the names of the ISA devices that are configured on your system, use either the `lsresource` command or the `lsattr` command to get the current settings of your ISA devices. The `lsresource` command writes a list of assigned bus resources to standard out, or determines if the bus resources for devices resolve. On the command line, enter:

```
lsresource -l apm0
```

An output similar to Figure 4-6 will be shown.

```
# lsresource -l apm0
TYPE DEVICE ATTRIBUTE S G CURRENT
B apm0 bus_mem_addr 0x000e2000 - 0x000e3fff
O apm0 bus_io_addr 0x000006a0 - 0x000006a6
N apm0 bus_intr_lvl 7 (A0)
# █
```

Figure 4-6 Finding out current resource settings using *lsresource*

Use the **lsattr** command to find out the current settings of all of your ISA devices. The **lsattr** command displays information about the attributes of a given device or kind of device. Use the **lsattr** command, as shown in Figure 4-7.

```
# lsattr -l apm0 -E -H
attribute value description user_settable
bus_intr_lvl 7 True
bus_io_addr 0x6A0 True
bus_mem_addr 0xE2000 True
window_size 0x2000 Window Size False
intr_priority 2 False
# █
```

Figure 4-7 Finding out current resource settings using *lsattr*

Once you have the current values for the installed devices, refer to your device documentation and select the recommended values for the device to work properly. Next, configure the adapter using the SMIT fast path **smitty isa**.

A screen similar to Figure 4-8 on page 61 will be shown.

```

ISA Adapters

Move cursor to desired item and press Enter.

Install ISA Adapter Software
Add an ISA Adapter
Change / Show Characteristics of an ISA Adapter
Remove an ISA Adapter
List all Defined ISA Adapters
List all Supported ISA Adapters
Configure a Defined ISA Adapter

F1=Help      F2=Refresh   F3=Cancel    F8=Image
F9=Shell     F10=Exit    Enter=Do

```

Figure 4-8 smitty isa command

Follow these steps:

1. Select Add an ISA Adapter and press Enter, as in Figure 4-9.

```

ISA Adapters

Move cursor to desired item and press Enter.

Install ISA Adapter Software
Add an ISA Adapter
Change / Show Characteristics of an ISA Adapter

Add an ISA Adapter

Move cursor to desired item and press Enter.

tokenring isa IBM 16/4 PowerPC Token-Ring Adapter (isa)
portmaster isa Multiport Model 2 Adapter
ethernet isa IBM ISA Ethernet Adapter
articmpx isa X.25 CoProcessor/1 Adapter
pcxr isa IBM 8-Port Async, EIA-232 (ISA)
pc8s isa IBM 8-Port EIA-232/RS-422A (ISA) Adapter
cxia isa IBM 128-Port Async, EIA-232 (ISA)

F1=Help      F2=Refresh   F3=Cancel    F8=Image
F8=Image     F10=Exit    Enter=Do
F1           /=Find      n=Find Next
F9

```

Figure 4-9 Add an ISA Adapter screen

Note: You can try to configure the adapter without actually installing it, because some adapters may have DIP switches that you may have to set in order to get the right settings. If you try to configure an adapter, for example, an X.25 adapter that has not been installed, and there are no parameter conflicts, you will be given a message as follows:

```
ampx0 Defined
Method error (/usr/lib/methods/cfgclx):
0514-047 Cannot access a device.
[busquery]ioctl(): Function not implemented
ampx0 deleted
```

This shows that you have configured the adapter correctly, except that you still must actually install it.

2. Select the adapter you want to add (assume that you are trying to configure a Multiport Model 2 adapter) and press Enter. A screen similar to Figure 4-10 is shown.

Add a Multiport Model 2 Adapter

Type or select values in entry fields.
Press Enter AFTER making all desired changes.

Description	[Entry Fields]	
Parent Device	Multiport Model 2 Adap>	
<u>ISA Interrupt Level</u>	bus1	
Bus IO Address	[7]	+#
Bus Memory Address	[0x6A0]	+X
Define device only, do not configure	[0xE2000]	+X
	no	+

F1=Help	F2=Refresh	F3=Cancel	F4=List
F5=Reset	F6=Command	F7=Edit	F8=Image
F9=Shell	F10=Exit	Enter=Do	

Figure 4-10 Add a Multiport Model 2 Adapter screen

3. Change any input fields required and press Enter once you are done. If your given values conflict with some other ISA device, a message similar to Figure 4-11 on page 63 will be shown.

```

COMMAND STATUS

Command: failed          stdout: yes          stderr: no

Before command completion, additional instructions may appear below.

apm1 Defined
lsresource : The attribute(s) for some device(s) in the system
could not be resolved. To resolve conflicts, attribute(s) need to be
modified. A suggested value for each attribute is provided.

DEVICE ATTRIBUTE      CURRENT SUGGESTED DESCRIPTION
apm1 bus_intr_lvl 7      9
apm1 bus_io_addr  0x6a0  0xaa0
apm1 bus_mem_addr 0xe2000 0xe4000
apm1 deleted

F1=Help          F2=Refresh          F3=Cancel          F6=Command
F8=Image         F9=Shell            F10=Exit           /=Find
n=Find Next

```

Figure 4-11 ISA adapter resource conflict

4. Go back to the previous screen and correct the values accordingly.

You have successfully configured an ISA adapter.

4.4.3 128-port asynchronous adapter considerations

The 128-port asynchronous adapter subsystem meets the multiuser requirements for workstations in the open system environment. The subsystem can support up to 128 devices and offers higher speeds to the end user. It is an intelligent adapter with the ability to offload line protocol processing from the operating system.

The 128-port product consists of an adapter card, up to eight remote asynchronous node (RAN) units, each supporting 16 devices, for a total of 128 devices per adapter. The 128-port asynchronous adapter card resides in the system unit, and is connected by either EIA 422, direct cabling, EIA 422/EIA 232 synchronous modems, or Data Service Unit/Channel Service Units (DSU/CSUs) to the RAN. The number of 128-port asynchronous adapters that can be installed is dependent on the number of slots available in the system with a hardware limit of seven adapters per bus (an optional I/O bus can provide eight additional slots).

Each 128-port asynchronous adapter has two synchronous lines. Up to four RANs can be connected to a single synchronous line in a daisy-chain fashion. That is, the first RAN is connected to one of the adapter's lines, the second RAN is connected to the first RAN, and so on (up to four RANs).

The RANs can be attached to the 128-port adapter with a direct local connection, a synchronous modem connection, or a combination of the two. Figure 4-12 shows some of the possible connection types.

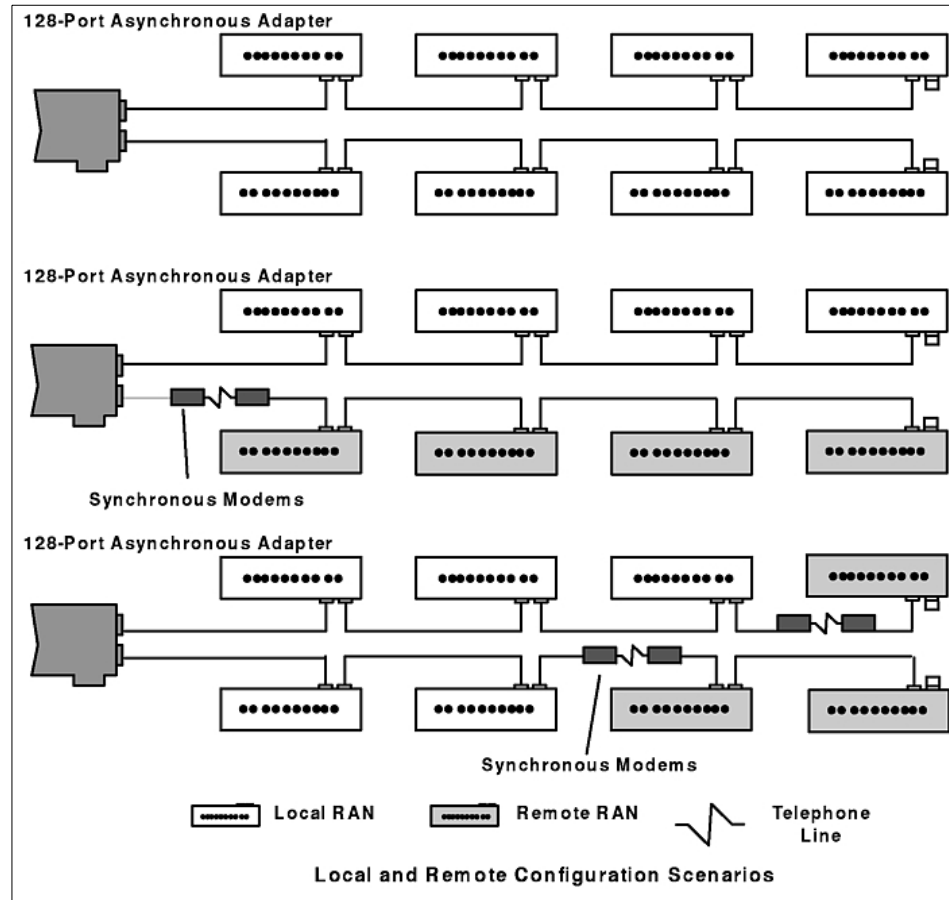

Figure 4-12 128-port asynchronous adapter connection combinations

The adapter identifies RANs by their node numbers. Each RAN in a daisy chain must have a unique node number (1n through 4n), which must be set during installation. The node numbers must be assigned in ascending order with the lowest number assigned to the RAN closest to the adapter. You can skip node numbers (to facilitate insertion of additional RANs at a later date), as long as the ascending sequence is maintained. Figure 4-13 summarizes the node number assignment.

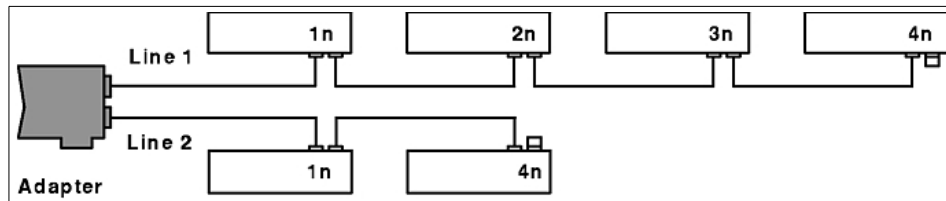

Figure 4-13 RAN numbering

The remote asynchronous node (RAN) is equipped with:

- ▶ Ten LED indicators
- ▶ Two-digit, seven-segment LED display
- ▶ Two push buttons

The RAN front panel display has several different display modes, as indicated by the two-digit, seven-segment display. Some of the RAN front panel display modes are shown in Table 4-4.

Table 4-4 RAN activity codes

Mode	Mode name	Description
P1	POST Complete	P1 appears on the seven-segment display. Power-on self-test is complete, relays are open and waiting for connection.
P2	Ping Packet Receive	P2 indicates that the operating system successfully transmitted a ping packet to RAN.
AC	Activity	AC appears on the seven-segment display. The 10 LEDs turn on sequentially from left to right. The speed of this <i>chase light</i> display increases with the overall activity level of the RAN.
En	Error Node	En appears on the seven-segment display. It indicates that a valid ping packet was received but the node number in EEPROM is incorrect.

In the case of duplicate node numbers, the RAN farthest from the host adapter will display En, instead of AC, when the system is started.

The configuration for a 128-port asynchronous adapter follows the same sequence of steps for a normal ISA adapter; however, you can customize your adapter port-wise. That is, you can set different characteristics for your lines and the corresponding nodes.

4.5 Adding a TTY device

In order to add a TTY, use the following procedure:

1. Run **smitty tty** and select Add a TTY or run **smitty maktty**.
2. The system will ask you for the TTY type and the parent adapter. Select both and press Enter.

A screen similar to Figure 4-14 will be shown.

```

                                     Add a TTY

Type or select values in entry fields.
Press Enter AFTER making all desired changes.

[TOP]                                     [Entry Fields]
TTY type                                   tty
TTY interface                             rs232
Description                               Asynchronous Terminal
Parent adapter                             sa0
* PORT number                             [0] +
Enable LOGIN                              disable +
BAUD rate                                  [9600] +
PARITY                                     [none] +
BITS per character                         [8] +
Number of STOP BITS                       [1] +
TIME before advancing to next port setting [0] +#
TERMINAL type                             [dumb]
FLOW CONTROL to be used                   [xon] +
[MORE...31]

F1=Help      F2=Refresh      F3=Cancel      F4=List
F5=Reset     F6=Command     F7=Edit       F8=Image
F9=Shell     F10=Exit         Enter=Do
```

Figure 4-14 Add a TTY screen

3. Select the port number you want this TTY to be added to in the PORT number field. For RANs, follow the location code rules to select the appropriate port number.
4. Change the TERMINAL Type field to the type of terminal you are using. This parameter is very important, because you might not be able to use all the

keys on your terminal if this parameter is set incorrectly. The TERM environment variable stores this setting. You can change the terminal emulation setting by using your TERM environment variable and using the **export** command to store the terminal emulation you want to use. For example, in order to use ibm3151 terminal emulation, use the command:

```
export $TERM=ibm3151.
```

5. Set the line speed and the kind of communication (1/8/N or 1/7/E) for your terminal and press Enter.

This will create a device special file in the /dev directory. Add an entry to the /etc/inittab file in order to run the getty process on your terminal, so that your terminal is available at system startup. It also adds another entry to the customized ODM (CuDv) database for the terminal you have just added.

You can also add a TTY directly on the command line. In order to add an ibm3151 RS232 terminal using adapter sa0 and port s1 with login enabled, use the following command:

```
mkdev -c tty -t tty -s rs232 -p sa0 -w s1 -a login=enable -a term=ibm3151
```

You can remove a terminal by using the command:

```
rmdev -l <tty name> -d
```

Where <tty name> can be determined by using the command **tty** or by listing all the TTYs and then selecting the TTY you want to remove.

You cannot remove a device that is in use. If the device is busy, you will receive an error message, as shown in the following example:

```
# rmdev -l tty0 -d
Method error (/etc/methods/ucfgdevice):
    0514-062 Cannot perform the requested function because the
        specified device is busy.
```

4.6 Adding a tape drive

Generally, a tape drive attached on a SCSI interface is automatically configured once you run the **cfgmgr** command or at the system start-up. There may be occasions when you want to add a new tape drive to your system. In order to add a tape drive, use the SMIT fast path **smitty tape** and follows these steps:

1. Select Add a Tape Drive.

A screen similar to Figure 4-15 on page 68 will be shown.

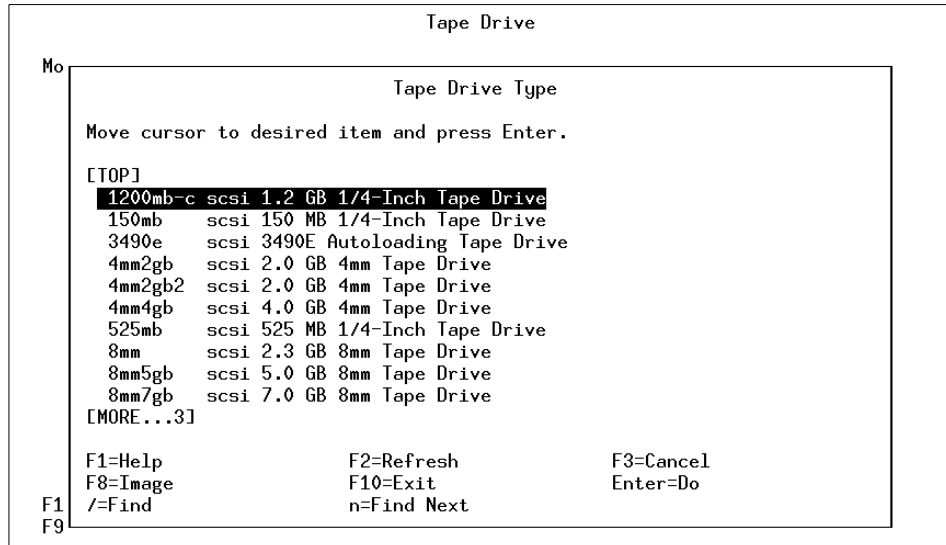

Figure 4-15 Selecting the new tape drive type

2. Choose the type of tape drive that you want to add and press Enter.
3. Select the parent adapter on which the tape will be attached and press Enter. A screen similar to Figure 4-16 will be shown.

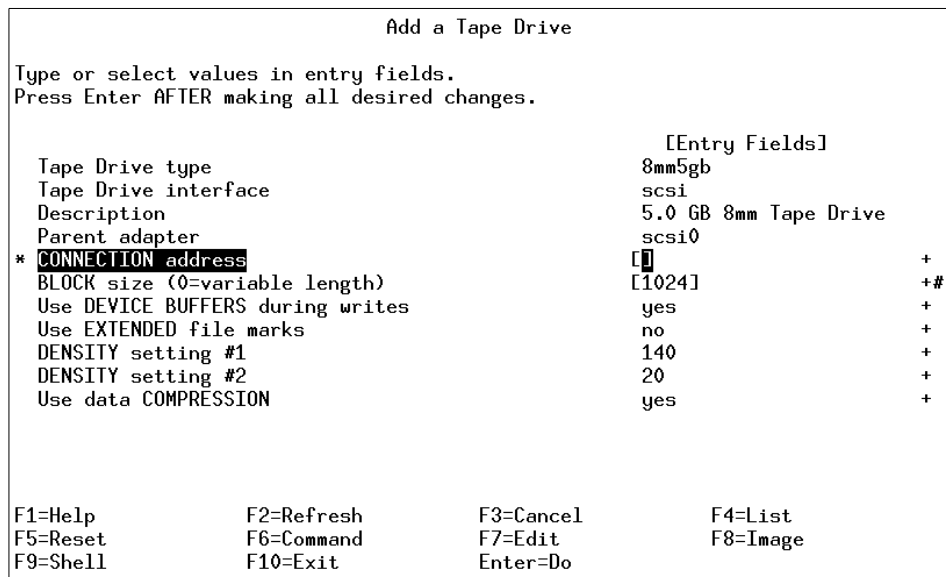

Figure 4-16 Setting characteristics of a new tape drive device

4. Enter the SCSI address in the CONNECTION address field.
5. The BLOCK size parameter is very important, since a tape is a block device. By default, the block size is 1024 bytes. If you save a file on a tape with block size of 512 bytes, you will not be able to read it with a tape drive with a block size equal to 1024 bytes on older AIX releases. It is recommended that you keep the block size 0, which is a variable block size. A variable block size automatically finds out the block size of your media and then reads the media accordingly. If the block sizes of the media and the tape drive are different, you can encounter an error similar to this when you try to read something from a tape:

```
restore: 0511-160 Cannot read the backup media
/dev/rmt0.1:There is an input or output error
```

6. Press Enter to complete the process.

Alternatively, you can add a new tape drive on the command line. For example, in order to create a device for an 8 mm tape attached on adapter scsi0 using 5 as the SCSI address, use the command:

```
mkdev -c tape -t '8mm' -s 'scsi' -p 'scsi0' -w '5,0' -a block_size='0'
```

4.7 Quiz

The following certification assessment question helps verify your understanding of the topics discussed in this chapter.

1. Given a device ID 14100401 for a Gigabit Ethernet adapter, which of the following commands should be used to determine the driver in use for this adapter?
 - A. `lsdev -Cc if`
 - B. `lsattr -E -l <device ID>`
 - C. `lslpp -w | grep ethernet`
 - D. `lslpp -l | grep <device ID>`

The following are additional questions created by the authors to further test your understanding of the topics.

1. What command can be run from the command line to permanently remove tty5 from the system?
 - A. `rmdev -l tty5`
 - B. `rmdev -dl tty5`
 - C. `mkdev -dl tty5`
 - D. `odmdelete -q "name=tty5" -o PdAt`
2. A client is setting up an 128-port asynchronous adapter with two remote RANs. The two SA devices (RANs) are not available to the system. In addition, node 1's LEDs is displaying AC and node 2's LEDs is displaying En. What is the most likely cause of the problem?
 - A. There are 2 RANs with the same node number.
 - B. The adapter itself is not being recognized by the system.
 - C. The serial line in SMIT is defined with the wrong speed.
 - D. The serial line in SMIT is defined with the wrong cable type.

4.7.1 Answers

The following answers are for the assessment quiz questions.

1. D

The following answers are for the additional quiz questions.

1. B
2. A

4.8 Exercises

The following exercises provide sample topics for self study. They will help ensure comprehension of this chapter.

1. You have just purchased a new pSeries. Find out the type of your pSeries system using the `bootinfo` command. Also, find out the number of processors you have.
2. You need to add a new ISA adapter to your system. Using the guidelines in the chapter, configure the ISA adapter correctly in your system.
3. Remove a TTY permanently from your system; also configure all of your TTYs to have `ibm3151` as the default emulation setting.
4. Familiarize yourself with the various adapters available to pSeries.



Object Data Manager

The ODM has many purposes. Its primary functions are to maintain the RISC System/6000 configuration, associated devices, and the vital product database. In addition, it provides a more robust, secure, and sharable resource than the ASCII files previously used in AIX.

System data managed by the ODM includes:

- ▶ Device configuration information
- ▶ Display information for SMIT (menus, selectors, and dialogs)
- ▶ Vital product data for installation and update procedures
- ▶ Communications configuration information
- ▶ System resource information

Most system object classes and objects are stored in the `/usr/lib/objrepos` directory; however, ODM information is stored in three directories as follows:

- ▶ `/usr/lib/objrepos`
- ▶ `/usr/share/lib/objrepos`
- ▶ `/etc/objrepos`

The basic components of the ODM are object classes and objects. To manage object classes and objects, you use the ODM commands and subroutines. Specifically, you use the create and add features of these interfaces to build object classes and objects for storage and management of your own data.

A summary of the ODM concepts is provided in Table 5-1.

Table 5-1 ODM concepts

Item	Definition	Similar to	Similar to
Object class	A stored collection of objects with the same definition.	An array of C-Language structures.	A file with fixed format records.
ODM object	A member of a defined ODM object class. An entity that requires management and storage of data.	An element of an array structure.	One of the fixed format records.
ODM database	A stored collection of ODM object classes.	A collection of structure arrays.	A directory of files.

An object class comprises one or more descriptors. Values are associated with the descriptors of an object when the object is added to an object class. The descriptors of an object and their associated values can be located and changed with the ODM facilities.

In the area of device configuration, the ODM contains information about all configured physical volumes, volume groups, and logical volumes. This information mirrors the information found in the VGDA. The process of importing a VGDA, for example, involves copying the VGDA data for the imported volume group into the ODM. When a volume group is exported, the data held in the ODM about that volume group is removed from the ODM database.

5.1 ODM commands

You can create, add, change, retrieve, display, and delete objects and object classes with ODM. ODM commands are entered on the command line.

Note: ODM commands should be used only when traditional methods of system maintenance, such as SMIT, are ineffective. For a beginning system administrator, it is recommended that you perform additional reading and exercises before using these commands. Incorrect use of these commands may result in a disabled system. The ODM commands are described here for introductory purposes.

The ODM commands are:

odmadd	Adds objects to an object class. The odmadd command takes an ASCII stanza file as input and populates object classes with objects found in the stanza file.
odmchange	Changes specific objects in a specified object class.
odmcreate	Creates empty object classes. The odmcreate command takes an ASCII file describing object classes as input and produces C language .h and .c files to be used by the application accessing objects in those object classes.
odmdelete	Removes objects from an object class.
odmdrop	Removes an entire object class.
odmget	Retrieves objects from object classes and puts the object information into odmadd command format.
odmshow	Displays the description of an object class. The odmshow command takes an object class name as input and puts the object class information into odmcreate command format.

5.2 Example of an object class for an ODM database

The following is an example of the object class definition for the Customized Device Database (CuDv):

```
# odmshow CuDv
class CuDv {
    char name[16];           /* offset: 0xc ( 12) */
    short status;          /* offset: 0x1c ( 28) */
    short chgstatus;       /* offset: 0x1e ( 30) */
    char ddins[16];        /* offset: 0x20 ( 32) */
}
```

```

char location[16];           /* offset: 0x30 ( 48) */
char parent[16];           /* offset: 0x40 ( 64) */
char connwhere[16];        /* offset: 0x50 ( 80) */
link PdDv PdDv uniquetype PdDvLn[48]; /* offset: 0x60 ( 96) */
};
/*
descriptors:      8
structure size:   0x98 (152) bytes
data offset:     0x20001cd8
population:      50 objects (50 active, 0 deleted)
*/

```

5.3 Quiz

The following certification assessment questions help verify your understanding of the topics discussed in this chapter.

1. A system administrator wants to examine the ODM's Predefined Device Database (PdDv) on a H70 server. He uses the **odmget** command to query the database, which pulls information from several sections of the system. Which of the following is an area that does not contain the ODM?
 - A. /etc/objrepos
 - B. /dev/objrepos
 - C. /usr/lib/objrepos
 - D. /usr/share/lib/objrepos

The following are additional questions created by the authors to further test your understanding of the topics.

1. A system administrator wishes to determine if a newly configured tape drive is correctly added to the ODM database. Which command would the administrator use?
 - A. **odmshow**
 - B. **odmadd**
 - C. **odmget**
 - D. **odmcreate**

2. The ODM is located in:
 - A. /etc/objrepos
 - B. /usr/lib/objrepos
 - C. /usr/share/lib/objrepos
 - D. All of the above

5.3.1 Answers

The following answers are for the assessment quiz questions.

1. B

The following answers are for the additional quiz questions.

1. C
2. D

5.4 Exercises

The following exercises provide sample topics for self study. They will help ensure comprehension of this chapter.

1. List the uses of the ODM.
2. Using the correct ODM facility, determine the format of the Predefined Device Database (PdDv).



Storage management, LVM, and file systems

In this chapter, storage management, Logical Volume Management (LVM), and file system support issues are covered. The basic tasks that require understanding are broken down into separate sections.

6.1 Logical volume storage concepts

The five basic logical storage concepts are physical volumes, volume groups, physical partitions, logical volumes, and logical partitions. The relationships among these concepts is provided in Figure 6-1.

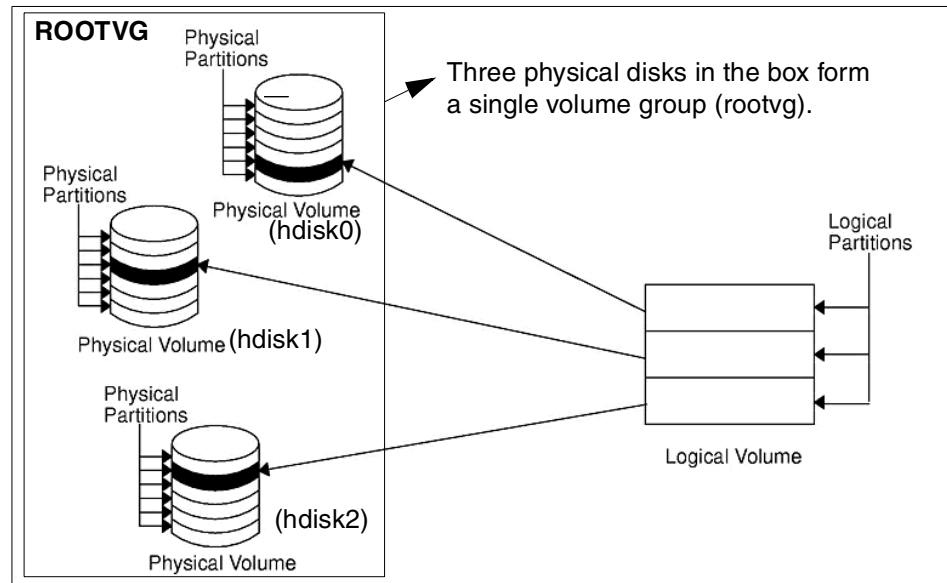

Figure 6-1 Relationship between logical storage components

The following can be said regarding Figure 6-1:

- ▶ Each individual fixed-disk drive is called a physical volume (PV) and has a name. For example: hdisk0, hdisk1, or hdisk2.
- ▶ All physical volumes belong to one volume group (VG) named rootvg.
- ▶ All of the physical volumes in a volume group are divided into physical partitions (PPs) of the same size.
- ▶ Within each volume group, one or more logical volumes (LVs) are defined. Logical volumes are groups of information located on physical volumes. Data on logical volumes appear as contiguous to the user, but can be discontinuous on the physical volume.
- ▶ Each logical volume consists of one or more logical partitions (LPs). Each logical partition corresponds to at least one physical partition. If mirroring is specified for the logical volume, additional physical partitions are allocated to store the additional copies of each logical partition.

- ▶ Logical volumes can serve a number of system purposes, for example, paging, but each logical volume that holds ordinary systems, user data, or programs contains a single journaled file system (JFS). Each JFS consists of a pool of page-size (4 KB) blocks. In AIX Version 4.1, a given file system can be defined as having a fragment size of less than 4 KB (512 bytes, 1 KB, or 2 KB).

After installation, the system has one volume group (the rootvg volume group) consisting of a base set of logical volumes required to start the system and any others you specify to the installation script.

6.1.1 Limitations of logical volume storage

The LVM in AIX provides a lot of flexibility in disk management. However, similar to all other operating system components, it has its limitations. Table 6-1 lists the limitations on the logical storage in AIX.

Table 6-1 Limitations for logical volume storage management

Storage components	Limitations
Volume group	255 per system
Physical volume	32 per volume group
Physical partition	1016 per physical volume up to 256 MB each in size. A multiple of 1016 may be used on AIX Version 4.3.1 or later systems, provided the factor is set to a non-default value.
Logical volume	256 per volume group
Logical partition	35,512 per logical volume

6.2 Managing physical volumes

The following sections discuss adding a new disk drive, changing physical volume characteristics, and monitoring the physical volumes.

6.2.1 Configuring a physical volume

The following three methods can be used to configure a new disk drive. If the LVM will use this disk, it must also be made of a physical volume.

Method 1

This method is used when it is possible or required to shut down and power off the system prior to attaching the disk.

When the system is booted after adding a disk drive, the **cfgmgr** command is run by the system during booting, which will automatically configure the disk. After boot-up is complete, log in as root and run **lspv**, and look for a new disk entry in the output, as shown in the following example.

```
hdisk1  none                none
```

or

```
hdisk1  00005264d21adb2e    none
```

The 16-digit number in the second column of the preceding example is the physical volume identifier (PVID).

If the output shows the new disk with a PVID, it can be used by LVM for configuration. If the new disk does not have a PVID, then use the procedure in Section 6.2.2, “Making an available disk a physical volume” on page 81 to allow the disk to be used by the LVM.

Method 2

This method may be used when it is not required to shut down or power off the system prior to attaching the disk. Perform the following tasks:

1. Run **lspv** to list the physical disks already configured on the system, as shown in the following example:

```
# lspv
hdisk0      000005265ac63976    rootvg
```

2. To configure all newly detected devices on the system (including the new disk), use the following command:

```
cfgmgr
```

3. Run **lspv** again, and look for a new disk entry in the output, as shown in the following example:

```
hdisk1  none                none
```

or

```
hdisk1  00005264d21adb2e    none
```

Once you have determined the name of the newly configured disk, use the procedure described in Section 6.2.2, “Making an available disk a physical volume” on page 81 to allow the disk to be utilized by the Logical Volume Manager.

Method 3

This method may be used when it is not required to shut down or power off the system prior to attaching the disk. This method requires the following information about the new disk:

- ▶ How the disk is attached (subclass)
- ▶ The type of the disk (type)
- ▶ Which system attachment the disk is connected to (parent name)
- ▶ The logical address of the disk (where connected)

Use the following command to configure the disk and ensure that it is available as a physical volume by using the `pv=yes` attribute.

```
mkdev -c disk -s subclass -t type -p parentname \ -w whereconnected -a pv=yes
```

The `pv=yes` attribute makes the disk a physical volume and writes a boot record with a unique physical volume identifier onto the disk (if it does not already have one).

6.2.2 Making an available disk a physical volume

A new disk drive can only be assigned to volume groups. To be used by the LVM, a disk must be configured as a physical volume. The following command will change an available disk (`hdisk1`) to a physical volume by assigning a physical volume identifier (PVID), if it does not already have one:

```
chdev -l hdisk1 -a pv=yes
```

This command has no effect if the disk is already a physical volume. However in an HACMP environment, you may damage the data if you alter the PVID on a shared volume.

6.2.3 Modifying physical volume characteristics

This section discusses the two characteristics that can be changed for a physical volume to control the use of physical volumes using the `chpv` command.

Setting allocation permission for a physical volume

The allocation permission for a physical volume determines if physical partitions contained on this disk, which are not allocated to a logical volume yet, can be allocated for use by logical volumes. Setting the allocation permission defines whether or not the allocation of new physical partitions is permitted for the specified physical volume.

The following command is used to turn off the allocation permission for physical volume `hdisk1`:

```
chpv -a n hdisk1
```

To turn the allocation permission back on, use the following command:

```
chpv -a y hdisk1
```

Setting the availability of a physical volume

The availability of a physical volume defines whether any logical input/output operations can be performed to the specified physical volume. Physical volumes should be made unavailable when they are to be removed from the system or are lost due to failure.

The following command is used to set the state of a physical volume to unavailable:

```
chpv -v r pvname
```

This will quiet all VGDA and VGSA copies on the physical volume, and the physical volume will not take part in future vary on quorum checking. Also, information about the specified volume will be removed from the VGDA's of the other physical volumes in that volume group.

The following command will make a physical volume available to the system:

```
chpv -v a pvname
```

Note: The `chpv` command uses space in the `/tmp` directory to store information while it is executing. If it fails, it could be due to lack of space in the `/tmp` directory. Create more space in that directory and try again.

6.2.4 Removing physical volumes

The physical volume must be unconfigured before it can be removed from the system. The following example shows how to unconfigure a physical volume (`hdisk1`) and change its state from available to defined using the `rmdev` command:

```
rmdev -l hdisk1
```

The definition of this physical volume will remain in the ODM.

6.2.5 Listing information about physical volumes

A physical volume correctly installed on the system can be assigned to a volume group and can subsequently be used to hold file systems and logical volumes.

The information about free physical partitions and their availability within different sectors on the disk can be very useful. The following section will discuss using the `lspv` command to obtain such information pertinent to physical volumes.

Listing physical volumes on the system

The `lspv` command executed without any flag will produce output that will identify the physical volumes by name that are known to the system, as shown in the following example:

```
# lspv
hdisk0      00615147ce54a7ee    rootvg
hdisk1      00615147a877976a    rootvg
#
```

The `lsdev` command with the `-C` option and `-c class` will also list the physical volumes on the system along with the status of each physical volume, as shown in the following example:

```
# lsdev -C -c disk
hdisk0 Available 40-58-00-0,0 16 Bit SCSI Disk Drive
hdisk1 Available 40-58-00-1,0 16 Bit SCSI Disk Drive
hdisk2 Available 20-68-L      SSA Logical Disk Drive
hdisk3 Available 20-68-L      SSA Logical Disk Drive
hdisk4 Available 20-68-L      SSA Logical Disk Drive
hdisk5 Available 20-68-L      SSA Logical Disk Drive
hdisk6 Available 20-68-L      SSA Logical Disk Drive
#
```

Listing physical volume characteristics

The following example shows the use of the `lspv` command to retrieve more detailed information about a physical volume:

```
# lspv hdisk1
PHYSICAL VOLUME:    hdisk1                VOLUME GROUP:    rootvg
PV IDENTIFIER:     00615147a877976a    VG IDENTIFIER    00615147b27f2b40
PV STATE:          active
STALE PARTITIONS:  0                ALLOCATABLE:     yes
PP SIZE:           4 megabyte(s)          LOGICAL VOLUMES: 13
TOTAL PPs:        238 (952 megabytes)    VG DESCRIPTORS:  1
FREE PPs:         71 (284 megabytes)
USED PPs:         167 (668 megabytes)
FREE DISTRIBUTION: 48..02..00..00..21
USED DISTRIBUTION: 00..46..47..47..27
#
```

The left hand pair of columns holds information about the physical volume itself. The right hand pair displays information concerning the volume group of which the physical volume is a member.

The meanings of various fields in the preceding example are:

PHYSICAL VOLUME	The name of the specified physical volume.
PV IDENTIFIER	The physical volume identifier (unique to the system).
PV STATE	The state of the physical volume. This defines whether or not the physical volume is available for logical input/output operations. It can be changed using the chpv command.
STALE PARTITIONS	The number of stale partitions.
PP SIZE	The size of a physical partition. This is a characteristic of the volume group and is set only at the creation of the volume group as an argument to the mkvg command. The default size is 4 MB.
TOTAL PPs	The total number of physical partitions, including both free and used partitions available on the physical volume.
FREE PPs	The number of free partitions available on the physical volume.
USED PPs	The number of used partitions on the physical volume.
FREE DISTRIBUTION	This field summarizes the distribution of free physical partitions across the physical volume, according to the sections of the physical volume on which they reside.
USED DISTRIBUTION	Same as free distribution, except that it displays the allocation of used physical partitions.
VOLUME GROUP	The name of the volume group to which the physical volume is allocated.
VG IDENTIFIER	The numerical identifier of the volume group to which the physical volume is allocated.
VG STATE	State of the volume group. If the volume group is activated with the varyonvg command, the state is either active/complete (indicating all physical volumes are active) or active/partial (indicating some physical volumes are not active). If the volume group is not activated with the varyonvg command, the state is inactive.
ALLOCATABLE	Whether the system is permitted to allocate new physical partitions on this physical volume.
LOGICAL VOLUMES	The number of the logical volumes in the volume group.

VG DESCRIPTORS The number of VGDA's for this volume group which reside on this particular physical volume.

Listing logical volume allocation within a PV

The following example shows the `lspv` command with the `-l` option to list the physical volume `hdisk1`. The output shows the names of all the logical volumes on the physical volume, the number of physical and logical partitions allocated, the distribution across the physical volume, and the mount point, if one exists.

```
# lspv -l hdisk1
hdisk1:
LV NAME          LPs   PPs   DISTRIBUTION      MOUNT POINT
rawlv            1     1     01..00..00..00..00  N/A
hd4              2     2     02..00..00..00..00  /
hd9var          1     1     01..00..00..00..00  /var
hd3              8     8     01..00..07..00..00  /tmp
lv06             5     5     00..05..00..00..00  /home2
lv07            13    13     00..13..00..00..00  /backfs
rawlv1           2     2     00..02..00..00..00  N/A
copied           2     2     00..02..00..00..00  N/A
newlv            1     1     00..01..00..00..00  N/A
fslv00           1     1     00..01..00..00..00  N/A
hd6              1     1     00..01..00..00..00  N/A
mytest           1     1     00..01..00..00..00  N/A
#
```

Listing physical partition allocation by PV region

The example provided in Figure 6-2 on page 86 shows how to retrieve more detailed information about the range of physical partitions allocated to a logical volume and the region of disk used for those partitions.

```

# lspv -p hdisk1
hdisk1:
PP RANGE STATE REGION LV NAME TYPE MOUNT POINT
1-2 used outer edge hd5 boot N/A
3-19 free outer edge
20-30 used outer edge hd2 jfs /usr
31-31 used outer edge hd4 jfs /
32-103 used outer edge hd2 jfs /usr
104-143 used outer middle paging01 paging N/A
144-170 used outer middle hd2 jfs /usr
171-173 free outer middle
174-174 used outer middle hd6 paging N/A
175-179 free outer middle
180-184 used outer middle paging02 paging N/A
185-192 used outer middle hd1 jfs /home
193-195 used outer middle lv01 jfs /var/dce
196-205 used outer middle lv02 jfs /var/dce/adm/dfs/
cache
206-206 used outer middle hd2 jfs /usr
207-207 used center hd8 jfslog N/A
208-208 used center hd4 jfs /
209-217 used center hd2 jfs /usr
218-218 used center hd9var jfs /var
219-221 used center hd3 jfs /tmp
222-222 used center hd1 jfs /home
223-285 used center hd2 jfs /usr
286-286 used center hd3 jfs /tmp
287-309 used center hd2 jfs /usr
310-412 used inner middle hd2 jfs /usr
413-447 used inner edge hd6 paging N/A
448-515 free inner edge
# █

```

Figure 6-2 Status and characteristics of hdisk1 by physical partitions

The following is the description of the fields shown in Figure 6-2:

PP RANGE	The range of physical partitions for which the current row of data applies.
STATE	Whether or not the partitions have been allocated. Value can be either used or free.
REGION	Notional region of the disk within which the partitions are located.
LV NAME	Name of the logical volume to which the partitions in question have been allocated.
TYPE	Type of file system residing on the logical volume.
MOUNT POINT	Mount point of the file system, if applicable.

Listing physical partition allocation table

To determine the degree of contiguity of data on the system in order to improve the I/O performance of a logical volume, you can use the `lspv` command with the `-M` option, as shown in Figure 6-3. You may decide to reorganize the system after analyzing the output.

```
# lspv -M hdisk0
hdisk0:1-17
hdisk0:18      lv03:1
hdisk0:19      lv03:2
hdisk0:20      lv03:3
hdisk0:21      lv03:4
hdisk0:22-33
hdisk0:34      paging00:1
hdisk0:35      paging00:2
hdisk0:36      paging00:3
hdisk0:37      paging00:4
hdisk0:38      paging00:5
hdisk0:39      paging00:6
hdisk0:40      paging00:7
hdisk0:41      paging00:8
hdisk0:42      paging00:9
hdisk0:43      paging00:10
hdisk0:44      paging00:11
hdisk0:45      paging00:12
hdisk0:46      paging00:13
hdisk0:47      paging00:14
hdisk0:48      paging00:15
hdisk0:49      paging00:16
hdisk0:50      paging00:17
hdisk0:51      paging00:18
hdisk0:52      paging00:19
hdisk0:53      paging00:20
hdisk0:54      paging00:21
hdisk0:55      paging00:22
hdisk0:56      paging00:23
hdisk0:57      paging00:24
hdisk0:58-81
# █
```

Figure 6-3 Physical partition allocation by disk region

The first column indicates the physical partition (if a group of contiguous partitions are free, it will indicate a range of partitions) for a particular hard disk. The second column indicates which logical partition of which logical volume is associated with that physical partition.

6.2.6 Migrating the contents of a physical volume

The physical partitions belonging to one or more specified logical volumes can be moved from one physical volume to one or more other physical volumes within a volume group using the `migratepv` command.

Note: The `migratepv` command cannot move data between different volume groups, as shown in Figure 6-4.

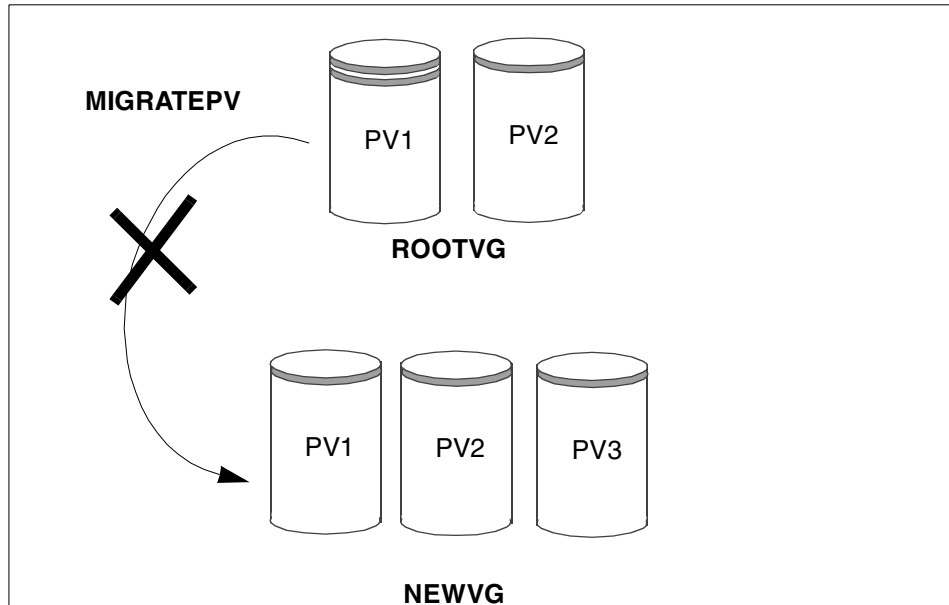

Figure 6-4 `migratepv` does not work across volume groups

The following procedure describes how to move the data from a failing disk before it is removed for repair or replacement.

1. Determine which disks are in the volume group. Make sure that the source and destination physical volumes are in the same volume group. If the source and destination physical volumes are in the same volume group, proceed to step 3. Use the following command to check the disks in the volume group:

```
# lsvg -p rootvg
rootvg:
  PV_NAME   PV STATE   TOTAL PPs   FREE PPs   FREE DISTRIBUTION
  hdisk0    active    159         0          00..00..00..00..00
```

2. If you are planning to migrate to a new disk, such as when you have a failing disk, perform the following steps:

- a. Make sure the disk is available by entering the following:

```
# lsdev -Cc disk
hdisk0 Available 00-08-00-30 670 MB SCSI Disk Drive
hdisk1 Available 00-08-00-20 857 MB SCSI Disk Drive
```

- b. If the disk is listed and in the available state, make sure it does not belong to another volume group using the following command (In the following example, `hdisk1` can be used as a destination disk.):

```
# lspv
hdisk0      0000078752249812  rootvg
hdisk1      000000234ac56e9e  none
```

- c. If the disk is not listed or is not available, you need to check or install the disk.
- d. Add the new disk to the volume group using the command:

```
extendvg VGName hdiskNumber
```

3. Make sure that you have enough room on the target disk for the source that you want to move.

- a. Determine the number of physical partitions on the source disk by using the following command (SourceDiskNumber will be of the form `hdiskNumber`):

```
lspv SourceDiskNumber | grep "USED PPs"
```

The output will look similar to the following:

```
USED PPs:      159 (636 megabytes)
```

In this example, you would need 159 free PPs on the destination disk to successfully complete the migration.

- b. Determine the number of free physical partitions on the destination disk or disks using the following command for each destination disk (DestinationDiskNumber will be of the form `hdiskNumber`):

```
lspv DestinationDiskNumber | grep "FREE PPs"
```

Add the free PPs from all of the destination disks. If the sum is larger than the number of USED PPs from step 3, you will have enough space for the migration.

4. Follow this step only if you are migrating data from a disk in the `rootvg` volume group. If you are migrating data from a disk in a user-defined volume group, proceed to step 5.

Check to see if the boot logical volume (`hd5`) is on the source disk:

```
lspv -l SourceDiskNumber | grep hd5
```

If you get no output, the boot logical volume is not located on the source disk. Continue to step 5.

If you get output similar to the following:

```
hd5          2  2  02..00..00..00..00  /b1v
```

then run the following command:

```
migratepv -l hd5 SourceDiskNumber DestinationDiskNumber
```

Note:

- ▶ This **migratepv** command is not allowed if the volume group is varied on in concurrent mode.
- ▶ The **migratepv** command cannot migrate striped logical volumes. To move data from one physical volume to another, use the **cp1v** command to copy the data and then use the **rm1v** command to remove the old copy.
- ▶ You must either have root user authority or be a member of the system group to execute the **migratepv** command.

Next, you will get a message warning you to perform the **bosboot** command on the destination disk.

Note: When the boot logical volume is migrated from a physical volume, the boot record on the source should be cleared. Failure to clear this record may result in a system hang. When you execute the **bosboot** command, you must also execute **mkboot -c**. At the time of publication, the **mkboot** command is currently unsupported (but works); however, using another command, such as **dd**, is not advisable, because it could cause a loss of data if used incorrectly.

Execute the **mkboot -c** command to clear the boot record on the source. Do the following on pre-AIX Version 4.2 systems:

```
bosboot -a -d /dev/DestinationDiskNumber
```

then:

```
bootlist -m normal DestinationDiskNumber
```

then:

```
mkboot -c -d /dev/SourceDiskNumber
```

5. Executing the SMIT fast path command **smitty migratepv** to migrate the data will show a screen similar to Figure 6-5 on page 91.

```

Move Contents of a Physical Volume

Type or select values in entry fields.
Press Enter AFTER making all desired changes.

                                [Entry Fields]
* SOURCE physical volume name    hdisk1
* DESTINATION physical volumes  [hdisk4]      +
Move only data belonging to this [ ]          +
LOGICAL VOLUME?

F1=Help      F2=Refresh    F3=Cancel    F4=List
F5=Reset     F6=Command    F7=Edit      F8=Image
F9=Shell     F10=Exit       Enter=Do

```

Figure 6-5 *smitty migratepv* command

6. List the physical volumes (PF4), and select the source physical volume you examined previously.
7. Go to the DESTINATION physical volume field. If you accept the default, all the physical volumes in the volume group are available for the transfer. Otherwise, select one or more disks with adequate space for the partitions you will be moving (from step 4).
8. If you wish, go to the Move only data belonging to this LOGICAL VOLUME field, and list and select a logical volume. You will move only the physical partitions allocated to the logical volume specified that are located on the physical volume selected as the source physical volume.
9. Press Enter to move the physical partitions.
10. To remove the source disk from the volume group, such as when it is failing, enter the following command:

```
reducevg VGName SourceDiskNumber
```
11. To physically remove the source disk from the system, such as when it is failing, enter the following command:

```
rmdev -l SourceDiskNumber -d
```

A few more examples of using the **migratepv** command are:

- ▶ Use the following command to move physical partitions from hdisk1 to hdisk6 and hdisk7; all physical volumes are in one volume group:

```
migratepv hdisk1 hdisk6 hdisk7
```

- ▶ Use the following command to move physical partitions in logical volume lv02 from hdisk1 to hdisk6:

```
migratepv -l lv02 hdisk1 hdisk6
```

6.3 Managing volume groups

This section discusses the functions that can be performed on volume groups. As with physical volumes, volume groups can be created and removed, and their characteristics can be modified. Additional functions, such as activating and deactivating volume groups, can also be performed.

6.3.1 Adding a volume group

Before a new volume group can be added to the system, one or more physical volumes, not used in other volume groups and in an available state, must exist on the system.

It is important to decide upon certain information, such as the volume group name and the physical volumes to use, prior to adding a volume group.

New volume groups can be added to the system by using the **mkvg** command or by using SMIT. Of all the characteristics set at creation time of the volume group, the following are essentially the most important:

- ▶ Volume group names shall be unique on the system.
- ▶ Names of all physical volumes to be used in the new volume group.
- ▶ Maximum number of physical volumes that can exist in the volume group.
- ▶ Physical partition size for the volume group.
- ▶ Flag to activate the volume group automatically at each system restart.

The following example shows the use of the **mkvg** command to create a volume group, myvg, using the physical volumes hdisk1 and hdisk5, with a physical partition size of 8 MB. The volume group is limited to a maximum of 10 physical volumes. Use the command:

```
mkvg -y myvg -d 10 -s 8 hdisk1 hdisk5
```

Alternatively, you can use the SMIT fast path `smitty mkvg` to obtain the screen shown in Figure 6-6 and enter the characteristics of the volume group to be created in the fields.

```

                                Add a Volume Group

Type or select values in entry fields.
Press Enter AFTER making all desired changes.

                                [Entry Fields]
VOLUME GROUP name                [ ]
Physical partition SIZE in megabytes 4 +
* PHYSICAL VOLUME names           [ ] +
Activate volume group AUTOMATICALLY yes +
  at system restart?
Volume Group MAJOR NUMBER          [ ] +#
Create VG Concurrent Capable?      no +
Auto-varyon in Concurrent Mode?    no +

F1=Help      F2=Refresh      F3=Cancel      F4=List
F5=Reset     F6=Command     F7=Edit       F8=Image
F9=Shell     F10=Exit          Enter=Do

```

Figure 6-6 `smitty mkvg` command

The `smitty mkvg` command will automatically activate the volume group by calling the `varyonvg` command. Moreover, the SMIT command limits the following functions, as compared to the command line.

- ▶ It does not provide the `-d` flag to set the maximum number of physical volumes. It uses a default value of 32.
- ▶ It does not provide the `-m` flag to set the maximum size of the physical volume. This flag will determine how many physical partitions are used. It uses a default value of 1016 partitions.
- ▶ It always uses the `-f` flag to force creation of the volume group.

Note: For a new volume group to be successfully added to the system using the `mkvg` command, the root file system should have about 2 MB of free space. Check this using the `df` command. This free space is required because a file is written in the directory `/etc/vg` each time a new volume group is added.

6.3.2 Modifying volume group characteristics

The following sections discuss the tasks required to modify a volume group's characteristics.

Modifying volume group activation characteristics

The following command allows the volume group, newvg, to be varied on automatically each time a system is restarted:

```
chvg -ay newvg
```

The following command will turn off the automatic varying on of a volume group at the system restart:

```
chvg -an newvg
```

Unlocking a volume group

A volume group can become locked when an LVM command terminates abnormally due to a system crash while an LVM operation was being performed on the system.

In AIX Version 4, it is now also possible to unlock a volume group. The following example shows the command to unlock the newvg volume group:

```
chvg -u newvg
```

Adding a physical volume

It may be necessary to increase the free space available in a volume group so that existing file systems and logical volumes within the volume group can be extended, or new ones can be added. To do this requires additional physical volumes be made available within the volume group.

It is possible to add physical volumes to a volume group, up to the maximum specified at creation time. A physical volume can be added using the **extendvg** command. The following example shows the command to add the physical volume, hdisk3, to volume group newvg:

```
extendvg newvg hdisk3
```

Note: The **extendvg** command will fail if the physical volume being added already belongs to a varied on volume group on the current system. Also, if the physical volume being added belongs to a volume group that is currently not varied on, the user will be asked to confirm whether or not to continue.

Alternatively, you can use the SMIT fast path command **smitty vgsc** and select the option Add a Physical Volume to a Volume Group.

Removing a physical volume

The volume group must be varied on before it can be reduced. The following example shows how to remove a physical volume, `hdisk3`, from a volume group, `myvg`:

```
reducevg myvg hdisk3
```

Alternatively, you can use the SMIT fast path command **smitty reducevg** to remove a physical volume from a volume group.

Note: The **reducevg** command provides the `-d` and `-f` flags.

- ▶ The `-d` flag can be risky because it automatically deletes all logical volume data on the physical volume before removing the physical volume from the volume group. If a logical volume spans multiple physical volumes, the removal of any of those physical volumes may jeopardize the integrity of the entire logical volume.
- ▶ The `-f` flag makes the `-d` flag even more risky by suppressing interaction with a user requesting confirmation that the logical volume should be deleted.

If the logical volumes on the physical volume specified to be removed also span other physical volumes in the volume group, the removal operation may destroy the integrity of those logical volumes, regardless of the physical volume on which they reside.

When you remove all physical volumes in a volume group, the volume group itself is also removed.

Removing a physical volume reference

Sometimes a disk is removed from the system without first running **reducevg VolumeGroup PhysicalVolume**. The VGDA still has the removed disk's reference, but the physical volume name no longer exists or has been reassigned. To remove references to the disk which has been removed, you can still use the **reducevg** command using the PVID of the physical volume removed. The following command will remove the reference of a physical volume (with PVID of `000005265ac63976`) from the volume group `newvg`:

```
reducevg newvg 000005265ac63976
```

Resynchronizing the device configuration database

During normal operations, the device configuration database of the ODM remains consistent with the LVM information in the logical volume control blocks and the VGDA's on the physical volumes. If, for some reason, the device configuration database is not consistent with LVM information, the **sync1vodm** command can be used to resynchronize the database. The volume group must be active for the resynchronization to occur. If logical volume names are specified, only the information related to those logical volumes is updated.

To synchronize the device configuration database with the LVM information for rootvg, enter the following:

```
sync1vodm rootvg
```

6.3.3 Importing and exporting a volume group

There may be times when a volume group needs to be moved from one RS/6000 or IBM @server pSeries system to another, so that logical volume and file system data in the volume group can be accessed directly on the target system.

To remove the system definition of a volume group from the ODM database, the volume group needs to be exported using the **exportvg** command. This command will not remove any user data in the volume group, but will only remove its definition from the ODM database.

Similarly, when a volume group is moved, the target system needs to add the definition of the new volume group. This can be achieved by importing the volume group using the **importvg** command, which will add an entry to the ODM database.

The following example shows the export of a volume group *myvg*:

```
exportvg myvg
```

And the following example shows the import of a volume group *myvg*:

```
importvg -y myvg hdisk12
```

You can also use SMIT fast path commands **smitty exportvg** or **smitty importvg** to export or import a volume group.

If the specified volume group name is already in use, the **importvg** command will fail with an appropriate error message, since duplicate volume group names are not allowed. In this instance, the command can be rerun with a unique volume group name specified, or it can be rerun without the **-y** flag or the volume group name, which gives the imported volume group a unique system default name.

It is also possible that some logical volume names may also conflict with those already on the system. The **importvg** command will automatically reassign these with system default names. The important thing to remember when moving volume groups from system to system is that the **exportvg** command is always run on the source system prior to importing the volume group to the target system. Consider that a volume group is imported on system Y without actually performing an **exportvg** on system X. If system Y makes a change to the volume group, such as removing a physical volume from the volume group, and the volume group is imported back onto system X, the ODM database on system X will not be consistent with the changed information for this volume group.

It is, however, worth noting that a volume group can be moved to another system without first being exported on the source system.

Note:

- ▶ The **importvg** command changes the name of an imported logical volume if there currently is a logical volume with the same name already on the system. An error message is printed to standard error if an imported logical volume is renamed. The **importvg** command also creates file mount points and entries in `/etc/filesystems` if possible (if there are no conflicts).
- ▶ A volume group that has a paging space volume on it cannot be exported while the paging space is active. Before exporting a volume group with an active paging space, ensure that the paging space is not activated automatically at system initialization by running the following command:

```
chps -a n paging_space_name
```
- ▶ Then, reboot the system so that the paging space is inactive.
- ▶ If you do not activate the volume group through **smitty importvg**, you must run the **varyonvg** command to enable access to the file systems and logical volumes after every reboot.
- ▶ If you imported a volume group that contains file systems, or if you activated the volume group through **smitty importvg**, it is highly recommended that you run the **fsck** command before you mount the file systems. If you are moving the volume group to another system, be sure to unconfigure the disks before moving them.
- ▶ The **smitty exportvg** command deletes references to file systems in `/etc/filesystems`, but it leaves the mount points on the system.

6.3.4 Varying on and varying off a volume group

Once a volume group exists, it can be made available for use for system administrative activities using the **varyonvg** command. This process involves the following steps.

1. Each VGDA on each physical volume in a volume group is read.
2. The header and trailer time stamps within each VGDA are read. These time stamps must match for a VGDA to be valid.
3. If a majority of VGDA's (called the quorum) are valid, then the vary on process proceeds. If they are not, then the vary on fails.
4. The system will take the most recent VGDA (the one with the latest time stamp) and write it over all other VGDA's so they match.
5. The **syncvg** command is run to resynchronize any stale partition present (in the case where mirroring is in use).

The **varyonvg** command has the following options that can be used to overcome damage to the volume group structure or give status information.

- ▶ The **-f** flag can be used to force a volume group to be varied on even when inconsistencies are detected. These inconsistencies are generally differences between the configuration data for each volume group held in the ODM database and VGDA.
- ▶ The **-n** flag will suppress the invocation of the **syncvg** command at vary on time. When a volume group is varied on, and stale partitions are detected, the vary on process will invoke the **syncvg** command to synchronize the stale partitions. This option is of value when you wish to carefully recover a volume group and you want to ensure that you do not accidentally write bad mirrored copies of data over good copies.
- ▶ The **-s** flag allows a volume group to be varied on in maintenance or systems management mode. Logical volume commands can operate on the volume group, but no logical volume can be opened for input or output.

The following example shows the command to activate a volume group, newvg.

```
varyonvg newvg
```

You can also use SMIT fast path command **smitty varyonvg** to obtain the screen shown in Figure 6-7 on page 99 and enter the name of volume group to be varied on along with all the options.

```

                                Activate a Volume Group

Type or select values in entry fields.
Press Enter AFTER making all desired changes.

                                [Entry Fields]
* VOLUME GROUP name          [ ]          +
RESYNCHRONIZE stale physical partitions?  yes          +
Activate volume group in SYSTEM
MANAGEMENT mode?                    no           +
FORCE activation of the volume group?     no           +
Warning--this may cause loss of data
integrity.
Varyon VG in Concurrent Mode?          no           +

F1=Help      F2=Refresh      F3=Cancel      F4=List
F5=Reset     F6=Command     F7=Edit       F8=Image
F9=Shell     F10=Exit       Enter=Do

```

Figure 6-7 *smitty varyonvg command*

The **varyoffvg** command will deactivate a volume group and its associated logical volumes. This requires that the logical volumes be closed, which requires that file systems associated with logical volumes be unmounted. The **varyoffvg** also allows the use of the -s flag to move the volume group from being active to being in maintenance or systems management mode.

Note: In AIX Version 4 and later, when a volume group is imported it is automatically varied on, whereas in AIX Version 3, the volume group has to be varied on separately.

The following example shows the command to deactivate a volume group, myvg:

```
varyoffvg myvg
```

You can also use SMIT fast path command **smitty varyoffvg**, which will show a screen similar to Figure 6-8 on page 100. You can enter the name of volume group to be varied off and you can also put the volume group in system management mode.

```

                                Deactivate a Volume Group

Type or select values in entry fields.
Press Enter AFTER making all desired changes.

* VOLUME GROUP name                                [Entry Fields]      +
  Put volume group in SYSTEM                          [ ]                          +
  MANAGEMENT mode?                                   no

```

F1=Help F2=Refresh F3=Cancel F4=List
F5=Reset F6=Command F7=Edit F8=Image
F9=Shell F10=Exit Enter=Do

Figure 6-8 *smitty varyoffvg command*

6.3.5 Monitoring volume groups

The **lsvg** command interrogates the ODM database for all volume groups currently known to the system. The following are a few examples showing the use of the **lsvg** command to monitor volume groups.

Listing the volume groups

The following example shows the use of the **lsvg** command without any flag to list all the volume groups known to the system:

```

# lsvg
rootvg
altinst_rootvg
datavg
testvg
#

```

The following example shows how to list the volume groups that are currently active (varied on):

```

# lsvg -o
testvg
datavg
rootvg

```

Listing the characteristics of a volume group

Figure 6-9 shows the command to list detailed information and status about volume group characteristics.

```
# lsvg rootvg
VOLUME GROUP:      rootvg                VG IDENTIFIER:    00615151e5394126
VG STATE:          active                    PP SIZE:          4 megabyte(s)
VG PERMISSION:     read/write              TOTAL PPs:        596 (2384 megabytes)
MAX LVs:           256                    FREE PPs:         146 (584 megabytes)
LVs:               14                      USED PPs:         450 (1800 megabytes)
OPEN LVs:          13                    QUORUM:           2
TOTAL PVs:         2                      VG DESCRIPTORS:   3
STALE PVs:         0                      STALE PPs:        0
ACTIVE PVs:        2                      AUTO ON:          yes
MAX PPs per PV:   1016                   MAX PVs:          32
# █
```

Figure 6-9 `lsvg rootvg` command

Listing the logical volumes in a volume group

Figure 6-10 shows the command used to display the names, characteristics, and status of all the logical volumes in volume group rootvg.

```
# lsvg -l rootvg
rootvg:
LV NAME           TYPE      LPs  PPs  PVs  LV STATE      MOUNT POINT
hd5               boot     2    2    1    closed/syncd  N/A
hd6               paging   36   36   1    open/syncd    N/A
hd8               jfslog   1    1    1    open/syncd    N/A
hd4               jfs      2    2    1    open/syncd    /
hd2               jfs      309  309  1    open/syncd    /usr
hd9var            jfs      1    1    1    open/syncd    /var
hd3               jfs      4    4    1    open/syncd    /tmp
hd1               jfs      9    9    1    open/syncd    /home
paging00          paging   24   24   1    open/syncd    N/A
paging01          paging   40   40   1    open/syncd    N/A
lv01              jfs      3    3    1    open/syncd    /var/dce
lv02              jfs      10   10   1    open/syncd    /var/dce/adm/dfs/c
lv03              jfs      4    4    1    open/syncd    /usr/vice/cache
paging02          paging   5    5    1    open/syncd    N/A
# █
```

Figure 6-10 `lsvg -l rootvg` command

List the physical volume status within a volume group

Figure 6-11 on page 102 shows the use of the `lsvg` command with the `-p` flag to display a list of physical volumes contained in a volume group, as well as some status information, including physical partition allocation. This form of the `lsvg` command is useful for summarizing the concentrations of free space on the system.

```

# lsvg -p rootvg
rootvg:
PV_NAME      PV STATE    TOTAL PPs  FREE PPs   FREE DISTRIBUTION
hdisk1       active      515        93         17..08..00..00..68
hdisk0       active      81         53         17..12..00..08..16
# █

```

Figure 6-11 *lsvg -p vname* command

Following is the description of the various fields shown in the preceding example.

PV_NAME	The name of the physical volume.
PV STATE	Whether or not this physical volume is active.
TOTAL PPs	The total number of physical partitions on this physical volume.
FREE PPs	The total number of unused physical partitions on this physical volume.
FREE DISTRIBUTION	The location of the free physical partitions on the physical volumes. There are five columns, one for each disk region, in the following order: Outside edge, Outside middle, Center, Inside middle, Inside edge.

6.3.6 Reorganizing a volume group

The **reorgvg** command is used to reorganize the physical partition allocation for a volume group according to the allocation characteristics of each logical volume.

The following is the syntax of the **reorgvg** command:

```
reorgvg [ -i ] VolumeGroup [ LogicalVolume ... ]
```

The volume group must be varied on and must have free partitions before you can use the **reorgvg** command. The relocatable flag of each logical volume must be set to y using the **chlv -r** command for the reorganization to take effect; otherwise, the logical volume is ignored.

Note:

1. The **reorgvg** command does not reorganize the placement of allocated physical partitions for any striped logical volumes.
2. At least one free physical partition must exist on the specified volume group for the **reorgvg** command to run successfully.
3. In AIX Version 4.2 or later, if you enter the **reorgvg** command with the volume group name and no other arguments, it will only reorganize the first logical volume in the volume group. The first logical volume is the one listed by the **lsvg -l VolumeName** command.

You can also use the SMIT fast path command **smitty reorgvg** to do the same task. Table 6-2 provides details on the flags for the **reorgvg** command.

Table 6-2 *reorgvg* command flags

Flag	Description
-i	Specifies physical volume names read from standard input. Only the partitions on these physical volumes are organized.

- ▶ The following command reorganizes the logical volumes lv03, lv04, and lv07 on volume group vg02:

```
reorgvg vg02 lv03 lv04 lv07
```

Only the listed logical volumes are reorganized on vg02.

- ▶ The following example shows how to reorganize the partitions located on physical volumes hdisk4 and hdisk6 that belong to logical volumes lv203 and lv205:

```
echo "hdisk4 hdisk6" | reorgvg -i vg02 lv203 lv205
```

Only the partitions located on physical volumes hdisk4 and hdisk6 of volume group vg02, which belong to logical volumes lv203 and lv205, are reorganized.

6.3.7 Synchronizing a volume group

The **syncvg** command is used to synchronize logical volume copies that are not current (stale).

The following is the syntax of the **syncvg** command:

```
syncvg [ -f ] [ -i ] [ -H ] [ -P NumParallelLps ] { -l | -p | -v } Name ...
```

The **syncvg** command synchronizes the physical partitions, which are copies of the original physical partition that are not current. The **syncvg** command can be used with logical volumes, physical volumes, or volume groups, with the Name parameter representing the logical volume name, physical volume name, or volume group name. The synchronization process can be time consuming, depending on the hardware characteristics and the amount of data.

When the -f flag is used, an uncorrupted physical copy is chosen and propagated to all other copies of the logical partition, whether or not they are stale.

Unless disabled, the copies within a volume group are synchronized automatically when the volume group is activated by the **varyonvg** command. The commonly used flags of the **syncvg** command are shown in Table 6-3.

Table 6-3 Key flags for the syncvg command

Flag	Description
-p	Specifies that the Name parameter represents a physical volume device name.
-v	Specifies that the Name parameter represents a volume group device name.

The following examples show the use of the **syncvg** command:

- ▶ To synchronize the copies on physical volumes hdisk4 and hdisk5, execute the following command:

```
syncvg -p hdisk4 hdisk5
```

- ▶ To synchronize the copies on volume groups vg04 and vg05, execute the following command:

```
syncvg -v vg04 vg05
```

6.3.8 Moving a logical volume within a volume group

This section describes how to move a logical volume from one disk onto another disk. A problem faced is that the target disk already belongs to a volume group.

To migrate the information from the physical volume hdisk4 to the physical volume hdisk3, enter:

```
# migratepv hdisk4 hdisk3
0516-806 migratepv: Destination physical volume hdisk3 belongs
to wrong volume group.
# lspv
hdisk0      000919746edab91f    rootvg
hdisk1      0009197459d92f2e    None
hdisk2      00091974d381d097    uservg
```

```

hdisk3      00091974d81ff431  newvg
hdisk4      00091974de731316  uservg
hdisk5      00091974e4f3d56e  None

```

The easiest option is to move hdisk4 to hdisk1. Since hdisk1 is not part of a volume group, you must add it to the volume group:

```
extendvg uservg hdisk1
```

The command for this is:

```
migratepv hdisk4 hdisk1
```

The other option is to delete the volume group newvg. Any file systems associated with newvg and any logical volumes associated with newvg must be removed.

List the file system information and look for the newlv logical volume. Notice it is mounted on /u1:

```
# lsfs
Name          Nodename  Mount Pt      VFS  Size  Options  Auto
Accounting
/dev/hd4      --        /              jfs  32768 --      yes
no
/dev/hd1      --        /home          jfs  3276800 --     yes
no
/dev/hd2      --        /usr           jfs  4702208 --     yes
no
/dev/hd9var   --        /var           jfs  16384  --     yes
no
/dev/hd3      --        /tmp           jfs  32768  --     yes
no
/dev/userlv   --        /u             jfs  3276800 rw     yes
no
/dev/newlv    --        /u1            jfs  3276800 rw     yes
no
```

List the volume group to find the logical volume information. Notice the newlv and loglv01 LV names:

```
# lsvg -l newvg
newvg:
LV NAME      TYPE  LPs  PPs  PVs  LV STATE  MOUNT POINT
newlv        jfs   200  200  1    open/syncd /u1
loglv01     jfslog 1    1    1    open/syncd N/A
```

List the mount information to check if newlv is mounted. Notice that /u1 is mounted:

```
# mount
node      mounted      mounted over  vfs      date      options
-----
          /dev/hd4      /              jfs      Nov 16 18:45 rw,log=/dev/hd8
          /dev/hd2      /usr           jfs      Nov 16 18:45 rw,log=/dev/hd8
          /dev/hd9var   /var           jfs      Nov 16 18:45 rw,log=/dev/hd8
          /dev/hd3      /tmp           jfs      Nov 16 18:45 rw,log=/dev/hd8
          /dev/hd1      /home          jfs      Nov 16 18:46 rw,log=/dev/hd8
          /dev/userlv  /u              jfs      Nov 17 14:12
rw,log=/dev/loqlv00
          /dev/newlv    /u1            jfs      Nov 17 14:13
rw,log=/dev/loqlv01
```

To unmount the /dev/newlv logical volume, enter:

```
umount /dev/newlv
```

Type **mount** to check if /dev/newlv has ben unmounted. If successful, type:

```
smitty lvm
```

At the Logical Volume Manager menu, select Logical Volumes, as displayed in Figure 6-12.

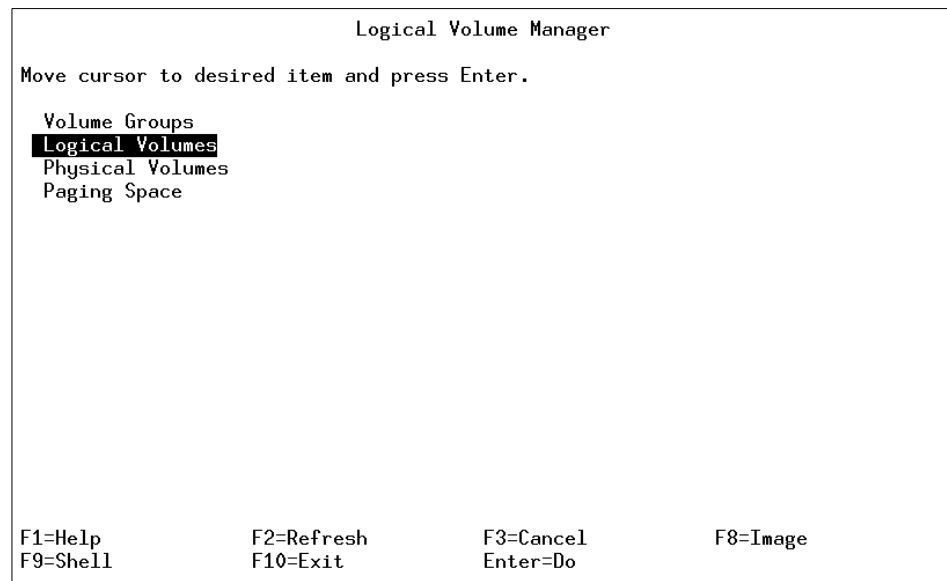

Figure 6-12 Logical Volume Manager menu

From the Logical Volumes Menu, select Remove a Logical Volume, as displayed in Figure 6-13.

```
Logical Volumes

Move cursor to desired item and press Enter.

List All Logical Volumes by Volume Group
Add a Logical Volume
Set Characteristic of a Logical Volume
Show Characteristics of a Logical Volume
Remove a Logical Volume
Copy a Logical Volume

F1=Help      F2=Refresh   F3=Cancel    F8=Image
F9=Shell     F10=Exit     Enter=Do
```

Figure 6-13 Logical Volumes menu

From the Remove a Logical Volume menu, enter the logical volume name you want removed, as displayed in Figure 6-14 on page 108.

Once completed, the system will display the command status, as in Figure 6-16.

```
COMMAND STATUS

Command: OK          stdout: yes          stderr: no

Before command completion, additional instructions may appear below.

mlv: Logical volume newlv is removed.

F1=Help          F2=Refresh          F3=Cancel          F6=Command
F8=Image         F9=Shell            F10=Exit           /=Find
n=Find Next
```

Figure 6-16 Remove a Logical Volume - Command Status screen

Once the Logical Volume has been removed, the Volume Group must be removed. Press F3 until you get to the Logical Volume Manager menu, then select Volume Groups, as displayed in Figure 6-17.

```
Logical Volume Manager

Move cursor to desired item and press Enter.

Volume Groups
Logical Volumes
Physical Volumes
Paging Space

F1=Help          F2=Refresh          F3=Cancel          F8=Image
F9=Shell         F10=Exit            Enter=Do
```

Figure 6-17 Logical Volume Manager menu

In the Volume Groups menu, select Remove a Volume Group, as displayed in Figure 6-18.

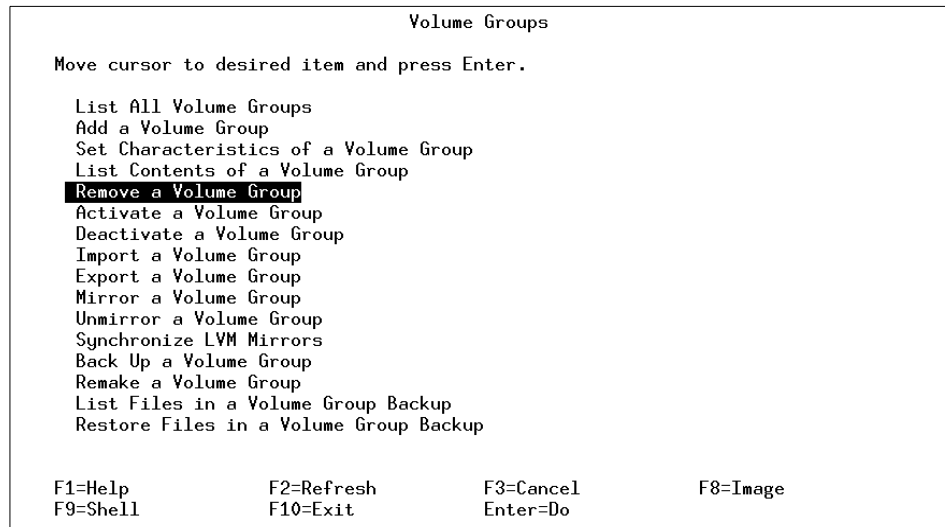

Figure 6-18 Volume Groups menu

From the Remove a Volume Group menu, select the VOLUME GROUP name to be removed, as displayed in Figure 6-19.

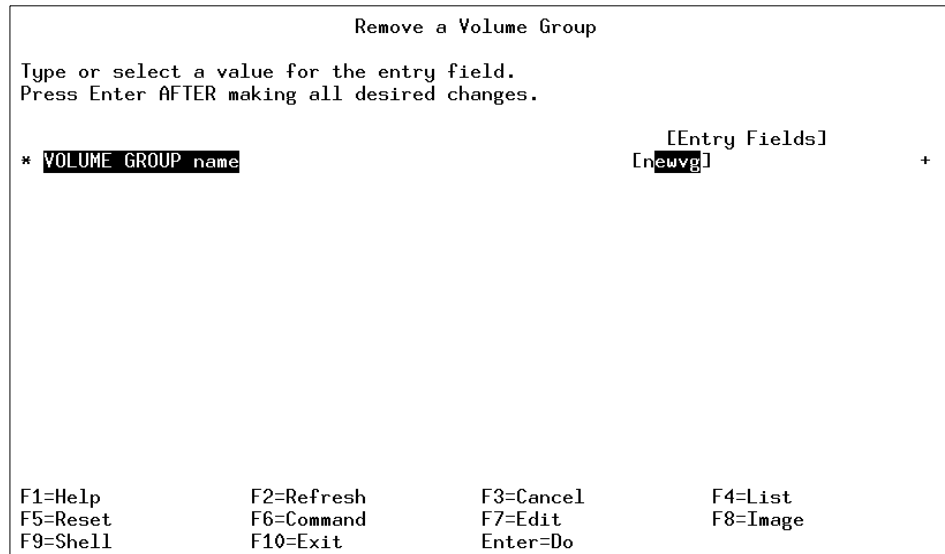

Figure 6-19 Remove a Volume Group menu

After a selection has been entered for the Volume Group to remove, a confirmation screen is displayed, as in Figure 6-20. Press Enter to continue.

```
Remove a Volume Group

Type or select a value for the entry field.
Press Enter AFTER making all desired changes.

* VOLUME GROUP name [Entry Fields] [newvg] +

ARE YOU SURE?

Continuing may delete information you may want
to keep. This is your last chance to stop
before continuing.
Press Enter to continue.
Press Cancel to return to the application.
█

F1 F1=Help          F2=Refresh        F3=Cancel
F5 F8=Image         F10=Exit          Enter=Do
F9
```

Figure 6-20 Remove a Volume Group - confirmation screen

Figure 6-21 on page 112 is the COMMAND STATUS screen confirming a successful removal of the Volume Group.

```
COMMAND STATUS

Command: OK          stdout: yes          stderr: no

Before command completion, additional instructions may appear below.

rmLv: Logical volume loglv01 is removed.
Ideletepv: Volume Group deleted since it contains no physical volumes.

F1=Help          F2=Refresh          F3=Cancel          F6=Command
F8=Image         F9=Shell            F10=Exit           /=Find
n=Find Next
```

Figure 6-21 Remove a Volume Group - Command Status screen

Press F10 to exit to the command prompt.

To check the status of your Physical Volumes, enter:

```
# lspv
hdisk0      000919746edab91f   rootvg
hdisk1      0009197459d92f2e   None
hdisk2      00091974d381d097   uservg
hdisk3      00091974d81ff431   None
hdisk4      00091974de731316   uservg
hdisk5      00091974e4f3d56e   None
```

To add the physical volume hdisk3 to the volume group uservg, enter:

```
smitty vg
```

From the Volume Groups menu, select the Set Characteristics of a Volume Group option, as displayed in Figure 6-22 on page 113.

```
Volume Groups

Move cursor to desired item and press Enter.

List All Volume Groups
Add a Volume Group
Set Characteristics of a Volume Group
List Contents of a Volume Group
Remove a Volume Group
Activate a Volume Group
Deactivate a Volume Group
Import a Volume Group
Export a Volume Group
Mirror a Volume Group
Unmirror a Volume Group
Synchronize LVM Mirrors
Back Up a Volume Group
Remake a Volume Group
List Files in a Volume Group Backup
Restore Files in a Volume Group Backup

F1=Help      F2=Refresh   F3=Cancel    F8=Image
F9=Shell     F10=Exit    Enter=Do
```

Figure 6-22 Volume Groups menu

From the Set Characteristics of a Volume Group menu, select the Add a Physical Volume to a Volume Group option, as displayed in Figure 6-23.

```
Set Characteristics of a Volume Group

Move cursor to desired item and press Enter.

Change a Volume Group
Add a Physical Volume to a Volume Group
Remove a Physical Volume from a Volume Group
Reorganize a Volume Group

F1=Help      F2=Refresh   F3=Cancel    F8=Image
F9=Shell     F10=Exit    Enter=Do
```

Figure 6-23 Set Characteristics of a Volume Group menu

In the Add a Physical Volume to a Volume Group field, enter the VOLUME GROUP name and the PHYSICAL VOLUME names, as displayed in Figure 6-24.

```

Add a Physical Volume to a Volume Group

Type or select values in entry fields.
Press Enter AFTER making all desired changes.

                                [Entry Fields]
* VOLUME GROUP name                [uservg]                +
* PHYSICAL VOLUME names            [hdisk3]                +

F1=Help          F2=Refresh      F3=Cancel        F4=List
F5=Reset         F6=Command     F7=Edit         F8=Image
F9=Shell        F10=Exit       Enter=Do
  
```

Figure 6-24 Add a Physical Volume to a Volume Group menu

Figure 6-25 displays the confirmation screen in the Add a Physical Volume to a Volume Group menu. Press Enter to continue.

```

Add a Physical Volume to a Volume Group

Type or select values in entry fields.
Press Enter AFTER making all desired changes.

                                [Entry Fields]
* VOLUME GROUP name                [uservg]                +
* PHYSICAL VOLUME names            [hdisk3]                +

ARE YOU SURE?

Continuing may delete information you may want
to keep. This is your last chance to stop
before continuing.
Press Enter to continue.
Press Cancel to return to the application.

F1 F1=Help          F2=Refresh      F3=Cancel
F5 F8=Image        F10=Exit       Enter=Do
F9
  
```

Figure 6-25 Add a Physical Volume to a Volume Group - confirmation screen

Once the command has completed, you will see Command: OK, as displayed in Figure 6-26.

```
COMMAND STATUS
Command: OK          stdout: no          stderr: no
Before command completion, additional instructions may appear below.
█

F1=Help      F2=Refresh    F3=Cancel    F6=Command
F8=Image     F9=Shell     F10=Exit     /=Find
n=Find Next
```

Figure 6-26 Add a Physical Volume to a Volume Group - Command Status

Press F10 to exit to the command prompt. At the command prompt, check the status of your Physical Volume.

Enter:

```
# lspv
hdisk0      000919746edab91f  rootvg
hdisk1      0009197459d92f2e  None
hdisk2      00091974d381d097  uservg
hdisk3      00091974d81ff431  uservg
hdisk4      00091974de731316  uservg
hdisk5      00091974e4f3d56e  None
```

To move the information from hdisk4 to hdisk3, enter:

```
migratepv hdisk4 hdisk3
```

To remove hdisk4 from the volume group uservg, enter:

```
# reducevg uservg hdisk4
# lspv
hdisk0      000919746edab91f  rootvg
hdisk1      0009197459d92f2e  None
hdisk2      00091974d381d097  uservg
hdisk3      00091974d81ff431  uservg
```

```
hdisk4      00091974de731316  None
hdisk5      00091974e4f3d56e  None
```

6.3.9 Extending a volume group to a defined physical volume

In this section, there exists a volume group called uservg on hdisk2. You are going to install a new disk and try to extend a uservg to use that drive.

List the volume groups to check what is available:

```
# lsvg
rootvg
uservg
newvg
```

List the disk devices on your system by entering:

```
# lsdev -Cc disk
hdisk0 Available 40-58-00-0,0 16 Bit SCSI Disk Drive
hdisk1 Available 40-58-00-1,0 16 Bit SCSI Disk Drive
hdisk2 Available 20-68-L      SSA Logical Disk Drive
hdisk3 Available 20-68-L      SSA Logical Disk Drive
```

Shut the system down and install the new device, boot the machine, log in as root, and then enter the following:

```
# lsdev -Cc disk
hdisk0 Available 40-58-00-0,0 16 Bit SCSI Disk Drive
hdisk1 Available 40-58-00-1,0 16 Bit SCSI Disk Drive
hdisk2 Available 20-68-L      SSA Logical Disk Drive
hdisk3 Available 20-68-L      SSA Logical Disk Drive
hdisk4 Defined   20-68-L      SSA Logical Disk Drive
```

To check the volume group uservg, enter:

```
# lsvg uservg
VOLUME GROUP:  uservg          VG IDENTIFIER:  000919742f85e776
VG STATE:      active         PP SIZE:        8 megabyte(s)
VG PERMISSION: read/write     TOTAL PPs:     537 (4296 megabytes)
MAX LVs:       256            FREE PPs:      336 (2688 megabytes)
LVs:           2              USED PPs:      201 (1608 megabytes)
OPEN LVs:     2              QUORUM:        2
TOTAL PVs:    1              VG DESCRIPTORS: 2
STALE PVs:    0              STALE PPs:     0
ACTIVE PVs:   1              AUTO ON:       yes
MAX PPs per PV: 1016        MAX PVs:       32
```

To extend the volume group uservg, enter the following:

```
smitty vg
```

Select the Set Characteristics of a Volume Group option from the Volume Groups menu, as displayed in Figure 6-27.

```
Volume Groups

Move cursor to desired item and press Enter.

List All Volume Groups
Add a Volume Group
Set Characteristics of a Volume Group
List Contents of a Volume Group
Remove a Volume Group
Activate a Volume Group
Deactivate a Volume Group
Import a Volume Group
Export a Volume Group
Mirror a Volume Group
Unmirror a Volume Group
Synchronize LVM Mirrors
Back Up a Volume Group
Remake a Volume Group
List Files in a Volume Group Backup
Restore Files in a Volume Group Backup

F1=Help      F2=Refresh   F3=Cancel    F8=Image
F9=Shell     F10=Exit    Enter=Do
```

Figure 6-27 Volume Groups menu

Select the Add a Physical Volume to a Volume Group option in the Set Characteristics of a volume group, menu as displayed in Figure 6-28 on page 118.

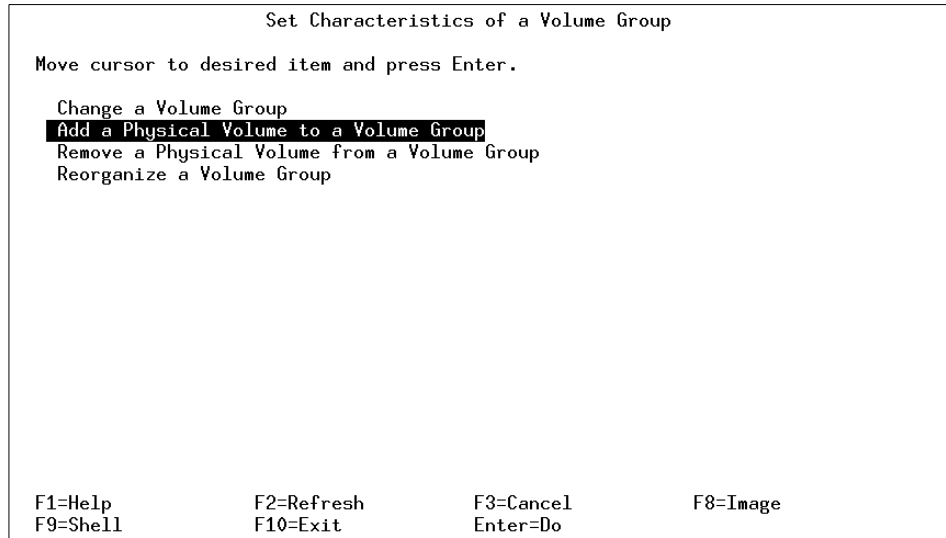

Figure 6-28 Set Characteristics of a Volume Group menu

From the Add a Physical Volume to a Volume Group menu, insert the Volume Group name and the Physical Volume names, as displayed in Figure 6-29.

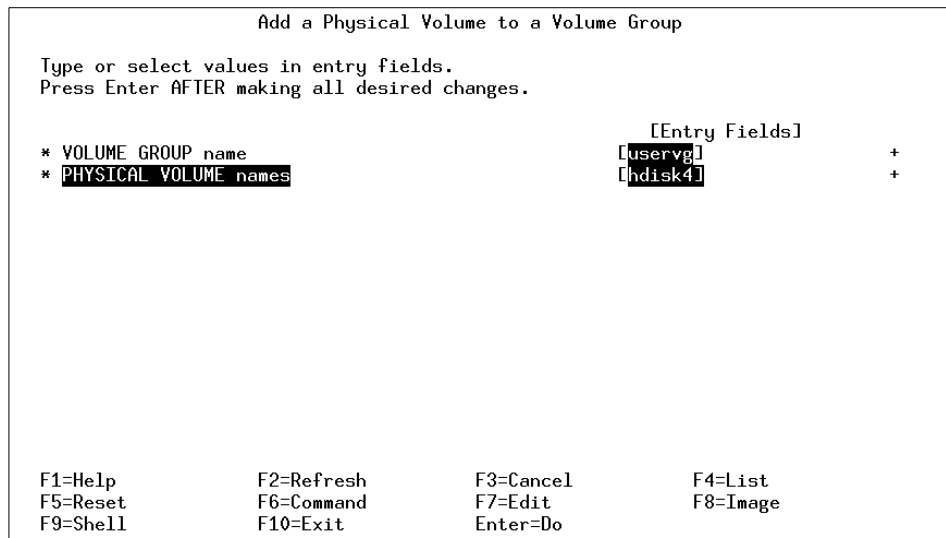

Figure 6-29 Add a Physical Volume to a Volume Group menu

Once the Volume Group and Physical Volume information has been entered, the system will display a confirmation message, as displayed in Figure 6-30.

```

                                Add a Physical Volume to a Volume Group

Type or select values in entry fields.
Press Enter AFTER making all desired changes.

                                [Entry Fields]
* VOLUME GROUP name                [uservg]      +
* PHYSICAL VOLUME names            [hdisk4]     +

                                ARE YOU SURE?

Continuing may delete information you may want
to keep. This is your last chance to stop
before continuing.
Press Enter to continue.
Press Cancel to return to the application.

F1  █                               F2=Refresh      F3=Cancel
F5  F1=Help                          F10=Exit       Enter=Do
F9
```

Figure 6-30 Add a Physical Volume to a Volume Group - confirmation screen

Figure 6-31 on page 120 shows the screen for the failed operation. The reason for the failure is that the disk is defined but not available.

```
COMMAND STATUS

Command: Failed          stdout: yes          stderr: no

Before command completion, additional instructions may appear below.

0516-024 hdisk4: Unable to open physical volume.
          Either PV was not configured or could not be opened. Run
          diagnostics.
0516-792 extendvg: Unable to extend volume group.

F1=Help          F2=Refresh      F3=Cancel      F6=Command
F8=Image         F9=Shell        F10=Exit       /=Find
n=Find Next
```

Figure 6-31 Add a Physical Volume to a Volume Group - Command Status

Press F10 to exit SMIT and then type the following:

```
# mkdev -l 'hdisk4'
hdisk4 Available
```

The device hdisk4 is now available for the system to create a volume group on.

Go back into the SMIT Volume Group Menu and enter:

```
smitty vg
```

Select the Set Characteristics of a Volume Group, as displayed in Figure 6-27 on page 117.

Select the Add a Physical Volume to a Volume Group, as displayed in Figure 6-28 on page 118.

Enter the Volume Group name and the Physical Volume names, as displayed in Figure 6-29 on page 118. At the confirmation window, press Enter to continue, as displayed in Figure 6-30 on page 119.

Once the process is complete, the Command Status screen will display OK for the successful completion of the command, as shown in Figure 6-32 on page 121.

```

                                COMMAND STATUS
Command: OK          stdout: no      stderr: no
Before command completion, additional instructions may appear below.
█

F1=Help      F2=Refresh   F3=Cancel    F6=Command
F8=Image     F9=Shell     F10=Exit     /=Find
n=Find Next

```

Figure 6-32 Add a Physical Volume to a Volume Group - Command Status

To check the volume group named `uservg`, enter:

```

# lsvg uservg
VOLUME GROUP:   uservg          VG IDENTIFIER:  000919742f85e776
VG STATE:       active          PP SIZE:        8 megabyte(s)
VG PERMISSION:  read/write      TOTAL PPs:      1074 (8592 megabytes)
MAX LVs:        256             FREE PPs:       873 (6984 megabytes)
LLVs:           2               USED PPs:       201 (1608 megabytes)
OPEN LVs:       2               QUORUM:         2
TOTAL PVs:      2               VG DESCRIPTORS: 3
STALE PVs:      2               STALE PPs:      0
ACTIVE PVs:     2               AUTO ON:        yes
MAX PPs per PV: 1016           MAX PVs:        32

```

6.4 Managing logical volumes

Physical volumes and volume groups are normally not addressed directly by users and applications to access data, and they cannot be manipulated to provide disk space for use by users and applications. However, logical volumes provide the mechanism to make disk space available for use, giving users and applications the ability to access data stored on them.

When you create a logical volume, you specify the number of logical partitions for the logical volume. A logical partition maps to one, two, or three physical partitions, depending on the number of copies of your data you want to maintain. For example, you can specify a logical volume to be mirrored and have more than one copy, as shown in Figure 6-33. One copy of the logical volume (the default) indicates that there is a direct mapping of one logical partition to one physical partition.

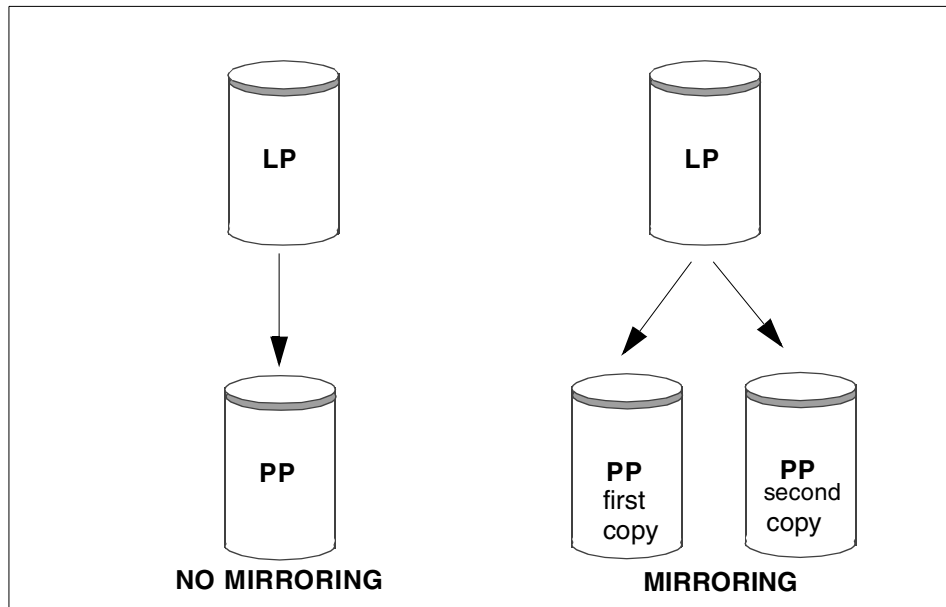

Figure 6-33 Mapping of LP to PP for mirrored and non-mirrored data

The management of logical volumes is, therefore, the management of disk space that is available for use. This section will review the functions that can be performed by users on logical volumes.

6.4.1 Adding a logical volume

You can create additional logical volumes with the `mklv` command. This command allows you to specify the name of the logical volume and define its characteristics, including the number and location of logical partitions to allocate for it. The default maximum size for a logical volume at creation is 128 logical partitions, unless specified to be larger.

Creating a logical volume using the command line

The `mk1v` command is used to create a new logical volume. Following is the syntax of the `mk1v` command and the most commonly used flags are shown in Table 6-4.

```
mk1v [ -a Position ] [ -b BadBlocks ] [ -c Copies ] [ -d Schedule ]
[ -e Range ] [ -i ] [ -L Label ] [ -m MapFile ] [ -r Relocate ] [ -s Strict ]
[ -t Type ] [ -u UpperBound ] [ -v Verify ] [ -w MirrorWriteConsistency ]
[ -x Maximum ] [ -y NewLogicalVolume | -Y Prefix ] [ -S StripeSize ]
[ -U Userid ] [ -G Groupid ] [-P Modes ] VolumeGroup Number
[ PhysicalVolume ... ]
```

Table 6-4 `mk1v` command flags

Flag	Description
-c <i>Copies</i>	Sets the number of physical partitions allocated for each logical partition. The copies variable can be set to a value from 1 to 3; the default is 1.
-i	Reads the <code>PhysicalVolume</code> parameter from standard input. Use the -i flag only when <code>PhysicalVolume</code> is entered through standard input.
-L	Sets the logical volume label. The default label is None. The maximum size of the label file is 127 characters. If the logical volume is going to be used as a journaled file system (JFS), then the JFS will use this field to store the mount point of the file system on that logical volume for future reference.
-P <i>Modes</i>	Specifies permissions (file modes) for the logical volume special file.
-t <i>Type</i>	Sets the logical volume type. The standard types are JFS (file systems), JFSLOG (journal file system logs), and paging (paging spaces), but a user can define other logical volume types with this flag. You cannot create a striped logical volume of type boot. The default is JFS. If a log is manually created for a file system, the user must run the <code>logform</code> command to clean out the new JFSLOG before the log can be used. Use the following command to format the logical volume logdev: <pre>logform /dev/logdev</pre> where <code>/dev/logdev</code> is the absolute path to the logical volume.
-y <i>NewLogicalVolume</i>	Specifies the logical volume name to use instead of using a system-generated name. Logical volume names must be unique systemwide names, and can range from 1 to 15 characters. If the volume group is varied on in concurrent mode, the new name should be unique across all the concurrent nodes the volume group is varied on. The name cannot begin with a prefix already defined in the PdDv class in the Device Configuration Database for other devices.

The following example shows the use of `mklv` command to create a new logical volume, `newlv`. This will create a logical volume called `newlv` in the `rootvg` and it will have 10 logical partitions and each logical partition consists of two physical partitions. The command is:

```
mklv -y newlv -c 2 rootvg 10
```

Creating a logical volume using SMIT

You can use the following SMIT hierarchy to create a logical volume:

1. Run the command `smitty mklv`.
2. Press F4 to get a list of all the volume groups that are defined in the system. A screen similar to Figure 6-34 will be shown.

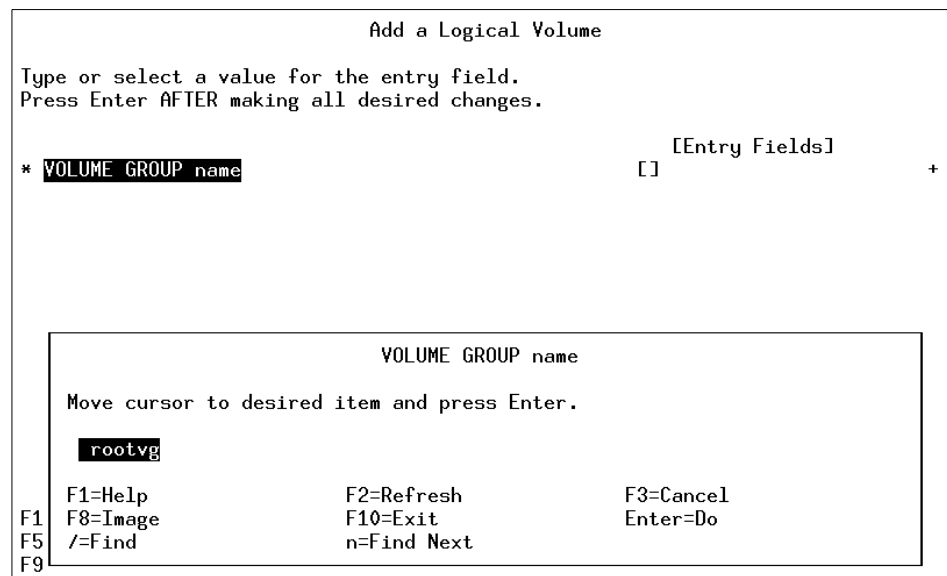

Figure 6-34 Selecting the volume group to hold the new logical volume

3. Use the arrow keys to select the volume group in which you want to create your new logical volume and press Enter. A screen similar to Figure 6-35 on page 125 will be shown.

```

                                Add a Logical Volume

Type or select values in entry fields.
Press Enter AFTER making all desired changes.

[TOP]                                [Entry Fields]
Logical volume NAME                    [ ]
* VOLUME GROUP name                    rootvg
* Number of LOGICAL PARTITIONS         [ ] #
PHYSICAL VOLUME names                  [ ] +
Logical volume TYPE                    [ ]
POSITION on physical volume            middle +
RANGE of physical volumes              minimum +
MAXIMUM NUMBER of PHYSICAL VOLUMES    [ ] #
to use for allocation
Number of COPIES of each logical      1 +
partition
Mirror Write Consistency?              yes +
Allocate each logical partition copy   yes +
[MORE...11]

F1=Help      F2=Refresh      F3=Cancel      F4=List
F5=Reset     F6=Command     F7=Edit       F8=Image
F9=Shell     F10=Exit       Enter=Do

```

Figure 6-35 Setting characteristics of the new logical volume

4. In the Logical volume NAME parameter, enter the name of the logical volume you are creating (newlv in this case).
5. In the Number of LOGICAL PARTITIONS parameter, enter the number of logical partitions you want to assign to your new logical volume (10 in this case). Each logical partition corresponds to one or more physical partitions, depending upon the number of copies of data you want to keep.
6. In the PHYSICAL VOLUME names parameter, enter the physical volumes that you want to use for this logical volume. If you do not specify any names, the first PV in the system will be used to place all the data on.
7. In the Number of COPIES of each logical partition parameter, enter the number of copies that you want for your data. If you want to mirror your data change, the default is from 1 to a maximum of 3.
8. Press Enter to create the logical volume.

6.4.2 Removing a logical volume

You may need to remove a logical volume if it is no longer in use for storage purposes by users and applications. The `rm1v` command can be used to remove a logical volume.

Removing a logical volume using the command line

The `rmlv` command is used to remove a logical volume. The general syntax of the command and its commonly used flags are shown in Table 6-5. The command is:

```
rmlv [ -f ] [ -p PhysicalVolume ] LogicalVolume ...
```

Table 6-5 `rmlv` command flags

Flag	Description
-f	Removes the logical volumes without requesting confirmation.
-p <i>PhysicalVolume</i>	Removes only the logical partition on the <i>PhysicalVolume</i> . The logical volume is not removed unless there are no other physical partitions allocated.

The following example shows the command to remove a logical volume, `newlv`:

```
# rmlv newlv
Warning, all data on logical volume newlv will be destroyed.
rmlv: Do you wish to continue? y(es) n(o) y
#
```

Entering a `y` as the response to this dialogue and pressing `Enter` will complete the process of deletion of a logical volume.

Removing a logical volume using SMIT

You can use the SMIT fast path `smitty rmlv` to remove a logical volume.

Removing a logical volume when rootvg is full

In this section, you will attempt to remove the logical volume `templv`, but with a few surprises, when the `rootvg` is full.

Unmount the logical volume:

```
umount /dev/templv
```

Remove the logical volume:

```
# rmlv templv
Warning, all data contained on logical volume templv will be destroyed.
rmlv: Do you wish to continue? y(es) n(o)? y
/tmp/lvmap11780: There is not enough space in the file system.
0516-912 rmlv: Unable to remove logical volume templv.
```

While removing the logical volume, you receive the preceding error message. Check the disk space by entering:

```
# df
Filesystem      512-blocks      Free %Used    Iused %Iused Mounted on
/dev/hd4         32768            0 100%     1868   16% /
/dev/hd2        4702208          0 100%    51167    9% /usr
/dev/hd9var     16384            0 100%     183     9% /var
/dev/hd3         32768            0 100%      34     1% /tmp
/dev/hd1         16384            8 100%      49     3% /home
/dev/userlv     16793600        9968728  41%      21     1% /u
```

The file systems `/`, `/usr`, `/var`, `/tmp`, and `/home` are full. There are two options to fix this problem:

1. Check the file systems and find unused or obsolete files that can be removed.
2. Increase the size of the file systems, if you have enough disk space, or add an additional drive and use the **extendvg** command to add the drive to the rootvg, then increase the size of the file systems.

After investigation, you will find that there is a file called `bigfile`, which is an unused file that is taking up space on the file system `/tmp` and `/home`. Delete this file from the two file systems. The other file systems will be resized using the **chfs** command.

To delete the obsolete files from `/tmp` and `/home`, do the following:

```
# rm /tmp/bigfile
# rm /home/bigfile
# df
Filesystem      512-blocks      Free %Used    Iused %Iused Mounted on
/dev/hd4         49152            0 100%     1868   16% /
/dev/hd2        4702208          0 100%    51167    9% /usr
/dev/hd9var     16384            0 100%     183     9% /var
/dev/hd3         32768           31568    4%       33     1% /tmp
/dev/hd1         16384           15656    5%       48     3% /home
/dev/userlv     16793600        9968728  41%      21     1% /u
```

To resize the other three file systems, enter:

```
smitty jfs
```

From the Journalled File Systems menu select the Change / Show Characteristics of a Journalled File System option, as displayed in Figure 6-36 on page 128.

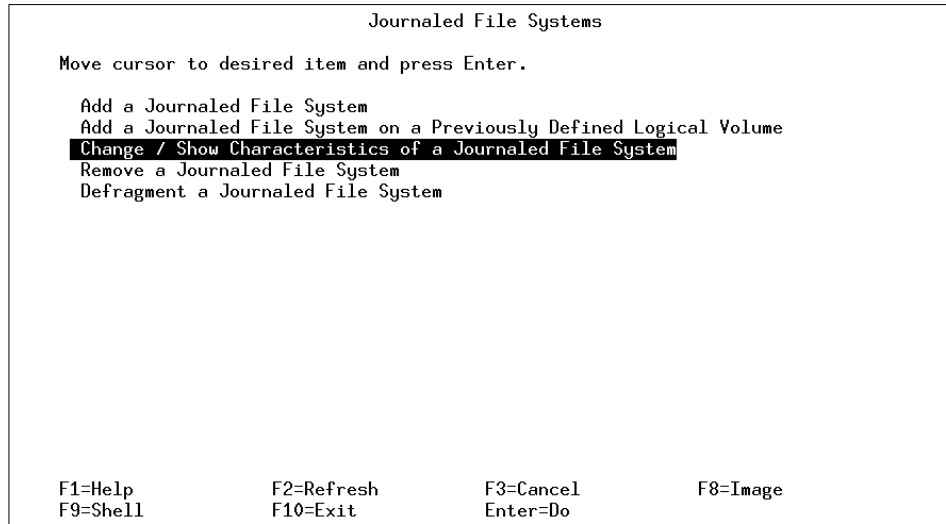

Figure 6-36 Journalled File Systems menu

Once the Change / Show Characteristics of a Journalled File System option has been taken, a File System Name submenu will appear. Select the file system to which changes will be made, as displayed in Figure 6-37.

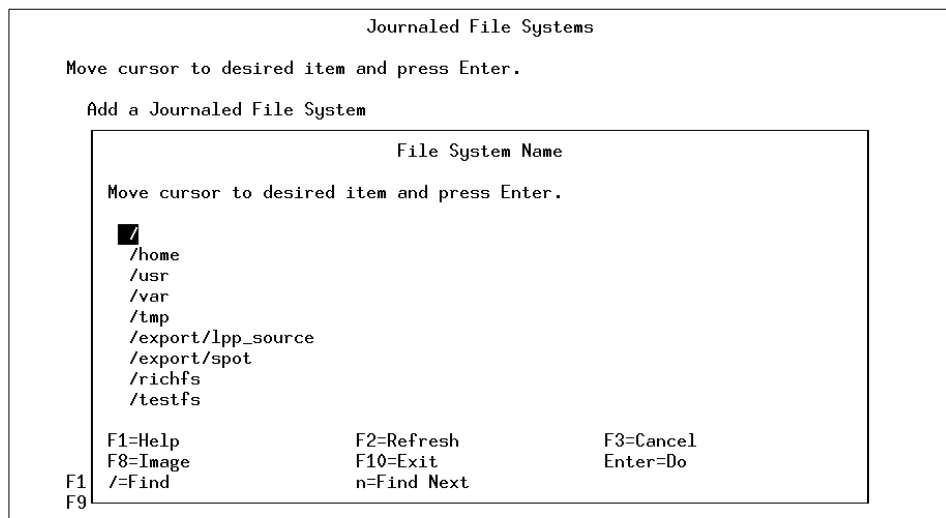

Figure 6-37 File System Name submenu

Figure 6-38 on page 129 shows the original characteristics of the / (root) file systems. Go down to the Size of file system (in 512-byte blocks) option.

```

Change / Show Characteristics of a Journaled File System

Type or select values in entry fields.
Press Enter AFTER making all desired changes.

                                     [Entry Fields]
File system name                       /
NEW mount point                       [/]
SIZE of file system (in 512-byte blocks) [32768]
Mount GROUP                            [bootfs]
Mount AUTOMATICALLY at system restart? yes                               +
PERMISSIONS                            read/write                       +
Mount OPTIONS                           []                               +
Start Disk Accounting?                  no                               +
Fragment Size (bytes)                   4096
Number of bytes per inode                2048
Compression algorithm                   no
Large File Enabled                       false
Allocation Group Size (MBytes)          8

F1=Help      F2=Refresh      F3=Cancel      F4=List
F5=Reset     F6=Command     F7=Edit       F8=Image
F9=Shell     F10=Exit       Enter=Do

```

Figure 6-38 Original characteristics of a journaled file system

Figure 6-39 shows the same menu as Figure 6-38, except the Size of file system (in 512-byte blocks) has been changed. The size can only be increased.

```

Change / Show Characteristics of a Journaled File System

Type or select values in entry fields.
Press Enter AFTER making all desired changes.

                                     [Entry Fields]
File system name                       /
NEW mount point                       [/]
SIZE of file system (in 512-byte blocks) [49152]
Mount GROUP                            [bootfs]
Mount AUTOMATICALLY at system restart? yes                               +
PERMISSIONS                            read/write                       +
Mount OPTIONS                           []                               +
Start Disk Accounting?                  no                               +
Fragment Size (bytes)                   4096
Number of bytes per inode                2048
Compression algorithm                   no
Large File Enabled                       false
Allocation Group Size (MBytes)          8

F1=Help      F2=Refresh      F3=Cancel      F4=List
F5=Reset     F6=Command     F7=Edit       F8=Image
F9=Shell     F10=Exit       Enter=Do

```

Figure 6-39 New characteristics of a journaled file system

In Figure 6-40, the Command Status window displaying the success of the operation to increase the size of a file system is shown.

```
COMMAND STATUS

Command: OK          stdout: yes          stderr: no

Before command completion, additional instructions may appear below.

Filesystem size changed to 40960

F1=Help          F2=Refresh          F3=Cancel          F6=Command
F8=Image         F9=Shell            F10=Exit           /=Find
n=Find Next
```

Figure 6-40 smitty jfs Command Status screen

Press F10 to exit out of the SMIT system and go back to the command line.

To check the new size of the file system, enter:

```
# df
Filesystem      512-blocks      Free %Used    Iused %Iused Mounted on
/dev/hd4         49152          25856  48%      1867   16% /
/dev/hd2        4702208           0 100%    51167    9% /usr
/dev/hd9var     16384           0 100%     183    9% /var
/dev/hd3        32768          31568   4%        33    1% /tmp
/dev/hd1        16384          15656   5%         48    3% /home
/dev/userlv    16793600      9968728  41%        21    1% /u
```

To change the size of the /usr and /var file systems from the command line, enter:

```
# chfs -a size='5000000' /usr
Filesystem size changed to 5013504
# chfs -a size='32768' /var
Filesystem size changed to 32768
```

To check the size of the file systems, enter:

```
# df
Filesystem      512-blocks      Free %Used    Iused %Iused Mounted on
/dev/hd4         49152          25848   48%      1867   16% /
/dev/hd2        5013504       301520   94%     51167    9% /usr
/dev/hd9var     32768         15864   52%       183    5% /var
/dev/hd3        32768         31568    4%        33    1% /tmp
/dev/hd1        16384         15656    5%         48    3% /home
/dev/userlv     16793600     9968728  41%        21    1% /u
```

All of the file systems now have additional space. Remove the logical volume by entering the following:

```
# rmlv templv
Warning, all data contained on logical volume templv will be destroyed.
rmlv: Do you wish to continue? y(es) n(o)? y
rmlv: Logical volume templv is removed.
```

The logical volume has been removed. To remove the volume group, enter:

```
# reducevg -df tempvg hdisk4
rmlv: Logical volume loglv01 is removed.
ldeletepv: Volume Group deleted since it contains no physical volumes.
```

The volume group has been removed and the physical volume made available for use on another volume group. To verify this, enter:

```
# lspv
hdisk0          000919746edab91f   rootvg
hdisk1          0009197459d92f2e   None
hdisk2          00091974d381d097   uservg
hdisk3          00091974d81ff431   uservg
hdisk4          00091974de731316   None
hdisk5          00091974e4f3d56e   None
hdisk6          0009197425444544   raidvg
```

6.4.3 Reducing the size of a logical volume

The following steps could be performed to reduce the size of a logical volume to free up the excess logical partition allocation:

1. Back up all data in the logical volume.
2. Remove the logical volume.
3. Recreate the logical volume with the reduced logical partition allocation.
4. Restore the data.

The resulting free space could be put to better use by allocating it to other logical volumes requiring it.

6.4.4 Increasing the size of a logical volume

An existing logical volume can be increased in size by using the **extendlv** command or SMIT.

If the logical volume is used by a journaled file system, you can also use the **chfs** command or SMIT fast path command **smitty chjfs** to increase the size of the logical volume.

Extending a logical volume using the command line

The **extendlv** command is used to increase the size of a logical volume. The following is the general syntax of the command and its commonly used flags:

```
extendlv [ -a Position ] [ -e Range ] [ -u Upperbound ] [ -s Strict ]  
LogicalVolume Partitions [ PhysicalVolume ... ]
```

The following example shows the use of the **extendlv** command to add three more logical partitions to the logical volume you created:

```
extendlv newlv 3
```

Extending a logical volume using SMIT

The SMIT fast path **smitty extendlv** can be used to increase the size of a logical volume.

6.4.5 Copying a logical volume

Logical volumes may need to be copied for a number of reasons. If a disk is to be removed and replaced with a new disk, the logical volumes on that disk will need to be copied to the new disk. Logical volumes can be copied to new logical volumes or to existing logical volumes, which are then overwritten.

Copying a logical volume using the command line

The following example shows the use of **cp1v** command to copy a logical volume:

```
cp1v -v myvg -y newlv oldlv
```

This copies the contents of **oldlv** to a new logical volume called **newlv** in the volume group **myvg**. If the volume group is not specified, the new logical volume will be created in the same volume group as the old logical volume. This command creates a new logical volume.

The following example demonstrates how to copy a logical volume to an existing logical volume:

```
cp1v -e existinglv oldlv
```

This copies the contents of oldlv to the logical volume existinglv. Confirmation for the copy will be requested, as all data in existinglv will be overwritten.

If existinglv is smaller than oldlv, then data will be lost, probably resulting in corruption.

Note: Do not copy from a larger logical volume containing data to a smaller one. Doing so results in a corrupted file system because some data (including the superblock) is not copied. This command will fail if the **cp1v** creates a new logical volume and the volume group is varied on in concurrent mode.

Copying a logical volume using SMIT

Alternatively, you can use the SMIT fast path **smitty cp1v** to obtain a screen, as shown in Figure 6-41.

```
Copy a Logical Volume

Move cursor to desired item and press Enter.

Copy over an existing logical volume
Copy to a user created logical volume
Copy to a system created logical volume

F1=Help      F2=Refresh   F3=Cancel    F8=Image
F9=Shell     F10=Exit    Enter=Do
```

Figure 6-41 *smitty cp1v* command

1. Select Copy over an existing logical volume. A screen similar to Figure 6-42 on page 134 will be shown.

```

Copy over an existing logical volume

Type or select values in entry fields.
Press Enter AFTER making all desired changes.

* SOURCE logical volume name
* DESTINATION logical volume

[Entry Fields]
[]
[]

F1=Help      F2=Refresh   F3=Cancel    F4=List
F5=Reset     F6=Command   F7=Edit      F8=Image
F9=Shell     F10=Exit     Enter=Do

```

Figure 6-42 Selecting source and destination logical volumes

2. Enter the name of the logical volume you want to copy in the SOURCE logical volume name parameter
3. Enter the name of the logical volume on which you want to copy your existing logical volume to in the DESTINATION logical volume name field. This name can be of an existing logical volume that you have already created or it can be a new logical volume that you want to create. Press Enter to complete this step.

Note: You might encounter the following error:

```
chlv : Destination logical volume must have type set to copy
```

If this is the case, use the following command:

```
chlv -t copy <Destination Logical Volume Name>
```

Return to your SMIT session. Now the system will allow you to copy the logical volume. This has been done to ensure extra security so that you do not overwrite your data accidentally.

6.4.6 Listing logical volumes

The following logical volumes are automatically created at the system installation time:

hd5	This is the boot logical volume that holds the boot code. It is available only at the system startup time.
hd6	This is the default paging space logical volume that is used by the system to perform paging.
hd8	This logical volume is used as the default logging space for the journaled file systems.
hd4	This logical volume is used by the / (root) file system.
hd2	This logical volume is used by the /usr file system.
hd9var	This logical volume is used by the /var file system.
hd3	This logical volume is used by the /tmp file system.
hd1	This logical volume is used by the /home file system.

Figure 6-43 lists all the logical volumes defined on the system, which were found by running:

```
lsvg | lsvg -il
```

LV NAME	TYPE	LPs	PPs	PVs	LV STATE	MOUNT POINT
hd5	boot	2	2	1	closed/syncd	N/A
hd6	paging	32	32	1	open/syncd	N/A
hd8	jfslog	1	1	1	open/syncd	N/A
hd4	jfs	4	4	1	open/syncd	/
hd2	jfs	123	123	1	open/syncd	/usr
hd9var	jfs	1	1	1	open/syncd	/var
hd3	jfs	4	4	1	open/syncd	/tmp
hd1	jfs	1	1	1	open/syncd	/home
lv00	jfs	4	4	1	closed/syncd	/usr/vice/cache
lv01	jfs	3	3	1	open/syncd	/var/dce
lv02	jfs	10	10	1	closed/syncd	/var/dce/adm/dfs/c
ache						
lvtest	???	3	6	1	open/syncd	/test
lvbkup	???	3	3	1	closed/syncd	N/A
lv03	jfs	108	108	1	closed/syncd	/export/lpp_source
_1						
lv04	jfs	53	53	1	closed/syncd	/export/spot_1
lv05	jfs	158	158	1	closed/syncd	/work
lv06	jfs	5	5	1	closed/syncd	/home2
lv07	jfs	1	1	1	open/syncd	/auto1
lv08	jfs	1	1	1	closed/syncd	/auto2
Standard input						

Figure 6-43 Logical volume listing

The `lslv` command can be used to view all the attributes related to a logical volume (`newlv`), as shown in Figure 6-44.

```
# lslv newlv
LOGICAL VOLUME:      newlv          VOLUME GROUP:      rootvg
LV IDENTIFIER:       00615147b27f2b40.26  PERMISSION:         read/write
VG STATE:            active/complete  LV STATE:           closed/syncd
TYPE:                jfs              WRITE VERIFY:       off
MAX LPs:             512              PP SIZE:            4 megabyte(s)
COPIES:              1                SCHED POLICY:       parallel
LPs:                 1                PPs:                1
STALE PPs:           0                BB POLICY:          relocatable
INTER-POLICY:        minimum           RELOCATABLE:        yes
INTRA-POLICY:        middle            UPPER BOUND:        32
MOUNT POINT:         N/A              LABEL:              None
MIRROR WRITE CONSISTENCY: on
EACH LP COPY ON A SEPARATE PV?: yes
# █
```

Figure 6-44 Logical volume attributes

6.4.7 Logical volume size

The size of a logical volume is the space that is allocated to the logical volume and is a factor of the number of logical partitions that are allocated to the logical volume and the number of copies that you have told the system to maintain. Therefore, the total space taken up by the logical volume is determined by the following formula:

Total LV size=PP size * LPs assigned to LV * Number of copies of the LV

If PP size is 4 MB, LPs assigned to the logical volume are 10, and the number of copies of the logical volume are 2, then the total space that will be allocated to this logical volume will be 80 MB (4*10*2).

6.4.8 Other logical volume characteristics

The AIX LVM provides a number of facilities or *policies* for managing both the performance and availability characteristics of logical volumes. The policies that have the greatest impact on performance are *Intra-disk allocation*, *inter-disk allocation*, *I/O scheduling*, and *write-verify policies*.

Intra-disk allocation policy

The intra-disk allocation policy determines the actual physical location of the physical partitions on disk. A disk is logically divided into the following five concentric areas as follows, and as shown in Figure 6-45:

- ▶ Outer edge
- ▶ Outer middle
- ▶ Center
- ▶ Inner middle
- ▶ Inner edge

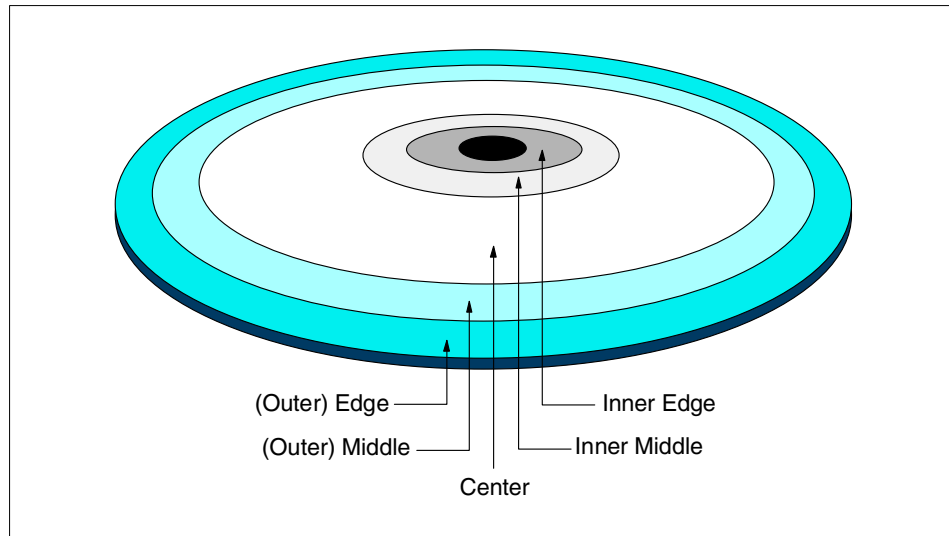

Figure 6-45 Physical partition mapping

Due to the physical movement of the disk actuator, the outer and inner edges typically have the largest average seek times and are a poor choice for application data that is frequently accessed. The center region provides the fastest average seek times and is the best choice for paging space or applications that generate a significant amount of random I/O activity. The outer and inner middle regions provide better average seek times than the outer and inner edges but worse seek times than the center region.

As a general rule, when designing a logical volume strategy for performance, the most performance critical data should be placed as close to the center of the disk as possible. There are, however, two notable exceptions:

1. Applications that perform a large amount of sequential reads or writes experience higher throughput when the data is located on the outer edge of the disk due to the fact that there are more data blocks per track on the outer edge of the disk than the other disk regions.

2. Logical volumes with Mirrored Write Consistency (MWC) enabled should also be located at the outer edge of the disk, as this is where the MWC cache record is located

When the disks are setup in a RAID5 configuration, the intra-disk allocation policy will not have any benefits to performance.

Inter-disk allocation policy

The inter-disk allocation policy is used to specify the number of disks that contain the physical partitions of a logical volume. The physical partitions for a given logical volume can reside on one or more disks in the same volume group, depending on the setting of the *Range* option. The range option can be set using the `smitty mk1v` command and changing the RANGE of physical volumes menu option.

- ▶ The maximum range setting attempts to spread the physical partitions of a logical volume across as many physical volumes as possible in order to decrease the average access time for the logical volume.
- ▶ The minimum range setting attempts to place all of the physical partitions of a logical volume on the same physical disk. If this cannot be done, it will attempt to place the physical partitions on as few disks as possible. The minimum setting is used for increased availability only and should not be used for frequently accessed logical volumes. If a non-mirrored logical volume is spread across more than one drive, the loss of any of the physical drives will result in data loss. In other words, a non-mirrored logical volume spread across two drives will be twice as likely to experience a loss of data as one that resides on only one drive.

The physical partitions of a given logical volume can be mirrored to increase data availability. The location of the physical partition copies is determined by the setting of the *Strict* option with the `smitty mk1v` command called Allocate each logical partition copy. When *Strict* = y, each physical partition copy is placed on a different physical volume. When *Strict* = n, the copies can be on the same physical volume or different volumes. When using striped and mirrored logical volumes in AIX Version 4.3.3 and above, there is an additional partition allocation policy known as *superstrict*. When *Strict* = s, partitions of one mirror cannot share the same disk as partitions from a second or third mirror, thus further reducing the possibility of data loss due to a single disk failure.

In order to determine the data placement strategy for a mirrored logical volume, the settings for both the Range and Strict options must be carefully considered. As an example, consider a mirrored logical volume with range setting of minimum and a strict setting of yes. The LVM would attempt to place all of the physical partitions associated with the primary copy on one physical disk, with the mirrors

residing on either one or two additional disks, depending on the number of copies of the logical volume (2 or 3). If the strict setting were changed to no, all of the physical partitions corresponding to both the primary and mirrors would be located on the same physical disk.

I/O-scheduling policy

The default for logical volume mirroring is that the copies should use different disks. This is both for performance and data availability. With copies residing on different disks, if one disk is extremely busy, then a read request can be completed using the other copy residing on a less busy disk. Different I/O scheduling policies can be set for logical volumes. The different I/O scheduling policies are as follows:

- | | |
|-------------------|---|
| Sequential | The sequential policy results in all reads being issued to the primary copy. Writes happen serially, first to the primary disk; only when that is completed is the second write initiated to the secondary disk. |
| Parallel | The parallel policy balances reads between the disks. On each read, the system checks whether the primary is busy. If it is not busy, the read is initiated on the primary. If the primary is busy, the system checks the secondary. If it is not busy, the read is initiated on the secondary. If the secondary is busy, the read is initiated on the copy with the least number of outstanding I/Os. Writes are initiated concurrently. |

AIX 5L Version 5.1 introduces two additional policies, as follows:

- | | |
|-----------------------------|---|
| Parallel/sequential | The parallel/sequential policy always initiates reads on the primary copy. Writes are initiated concurrently. |
| Parallel/round robin | The parallel/round robin policy is similar to the parallel policy except that instead of always checking the primary copy first, it alternates between the copies. This results in equal utilization for reads even when there is never more than one I/O outstanding at a time. Writes are initiated concurrently. |

Write-verify policy

When the write-verify policy is enabled, all write operations are validated by immediately performing a follow-up read operation of the previously written data. An error message will be returned if the read operation is not successful. The use of write-verify enhances the integrity of the data but can drastically degrade the performance of disk writes.

6.5 Managing journaled file systems

A file system is a set of files, directories, and other structures. File systems maintain information and identify the location of a file or directory's data. In addition to files and directories, file systems contain a boot block, a superblock, bitmaps, and one or more allocation groups. An allocation group contains disk i-nodes and fragments.

The following three types of file systems are supported on an AIX system.

Journaled file system This native file system type is called the journaled file system (JFS). Each journaled file system resides on a separate logical volume. The operating system mounts journaled file systems during initialization.

Network file system The network file system (NFS) is a distributed file system that allows users to access files and directories located on remote computers and use those files and directories as if they are local.

CD-ROM file system The CD-ROM file system (CDRFS) is a file system type that allows you to access the contents of a CD-ROM through the normal file system interfaces.

The journaled file system (JFS) divides the logical volume into a number of fixed size units called logical blocks. The logical blocks in the file system are organized as follows:

Logical block 0 The first logical block in the file system is reserved and available for a bootstrap program or any other required information; this block is unused by the file system.

Superblock The first and thirty-first logical blocks are reserved for the superblock (logical block 31 being a backup copy). The super block contains information, such as the overall size of the file system in 512 byte blocks, the file system name, file system log device address (logs will be covered later in this section), version number, and file system state.

Allocation groups The rest of the logical blocks in the file system are divided into a number of allocation groups. An allocation group consists of data blocks and i-nodes to reference those data blocks when they are allocated to directories or files.

6.5.1 Characteristics of the journaled file system

The size for a journaled file system (JFS) is defined when the file system is created. Consider the following parameters:

- ▶ Number of i-nodes
- ▶ Allocation group size
- ▶ File system fragment addressability
- ▶ Journaled file system log size
- ▶ Maximum journaled file system size

Number of i-nodes

The total number of i-nodes in a file system limits the total number of files and the total size of the file system. The JFS provides the nbpi (number of bytes per i-node) parameter that affects the number of i-nodes in a file system. JFS supports nbpi values of 512, 1024, 2048, 4096, 8192, 16384, 32768, 65536, and 131072. The values 32768, 65536, and 131072 only apply to AIX Version 4.2 or later.

For example, to create an 8 MB file system with an nbpi value of 4096, an i-node will be generated for each 4096 bytes of data. This would result in a maximum of 2048 i-nodes for an 8 MB file system, which means that if every file in the file system is ideally 4 KB in length, a maximum of 2048 files can be created in the file system.

The JFS restricts all file systems to 16 MB (2^{24}) i-nodes.

Allocation group size

AIX Version 4.2 or later supports various allocation group sizes. The JFS segregates file system space into groupings of i-nodes and disk blocks for user data. These groupings are called allocation groups. The allocation group size can be specified when the file system is created. The allocation group sizes are 8 MB, 16 MB, 32 MB, and 64 MB. Each allocation group size has an associated nbpi range. The ranges are defined in Table 6-6.

Table 6-6 Allowable nbpi values

Allocation group size in MB	Maximum number of i-nodes
8	512, 1024, 2048, 4096, 8192, and 16384
16	1024, 2048, 4096, 8192, 16384, and 32768
32	2048, 4096, 8192, 16384, 32768, and 65536
64	4096, 8192, 16384, 32768, 65536, and 131072

File system fragment addressability

The JFS supports four fragment sizes: 512, 1024, 2048, and 4096 byte units of contiguous disk space. The JFS maintains fragment addresses in i-nodes and indirect blocks as 28-bit numbers. Each fragment must be addressable by a number from 0 to 256 MB (2^{28}).

The journaled file system log

Multiple journaled file systems use a common log, called a JFS log, configured to be 4 MB in size. For example, after initial installation, all file systems within the root volume group use logical volume hd8 as a common JFS log. The default logical volume partition size is 4 MB (for volume groups containing disks \leq 4 GB), and the default log size is one partition; therefore, the root volume group normally contains a 4 MB JFS log. When file systems exceed 2 GB or when the total amount of file system space using a single log exceeds 2 GB, the default log size needs to be increased. The JFS log is limited to a maximum size of 256 MB.

Maximum journaled file system size

The maximum JFS size is defined when the file system is created. For example, selecting an nbpi ratio of 512 will limit the file system to a size of 8 GB ($512 * 2^{24} = 8$ GB). When creating a JFS file system, the factors listed (nbpi, fragment size, and allocation group size) need to be weighed carefully. The file system size limitation is the minimum of $NPBI * 2^{24}$ or $Fragment\ Size * 2^{28}$.

6.5.2 Characteristics of the enhanced journaled file system

AIX 5L Version 5.1 introduces the Journaled File System 2 (JFS2). JFS2 is an enhanced and updated version of the JFS on AIX Version 4.3 and previous releases. Table 6-7 highlights the differences between the JFS and the JFS2.

Table 6-7 Journaled file system differences

Function	JFS	JFS2
Architectural maximum file	64 GB	1 PB ^a
Architectural maximum file system size	1 TB ^b	4 PB
Maximum file size tested	64 GB	1 TB
Number of i-nodes	Fixed, set at file system creation	Dynamic, limited by disk space
Directory organization	Linear	B-tree
Compression	Yes	No

Function	JFS	JFS2
Default ownership at creation	sys.sys	root.system
SGID of default file mode	SGID=on	SGID=off
Quotas	Yes	No

a. PB stands for Petabytes, which is equal to 1,048,576 GB.

b. TB stands for Terabytes, which is equal to 1,024 GB.

Compatibility

In some cases, there will be many servers coexisting with different levels of AIX in a data center. From the JFS point of view, you can only import volume groups and mount file systems from AIX Version 4 to AIX 5L servers. It is not possible to mount the JFS2 file system on AIX Version 4 machines.

Migration

There is no LVM nor JFS command that migrates JFS volumes automatically. It is possible to migrate JFS volumes in two different ways:

1. Back up the file system, remove it, and recreate it in the JFS2 type, then restore the data to the new file system.
2. If there is enough disk space available in the volume group, it is possible to create a new JFS2 file system structure with the same attributes, and just copy all the files from one file system to another.

JFS2 rootvg support for 64-bit systems

AIX 5L Version 5.1 introduces a feature to set all file systems in the rootvg as JFS2 type file systems. While installing a system with the complete overwrite option, you can enable the 64-bit kernel and JFS2. If this option is enabled, the installation task will create JFS2 file systems in the rootvg.

To create user-defined JFS2 file systems in AIX 5L Version 5.1, use either the SMIT fast path `smitty jfs2` or the `crfs` command with the `-v jfs2` flag.

6.5.3 Creating a file system

Every file system in AIX corresponds to a logical volume. In order to create a journaled file system, use the following SMIT hierarchy.

1. Executing the SMIT fast path command `smitty crjfs` will show a screen similar to Figure 6-46 on page 144.

```

                                Add a Journaled File System

Move cursor to desired item and press Enter.

Add a Standard Journaled File System
Add a Compressed Journaled File System
Add a Large File Enabled Journaled File System

F1=Help          F2=Refresh      F3=Cancel      F8=Image
F9=Shell         F10=Exit       Enter=Do

```

Figure 6-46 smitty crjfs command

2. Select Add a Standard Journaled File System to add a new journaled file system. A screen similar to Figure 6-47 is displayed.

```

                                Add a Journaled File System

Move cursor to desired item and press Enter.

Add a Standard Journaled File System
Add a Compressed Journaled File System
Add a Large File Enabled Journaled File System

                                Volume Group Name

Move cursor to desired item and press Enter.

                                rootvg

F1=Help          F2=Refresh      F3=Cancel
F8=Image         F10=Exit       Enter=Do
F1 /:=Find       n=Find Next
F9

```

Figure 6-47 Selecting the volume group to hold the new file system

3. Select the volume group you want to add this new file system to by using the arrow keys. In this case, since there is only one volume group (rootvg), only rootvg is displayed. Select rootvg as your target volume group by pressing the Enter key.
4. Once you select the target volume group, a screen similar to Figure 6-48 is displayed.

```

Add a Standard Journaled File System

Type or select values in entry fields.
Press Enter AFTER making all desired changes.

Volume group name                               [Entry Fields]
* SIZE of file system (in 512-byte blocks)       rootvg #
* MOUNT POINT                                   []
Mount AUTOMATICALLY at system restart?         no +
PERMISSIONS                                     read/write +
Mount OPTIONS                                   [] +
Start Disk Accounting?                          no +
Fragment Size (bytes)                           4096 +
Number of bytes per inode                       4096 +
Allocation Group Size (MBytes)                  8 +

F1=Help      F2=Refresh      F3=Cancel      F4=List
F5=Reset     F6=Command     F7=Edit       F8=Image
F9=Shell    F10=Exit      Enter=Do

```

Figure 6-48 Setting characteristics of the new file system

5. In the Size of file system (in 512 byte blocks) parameter, enter the size of the file system you want to create. For example, if you want to create a file system of 4 MB size, you can simply multiply the number of megabytes (four in this case) with 2048 to get 512-byte blocks you will need to create a file system this large (8192 in this case).

Note: In AIX, all of the I/O is in 4 KB blocks, but space is allocated in multiples of 512 byte blocks. This is done just to remain consistent with other UNIX systems. The smallest file system that you can create is equal to one PP, so even if you mention the number of blocks to be less than one PP, the system will still create a file system equal to one PP. The following example shows how to calculate the number of blocks for a given amount of space in MB.

Because 512 bytes = 1 block, 1024 bytes = 2 blocks, and because 1MB = 2*1024 blocks, x MB = x * 2048 blocks

This indicates that the equivalent number of blocks for a file system of 2 MB are 4096 (Enter this number in the Size of File System field).

- Next, in the MOUNT POINT parameter, enter the full path where you want your file system to attach itself to in the file system hierarchy. A mount point is a directory or file at which the new file system, directory, or file is made accessible.
- Press Enter to create the journaled file system. The screen shown in Figure 6-49 indicates the successful completion of the process.

```
COMMAND STATUS
Command: OK          stdout: yes          stderr: no
Before command completion, additional instructions may appear below.
Based on the parameters chosen, the new /dummy JFS file system
is limited to a maximum size of 134217728 (512 byte blocks)
New File System size is 8192

F1=Help          F2=Refresh        F3=Cancel         F6=Command
F8=Image         F9=Shell          F10=Exit          /=Find
n=Find Next
```

Figure 6-49 smitty crjfs results

Alternatively, you can achieve the same task on the command line using the following command:

```
crfs -v jfs -g rootvg -a size=8192 -m /dummy
```

This will create a journaled file system of 4 MB with /dummy as the mount point in the rootvg volume group.

6.5.4 Mounting a file system

Mounting is a concept that makes file systems, files, directories, devices, and special files available for use at a particular location. It is the only way a file system is made accessible. Once you have created the file system, the next task is to make it available to your users. In order to do that, you must know how AIX manages the patching of the newly created file systems into its file tree using the mount points.

Figure 6-50 shows a file system mount point (/u/kenzie) before a file system is mounted over it.

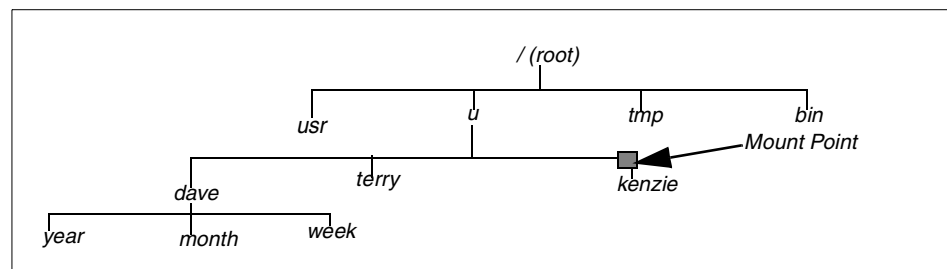

Figure 6-50 File tree view before mounting

Figure 6-51 shows a mounted file system /u/kenzie over the /u/kenzie mount point.

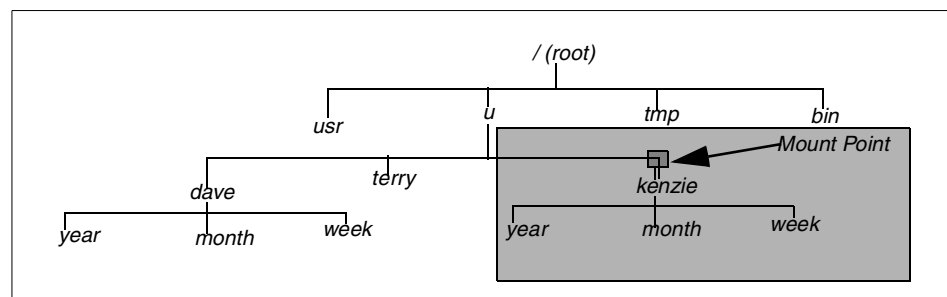

Figure 6-51 File tree view after mounting

Note:

- ▶ When a file system is mounted over a directory, the permissions of the root directory of the mounted file system take precedence over the permissions of the mount point.
- ▶ A common problem is failure of the `pwd` command. Without search permission in the mounted-over directory, the `pwd` command returns the following message:

```
pwd: Permission denied
```

This problem can be avoided by always setting the permissions of the mounted-over directory to at least 111.

Mounting a file system using the command line

The following command shows how to mount a file system (/FileSystemX):

```
mount /FileSystemX
```

Alternatively, if you know the name of the device associated with your file system, you can use the device name to mount your newly created file system.

If you want to mount all the file systems, you can use the following command to mount all the file systems at one time:

```
mount {-a|all}
```

Mounting a file system using SMIT

A file system can be also be mounted using the following SMIT fast path hierarchy.

1. Executing `smitty mount` will display the screen shown in Figure 6-52 on page 149.

```

Mount a File System

Move cursor to desired item and press Enter.

List All Mounted File Systems
Mount a File System
Mount a Group of File Systems

F1=Help      F2=Refresh   F3=Cancel    F8=Image
F9=Shell     F10=Exit    Enter=Do

```

Figure 6-52 smitty mount command

- Use the arrow keys to move the cursor down and select Mount a File System by pressing the Enter key. A screen similar to Figure 6-53 is shown.

```

Mount a File System

Type or select values in entry fields.
Press Enter AFTER making all desired changes.

FILE SYSTEM name      [ ]      +
DIRECTORY over which to mount [ ]      +
TYPE of file system   [ ]      +
FORCE the mount?      no          +
REMOTE NODE containing the file system [ ]      +
to mount
Mount as a REMOVABLE file system?    no          +
Mount as a READ-ONLY system?         no          +
Disallow DEVICE access via this mount? no          +
Disallow execution of SUID and sgid programs no          +
in this file system?

F1=Help      F2=Refresh   F3=Cancel    F4=List
F5=Reset     F6=Command   F7=Edit      F8=Image
F9=Shell     F10=Exit    Enter=Do

```

Figure 6-53 Mount a File System screen

3. Use the arrow keys to move down to DIRECTORY over which to mount.
4. Press F4 to get a list of the mount points that you have defined for your file system. (Refer to Section 6.5.3, "Creating a file system" on page 143 to see how you created a file system, and notice that you created a mount point for your file system. You will use the same mount point to make your file system available to the users). Pressing F4 shows a screen similar to Figure 6-54.

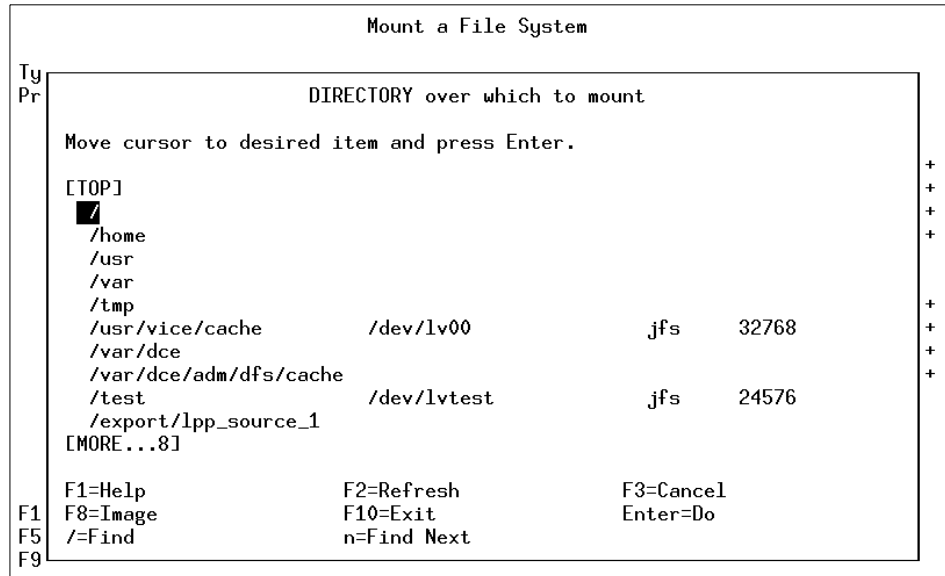

Figure 6-54 Selecting the mount point

5. Use the arrow keys to select the file system you want to mount. Press Enter to make the selection. This will display the mount point you just selected in the DIRECTORY over which to mount field.
6. Press Enter again and wait for the SMIT OK prompt, which indicates the successful completion of the process.

Automatic mounting

Mounts can be set to occur automatically during system initialization. There are two types of automatic mounts:

- ▶ Those mounts that are required to boot and run the system. These file systems are explicitly mounted by the boot process. The stanzas of such file systems in the `/etc/filesystems` file have `mount=automatic`. When the multi-user initialization starts, the `/etc/rc` script does not try to mount these file systems again when it executes the `mount all` command. Similarly, when the `umount all` command is executed, these file systems are not unmounted.

- ▶ The second type of automatic mount is user-controlled. These file systems are mounted during initialization by the `/etc/rc` script when it issues the `mount a11` command. The stanzas of user-controlled automatic mounts contain `mount = true` in `/etc/filesystems`.

You can specify that a file system is to be mounted automatically by either the `mount a11` command or by the `/etc/rc` script at the initialization time. You do this by setting the Mount AUTOMATICALLY at system restart field to TRUE when you are creating a file system. (See Figure 6-48 on page 145), or by using the `chfs -A yes filesystem` command. The following stanza from `/etc/filesystems` shows a file system which is mounted automatically:

```
/opt:
    dev           = /dev/hd10opt
    vfs           = jfs
    log           = /dev/hd8
    mount        = true
    check        = true
```

Displaying mounted file systems

The following example shows the use of `mount` command without a flag to display information about all the currently mounted file systems:

```
# mount
node      mounted      mounted over  vfs    date      options
-----
          /dev/hd4      /             jfs    Oct 25 18:20 rw,log=/dev/hd8
          /dev/hd2      /usr          jfs    Oct 25 18:20 rw,log=/dev/hd8
          /dev/hd9var   /var         jfs    Oct 25 18:20 rw,log=/dev/hd8
          /dev/hd3      /tmp         jfs    Oct 25 18:20 rw,log=/dev/hd8
          /dev/lv01     /var/dce     jfs    Oct 25 18:21 rw,log=/dev/hd8
          /dev/hd1      /home        jfs    Oct 27 15:14 rw,log=/dev/hd8
          /dev/lvtest   /test        jfs    Oct 27 15:17 rw,log=/dev/hd8
          /dev/lv07     /auto1       jfs    Oct 27 15:34 rw,log=/dev/hd8
```

6.5.5 Removing a file system

The following example shows the steps involved to remove a file system.

1. Using the `mount` command to check the file systems that are currently mounted will display the following screen:

```
# mount
node      mounted      mounted over  vfs    date      options
-----
          /dev/hd4      /             jfs    Oct 25 18:20 rw,log=/dev/hd8
          /dev/hd2      /usr          jfs    Oct 25 18:20 rw,log=/dev/hd8
          /dev/hd9var   /var         jfs    Oct 25 18:20 rw,log=/dev/hd8
          /dev/hd3      /tmp         jfs    Oct 25 18:20 rw,log=/dev/hd8
          /dev/lv01     /var/dce     jfs    Oct 25 18:21 rw,log=/dev/hd8
          /dev/hd1      /home        jfs    Oct 27 15:14 rw,log=/dev/hd8
```

```

/dev/lvtest    /test        jfs    Oct 27 15:17 rw,log=/dev/hd8
/dev/lv07     /auto1      jfs    Oct 27 15:34 rw,log=/dev/hd8

```

2. Identify if the file system you want to remove is shown in the list:
 - a. Yes: Continue with Step 3.
 - b. No: Go to Step 5.
3. Unmount the file system by using the **umount** command:

```
umount filesystem_name
```
4. Repeat Step 1 to check whether the file system has successfully been unmounted.
5. Using the SMIT fast path command **smitty rmjfs** to remove a journaled file system will display a screen similar to the one shown in Figure 6-55 on page 152.

Remove a Journaled File System

Type or select values in entry fields.
Press Enter AFTER making all desired changes.

<p>* FILE SYSTEM name</p> <p>Remove Mount Point</p>	<p style="text-align: right;">[Entry Fields]</p> <p style="text-align: center;">no</p>	<p>+</p> <p>+</p>
---	--	-------------------

F1=Help	F2=Refresh	F3=Cancel	F4=List
F5=Reset	F6=Command	F7=Edit	F8=Image
F9=Shell	F10=Exit	Enter=Do	

Figure 6-55 *smitty rmjfs* command

6. Press F4 to get a list of all the file systems that are defined on the system. You will obtain a screen similar to Figure 6-56 on page 153.

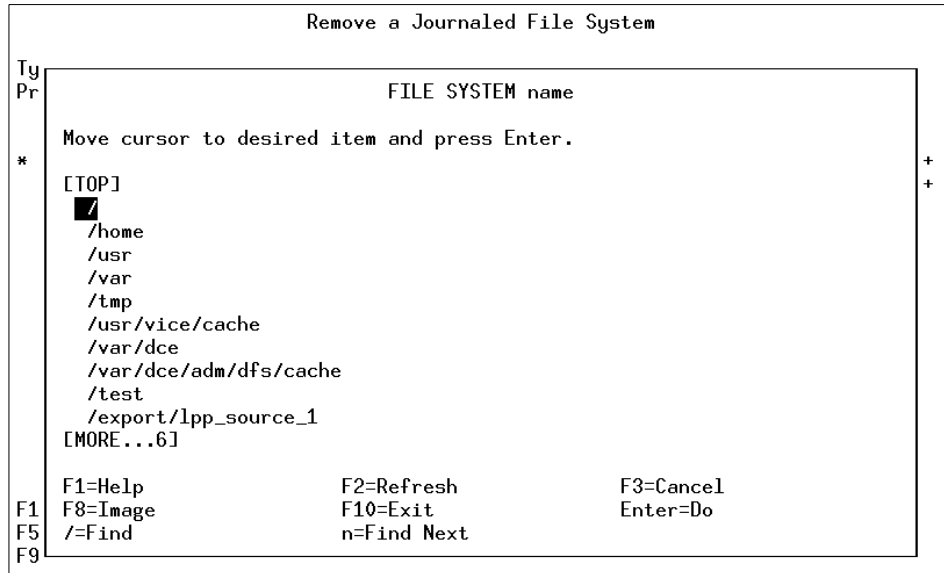

Figure 6-56 Selecting the file system to remove

7. Select the file system to be removed using the arrow keys and press Enter.
8. The name of the file system you just selected will be shown in the FILE SYSTEM name parameter.
9. If you want to keep the directory name that was used to mount this file system, press Enter to complete the command, otherwise change the Remove Mount Point field to YES and press Enter to complete the process.

Alternatively, you could replace steps 5 through 9 with the `rmfs` command:

```
#rmfs filesystem_name
```

To remove the mount point when the file system is removed, add the `-r` flag.

6.5.6 Increasing the size of a file system

AIX provides you the facility to increase the size of a file system dynamically, provided you have enough free space available on your disk. File systems that are low on space might create unanticipated problems.

Note: Whenever a file system is full, the system cannot write to it and returns you the following error:

```
There is not enough space in the file system
```

Increasing file system size using the command line

A file system can be increased by using the `chfs` command, as shown in the following steps:

1. Use the `df` command to find out the current size of the file system.
2. Calculate the number of blocks you need to add.
3. On the command line, enter the following command:

```
chfs -a size=new_size_in_512-byte_blocks file_system_name
Filesystem size changed to new_size_in_512-byte_blocks
```

Increasing the size of a file system using SMIT

To increase the file system size using SMIT, perform the following steps.

1. Run the `smitty chjfs` command to display a screen similar to Figure 6-57.

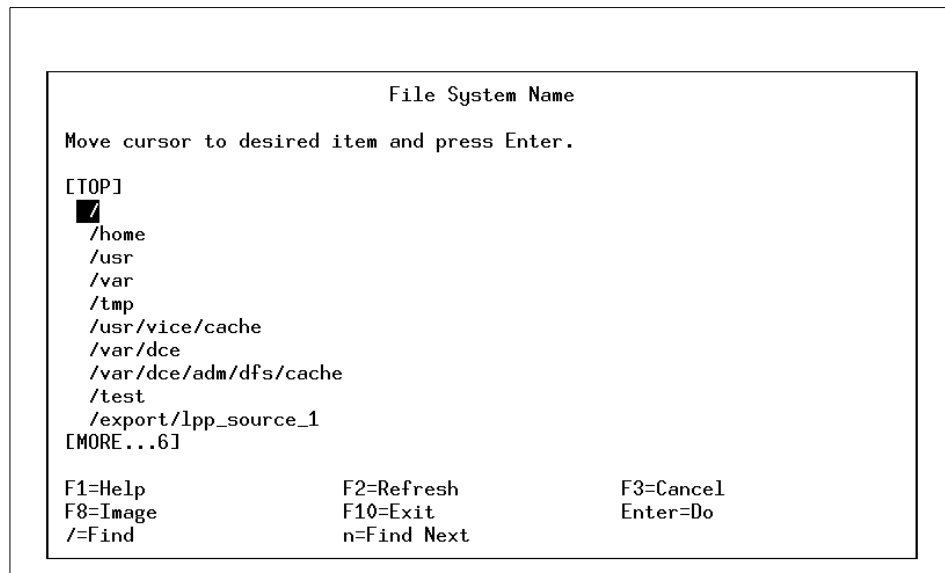

Figure 6-57 `smitty chjfs` command

2. Use the arrow keys to select the file system you want to change and press the Enter key. A screen similar to Figure 6-58 on page 155 will be shown, which will report the current file system attributes.

```

Change / Show Characteristics of a Journaled File System

Type or select values in entry fields.
Press Enter AFTER making all desired changes.

                                     [Entry Fields]
File system name                       /tmp
NEW mount point                         [tmp]
SIZE of file system (in 512-byte blocks) [32768]
Mount GROUP                             []
Mount AUTOMATICALLY at system restart?  yes                                     +
PERMISSIONS                             read/write                               +
Mount OPTIONS                           []                                       +
Start Disk Accounting?                   no                                       +
Fragment Size (bytes)                    4096
Number of bytes per inode                 4096
Compression algorithm                    no
Large File Enabled                        false
Allocation Group Size (MBytes)           8

F1=Help      F2=Refresh      F3=Cancel      F4=List
F5=Reset     F6=Command     F7=Edit       F8=Image
F9=Shell    F10=Exit      Enter=Do

```

Figure 6-58 Setting new characteristics of a file system

3. Enter the new file system size that you calculated in the SIZE of file system (in 512 byte block) field.
4. Press Enter. The SMIT OK prompt will indicate the successful completion of the process.

6.5.7 Checking file system consistency

The **fsck** command checks file system consistency and interactively repairs the file system. The general syntax of the **fsck** command is as follows:

```

fsck [ -n ] [ -p ] [ -y ] [ -dBlockNumber ] [ -f ] [ -ii-NodeNumber ]
[ -o Options ] [ -tFile ] [ -V VfsName ] [ FileSystem1 - FileSystem2 ... ]

```

The flags commonly used with the **fsck** command and their meanings are shown in Table 6-8.

Table 6-8 *fsck* command flags

Flag	Description
-f	<p>Performs a fast check. Under normal circumstances, the only file systems likely to be affected by halting the system without shutting down properly are those that are mounted when the system stops. The -f flag prompts the fsck command not to check file systems that were unmounted successfully. The fsck command determines this by inspecting the <code>s_fmod</code> flag in the file system superblock.</p> <p>This flag is set whenever a file system is mounted and cleared when it is unmounted successfully. If a file system is unmounted successfully, it is unlikely to have any problems. Because most file systems are unmounted successfully, not checking those file systems can reduce the checking time.</p>
-p	<p>Does not display messages about minor problems, but fixes them automatically. This flag does not grant the wholesale license that the -y flag does and is useful for performing automatic checks when the system is started normally. You should use this flag as part of the system startup procedures, whenever the system is being run automatically. Also allows parallel checks by group. If the primary superblock is corrupt, the secondary superblock is verified and copied to the primary superblock.</p>
-tFile	<p>Specifies a file parameter as a scratch file on a file system other than the one being checked, if the fsck command cannot obtain enough memory to keep its tables. If you do not specify the -t flag and the fsck command needs a scratch file, it prompts you for the name of the scratch file. However, if you have specified the -p flag, the fsck command is unsuccessful. If the scratch file is not a special file, it is removed when the fsck command ends.</p>
-y	<p>Assumes a yes response to all questions asked by the fsck command. This flag lets the fsck command take any action it considers necessary. Use this flag only on severely damaged file systems.</p>

The **fsck** command checks and interactively repairs inconsistent file systems. You should run this command before mounting any file system. You must be able to read the device file on which the file system resides (for example, the `/dev/hd0` device).

Normally, the file system is consistent and the **fsck** command merely reports on the number of files, used blocks, and free blocks in the file system. If the file system is inconsistent, the **fsck** command displays information about the inconsistencies found and prompts you for permission to repair them. If the file system cannot be repaired, restore it from backup.

Mounting an inconsistent file system may result in a system crash. If you do not specify a file system with the `FileSystem` parameter, the `fsck` command will check all the file systems with attribute `check=TRUE` in `/etc/filesystems`.

Note: By default, the `/`, `/usr`, `/var`, and `/tmp` file systems have the `check` attribute set to `False` (`check=false`) in their `/etc/filesystem` stanzas. The attribute is set to `False` for the following reasons:

1. The boot process explicitly runs the `fsck` command on the `/`, `/usr`, `/var`, and `/tmp` file systems.
2. The `/`, `/usr`, `/var`, and `/tmp` file systems are mounted when the `/etc/rc` file is executed. The `fsck` command will not modify a mounted file system and `fsck` results on mounted file systems are unpredictable.

6.5.8 Initializing the JFS log device

The `logform` command initializes a logical volume for use as a JFS log device, which stores transactional information about file system metadata changes and can be used to roll back incomplete operations if the machine crashes. The general syntax of the `logform` command is:

```
logform LogName
```

Note:

- ▶ The `logform` command is destructive; it wipes out all data in the logical volume.
- ▶ Accidentally running this on a logical volume containing a file system completely destroys the file system's data. The `logform` command should only be run on `CLOSED` logical volumes. If a log device is open due to its use by a mounted file system, the file system should be unmounted prior to running `logform` against the log device. The `logform` command destroys all log records on existing log devices, which may result in file system data loss. You can check to ensure that the log device is closed by running the following:

```
lsvg -l VGname
```

6.5.9 How to add additional JFS logs

A file system log is a formatted list of file system transaction records. The log for this system is called the journaled file system (JFS) log and is used when the system goes down before the transactions have been completed. The JFS log ensures file system integrity, but not necessarily data integrity. A dedicated JFS log is created on hd8 for rootvg when the system is installed. The JFS log size is 4 MB. You can also create a JFS log on a separate disk within a volume group, as shown in the following procedure.

In this example, we will be using uservg as the volume group and userlv as the logical volume. First, determine the mounted file systems:

```
# mount
node      mounted      mounted over  vfs    date      options
-----
/dev/hd4  /              /              jfs    Nov 16 18:45 rw,log=/dev/hd8
/dev/hd2  /usr           /usr           jfs    Nov 16 18:45 rw,log=/dev/hd8
/dev/hd9var /var          /var           jfs    Nov 16 18:45 rw,log=/dev/hd8
/dev/hd3  /tmp          /tmp           jfs    Nov 16 18:45 rw,log=/dev/hd8
/dev/hd1  /home         /home          jfs    Nov 16 18:46 rw,log=/dev/hd8
/dev/userlv /u            /u             jfs    Nov 18 11:25 rw,log=/dev/loglv00
```

Notice that the log for the /userlv logical volume is the logical volume loglv00.

To check the loglv00 LV, enter:

```
# lslv loglv00
LOGICAL VOLUME: loglv00          VOLUME GROUP: uservg
LV IDENTIFIER: 00091974342f2afa.2 PERMISSION: read/write
VG STATE:      active/complete  LV STATE:      opened/syncd
TYPE:         jfslog            WRITE VERIFY: off
MAX LPS:      512              PP SIZE:      8 megabyte(s)
COPIES:       1                SCHED POLICY: parallel
LPs:         1                 PPs:         1
STALE PPs:   0                 BB POLICY:    relocatable
INTER-POLICY: minimum          RELOCATABLE: yes
INTRA-POLICY: middle           UPPER BOUND:  32
MOUNT POINT: N/A              LABEL:       None
MIRROR WRITE CONSISTENCY: on
EACH LP COPY ON A SEPARATE PV ?: yes
```

Check the physical volumes (PVs) to look for a drive with no VG associated:

```
# lspv
hdisk0      000919746edab91f  rootvg
hdisk1      0009197459d92f2e  None
hdisk2      00091974d381d097  uservg
hdisk3      00091974d81ff431  uservg
hdisk4      00091974de731316  None
```

Notice that hdisk1 and hdisk4 have no VGs assigned to them. To extend the uservg volume group to incorporate hdisk4, type:

```
extendvg -f 'uservg' 'hdisk4'
```

To create the jfslog on hdisk4, enter:

```
smitty mklv
```

In Figure 6-59, select VOLUME GROUP name. In this example, it is uservg.

```

                                Add a Logical Volume

Type or select a value for the entry field.
Press Enter AFTER making all desired changes.

* VOLUME GROUP name                [Entry Fields]
                                     [uservg]
                                     +

F1=Help      F2=Refresh    F3=Cancel    F4=List
F5=Reset     F6=Command    F7=Edit     F8=Image
F9=Shell     F10=Exit     Enter=Do
```

Figure 6-59 Add a Logical Volume screen

From the Add a Logical Volume screen, select the following options:

Logical volume NAME to create	userlog
Number of LOGICAL PARTITIONS	1
PHYSICAL VOLUME names	hdisk4
Logical volume TYPE	jfslog
POSITION on physical volume	center

as displayed in Figure 6-60 on page 160.

```

                                Add a Logical Volume

Type or select values in entry fields.
Press Enter AFTER making all desired changes.

[TOP]                                [Entry Fields]
Logical volume NAME                    [userlog]
VOLUME GROUP name                       [uservg]
Number of LOGICAL PARTITIONS            [1] #
PHYSICAL VOLUME names                   [hdisk4] +
Logical volume TYPE                     [jfslog]
POSITION on physical volume              [center] +
RANGE of physical volumes                [minimum] +
MAXIMUM NUMBER of PHYSICAL VOLUMES     [ ] #
to use for allocation
Number of COPIES of each logical        1 +
partition
Mirror Write Consistency?                yes +
Allocate each logical partition copy    yes +
[MORE...11]

F1=Help      F2=Refresh      F3=Cancel      F4=List
F5=Reset     F6=Command     F7=Edit       F8=Image
F9=Shell     F10=Exit       Enter=Do

```

Figure 6-60 Add a Logical Volume characteristics screen

Once completed, the COMMAND STATUS screen will display confirmation, as displayed in Figure 6-61.

```

                                COMMAND STATUS

Command: OK          stdout: yes          stderr: no

Before command completion, additional instructions may appear below.

userlog

F1=Help      F2=Refresh      F3=Cancel      F6=Command
F8=Image     F9=Shell        F10=Exit       /=Find
n=Find Next

```

Figure 6-61 Add a Logical Volume - Command Status screen

Press F10 to exit SMIT to the command line and enter the following:

```
# /usr/sbin/logform /dev/userlog
logform: destroy /dev/userlog (y)?y
```

Note: The preceding command formats the JFS log logical volume so that it can record file system transactions. Nothing is destroyed, despite the wording in the prompt.

Modify `/etc/filesystems` and the logical volume control block (LVCB) as follows:

```
# chfs -a log=/dev/userlog /userlv
```

Unmount, then remount, the `/userlv` file system, and then verify that it been mounted by typing:

```
# mount
node          mounted      mounted over  vfs    date          options
-----
/dev/hd4      /              /              jfs    Nov 16 18:45  rw,log=/dev/hd8
/dev/hd2      /usr           /usr           jfs    Nov 16 18:45  rw,log=/dev/hd8
/dev/hd9var   /var           /var           jfs    Nov 16 18:45  rw,log=/dev/hd8
/dev/hd3      /tmp          /tmp           jfs    Nov 16 18:45  rw,log=/dev/hd8
/dev/hd1      /home         /home          jfs    Nov 16 18:46  rw,log=/dev/hd8
/dev/userlv   /u            /u             jfs    Nov 18 11:25  rw,log=/dev/userlog
```

Notice that the log is now `userlog` instead of `loglv00`.

To verify that you have set up the file system and log correctly, use the following command:

```
# lsvg -l uservg
uservg:
LV NAME      TYPE    LPs  PPp  PVs  LV STATE  MOUNT POINT
userlv       jfs     820  820  2    open/syncd /u
userlog      jfslog  1    1    1    open/syncd N/A
```

There should be two logical volumes listed, as shown in the preceding example.

6.6 Troubleshooting file system problems

This section will discuss some of the problems encountered while managing LVM and how to resolve them.

6.6.1 Recovering from super block errors

If you receive one of the following errors from the **fsck** or **mount** commands, the problem may be a corrupted (or *dirty*) superblock:

```
fsck: Not an AIX3 file system
fsck: Not an AIXV3 file system
fsck: Not an AIX4 file system
fsck: Not an AIXV4 file system
fsck: Not a recognized file system type
mount: invalid argument
```

The problem can be resolved by restoring the backup of superblock over the primary superblock using one of the following commands:

```
dd count=1 bs=4k skip=31 seek=1 if=/dev/1v00 of=/dev/1v00
```

The following command works only for AIX Version 4.x:

```
fsck -p /dev/1v00
```

Once the restoration process is completed, check the integrity of the file system by issuing the **fsck** command:

```
fsck /dev/1v00
```

In many cases, restoration of the backup of superblock to the primary superblock will recover the file system. If this does not resolve the problem, recreate the file system, and restore the data from a backup.

6.6.2 Cannot unmount file systems

A file system cannot be unmounted if any references are still active within that file system and the following error message will be displayed:

```
Device busy
```

or

```
A device is already mounted or cannot be unmounted
```

The following situations can leave an open references to a mounted file system.

- ▶ Files are open within a file system. Close these files before the file system can be unmounted. The **fuser** command is often the best way to determine what is still active in this file system. The **fuser** command will return the process IDs for all processes that have open references within a specified file system, as shown in the following example:

```
fuser -xc /tmp (or fuser /dev/hd3)
/tmp: 2910 3466 11654 26400
```

The process having an open reference can be killed by using the **kill** command and the unmount can be accomplished.

- ▶ If the file system is still busy and not getting unmounted, this could be due to a kernel extension that is loaded, but exists within the source file system. The **fuser** command will not show these kinds of references, because a user process is not involved. However, the **genkex** command will report on all loaded kernel extensions.
- ▶ File systems are still mounted within that file system. Unmount those file systems before this file system can be unmounted. If any file system is mounted within a file system, this leaves open references in the source file system at the mount point of the other file system. Use the **mount** command to get a list of mounted file systems. Unmount all the file systems that are mounted within the file system to be unmounted.
- ▶ A user is using a directory within the file system as their current working directory. The **fuser** command appends a **c** to the process IDs of all processes that are using a directory as their current working directory, and the **-u** flag identifies the owner of the process. It can be used with the **find** command, as shown in the following example:

```
# find /home -type d -exec fuser -u {} \;  
/home:  
/home/lost+found:  
/home/guest:  
/home/kenzie:    3548c(kenzie)
```

Have the identified user change their current working directory to a directory outside the file system, or kill the process, and the **umount** can be accomplished.

6.6.3 When the **df** command hangs

If the system hangs when you use the **df** command, the process described in this section may assist you.

Run the **df** command to check the file system. Note that the **raven:/u2** entry at the bottom is a remote file system that is locally mounted:

```
# df  
Filesystem    512-blocks    Free %Used    Iused %Iused Mounted on  
/dev/hd4      40960         19384  53%      1252   13% /  
/dev/hd2      663552        13288  98%      13170  16% /usr  
/dev/hd9var   401408        262528 35%      22288  45% /var  
/dev/hd3      65536         35336  47%        70    1% /tmp  
/dev/hd1      360448        19704  95%        98    1% /home  
raven:/u2     16384         0 100%        18    1% /u2
```

If the remote system raven is down and you enter the **df** command, the following will be your response:

```
# df
Filesystem      512-blocks      Free %Used    Iused %Iused Mounted on
/dev/hd4         40960          19384  53%      1252   13% /
/dev/hd2        663552         13288  98%     13170   16% /usr
/dev/hd9var     401408         262528  35%     22288   45% /var
/dev/hd3         65536          35336  47%         70    1% /tmp
/dev/hd1        360448         19704  95%         98    1% /home
NFS server raven not responding still trying
```

Break out of the error by pressing Ctrl-C.

Correct the problem with the remote system and once communication has been reestablished, you can run the **df** command to completion.

Some tips to check the remote system are:

- ▶ To check if the remote system is reachable through the network, enter:

```
# ping raven
PING raven: (9.3.1.215): 56 data bytes
64 bytes from 9.3.1.215: icmp_seq=0 ttl=255 time=9 ms
64 bytes from 9.3.1.215: icmp_seq=1 ttl=255 time=1 ms
^C
----raven PING Statistics----
2 packets transmitted, 2 packets received, 0% packet loss
round-trip min/avg/max = 1/5/9 ms
```

This shows that there is no problem with the network connection to the remote machine. If **ping** failed, it could be a break in the network or a problem with the network adapters in either machine. Choose another address on the same network segment to test.

- ▶ Stop and restart the NFS daemon on the remote system:

```
# stopsrc -s nfsd
0513-044 The stop of the nfsd Subsystem was completed successfully.
# startsrc -s nfsd
0513-059 The nfsd Subsystem has been started. Subsystem PID is 10178.
```

Also verify that NFS services are started in **/etc/inittab** after TCP/IP is started:

```
rctcpip:23456789:wait:/etc/rc.tcpip > /dev/console 2>&1 # Start TCP/IP
daemons
rcnfs:23456789:wait:/etc/rc.nfs > /dev/console 2>&1 # Start NFS Daemons
```

6.6.4 Deleting an application file that is locked

In this section, you are trying to delete an application file that is locked. When you try to delete the file, you receive an error message telling you that it cannot be deleted because the file is locked.

If you get an error trying to delete the file `/userdirectory/myfile`, enter:

```
# fuser /userdirectory/myfile
myfile: 104772
```

The number 104772 is the process ID (PID) of the file. To kill the process ID, enter:

```
kill -9 104772
```

Now, to delete the file and free the disk space for use by the file system, enter:

```
rm myfile
```

6.6.5 Full file systems

Full file systems can produce a wide variety of problems. While some of these problems are obvious, many others are not. For example, users will not be able to log in using the AIX Common Desktop Environment (CDE) when the `/home` file system is full. If `/home` is full, the AIX CDE welcome window will accept the user's name and password, the display will then go blank and appear to hang, then will return to the AIX CDE welcome window. In order to log in and investigate, press the Options button on the AIX CDE welcome window and select Command Line Login, or log in from a non-graphic display.

The amount of free space in file systems should always be checked when investigating problems.

6.7 Summary of LVM commands

This section summarizes the key commands that have been used in different sections of this chapter.

6.7.1 PV commands

The following commands are most commonly used with physical volume related tasks:

- lssdev** Lists devices in the ODM.
- chdev** Changes the characteristics of a device.

mkdev	Adds a device to the system.
chpv	Changes the state of the physical volume.
lspv	Displays information about a physical volume within a volume group.
migratepv	Moves allocated physical partitions from one physical volume to one or more other physical volumes.

6.7.2 VG commands

The following commands are most commonly used with volume group related tasks:

mkvg	Creates a new volume group.
extendvg	Adds a physical volume to a volume group.
reducevg	Removes a physical volume from a volume group.
chvg	Changes a volume group.
lsvg	Displays information about a volume group.
importvg	Installs a volume group.
exportvg	Removes a volume group.
reorgvg	Reorganizes a volume group.
syncvg	Synchronizes a volume group.
varyonvg	Makes a volume group available for use.
varyoffvg	Makes a volume group unavailable for use.

6.7.3 LV commands

The following commands are some of the most commonly used logical volume commands:

mklv	Creates a logical volume.
lslv	Lists the characteristics of a logical volume.
rm1v	Removes a logical volume.
extendlv	Increases the size of a logical volume.
chlv	Changes the characteristic of a logical volume.
mk1vcopy	Adds copies to a logical volume.
rm1vcopy	Removes copies from a logical volume.

6.7.4 File system commands

The following is the list of file systems commands that have been discussed in this chapter:

chfs	Changes the characteristics of a file system.
crfs	Adds a file system.
lsfs	Displays the characteristics of a file system.
rmfs	Removes a file system.
mount	Makes a file system available for use.
fsck	Checks file system consistency and interactively repairs the file system.
umount	Unmounts a previously mounted file system, directory, or file.
df	Reports information about space on file systems.
dd	Reads the <i>InFile</i> parameter or standard input, does the specified conversions, then copies the converted data to the <i>OutFile</i> parameter or standard output; the input and output block size can be specified to take advantage of raw physical I/O.

6.8 Quiz

The following certification assessment questions help verify your understanding of the topics discussed in this chapter.

1. A customer has purchased a new drive and has configured it on the system as `hdisk5`. What is the correct sequence of commands to make the new drive usable by the system for the enhanced JFS file system storage?
 - A. `mklv, mkvg, crfs`
 - B. `mkvg, mklv, crfs`
 - C. `crfs, mklv, mkvg`
 - D. `mkvg, crfs, mklv`

The following are additional questions created by the authors to further test your understanding of the topics.

1. Company XYZ has a stand-alone RS/6000 system they use to maintain an expanding customer database. The database is currently stored in the logical volume dblv in rootvg on hdisk4. Because of future growth, the customer decided to move the database to a new drive in a separate volume group. This new drive is hdisk5 in volume group datavg. Which of the following commands can be used to move the database logical volume, dblv, to the new volume group?
 - A. **mk1v -l dblv**
 - B. **cplv -v datavg dblv**
 - C. **migrate1v dblv hdisk5**
 - D. **migratepv -l dblv hdisk4 hdisk5**
2. While attempting to write a 200 MB file to the /user/data file system with 1 GB free space, the system responds with the message that it is out of space. Which of the following could be causing this?

df output

Filesystem	1024-blocks	Free	%Used	Iused	%Iused	Mounted on
/dev/hd4	40960	3744	91%	2416	12%	/
/dev/hd2	1003520	35280	97%	37596	13%	/usr
/dev/hd9var	36864	24540	34%	1236	14%	/var
/dev/hd3	167936	8108	96%	844	2%	/tmp
/dev/hd1	40960	20232	51%	1364	14%	/home
/dev/data1v	1224704	1023952	16%	6309	7%	/user/data
/dev/data1v2	16384	5884	65%	1018	25%	/data2
/dev/user1v2	12288	11608	6%	49	2%	/user2
/dev/user1v	12288	5002	59%	643	7%	/user
/dev/foolv	12288	121	99%	49	2%	/foo

- A. The /user/data file system is mounted read only.
- B. The permissions on the /user file system is wrong.
- C. The permissions on the /user/data file system is wrong.
- D. /user is preventing you from reaching the /user/data file system.

3. The order-processing department of a company has complained of slow response times from their application. The system administrator has determined this is due to a disk I/O bottleneck on the physical volume where the application data file system is located. Which of the following could be used to help improve the application response times?
 - A. Stripe the file system logical volume across multiple disks.
 - B. Move the jfslog to the same physical volume as the file system.
 - C. Increase the size of the application data file system.
 - D. Move the physical volume into a separate volume group.
4. Customer XYZ discovered that one of their hard drives, hdisk3, was bad. The drive contains volume group data3vg, which was used by an application many years ago. Since they do not need to keep this information, they decided to simply remove the drive. After rebooting, the physical volume for hdisk3 is still listed in the volume group descriptor area (VGDA). Which of the following commands can be used to delete the physical volume from data3vg?
 - A. `reducevg`
 - B. `sync1voldm`
 - C. `reduce1voldm`
 - D. `syncvg`

6.8.1 Answers

The following answers are for the assessment quiz questions.

1. B

The following answers are for the additional quiz questions.

1. B
2. D
3. A
4. A

6.9 Exercises

The following exercises provide sample topics for self study. They will help ensure comprehension of this chapter.

1. List all the physical volumes, volume groups, logical volumes, physical partitions, and file systems on your system.
2. Determine which disks the rootvg volume group resides on.
3. Add a new physical volume to your system and check to make sure the drive is available.
4. Create a volume group named datavg on this new physical volume.
5. Create a file system named data files.
6. Unmount the data files file system.
7. Create a mirror of datavg.
8. Determine whether you have a disk quorum.
9. Increase the size of the file system data files.
10. Reduce the file system data files.
11. List the disks that a file system, data files, and a volume group, datavg, reside on.
12. Remove the mirror of datavg and check to make sure the device is not mirrored.
13. Remove the datavg volume group.
14. Create multiple jfslogs on several PVs.
15. How do you erase a file that is being locked by an application?
16. Run **extendvg** to extend a volume group. What needs to be run first?
17. Stripe data to spread I/O.



SMIT fast path commands

The System Management Interface Tool (SMIT) provides an alternative, natural-language, task-oriented interface for AIX system management. The SMIT facility runs in two interfaces, ASCII (nongraphical) or AIXwindows (graphical). After you enter SMIT using the `smit` command, the first screen displayed is the main menu, which is shown in Figure 7-1 on page 172. The main menu selections lead to submenus, helping to narrow the scope of choice to a particular task. Alternatively, you can use the `smit` command with a *fast path* parameter, which can save you time by allowing you to go directly to the menu or dialog for your task, bypassing the upper-level menus. For example, to change the characteristics of a user, enter the following command:

```
smit chuser
```

The `chuser` command is an example of a fast path parameter. The `smit` command plus the fast path parameter, `chuser`, takes you directly to the menu, Change User Attributes, which guides you through the steps to change a user's characteristics.

```
System Management
Move cursor to desired item and press Enter.
Software Installation and Maintenance
Software License Management
Devices
System Storage Management (Physical & Logical Storage)
Security & Users
Communications Applications and Services
Print Spooling
Problem Determination
Performance & Resource Scheduling
System Environments
Processes & Subsystems
Applications
Using SMIT (information only)

F1=Help      F2=Refresh   F3=Cancel    F8=Image
F9=Shell     F10=Exit    Enter=Do
```

Figure 7-1 System Management menu

At any menu in SMIT (as shown in Figure 7-1), you can show the fast path to that menu by pressing F8 or by choosing Fast Path from the Show menu.

7.1 Summary of SMIT fast path commands

The following list provides a quick reference to many SMIT fast paths. In this list, a SMIT menu name is followed by its associated fast path in parentheses. Enter the command `smit` and the fast path shown to go directly to its associated menu.

- ▶ Software Installation and Maintenance (install)
 - Install and Update Software (install_update)
 - Install and Update from LATEST Available Software (install_latest)
 - Update Installed Software to Latest Level (Update All) (install_all)
 - Install and Update Software by Package Name (includes devices and printers) (install_package)
 - Install Software Bundle (Easy Install) (install_bundle)
 - Update Software by Fix (APAR) (update_by_fix)
 - Install and Update from ALL Available Software (install_all)
 - List Software and Related Information (list_software)
 - Software Maintenance and Utilities (maintain_software)
 - Commit Applied Software Updates (Remove Saved Files) (commit)
 - Reject Applied Software Updates (Use Previous Version) (reject)
 - Remove Installed Software (remove)
 - Copy Software to Hard Disk for Future Installation (bffcreate)
 - Check Software File Sizes After Installation (check_files)
 - Verify Software Installation and Requisites (verify_install)
 - Network Installation Management (nim_client)
 - System Backup Manager (backsys)
 - Back Up the System (mksysb)
 - List Files in a System Image (lsmksysb)
 - Restore Files in a System Image (restmksysb)
- ▶ Software License Management (licences)
 - Manage Nodelocked Licenses (manage_nodelocked)
 - Manage License Servers and License Databases (manage_servers)
 - Show License Usage on Servers (show_server_status)
- ▶ Devices (dev)
 - Install/Configure Devices Added After IPL (cfgmgr)

- Printer/Plotter (printer)
 - Printer/Plotter Devices (pdp)
 - Add a Printer/Plotter (makprt)
 - Move a Printer/Plotter to Another Port (movprt)
 - Change / Show Characteristics of a Printer/Plotter (chgprt)
 - Remove a Printer/Plotter (rmvprt)
 - Install Additional Printer/Plotter Software (printerinst)
 - Print Spooling (spooler)
- TTY (tty)
- PTY (pty)
- Console (console)
- Fixed Disk (disk)
- CD ROM Drive (cdrom)
- Read/Write Optical Drive (rwopt)
- Diskette Drive (diskette)
- Tape Drive (tape)
- Communication (commoddev)
- Graphic Displays (g_display)
- Graphic Input Devices (input)
- Low Function Terminal (LFT) (lft)
- SCSI Initiator Device (scsiid)
- SCSI Adapter (scsia)
- Asynchronous I/O (aio)
- Multimedia (mm)
- List Devices (lsattr)
- Install Additional Device Software (devinst)
- ▶ System Storage Management (Physical & Logical Storage) (storage)
 - Logical Volume Manager (lvm)
 - Volume Groups (vg)
 - Logical Volumes (lv)
 - Physical Volumes (pv)
 - Paging Space (pgsp)

- Add Another Paging Space (mkps)
- Change / Show Characteristics of a Paging Space (chps)
- Remove a Paging Space (rmps)
- Activate a Paging Space (swapon)
- Deactivate a Paging Space (swapoff)
- File Systems (fs)
 - Add / Change / Show / Delete File Systems (manfs)
 - Mount a File System (mountfs)
 - Mount a Group of File Systems (mountg)
 - Unmount a File System (umountfs)
 - Unmount a Group of File Systems (umountg)
 - Verify a File System (fsck)
 - Backup a File System (backfilesys)
 - Restore a File System (restfilesys)
 - List Contents of a Backup (listtoc)
- Files & Directories (filemgr)
 - Backup a File or Directory (backfile)
 - Restore a File or Directory (restfile)
- System Backup Manager (backsys)
- ▶ Security & Users (security)
 - Users (users)
 - Add a User (mkuser)
 - Change a User's Password (passwd)
 - Change / Show Characteristics of a User (chuser)
 - Lock / Unlock a User's Account (lockuser)
 - Reset User's Failed Login Count (failed_login)
 - Remove a User (rmuser)
 - Groups (groups)
 - Passwords (passwords)
 - Login Controls (login)
 - Roles (roles)
- ▶ Communications Applications and Services (commo)

- TCP/IP (tcpip)
 - Minimum Configuration & Startup (mktcpip)
 - Further Configuration (configtcp)
 - Use DHCP for TCPIP Configuration & Startup (usedhcp)
 - IPV6 Configuration (configtcp6)
- NFS (nfs_menu) (nfs)
- CIFS/SMB (smb)
- ▶ Print Spooling (spooler)
 - Start a Print Job (qprt)
 - Manage Print Jobs (jobs)
 - Manage Print Queues (pqmanage)
 - Add a Print Queue (mkpq)
 - Add an Additional Printer to an Existing Print Queue (mkpqprt)
 - Change / Show Print Queue Characteristics (chpq)
 - Change / Show Printer Connection Characteristics (chprtcom)
 - Remove a Print Queue (rmpq)
 - Manage Print Server (server)
 - Programming Tools (pqtools)
- ▶ Problem Determination (problem)
 - Error Log (error)
 - Generate Error Report (errprt)
 - Change / Show Characteristics of the Error Log (errdemon)
 - Clean the Error Log (errclear)
 - Trace (trace)
 - System Dump (dump)
 - Change the Primary Dump Device (dumpchgp)
 - Change the Secondary Dump Device (dumpchgs)
 - Alog (alog)
 - Hardware Diagnostics (diag)
 - Verify Software Installation and Requisites (verify_install)
- ▶ Performance & Resource Scheduling (performance)
 - Resource Status & Monitors (monitors)

- Analysis Tools (analysis)
- Resource Controls (controls)
- Schedule Jobs (at)
- Power Management (pm)
- Workload Management (wlm)
 - Work on alternate configurations (wlmconfig)
 - Work on a set of Subclasses (wlmsubclass)
 - Change / Show Characteristics of a class (wlmchclass)
 - Remove a class (wlrmrclass)
 - Class assignment rules (wlmrms)
 - Start/Stop/Update WLM (wlmmmanage)
 - Assign/Unassign processes to a class/subclass (wlmassign)
- Resource Set Management (rset)
- ▶ System Environments (system)
 - Stop the System (shutdown)
 - Assign the Console (chcons)
 - Change / Show Date and Time (chtz_date)
 - Manage Language Environment (mlang)
 - Change / Show Characteristics of Operating System (chgsys)
 - Change / Show Number of Licensed Users (chlicense)
 - Broadcast Message to all Users (wall)
 - Manage System Logs (logs)
 - Change / Show Characteristics of System Dump (dump)
 - Change System User Interface (dtconfig)
 - Internet and Documentation Services (web_configure)
 - Change/Show Default Documentation Language (chdoclang)
 - Manage Remote Reboot Facility (rrbtty)
 - Manage System Hang Detection (shd)
- ▶ Processes & Subsystems (src)
 - Processes (process)
 - Subsystems (subsys)
 - Subservers (subserver)

7.2 Quiz

The following are additional questions created by the authors to further test your understanding of the topics.

1. Company ABC recently ordered an HP Laserjet 5 printer. The system administrator needs to install the printer drivers for the printer. What SMIT installation screen fastpath can be used to perform the installation?
 - A. `smit makprt`
 - B. `smit printerinst`
 - C. `smit install_commit`
 - D. `smit maintain_software`
2. The system administrator wants to add a new printer queue for an EPSON dot matrix printer. What SMIT fast path command shall he use to perform the function?
 - A. `smit qprt`
 - B. `smit mkpq`
 - C. `smit chpq`
 - D. `smit mkpqrt`

7.2.1 Answers

The following answers are for the additional quiz questions.

1. B
2. B

7.3 Exercises

The following exercises provide sample topics for self study. They will help ensure comprehension of this chapter.

1. Perform the following functions using the SMIT fast path commands.
 - Update software by fix (APAR).
 - Verify the software installation and requisites.
 - Add a plotter.
 - Activate a paging space.
 - Add a paging space.

- Change a user's password.
- Add a print queue.
- Show characteristics of error log.



Problem determination

This chapter provides information to assist you in solving problems with the operating system, hardware, or other programs installed on the system by using the following tools:

- ▶ Boot logging facility
- ▶ Error logging facility
- ▶ System dump facility

8.1 Boot logging facility

There may be instances when you must trace the boot process and find out if something went wrong with the system during the boot process. AIX provides you with an excellent tool to monitor these problems through the help of the **alog** command.

The rc.boot script explicitly redirects boot information through the **alog** command to the file /var/adm/ras/bootlog. If something goes wrong with the system, you can boot the system in single-user mode (maintenance mode) and access these logs through the **alog** command to see at what stage the system is failing. A part of the rc.boot script is shown below to illustrate how the logging mechanism has been incorporated.

```
# Error Recovery if customized data is zero

[ -f /no_sbase ] && {
    echo "rc.boot: executing savebase recovery procedures" \
    >>/tmp/boot_log
    X=`ODMDIR=/mnt/etc/objrepos odmshow CuDv |\
    fgrep population`
    count=`echo $X | cut -f2 -d' '`
    [ $count -ne 0 ] && {
        /usr/sbin/savebase -o /mnt/etc/objrepos
        [ $? -ne 0 ] && loopled 0x546
        mount /var# so that reboot can log
        echo "savebase recovery reboot" \
        >>/tmp/boot_log
        cat /tmp/boot_log | alog -q -t boot
        reboot
    }
}
```

The **alog** command works with log files that are specified on the command line or with logs that are defined in the **alog** configuration database.

The most common flags used with the **alog** command and their description are given in Table 8-1.

Table 8-1 Command flags for alog

Flag	Description
-f <i>LogFile</i>	Specifies the name of a log file. If the specified <i>LogFile</i> does not exist, one is created. If the alog command is unable to write to <i>LogFile</i> , it writes to /dev/null.

Flag	Description
-L	Lists the log types currently defined in the a1og configuration database. If you use the -L flag with the -t LogType flag, the attributes for a specified LogType are listed.
-o	Lists the contents of LogFile. Writes the contents of LogFile to standard output in sequential order.
-q	Copies standard input to LogFile but does not write to standard output.
-t <i>LogType</i>	Identifies a log defined in the a1og configuration database. The a1og command gets the log's file name and size from the a1og configuration database.

These logs can be maintained by using either SMIT or by using the **a1og** command directly. The general use of the **a1og** command is as follows:

- ▶ To show the contents of a log file

In order to list the contents of a log file, use the command:

```
a1og -f LogFile [ -o ]
```

- ▶ To log data to a specified log file

You can change the default file that is used to log the activities by using the following command:

```
a1og -f LogFile | [ [ -q ] [ -s Size ] ]
```

- ▶ To display the verbosity value of a specified log type

The verbosity value specifies the depth of information that is written to a log. In order to display the verbosity value of a log, use the following command:

```
a1og -t LogType -V
```

- ▶ To change the attributes of a specified log type

You can use the different attributes of a log type by using the following command:

```
a1og -C -t LogType [ -f LogFile ] [ -s Size ] [ -w Verbosity ]
```

- ▶ To display the current attributes of a specified log type

Before you can change the attributes of a log, it is recommended that you view what the current attributes are. Use the following command to display the current attributes of a log type:

```
a1og -L [ -t LogType ]
```

In order to view the boot log, you can either use SMIT or use the **a log** command directly. Follow the sequence in “Viewing the boot log” on page 184 to view the contents of the boot log.

► Viewing the boot log

You can view the boot log by either using the SMIT fastpath **smitty a log_show** and giving the name of the log you want to view, or you can use the **a log** command. In order to view a log using the **a log** command, determine what predefined logs are available to you.

Use the **a log -L** command to view the logs defined in the **a log** database. On the command line, enter:

```
# a log -L
boot
bosinst
nim
dumpsymp
```

In order to view the boot log (the log that holds boot information), enter:

```
# a log -o -t boot
-----
attempting to configure device 'fda0'
invoking /usr/lib/methods/cfgfda_isa -2 -l fda0
return code = 0
***** stdout *****
fd0

***** no stderr *****
-----
invoking top level program -- "/etc/methods/starttty"
return code = 0
***** no stdout *****
***** no stderr *****
-----
invoking top level program -- "/etc/methods/startsmt"
return code = 0
***** no stdout *****
***** no stderr *****
-----
invoking top level program -- "/etc/methods/load_blockset_ext"
return code = 0
***** no stdout *****
***** no stderr *****
-----
invoking top level program -- "/usr/lib/methods/defaio"
return code = 0
***** no stdout *****
***** no stderr *****
```

```
-----  
calling savebase  
return code = 0  
***** no stdout *****  
***** no stderr *****  
Starting AIX Windows Desktop....  
Saving Base Customize Data to boot disk  
Starting the sync daemon  
Starting the error daemon  
System initialization completed.  
Starting Multi-user Initialization  
  Performing auto-varyon of Volume Groups  
  Activating all paging spaces  
swapon: Paging device /dev/hd6 activated.  
/dev/rhd1 (/home): ** Unmounted cleanly - Check suppressed  
  Performing all automatic mounts  
Multi-user initialization completed
```

Any errors that are encountered will be logged into this file. However, the **a log** file has no concurrency control; therefore, if multiple processes try to write to the same file at the same time, the contents of the log file might not be as anticipated. Additionally, it is a cyclic file, so when its size gets to the maximum, it is overwritten.

8.2 Error logging facility

The error logging facility records hardware and software failures in the error log for informational purposes or for fault detection and corrective action. The error logging subsystem is composed of three components, whose processing flow is shown in Figure 8-1 on page 186. The type of tasks are defined as follows:

- ▶ Error log programming
Used by developers to create error templates and create messages.
- ▶ Error processing
Invoked when an error occurs.
- ▶ Error log file processing
Used by administrators to diagnose a problem.

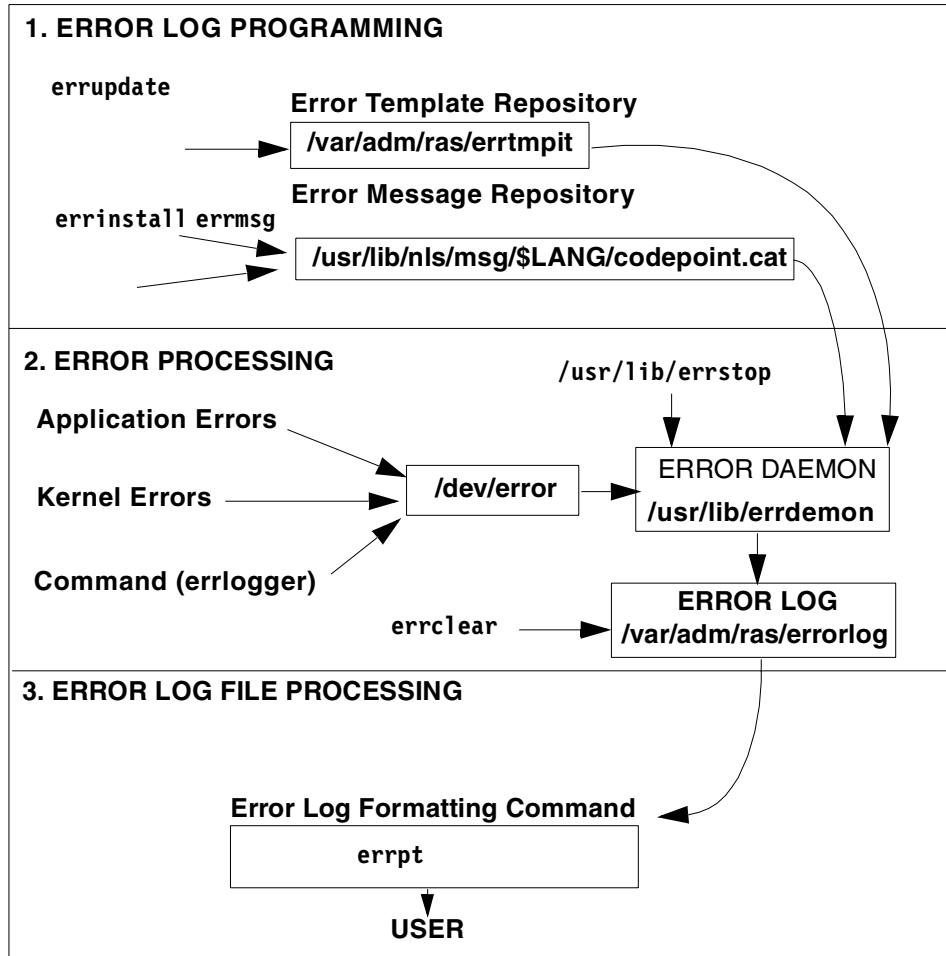

Figure 8-1 Error logging subsystem overview

8.2.1 Software service aids package

AIX 5L Version 5.1 base system (`bos.rte.serv_aid`) consists of `errlog` subroutines, `errsave`, and `errlast` kernel service, error device driver (`/dev/error`), error daemon, and the `errinstall`, `errupdate`, and `errstop` commands.

An optionally installable software service aids package (`bos.sysmgt.serv_aid`), which consists of the `errclear`, `errdead`, `errlogger`, `errmsg`, `errpt`, and `sysdumpstart` commands, is required to generate reports from an error log using the `errpt` command and to delete entries from the error log using the `errclear` command.

8.2.2 Managing the error log

The following sections discuss various error log management related functions.

Configuring an error log file (/var/adm/ras/errlog)

This section discusses the use of **errdemon** command to customize the error log file.

- ▶ To list the current values for the error log file name, error log file size, and buffer size that are currently stored in the error log configuration database settings, use the following command.:

```
# /usr/lib/errdemon -l
Error Log Attributes
-----
Log File           /var/adm/ras/errlog
Log Size           4096 bytes
Memory Buffer Size 8192 bytes
```

The preceding example shows the default error log file attributes. The log file size cannot be made smaller than the hard-coded default of 4 KB and the buffer cannot be made smaller than the hard-coded default of 8 KB.

- ▶ To change the log file name to /var/adm/ras/errlog.test, use the following command:

```
/usr/lib/errdemon -i /var/adm/ras/errlog.test
```

- ▶ To change the log file size to 8 KB, use the following command:

```
/usr/lib/errdemon -s 8192
```

If the log file size specified is smaller than the size of the log file currently in use, the current log file is renamed by appending .old to the file name and a new log file is created with the specified size limit. The amount of space specified is reserved for the error log file and is not available for use by other files. Therefore, you should be careful not to make the log excessively large. But, if you make the log too small, important information may be overwritten prematurely. When the log file size limit is reached, the file wraps. That is, the oldest entries are overwritten by new entries.

- ▶ To change the size of the error log device driver's internal buffer to 16 KB, use the following command:

```
# /usr/lib/errdemon -B 16384
0315-175 The error log memory buffer size you supplied will be rounded up
to a multiple of 4096 bytes.
```

If the specified buffer size is larger than the buffer size currently in use, the in-memory buffer is immediately increased and if the specified buffer size is smaller than the buffer size currently in use, the new size is put into effect the next time the error daemon is started after the system is rebooted. The size you specify is rounded up to the next integral multiple of the memory page size (4 KB).

You should be careful not to impact your system's performance by making the buffer excessively large. But, if you make the buffer too small, the buffer may become full if error entries are arriving faster than they are being read from the buffer and put into the log file. When the buffer is full, new entries are discarded until space becomes available in the buffer. When this situation occurs, an error log entry is created to inform you of the problem.

The following command shows the new attributes of error log file:

```
# /usr/lib/errdemon -l
Error Log Attributes
-----
Log File           /var/adm/ras/errlog.test
Log Size           8192 bytes
Memory Buffer Size 16384 bytes
```

Starting the error logging daemon

To determine if error logging daemon is on or off, issue the **errpt** command. The **errpt** command output may contain entries, as shown in Figure 8-2.

```
# errpt
IDENTIFIER  TIMESTAMP  T  C  RESOURCE_NAME  DESCRIPTION
9DBCfDEE   1108182898 T  0  errdemon       ERROR LOGGING TURNED ON
192AC071   1108182898 T  0  errdemon       ERROR LOGGING TURNED OFF
AA8AB241   1108182798 T  0  OPERATOR       OPERATOR NOTIFICATION
# █
```

Figure 8-2 Sample **errpt** command output

If the **errpt** command does not generate entries, error logging has been turned off. To activate the daemon, use the following command:

```
/usr/lib/errdemon
```

The **errdemon** daemon starts error logging and writes error log entries in the system error log.

Stopping the error logging daemon

To stop the error logging daemon from logging entries, use the following command:

```
/usr/lib/errstop
```

Cleaning an error log

Cleaning of the error log implies deleting old or unnecessary entries from the error log. Cleaning is normally done as part of the daily **cron** command execution (see Chapter 14, “The cron daemon and crontab” on page 357 for more information on cron). If it is not done automatically, you should probably clean the error log regularly.

To delete all the entries from the error log, use the following command:

```
errclear 0
```

To selectively remove entries from the error log, for example, to delete all software errors entries, use the following command:

```
errclear -d S 0
```

Alternatively, use the SMIT fast path command (**smit errclear**), which will display the screen shown in Figure 8-3. Fill in the appropriate fields, as per your requirements, to clean the error log.

Clean the error log

Type or select values in entry fields.
Press Enter AFTER making all desired changes.

	[Entry Fields]	
Remove entries older than this NUMBER OF DAYS	[30]	#
Error CLASSES (default is all)	[]	+
Error TYPES (default is all)	[]	+
Error LABELS (default is all)	[]	+
Error ID's (default is all)	[]	+X
Resource CLASSES (default is all)	[]	
Resource TYPES (default is all)	[]	
Resource NAMES (default is all)	[]	
SEQUENCE numbers (default is all)	[]	
LOGFILE	[/var/adm/ras/errlog]	
TEMPLATE file	[/var/adm/ras/errtmpl]	

F1=Help	F2=Refresh	F3=Cancel	F4=List
F5=Reset	F6=Command	F7=Edit	F8=Image
F9=Shell	F10=Exit	Enter=Do	

Figure 8-3 Clean the error log menu

Generating an error report

The **errpt** command generates the default summary error report that contains one line of data for each error. It includes flags for selecting errors that match specific criteria. By using the default condition, you can display error log entries in the reverse order they occurred and were recorded. By using the -c (concurrent) flag, you can display errors as they occur. You can use flags to generate reports with different formats. The following is the syntax of the **errpt** command.

```
errpt [ -a ] [ -c ] [ -d ErrorClassList ] [ -e EndDate ] [ -g ] [ -i File ]
[ -j ErrorID [ ,ErrorID ] ] | [ -k ErrorID [ ,ErrorID ] ] [ -J ErrorLabel
[ ,ErrorLabel ] ] | [ -K ErrorLabel [ ,ErrorLabel ] ] [ -l SequenceNumber ]
[ -m Machine ] [ -n Node ] [ -s StartDate ] [ -F FlagList ]
[ -N ResourceNameList ] [ -R ResourceTypeList ] [ -S ResourceClassList ]
[ -T ErrorTypeList ] [ -y File ] [ -z File ]
```

The flags commonly used with the **errpt** command are found in Table 8-2.

Table 8-2 Common flags for *errpt*

Flag	Description
-a	Displays information about errors in the error log file in detailed format.
-e <i>EndDate</i>	Specifies all records posted prior to and including the <i>EndDate</i> variable, where the <i>EndDate</i> variable has the form <i>mmdhmmyy</i> (month, day, hour, minute, and year).
-J <i>ErrorLabel</i>	Includes the error log entries specified by the <i>ErrorLabel</i> variable. The <i>ErrorLabel</i> variable values can be separated by commas or enclosed in double-quotation marks and separated by commas or space characters.
-j <i>ErrorID</i> [, <i>ErrorID</i>]	Includes only the error-log entries specified by the <i>ErrorID</i> (error identifier) variable. The <i>ErrorID</i> variables can be separated by commas or enclosed in double-quotation marks and separated by commas or space characters.
-K <i>ErrorLabel</i>	Excludes the error log entries specified by the <i>ErrorLabel</i> variable.
-k <i>ErrorID</i>	Excludes the error log entries specified by the <i>ErrorID</i> variable.
-N <i>ResourceNameList</i>	Generates a report of resource names specified by the <i>ResourceNameList</i> variable, where <i>ResourceNameList</i> is a list of names of resources that have detected errors.

Flag	Description
-s <i>StartDate</i>	Specifies all records posted on and after the StartDate variable, where the StartDate variable has the form <i>mmddhhmmyy</i> (month, day, hour, minute, and year).

The output of **errpt** command without any flag will display the error log entries with the following fields:

IDENTIFIER	Numerical identifier for the event.
TIMESTAMP	Date and time of the event occurrence.
T	Type of error. Depending upon the severity of the error, the following are the possible error types: <ul style="list-style-type: none"> PEND The loss of availability of device or component is imminent. PERF The performance of the device or component has degraded to below an acceptable level. PERM Most severe errors, due to a condition that could not be recovered. TEMP Condition that was recovered after a number of unsuccessful attempts. UNKN Not possible to determine the severity of an error. INFO This is an informational entry.
C	Class of error. The following are the possible error classes: <ul style="list-style-type: none"> H Hardware. S Software. O Informational message. U Undetermined.
RESOURCE_NAME	Name of the failing resource.
DESCRIPTION	Summary of the error.

Using the **errpt** command without a flag will output all the entries in the log, as shown in the following example. Since the number of error log entries may exceed a single page, you can use **errpt | pg** to have a page-wise view.

```
# errpt
IDENTIFIER  TIMESTAMP  T C RESOURCE_NAME  DESCRIPTION
OBA49C99   1106154298 T H scsi0         SCSI BUS ERROR
E18E984F   1106110298 P S SRC           SOFTWARE PROGRAM ERROR
```

```

2A9F5252 1106094298 P H tok0 WIRE FAULT
E18E984F 1102120498 P S SRC SOFTWARE PROGRAM ERROR
E18E984F 1101105898 P S SRC SOFTWARE PROGRAM ERROR
AD331440 1101104498 U S SYS_DUMP SYSTEM DUMP
E18E984F 1030182798 P S SRC SOFTWARE PROGRAM ERROR
E18E984F 1030182698 P S SRC SOFTWARE PROGRAM ERROR
E18E984F 1030182598 P S SRC SOFTWARE PROGRAM ERROR
E18E984F 1023175198 P S SRC SOFTWARE PROGRAM ERROR
E18E984F 1023175098 P S SRC SOFTWARE PROGRAM ERROR
E18E984F 1023174898 P S SRC SOFTWARE PROGRAM ERROR
2A9F5252 1022143498 P H tok0 WIRE FAULT
35BFC499 1022081198 P H hdisk0 DISK OPERATION ERROR
AD331440 1021185998 U S SYS_DUMP SYSTEM DUMP
0BA49C99 1021185798 T H scsi0 SCSI BUS ERROR
35BFC499 1021180298 P H hdisk0 DISK OPERATION ERROR

```

The preceding example shows that the resource name for a disk operation error is `hdisk0`. To obtain all the errors with resource name `hdisk0` from the error log, use the `errpt` command with `-N` flag, as shown in the following example:

```

# errpt -N hdisk0
IDENTIFIER  TIMESTAMP  T C RESOURCE_NAME  DESCRIPTION
35BFC499    1022081198 P H hdisk0         DISK OPERATION ERROR
35BFC499    1021180298 P H hdisk0         DISK OPERATION ERROR

```

Reading an error log report

To read the contents of an error log report, use the `errpt` command with the `-a` flag. For example, to read an error log report with resource name `hdisk0`, use the `errpt` command with the `-a` and `-j` flags with an error identifier, as shown in the following sample error report:

```

# errpt -a -j 35BFC499
-----
LABEL:          DISK_ERR3
IDENTIFIER:     35BFC499

Date/Time:      Thu Oct 22 08:11:12
Sequence Number: 36
Machine Id:     006151474C00
Node Id:        sv1051c
Class:          H
Type:           PERM
Resource Name:  hdisk0
Resource Class: disk
Resource Type:  scsd
Location:       04-B0-00-6,0
VPD:

Manufacturer.....IBM
Machine Type and Model.....DORS-32160  !#

```

```
FRU Number.....
ROS Level and ID.....57413345
Serial Number.....5U5W6388
EC Level.....85G3685
Part Number.....07H1132
Device Specific.(Z0).....000002028F00001A
Device Specific.(Z1).....39H2916
Device Specific.(Z2).....0933
Device Specific.(Z3).....1296
Device Specific.(Z4).....0001
Device Specific.(Z5).....16
```

Description
DISK OPERATION ERROR

Probable Causes
DASD DEVICE
STORAGE DEVICE CABLE

Failure Causes
DISK DRIVE
DISK DRIVE ELECTRONICS
STORAGE DEVICE CABLE

Recommended Actions
PERFORM PROBLEM DETERMINATION PROCEDURES

Detail Data
SENSE DATA
0A06 0000 2800 0000 0088 0002 0000 0000 0200 0200 0000 0000 0000 0000 0000 0000
0000 0000 0000 0000 0000 0000 0000 0000 0000 0000 0000 0000 0000 0000 0000 0000
0000 0000 0000 0000 0000 0000 0000 0000 0000 0000 0000 0000 0000 0000 0000 0000
0000 0000 0000 0000 0000 0000 0000 0000 0000 0000 0000 0000 0000 0000 0000 0000
0000 0000 0000 0000 0000 0000 0000 0000 0000 0000 0000 0001 0001 2FC0

In this example, the **errpt** output indicates that the error was hardware in nature and a PERM type, or severe error from which the system could not recover. This error was a disk operation error on hdisk0, and may be due to a failing disk drive or a bad device cable. Given that the error had appeared twice in the errpt, it may be necessary to have a customer engineer service the machine by checking cables and hardware, replacing any parts that have worn out.

Copying an error log to diskette or tape

You may need to send the error log to AIX System Support Center for analysis. To copy the error log to a diskette, place a formatted diskette into the diskette drive and use the following commands:

```
ls /var/adm/ras/errlog | backup -ivp
```

To copy the error log to tape, place a tape in the drive and enter:

```
ls /var/adm/ras/errlog | backup -ivpf/dev/rmt0
```

Log maintenance activities

The **errlogger** command allows the system administrator to record messages in the error log. Whenever you perform a maintenance activity, replace hardware, or apply a software fix, it is a good idea to record this activity in the system error log.

The following example shows the log entries before and after a message (Error Log cleaned) was logged by an operator (using the **errlogger** command) in the error log:

```
# errpt
IDENTIFIER  TIMESTAMP  T C RESOURCE_NAME  DESCRIPTION
9DBCfDEE   1109164598 T 0 errdemon       ERROR LOGGING TURNED ON
192AC071   1109164598 T 0 errdemon       ERROR LOGGING TURNED OFF
# errlogger "Error Log cleaned"
# errpt
IDENTIFIER  TIMESTAMP  T C RESOURCE_NAME  DESCRIPTION
AA8AB241   1109164698 T 0 OPERATOR       OPERATOR NOTIFICATION
9DBCfDEE   1109164598 T 0 errdemon       ERROR LOGGING TURNED ON
192AC071   1109164598 T 0 errdemon       ERROR LOGGING TURNED OFF
```

The identifier AA8AB241 in the preceding example is the message record entry with a description of OPEARATOR NOTIFICATION.

8.3 System dump facility

The system dump copies selected kernel structures to the dump device when an unexpected system halt occurs. The dump device can be configured dynamically to either a tape or a logical volume on the hard disk to store the system dump. A primary dump device is a dedicated dump device, while a secondary dump device is shared.

While installing an operating system, the dump device is automatically configured. By default, AIX 5L Version 5.1 configures /dev/hd6 (paging logical volume) as the primary dump device and /dev/sysdumpnull as the secondary dump device. If the system was migrated from AIX Version 3, /dev/hd7 (the default dump device for AIX Version 3) will continue to be the default dump device for AIX 5L Version 5.1.

The dump can either be system initiated or user initiated, as shown in Figure 8-4. When the system dump completes, the system either halts or reboots, depending upon the setting of the autorestart attribute of sys0, which can be shown and altered using SMIT by selecting System Environments, and then Change / Show Characteristics of Operating System. The Automatically REBOOT system after a crash option shows and sets the value of sys0 attribute.

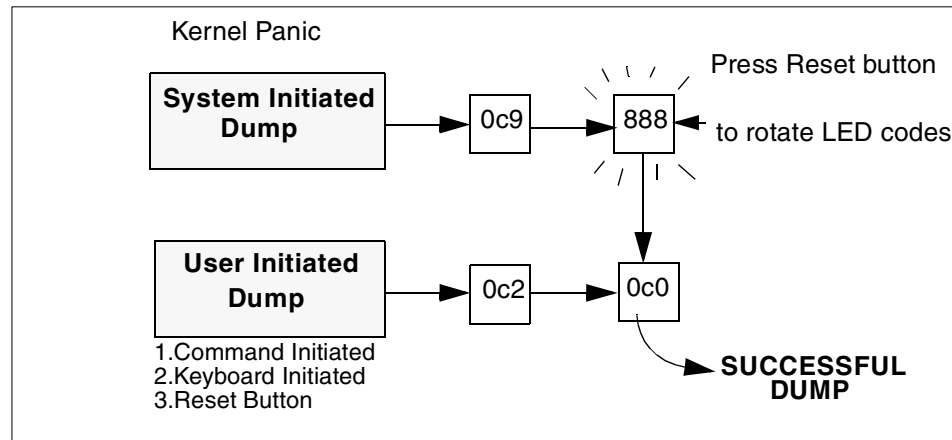

Figure 8-4 Successful system dumps - LED codes

8.3.1 Managing a dump device

The `sysdumpdev` command is used to dynamically configure the dump device, as shown in the following examples.

- ▶ To list the current dump destination, use the following command:

```
# sysdumpdev -l
primary          /dev/hd6
secondary        /dev/sysdumpnull
copy directory   /var/adm/ras
forced copy flag TRUE
always allow dump FALSE
```

- ▶ The following example shows the command to change the primary dump device from the default, `/dev/hd6`, to `/dev/hd9`:

```
# sysdumpdev -P -p /dev/hd9
primary          /dev/hd9
secondary        /dev/sysdumpnull
copy directory   /var/adm/ras
forced copy flag TRUE
always allow dump FALSE
```

- ▶ To estimate the dump size of the current system, run the following command:

```
# sysdumpdev -e
0453-041 Estimated dump size in bytes: 18227200
```

- ▶ The following example shows the command to display statistical information about the previous dump, and in this example, there is no dump record:

```
# sysdumpdev -L
0453-019 No previous dumps recorded.
```

- ▶ The following example shows running the **sysdumpdev -L** command after a successful dump has occurred on the system:

```
# sysdumpdev -L
0453-039

Device name:          /dev/hd6
Major device number: 10
Minor device number: 2
Size:                24202752 bytes
Date/Time:           Tue Nov 10 16:50:45 CST 1998
Dump status:         0
dump completed successfully
Dump copy filename: /var/adm/ras/vmcore.1
```

Alternatively, all the commands used in the preceding examples of this section can be executed using the SMIT fast path **smit dump**, which will display the menu shown in Figure 8-5 on page 197. Select the appropriate option from the menu to do the desired function.

```
System Dump
Move cursor to desired item and press Enter.
Show Current Dump Devices
Show Information About the Previous System Dump
Show Estimated Dump Size
Change the Primary Dump Device
Change the Secondary Dump Device
Change the Directory to which Dump is Copied on Boot
Start a Dump to the Primary Dump Device
Start a Dump to the Secondary Dump Device
Copy a System Dump from a Dump Device to a File
Copy a System Dump from a Dump Device to Diskette
Always ALLOW System Dump

F1=Help      F2=Refresh   F3=Cancel    F8=Image
F9=Shell     F10=Exit    Enter=Do
```

Figure 8-5 System Dump menu

8.3.2 System initiated dump

A system dump initiated by a kernel panic is written to the primary dump device.

Understanding flashing 888 error messages

A flashing 888 in a three digit hardware display indicates that a message is encoded as a string of three digit display values which can be read by pressing the reset button repeatedly and noting the changed three digit value every time until a flashing 888 is displayed again. Some RS/6000 systems use an advance button to perform this task.

An initial value of 102 after flashing 888 indicates an unexpected system halt, as shown in Figure 8-6 on page 198. The value of mmm indicates the cause of halt and crash code (see Table 8-3 on page 198), and the value of ddd indicates the dump status and dump code (see Table 8-4 on page 199).

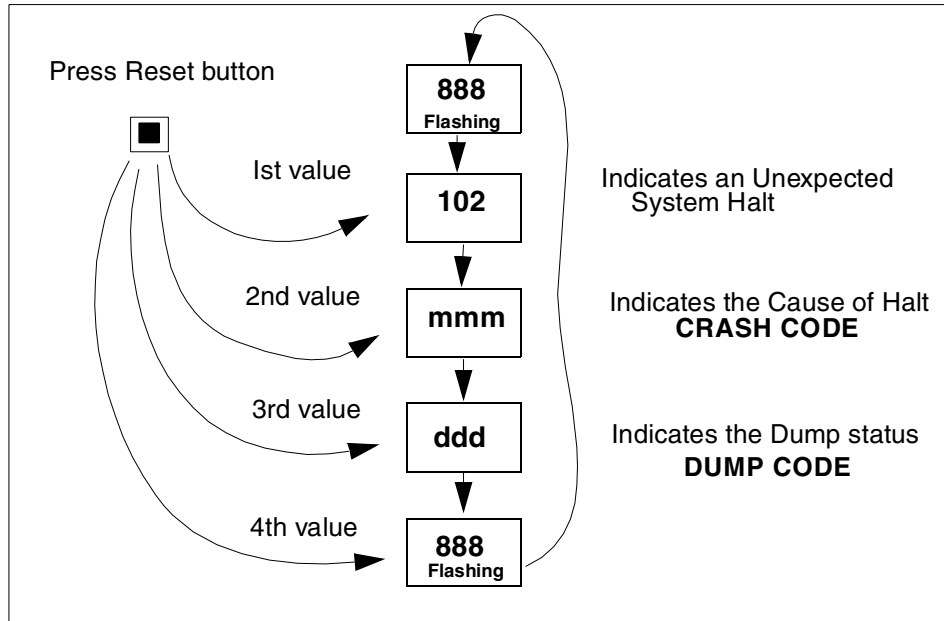

Figure 8-6 Unexpected system halt - Three-digit display string

Table 8-3 lists various crash codes. The 2xx type codes describe a machine check that is reporting hardware failure.

Table 8-3 Crash codes

Code	Description
000	Unexpected system interrupt.
200	Machine check due to memory bus error (RAS/CAS parity).
201	Machine check due to memory time out.
202	Machine check due to memory card failure.
203	Machine check due to address exception: address out of range.
204	Machine check due to attempted store into R.
205	Machine check due to uncorrectable error correction code, due to address parity.
206	Machine check due to uncorrectable error correction code.
207	Machine check due to undefined error.
208	Machine check due to an L2 uncorrectable ECC.

Code	Description
300	Data storage interrupt: processor type.
32x	Data storage interrupt: The number represented by x is the bus unit identification.
38x	Data storage interrupt: The number represented by x is the bus unit identification.
400	Instruction storage interrupt.
500	External interrupt.
52x	External interrupt.
53x	External interrupt because of IOCC bus timeout.
54x	External interrupt because of IOCC keyboard check.
700	Program interrupt.
800	Floating point unavailable.

Table 8-4 lists various system dump codes.

Table 8-4 System dump codes

Code	Description
0c0	Dump completed successfully.
0c2	Dump started.
0c3	The dump is inhibited.
0c4	Dump completed unsuccessfully. Not enough space available on dump device. Partial dump available.
0c5	Dump failed to start. Unexpected error occurred when attempting to write to dump device.
0c7	Network dump in progress.
0c8	Dump disabled. System configuration does not include a dump device.
0c9	System initiated dump started.

8.3.3 User initiated dump

There are three ways for a user to invoke a system dump, depending upon the system condition, as shown in Figure 8-7 on page 201. The following sections discuss the steps involved in initiating a system dump, verifying the dump, copying the dump onto a tape, and sending it to a Service Support Center for analysis.

Check the estimated dump size

The following command shows the estimated size of dump will be 20971520 bytes:

```
# sysdumpdev -e
0453-041 Estimated dump size in bytes: 20971520
```

Check the size of primary dump device

The primary dump device, in this case, is the paging logical volume (/dev/hd6). To display its size, use the **lspv -a** command, as shown in the following example. If the reported free space is less than estimated dump size (reported in the preceding section), you should increase the dump device size. The following example shows the 128 MB of primary dump device with 6 percent used:

```
# lspv -a
Page Space   Physical Volume   Volume Group   Size   %Used   Active   Auto   Type
hd6          hdisk0             rootvg         128MB   6       yes     yes   lv
```

Starting a dump

If you initiate the system dump from the command line, use the **sysdumpstart** command with a **-p** flag to write to the primary device or a **-s** flag to write to the secondary device.

If the dump is initiated using the special key sequences, use the sequence Ctrl-Alt-NumPad1 to write to the primary dump device and use the sequence Ctrl-Alt-NumPad2 to write to the secondary dump device. If you initiate a system dump by pressing the reset button, the system dump is written to the primary dump device.

Note: By default, the system will not begin a dump by pressing the special key sequences or pressing the reset button unless the keymode switch is in the service position. To enable dumps via the use of the special key sequences or pressing the reset button while the keymode switch is in the normal position, run the command:

```
# sysdumpdev -K
```

On a system without a keymode switch, a dump cannot be forced with the reset button unless this value has been set.

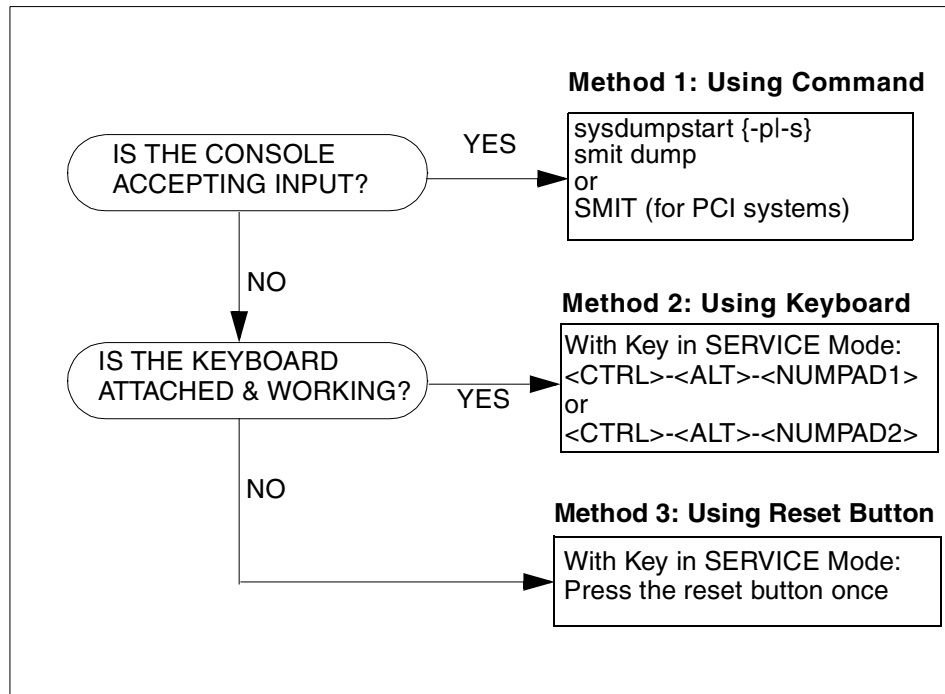

Figure 8-7 Method of user initiated system dump

Verifying a system dump

The `crash` command is an interactive tool that is used to examine a system dump file. Checking that the dump is readable saves time by reducing callbacks from the support center.

To invoke the **crash** command on a system image file and kernel file, use the following command syntax:

```
# crash SystemImageFile KernelFile
```

where SystemImageFile is either a file name or the name of the dump device and KernelFile is the default kernel /usr/lib/boot/unix.

The following example shows the commands to obtain the system dump file name (var/adm/ras/vmcore.1) and then uses the **crash** command on that dump file to verify the validity of dump:

```
# sysdumpdev -L
0453-039

Device name:          /dev/hd6
Major device number: 10
Minor device number: 2
Size:                24202752 bytes
Date/Time:           Tue Nov 10 16:50:45 CST 1998
Dump status:         0
dump completed successfully
Dump copy filename: /var/adm/ras/vmcore.1
#
# crash /var/adm/ras/vmcore.1
Using /unix as the default namelist file.
>
> stat
    sysname: AIX
    nodename: aix4xdev
    release: 3
    version: 4
    machine: 000044091C00
    time of crash: Tue Nov 10 16:50:45 CST 1998
    age of system: 1 day, 5 hr., 28 min.
    xmalloc debug: disabled
    abend code: 0
    csa: 0x0
>
> quit
#
```

If the **crash** command outputs the **>**, and the **stat** subcommand verifies the details of dump, the dump is successful. Any other output indicates the dump may not be successfully analyzed.

Copying system dumps

In AIX 5L Version 5.1, the **pax** command allows you to copy, create, and modify files that are greater than 2 GB in size, like system dumps, from one location to another. This can be useful in migrating dumps, as the **tar** and **cpio** commands (formerly used for copying dumps in previous versions of AIX) cannot handle manipulating files that are larger than 2 GB in size. The **pax** command can also view and modify files in tar and cpio format.

The syntax for the **pax** command is as follows:

```
pax [ -r | -w | -rw ] [ -c ] [ -d ] [ -i ] [ -k ] [ -l ] [ -n ] [ -t ] [ -u ]  
[ -v ] [ -X ] [ -H | -L ] [ -p String ... ] [ -o Options ]  
[ -s ReplacementString ... ] [ -x Format ] [ File ... ] Directory
```

Table 8-5 shows commonly used flags for the **pax** command.

Table 8-5 Common flags for pax

Flag	Description
-a	Appends files to the end of an archive.
-c	Matches all file or archive members except those specified by the Pattern parameter.
-d	Causes directories being copied, archived, or extracted, to match only the directory itself and not the contents of the directory.
-f <i>Archive</i>	Specifies the path of an archive file to be used instead of standard input (when the -w flag is not specified) or standard output (when the -w flag is specified but the -r flag is not).
-i	Renames files or archives interactively.
-k	Prevents the pax command from writing over existing files.
-r	Reads an archive file from the standard input.
-v	Writes information about the process. If neither the -r or -w flags are specified, the -v flag produces a verbose table of contents; otherwise, archive member path names are written to standard error.
-w	Writes files to the standard output in the specified archive format.
-x <i>Format</i>	Specifies the output archive format. If no format is provided, pax uses the pax format by default.

The **pax** command can output archives in one of three formats by using the **-x** flag:

pax	The default interchange format. This format can support file sizes larger than 2 GB in size.
cpio	The extended cpio interchange format.
ustar	The extended tar interchange format.

Note: If the **-x** flag is not specified during an archive operation, the **pax** command will output archives in tar format by default.

For example, to view the contents of the tar file `/tmp/etc.tar`, run the command:

```
# pax -vf /tmp/etc.tar
drwxr-xr-x 0 root  system      Sep  6 13:17 .
-rw-r--r-- 0 root  system    1856 Apr  5 15:56 ./consdef
-r-xr-xr-x 0 bin   bin       880 Apr  5 15:06 ./csh.cshrc
-r-xr-xr-x 0 bin   bin       944 Apr  5 15:06 ./csh.login
-rw-r--r-- 0 bin   bin      1126 Apr  5 13:21 ./dlpi.conf
-rw-rw-r-- 0 bin   system     74 Aug 30 14:15 ./dumpdates
-rw-rw-r-- 0 root  system    1748 Aug 23 15:28 ./environment
-rw-rw-r-- 0 root  system    1593 Aug 23 15:14 ./filesystems
-rw-r--r-- 0 root  security  333 Aug 30 14:18 ./group
-rw-r--r-- 0 root  system   2235 Sep  6 13:16 ./inittab
-r-xr-xr-x 0 bin   bin     21332 Aug 23 14:52 ./magic
...
```

To create a pax archive called `tmp.pax` that contains two files, `/home/matt/soft.tar` and `/home/chad/soft.tar`, that total over 2 GB in size, run the command:

```
# pax -x pax -wvf tmp.pax /home/matt/soft.tar /home/chad/temp.tar
/home/matt/soft.tar
/home/chad/temp.tar
```

To copy the dump file `dump.out` to the tape drive `rmt1`, run the command:

```
# pax -wvf /dev/rmt1 dump.out
dump.out
```

To untar the tar file `/var/adm/link.tar` to the current directory, run the command:

```
# pax -rvf /var/adm/link.tar
USTAR format archive
./link.out
./link.in
```

To copy the file `run.pax` to the `/tmp` directory, run the command:

```
# pax -rw run.pax /tmp
```

Compile and copy a system dump onto media

The **snap** command is used to gather configuration information of the system. It provides a convenient method of sending the **ls1pp** and **errprt** output to your service support center. It gathers the information and compresses the information to a pax file, which can be downloaded to a tape or diskette or electronically transmitted.

The syntax for the **snap** command is as follows:

```
snap [ -a ] [ -A ] [ -b ] [ -c ] [ -D ] [ -f ] [ -g ] [ -G ] [ -i ] [ -k ]  
[ -l ] [ -L ] [ -n ] [ -N ] [ -p ] [ -r ] [ -s ] [ -S ] [ -t ] [ -T ] [ -w ]  
[ -o OutputDevice ] [ -d Dir ] [ -v Component ]
```

Table 8-6 shows commonly used flags for the **snap** command.

Table 8-6 Common flags for *snap*

Flag	Description
-a	Gathers all system configuration information. This option requires approximately 8 MB temporary (<code>/tmp</code>) free disk space.
-c	Creates a compressed pax image (<code>snap.pax.Z</code> file) of all files in the <code>/tmp/ibmsupt</code> directory tree or other named directory.
-D	Gathers dump and <code>/unix</code> information. The primary dump device is used.
-d <i>Directory</i>	Identifies the optional snap command output directory (<code>/tmp/ibmsupt</code> is default).
-f	Gathers file system information.
-g	Gathers the output of the ls1pp -hBc command, which is required to recreate the exact operating system environments. Writes output to the <code>/tmp/ibmsupt/general/ls1pp.hBc</code> file. Also collects general system information and writes the output to the <code>/tmp/ibmsupt/general/general.snap</code> file.
-k	Gathers kernel information.
-L	Gathers LVM information.
-o <i>OutputDevice</i>	Copies the compressed image to onto diskette or tape.
-r	Removes snap command output from the <code>/tmp/ibmsupt</code> directory.

Flag	Description
<i>-v Component</i>	Displays the output of the commands executed by the snap command. Use this flag to view the specified name or group of files.

The default directory for the output from the **snap** command is `/tmp/ibmsupt`. If you want to name an optional directory, use the `-d` option with the path of the desired output directory. Approximately 8 MB of temporary disk space is required when executing all of the **snap** command options. The cleanup option `-r` should be used to remove the information saved by the **snap** command and to retrieve disk space.

For example, to copy system information including file system and kernel parameters to `rmt0`, you would run:

```
# /usr/sbin/snap -gfkD -o /dev/rmt0
```

Before executing the **snap -c** or **snap -o** commands, any additional information required by your service support center should be copied to the `/tmp/ibmsupt` directory. For example, you may be asked by your service support center to provide a test case that demonstrates the problem. The test case should be copied to the `/tmp/ibmsupt` directory. When the `-c` or `-o` option of the **snap** command is executed, the test case will be included.

Note: Only root can run the **snap** command to gather system information.

8.4 Quiz

The following certification assessment questions help verify your understanding of the topics discussed in this chapter.

1. A system administrator is using **installp** to install the software for a new SSA adapter that was just added to an F50. The install seems to hang for an unusually long time and the LED display reads `0c9`. What is most likely happening?
 - A. The system is committing the SSA lpps.
 - B. The system has crashed and is dumping.
 - C. The system is running **cfgmgr** to add the device.
 - D. The system is running diagnostics on the SSA subsystem.

2. ABC Company is trying to send a system dump to IBM for analysis along with system data. Free space is extremely tight. The system administrator logs in as himself and issues the command `/usr/sbin/snap -gfkD -o /dev/rmt0`. Nothing is created on the tape. What could the problem be?
 - A. Only root can run the **snap** command and 8 MB of free space must be available in the /tmp directory.
 - B. The command should be `/usr/sbin/snap -c -o /dev/rmt0` and there must be 8 MB of free space available in /tmp.
 - C. The estimated dump size estimated with the `sysdumpdev -e` command, was too small and the dump was never created.
 - D. There was no dump data created in /var/spool/tmp. A dump needs to be created first before the **snap** command can be run.
3. After rebooting, the support specialist decides to check the error log for errors. Which of the following is the correct command to use?
 - A. **crash**
 - B. **errpt -a**
 - C. **errlog -a**
 - D. **errlog -k**

The following are additional questions created by the authors to further test your understanding of the topics.

1. A system administrator is using `installp` to install the software for a new SSA adapter that was just added to an F50. The install seems to hang for an unusually long time and the LED display reads 0c9. What is most likely happening?
 - A. The system has crashed and is dumping.
 - B. The system is committing the SSA lpps.
 - C. The system is running `cfgmgr` to add the device.
 - D. The system is running diagnostics on the SSA subsystem.

2. Customer XYZ has been running with AIX Version 4 for several months with no problems. The system just crashed and they need assistance with determining what happened. By pressing the yellow reset button, they found that the crash codes displayed on the LEDs were: 888-102-700-0c0. These LED codes indicate that:
 - A. It was a software problem and there is a partial dump for analysis.
 - B. It was a hardware problem and there is a partial dump for analysis.
 - C. It was a software problem and there is a complete dump for analysis.
 - D. It was a hardware problem and there is a complete dump for analysis.
3. Analyzing the following error report listing, how would a system specialist find out detailed information on why the system shutdown?

IDENTIFIER	TIMESTAMP	T	C	RESOURCE_NAME	DESCRIPTION
2A9F5252	1119151898	P	H	tok0	WIRE FAULT
2BFA76F6	1117101698	T	S	SYSPROC	SYSTEM SHUTDOWN BY USER
9DBCfDEE	1117101998	T	O	errdemon	ERROR LOGGING TURNED ON
192AC071	1117101598	T	O	errdemon	ERROR LOGGING TURNED OFF
AA8AB241	1116181498	T	O	CMDCRASH_EXIT	OPERATOR NOTIFICATION
AA8AB241	1116181498	T	O	CMDCRASH_ENTRY	OPERATOR NOTIFICATION
2BFA76F6	1116173598	T	S	SYSPROC	SYSTEM SHUTDOWN BY USER
9DBCfDEE	1116174198	T	O	errdemon	ERROR LOGGING TURNED ON
192AC071	1116173498	T	O	errdemon	ERROR LOGGING TURNED OFF
2BFA76F6	1116164698	T	S	SYSPROC	SYSTEM SHUTDOWN BY USER

- A. **errpt 2BFA76F6**
 - B. **errpt -j 2BFA76F6**
 - C. **errpt -a -j 2BFA76F6**
 - D. **errpt -a -k 2BFA76F6**
4. ABC Company has an employee time tracking application which has randomly stopped running several times over the last few months. The system administrator has written a script that monitors the status of the application. If the application is not running, the script restarts the application and adds an entry to the system error log reporting the time of the failure. What command is used in the monitor script to add the failure message to the system error log?
 - A. **errpt**
 - B. **errsave**
 - C. **errorlog**
 - D. **errlogger**

8.4.1 Answers

The following answers are for the assessment quiz questions.

1. B
2. A
3. B

The following answers are for the additional quiz questions.

1. A
2. C
3. C
4. D

8.5 Exercises

The following exercises provide sample topics for self study. They will help ensure comprehension of this chapter.

1. Determine the status of an error logging daemon on the system.
2. Display the error log on the system. Delete all the software entries from the error log.
3. Determine the size of error log file on the system.
4. Display only the errors with resource name `hdisk0` from the error log.
5. Copy the error log on to a tape device (`/dev/rmtx`).
6. You have applied a new APAR. Log an entry into the error log to record this activity. With what resource name is the entry listed when you display the error log with the `errpt` command?
7. Estimate the dump size for the system. Display your current dump device configuration. If the size of a dump device is less than the estimated dump size, increase the size of the dump device and initiate a dump on the system.
8. Verify the system dump taken in the preceding step using the `crash` command.
9. Copy the dump on to a tape using the `snap` command.



System backup and restore

This chapter covers the backup and restore procedures and the common tasks that are carried out to ensure that you have backed up the proper information and that your backup media is reliable.

9.1 Saving information

Data in AIX is divided in system and user parts. System data makes up the operating system and its extensions. It is kept in several file systems in the root volume group, such as /, /usr, /var, and /tmp. User data is mainly contained in user-defined file systems. User data can exist in file systems both inside and outside of the root volume group. By default, the /home file system is the repository for user data in the root volume group.

AIX provides you with a number of commands to successfully back up your system to ensure availability of data at all times. These commands vary, depending on the type of information you are trying to save.

Figure 9-1 on page 213 shows you the flow of the backup process, for example, in order to save rootvg you can adopt different approaches, depending on what are you trying to save by using the **mksysb** command. You can alternatively save individual files by using the **tar**, **cpio**, **dd**, and **backup** commands. You can also save entire user volume groups by using the **savevg** command.

Figure 9-1 on page 213 summarizes the methods used to back up system and user data.

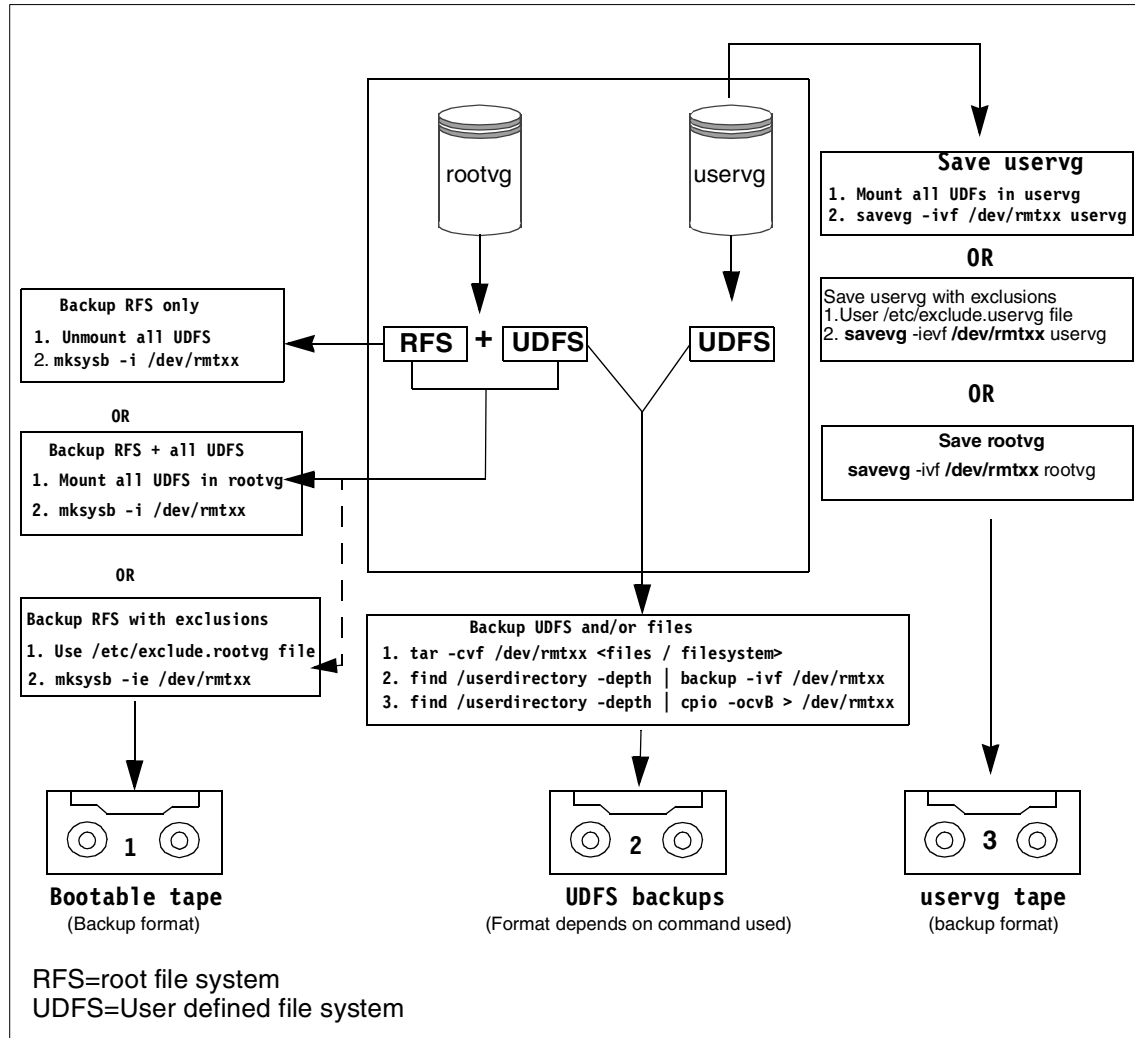

Figure 9-1 Flowchart for saving information

9.2 The data layout of a mksysb tape

The contents of a **mksysb** tape are shown in Figure 9-2.

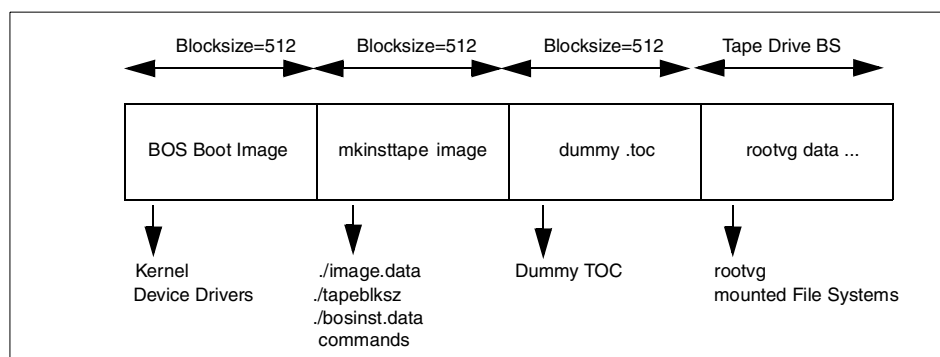

Figure 9-2 Layout of a mksysb tape

The BOS boot image contains a copy of the system's kernel and device drivers needed to boot from the **mksysb** tape. It is created by the **bosboot** command.

There are three important files in the mkinsttape image (the second image of the **mksysb** tape): `./tapeblksz`, `./bosinst.data`, and `./image.data`. The `./tapeblksz` file contains the block size the tape drive was set to when the **mksysb** command was run.

The `./bosinst.data` file allows you to specify the requirements at the target system and how the user interacts with the target system. This file contains the customized BOS install procedures and dictates how the BOS install program will behave. You can customize this file before issuing the **mksysb** command or use a procedure to customize this after the image backup is done.

The `./image.data` file contains information describing the image installed during the BOS installation process. This information includes the sizes, names, maps, and mount points of logical volumes and file systems in the rootvg. You can customize this file before using the **mksysb** command, or run **mksysb -i** to generate a new `./image.data` file on the tape during a backup. The **mkszfile** command generates the `./image.data` file. The `./image.data` file is arranged in stanza format. Each stanza contains one or more fields. The most important fields are:

- SHRINK** When set to YES, causes the system to create the smallest file systems required to contain all the data in the file system.
- BOSINST_FILE** Provides the full path name of a file or command to execute after the BOS install completes.

EXACT_FIT When set to YES, causes the system to place logical volumes on the disk according to the physical partition maps that were generated with the `-m` flag of the **mksysb** command.

The dummy Table Of Contents (TOC) is used to have the **mksysb** tape contain the same number of images as a BOS install tape.

The rootvg data area contains all data in the rootvg volume group backed up by the **mksysb** command. The **mksysb** command uses the **backup** command to save the contents of mounted JFS data in rootvg, excluding raw data.

Note: Keep the following points in mind while running the **mksysb** command:

- ▶ Use `/etc/exclude.rootvg` file to exclude any file, file system, directory or patterns that you do not need in your backup. Use the `-e` flag with the **mksysb** command to use the `exclude.rootvg` file.
- ▶ `/tmp` is used as a work area by the **mksysb** command. It typically needs 8 to 12 MB of free space in `/tmp`. Use the `-X` flag with **mksysb** to automatically expand the `/tmp` file system; otherwise, you will encounter an error similar to:

0511-432 A write error occurred: There is not enough space in the file system.

and **mksysb** will fail.
- ▶ Use the `-p` flag (disable software packing of backup) only if you know that your tape drive does not do compression.

9.3 Verifying system backups

The only method to verify that the system backup will correctly restore with no problems is to actually restore all the files listed in your company's disaster recovery plan. However, in order to minimize problems due to tape media damage, there are a number of ways you can verify whether your backup has been done properly or not:

- ▶ Using SMIT.
- ▶ Using the **restore** command.

Note: The only way to verify that the **mksysb** tape will successfully boot is to bring the machine down and boot from the tape. No data needs to be restored. Data verification can be done using the following techniques.

However, caution must be taken if the PROMPT field in the bosinst.data file is set to NO, which will cause the system to begin a **mksysb** restore automatically.

9.3.1 Using SMIT to verify a tape

Generally, **mksysb** is an unattended activity, so you need to look for errors that might have occurred during the save operation that will render data unavailable if you try to restore from it. It is always a good practice to look at your smit.log file after a **mksysb** is run from SMIT. It is recommended that you do not run **mksysb** directly from the command line in order to ensure that you do not miss errors generated during a save operation.

In order to verify the **mksysb** tape, use the SMIT fast path **smitty 1smksysb** and perform the steps that follow. A screen similar to Figure 9-3 will be shown.

```

                                List Files in a System Image

Type or select values in entry fields.
Press Enter AFTER making all desired changes.

                                [Entry Fields]
* DEVICE or FILE                                [dev/rmt0]          +/
Number of BLOCKS to read in a single input        []                    #
  (Leave blank to use a system default)
Verify BLOCK size if tape device?                 no                    +

F1=Help      F2=Refresh    F3=Cancel    F4=List
F5=Reset     F6=Command   F7=Edit     F8=Image
F9=Shell     F10=Exit     Enter=Do

```

Figure 9-3 List Files in a System Image menu

1. Select your backup device name.

2. Select defaults for all other parameters and press Enter=DO. This will list the contents of your **mksysb** tape and log them in the `smit.log`, as shown below:

```
New volume on /dev/rmt0.1:
Cluster size is 51200 bytes (100 blocks).
The volume number is 1.
The backup date is: Tue Nov 10 17:02:28 CST 1998
Files are backed up by name.
The user is root.
./bosinst.data
./image.data
./tmp/vgdata/rootvg/copied.map
./tmp/vgdata/rootvg/fs1v00.map
./tmp/vgdata/rootvg/hd1.map
./tmp/vgdata/rootvg/hd2.map
...
```

Cross check the listing and verify that none of your important files are missing. This will ensure that data will be available to you once you need it. The listing that is generated as a result of executing this command is helpful in finding out the date this tape was generated, which might help you if you do a **mksysb** on a regular basis and do not rotate tapes. If your tape tags are accidentally destroyed, you can still find out the latest backup you have by using this method.

9.3.2 Using restore to verify a tape

In order to verify a **mksysb** tape without using SMIT, you need to use the **restore** command, because all the files with **mksysb** are archived in the backup file format using the **backup** command.

Data on a **mksysb** tape is written from the fourth file marker onwards (see Section 9.2, “The data layout of a **mksysb** tape” on page 214 for details on **mksysb** tape format), so you need to control the tape manually to move to the correct segment of the tape. Use the **tctl** command to control the tape. The general syntax of the **tctl** command is as follows:

```
tctl [ -f Device ] [ eof | weof | fsf | bsf | fsr | bsr | rewind | offline |
rewoffl | erase | retention | reset | status ] [ Count ]
```

The **tctl** command gives subcommands to a streaming tape device. Subcommands most frequently used by **tctl** are listed in Table 9-1.

Table 9-1 Common **tctl** subcommands

Subcommand	Description
rewind	Rewinds the tape.

Subcommand	Description
rewoffl or offline	Rewinds the tape and takes the tape drive offline. This will unload or eject the tape when appropriate. The tape must be reinserted, or another tape must be loaded before the device can be used again.
status	Displays status information about the specified tape device.
fsf <i>Count</i>	Moves the tape forward by the number of file marks specified by the <i>Count</i> parameter, and positions it on the end-of-tape (EOT) side of the file mark.
bsf <i>Count</i>	Moves the tape backward by the number of file marks specified by the <i>Count</i> parameter, and positions it on the beginning-of-tape (BOT) side of the file mark. If the bsf subcommand attempts to move the tape past the beginning, the tape will rewind and the tctl command returns EIO.

The general syntax for the **restore** command is as follows:

```
restore -[ T | x | r | R | i ] [ B d h M q v y ] [ -b Number ] [ -f Device ]
[ -s SeekBackup ] [ -X VolumeNumber ] [ File ... ]
```

Table 9-2 is a list of common command flags and their descriptions for the **restore** command.

Table 9-2 Command flags for restore

Flag	Description
-f <i>Device</i>	Specifies the input device.
-q	Specifies that the first volume is ready to use and that the restore command should not prompt you to mount the volume and hit Enter.
-R	The -R flag allows a previously interrupted restore to be restarted. Once restarted, the restore command behavior is the same as with the -r flag.
-r	Restores all files in a file system archive.
-S <i>SeekBackup</i>	Specifies the backup to seek and restore on a multiple-backup tape archive. The -s flag is only applicable when the archive is written to a tape.
-T	Displays information about the backup archive.
-v	Displays additional information when restoring.
-x	Restores individually named files specified by the File parameter.

To see the contents of the **mksysb** tape, use the following sequence of commands:

1. Rewind the tape using the command:

```
tctl -f /dev/rmtxx rewind
```

2. Advance the tape to the fourth file marker by running the command:

```
tctl -f /dev/rmtxx fsf 3
```

3. Read the contents of the tape and redirect the output to a temporary file by using the command:

```
restore -Tvqf /dev/rmtxx.1 > /tmp/mksysb.log
```

You can skip the second step in the procedure and go directly to viewing the contents of the tape by running the command:

```
restore -s4 -Tvqf /dev/rmtxx.1 > /tmp/mksysb.log
```

The **-s4** flag of the **restore** command automatically advances the tape to the beginning of the fourth file marker for restore.

This will generate a listing similar to the `smit.log` output shown in Section 9.3.1, “Using SMIT to verify a tape” on page 216.

9.4 Saving user data

User data in the rootvg is stored with **mksysb**, depending on what file systems you have mounted when the **mksysb** command is run and the contents of the `/etc/exclude.rootvg` file. Alternatively, there are several other ways to back up user data outside the rootvg, and other ways of backing up user data within the rootvg. This section briefly describes some of these backup methods.

9.4.1 Backing up user data

The **backup** command that is invoked by the **mksysb** command can also be run by itself to back up user data. The backup command can back up both user data in the rootvg and in user volume groups. The general syntax of the backup command is as follows:

```
backup -i [ -b Number ] [ -p [ -e RegularExpression ] ] [ -f Device ]  
[ -l Number ] [ -o ] [ -q ] [ -v ]
```

Table 9-3 shows a list of common command flags and their descriptions for the **backup** command.

Table 9-3 Command flags for backup

Flag	Description
-f	Specifies the output device.
-i	Specifies that files be read from standard input and archived by file name.
-p	Specifies that the files be packed, or compressed, before they are archived. Only files of less than 2 GB are packed. This option should only be used when backing up files from an inactive file system. Modifying a file when a backup is in progress may result in corruption of the backup and an inability to recover the data. When backing up to a tape device that performs compression, this option can be omitted.
-q	Indicates that the removable medium is ready to use. When you specify the -q flag, the backup command proceeds without prompting you to prepare the backup medium. Press the Enter key to continue.
-u	Updates /etc/dumpdates with time, date, and level of the last incremental backup.
-v	Causes the backup command to display additional information about the backup.

For example, to back up the directory /data/crash to the tape drive, you would run:

```
# cd /data/crash
# find . -depth | backup -ivf /dev/rmt0
```

or

```
# find . -print | backup -ivf /dev/rmt0
```

These commands will back up the information in /data/crash using relative path names. When you restore the information using the **restore** command, you need to be in the /data/crash directory, or else it will restore the information into your current directory.

Note: The `-i` flag causes the **backup** command to back up files listed from standard input. Do not attempt to directly back up data with the **backup -i** command, such as:

```
# backup -ivf /dev/rmt0 /data/crash
```

This will cause the command to hang indefinitely.

Alternatively, you can use the **tar**, **cpio**, or **dd** commands to save user files, directories, and file system data.

9.4.2 Backing up user volume groups

Since the **mksysb** command only backs up rootvg, in order to save user volume groups, use the **savevg** command. The **savevg** command finds and backs up all files belonging to a specified volume group. A volume group must be varied on, and the file systems must be mounted. The **savevg** command uses the data file created by the **mkvgdata** command to back up files.

The general syntax of the **savevg** command is as follows:

```
savevg [ -b Blocks ] [ -e ] [ -f Device ] [ -i | -m ] [ -p ] [ -v ] [ -X ]  
VGName
```

Table 9-4 shows a list of common command flags and their descriptions for the **savevg** command.

Table 9-4 Command flags for **savevg**

Flag	Description
-e	Excludes files specified in the <code>/etc/exclude.vgname</code> file from being backed up by this command.
-f <i>Device</i>	Specifies the device or file name on which the image is to be stored. The default is the <code>/dev/rmt0</code> device.
-i	Creates the data file by calling the mkvgdata command.

To back up the **uservg** volume group and create a new **uservg.data** file, run the following command:

```
# savevg -if /dev/rmt0 uservg  
Creating list of files to back up....  
Backing up 9077 files.....  
4904 of 9077 files (54%).....  
8798 of 9077 files (96%).....  
8846 of 9077 files (97%).....
```

```
9029 of 9077 files (99%).....  
0512-038 savevg: Backup Completed Successfully.
```

9.4.3 Backing up raw logical volumes

Raw logical volume data will not be archived using the **savevg** command. In order to save a raw logical volume, use the **dd** command and proceed with the following sequence of steps to save your raw logical volumes:

1. Check the block size of the tape using the **tctl** command:

```
tctl -f /dev/rmtxx status
```

2. Change the block size of the tape to your required block size using:

```
chdev -l rmtxx -a block_size=<tape block size>
```

3. Save the raw logical volume onto a tape device using:

```
dd if=/dev/lvname of=/dev/rmtxx ibs=512 obs=<tape block size>
```

This will create a back up of the raw logical volume on the tape.

If you use the **savevg** command to save a rootvg, the only difference between a **mksysb** image and an **savevg** image is that the **mksysb** command creates the **bos/install** images and places them on the tape to create a bootable/ installable tape. A **savevg** image is not capable of being installed directly.

9.5 Restoring information

Once you have a backup of your data, you can restore it in a number of ways. The flow of the restore process is shown in Figure 9-4 on page 223.

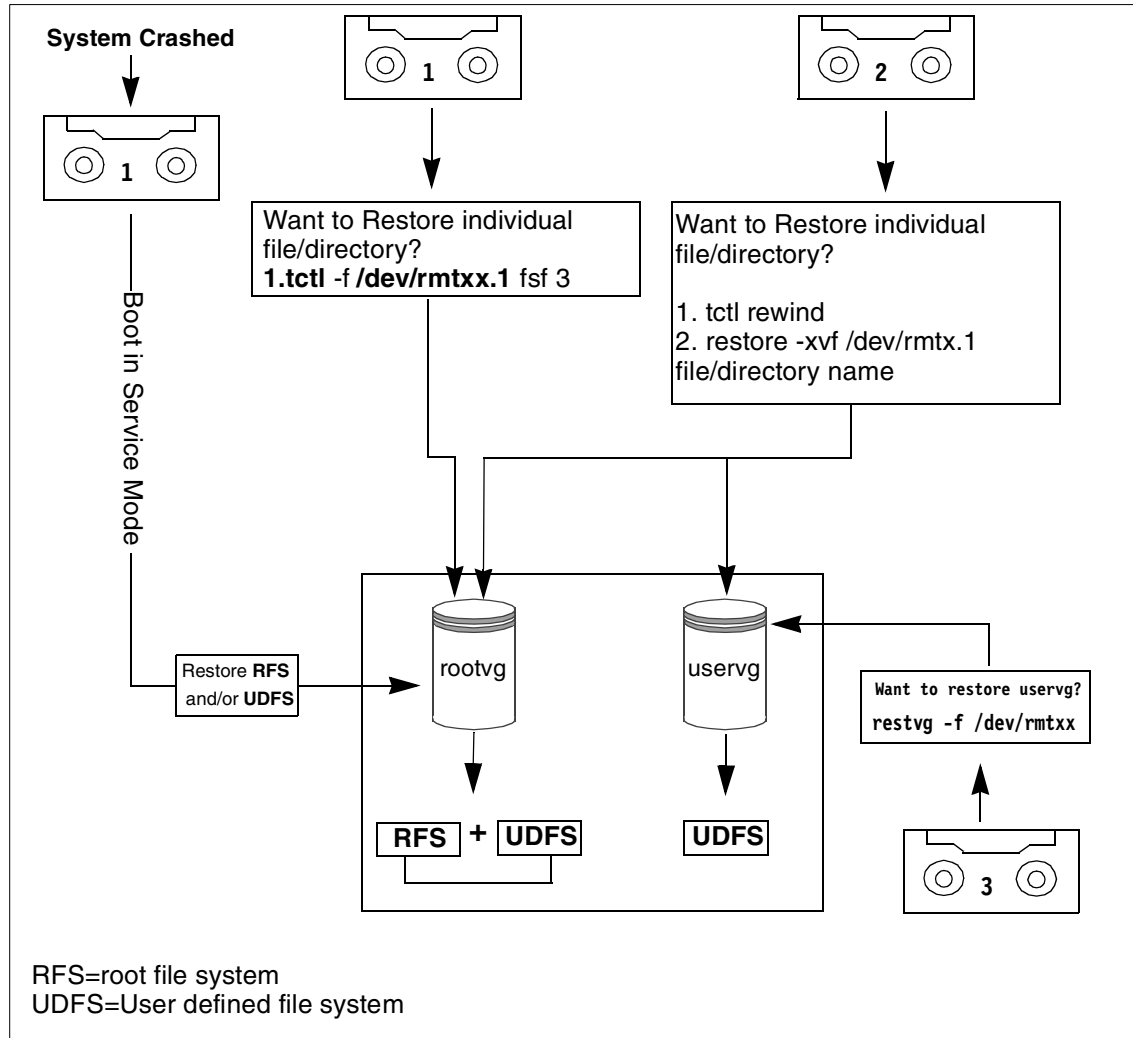

Figure 9-4 Flowchart for restoring information

9.5.1 Restoring rootvg

You can use a **mksysb** tape to restore your entire rootvg by doing the following:

1. Check if your system will boot from tape by running the command:

```
# bootinfo -e
```

If a 1 is returned, a boot from tape is supported. If a 0 is returned, a boot from tape is not supported

2. Put the **mksysb** tape in the tape drive.
3. Check the boot list for service mode by running the command:

```
# bootlist -m service -o
```

If necessary, alter the service boot list to boot from rmt0 by running the command:

```
# bootlist -m service rmt0
```
4. Reboot the system. The system will read from the **mksysb** and prompt you for restoration configuration.

9.5.2 Restoring a non-rootvg volume group

To restore a backup of the user volume group, use the **restvg** command from a **savevg** image. This utility can be used to shrink the size of file systems within the uservg volume group. All you have to do is to modify the `/tmp/vgdata/uservg/uservg.data` file.

To restore the volume group uservg from tape onto the disks specified in the `/tmp/vgdata/uservg/uservg.data` file, enter the following:

```
# restvg -f /dev/rmt0
```

9.5.3 Restoring a file system

The **restore** command is used to restore data backed up with the **backup** command.

To show the table of contents of a tape and list the files on it, run the command:

```
# restore -Tvf /dev/rmt0
```

To restore individual files from a backup made by the **backup -i** command, run the command:

```
# restore -xvf /dev/rmt0 /data/crash
```

To restore an entire file system archive, run the command:

```
# restore -rvf /dev/rmt0 /data
```

9.5.4 Errors with restoring data

There are a number of problems that you may encounter while you are restoring data back onto your system. The following is a short list of problems that you may encounter while restoring data:

1. The most general problem that you can face is the incorrect block size which results in a restore failure. See Section 9.5.5, “Block size determination” on page 225 to learn how to recover from this problem.
2. Your storage media can be physically damaged. Media errors are recorded in the error log. If the media can be read successfully with the **dd** or the **tcopy** command, a syntax or usage problem possibly exists. Syntax or usage problems could include:
 - The incorrect archive utility was used.
 - The **cpio** backup was not written with ASCII headers and the command specifies ASCII headers (-c).
 - The **tar** command has calculated a checksum different from what is recorded on the tape, indicating that the incorrect volume may be in the drive. (Use the -i flag to ignore checksums.)
 - For tapes, the archive utility does not have enough buffer space to hold an entire block from the tape file.
3. During a **restvg** command execution (used for restoring user volume group), you may encounter a failure. Since it expects the **savevg** image to be the first image on the tape. This means that you cannot use a **mksysb** tape to restore the root volume group through the **restvg** command, so you can only restore a **mksysb** tape in the service mode.
4. You may run out of space on a file system restore if the new file system you created does not have enough space on it.

9.5.5 Block size determination

A typical problem with moving tapes between systems is an incorrect block size. Incorrect block sizes can cause the tape to be temporarily unreadable. For example, a tar backup is placed on a tape with a 512 byte block size. When the tape is placed into a system with a 2048 byte block size, and a restore is attempted, the system displays:

```
# tar -tvf /dev/rmt0
tar: 0511-193 An error occurred while reading from the media.
There is an input or output error.
```

There are two methods to determine tape block size:

► Method 1

Use the **tcopy** command as follows:

```
# tcopy /dev/rmt0
tcopy : Tape File: 1; Records: 1 to 7179 ; size:512
tcopy : Tape File: 1; End of file after :7179 records; 3675648 bytes
tcopy : Tape File: 2; Records: 1 to 2900 ; size:512
tcopy : Tape File: 2; End of file after 2900 records, 76890 bytes
...
```

This will give you a list of all the files found on the media with their byte count and the block size (shown in bold) used.

► Method 2

Use the **dd** command to read a single block from the device and find out what block size is used for the archive:

```
dd if=/dev/rmt0 bs=128k count=1 | wc -c
```

This will return to you the size in bytes of the block being read.

To change the block size, use the **chdev** command as follows:

```
# chdev -l rmt0 -a block_size=512
rmt0 changed
# tar tvf /dev/rmt0
-rw-rw-r--  0 0    1817 Jun 09 16:24:17 2000 /etc/hosts
```

9.6 Quiz

The following certification assessment questions help verify your understanding of the topics discussed in this chapter.

1. The system administrator is planning to upgrade the accounting application in `/home/acct`. Before the upgrade, the administrator would like to backup all of the data in this directory. What is the proper syntax of the **backup** command to perform this task?
 - A. **backup -cvf /dev/rmt0 /home/acct**
 - B. **backup -ivf /dev/rmt0 /home/acct**
 - C. **find /home/acct -print | backup -cvf /dev/rmt0**
 - D. **find /home/acct -print | backup -ivf /dev/rmt0**

2. The system administrator runs the **backup -ivf /dev/rmt0 /home** command to back up the /home file system. The command hangs. What is the most likely cause of this problem?
 - A. Corrupted /home file system.
 - B. Problem with the tape drive.
 - C. The root file system is 100 percent full.
 - D. Incorrect syntax usage of the **backup** command.

The following are additional questions created by the authors to further test your understanding of the topics.

1. Which of the following files contains the logical volume and file system information that **mksysb** saves during a system backup?
 - A. /fs.size
 - B. /image.data
 - C. /bosinst.data
 - D. /install.data
2. A system administrator would like to have the system eject a backup tape each night after the system backup is complete to ensure that it is not overwritten. Which of the following commands can be used to eject the tape?
 - A. **tctl**
 - B. **eject**
 - C. **rmdev**
 - D. **rmtape**
3. At the XYZ Company, the system administrator has implemented a daily backup schedule for the /home file system. The file system is stored on the 4 mm tape drive /dev/rmt1 using the **tar** command. What command can be used to verify the most recent tape has successfully stored the files in /home?
 - A. **tar -ivf /dev/rmt1**
 - B. **tar -tvf /dev/rmt1**
 - C. **tar -lvf /dev/rmt1.1**
 - D. **tar -ivf /dev/rmt1.1 /home**

4. At XYZ company, a nightly backup is performed to the tape drive using **mksysb** scheduled by **cron**. Where can the system administrator look to find the output of the **mksysb** command?
- A. /smit.log
 - B. /var/adm/messages
 - C. /var/spool/mail/root
 - D. /var/spool/cron/cronlog
5. The system administrator at ABC calls to ask for assistance while backing up of the rootvg with the **mksysb** command. The **mksysb** command fails with the following error message:
- ```
0511-084 internal packing error
```
- What should the system administrator do to resolve this error?
- A. Use the **-p** flag with **mksysb**.
  - B. Run **fsck** on the rootvg file system.
  - C. Disable compression on the tape drive.
  - D. Specify an alternate density setting on the tape drive.
6. The system administrator of company ABC has been asked to restore some files from an old backup of the /home file system. The restore is failing because the block size of the tape drive is incorrect. The system administrator does not know to what block size the backup was written. What command can be used to determine the block size of the tape?
- A. **tar**
  - B. **tctl**
  - C. **cpio**
  - D. **tcopy**
7. The intranet Web server for the ABC company experienced a disk drive failure and the system must be restored for the **mksysb** backup tape. With the backup tape in the tape drive, what is the first step the system administrator should use to initiate the **mksysb** restore?
- A. Boot the server in service mode.
  - B. Issue the **boot -mksysb** command.
  - C. Press the reset button when the C31 LED appears.
  - D. Hold down the reset button when powering on the server.

8. A technical specialist working on an RS/6000 Model 397 running AIX Version 4.3.1 determines that the system needs to be reinstalled with the same version of the operating system. What is the best method to perform the reinstallation without erasing /home and /data, a file system used to store project data?
- A. Reinstall bos.rte from the installation media.
  - B. Perform a preservation installation from a **mksysb**.
  - C. Perform a migration installation from the installation media.
  - D. Perform a preservation installation from the installation media.

### 9.6.1 Answers

The following answers are for the assessment quiz questions.

- 1. D
- 2. D

The following answers are for the additional quiz questions.

- 1. B
- 2. A
- 3. B
- 4. C
- 5. A
- 6. D
- 7. A
- 8. D

### 9.7 Exercises

The following exercises provide sample topics for self study. They will help ensure comprehension of this chapter.

- 1. Perform a back up of your system using **mksysb**. Make sure that you exclude the /tmp file system from your backup. In addition to this, you must back up all your user file systems in your rootvg.
- 2. Check out your smit.log for any errors during your backup operation.

3. With the **mksysb** tape you have just made, perform the following tasks:
  - Create a listing of the contents of the tape.
  - Verify that your backup contains all the files.
  - Find out the block size of the tape when you took your backup.
  - Using your **mksysb** tape, find out the date when it was saved.
  - Verify that you can boot off this **mksysb** tape.
  - Restore `/etc/hosts` and `/etc/filesystems` file from your **mksysb** tape.
4. Save your rootvg using the **savevg** command and use a separate tape for backup.
5. Try restoring your rootvg from your **mksysb** tape using the **restvg** command.
6. Create a raw logical volume and save your raw logical volume using the **dd** command.
7. Use **backup**, **restore**, and **tar** commands to back up your user file systems.



## System performance

This chapter discusses the several system performance monitoring tools used to capture the data required to identify the performance problems related to CPU, memory, and I/O subsystem. The filesets bos.acct and bos.perf.tools contain these tools.

## 10.1 Using the topas command

The **topas** command is a performance monitoring tool that was introduced in AIX Version 4.3.3. In AIX 5L Version 5.1, it has several new enhancements, including Workload Manager support, an improved set of CPU usage panels, several new column sort options, NFS statistics, and per disk or adapter breakdown of network and disk usage. Figure 10-1 provides a sample **topas** command screen.

|                                 |       |               |        |          |         |                 |              |
|---------------------------------|-------|---------------|--------|----------|---------|-----------------|--------------|
| Topas Monitor for host: server1 |       | EVENTS/QUEUES |        | FILE/TTY |         |                 |              |
| Fri Aug 31 11:52:48 2001        |       | Interval: 2   |        | Cswitch  | 35      | Readch          | 78           |
| Kernel                          | 0.1   |               |        | Syscall  | 76      | Writech         | 3252         |
| User                            | 0.0   |               |        | Reads    | 1       | Rawin           | 0            |
| Wait                            | 0.0   |               |        | Writes   | 3       | Ttyout          | 0            |
| Idle                            | 99.8  | #####         |        | Forks    | 0       | Igets           | 0            |
|                                 |       |               |        | Execs    | 0       | Namei           | 0            |
|                                 |       |               |        | Runqueue | 0.0     | Dirblk          | 0            |
| Network                         | KBPS  | I-Pack        | O-Pack | KB-In    | KB-Out  | Waitqueue       | 0.0          |
| tr0                             | 3.5   | 3.0           | 3.0    | 0.2      | 3.3     |                 |              |
| lo0                             | 0.0   | 0.0           | 0.0    | 0.0      | 0.0     |                 |              |
| Disk                            | Busy% | KBPS          | TPS    | KB-Read  | KB-Writ | PAGING          | MEMORY       |
| hdisk0                          | 0.0   | 0.0           | 0.0    | 0.0      | 0.0     | Faults          | 0            |
| hdisk1                          | 0.0   | 0.0           | 0.0    | 0.0      | 0.0     | Steals          | 0            |
|                                 |       |               |        |          |         | % Comp          | 24.5         |
|                                 |       |               |        |          |         | PgspIn          | 0            |
|                                 |       |               |        |          |         | % Noncomp       | 19.8         |
|                                 |       |               |        |          |         | PgspOut         | 0            |
|                                 |       |               |        |          |         | % Client        | 0.5          |
|                                 |       |               |        |          |         | PageIn          | 0            |
| Name                            | PID   | CPU%          | PgSp   | Owner    |         | PageOut         | 0            |
| topas                           | 13284 | 0.1           | 0.8    | root     |         | Sios            | 0            |
| xterm                           | 15076 | 0.0           | 0.9    | root     |         | % Used          | 1.2          |
| dtexec                          | 22776 | 0.0           | 0.7    | root     |         | % Free          | 98.7         |
| dtscree                         | 21362 | 0.0           | 0.6    | root     |         | NFS (calls/sec) |              |
| syncd                           | 5956  | 0.0           | 0.3    | root     |         | ServerV2        | 0            |
| X                               | 5454  | 0.0           | 3.1    | root     |         | ClientV2        | 0            |
| dtsses                          | 5198  | 0.0           | 2.7    | root     |         | ServerV3        | 0            |
|                                 |       |               |        |          |         | ClientV3        | 0            |
|                                 |       |               |        |          |         | Press:          | "h" for help |
|                                 |       |               |        |          |         |                 | "q" to quit  |

Figure 10-1 topas command output

The general syntax of the **topas** command is as follows:

```
topas [-d number_of_hot_disks] [-h] [-i monitoring_interval_in_seconds]
[-n number_of_hot_network_interfaces] [-p number_of_hot_processes]
```

Table 10-1 provides a list of the flags for **topas** and their descriptions.

Table 10-1 topas command flags

| Flag                | Description                                                                                                                                                                         |
|---------------------|-------------------------------------------------------------------------------------------------------------------------------------------------------------------------------------|
| -d NumberOfHotDisks | Specifies the maximum number of disks shown. If this argument is omitted, a default of 5 (five) is assumed. If a value of zero is specified, no disk information will be displayed. |
| -h                  | Displays help information.                                                                                                                                                          |

| Flag | Description                                                                                                                                                                                                                                                                                                                                                                                                |
|------|------------------------------------------------------------------------------------------------------------------------------------------------------------------------------------------------------------------------------------------------------------------------------------------------------------------------------------------------------------------------------------------------------------|
| -i   | Sets the monitoring interval in seconds. The default is two seconds.                                                                                                                                                                                                                                                                                                                                       |
| -n   | Specifies the maximum number of network interfaces shown. If this argument is omitted, a default of 2 is assumed. If a value of zero is specified, no network information will be displayed.                                                                                                                                                                                                               |
| -p   | Specifies the maximum number of processes shown. If this argument is omitted a default of 16 is assumed. If a value of zero is specified, no process information will be displayed. Retrieval of process information constitutes the majority of the <b>topas</b> overhead. If process information is not required, you should always use this option to specify that you do not want process information. |

For example, to view the top 10 processes in use while not displaying any network interface statistics, in five second intervals, run the command:

```
topas -i5 -n0 -p10
```

Within the **topas** command screen, there are a variety of subcommands that can change the output of what is being displayed. Table 10-2 has a list of subcommands you can use in the **topas** command screen.

*Table 10-2 topas command screen subcommands*

| Subcommand | Description                                                                                                                                      |
|------------|--------------------------------------------------------------------------------------------------------------------------------------------------|
| a          | Show all the variable subsections being monitored. Pressing the 'a' key always returns <b>topas</b> to the main initial display.                 |
| c          | Pressing the 'c' key repeatedly toggles the CPU subsection between the cumulative report, off, and a list of busiest CPUs.                       |
| d          | Pressing the 'd' key repeatedly toggles the disk subsection between busiest disks list, off, and total disk activity for the system.             |
| f          | Moving the cursor over a WLM class and pressing 'f' shows the list of top processes in the class on the bottom of the screen (WLM Display Only). |
| h          | Toggles between help screen and main display.                                                                                                    |
| n          | Pressing the 'n' key repeatedly toggles the network interfaces subsection between busiest interfaces list, off, and total network activity.      |

| Subcommand | Description                                                                               |
|------------|-------------------------------------------------------------------------------------------|
| p          | Pressing the 'p' key toggles the hot processes subsection on and off.                     |
| q          | Quits the program.                                                                        |
| r          | Refreshes the screen.                                                                     |
| w          | Pressing the 'w' key toggles the WorkLoad Management (WLM) classes subsection on and off. |
| W          | Toggle to the Full Screen WLM Class Display.                                              |

## 10.2 Using the vmstat command

The `vmstat` command reports statistics about processes, virtual memory, paging activity, faults, CPU activity, and disk transfers. A sample of the `vmstat` output report is shown in Figure 10-2.

```
vmstat hdisk0 hdisk1 4
kthr memory page faults cpu disk xfer

 r b avm fre re pi po fr sr cy in sy cs us sy id wa 1 2 3 4
0 1 37184 156 0 0 0 1 7 0 171 582 58 4 3 93 1 1 0
1 1 37184 156 0 0 0 0 0 0 555 5373 1600 12 15 73 0 0 0
2 1 37189 162 0 0 2 4 12 0 523 5477 1377 30 24 45 0 2 0
2 1 37189 162 0 0 0 0 0 0 508 5623 1312 39 28 34 0 0 0
0 1 37189 161 0 0 0 0 0 0 545 5382 1521 17 17 65 0 0 0
0 1 37189 161 0 0 0 0 0 0 553 5337 1575 16 14 70 0 0 0
0 1 37189 3053 0 0 0 0 0 0 553 5284 1566 16 16 68 0 0 0
0 1 37189 3049 0 0 0 0 0 0 568 5308 1511 15 15 64 6 7 0
0 1 37189 2890 0 18 0 0 0 0 578 5321 1587 15 16 47 22 28 0
0 2 37189 2549 0 41 0 0 0 0 641 5329 1620 18 19 0 63 71 0
1 2 37346 1925 0 25 0 0 0 0 621 21626 1559 19 25 5 51 67 0
0 1 37346 1925 0 0 0 0 0 0 551 5275 1567 14 14 72 0 0 0
0 1 37346 1630 0 0 0 0 0 0 565 5303 1513 17 21 61 1 10 0
4 1 37377 121 0 0 56 60 296 0 620 5324 1234 40 45 13 3 46 7
0 1 37377 125 0 0 16 186 4856 0 550 5219 1345 20 45 24 10 5 17
0 1 37346 160 0 0 0 116 927 0 571 5397 1454 21 30 45 4 12 7
0 1 37346 160 0 0 0 0 0 0 548 5281 1552 12 16 72 0 0 0
0 1 37346 160 0 0 0 0 0 0 548 5259 1545 14 14 72 0 0 0
^C# █
```

Figure 10-2 `vmstat` output example with disk activity

The following sections will discuss some of the frequently referenced fields for analysis from the preceding example of the `vmstat` report.



## 10.2.1 Paging activity statistics

When processes on the system require more pages of memory than are available in RAM, working pages may be paged out to paging space and then paged in when they are needed again. Accessing a page from paging space is considerably slower than accessing a page directly from RAM. For this reason, constant paging activity can cause system performance degradation. The paging activity is determined by the following four fields.

- pi** Number of pages per second paged in from paging space.
- po** Number of pages per second paged out to paging space.
- fr** Number of pages that must be freed to replenish the free list or to accommodate an active process.
- sr** Number of pages that must be examined in order to free fr number of pages.

### Data analysis

The following conclusions can be drawn from the various filed values:

- ▶ A consistent nonzero value of pi and po means high paging activity that can slow down the system. This can be due to a memory bottleneck.
- ▶ A high fr:sr ratio indicates that the memory is overcommitted. An fr:sr ratio of 1:4 means for every one page freed, four pages must be examined. It is difficult to determine a memory constraint based on this ratio alone and what constitutes a high ratio is workload/application dependent.

## 10.2.2 CPU statistics

The following fields of a **vmstat** report determine the status of CPU usage.:

- id** Percentage of time the CPU is idle (the run queue is empty).
- wa** Percentage of time the CPU is idle (with pending local disk I/O).
- r** Number of threads (smallest work unit) placed on the run queue per second.
- b** Number of threads (smallest work unit) placed on the wait queue per second (awaiting resource or completion of an I/O).
- us** Percentage of CPU time spent in user mode.
- sy** Percentage of CPU time spent in system mode.

## Data analysis

The values of various fields can lead you to the following conclusions:

- ▶ If the id value is consistently 0 percent, the CPU is being used 100 percent of the time.
- ▶ A key factor when evaluating CPU performance is the size of the run queue. As the run queue increases, the users will notice degradation (an increase) in response time.
- ▶ If us+sy time is below 90 percent, a single user system is not considered CPU constrained. However, if us+sy time on a multiuser system exceeds 80 percent, the processes may spend time waiting in the run queue and therefore the response time and throughput might suffer.
- ▶ A wa value of over 40 percent indicates that the disk subsystem is not balanced or the work load is disk-intensive.

### 10.2.3 Determining the I/O for persistent storage

The I/O for persistent storage is the I/O (disk reads and writes) initiated by VMM excluding paging space I/O. The following example shows how to calculate I/O for persistent storage using the `vmstat` command with the `-s` option:

```
vmstat -s
3983934 total address trans. faults
384406 page ins
218433 page outs
16928 paging space page ins
35468 paging space page outs
0 total reclaims
1738350 zero filled pages faults
19584 executable filled pages faults
2035457 pages examined by clock
132 revolutions of the clock hand
393739 pages freed by the clock
57211 backtracks
0 lock misses
161 free frame waits
0 extend XPT waits
197637 pending I/O waits
340980 start I/Os
340980 iodes
16706966 cpu context switches
46963483 device interrupts
0 software interrupts
0 traps
161793600 syscalls
```

There are 23 separate events reported by the `vmstat -s` output, but the following four are used to calculate the persistent storage I/O.

**page ins** This field is the count of systemwide pages read from disk (including pages read from paging space). When a page is read from disk to memory, this count is incremented. It is a count of VMM-initiated read operations and, with the page outs field, represents the real I/O (disk reads and writes) initiated by the VMM.

**page outs** This field is the count of system-wide pages written on to the disk (including pages written to the paging space). The process of writing pages to the disk is count incremented. The page outs field value is a total count of VMM-initiated write operations and, with the page ins field, represents the total amount of real I/O initiated by the VMM.

**paging space page ins** This field is the count of pages read from paging space.

**paging space page outs** This field is the count of pages written to paging space.

If the value for paging space page ins is subtracted from the (system-wide) value for page ins, the result is the number of persistent pages (files) that were read from disk. Similarly, if the value for paging space page outs is subtracted from the (system-wide) value for page outs, the result is the number of persistent pages (files) that were written to disk.

The preceding example shows that 367478 (384406-16928) number of pages are read from disk and 182965 (218433-35468) number of pages are written to the disk.

These counts apply to the time since system initialization. If you need counts for a given time interval, execute `vmstat -s` at the time you want to start monitoring and again at the end of the interval. The deltas between like fields of successive reports will be the count for the interval.

## 10.3 Using the iostat command

The `iostat` command tool reports the following three types of statistics:

- ▶ Terminal statistics
- ▶ CPU statistics
- ▶ Disk statistics

This section discusses the use of the **iostat** command to identify I/O-subsystem and CPU bottlenecks using CPU statistics and disk statistics. The following is a sample **iostat** output report:

```
iostat

tty: tin tout avg-cpu: % user % sys % idle % iowait
 0.1 9.0 7.7 6.8 85.0 0.5

Disks: % tm_act Kbps tps Kb_read Kb_wrtn
hdisk1 0.1 0.7 0.0 39191 242113
hdisk0 0.8 11.1 0.8 3926601 822579
cd0 0.0 0.0 0.0 780 0
```

The following sections will discuss some of the frequently referenced fields from the preceding example.

### 10.3.1 CPU statistics

The following fields of CPU statistics in the **iostat** report determine the CPU usage and the I/O status.

- % user** The % user column shows the percentage of CPU resource spent in user mode. A UNIX process can execute in user or system mode. When in user mode, a process executes within its own code and does not require kernel resources.
- % sys** The % sys column shows the percentage of CPU resource spent in system mode. This includes CPU resource consumed by kernel processes and others that need access to kernel resources. For example, the reading or writing of a file requires kernel resources to open the file, seek a specific location, and read or write data. A UNIX process accesses kernel resources by issuing system calls.
- % idle** The % idle column shows the percentage of CPU time spent idle, or waiting, without pending local disk I/O. If there are no processes on the run queue, the system dispatches a special kernel process called wait. On most AIX systems, the wait process ID (PID) is 516.
- % iowait** The % iowait column shows the percentage of time the CPU was idle with pending local disk I/O. The iowait state is different from the idle state in that at least one process is waiting for local disk I/O requests to complete. Unless the process is using asynchronous I/O, an I/O request to disk causes the calling process to block (or sleep) until the request is completed. Once a process's I/O request completes, it is placed on the run queue.

## Data analysis

The following conclusions can be drawn from the **iostat** reports:

- ▶ A system is CPU-bound if the sum of user and system time exceeds 90 percent of CPU resource on a single-user system or 80 percent on a multiuser system. This condition means that the CPU is the limiting factor in system performance.
- ▶ A high iowait percentage indicates the system has a memory shortage or an inefficient I/O subsystem configuration. Understanding the I/O bottleneck and improving the efficiency of the I/O subsystem requires more data than **iostat** command output can provide. However, typical solutions might include:
  - Limiting the number of active logical volumes and file systems placed on a particular physical disk (the idea is to balance file I/O evenly across all physical disk drives).
  - Spreading a logical volume across multiple physical disks (this is useful when a number of different files are being accessed).
  - Creating multiple JFS logs for a volume group and assigning them to specific file systems (this is beneficial for applications that create, delete, or modify a large number of files, particularly temporary files).
  - Backing up and restoring file systems to reduce fragmentation. (Fragmentation causes the drive to seek excessively and can be a large portion of overall response time.)
  - Adding additional drives and rebalancing the existing I/O subsystem.
- ▶ On systems running a primary application, high I/O wait percentage may be related to workload. In this case, there may be no way to overcome the problem.
- ▶ On systems with many processes, some will be running while others wait for I/O. In this case, the iowait can be small or zero because running processes *hide* wait time. Although iowait is low, a bottleneck may still limit application performance.

To understand the I/O subsystem thoroughly, you need to examine the disk statistics of **iostat** report in the following section.

### 10.3.2 Disk statistics

The disk statistics portion of the **iostat** output determines the I/O usage. This information is useful in determining whether a physical disk is the bottleneck for performance. The system maintains a history of disk activity by default. The history is disabled if you see the following message:

```
Disk history since boot not available.
```

Disk I/O history should be enabled because the CPU resource used in maintaining it is insignificant. History-keeping can be disabled or enabled by executing **smitty chgsys**, which will display the screen shown in Figure 10-3. Change the option Continuously maintain DISK I/O history to TRUE to enable the history keeping option.

```

Change / Show Characteristics of Operating System

Type or select values in entry fields.
Press Enter AFTER making all desired changes.

 [Entry Fields]
Maximum number of PROCESSES allowed per user [40] + #
Maximum number of pages in block I/O BUFFER CACHE [20] + #
Maximum Kbytes of real memory allowed for MBUFFS [0] + #
Automatically REBOOT system after a crash false +
Continuously maintain DISK I/O history true +
HIGH water mark for pending write I/Os per file [0] + #
LOW water mark for pending write I/Os per file [0] + #
Amount of usable physical memory in Kbytes 65536
State of system keylock at boot time normal
Enable full CORE dump false +
Use pre-430 style CORE dump false +

F1=Help F2=Refresh F3=Cancel F4=List
F5=Reset F6=Command F7=Edit F8=Image
F9=Shell F10=Exit Enter=Do

```

Figure 10-3 Enabling the disk I/O history

You can also use the **chdev** command as follows:

```
chdev -l sys0 -a iostat=true
```

The following fields of the **iostat** report determine the physical disk I/O:

- Disks** The Disks column shows the names of the physical volumes. They are either hdisk or cd followed by a number. (hdisk0 and cd0 refer to the first physical disk drive and the first CD-ROM disk drive, respectively.)
- % tm\_act** The % tm\_act column shows the percentage of time the volume was active. This is the primary indicator of a bottleneck.
- Kbps** Kbps shows the amount of data read from and written to the drive in KBs per second. This is the sum of Kb\_read plus Kb\_wrtn, divided by the number of seconds in the reporting interval.
- tps** tps reports the number of transfers per second. A transfer is an I/O request at the device-driver level.

**Kb\_read** Kb\_read reports the total data (in KB) read from the physical volume during the measured interval.

**Kb\_wrtn** Kb\_wrtn shows the amount of data (in KB) written to the physical volume during the measured interval.

## Data analysis

There is no unacceptable value for any of the fields in the preceding section, because statistics are too closely related to application characteristics, system configuration, and types of physical disk drives and adapters. Therefore, when evaluating data, you must look for patterns and relationships. The most common relationship is between disk utilization and data transfer rate.

To draw any valid conclusions from this data, you must understand the application's disk data access patterns (sequential, random, or a combination) and the type of physical disk drives and adapters on the system. For example, if an application reads and writes sequentially, you should expect a high disk-transfer rate when you have a high disk-busy rate. (Note: Kb\_read and Kb\_wrtn can confirm an understanding of an application's read and write behavior, but they provide no information on the data access patterns).

Generally, you do not need to be concerned about a high disk-busy rate as long as the disk-transfer rate is also high. However, if you get a high disk-busy rate and a low data-transfer rate, you may have a fragmented logical volume, file system, or individual file.

What is a high data-transfer rate? That depends on the disk drive and the effective data-transfer rate for that drive. You should expect numbers between the effective sequential and effective random disk-transfer rates.

You can also use the data captured by the **iostat** command to analyze the requirement of an additional SCSI adapter (if the one installed in your system is the I/O bottleneck) by tracking transfer rates, and finding the maximum data transfer rate for each disk.

The disk usage percentage (% tm\_act) is directly proportional to resource contention and inversely proportional to performance. As disk use increases, performance decreases and response time increases. In general, when a disk's use exceeds 70 percent, processes are waiting longer than necessary for I/O to complete because most UNIX processes block (or sleep) while waiting for their I/O requests to complete.

To overcome I/O bottlenecks, you can perform the following actions:

- ▶ Look for busy versus idle drives. Moving data from more busy to less busy drives may help alleviate a disk bottleneck.

- ▶ Check for paging activity because paging to and from disk will also contribute to the I/O load. Move paging space from a more busy drive to a less busy drive to improve the performance.

## 10.4 Using the vmtune command

The **vmtune** command changes operational parameters of the Virtual Memory Manager (VMM) and other AIX components. The command and source for **vmtune** are found in the `/usr/samples/kernel` directory. It is installed with the `bos.adt.samples` fileset.

The **vmtune** command can only be executed by root. Changes made by the **vmtune** command persist until the next reboot of the system. If a permanent change in VMM parameters is needed, an appropriate **vmtune** command should be put in a script run by the `init` process at boot.

The **vmtune** command syntax is as follows:

```
vmtune [-b numfsbuf] [-B numpbuf] [-c numclust] [-f minfree]
[-F maxfree] [-k npskill] [-l lrubucket] [-M maxpin] [-N pd_npages]
[-p minperm] [-P maxperm] [-r minpgahead] [-R maxpgahead]
[-u lvm_budcft] [-w npswarn] [-W maxrandwrt]
```

The flags and their descriptions for the **vmtune** command are shown in Table 10-3.

Table 10-3 vmtune command flags and flag descriptions

| Flag                     | Flag description                                                                                                                                                                                                                                                   |
|--------------------------|--------------------------------------------------------------------------------------------------------------------------------------------------------------------------------------------------------------------------------------------------------------------|
| <code>-b numfsbuf</code> | Specifies the number of file system bufstructs. The default value is 64.                                                                                                                                                                                           |
| <code>-B numpbuf</code>  | Specifies the number of pbufs used by the LVM. The maximum value is 128. In AIX Version 3, the number of pbufs may need to be increased in systems doing many large, sequential I/O operations.                                                                    |
| <code>-c numclust</code> | Specifies the number of 16 KB clusters processed by write behind. The default value is 1.                                                                                                                                                                          |
| <code>-f minfree</code>  | Specifies the minimum number of frames on the free list. This number can range from 8 to 204800.                                                                                                                                                                   |
| <code>-F maxfree</code>  | Specifies the number of frames on the free list at which page stealing is to stop. This number can range from 16 to 204800, but must be greater than the number specified by the <code>minfree</code> parameter by at least the value of <code>maxpgahead</code> . |



| Flag                 | Flag description                                                                                                                                                                                                                                                                                                                                                                                                                                                                 |
|----------------------|----------------------------------------------------------------------------------------------------------------------------------------------------------------------------------------------------------------------------------------------------------------------------------------------------------------------------------------------------------------------------------------------------------------------------------------------------------------------------------|
| -k <i>npskill</i>    | Specifies the number of free paging-space pages at which AIX begins killing processes. The default value is 128.                                                                                                                                                                                                                                                                                                                                                                 |
| -l <i>lrubucket</i>  | Specifies the size (in 4 KB pages) of the least-recently used (LRU) page-replacement bucket size. This is the number of page frames which will be examined at one time for possible pageouts when a free frame is needed. A lower number will result in lower latency when looking for a free frame, but will also result in behavior that is not similar to a true lru algorithm. The default value is 512 MB and the minimum is 256 MB. Tuning this option is not recommended. |
| -M <i>maxpin</i>     | Specifies the maximum percentage of real memory that can be pinned. The default value is 80. If this value is changed, the new value should ensure that at least 4 MB of real memory will be left unpinned for use by the kernel.                                                                                                                                                                                                                                                |
| -N <i>pd_npages</i>  | Specifies the number of pages that should be deleted in one chunk from RAM when a file is deleted. The default value is the largest possible file size divided by the page size (currently 4096). If the largest possible file size is 2 GB, then <i>pd_npages</i> is 524288 by default. Tuning this option is really only useful for real-time applications.                                                                                                                    |
| -p <i>minperm</i>    | Specifies the point below which file pages are protected from the repage algorithm. This value is a percentage of the total real-memory page frames in the system. The specified value must be greater than or equal to five.                                                                                                                                                                                                                                                    |
| -P <i>maxperm</i>    | Specifies the point above which the page stealing algorithm steals only file pages. This value is expressed as a percentage of the total real-memory page frames in the system. The specified value must be greater than or equal to five.                                                                                                                                                                                                                                       |
| -r <i>minpgahead</i> | Specifies the number of pages with which sequential read-ahead starts. This value can range from 0 through 4096. It should be a power of two.                                                                                                                                                                                                                                                                                                                                    |
| -R <i>maxpgahead</i> | Specifies the maximum number of pages to be read ahead. This value can range from 0 through 4096. It should be a power of two and should be greater than or equal to <i>minpgahead</i> .                                                                                                                                                                                                                                                                                         |
| -u <i>lvm_bufcnt</i> | Specifies the number of LVM buffers for raw physical I/Os. The default value is nine. The possible values can range between 1 and 64. This option is only available in AIX Version 4.                                                                                                                                                                                                                                                                                            |
| -w <i>npswarn</i>    | Specifies the number of free paging-space pages at which AIX begins sending the SIGDANGER signal to processes. The default value is 512.                                                                                                                                                                                                                                                                                                                                         |

| Flag                 | Flag description                                                                                                                                                                                |
|----------------------|-------------------------------------------------------------------------------------------------------------------------------------------------------------------------------------------------|
| -W <i>maxrandwrt</i> | Specifies a threshold (in 4 KB pages) for random writes to accumulate in RAM before these pages are synchronized to disk using a write-behind algorithm. This threshold is on a per file basis. |

An example of the use of the **vm tune** command is located in Section 10.6.2, “Tuning a system for sequential I/O” on page 246.

## 10.5 Controlling resource usage

The following sections describe various methods to limit the consumption of system resources.

### 10.5.1 Using the nice and renice commands

The **nice** and **renice** commands are used to change the priority of a process. The **nice** command runs another command at a different priority, while the **renice** command changes the priority of an already running process. The root user can increase or decrease the priority of any process. Other users can only decrease the priority of processes they own.

The following example shows the **nice** command running the **cc** command at a lower priority:

```
nice -n 15 cc -c *.c
```

The following example shows the **renice** command lowering the priority of process ID 16304 by 5:

```
renice -n -5 16304
```

### 10.5.2 Workload Manager

The Workload Manager (WLM) allows the system administrator to divide resources between jobs. WLM provides isolation between user communities with very different system behaviors. This can prevent effective starvation of workloads with certain characteristics, such as interactive or low CPU usage jobs, by workloads with other characteristics, such as batch or high memory usage jobs. CPU time, memory, and I/O bandwidth are managed separately. Therefore, different styles of applications can be managed.

AIX WLM delivers the basic ability to give system administrators more control over how scheduler, Virtual Memory Manager (VMM), and device driver calls allocate CPU, physical memory, and I/O bandwidth to a class-based user, group, application path, process type, or application tag.

The AIX WLM is an operating system feature introduced in AIX Version 4.3.3.

## 10.6 Logical volume performance

There are many factors that can affect the LVM, and therefore I/O performance. A few of these will be addressed here.

### 10.6.1 Logical volume fragmentation

Logical volume performance can degrade if logical partitions are not contiguous on physical volumes, due to the disk head having to skip along the disk surface. To check a logical volume for possible fragmentation, use the `-m` flag of the `lslv` command. The `-m` flag lists the following fields for each logical partition:

- LP** Logical partition number.
- PP1** First physical partition number allocated to the logical partition.
- PV1** Physical volume name where the logical partition's first physical partition is located.
- PP2** Second physical partition number allocated to the logical partition.
- PV2** Physical volume name where the logical partition's second physical partition (first copy) is located.
- PP3** Third physical partition number allocated to the logical partition.
- PV3** Physical volume name where the logical partition's third physical partition (second copy) is located.

The following example shows the use of the `lslv -m` command:

```
lslv -m hd10opt
hd10opt:/opt
LP PP1 PV1 PP2 PV2 PP3 PV3
0001 0228 hdisk0
0002 0257 hdisk0
```

Notice that LP1 is located in PP 228 of hdisk0 and LP2 is in PP 257 of hdisk0, which is 29 PPs away. Logical volume hd10opt is fragmented.

The LVM command **reorgvg** can reorganize logical volumes so that they comply with the intra-disk policies. By using **reorgvg** and providing both the volume group and the name of the logical volume, the highest priority is given to the listed volume group when performing the reorganization. During the reorganization, the volume group is locked and cannot be used.

The following example shows the use of the **reorgvg** command:

```
reorgvg rootvg hd10opt
0516-962 reorgvg: Logical volume hd10opt migrated.
lslv -m hd10opt
hd10opt:/opt
LP PP1 PV1 PP2 PV2 PP3 PV3
0001 0276 hdisk0
0002 0277 hdisk0
```

Notice that the two LPs are now contiguous on hdisk0, in PPs 276 and 277.

## 10.6.2 Tuning a system for sequential I/O

Two techniques to tune the I/O performance of workloads where the goal is high-performance reading and writing of large sequential files are striping, and VMM tuning.

Striping is a technique for spreading the data in a logical volume across several disk drives in such a way that the I/O capacity of the disk drives can be used in parallel to access data on the logical volume. A logical volume is configured to use striping by using either the **smitty ch1v1** fast path or the **chlv -e** command to increase the Range setting.

In an ordinary logical volume, the data addresses correspond to the sequence of blocks in the underlying physical partitions. In a striped logical volume, the data addresses follow the sequence of stripe units. A complete stripe consists of one stripe unit on each of the physical devices that contains part of the striped logical volume. The LVM determines which physical blocks on which physical drives correspond to a block being read or written. If more than one drive is involved, the necessary I/O operations are scheduled for all drives simultaneously.

The second technique is to tune the VMM in favour of sequential I/O using the **vmtune** command. The recommended values for this tuning are:

```
minpgahead 2
maxpgahead 16 x number of disk drives
I/O requests Equal to maxpgahead
```

The maxfree and minfree settings should be done after doing some investigation using the **vmstat** command and then setting the system according to your system requirements. For a better understanding of tuning your AIX system, consult the *AIX Performance Tuning Guides*, which can be found in the AIX product documentation and at the following Web site:

<http://www.ibm.com/servers/aix/library>

For this example, use a value of 128:

```
minfree 128
maxfree minfree + maxpgahead
```

For this section, assume the following devices exist:

```
lspv
hdisk0 000919746edab91f rootvg
hdisk1 0009197459d92f2e uservg
hdisk2 00091974d381d097 uservg
```

Your system has three disk drives; using the recommended values described for logical volume striping, your values would be:

```
minpgahead 2
maxpgahead 48 (3x16)
minfree 128
maxfree 176 (48 + 128)
```

To set the system up with these parameters, enter:

```
/usr/samples/kernel/vmtune -f 128 -F 144 -r 2 -R 176
```

To make these changes permanent, enter the above line into `/etc/inittab`.

## 10.7 Paging space management

Paging space requirements are unique for each system, depending upon the kind of applications running and/or the number of active users.

### 10.7.1 Low paging space

If any of the following messages appear on the console or in response to a command on any terminal, it indicates a low paging space:

```
"INIT: Paging space is low"
"ksh: cannot fork no swap space"
"Not enough memory"
"Fork function failed"
```

```
"fork () system call failed"
"Unable to fork, too many processes"
"Fork failure - not enough memory available"
"Fork function not allowed. Not enough memory available."
"Cannot fork: Not enough space"
```

## 10.7.2 Paging space tips

The following tips, in general, will help in creating or increasing the paging space:

- ▶ Do not allocate more than one paging space logical volume on a physical volume. All processes started during the boot process are allocated paging space on the default paging space logical volume (hd6). After the additional paging space logical volumes are activated, paging space is allocated in a round robin manner in 4 KB blocks. If you have paging space on multiple physical volumes and have more than one paging space on one physical volume, you are no longer spreading paging activity over multiple physical volumes.
- ▶ Avoid putting a paging space logical volume on a heavily active logical volume, for example, a volume that is being used by a database. It is not necessary to put a paging space logical volume on each physical volume.
- ▶ Make each paging space logical volume roughly equal in size. If you have paging spaces of different sizes, and the smaller ones become full, you will no longer be spreading your paging activity across all of the physical volumes.
- ▶ Do not extend a paging space logical volume onto multiple physical volumes. If a paging space logical volume is spread over multiple physical volumes, you will not be spreading paging activity across all the physical volumes. If you want to allocate space for paging on a physical volume that does not already have a paging space logical volume, create a new paging space logical volume on that physical volume.
- ▶ For the best performance on a system having multiple disk controllers, allocate paging space logical volumes on physical volumes that are each attached to a different disk controller.
- ▶ The default paging space may be altered while in maintenance mode.

## 10.7.3 Managing default paging space (hd6)

The AIX installation defaults to a paging logical volume (hd6) on drive hdisk0, that contains part or all of the busy / (root) and /usr file systems.

A special procedure is required for removing the default paging space (hd6). These paging spaces are activated during boot time by shell scripts that configure the system. To remove one of the default paging spaces, these scripts must be altered and a new boot image must be created.

## Reducing the size of hd6 paging space

The following example shows the steps involved in reducing the size of hd6 paging space from 160 MB to 120 MB. The steps in the following procedures are all necessary, even those not directly related to the hd6 paging space. The additional steps are needed because a paging space cannot be deactivated while the system is running

### Note:

- ▶ AIX Version 4.2.1 and later does not support reducing the size of hd6 below 32 MB or the system will not boot.
- ▶ If you decide to reduce hd6, you must leave enough space for the software in rootvg. A rule of thumb for reducing hd6 paging space on systems prior to AIX 4.3.2 is to leave enough space to match physical memory. To find out the amount of physical memory, use the following command:

```
lsattr -E -l sys0 -a realmem
```

1. Create a temporary paging space on rootvg by executing the following command:

```
mkps -a -n -s 30 rootvg hdisk0
```

This command outputs the name of the paging space (paging00 if no others exist).

2. Use the following command to deactivate the hd6 paging spaces in preparation for the reboot later in the procedure:

```
chps -a n hd6
```

3. Change the paging space entry in the /sbin/rc.boot file from:

```
swapon /dev/hd6
```

to

```
swapon /dev/paging00.
```

4. Run the following command to check the primary dump device designation:

```
sysdumpdev -l
primary /dev/hd6
secondary /dev/sysdumpnull
copy directory /var/adm/ras
forced copy flag TRUE
always allow dump FALSE
```

5. If the primary dump device is hd6, change it to some other paging space. The following command shows how to change the primary dump device to paging00:

```
sysdumpdev -P -p /dev/paging00
primary /dev/paging00
secondary /dev/sysdumpnull
copy directory /var/adm/ras
forced copy flag TRUE
always allow dump FALSE
```

6. Create a bootable image with the **bosboot** command for a hard disk image:

```
bosboot -d /dev/hdisk0 -a
```

7. Put the system key (if present) in the normal position and use the following command, which will both shutdown the operating system and reboot it:

```
shutdown -r
```

8. After the system reboots, remove the hd6 paging space:

```
rmps hd6
```

9. Create a new paging space logical volume of the size 120 MB for the hd6 paging space:

```
mklv -t paging -y hd6 rootvg 30
```

10. Use the **lspv -a** command to verify the reduced size of default paging space (hd6).

11. Change the primary dump device designation back to be the paging space hd6:

```
sysdumpdev -P -p /dev/hd6
```

12. Change the paging space entry in the `/sbin/rc.boot` file from

```
swapon /dev/paging00
```

to

```
swapon /dev/hd6.
```

13. Create a bootable image with the **bosboot** command for a hard disk image:

```
bosboot -d /dev/hdisk0 -a
```



14. Execute the following command to make the new hd6 paging space automatically activated when the system reboots:

```
chps -a y hd6
```

15. Execute the following command to change the attribute of temporary paging space, paging00, so that it does not automatically activate after next reboot:

```
chps -a n paging00
```

16. Put the system key (if present) in the normal position and use the following command, to shutdown and reboot the system:

```
shutdown -r
```

17. After the system reboots, remove the temporary paging space:

```
rmpps paging00
```

### ***Reducing hd6 in AIX 5L Version 5.1***

You can use the **chps -d** command to dynamically reduce the size of the primary paging space hd6. If you decrease the primary paging space, a temporary boot image and a temporary /sbin/rc.boot pointing to a temporary primary paging space will be created to make sure the system is always in a state where it can be safely rebooted.

**Note:** The **chps -d** command will prevent you from decreasing the size of hd6 below 32 MB or actually deleting it.

### **Moving the hd6 paging space to another volume group**

Moving a paging space with the name hd6 from rootvg to another volume group is not recommended, because the name is hard-coded in several places.

Only the paging spaces in rootvg will be active during the second phase of the boot process, and having no paging space in rootvg could severely affect system boot performance. If you want the majority of paging space on other volume groups, it is better to make hd6 as small as possible (the same size as physical memory) and then create larger paging spaces on other volume groups.

### **Moving the hd6 paging space within the same VG**

Moving the default paging space from hdisk0 to a different disk within the same volume group does not require system reboot.

The following example shows the command used to move the default (hd6) paging space from hdisk0 to hdisk1:

```
migratepv -l hd6 hdisk0 hdisk1
```

This may take a few minutes, depending upon the size of paging space.

## 10.7.4 Dynamically deactivating paging space

AIX 5L Version 5.1 introduces the **swapoff** command, which deactivates paging spaces without requiring a reboot.

The **swapoff** command syntax is as follows:

```
swapoff DeviceName { DeviceName ... }
```

Use the command **swapoff /dev/paging03** to deactivate paging space paging03, or use the SMIT fast path **smitty swapoff**, as shown in Figure 10-4.

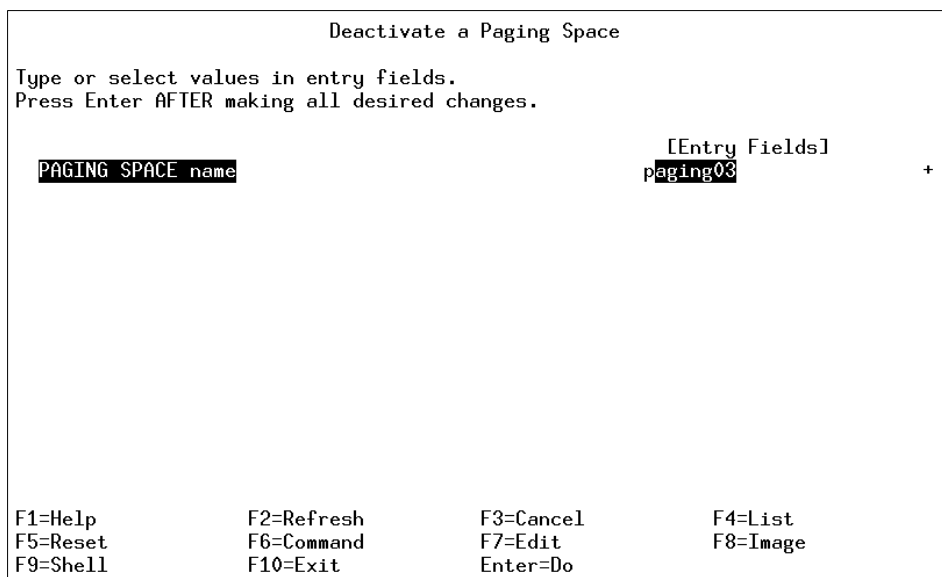

The screenshot shows a terminal window titled "Deactivate a Paging Space". The instructions read: "Type or select values in entry fields. Press Enter AFTER making all desired changes." Below the instructions, there is a field labeled "PAGING SPACE name" with the value "paging03" entered. To the right of this field is a label "[Entry Fields]" and a plus sign "+". At the bottom of the window, there is a list of function key shortcuts: F1=Help, F2=Refresh, F3=Cancel, F4=List, F5=Reset, F6=Command, F7=Edit, F8=Image, F9=Shell, F10=Exit, and Enter=Do.

Figure 10-4 smitty swapoff command

**Note:** It is necessary to move all pages in use on the paging space being deactivated to other paging spaces, so there must be enough space available in the other active paging spaces.

## 10.8 Quiz

The following certification assessment questions help verify your understanding of the topics discussed in this chapter.

1. A system administrator responding to user response time complaints has narrowed down the problem to poor I/O response time. What command should the administrator issue to determine if a particular logical volume is fragmented?
  - A. `defragfs -q file system name`
  - B. `lslv -m logical volume name`
  - C. `lsvg -l volume group name`
  - D. `fileplace -p file name`
2. A system administrator is notified by users of a system that the response time on the server is unacceptable and that they suspect the network is a bottleneck. What command can the administrator run to view the number of packets and the number of bytes being transmitted and received on the en0 interface?
  - A. `topas -i 10`
  - B. `netstat -in`
  - C. `vmstat -s 10`
  - D. `netstat -I en0 10`
3. A system performs large batch-type jobs with mostly sequential I/O. The system memory is not fully committed. What `vmtune` settings should be changed to increase sequential read throughput?
  - A. `maxperm` and `minperm`
  - B. `maxpin` and `numfsbufs`
  - C. `maxpgahead` and `minfree`
  - D. `maxrandwrt` and `minpgahead`

The following are additional questions created by the authors to further test your understanding of the topics.

1. A client needs more disk space for another volume group and has decided to use hdisk12 from the uservg volume group. The client realizes that paging space, paging12, must first be removed from hdisk12. Which of the following is the correct sequence of events?
  - A. **chps -an paging12, reboot, rmpps paging12**
  - B. **swapoff paging12, rmpps paging12**
  - C. **swapoff paging12, reboot, rmpps paging12**
  - D. **chps -an paging12, swapoff paging12, rmpps paging12**
  
2. A customer would like to remove an unneeded, but active, paging space called paging00. What is proper sequence of steps to accomplish this?
  - A. Remove the paging space with the **rmpps** command and reboot the system.
  - B. Disable the paging space with the **chps** command, reboot the system and remove the paging00 logical volume with the **rmpps** command.
  - C. Disable the paging space with the **chps** command, remove the paging00 logical volume with the **rmpps** command, and reboot the system.
  - D. Disable the paging space with the **chps** command, reboot the system and remove the paging00 logical volume with the **rm1v** command.
  
3. Company ABC has sent a technical specialist to a customer site in response to a complaint about slow system performance. The technical specialist verified unusually slow performance on the customer's system, and is attempting to find the source of the problem using the **vmstat** command. Given the output of the **vmstat** command below, what is the most likely cause of the performance problem?

```

kthr memory page faults cpu
----- -
r b avm fre re pi po fr sr cy in sy cs us sy id wa
0 0 5311 48642 0 0 0 0 0 0 102 4 11 0 0 99 0
0 1 52197 1756 0 0 0 0 0 0 206 157 26 28 12 0 60
0 1 51192 2751 0 0 0 0 0 0 204 24 22 22 12 0 66

```

- A. High user process activity
- B. Excessive system paging
- C. Poor disk drive I/O response time
- D. Excessive system CPU interrupts

4. A system administrator runs the **vmstat** command due to system performance problems. The output of **vmstat** is shown below. What can be concluded from this output?

```

kthr memory page faults cpu
----- -
 r b avm fre re pi po fr sr cy in sy cs us sy id wa
2 0 9200 11027 0 0 0 0 0 0 103 52 14 44 46 9 0
2 1 9200 11027 0 0 0 0 0 0 207 251 29 45 45 9 0
3 1 9200 11027 0 0 0 0 0 0 207 120 29 46 47 7 0
5 1 9200 11027 0 0 0 0 0 0 206 120 29 43 55 2 0
4 1 9200 11027 0 0 0 0 0 0 207 131 32 49 48 3 0

```

- A. The CPU is not sufficient for the load.  
 B. The machine needs a memory upgrade.  
 C. The machine needs a FDDI card installed.  
 D. A user program is causing unnecessary paging.
5. A system administrator is experiencing performance problems and runs the **vmstat** command. The output of **vmstat** is shown below. What can be concluded from this output?

```

kthr memory page faults cpu
----- -
 r b avm fre re pi po fr sr cy in sy cs us sy id wa
2 0 9200 11027 0 0 0 0 0 0 103 52 14 14 16 0 69
2 1 9200 11027 0 0 0 0 0 0 207 251 29 12 11 0 67
3 1 9200 11027 0 0 0 0 0 0 207 120 29 9 11 0 80
5 1 9200 11027 0 0 0 0 0 0 206 120 29 13 5 0 79
4 1 9200 11027 0 0 0 0 0 0 207 131 32 9 8 0 72

```

- A. The machine is I/O bound.  
 B. The machine needs its memory optimized.  
 C. The machine needs a FDDI card installed.  
 D. A user program is causing unnecessary paging.
6. The system administrator for Company XYZ is monitoring a system that has recently shown a decrease in performance. What is the best tool to identify where a performance bottleneck may exist?
- A. **lsps**  
 B. **errpt**  
 C. **svmon**  
 D. **vmstat**

7. A system has a 128-port controller with 130 TTYs configured total for the system and the terminal input and output is slowing down. The console is exhibiting the same behavior. Systems support runs the **netstat**, **vmstat**, and **ps aux** commands. Based on the outputs of these commands, what needs to be done to remedy the problem?

```
vmstat
```

```

kthr memory page faults cpu
----- -
 r b avm fre re pi po fr sr cy in sy cs us sy id wa
0 0 9778 1262 0 0 0 0 0 0 161 72 32 10 15 75 0
0 0 9778 1261 0 0 0 0 0 0 171 161 38 11 20 69 0
0 0 9778 1261 0 0 0 0 0 0 162 119 32 11 20 69 0
0 0 9778 1261 0 0 0 0 0 0 163 119 32 12 20 68 0
0 0 9778 1261 0 0 0 0 0 0 164 120 33 11 20 69 0

```

```
netstat
```

```

16 mbufs in use:
0 mbuf cluster pages in use
4 Kbytes allocated to mbufs
110 requests for mbufs denied
0 calls to protocol drain routines
0 sockets not created because sockthresh was reached

```

```
ps aux
```

```

USER PID %CPU %MEM SZ RSS TTY STAT STIME TIME COMMAND
root 516 99.1 0.0 4 8 - A Jul 27 2851:18 kproc
root 14474 1.1 1.0 980 1180 - A 08:01:48 1:09
/usr/dt/bin/dtterm
root 1032 0.2 0.0 316 232 - A Jul 27 6:51 kproc
root 2258 0.2 1.0 964 1148 - A 08:01:13 0:14
/usr/dt/bin/dtterm
user1 2364 0.1 5.0 5468 4768 - A Jul 27 2:02
/usr/lpp/X11/bin/
root 5676 0.0 0.0 116 184 - A Jul 27 1:11 ./sapid
root 4154 0.0 0.0 84 96 - A Jul 27 0:53
/usr/sbin/syncd 6
root 0 0.0 0.0 8 12 - A Jul 27 0:31 swapper
root 4044 0.0 2.0 1808 2008 - A 08:00:43 0:01 dtwm
root 1 0.0 0.0 384 436 - A Jul 27 0:07 /etc/init
root 7740 0.0 1.0 980 1132 - A Jul 27 0:04
/usr/sbin/snmpd
root 774 0.0 0.0 12 16 - A Jul 27 0:03 kproc
user2 3376 0.0 0.0 432 428 - A Jul 27 0:02
/usr/dt/bin/dtlog

```

```

user2 8796 0.0 0.0 232 312 - A Jul 27 0:01
/usr/sbin/cron
root 7998 0.0 0.0 272 260 - A Jul 27 0:01
/usr/sbin/tftpd -
root 5196 0.0 1.0 456 532 - A Jul 27 0:01
/usr/bin/cnsviiew
imnadm 12132 0.0 2.0 1756 1808 - A Jul 27 0:00
/usr/IMNSearch/ht

```

- A. Add another paging space.
  - B. Increase the value of thewall.
  - C. Increase the size of paging space.
  - D. Run `ki11 -9` on the PID of the kproc process.
8. A customer is experiencing performance problems and runs the `vmstat` command. The output of `vmstat` is shown below. What can be concluded from this output?

```

kthr memory page faults cpu

r b avm fre re pi po fr sr cy in sy cs us sy id wa
1 0 9200 27 0 87 89 0 0 0 103 52 14 10 15 9 65
2 1 9200 22 0 136 122 0 0 0 207 251 29 9 12 8 71
3 1 9200 19 0 112 107 0 0 0 207 120 29 11 9 7 73
5 1 9200 17 0 99 122 0 0 0 206 120 29 12 8 8 72

```

- A. The machine needs a CPU upgrade.
- B. Another ATM card needs to be added.
- C. The paging space needs to be optimized.
- D. A user program is causing a system loop.

9. A customer is experiencing performance problems and runs the **iostat** command. The output of the **iostat** command is shown below. What should be recommended?

```
tty: tin tout avg-cpu: % user % sys % idle %
iowait
 0.0 170.2 7.1 12.1 0.8 80.0
```

```
Disks: % tm_act Kbps tps Kb_read Kb_wrtn
hdisk0 0.0 0.0 0.0 0 0
hdisk1 0.0 0.0 0.0 0 0
cd0 55.9 622.4 155.6 1250 8
```

```
tty: tin tout avg-cpu: % user % sys % idle %
iowait
 0.0 170.2 5.1 14.1 0.8 80.0
```

```
Disks: % tm_act Kbps tps Kb_read Kb_wrtn
hdisk0 0.5 2.0 0.5 4 0
hdisk1 0.0 0.0 0.0 0 0
cd0 55.9 622.4 155.6 1270 0
```

- A user program needs optimizing.
- Another ATM card needs to be added.
- The CD-ROM needs to be removed from the configuration.
- Space permitting, the volume mounted on the CD-ROM should be moved to a disk.

## 10.8.1 Answers

The following answers are for the assessment quiz questions.

- B
- A
- C

The following answers are for the additional quiz questions.

- A
- B
- C
- A
- A
- D



7. B
8. C
9. D

## 10.9 Exercises

The following exercises provide sample topics for self study. They will help ensure comprehension of this chapter.

1. Execute the **iostat** command on the system and analyze the output for CPU statistics, and disk statistics.
2. Execute the **vmstat** command on the system and analyze the output for CPU statistics and paging activity.
3. Determine the I/O for persistent storage on your system using the **vmstat -s** command.
4. Increase the default paging space (hd6) on the system by 5 MB and then reduce the size of the default paging space by 5 MB. How many system reboots are required to accomplish this task?





# Networking

A network is the combination of two or more computers and the connecting links between them. A physical network is the hardware (equipment such as adapter cards, cables, and concentrators) that makes up the network. The software and the conceptual model make up the logical network.

You will find important aspects of network support on systems in this section, including modifying network adapters and interfaces, performance tuning, and network troubleshooting. Note that this does not present the full scope of network support, but provides a useful starting point for support professionals.

## 11.1 Adapters, interfaces, and configuration problems

In AIX, most forms of system-to-system and system-to-network communication is done through the use of adapters and interfaces. Adapters are physical components of systems (hardware) that actively broadcast system information to other systems or networks. Examples of this include Ethernet and token ring PCI adapter cards. Interfaces are definitions within the system that refer information to adapters or other internal components. Examples of this include a token ring network interface or the loopback interface. This section describes some common tasks and problems you will encounter while performing network adapter and interface support.

### 11.1.1 Adding a network adapter

To add a network adapter to the system, perform the following steps:

**Note:** You should perform this procedure during a system maintenance window, as this procedure will require the shutdown of the system and may interfere with the work of users on the system.

1. Examine what network adapters and interfaces are already on the system by running the following commands:

```
lspcfg |grep -i adapter
+ mg20 20-58 GXT130P Graphics Adapter
+ fda0 01-D1 Standard I/O Diskette Adapter
* siokma0 01-K1 Keyboard/Mouse Adapter
+ sioka0 01-K1-00 Keyboard Adapter
+ sioma0 01-K1-01 Mouse Adapter
+ ppa0 01-R1 Standard I/O Parallel Port Adapter
+ tok0 10-68 IBM PCI Tokenring Adapter (14103e00)
+ ent0 10-80 IBM PCI Ethernet Adapter (22100020)
lsdev -Cc if
en0 Defined 10-80 Standard Ethernet Network Interface
et0 Defined 10-80 IEEE 802.3 Ethernet Network Interface
lo0 Available Loopback Network Interface
tr0 Available 10-68 Token Ring Network Interface
```

2. Shut down and power off the system (for systems without hot plug cards).
3. Physically install the new network adapter.
4. Power on the system in normal mode.
5. When the system is fully up, run the **cfgmgr** command. This will automatically detect the network adapter and add network interfaces for the adapter.

**Note:** After running `cfgmgr`, you may receive an error message as in the following example:

```
cfgmgr
cfgmgr: 0514-621 WARNING: The following device packages are required for
device support but are not currently installed.
devices.pci.ethernet:devices.pci.14100401:devices.pci.ae120100:devices.pci
i.pciclass.020000
```

If a message such as this appears, you will need to install the additional filesets listed to enable the network adapter on the system.

6. Run the following commands to confirm the network adapter has been properly added to the system:

```
lspcfg |grep -i adapter
+ mg20 20-58 GXT130P Graphics Adapter
+ ent1 20-60 Gigabit Ethernet-SX PCI Adapter
+ fda0 01-D1 Standard I/O Diskette Adapter
* siokma0 01-K1 Keyboard/Mouse Adapter
+ sioka0 01-K1-00 Keyboard Adapter
+ sioma0 01-K1-01 Mouse Adapter
+ ppa0 01-R1 Standard I/O Parallel Port Adapter
+ tok0 10-68 IBM PCI Tokenring Adapter (14103e00)
+ ent0 10-80 IBM PCI Ethernet Adapter (22100020)
lsdev -Cc if
en0 Defined 10-80 Standard Ethernet Network Interface
en1 Defined 20-60 Standard Ethernet Network Interface
et0 Defined 10-80 IEEE 802.3 Ethernet Network Interface
et1 Defined 20-60 IEEE 802.3 Ethernet Network Interface
lo0 Available Loopback Network Interface
tr0 Available 10-68 Token Ring Network Interface
```

## 11.1.2 Removing a network adapter

To remove a network adapter from the system, use the `ifconfig` command to remove the network adapter and interface definitions from the system prior to physically removing the network adapter. The `ifconfig` command allows you to perform configurations and modifications directly to network interfaces. The general syntax of the `ifconfig` command is as follows:

```
ifconfig Interface [AddressFamily [Address [DestinationAddress]]
[Parameters...]]
```

Table 11-1 is a list of common command parameters and their functions for the **ifconfig** command.

Table 11-1 Command parameters for *ifconfig*

| Parameter           | Description                                                                                                            |
|---------------------|------------------------------------------------------------------------------------------------------------------------|
| alias               | Establishes an additional network address for the interface.                                                           |
| delete              | Removes the specified network address from the interface.                                                              |
| detach              | Removes an interface from the network interface list.                                                                  |
| down                | Marks an interface as inactive (down), which keeps the system from trying to transmit messages through that interface. |
| mtu <i>Value</i>    | Sets the maximum IP packet size to <i>Value</i> bytes, (maximum transmission unit), ranging from 60 to 65535.          |
| netmask <i>Mask</i> | Specifies how much of the address to reserve for subdividing networks into subnetworks.                                |
| up                  | Marks an interface as active (up).                                                                                     |

To remove a network adapter, perform the following steps:

**Note:** Before performing this procedure, make sure that no applications or processes still use the network adapter or network interfaces associated with the network adapter you intend to remove. This can potentially cause system problems if the applications and processes on the system attempt to use network adapters or interfaces that are no longer present on the system.

You should perform this procedure during a system maintenance window, as this procedure may require the shutdown of the system and may interfere with the work of users on the system.

1. Deactivate (down) all network interface definitions for the network adapter by running the command:

```
ifconfig Interface down
```

This step is technically not required, but is a good failsafe to ensure that no applications or processes are using the specified network interfaces.

2. Remove (detach) all network interface definitions from the network interface list by running the command:

```
ifconfig Interface detach
```

This step will remove all attributes associated with the network interface from the system, including attributes like IP address and MTU size.

3. Delete the network interface definitions from the system by running the command:

```
rmdev -l Interface -d
```

4. Delete the network adapter definition from the system by running the command:

```
rmdev -l Adapter -d
```

5. Shut down and power off the system (on non hot plug machines).
6. Physically remove the network adapter.
7. Power on the system.

**Note:** If you do not physically remove the network adapter before powering on the system, the **cfgmgr** program will detect the network adapter during the system boot, unless it is an ISA adapter, and redefine the device in the Customized Devices object database.

### 11.1.3 Adapter and interface configuration problems

Network adapters that are properly added to your system may have difficulty communicating to other systems or networks, although all the hardware appears to be functioning correctly. These problems can be caused by incorrect adapter and interface configuration.

#### Ring and media speed configuration problems

Both Ethernet and token ring adapters communicate at a certain rate of data throughput called the ring or media speed. For token ring adapters, communication is done at either a 4 or 16 Mbps ring speed. For most Ethernet adapters, communication is done at either a 10 or 100 Mbps ring speed in one of two modes: full duplex or half duplex.

An incorrect ring or media speed will prevent the system from communicating with other systems or networks. Some symptoms of a problem due to incorrect ring or media speed may include:

- ▶ Connection timeouts (**telnet**)
- ▶ No packet transmission or response (**ping**)
- ▶ Unusual pauses and hangs when initializing communication daemons (**inetd**)

To correct ring or media speed problems, perform the following steps:

1. Obtain the proper ring or media speed from your network administrator.

2. Remove (detach) all network interfaces for the network adapter by running the command:

```
ifconfig Interface detach
```

**Note:** Removing all network interfaces by using the detach parameter will remove all configuration for the network interfaces, including IP addresses and MTU size definitions. You should keep a copy of all necessary configuration for the network interfaces for reconfiguration after the ring or media speed is changed.

3. To change the ring speed for a token ring adapter, run the command **smitty chgtok** (for changing the media speed for an Ethernet adapter, go to step 6). You will see a submenu similar to the one shown in Figure 11-1.

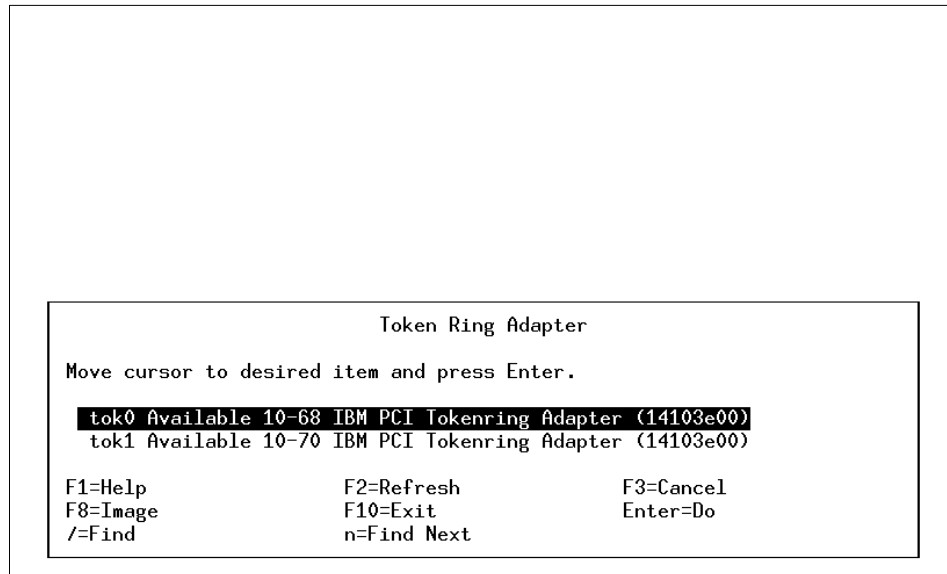

Figure 11-1 Token Ring Adapter submenu

Use the arrow keys to select the adapter you want, and press Enter.

4. On the following screen, you will see a menu similar to the one in Figure 11-2 on page 267.



```

Change / Show Characteristics of a Token Ring Adapter

Type or select values in entry fields.
Press Enter AFTER making all desired changes.

Token Ring Adapter [Entry Fields]
Description tok0
Status IBM PCI Tokenring Adap>
Location Available
TRANSMIT queue size 10-68
HARDWARE RECEIVE queue size 64 + #
RING speed [5]12] + #
Full duplex [autosense] +
Receive ATTENTION MAC frame no +
Receive BEACON MAC frame no +
Enable ALTERNATE TOKEN RING address no +
ALTERNATE TOKEN RING address [0x] +
Apply change to DATABASE only no +

F1=Help F2=Refresh F3=Cancel F4=List
F5=Reset F6=Command F7=Edit F8=Image
F9=Shell F10=Exit Enter=Do

```

Figure 11-2 Change/Show Characteristics of a Token Ring Adapter menu

Use the arrow keys to select the RING speed field, and press F4.

5. A submenu will pop up, providing the ring speed options, similar to the one shown in Figure 11-3.

```

Change / Show Characteristics of a Token Ring Adapter

Type or select values in entry fields.
Press Enter AFTER making all desired changes.

Token Ring Adapter [Entry Fields]
Description tok0
Status IBM PCI Tokenring Adap>
Location Available
TRANSMIT queue size 10-68
RING speed [5]12] + #
Full duplex [autosense] +
Receive ATTENTION MAC frame no +
Receive BEACON MAC frame no +
Enable ALTERNATE TOKEN RING address no +
ALTERNATE TOKEN RING address [0x] +
Apply change to DATABASE only no +

F1=Help F2=Refresh F3=Cancel F4=List
F5=Reset F6=Command F7=Edit F8=Image
F9=Shell F10=Exit Enter=Do

Move cursor to desired item and press Enter.

 4
 16
 autosense

F1=Help F2=Refresh F3=Cancel
F8=Image F10=Exit Enter=Do
F5 n=Find Next
F9

```

Figure 11-3 RING speed submenu

Select the ring speed you want, and press Enter. Press Enter again to change the ring speed for the token ring adapter.

6. To change the media speed for an Ethernet adapter, run the command **smitty chgenet**. You will see a submenu similar to the one shown in Figure 11-4.

```

 Ethernet Adapter
Move cursor to desired item and press Enter.
ent0 Available 10-80 IBM PCI Ethernet Adapter (22100020)
ent1 Available 30-70 IBM 10/100 Mbps Ethernet PCI Adapter (23100020)

F1=Help F2=Refresh F3=Cancel
F8=Image F10=Exit Enter=Do
/=Find n=Find Next
```

Figure 11-4 Ethernet Adapter submenu

Use the arrow keys to select the adapter you want, and press Enter.

7. On the following screen, you will see a menu similar to the one shown in Figure 11-5 on page 269.

```

Change / Show Characteristics of an Ethernet Adapter

Type or select values in entry fields.
Press Enter AFTER making all desired changes.

 [Entry Fields]
Ethernet Adapter ent1
Description IBM 10/100 Mbps Ethern>
Status Available
Location 30-70
TRANSMIT queue size [512] + #
HARDWARE RECEIVE queue size [256] + #
RECEIVE buffer pool size [384] + #
Media Speed 100_Full_Duplex +
Inter-Packet Gap [96] + #
Enable ALTERNATE ETHERNET address no +
ALTERNATE ETHERNET address [0x000000000000] +
Apply change to DATABASE only no +

F1=Help F2=Refresh F3=Cancel F4=List
F5=Reset F6=Command F7=Edit F8=Image
F9=Shell F10=Exit Enter=Do

```

Figure 11-5 Change/Show Characteristics of an Ethernet Adapter menu

Use the arrow keys to select the Media Speed field, and press F4.

8. A submenu will pop up, providing the ring speed options, similar to the one shown in Figure 11-6.

```

Change / Show Characteristics of an Ethernet Adapter

Type or select values in entry fields.
Press Enter AFTER making all desired changes.

 [Entry Fields]
Ethernet Adapter ent1
Description IBM 10/100 Mbps Ethern>
Status Available

 Media Speed
Move cursor to desired item and press Enter.

 10_Half_Duplex
 10_Full_Duplex
 100_Half_Duplex
 100_Full_Duplex
 Auto_Negotiation

F1=Help F2=Refresh F3=Cancel F4=List
F5=Image F8=Image F10=Exit F10=Exit
F9 /=Find n=Find Next Enter=Do

```

Figure 11-6 Media Speed submenu

Select the media speed you want, and press Enter. Press Enter again to change the media speed for the Ethernet adapter.

## Cable type configuration problems

Ethernet adapters can use several different types of cable connections, such as bnc or dix. If the cable type is set incorrectly, the system may not be able to communicate properly.

To set the cable type, run **smitty tcpip** and, in the Minimum Configuration & Startup menu, select the Ethernet interface you want to change. A screen similar to the one shown in Figure 11-7 will appear.

```
Minimum Configuration & Startup

To Delete existing configuration data, please use Further Configuration menus

Type or select values in entry fields.
Press Enter AFTER making all desired changes.

[TOP] [Entry Fields]
* HOSTNAME [Server2.itsc.austin.ib>]
* Internet ADDRESS (dotted decimal) []
 Network MASK (dotted decimal) []
* Network INTERFACE en1
 NAMESERVER
 Internet ADDRESS (dotted decimal) [9.3.240.2]
 DOMAIN Name [itsc.austin.ibm.com]
 Default Gateway
 Address (dotted decimal or symbolic name) [9.3.240.1]
 Cost [0] #
 Do Active Dead Gateway Detection? no +
[MORE...2]

F1=Help F2=Refresh F3=Cancel F4=List
F5=Reset F6=Command F7=Edit F8=Image
F9=Shell F10=Exit Enter=Do
```

Figure 11-7 Minimum Configuration & Startup menu for CABLE type

Scroll down using the arrow keys to the Your CABLE Type field and press F4. A submenu similar to the one shown in Figure 11-8 on page 271 will pop up.

```

Minimum Configuration & Startup

To Delete existing configuration data, please use Further Configuration menus

Type or select values in entry fields.
Press Enter AFTER making all desired changes.

[MORE...2] [Entry Fields]
Network MASK (dotted decimal) []
* Network INTERFACE en1

Your CABLE Type

Move cursor to desired item and press Enter.

bnc
dix
tp
N/A
#
+
+
+

[CB]
F1=Help F2=Refresh F3=Cancel
F1 F8=Image F10=Exit Enter=Do
F5 /=-Find n=Find Next
F9

```

Figure 11-8 Your CABLE Type submenu

Use the arrow keys to select your cable type, and press Enter. Press Enter again to change the cable type for the Ethernet definition.

## Network interface MTU size problems

When messages are transmitted through a network interface, they travel in bundles of information called packets. These packets can vary in length from 60 bytes to 65535 bytes per packet. By default, a 16 Mb token-ring interface will transmit packets that are 1492 bytes long, and Ethernet interfaces will transmit packets that are 1500 bytes long. For AIX systems, these packets are governed by the maximum transmission unit (MTU) size variable.

**Note:** The minimum and maximum MTU sizes for specific interfaces may vary. See “Automatic Configuration of Network Interfaces” in the *AIX 5L Version 5.1 System Management Guide: Communications and Networks* for more information. This guide can be found at:

<http://www.ibm.com/servers/aix/library>

All systems on the same local area network must have the same MTU size to communicate properly. If a system has an incorrect MTU size, packets from other systems may not reach their target systems due to packet collisions.

To determine the MTU size for a network interface, run the command:

```
lsattr -El Interface
```

The output will look similar to the following:

```
lsattr -El tr1
mtu 1492 Maximum IP Packet Size for This Device True
mtu_4 1492 Maximum IP Packet Size for 4 Mbit ring speed True
mtu_16 1492 Maximum IP Packet Size for 16 Mbit ring speed True
mtu_100 1492 Maximum IP Packet Size for 100 Mbit ring speed True
...
```

The **ifconfig** command can adjust the MTU size for a network interface. To change the MTU size, run the command:

```
ifconfig Interface mtu Value
```

For example, to change the MTU size of tr1 to 12000 bytes in length, run the command:

```
ifconfig tr1 mtu 12000
```

The **chdev** command can also change the MTU size by running:

```
chdev -l Interface -a mtu=Value
```

**Note:** The MTU size cannot be changed while the interface is in use. The interface must first be deactivated (down) before the MTU size can be changed.

## 11.2 TCP/IP

TCP/IP is a peer-to-peer, connection-oriented protocol for system-to-system and system-to-network communications. TCP/IP has no master/slave relations between systems and networks. TCP/IP applications, however, use a client/server model for communications.

### 11.2.1 TCP/IP initialization

During the IPL process when a system is booted, the init process will start TCP/IP by running the `/etc/rc.tcpip` script after starting the SRC. The `/etc/rc.tcpip` script uses SRC commands to initialize selected daemons.

Most of the daemons that can be initialized by the `/etc/rc.tcpip` file are specific to TCP/IP. These daemons are:

- inetd** Provides Internet service management for a network; started by default.
- gated** Provides gateway routing functions for all TCP/IP protocols, such as SNMP and ICMP.
- routed** Implements the Routing Information Protocol (RIP).
- named** Provides services for the Domain Name Protocol (DOMAIN).
- timed** Synchronizes one machine's clock with those of other machines on the LAN that are also running the timed daemon.
- rwhod** Maintains the database used by the **rwho** and **ruptime** commands.

**Note:** Running the **gated** and **routed** daemons at the same time on a host may cause unpredictable results.

There are also daemons specific to the base operating system or to other applications that can be started through the `/etc/rc.tcpip` file. These daemons are:

- lpd** Provides the remote print server, monitoring port 515 for print requests.
- portmap** Knows the location of every registered port on the host and which programs are available on each of these ports.
- sendmail** Receives formatted text messages and routes the messages to one or more users (mail).
- syslogd** Reads a datagram socket and sends each message line to a destination described by the `/etc/syslog.conf` configuration file; started by default.

**Note:** If `/etc/rc.tcpip` is not initialized by `/etc/inittab` at boot time, and you have a graphics console, ensure that the `/etc/rc.dt` entry in `/etc/inittab` is also not initialized at boot time. If `/etc/rc.dt` has not been commented out or removed from `/etc/inittab`, your console will hang when you try to log in and you will not be able to recover, as extra-system communication (**telnet**, **rlogin**) will not have been initialized.

## 11.2.2 Starting and stopping TCP/IP daemons

Any TCP/IP daemon that is initialized by `/etc/rc.tcpip` during the system boot can be stopped by running the command:

```
stopsrc -s Daemon
```

To stop all TCP/IP daemons, run the command:

```
stopsrc -g tcpip
```

To stop TCP/IP daemons and remove the TCP/IP /etc/locks/lpd lock files, run the command:

```
/etc/tcp.clean
```

To start a specific TCP/IP daemon, run the command:

```
startsrc -s Daemon
```

To start all TCP/IP daemons that are normally started during the IPL process when a system is booted, run the command:

```
/etc/rc.tcpip
```

**Note:** Do *not* restart TCP/IP daemons using the command:

```
startsrc -g tcpip
```

It will start all subsystems defined in the ODM for the tcpip group, which includes both routed and gated.

### 11.2.3 The inetd daemon

The inetd daemon provides Internet service management for a network. This daemon reduces system load by invoking other daemons only when they are needed and by providing several simple Internet services internally without invoking other daemons. By default, the subservers (daemons) started by inetd are:

- |                |                                                                                                                                                                              |
|----------------|------------------------------------------------------------------------------------------------------------------------------------------------------------------------------|
| <b>comsat</b>  | Receives reports of incoming mail and notifies users if they have enabled this service with the <b>bi ff</b> command.                                                        |
| <b>ftpd</b>    | Serves as the Defense Advanced Research Product Agency (DARPA) Internet File Transfer Protocol (FTP) server process.                                                         |
| <b>fingerd</b> | Provides an interface to the <b>finger</b> command at several network sites. The <b>finger</b> command returns a status report on either the system or a user on the system. |
| <b>rlogind</b> | Provides services for the <b>rlogin</b> remote login command.                                                                                                                |
| <b>rexecd</b>  | Provides services for the <b>rexec</b> remote execute command.                                                                                                               |
| <b>rshd</b>    | Provides services for the <b>rcp</b> and <b>rsh</b> commands for remote execution of shell commands.                                                                         |
| <b>talkd</b>   | Provides services that notifies a user (the recipient) that another user (the caller) wants to initiate a conversation by the <b>talk</b> command.                           |



|                |                                                                                                                                                          |
|----------------|----------------------------------------------------------------------------------------------------------------------------------------------------------|
| <b>telnetd</b> | Serves as the DARPA standard Telnet Protocol (TELNET) server communication process.                                                                      |
| <b>tftpd</b>   | Runs the Trivial File Transfer Protocol (TFTP) server.                                                                                                   |
| <b>uucpd</b>   | Enables users of systems linked by the Basic Networking Utilities (BNU) program to establish a TCP/IP connection to other systems linked over a network. |

For example, when a user attempts to establish a telnet connection to a system running the inetd daemon, the telnetd daemon will be initialized by the inetd daemon upon connection request. Otherwise, the telnetd daemon will not be running on the system until a connection request is made.

By default, the tftpd, fingerd, and comsat daemons are not started by inetd. To enable them, remove the # (pound) sign in front of the service you wish to enable, and run the command:

```
refresh -s inetd
```

## 11.2.4 Errors with the inetd daemon and subservers

The **ping** command sends an Internet Control Message Protocol (ICMP) ECHO\_REQUEST packet from a system to obtain an ICMP ECHO\_RESPONSE packet from another system. The **ping** command can be used to see if another system is on a network, or to measure the amount of time it takes information (packets) to be sent or received from a particular system.

If the inetd daemon is not initialized by /etc/rc.tcpip, other systems will not be able to establish network communications using services such as Telnet or FTP to your system, although they will be able to **ping** and successfully receive ICMP ECHO\_RESPONSE packets back from your system. However, as long as the network interface has not been brought down (deactivated) on your system, you can still utilize the client network services to Telnet, FTP, and **ping** to other systems.

If the inetd daemon has been initialized by /etc/rc.tcpip and other systems are able to **ping** your system, but they are unable to issue to establish Telnet connections to your system, your system may have a problem with the amount of pseudo-terminals available.

By default, when an **rlogin**, **telnet**, or **rsh** command opens a session on a system, or when a window with a shell is opened on a graphical system console (aixterm), the system spawns a pseudo-terminal session. If the maximum amount of pseudo-terminals on the system are being used, any subsequent attempts to spawn a new pseudo-terminal will hang.

The maximum amount of pseudo terminals can be changed by running the command **smitty chgpty**. A sample screen is shown in Figure 11-9.

```
Change / Show Characteristics of the PTY

Type or select values in entry fields.
Press Enter AFTER making all desired changes.

STATE to be configured at boot time
Maximum number of Pseudo-Terminals [256]
Maximum number of BSD Pseudo-Terminals [16]

[Entry Fields]
available +
[256] #
[16] +#

F1=Help F2=Refresh F3=Cancel F4=List
F5=Reset F6=Command F7=Edit F8=Image
F9=Shell F10=Exit Enter=Do
```

Figure 11-9 Change/Show Characteristics of the PTY menu

By default, systems have 256 pseudo-terminals available. To change this value, use the arrow keys to go to the Maximum number of Pseudo-Terminals field and type in how many pseudo-terminals you want to enable. Press Enter to change the maximum number of pseudo-terminals.

**Note:** More pseudo-terminals will use more memory and resources as pseudo-terminals are opened.

## 11.3 IP addressing, gateways, and subnetting

Internet Protocol (IP) addressing and subnetting allows systems to communicate with each other and to other systems or networks across the TCP/IP network. IP addresses are unique identifiers for systems, routers, and other network devices that send and receive information across the TCP/IP network. Gateways are systems that handle the routing of information to other systems and networks. Subnets are ways of grouping systems by IP addresses into common sub-networks for communication ease.

## 11.3.1 IP addresses

A standard IPv4 address field has two parts: a network address and a local address. This IP address is 32-bits in length grouped eight bits at a time, separated in decimal format, such as 207.25.253.26. These addresses are broken down into one of five classes, A, B, C, D, or E, based upon their network address (as shown in Table 11-2).

Table 11-2 IPv4 address classes

| IP address class                      | Format  | First octet | Address range                | Number bits network / host | Number of hosts |
|---------------------------------------|---------|-------------|------------------------------|----------------------------|-----------------|
| A                                     | N.H.H.H | 0           | 1.0.0.0<br>127.0.0.0         | 7 / 24                     | $2^{24} - 2$    |
| B                                     | N.N.H.H | 10          | 128.1.0.0<br>191.254.0.0     | 14 / 16                    | $2^{16} - 2$    |
| C                                     | N.N.N.H | 110         | 192.0.1.0<br>223.255.254.0   | 22 / 8                     | $2^8 - 2$       |
| D                                     | -       | 1110        | 224.0.0.0<br>239.255.255.255 | -                          | -               |
| N - Network number<br>H - Host number |         |             |                              |                            |                 |

### The netstat command

To view information about network information and IP addresses on your system, run the **netstat** command. The syntax of the **netstat** command is as follows:

```
netstat [-n] [{ -A -a } | { -r -C -i -I Interface }] [-f AddressFamily]
[-p Protocol] [Interval] [System]
```

Table 11-3 is a list of common command flags and their descriptions for the **netstat** command.

Table 11-3 Command flags for netstat

| Flag | Description                                                                                        |
|------|----------------------------------------------------------------------------------------------------|
| -a   | Shows the state of all sockets. Without this flag, sockets used by server processes are not shown. |
| -i   | Shows the state of all configured interfaces.                                                      |
| -m   | Shows statistics recorded by the memory management routines.                                       |

| Flag               | Description                                                                                                                                                                                                                |
|--------------------|----------------------------------------------------------------------------------------------------------------------------------------------------------------------------------------------------------------------------|
| -n                 | Shows network addresses as numbers. When this flag is not specified, the <b>netstat</b> command interprets addresses where possible and displays them symbolically. This flag can be used with any of the display formats. |
| -p <i>Protocol</i> | Shows statistics about the value specified for the <i>Protocol</i> variable, which is either a well-known name for a protocol or an alias for it, like tcp or udp.                                                         |
| -r                 | Shows the routing tables. When used with the -s flag, the -r flag shows routing statistics.                                                                                                                                |
| -s                 | Shows statistics for each protocol.                                                                                                                                                                                        |

For example, to view a simple routing table containing IP addresses of network interfaces, run the command:

```
netstat -rn
Routing tables
Destination Gateway Flags Refs Use If PMTU Exp Groups

Route Tree for Protocol Family 2 (Internet):
9.3.1/24 9.3.1.141 U 11 1265 tr0 - -
127/8 127.0.0.1 U 2 382 lo0 - -
192.168.0/16 192.168.3.1 U 0 4 en0 - -

Route Tree for Protocol Family 24 (Internet v6):
::1 ::1 UH 0 0 lo0 16896 -
```

To view information about network interfaces, including MTU size, IP address, and the amount of packets being transmitted through the network interface, run the command:

```
netstat -in
Name Mtu Network Address Ipkts Ierrs Opkts Oerrs Coll
lo0 16896 link#1 340 0 341 0 0
lo0 16896 127 127.0.0.1 340 0 341 0 0
lo0 16896 ::1 340 0 341 0 0
en0 1492 link#2 8.0.5a.f8.d6.cc 39 0 5 0 0
en0 1492 192.168.0 192.168.3.1 39 0 5 0 0
tr0 1492 link#3 0.4.ac.61.73.ee 6542 0 509 0 0
tr0 1492 9.3.1 9.3.1.141 6542 0 509 0 0
```

## Changing the state of network interfaces

Changing the state of network interfaces, including the assignment of IP addresses, can be performed with the **ifconfig** command. Changes made with the **ifconfig** command can be verified with the **netstat** command.

To deactivate (down) a network interface, such as tr0, run the command:

```
ifconfig tr0 down
netstat -in
Name Mtu Network Address Ipkts Ierrs Opkts Oerrs Coll
lo0 16896 link#1 338 0 339 0 0
lo0 16896 127 loopback 338 0 339 0 0
lo0 16896 ::1 338 0 339 0 0
en0 1492 link#2 8.0.5a.f8.d6.cc 39 0 5 0 0
en0 1492 192.168.0 192.168.3.1 39 0 5 0 0
tr0* 1492 link#3 0.4.ac.61.73.ee 5954 0 434 0 0
tr0* 1492 9.3.1 9.3.1.141 5954 0 434 0 0
Routing tables
Destination Gateway Flags Refs Use If PMTU Exp Groups
netstat -rn
Route Tree for Protocol Family 2 (Internet):
9.3.1/24 9.3.1.141 U 2 731 tr0 - -
127/8 127.0.0.1 U 4 337 lo0 - -
192.168.0/16 192.168.3.1 U 0 4 en0 - -
Route Tree for Protocol Family 24 (Internet v6):
::1 ::1 UH 0 0 lo0 16896 -
```

When the interface has been brought down (deactivated), the routing table produced by the **netstat -rn** command does not change much. However, in the interface configuration output of the **netstat -in** command, you may notice asterisks (\*) by the token ring interface, indicating that it is in the down state.

But, if the token-ring interface is removed (detached) from the network interface list, the token-ring entries will no longer exist in the interface configuration and route table of the **netstat** command output. To remove (detach) a network interface from the system, run the command:

```
ifconfig tr0 detach
netstat -i
Name Mtu Network Address Ipkts Ierrs Opkts Oerrs Coll
lo0 16896 link#1 789 0 790 0 0
lo0 16896 127 loopback 789 0 790 0 0
lo0 16896 ::1 789 0 790 0 0
en0 1492 link#2 8.0.5a.f8.d6.cc 39 0 5 0 0
en0 1492 192.168.0 192.168.3.1 39 0 5 0 0
Routing tables
Destination Gateway Flags Refs Use If PMTU Exp Groups
netstat -rn
Route Tree for Protocol Family 2 (Internet):
127/8 127.0.0.1 U 3 378 lo0 - -
192.168.0/16 192.168.3.1 U 0 4 en0 - -
Route Tree for Protocol Family 24 (Internet v6):
::1 ::1 UH 0 0 lo0 16896 -
```

As shown, the tr0 interface is no longer listed on the interface configuration list or the route table.

To add a network interface to the system, or to re-add a previously removed (detached) network interface to the system, run the command:

```
ifconfig tr0 up
```

Simply configuring the token-ring interface state to up is not enough to return the network back to the original status. To assign a network address and netmask to a network interface, run the command:

```
ifconfig tr0 9.3.1.141 netmask 255.255.255.0 up
netstat -in
Name Mtu Network Address Ipkts Ierrs Opkts Oerrs Coll
lo0 16896 link#1 991 0 992 0 0
lo0 16896 127 localhost 991 0 992 0 0
lo0 16896 ::1 991 0 992 0 0
en0 1492 link#2 8.0.5a.f8.d6.cc 39 0 5 0 0
en0 1492 192.168.0 192.168.3.1 39 0 5 0 0
tr0 1492 link#3 0.4.ac.61.73.ee 76 0 18 0 0
tr0 1492 9.3.1 9.3.1.141 76 0 509 0 0
netstat -rn
Routing tables
Destination Gateway Flags Refs Use If PMTU Exp Groups

Route Tree for Protocol Family 2 (Internet):
9.3.1/24 9.3.1.141 U 0 22 tr0 - -
127/8 127.0.0.1 U 3 380 lo0 - -
192.168.0/16 192.168.3.1 U 0 4 en0 - -

Route Tree for Protocol Family 24 (Internet v6):
::1 ::1 UH 0 0 lo0 16896 -
```

## 11.3.2 Gateways

Information that is sent to destinations not explicitly defined in your system or on a network directly connected to your system will pass through a gateway. This gateway (also called a route) is a system or network device that will route information onto other systems or networks.

## Using traceroute

The **traceroute** command can show through which routes (gateways) information travels, how long it takes information to reach its destination, and through how many routers the information traverses (hops). For example, if you wanted to see which route information travels from the system with the IP address of 9.3.1.141, to the system with the IP address of 9.8.0.8, you would enter:

```
traceroute 9.8.0.8
trying to get source for 9.8.0.8
source should be 9.3.1.141
traceroute to 9.8.0.8 (9.8.0.8) from 9.3.1.141 (9.3.1.141), 30 hops max
outgoing MTU = 1492
 1 itso.austin.ibm.com (9.3.1.74) 11 ms 2 ms 2 ms
 2 9.444.33.129 (9.444.33.129) 4 ms 4 ms 4 ms
 3 9.444.33.129 (9.444.33.129) 4 ms 4 ms 4 ms
 4 site1.austin.ibm.com (9.3.90.200) 7 ms site2.south.ibm.com (9.3.200.202) 8
ms 7 ms
 5 site3.austin.ibm.com (199.4.213.125) 17 ms 19 ms 17 ms
 6 9.88.1.174 (9.88.1.174) 74 ms 80 ms 71 ms
 7 9.8.0.8 (9.8.0.8) 327 ms 329 ms 327 ms
```

## Defining a default route

If a default route is not defined on your system, only directly attached hosts are accessible from your system. For example, on the system with the IP address of 9.3.1.141, a default route is not defined. When the system attempts to contact the system with the IP address 9.8.0.8, that is not on the same local network, so the system receives errors:

```
ping 9.8.0.8
PING 9.8.0.8: (9.8.0.8): 56 data bytes
0821-069 ping: sendto: Cannot reach the destination network.
ping: wrote 9.8.0.8 64 chars, ret=-1
0821-069 ping: sendto: Cannot reach the destination network.
ping: wrote 9.8.0.8 64 chars, ret=-1
^C
----9.8.0.8 PING Statistics----
2 packets transmitted, 0 packets received, 100% packet loss
traceroute 9.8.0.8
trying to get source for 9.8.0.8
source should be 9.3.1.141
traceroute to 9.8.0.8 (9.8.0.8) from 9.3.1.141 (9.3.1.141), 30 hops max
sendto: Cannot reach the destination network.
 1 traceroute: Partial write of -1 bytes
outgoing MTU = 32768
 *sendto: Cannot reach the destination network.
traceroute: Partial write of -1 bytes
 *sendto: Cannot reach the destination network.
```

```
traceroute: Partial write of -1 bytes
^C#
```

The **netstat -rn** command shows that there is no default route assigned:

```
netstat -rn
Routing tables
Destination Gateway Flags Refs Use If PMTU Exp Groups

Route Tree for Protocol Family 2 (Internet):
9.3.1/24 9.3.1.141 U 11 1265 tr0 - -
127/8 127.0.0.1 U 2 382 lo0 - -
192.168.0/16 192.168.3.1 U 0 4 en0 - -

Route Tree for Protocol Family 24 (Internet v6):
::1 ::1 UH 0 0 lo0 16896 -
```

To add a default route to the system, run the **route add** command. For example, to add the route 9.3.1.74 to the system, you would run:

```
route add -net 0 9.3.1.74
9.3.1.74 net 0: gateway 9.3.1.74
```

This change can be seen in the **netstat -rn** output:

```
netstat -rn
Routing tables
Destination Gateway Flags Refs Use If PMTU Exp Groups

Route Tree for Protocol Family 2 (Internet):
default 9.3.1.74 UG 0 0 tr0 - -
9.3.1/24 9.3.1.141 U 2 189 tr0 - -
127/8 127.0.0.1 U 3 380 lo0 - -
192.168.0/16 192.168.3.1 U 0 4 en0 - -

Route Tree for Protocol Family 24 (Internet v6):
::1 ::1 UH 0 0 lo0 16896 -
```

Now, the system can communicate with the 9.8.0.8 system, as shown by the **ping** command output:

```
ping 9.8.0.8
PING 9.8.0.8: (9.8.0.8): 56 data bytes
64 bytes from 9.8.0.8: icmp_seq=0 ttl=49 time=384 ms
64 bytes from 9.8.0.8: icmp_seq=1 ttl=50 time=354 ms
^C
----9.8.0.8 PING Statistics----
2 packets transmitted, 2 packets received, 0% packet loss
round-trip min/avg/max = 354/369/384 ms
traceroute 9.8.0.8
trying to get source for 9.8.0.8
```



```

source should be 9.3.1.141
traceroute to 9.8.0.8 (9.8.0.8) from 9.3.1.141 (9.3.1.141), 30 hops max
outgoing MTU = 1492
 1 itso.austin.ibm.com (9.3.1.74) 11 ms 2 ms 2 ms
 2 9.444.33.129 (9.444.33.129) 4 ms 4 ms 4 ms
 3 9.444.33.129 (9.444.33.129) 4 ms 4 ms 4 ms
 4 site1.austin.ibm.com (9.3.90.200) 7 ms site2.south.ibm.com (9.3.200.20
2) 8 ms 7 ms
 5 site3.austin.ibm.com (199.4.213.125) 17 ms 19 ms 17 ms
 6 9.88.1.174 (9.88.1.174) 74 ms 80 ms 71 ms
 7 9.8.0.8 (9.8.0.8) 327 ms 329 ms 327 ms

```

### 11.3.3 Subnets

When a system sends a message to a destination, the system must determine whether the destination is on the same network as the source or if the destination must be reached through a gateway. The system compares the destination address to the host address using the subnet mask.

Subnet addressing allows an autonomous network made up of multiple systems to share the same network address. To make subnets possible, the local address part of an Internet address is divided into a subnet number and a host number. The bits that identify the subnet are specified by a bit mask.

For example, if a system with an IP address of 192.168.3.1 had a netmask of 255.255.0.0, its network address would be 192.168. This would allow the system to communicate with all other systems in the same network address of 192.168 without the use of a gateway.

If the system with the IP address of 192.168.3.1 had a netmask of 255.255.255.0, its network address would be 192.168.3. This would allow the system to communicate with all other systems in the same network address of 192.168.3 without a gateway.

The netmask can determine how many systems can be on the same network address. For example, for the class B network address 172.16.0.0, Table 11-4 lists some possible subnetting scenarios that show how many systems (hosts) may be on the same network address.

*Table 11-4 Subnetting reference chart for class B addresses*

| Numbers of bits for subnet | Subnet mask   | Number of subnets | Number of hosts |
|----------------------------|---------------|-------------------|-----------------|
| 2                          | 255.255.192.0 | 2                 | 16382           |
| 3                          | 255.255.224.0 | 6                 | 8190            |

| Numbers of bits for subnet | Subnet mask     | Number of subnets | Number of hosts |
|----------------------------|-----------------|-------------------|-----------------|
| 4                          | 255.255.240.0   | 14                | 4094            |
| 5                          | 255.255.248.0   | 30                | 2046            |
| 6                          | 255.255.252.0   | 62                | 1022            |
| 7                          | 255.255.254.0   | 126               | 510             |
| 8                          | 255.255.255.0   | 254               | 254             |
| 9                          | 255.255.255.128 | 510               | 126             |
| 10                         | 255.255.255.192 | 1022              | 62              |
| 11                         | 255.255.255.224 | 2046              | 30              |
| 12                         | 255.255.255.240 | 4096              | 14              |
| 13                         | 255.255.255.248 | 8190              | 6               |
| 14                         | 255.255.255.252 | 16382             | 2               |

### 11.3.4 Problems with incorrect subnet masks

If two systems on the same network have different subnet masks, the systems will be unable to communicate with each other.

A system with the IP address 192.168.3.1 is communicating with another system with the IP address 192.168.1.2. Both have the netmask of 255.255.0.0. This places both systems on the network address of 192.168.

The network configuration of the first system with the IP address 192.168.3.1 is as follows:

```
netstat -rn
Routing tables
Destination Gateway Flags Refs Use If PMTU Exp Groups

Route Tree for Protocol Family 2 (Internet):
default 9.3.1.74 UG 0 3 tr0 - -
9.3.1/24 9.3.1.141 U 37 44175 tr0 - -
127/8 127.0.0.1 U 3 332 lo0 - -
192.168.0/16 192.168.3.1 U 0 17 en0 - -

Route Tree for Protocol Family 24 (Internet v6):
::1 ::1 UH 0 0 lo0 16896 -
ifconfig en0
```

```

en0:
flags=e080863<UP,BROADCAST,NOTRAILERS,RUNNING,SIMPLEX,MULTICAST,GROUPRT,64B
IT>
 inet 192.168.3.1 netmask 0xffff0000 broadcast 192.168.255.255
ping 192.168.1.2
PING 192.168.1.2: (192.168.1.2): 56 data bytes
64 bytes from 192.168.1.2: icmp_seq=0 ttl=255 time=1 ms
64 bytes from 192.168.1.2: icmp_seq=1 ttl=255 time=0 ms
^C
----192.168.1.2 PING Statistics----
2 packets transmitted, 2 packets received, 0% packet loss
round-trip min/avg/max = 0/0/1 ms

```

The network configuration of the second system with the IP address 192.168.1.2 is as follows:

```

netstat -rn
Routing tables
Destination Gateway Flags Refs Use If PMTU Exp Groups

Route Tree for Protocol Family 2 (Internet):
default 9.3.1.74 UG 0 13 tr0 - -
9.3.1/24 9.3.1.124 U 33 784208 tr0 - -
127/8 127.0.0.1 U 4 319 lo0 - -
192.168.0/16 192.168.1.2 U 0 4 en0 - -

Route Tree for Protocol Family 24 (Internet v6):
::1 ::1 UH 0 0 lo0 16896 -
ifconfig en0
en0:
flags=e080863<UP,BROADCAST,NOTRAILERS,RUNNING,SIMPLEX,MULTICAST,GROUPRT,64B
IT>
 inet 192.168.1.2 netmask 0xffff0000 broadcast 192.168.255.255
ping 192.168.3.1
PING 192.168.3.1: (192.168.3.1): 56 data bytes
64 bytes from 192.168.3.1: icmp_seq=0 ttl=255 time=1 ms
64 bytes from 192.168.3.1: icmp_seq=1 ttl=255 time=0 ms
^C
----192.168.3.1 PING Statistics----
2 packets transmitted, 2 packets received, 0% packet loss
round-trip min/avg/max = 0/0/1 ms

```

If the netmask definition of the machine with IP address 192.168.1.2 is changed to 255.255.255.0, that would make the network address 192.168.1 for that system. The two systems would no longer communicate, as shown by the following commands:

```

netstat -rn
Routing tables
Destination Gateway Flags Refs Use If PMTU Exp Groups

```

```

Route Tree for Protocol Family 2 (Internet):
default 9.3.1.74 UG 0 13 tr0 - -
9.3.1/24 9.3.1.124 U 34 822719 tr0 - -
127/8 127.0.0.1 U 4 319 lo0 - -
192.168.1/24 192.168.1.2 U 0 0 en0 - -

Route Tree for Protocol Family 24 (Internet v6):
::1 ::1 UH 0 0 lo0 16896 -
ifconfig en0
en0:
flags=e080863<UP,BROADCAST,NOTRAILERS,RUNNING,SIMPLEX,MULTICAST,GROUPRT,64B
IT>
 inet 192.168.1.2 netmask 0xfffff00 broadcast 192.168.1.255
ping 192.168.3.1
PING 192.168.3.1: (192.168.3.1): 56 data bytes
^C
----192.168.3.1 PING Statistics----
2 packets transmitted, 0 packets received, 100% packet loss
#

```

The network configuration of the machine with the IP address 192.168.3.1 is unchanged, but the **ping** command cannot reach the target system:

```

netstat -rn
Routing tables
Destination Gateway Flags Refs Use If PMTU Exp Groups

Route Tree for Protocol Family 2 (Internet):
default 9.3.1.74 UG 0 3 tr0 - -
9.3.1/24 9.3.1.141 U 37 44663 tr0 - -
127/8 127.0.0.1 U 3 332 lo0 - -
192.168.0/16 192.168.3.1 U 0 26 en0 - -

Route Tree for Protocol Family 24 (Internet v6):
::1 ::1 UH 0 0 lo0 16896 -
ifconfig en0
en0:
flags=e080863<UP,BROADCAST,NOTRAILERS,RUNNING,SIMPLEX,MULTICAST,GROUPRT,64BIT>
 inet 192.168.3.1 netmask 0xffff0000 broadcast 192.168.255.255
ping 192.168.1.2
PING 192.168.1.2: (192.168.1.2): 56 data bytes
^C
----192.168.1.2 PING Statistics----
4 packets transmitted, 0 packets received, 100% packet loss

```

Even if the netmask of the system with the IP address of 192.168.3.1 were changed to 255.255.255.0, the systems would still be unable to communicate directly. By changing the netmask to 255.255.255.0, the system with the IP address of 192.168.3.1 would be on the network address 192.168.3, while the system with the IP address 192.168.1.2 would be on the network address 192.168.1. These systems could, however, communicate through a gateway if available.

## 11.4 Network configuration files

There are many different configuration files used in network support. This section briefly describes some of the more important files you will encounter and modify while performing network support.

**Note:** All files in this section should have permissions of 600 and should be owned by root whenever possible. These files often contain sensitive information, and unauthorized modification of these files can lead to security exposures and risks. Most of these files will not function properly unless their permissions are set to 600.

### 11.4.1 /etc/resolv.conf

Domain name servers (DNS) allow IP addresses to be represented symbolically for ease. For example, the system with the IP address of 207.25.253.26 is named `service.software.ibm.com`.

The `/etc/resolv.conf` file has two functions. First, it indicates to a system that it should go to a specific domain name server to resolve a name. Second, it defines to the system to what domain it belongs.

For example, the system named *sample* has the following `/etc/resolv.conf` file:

```
cat /etc/resolv.conf
nameserver 9.3.1.74
domain itsc.austin.ibm.com
```

The system `sample` would use the name server 9.3.1.74 for name resolution. Since it belongs to the `itsc.austin.ibm.com` domain, the full host name of the system is `sample.itsc.austin.ibm.com`.

If the specified domain name server is unreachable, you will not be able to communicate with systems by host name and will receive errors. The `ping` command can be used to verify if a name server is unreachable.

For example, if the domain name server 9.3.1.74 is not available, it takes more than five minutes before an error message from the **ping** command is returned:

```
ping 9.3.1.121
PING 9.3.1.121: (9.3.1.121): 56 data bytes
^C
----9.3.1.121 PING Statistics----
3 packets transmitted, 0 packets received, 100% packet loss
date +%H:%M:%S
16:20:10
ping sv1166f
0821-062 ping: host name sv1166f NOT FOUND
date +%H:%M:%S
16:25:16
```

If the name server is down, however, you will still be able to communicate with other servers by IP address.

**Note:** If your name server has a host name assigned to it, do not enter this name into the nameserver field. Enter in the IP address of the name server; otherwise, your system will not be able to automatically communicate with the name server.

## 11.4.2 /etc/hosts

The /etc/hosts file provides a list of server names or aliases and their IP addresses. This file can be used for host name resolution for each defined server or server alias in the /etc/hosts file.

The following is a sample /etc/hosts file:

```
cat /etc/hosts
The format of this file is:
Internet Address Hostname # Comments
Items are separated by any number of blanks and/or tabs. A '#'
indicates the beginning of a comment; characters up to the end of the
line are not interpreted by routines which search this file. Blank
lines are allowed.

Internet Address Hostname # Comments
127.0.0.1 loopback localhost # loopback (lo0) name/address
9.3.240.57 sample2.itsc.austin.ibm.com
```

### 11.4.3 /etc/netsvc.conf

The /etc/netsvc.conf file is used to specify the ordering of name resolution services for sendmail, the gethostbyname, gethostaddr, and gethostent subroutines, in addition to alias resolution for sendmail.

When a process receives a symbolic host name and needs to resolve it into an address, it calls a resolver routine. By default, resolver routines attempt to resolve names using the following default order:

1. BIND/DNS (named, using the /etc/resolv.conf file)
2. Network Information Service (NIS)
3. Local /etc/hosts file

If all of the services were unavailable, then the resolver routine will return with the message SERVICE\_UNAVAILABLE.

This default order can be overwritten by creating the configuration file, /etc/netsvc.conf, and specifying the desired order for resolving host names. A sample /etc/netsvc.conf file is as follows:

```
#cat /etc/netsvc.conf
hosts = nis, local, bind
```

In this example, the system will use NIS to attempt to resolve host names first, followed by the /etc/hosts file, and then BIND/DNS last.

**Note:** The NSORDER environment variable will override the host name resolution list in /etc/netsvc.conf. If your /etc/netsvc.conf file does not seem to be working properly, you may want to examine the NSORDER environment variable by running the command:

```
echo $NSORDER
NSORDER=local,bind
```

### 11.4.4 \$HOME/.netrc

The \$HOME/.netrc file contains information used by the automatic login feature of the **rexec** and **ftp** commands. The \$HOME/.netrc file contains the login password for the user plain text. Even with permissions set to 600, passwords for remote systems are vulnerable to being revealed to any user with root authority.

## 11.4.5 \$HOME/.forward

When mail is sent to a local user, the `sendmail` command checks for the `$HOME/.forward` file for that user. The `$HOME/.forward` file can contain one or more addresses or aliases. Any messages are then sent to the addresses or aliases in the `$HOME/.forward` file.

## 11.4.6 /etc/hosts.equiv and \$HOME/.rhosts

The `/etc/hosts.equiv` and `$HOME/.rhosts` files define which remote hosts and users can invoke certain commands on the local system without supplying a password.

The format of the `/etc/hosts.equiv` and `$HOME/.rhosts` files is as follows:

```
[+ | -] HostName [+ | -] UserName or @NetGroup
```

**Note:** Both `/etc/hosts.equiv` and `$HOME/.rhosts` are read top to bottom, so the order of placing entries into these files can change the desired results. The deny, or - (minus sign), statements must precede the accept, or + (plus sign), statements in the lists.

For example, to allow all the users on the hosts *toaster* and *machine* to log in to the local host, you would enter:

```
toaster
machine
```

To only allow the user *ethan* to log in from the host *data*, you would enter:

```
data ethan
```

To allow the user *quin* to log in from any host, you would enter:

```
+quin
```

To deny all members from the *customers* netgroup from logging in automatically, you would enter:

```
- @customers
```

## 11.5 Exporting X-Windows and graphical applications

In AIX, it is possible to export X-Windows sessions and graphical applications to other systems through the use of the `DISPLAY` environment variable. This allows remote users to emulate a graphical console or other graphical processes on their systems.



X-Windows consists of three components: the server, client programs, and the communications channel. The server distributes user input to and accepts output requests from various client programs (applications) located either on the same machine or elsewhere on the network.

The DISPLAY environment variable is a string with the following format:

```
HostName:Number.Screen
```

where:

- HostName** Specifies the name of the host system where the display is physically attached. The host name should be followed by a : (colon).
- Number** Specifies the ID number of the display server on that host machine. The display number can be followed by a . (period).
- Screen** Specifies the number of the screen on that host server. Multiple screens can be connected to or controlled by a single X server.

By default, the DISPLAY environment variable is set to :screen#. When you log in to the graphic console, the DISPLAY environment variable is:

```
echo $DISPLAY
:0.0
```

### 11.5.1 Failing to start an X-Windows application

By default, the DISPLAY environment variable is not set when you **telnet** or **rlogin** to a remote host. An attempt to start an X-Windows application will fail if:

- ▶ The DISPLAY environment variable is not set up.
- ▶ The X-Windows server has not been started.
- ▶ The X-Windows server access control has been enabled and your remote host is not on the access control list.

Each of these conditions is discussed in the following sections.

#### The DISPLAY environment variable is not set

If you have not set your DISPLAY environment variable, you will see these messages:

```
echo $DISPLAY

aixterm
1363-008 aixterm: Cannot make a connection to X server.
 If the X server is not running, run the xinit command.
 If the X server is running, check the specified display number.
```

Note that the name of the X-Windows server is empty. Rectify this by setting up your DISPLAY environment variable.

### The X-Windows server is not started

If you have not started the X-Windows server, you will see these messages:

```
export DISPLAY='sv1166a:0'
aixterm
1363-008 aixterm: Cannot make a connection to X server sv1166a:0.
 If the X server is not running, run the xinit command.
 If the X server is running, check the specified display number.
#
```

The host name sv1166a is just an example. Replace it with the appropriate host name. Rectify this by starting the X-Windows server on your local host using the **xinit** command.

### X-Windows server access control list

If access control is enabled and the host name sv1166a is not on the access control list, you will see these messages:

```
echo $DISPLAY
sv1166a:0
aixterm
Xlib: connection to "sv1166a:0.0" refused by server
Xlib: Client is not authorized to connect to Server
1363-008 aixterm: Cannot make a connection to X server sv1166a:0.
 If the X server is not running, run the xinit command.
 If the X server is running, check the specified display number.
#
```

For AIX, rectify this from the local console on the local host by using:

► The **xhost +** command:

```
xhost +
access control disabled, clients can connect from any host
```

Do this only if it does not violate the security guideline of your company.

► The **xhost +sv1050a** command:

```
xhost +sv1050a
sv1050a being added to access control list
xhost
access control enabled, only authorized clients can connect
INET:sv1050a.itsc.austin.ibm.com
#
```

The host name of the remote host sv1050a is an example. Replace it with the appropriate host name of the remote host that you have a telnet session with. You may see other host names on the access control list.

## 11.5.2 Setting up the DISPLAY environment variable

The display name or DISPLAY environment variable is a string with the following format:

```
HostName:Number.Screen
```

Instead of using the host name, you can also use the IP address in the DISPLAY environment variable.

### Using the host name

Using the host name is more convenient. Use the **hostname** command on one of your local sessions to find out the host name to use:

```
hostname
sv1166a
```

Go back to your telnet session and set up your DISPLAY environment variable by entering:

```
export DISPLAY='sv1166a:0'
```

The screen number does not need to be specified if you have only one screen connected or controlled by the X-Windows server.

## 11.6 Advanced network configuration options

This section discusses some of the more advanced network configuration options you may configure while performing network support. This includes such topics as the ARP cache, IP forwarding, and network performance tuning.

### 11.6.1 The ARP cache

The Address Resolution Protocol (ARP) dynamically translates Internet addresses into the unique hardware addresses on local area networks. Nodes on the same segment of the same LAN use ARP to determine the hardware address of other nodes. This information is stored within the system in the ARP cache.

To display and modify ARP cache entries, use the **arp** command. The general syntax of the **arp** command for network interfaces is as follows:

```
arp [-t ifType] [-s Type | -d] HostName [AdapterAddress] [Route]
[temp] [pub]
```

Table 11-5 is a list of common command flags and their functions for the **arp** command.

*Table 11-5 Command flags for arp*

| Flag                                   | Description                                                                                                                                                                                             |
|----------------------------------------|---------------------------------------------------------------------------------------------------------------------------------------------------------------------------------------------------------|
| -a                                     | Displays all of the current ARP entries.                                                                                                                                                                |
| -d                                     | Deletes an entry for the host specified by the <i>HostName</i> variable if the user has root user authority.                                                                                            |
| -s <i>Type HostName AdapterAddress</i> | Creates an ARP entry of the type specified by the <i>Type</i> variable for the host specified by the <i>HostName</i> variable with the adapter address specified by the <i>AdapterAddress</i> variable. |
| -t <i>ifType</i>                       | Indicates the type of network interface.                                                                                                                                                                |

For example, to view the entire ARP cache, you would run:

```
arp -a
 itsorusi.itsc.austin.ibm.com (9.3.1.74) at 10:0:5a:a8:42:14 [token ring]
 sv1166a.itsc.austin.ibm.com (9.3.1.25) at 0:6:29:f0:e2:77 [token ring]
 itsonv.itsc.austin.ibm.com (9.3.1.5) at 8:0:5a:48:4a:48 [token ring]
 netcomp.itsc.austin.ibm.com (9.3.1.232) at 10:0:5a:38:fb:3 [token ring]
 jc6003a.itsc.austin.ibm.com (9.3.1.111) at 0:6:29:f0:e1:2 [token ring]
```

To delete the entry for the server jc6003a from the ARP cache, you would run:

```
arp -d jc6003a
Entry jc6003a (9.3.1.111) was deleted from local arp table.
arp -a
 itsorusi.itsc.austin.ibm.com (9.3.1.74) at 10:0:5a:a8:42:14 [token ring]
 sv1166a.itsc.austin.ibm.com (9.3.1.25) at 0:6:29:f0:e2:77 [token ring]
 itsonv.itsc.austin.ibm.com (9.3.1.5) at 8:0:5a:48:4a:48 [token ring]
 netcomp.itsc.austin.ibm.com (9.3.1.232) at 10:0:5a:38:fb:3 [token ring]
```

You can only delete one entry from the ARP cache at a time. Entries in the ARP mapping table are deleted after 20 minutes; incomplete entries are deleted after three minutes. To make a permanent entry in the ARP mapping tables, use the **arp** command with the **pub** parameter.

**Note:** Moving a network adapter from one system to another may cause network traffic to be directed to the wrong system by the ARP cache. You should either delete the ARP entry on every node in the segment at the time of the move, or ensure that at least 20 minutes have passed before you bring up the system receiving the network adapter.

## 11.6.2 Detecting network bottlenecks

A network bottleneck is the term when information is not being sent or received properly by systems on the network. Most of the time, these bottlenecks can be seen by delays in simple commands like **ping** and **traceroute**. AIX provides several tools that can identify network bottlenecks and congestion.

### Using the **spray** command to identify network bottlenecks

The **spray** command is a tool that sends a specified number of packets to a host and reports performance statistics. The **spray** command will identify how many packets were received and at what transfer rate the packets were received. The general syntax of the **spray** command is as follows:

```
spray Host [-c Count] [-d Delay] [-i] [-l Length]
```

Table 11-6 is a list of common command flags and their functions for the **spray** command.

Table 11-6 Command flags for **spray**

| Flag                           | Description                                                                                                                                                                                              |
|--------------------------------|----------------------------------------------------------------------------------------------------------------------------------------------------------------------------------------------------------|
| -c <i>Count</i>                | Specifies the number of packets to send. The default value is the number of packets required to make the total stream size 100,000 bytes.                                                                |
| -d <i>Delay</i>                | Specifies the time, in microseconds, the system pauses between sending each packet. The default is 0.                                                                                                    |
| -i                             | Uses the Internet Control Message Protocol (ICMP) echo packets rather than the RPC protocol. Since ICMP echoes automatically, it creates a two-way stream. You must be the root user to use this option. |
| -l (lowercase L) <i>Length</i> | Specifies the number of bytes in the packet that holds the RPC call message. The default value of the Length parameter is 86 bytes, the size of the RPC and UDP headers.                                 |

For example, to send 1200 packets at 2 microsecond intervals to the workstation named server2, you would run:

```
spray server2 -c 1200 -d 2
sending 1200 packets of length 86 to
server2 ...
```

```
no packets dropped by server2
20129 packets/second, 1731107 bytes/second
```

If there were high amounts of packets being dropped, or a low packets/second ratio, there could be a problem with the network.

## Using netstat for identifying network bottlenecks

The **netstat** command can also provide information for identifying network bottlenecks. By running the **netstat -i** command, the system displays cumulative statistics of errors, collisions, and packets transferred for the system. For example:

```
netstat -i
Name Mtu Network Address Ipkts Ierrs Opkts Oerrs Coll
tr0 1492 link#2 0.60.94.8a.d3.5a 1610269 0 6789 0 0
tr0 1492 9.3.240 server2 1610269 0 6789 0 0
lo0 16896 link#1 4706 0 4706 0 0
lo0 16896 127 localhost 4706 0 4706 0 0
lo0 16896 ::1 4706 0 4706 0 0
```

Errors in the Ierrs or Oerrs fields, or high amounts of collisions in the Coll field, can indicate possible network bottlenecks.

However, the **netstat -i** output displays cumulative information for the system since it was last booted. If the system has been up for a long period of time, this information may not be useful for identifying network bottlenecks as high amounts of errors or collisions may have been from events that happened long ago. To clear the interface statistics, run the **netstat -Zi** command.

**Note:** The **netstat -i** command does not display the collision count for Ethernet interfaces.

## Using topas for identifying network bottlenecks

The **topas** command can also provide information about network bottlenecks by monitoring the amount of information going through network interfaces in a realtime format.

To enable realtime monitoring of network information only, run the command:

```
topas -d0 -i0 -p0
```

This will create an output screen similar to Figure 11-10.

```

Topas Monitor for host: server1 EVENTS/QUEUES FILE/TTY
Mon Sep 10 14:22:27 2001 Interval: 0 Cswitch 58 Readch 18007
 Syscall 204 Writech 451
Kernel 0.2 | Reads 50 Rawin 0
User 0.2 | Writes 2 Ttyout 0
Wait 0.0 | Forks 0 Igets 0
Idle 99.5 |#####| Execs 0 Namei 1
 Runqueue 0.0 Dirblk 0
Network KBPS I-Pack O-Pack KB-In KB-Out Waitqueue 0.0
tr0 3.5 14.0 13.0 1.4 2.1
en0 0.0 0.0 0.0 0.0 0.0
lo0 0.0 0.0 0.0 0.0 0.0
 PAGING MEMORY
 Faults 0 Real,MB 511
 Steals 0 % Comp 32.3
 Pgspln 0 % Noncomp 67.9
 Pgsplout 0 % Client 0.5
 PageIn 0
 PageOut 0 PAGING SPACE
 Sios 0 Size,MB 512
 % Used 2.3
 NFS (calls/sec) % Free 97.6
 ServerV2 0
 ClientV2 0 Press:
 ServerV3 0 "h" for help
 ClientV3 0 "q" to quit

```

Figure 11-10 Network monitoring by topas

By observing the various fields, including KBPS, KB In, and KB Out, you can determine if a bottleneck is occurring on a particular interface.

### 11.6.3 The no command

The **no** command configures and displays network attributes in the current kernel. The **no** command can be used for the tuning of various network attributes to increase network performance and throughput.

The syntax for the **no** command is as follows:

```
no { -a | -d Attribute | -o Attribute [=NewValue] }
```

Table 11-7 is a list of command flags and their functions for the **no** command.

Table 11-7 Command flags for no

| Flag                | Description                                                            |
|---------------------|------------------------------------------------------------------------|
| -a                  | Prints a list of all configurable attributes and their current values. |
| -d <i>Attribute</i> | Sets <i>Attribute</i> back to its default value.                       |

| Flag                                        | Description                                                                                                                                                                                                                                 |
|---------------------------------------------|---------------------------------------------------------------------------------------------------------------------------------------------------------------------------------------------------------------------------------------------|
| -o <i>Attribute</i><br>[= <i>NewValue</i> ] | Displays the value of <i>Attribute</i> if <i>NewValue</i> is not specified; otherwise, this flag sets <i>Attribute</i> to <i>NewValue</i> . Do not enter space characters before or after the equal sign; otherwise, the command will fail. |

The following sections detail common functions and parameters that you can use the **no** command to modify.

**Note:** Use this command with caution. The **no** command performs no range checking, therefore it accepts all values for the variables. If used incorrectly, the **no** command can cause your system to become inoperable.

Changes made by the **no** command only affect the current kernel. The **no** command must be run again after each startup or after the network has been configured.

## IP forwarding

If there are multiple network adapters in a system that are assigned to two or more networks, the **no** command can allow IP packets to be forwarded across the system, causing the system to act as a gateway for IP packets. To enable IP forwarding, run the command:

```
no -o ipforwarding=1
```

For example, if you have a system with a token ring card that has an IP address of 9.3.1.124, on the 9.3.1 subnet, and another token ring card that has an IP address of 192.168.1.3, on the 192.168.1 subnet, IP forwarding will allow packets to flow from the 9.3.1 network to the 192.168.1 network and back.

**Note:** IP forwarding will be reset to the default zero (0) value after a system reboot. To enable IP forwarding at system reboot, you must add this command to a script that is run at boot time.

## Route revalidation

Route revalidation specifies that each connection's cached route should be revalidated each time a new route is added to the routing table. This will ensure that applications that keep the same connection open for long periods of time (for example NFS) will use the correct route after routing table changes occur. To enable route revalidation, run the command:

```
no -o routerevalidation=1
```



Turning this option on may cause some performance degradation.

## 11.6.4 Network tuning

The following describes various facets of network tuning to allow for better performance:

### Network traffic and thewall

To avoid fragmentation of kernel memory, common buffer pools are shared by the various layers of the communication subsystem. The mbuf management facility controls two pools of buffers: a pool of small buffers (256 bytes each), which are simply called mbufs, and a pool of large buffers (4096 bytes each), which are usually called mbuf clusters, or just clusters. The pools are created from system memory by making an allocation request to the Virtual Memory Manager (VMM).

The pools consist of pinned pieces of virtual memory; this means that they always reside in physical memory and are never paged out. The result is that the real memory available for paging in application programs and data has been decreased by the amount that the mbuf pools have been increased. On the other hand, network problems will arise if there is not enough memory available for the buffer pools to satisfy network sessions.

The maximum amount of memory, in kilobytes, allocated to the mbuf pools is specified in the *thewall* parameter of the **no** command. The default values for thewall in various AIX versions are:

- ▶ AIX Version 4.2.1. and earlier  
The default value is 1/8 of real memory or 65536 (64 megabytes), whichever is smaller.
- ▶ AIX Version 4.3.0  
The default value is 1/8 of real memory or 131072 (128 megabytes), whichever is smaller.
- ▶ AIX Version 4.3.1 and later  
The default value is 1/2 of real memory or 131072 (128 megabytes), whichever is smaller.

### Modifying thewall to raise the number of mbufs

The initial default value of thewall can be determined by running the command:

```
no -o thewall
thewall = 65488
```

The **netstat -m** command will display memory management routines statistics:

```
netstat -m
Kernel malloc statistics:

***** CPU 0 *****
By size inuse calls failed free hiwat freed
32 163 313 0 93 640 0
64 88 158 0 40 320 0
128 71 316 0 25 160 0
256 99 2726 0 13 384 0
512 76 375 0 4 40 0
1024 32 104 0 4 100 0
2048 0 4 0 2 100 0
4096 35 68 0 3 120 0
16384 1 1 0 18 24 7
32768 1 1 0 0 511 0

By type inuse calls failed memuse memmax mapb
```

```
Streams mblk statistic failures:
0 high priority mblk failures
0 medium priority mblk failures
0 low priority mblk failures
```

To increase the value of thewall from 65488 to 98232 to allow for more mbufs, run the command:

```
no -o thewall=98232
```

The change takes effect immediately for new connections. However, there will not be any change to the kernel malloc statistics until some network traffic has occurred. Performing a task, such as using an FTP session to transfer some files from another system, will update the kernel malloc statistics. The **netstat -m** command then shows the change in mbufs:

```
netstat -m
Kernel malloc statistics:

***** CPU 0 *****
By size inuse calls failed free hiwat freed
32 163 321 0 93 640 0
64 88 160 0 40 320 0
128 71 355 0 25 160 0
256 99 16439 0 29 384 0
512 76 662 0 4 40 0
1024 32 120 0 4 100 0
2048 0 7858 0 12 100 0
4096 35 68 0 1 120 0
16384 1 1 0 18 24 7
32768 1 1 0 0 511 0
```

```
By type inuse calls failed memuse memmax mapb
```

```
Streams mblk statistic failures:
0 high priority mblk failures
0 medium priority mblk failures
0 low priority mblk failures
```

The number of 256-byte mbufs has increased from 112 to 128. The number of 2048-byte mbufs has increased from 2 to 12. However, the number of 4096-byte mbufs has decreased from 38 to 36. Overall, there is an increase of mbufs available when the `thewall` value is raised. The decrease in the number of 4096-byte mbufs is a result the self-tuning function from the mbuf allocation mechanism implemented in AIX Version 4.

## Other tuning parameters

The following is a list of other tuning parameters that can be modified for network performance:

### ► sockthresh

In AIX Version 4.3.1 or later, the `sockthresh` parameter provides a way to prevent new sockets from being created when almost all the network memory is in use. The default is 85 percent of `thewall`. To change this value, run the command:

```
no -o sockthresh=Percentage
```

Usually, this percentage is decreased during tuning.

### ► sb\_max

The `sb_max` parameter provides an absolute upper bound on the size of TCP and UDP socket buffers. The default value is 65536. To change this value (preferably in multiples of 4096), run the command:

```
no -o sb_max=Value
```

Usually, the size is increased during tuning.

### ► tcp\_sendspace

The `tcp_sendspace` parameter provides the default value of the size of the TCP socket send buffer. The default value is 16384. The allowed range is 0 to 64 KB. The value must be less than or equal to `sb_max`, should be equal to `tcp_recvspace`, and uniform on all frequently accessed AIX systems. To change this value (preferably in multiples of 4096), run the command:

```
no -o tcp_sendspace=Value
```

Usually, the size is increased during tuning to fix poor-throughout problems.

► tcp\_recvspace

The `tcp_recvspace` parameter provides the default value of the size of the TCP socket receive buffer. The default value is 16384. The allowed range is 0 to 64 KB. The value must be less than or equal to `sb_max`, should be equal to `tcp_sendspace`, and uniform on all frequently accessed AIX systems. To change this value (preferably in multiples of 4096), run the command:

```
no -o tcp_recvspace=Value
```

Usually, the size is increased during tuning to fix poor-throughout problems.

► rfc1323

The `rfc1323` parameter enables TCP enhancements, allowing the `tcp_sendspace` and `tcp_recvspace` values to exceed the 64 KB limit up to 4 GB. To enable TCP enhancements, run the command:

```
no -o rfc1323=1
```

Run this command before attempting to set `tcp_sendspace` and `tcp_recvspace` to more than 64 KB.

► udp\_sendspace

The `udp_sendspace` parameter provides the default value for the size of the UDP socket send buffer. The value must not be greater than that of `sb_max`. The default value is 9216. The allowed range is 0 (zero) to 65536. To change this value (preferably in multiples of 4096), run the command:

```
no -o udp_sendspace=Value
```

Usually, the size is increased during tuning.

► udp\_recvspace

The `udp_recvspace` parameter provides the default value of the size of the UDP socket receive buffer. The value must not be greater than that of `sb_max`. The default value is 41600. To change this value (preferably in multiples of 4096), run the command:

```
no -o udp_recvspace=Value
```

Usually, the size is increased during tuning.

► tcp\_pmtu\_discover

Enables or disables path MTU discovery for TCP applications. Path MTU discovery prevents packet fragmentation by looking on the network for the smallest MTU packet size in use. In AIX Version 4.3.3 and later, this feature is enabled (1) by default. To change this value, run the command:

```
no -o tcp_pmtu_discover=Value
```

This setting should be enabled to prevent packet fragmentation.

▶ `udp_pmtu_discover`

Enables or disables path MTU discovery for UDP applications. Path MTU discovery prevents packet fragmentation by looking on the network for the smallest MTU packet size in use. UDP applications must be specifically written to utilize path MTU discovery. In AIX Version 4.3.3 and later, this feature is enabled (1) by default. To change this value, run the command:

```
no -o tcp_pmtu_discover=Value
```

This setting should be enabled to prevent packet fragmentation.

▶ `arptab_nb`

The `arptab_nb` parameter specifies the number of ARP table buckets available. The default value is 25. To change this value, run the command:

```
no -o arptab_nb=Value
```

This value is altered during tuning, depending on the amount of local systems listed in the ARP tables.

▶ `ipqmaxlen`

The `ipqmaxlen` parameter specifies the maximum number of entries on the IP input queue. The default value is 50. To change this value, run the command:

```
no -o ipqmaxlen=Value
```

Usually, the size is increased during tuning.

▶ `xmt_que_size`

The `xmt_que_size` parameter specifies the maximum number of send buffers that can be queued up for the device. The default value is 30. The allowed range is 20 to 150. To display the value of the first token-ring adapter on the system, use the `lsattr -E -l tok0 -a xmt_que_size` command. To change the value, you must first remove the network interface configuration, change the device `xmt_que_size` value, and then activate the network interface configuration:

```
ifconfig tr0 detach
chdev -l tok0 -a xmt_que_size=newvalue
ifconfig tr0 hostname up
```

The change is effective across system boot. Usually, the size is increased during tuning. It should be set to 150 as a matter of course on network-oriented systems, especially servers.

► `rec_que_size`

This is only tunable in AIX Version 3. The `rec_que_size` specifies the maximum number of receive buffers that can be queued up for the interface. The default value is 30. The allowed range is 20 to 150. To display the value of the first token ring adapter in the system, use the `lsattr -E -l tok0 -a rec_que_size` command. To change the value, you must first remove the network interface configuration, change the device `xmt_que_size` value, and then activate the network interface configuration:

```
ifconfig tr0 detach
chdev -l tok0 -a rec_que_size=newvalue
ifconfig tr0 hostname up
```

The change is effective across system boot. Usually, the size is increased during tuning. It should be set to 150 as a matter of course on network-oriented systems, especially servers.

## 11.7 Quiz

The following certification assessment questions help verify your understanding of the topics discussed in this chapter.

1. Which of the following must be performed in order to change the primary name server a system is pointing to?
  - A. Run `ypwhich`.
  - B. Edit the `/etc/hosts`.
  - C. Edit the `/etc/resolv.conf` file.
  - D. Run `no -o name_server=<new_server>`.

2. The system administrator notices a system with the routing shown below:  
cannot communicate with a system with an ipaddress 192.24.34.6

What is the most likely explanation?

```
netstat -rn
Routing tables
Destination Gateway Flags Refs Use If PMTU Exp
Groups

Route tree for Protocol Family 2 (Internet):
19.3.252.192/26 19.3.252.228 U 3 96 en0 - -
127/8 127.0.0.1 U 1 180 lo0 - -
192.168.0.2 192.168.0.1 UH 0 0 sl0 - -
192.168.0.4 192.168.0.3 UH 0 0 sl1 - -

Route tree for Protocol Family 24 (Internet v6):
::1 ::1 UH 0 0 lo0 16896
```

- A. The named is not running.  
B. Default gateway is not set.  
C. The NIS master server is down.  
D. The en0 has incorrect subnet mask.
3. What is the correct syntax to add a default route using the **route** command?
- A. **route add 0 193.46.34.5**  
B. **route default add 193.46.34.5**  
C. **route add 127.0.0.1 193.46.34.5**  
D. **route add -net 193.46.34.0 193.46.34.5**
4. What type of protocol or protocols should be used by the **spray** command, by default, to send a one-way stream of packets to the host?
- A. UDP  
B. TCP  
C. ICMP  
D. RPC, UDP

5. A user on system sys01 rlogins to system sys05 and attempts to run an X-Windows based application and receives the error message unable to open display. What should the user do to resolve this problem?
- A. Type **export DISPLAY=sys01:0** on sys01.
  - B. Type **export DISPLAY=sys01:0** on sys05.
  - C. Type **export DISPLAY=sys05:0** on sys01.
  - D. Type **export DISPLAY=sys05:0** on sys05.

The following are additional questions created by the authors to further test your understanding of the topics.

1. A system administrator has just moved an Ethernet adapter to another slot, removed the old definition, and added the IP address and subnet mask just as before. The **netstat** and **ifconfig** commands show the interface just as before, but the system administrator still cannot communicate with any other servers. Which of the following could cause this problem?
- A. The connector type has changed to BNC.
  - B. The adapter speed has changed to 10 Mbps.
  - C. The adapter should be removed and reseated.
  - D. The drivers were not reloaded after moving the adapter.
2. A system administrator is able to log in to system A's console and other systems can **ping** system A, but the system administrator is unable to Telnet or **rlogin** to system A from any other system on the network. Which of the following is the most likely cause of this problem?
- A. The inetd is not running on system A.
  - B. The routed is not running on system A.
  - C. The routing table on system A is corrupted.
  - D. The domain name server is not functioning correctly.
3. User X on machine AAA is trying to **rsh** to machine BBB. The user is prompted for a password, even though a /u/X/.rhosts file is configured on machine BBB. The user discovers this is a permission problem with the .rhosts file. Which of the following are the correct permissions of a .rhosts file?
- A. 400
  - B. 440
  - C. 600
  - D. 660



4. A system administrator is logged onto the local system, Carolina, and creates a **telnet** session on a remote system, Florida, to remotely start any application. The following error message is displayed:

```
cannot open DISPLAY:
```

The system administrator proceeds to enter the following command in response to the error message:

```
export DISPLAY=carolina.domain001.com:0.0
```

The system administrator re starts the application and receives the same error message:

```
cannot open DISPLAY
```

The system administrator echoes the DISPLAY variable, determines that it is set to carolina.domain001.com, and performs an **nslookup** of Carolina, which returns a good TCP/IP address of 9.90.90.9, as expected. The system administrator loaded both servers and knows that the graphics subsystem is properly installed on both systems and is started at boot time.

The system administrator exports the DISPLAY variable from Florida to Carolina, and still cannot connect. What should be the next logical step?

- A. Issue the **netstat -i** command to check the network.
- B. From Carolina, issue the **lshost** command to see if Florida is allowed host access.
- C. From Carolina, issue the **xhost list** command to see if Florida is allowed host access and if not, issue the **xhost add Florida** command.
- D. From Carolina, issue the **xhost** command to see if Florida is allowed host access and if not, from Carolina, issue the **xhost + Florida** command.

## 11.7.1 Answers

The following answers are for the assessment quiz questions.

1. C
2. B
3. A
4. D
5. B

The following answers are for the additional quiz questions.

1. A
2. A
3. C
4. D

## 11.8 Exercises

The following exercises provide sample topics for self study. They will help ensure comprehension of this chapter.

1. **rlogin** to another system and run an X application. Set the DISPLAY variable using both host name and IP address to prevent the unable to open DISPLAY error message. Compare the error message with that caused by **xhost** error.
2. Experiment with the **xhost** command to allow and disallow an X-Windows application client to connect to the host.
3. Explain the security implication for the **.rhost**, **.netrc**, **.forward**, and **hosts.equiv** files.
4. Experiment with the content and permission bits of the **\$HOME/.rhosts** file to show the effect on an **rsh** session from another host.
5. Using a test system that does not affect any user, remove a network adapter.
6. Set the value of the IP forwarding attribute of the network option to something other than 0 (zero) and 1 (one) to show that IP forwarding is enabled if the value of the parameter is set to other than 0 (zero).
7. If possible, test the value of the **ipforwarding** parameter of the network option to allow pings over multiple subnets on two interface boxes.
8. On a test system that does not affect any user, change the reference to the primary name server by editing the **/etc/resolv.conf** file. Observe the result when you try to access other hosts by host name and by IP addresses.

9. On a test system that does not affect any user, change the name resolution default order by editing the `/etc/netsvc.conf` file, so that `/etc/hosts` file will be used before the domain name server. Add an entry to the `/etc/hosts` file, so that the host name of a system has a different IP address and then try to access that host name.
10. Set the value of the `NSORDER` environment value to override the `/etc/netsvc.conf` file.
11. Use the `arp` command to display, delete, and add entries in the ARP cache.
12. On a test system that does not affect any user, change the state of the network interface from active to inactive and observe the results. Remove the network interface and observe the result.
13. Add the network interface back in and make it active again. Perform additional tasks to bring the network back into operation.
14. On a test system that does not affect any user, flush the routing table and try to access hosts on the same and different subnet.
15. On a test system that does not affect any user, change the subnet mask to different values and check if it can still communicate with other hosts.
16. On a test system that does not affect any user, change the `thewall` value and observe the effect on the buffer pools over a period of time.
17. On a test system that does not affect any user, set the value of various tunable parameters of the network option and observe the result over a period of time.
18. On a test system that does not affect any user, stop the `inetd` daemon and `telnet` to other systems. Ping this test system from another host and try to `telnet` to it. Observe the result.
19. On a test system that does not affect any user, change the token ring speed of a token-ring network adapter, or change the connection type of an Ethernet network adapter and observe the result.





# Printers

This chapter covers printing and common support procedures involved in ensuring an AIX printer, whether remotely or locally, remains operational. You are guided through problem determination and troubleshooting of printer problems.

## 12.1 The printer colon files

Printer and printer data stream attributes reside in *colon* files. Colon files reside in the `/usr/lib/lpd/pio/predef` and `/var/spool/lpd/pio/@local/custom/*` directories. The `/usr/lib/lpd/pio/predef` directory contains the predefined database and the `/var/spool/lpd/pio/@local/custom/*` directory contains the customized database.

## 12.2 Remote printing

Remote printing allows different computers to share printers. To use remote printing facilities, the computers must be connected using the Transmission Control Protocol/Internet Protocol (TCP/IP) protocol and must support the required TCP/IP applications, such as the `lpd` daemon.

Figure 12-1 on page 313 shows the logic flow of a remote printer request.

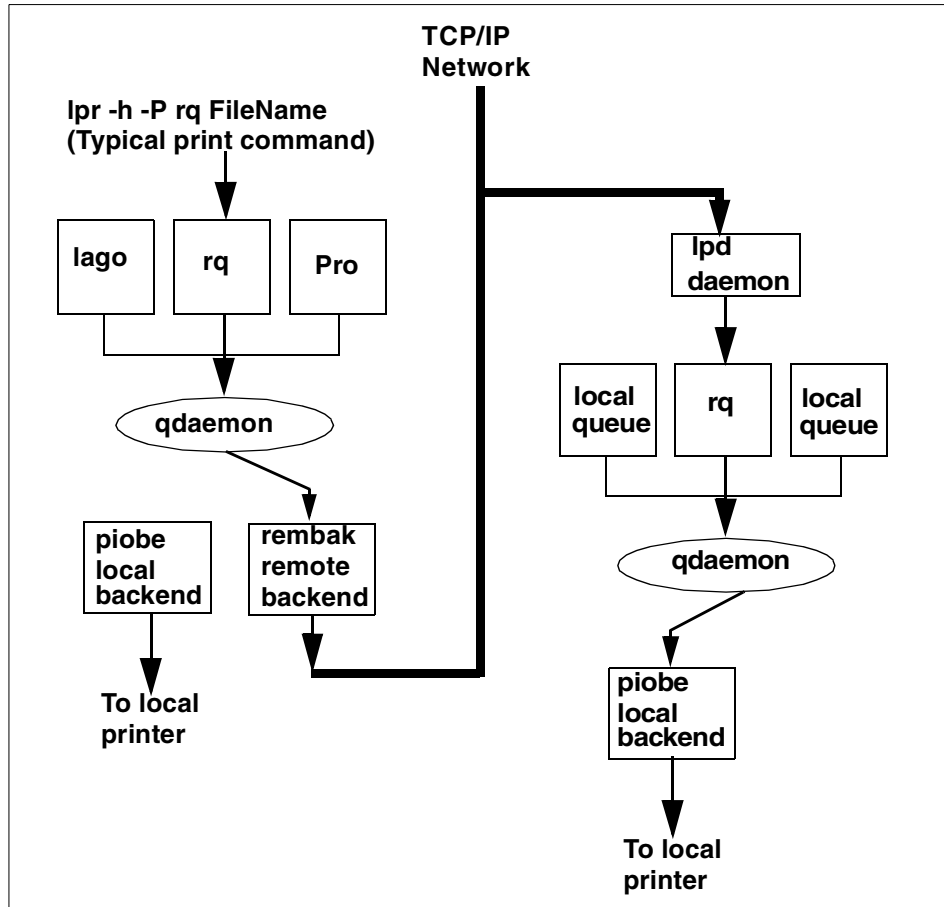

Figure 12-1 Remote print request

The `/etc/hosts.lpd` file, one of the important files in remote printing, is discussed in the following section.

### 12.2.1 The `/etc/hosts.lpd` file

The `/etc/hosts.lpd` file defines which remote systems are permitted to print on the local system. The remote systems listed in this file do not have the full privileges given to files listed in the `/etc/hosts.equiv` file.

The `hosts.lpd` file supports the following host name entries:

- + Signifies that any host on the network can print using the local host.

|                   |                                                                                     |
|-------------------|-------------------------------------------------------------------------------------|
| <b>HostName</b>   | The name of a remote host; signifies that HostName can print, using the local host. |
| <b>-HostName</b>  | Signifies the host is not allowed to print using the local host.                    |
| <b>+@NetGroup</b> | Signifies all hosts in the netgroup are allowed to print using the local host.      |
| <b>-@NetGroup</b> | Signifies that no hosts in the netgroup are allowed to print using the local host.  |

Entries in this file can be made using the System Management Interface Tool (SMIT) or the **ruser** command.

**Note:** Comments must be entered on separate lines in the hosts.lpd file. Comments should not be entered on lines containing host names.

To implement hosts.lpd file changes without restarting the system, use the System Resource Controller (SRC) **refresh** command.

## 12.2.2 Controlling the lpd daemon

Controlling the lpd daemon includes starting and stopping the lpd subsystem and changing the characteristics of the lpd subsystem. Use the SMIT or System Resource Controller (SRC) commands to control the lpd daemon.

There are three ways to start the lpd daemon. If it is not currently running, you can start the daemon at any time. You also have the option of having the lpd daemon start at system restart or to have it start both at the current time and at system restart. The same options are available to stop the lpd daemon: stop now, stop at system restart, or stop both now and at system restart. You can run the lpd daemon with DEBUG, SYSLOG, both DEBUG and SYSLOG, or with neither.

To control the lpd daemon with SMIT, type **smitty lpd**, then select the desired options from the SMIT menus. To control the lpd daemon with the SRC, use the following SRC commands:

|                 |                                                                                           |
|-----------------|-------------------------------------------------------------------------------------------|
| <b>startsrc</b> | Starts a subsystem, group of subsystems, or a subserver.                                  |
| <b>stopsrc</b>  | Stops a subsystem, group of subsystems, or a subserver.                                   |
| <b>lssrc</b>    | Gets the status of a subsystem, group of subsystems, or a subserver.                      |
| <b>refresh</b>  | Causes the subsystem or group of subsystems to reread the appropriate configuration file. |



|                  |                                                                       |
|------------------|-----------------------------------------------------------------------|
| <b>traceson</b>  | Enables tracing of a subsystem, group of subsystems, or a subserver.  |
| <b>tracesoff</b> | Disables tracing of a subsystem, group of subsystems, or a subserver. |

## 12.3 Virtual printers

Virtual printers are unique to AIX, but have a heritage in UNIX called *printcap files*. They basically add commands to set up a printer to perform certain operations and then provide simple formatting for ASCII text. They are not an API. They are a set of attributes that control what gets sent to the printer as setup commands before and after the print job. Virtual printers also do simple text formatting, such as adding carriage returns to line feeds.

### 12.3.1 Files used with virtual printers

The following files are important when looking at virtual printers:

|                                           |                                                      |
|-------------------------------------------|------------------------------------------------------|
| <b>/usr/sbin/mkvirprt</b>                 | Contains the <b>mkvirprt</b> command.                |
| <b>/etc/qconfig</b>                       | Contains configuration files.                        |
| <b>/usr/lib/lpd/pio/predef/*</b>          | Contains predefined printer attribute files.         |
| <b>/var/spool/lpd/pio/@local/custom/*</b> | Contains customized virtual printer attribute files. |
| <b>/usr/lib/lpd/pio/etc/*.attach</b>      | Contains attachment type files.                      |
| <b>/usr/lib/lpd/pio/etc/*.config</b>      | Contains the configuration file for the printer.     |
| <b>/var/spool/lpd/pio/@local/ddi*</b>     | Contains digested virtual printer attribute files.   |

### 12.3.2 Key commands

Some of the virtual printer commands are:

|                    |                                                                                                                    |
|--------------------|--------------------------------------------------------------------------------------------------------------------|
| <b>smitty mkpq</b> | Command to add a virtual printer. Also adds printer device.                                                        |
| <b>smitty chpq</b> | Command to change a virtual printer.                                                                               |
| <b>smitty rmpq</b> | Command to remove a virtual printer.                                                                               |
| <b>lsvirprt</b>    | Command to change individual attributes of virtual printer. Also used to list all attributes of a virtual printer. |

**smitty chvirprt**      Change a virtual printer attribute.

**Note:** Virtual Printers do not support graphics, except to pass it through to a printer.

A virtual printer is actually a fairly simple interface to a printer. It basically performs these functions:

1. Initializes the printer.
2. Provides a hook or interface to filters.
3. Formats ASCII data.
4. Translates from the input code page to the output printer symbol set (ASCII only).
5. Resets the printer to a predefined condition.
6. Calls the program to send the header and trailer pages.
7. Sends a form feed at the end of job.
8. Consumes some file space, such as /tmp.

Virtual Printers do not:

1. Generate any printer language commands, such as PostScript or PCL, other than the initialization and reset sequences.
2. Test for correctness of the format of data.
3. Automatically recognize the type of data, except for very simple sniffing of the first couple of characters, if set up properly.

Therefore, the virtual printer does almost nothing for any formatted PCL, formatted PPDS, graphics, or PostScript data, except tell the printer what language is incoming.

### 12.3.3 Creating a virtual printer

A virtual printer can be created using the **mkvirprt** command in AIX Version 3.2.5 or using the System Management Interface Tools (SMIT) fast path **smitty mkpq** in AIX Version 4. For this discussion, AIX Version 4 commands are used.

## Using the smitty mkpq command

The command `smitty mkpq` produces a screen similar to that shown in Figure 12-2.

```

 Add a Print Queue

Move cursor to desired item and press Enter. Use arrow keys to scroll.

ATTACHMENT TYPE DESCRIPTION
local Printer Attached to Local Host
remote Printer Attached to Remote Host
xstation Printer Attached to Xstation
ascii Printer Attached to ASCII Terminal
hpJetDirect Network Printer (HP JetDirect)
file File (in /dev directory)
ibmNetPrinter IBM Network Printer
ibmNetColor IBM Network Color Printer
other User Defined Backend

F1=Help F2=Refresh F3=Cancel
F8=Image F10=Exit Enter=Do
/=Find n=Find Next
```

Figure 12-2 `smitty mkpq` command screen

Perform the following steps:

1. Select attachment type `remote`, as not highlighted in Figure 12-2.
2. Select your preferred Type of Remote Printing. For this example, it is Standard processing.
3. Fill in the characteristics for the virtual printer being created, as shown in Figure 12-3 on page 318, and press the Enter key. After the Command: OK returns, exit SMIT and complete the process.

```

Add a Standard Remote Print Queue

Type or select values in entry fields.
Press Enter AFTER making all desired changes.

 [Entry Fields]
* Name of QUEUE to add [virprt1]
* HOSTNAME of remote server [sv1166f]
* Name of QUEUE on remote server [final]
Type of print spooler on remote server AIX Version 3 or 4 +
Backend TIME OUT period (minutes) [] #
Send control file first? no +
To turn on debugging, specify output []
 file pathname
DESCRIPTION of printer on remote server []

F1=Help F2=Refresh F3=Cancel F4=List
F5=Reset F6=Command F7=Edit F8=Image
F9=Shell F10=Exit Enter=Do

```

Figure 12-3 Add a Standard Remote Print Queue screen

You will now use the `lsvirprt` command to list the virtual printers on the system. The command `lsvirprt` without flags produces a menu, as in Figure 12-4, from which you can view and change the attributes of the virtual printer.

```

No. Queue Device Description
1 virprt1 @sv1166f Remote Printer

Enter number from list above (press Enter to terminate): -> █

```

Figure 12-4 `lsvirprt` command output screen

Using the **smitty chvirprt** command change attributes of the virtual printer. This command produces the screen in Figure 12-5. From this screen, you can supply the virtual printer queue, in this case `virprt1`, and then proceed to change the desired attributes for the virtual printer.

```
Print Queue to Change / Show

Type or select a value for the entry field.
Press Enter AFTER making all desired changes.

PRINT QUEUE name [Entry Fields]
 [virprt1] +

F1=Help F2=Refresh F3=Cancel F4=List
F5=Reset F6=Command F7=Edit F8=Image
F9=Shell F10=Exit Enter=Do
```

Figure 12-5 `smitty chvirprt` command screen

## 12.4 Troubleshooting remote printing problems

Trying to find out why print jobs from a remote client get lost on the way to a server can be a frustrating problem. In this section, some common errors, as well as how to trace a job sent by a remote client using the `iptrace` facility, are discussed.

### 12.4.1 0781-374 error message

If you attempt to send a print job to a remote print server whose `lpd` daemon is down, you will receive the following message:

```
0781-374 Connection to server timed out after retrying
rembak:errno=79: A remote host refused an attempted connect operation
```



## 12.4.3 How to run a remote trace

The question, "What is getting sent to the remote system when I print?" can be answered by using remote trace.

### What an iptrace can tell you

The following list contains what an iptrace can tell you:

- ▶ Characters actually sent over the network, even binary control characters.
- ▶ Responses that come from the LPD.
- ▶ Content of the control file.
- ▶ Which side terminated the conversation.
- ▶ Status information being sent back by the LPD.
- ▶ If the entire file gets sent to the LPD.
- ▶ If the control files follow the RFC-1179 standard.

### Using the iptrace facility

The iptrace facility can easily show what is being sent to the remote system using the following command:

```
iptrace -p printer -a -b -s source_host -d dest_host /tmp/trace.out
```

Table 12-1 provides the **iptrace** command flags.

Table 12-1 *Flags for the iptrace command*

| Flag              | Description                                                                                                                                                                   |
|-------------------|-------------------------------------------------------------------------------------------------------------------------------------------------------------------------------|
| -p <i>printer</i> | Use the word printer or a number such as 515, which means look at port 515 only. This will not get logon traffic.                                                             |
| -a                | Suppresses ARP packets.                                                                                                                                                       |
| -i <i>en0</i>     | Interface. Only use if multiple network cards are in the system.                                                                                                              |
| -b                | Change the -d and -s to bidirectional mode. Get data in both directions.                                                                                                      |
| -s                | Source hostname, or ipaddress where the <b>print</b> command is issued.                                                                                                       |
| -d                | Destination hostname, or ipaddress where the printer resides.                                                                                                                 |
| /tmp/trace.out    | This can be any file name. It is created with 11 bytes and then will get filled with data. It is a binary file that must later be formatted with the <b>ipreport</b> command. |

Print the job to the remote queue using the following command:

```
enq -Pqueue_name filename
```

or use:

```
lpstat -vqueue_name
```

Check to see if the file has grown using `ls -l /tmp/trace.out`:

```
ls -l /tmp/trace.out
-rw-r--r-- 1 root system 4538 Nov 09 11:17 /tmp/trace.out
```

If it is still 11 bytes, then you have made an error in the command. Use the `kill` command and end the process, then start again. Get the job ID using the command:

```
ps -ef |grep ipt
root 30984 1 0 11:17:47 - 0:00 iptrace -p printer -a -b -s sv1051c
-d sv1166f /tmp/trace.out
root 31234 26556 1 11:20:46 pts/10 0:00 grep ipt
```

Kill the `trace` command using the command:

```
kill -9 job_id
```

Format the output into a text file:

```
ipreport /tmp/trace.out > /tmp/report.out
```

The report contains three or four parts for each packet of data. These are:

- ▶ MAC header
- ▶ IP header
- ▶ TCP header
- ▶ b>data (If to/from application layer, that is, if FLAG=PUSH)

### How to interpret the trace

The MAC header does not supply much information useful to debugging printing.

The IP header gives the direction of the data flow and the number of bytes in the packet, but direction is also given in the TCP packet.

The TCP packet gives the:

- ▶ Direction of packet source port.
- ▶ Handshaking and purpose of packet flags.



- ▶ Source port number. This is important because of the multi-tasking environment. Packets from a status can be interspersed with packets from a print job, but for a single job the source port will remain the same.
- ▶ Packet identification. Use `th_seq` and `th_ack` to make sure the packets are in order, and to see which packet an ACK is responding to.
- ▶ Window size `th_win`. The data packet shows the actual data that is sent back and forth.

The data packets contain queue names, command information, actual data to be printed, print flags, and error messages from the remote system `lpd`. It often simplifies the reading of the data to extract the data from the packets. All data lines of importance begin with at least four zeros. You can search for the data by looking for these zeros, as follows:

```
grep 0000 /tmp/report.out > /tmp/datasent.out
```

The size of this file will largely depend upon the size of the data file being printed. For this reason, start with a small file. A useful command is:

```
echo "AAAAA" | qprt -Pqueue_name
```

This command output appears in the `grep` output as:

```
...
00000000 41414141 410a |AAAAA. |
...

```

You will notice that the data is divided into three columns. These are:

- ▶ Column 1, a character count, prior to the current line
- ▶ Column 2, the data in HEX
- ▶ Column 3, the data in ASCII, with periods for non-printable characters

A PostScript output might look something like this:

| !data    | hex equivalent of the characters sent to the remote host | ASCII equiv. of the characters. |
|----------|----------------------------------------------------------|---------------------------------|
| !byte in |                                                          |                                 |
| !packet  |                                                          |                                 |
| 00000000 | 020405ac                                                 | ....                            |
| 00000000 | 020405ac                                                 | ....                            |
| 00000000 | 0266696e 616c0a                                          | .final.                         |
| 00000000 | 00                                                       | .                               |
| 00000000 | 03313033 20646641 31303137 73763130                      | .103 dfA1017sv10                |
| 00000010 | 3531630a                                                 | 51c.                            |
| 00000000 | 00                                                       | .                               |
| 00000000 | 53746172 74207465 7374696e 670a5468                      | Start testing.Th                |
| 00000010 | 69732069 73206120 74657374 20707269                      | is is a test pri                |
| 00000020 | 6e74206a 6f622e0a 4920616d 20757369                      | nt job..I am usi                |

```

00000030 6e672069 70747261 63652074 6f207472 |ng iptrace to tr
00000040 61636520 72656d6f 74652070 72696e74 |ace remote print
00000050 206a6f62 732e0a46 696e6973 68207465 | jobs..Finish te
00000060 7374696e 672e0a | sting..
00000000 00 |.
00000000 00 |.
00000000 02313038 20636641 31303137 73763130 |.108 cfA1017sv10
00000010 3531630a |51c.
00000000 00 |.
00000000 48737631 30353163 0a50726f 6f740a66 |Hsv1051c.Proot.f
00000010 64664131 30313773 76313035 31630a55 |dfA1017sv1051c.U
00000020 64664131 30313773 76313035 31630a4e |dfA1017sv1051c.N
00000030 53544449 4e2e3237 3535300a 2d4e310a |STDIN.27550.-N1.
00000040 2d5a726f 6f744073 76313035 31630a2d |-Zroot@sv1051c.-
00000050 74726f6f 74407376 31303531 630a2d54 |troot@sv1051c.-T
00000060 53544449 4e2e3237 3535300a |STDIN.27550.
00000000 00 |.
00000000 00 |.
...

```

The information gained from this output includes:

- ▶ The remote queue name is final.
- ▶ The data file contains 103 bytes.
- ▶ The job number is 1017.
- ▶ The local host name is sv1051c.

### ***Some things to search for in the output***

There is always an initial handshake protocol that seems to appear similar to:

```

00000000 020405ac |....
00000000 020405ac |....

```

The middle column always starts with 02 for the handshake part. The rest is identification information and does not matter in this discussion.

In general, lines like the following indicate a positive acknowledgment:

```

00000000 00 |.

```

One of the first lines in the file is the queue name:

```

00000000 0266696e 616c0a |.final.

```

Notice in the middle column that this begins with 02. This is a flag to indicate that this is the start of a print request. The name on the end of the line is the queue name.

### **Command identifiers for LPD defined in RFC**

A status request for a queue would start with an 03. The following binary identifiers are defined in the RFC:

- 01** Print any waiting jobs. Not supported by AIX **rembak**.
- 02** Receive a printer job. Standard command for printing.
- 03** Send queue state (short). Default status with **qchk**, **lpstat**, and **enq -A**.
- 04** Send queue state (long).
- 05** Remove jobs.

A short distance down the file, a line will contain the temporary file name:

```
00000000 03313033 20646641 31303137 73763130 |.103 dfA1017sv10|
00000010 3531630a |51c. |
```

In this case, it begins with 03 in the middle column for data file. This is a subcommand of the **receive a printer job** command.

The **receive printer job** subcommands are as follows:

- 01** Abort job.
- 02** Receive control file:  
| 02 | Count | SP | Name | LF |
- 03** Receive data file:  
| 03 | Count | SP | Name | LF |

The preceding example line shows a receive data file subcommand with the following information:

- ▶ The 103 in the third column indicates the number of bytes in the file.
- ▶ The file name starts with *df* for data file.
- ▶ The job number is the next part of the data file; in this example, it is 1017.
- ▶ The last part of the file name is the sending host name sv1051c.

The next packet of data from the client to the server is the data file itself. Check this file for extraneous characters, line feeds, spaces, tabs, and other things that might affect the format. The data in the right-hand column should be exactly what was on the client, as shown in the following example:

```
00000000 53746172 74207465 7374696e 670a5468 |Start testing.Th|
00000010 69732069 73206120 74657374 20707269 |is is a test pri|
00000020 6e74206a 6f622e0a 4920616d 20757369 |nt job..I am usi|
00000030 6e672069 70747261 63652074 6f207472 |ng iptrace to tr|
00000040 61636520 72656d6f 74652070 72696e74 |ace remote print|
```

```
00000050 206a6f62 732e0a46 696e6973 68207465 | jobs..Finish te|
00000060 7374696e 672e0a | sting.. |
```

The next packet from the client is usually the control file name, as shown in the following example:

```
00000000 02313038 20636641 31303137 73763130 |.108 cfA1017sv10|
00000010 3531630a |51c. |
```

The subcommand for control file begins with 02 in the middle column. The information from the receive control file is:

- ▶ 02 is a control file descriptor.
- ▶ There is 108 bytes of control file information.
- ▶ The control file name starts with cfA.
- ▶ The job number 1017 was from host sv1051c.

A sample control file excerpt follows:

```
00000000 48737631 30353163 0a50726f 6f740a66 |Hsv1051c.Proot.f|
00000010 64664131 30313773 76313035 31630a55 |dfA1017sv1051c.U|
00000020 64664131 30313773 76313035 31630a4e |dfA1017sv1051c.N|
00000030 53544449 4e2e3237 3535300a 2d4e310a |STDIN.27550.-N1.|
00000040 2d5a726f 6f744073 76313035 31630a2d |-Zroot@sv1051c.-|
00000050 74726f6f 74407376 31303531 630a2d54 |troot@sv1051c.-T|
00000060 53544449 4e2e3237 3535300a |STDIN.27550. |
```

The meaning of the control file format is shown in Table 12-2.

Table 12-2 Control file format

| Flag            | Description                        |
|-----------------|------------------------------------|
| Hsv1051c        | Shows the host name of the client. |
| Proot           | Shows the user identification.     |
| dfA1017sv1051c  | Shows the file to print.           |
| UdfA1017sv1051c | Unlinks (deletes) file when done.  |
| NSTDIN.27550    | Origin of the file.                |
| -N1             | Make one copy.                     |
| -Zroot@sv1051c  | AIX originator of remote job flag. |
| -troot@sv1051   | AIX delivery flag.                 |
| -TSTDIN.27550   | AIX Title flag.                    |

## 12.5 Filters

Filters in UNIX are generally programs that read from standard in (stdin), and write to standard out (stdout), and somewhere in the middle modify the data in some way. Filters can be run directly from the command line, from a shell script, or from within a virtual printer. This section will cover how to use a filter from a virtual printer, and some of the details on filters available with AIX.

In AIX Version 4 Info Explorer, there is a sample C filter for adding carriage returns to line feeds.

### 12.5.1 AIX filters

The filters that are part of AIX are shown in Table 12-3.

Table 12-3 AIX filters

| Filters                                                  | Description                                                                                                                                                                                            |
|----------------------------------------------------------|--------------------------------------------------------------------------------------------------------------------------------------------------------------------------------------------------------|
| pr                                                       | A filter that formats ASCII data into pages, adds page numbers, and can provide print rotation and page numbers. Very similar to piobe formatting.                                                     |
| asa or fpr                                               | This filter interprets the carriage-control characters in column one, sometimes known as FORTRAN formatting. Although this filter goes by two names, there is only one filter.                         |
| nroff, troff, psroff, hplj, psc, tbl, pic, eqn, and grap | Filters for formatting xroff data to or from ditroff format. These filters allow a tagged file to create a formatted document that supports multiple fonts, tables, pictures, equations, and so forth. |
| enscript                                                 | Filter to convert ASCII TEXT data to PostScript                                                                                                                                                        |

Filters are generally set up in a virtual printer to run before the data goes to the formatting pipeline. You can implement a filter even when the virtual printer is set in pass through mode and when it does not use either the ci (initialization) or cr (reset) sequences.

Filters are the first programs in the input data stream processing pipeline set up by piobe that have an opportunity to selectively manipulate the data stream. A particular filter can be selected from the command line on a per-job basis, or permanently selected by modifying the virtual printer definition.

The **qprt** command uses the **-f** flag to select a particular filter on a per-job basis. The argument to the **-f** flag is the second letter of the two letters that name the filter attribute in the virtual printer definition.

For example, to select the pr filter for a job on an ASCII queue named asc on an IBM 4029 LaserPrinter, you could issue the command:

```
qprt -Pasc -fp /etc/motd
```

The filter attribute that selects the pr filter is named fp, so the argument to the -f flag is just p, the second letter.

To permanently select the pr filter, use **lsvirprt** to edit the virtual printer definition and set the value of the `_f` attribute to p. The `_f` attribute selects a filter that will be used to pre-process any job submitted to the queue associated with this virtual printer definition.

Since the **lp**, **lpr**, and **qprt** commands are all just front ends to the **enq** command, the true entry point to the spooler, you would assume that **enq** must support the -f flag. If you issue the **enq** command with the -f flag, however, you will receive an error message as follows:

```
enq -f
enq: Not a recognized flag: f
```

This is a situation where the previously described technique of mounting `/bin/echo` over `/bin/enq` proves useful.

The root user can issue the following commands from a shell prompt:

1. **mount /bin/echo /bin/enq**
2. **# qprt -Pasc -fp /etc/motd**  
**-P asc -o -f -o p /etc/motd**
3. **umount /bin/enq**

After the second command is issued, the element defined by your TERM environment variable is displayed, as shown in step 2, above.

These are the arguments **qprt** tried to pass to **enq**. You get to see them because **qprt** found echo instead of **enq**. The following command is equivalent to the command shown in step 2 previously:

```
enq -P asc -o -f -o p /etc/motd
```

The -o option specifies that flags specific to the backend should be passed to the backend. The -o option can be thought of as a free pass through the syntax checking that occurs before the **enq** command builds a job description file and notifies the qdaemon of the existence of a new job.

## Using filters

In this section, you will look at an example of a filter that maps linefeeds to carriage returns and linefeeds.

Many users have written or purchased applications that prepare data streams to fill in the blanks on pre-printed checks, invoices, bills-of-lading, or other forms. Printing these data streams requires precise control of the physical printer. It is often the case that the job processing pipeline created by piobe inserts or deletes enough data from the original data stream that the output data no longer falls at the proper position on the pre-printed form.

The root user can frequently use `lsvirprt` to set the value of the `_d` attribute in the virtual printer definition top. On an ASCII queue on an IBM 4029 Laser Printer, this would cause piobe to select the IP pipeline to process the job. The IP pipeline is for passthrough printing, which means that the formatter filters use the `passthru()` routine to simply pass the input data stream through to the printer without modification.

This frequently removes all the printer control problems that existed, but adds one new one. When the formatter filter operates in passthrough mode, the mapping of linefeeds to carriage returns and linefeeds is disabled. The forms still do not print correctly.

Supposing that the application does not allow the insertion of carriage returns into the data stream, you can fix this problem with a simple filter, as follows:

```
#include <stdio.h>
main(int argc, char **argv)
{
 int ch;
 while (EOF != (ch = fgetc(stdin)))
 {
 switch (ch)
 {
 case 10: fputc(ch,stdout);
 fputc(0x0D,stdout);
 break;
 default: fputc(ch,stdout);
 break;
 }
 }
}
```

Compile this and name it `cr_mapper` and install it somewhere accessible, such as `/usr/lib/lpd`. Assign it ownership of `root.printq` and permissions `555`.

Assuming you have an ASCII queue named asc on an IBM 4029 Laser Printer; in AIX Version 4 you can use **lsvirprt** to select the asc queue and then format the f1 filter attribute. You should see something like the following:

```
User defined filter 1
f1 =
```

As the f1 attribute has a null default value, the definition is sparse.

Edit the f1 attribute so its definition appears as follows:

```
User defined filter 1
f1 =
 '/usr/lib/lpd/cr_mapper'
```

When you save the new definition of f1, you can again format it with **lsvirprt**; you should see something like the following:

```
User defined filter 1
f1 = /usr/lib/lpd/cr_mapper
 '/usr/lib/lpd/cr_mapper'
```

The f1 filter can now be used from the command line by using commands such as:

```
qpvt -Pasc -f1 filename
enq -Pasc -o -f -o 1 filename
```

If the `_d` attribute was not set to p, the `-dp` flag and argument would have to be added to the commands as follows:

```
qpvt -Pasc -dp -f1 filename
enq -Pasc -o -d -o p -o -f -o 1 filename
```

The `cr_mapper` program reads characters from stdin and writes them to stdout. Whenever it reads and writes a line feed (a hex A, or decimal 10), it writes out a carriage return (a hex D).

## 12.6 Clearing and preventing queue hangs in AIX

In the AIX printing subsystem the file that defines queues is `/etc/qconfig`. This file is translated into a binary form called `/etc/qconfig.bin`. When the `qdaemon` is printing, this file is loaded into memory and used by the associated printing programs. When a change is made to `/etc/qconfig`, the current print jobs using the memory version of the file must complete printing before the new `qconfig.bin` can be loaded into memory for the new jobs to print. Thus, the current printing jobs must all finish before any jobs on the new or modified queue can print. When



small jobs are printing, this is not a problem, because the individual jobs finish quickly, and printing continues. But, when a large job is printing, or when a queue is in a DEV\_WAIT state, all new or modified queues will appear hung until this condition is cleared and the printing finishes.

In order to correct a hung queue, follow this procedure:

1. Run the **lpstat** command to get the status of the queue as follows:

```
lpstat
Queue Dev Status Job Files User PP % Blks Cp Rnk

lpforu lp0 DEV_WAIT 5 /etc/hosts root 2 1 1
 QUEUED 6 /etc/hosts root 2 1 2
 QUEUED 7 /etc/hosts root 2 1 3
 QUEUED 8 /etc/hosts root 2 1 4
```

2. Stop the qdaemon before making any changes to a queue. This is easily done with the following command:

```
stopsrc -c -s qdaemon
0513-044 The stop of the qdaemon Subsystem was completed successfully.
```

3. Make sure the qdaemon has stopped completely by checking with:

```
lssrc -s qdaemon
Subsystem Group PID Status
qdaemon spooler inoperative
```

4. Use **lpstat** or **enq -sA** to look for any DEV\_WAIT conditions. Wait until all RUNNING jobs are completed, but do not worry about jobs that are QUEUED at this time with a NEW job number in AIX 3. You will not see any of these jobs in AIX 4 or higher.
5. Clear any DEV\_WAIT conditions or cancel the jobs on those queues. Wait until any RUNNING jobs are finished. For details on clearing jobs, see Section 12.7, "Flushing a print job" on page 333.
6. If any of these conditions persist and you are unable to cancel the jobs, look in the /var/spool/lpd/stat directory for files that begin with a "p." This indicates active jobs that need to finish or be cleared. The file contains the PID (process ID) for the qd fork or other associated backend printer program. Often these programs can be cleared out manually as follows.

For example, if the file is `/var/spool/lpd/stat/p.lpforu.lp0`, then run the following command:

```
cat /var/spool/lpd/stat/p.lpforu.lp0
```

This returns the value:

```
28080
```

To verify that 28080 is the PID for the qd fork process, run:

```
ps -ef|grep 28080
 root 28080 35258 0 10:52:13 - 0:00 qd fork
 root 35720 28570 2 10:56:54 pts/3 0:00 grep 28080
```

To kill this process, run the command:

```
kill -9 28080
```

To check if the process has stopped, run:

```
ps -ef | grep 28080
root 28084 28570 1 10:59:25 pts/3 0:00 grep 28080
```

**Note:** Some commands may require root user or system group authority.

Once the system has been cleared, printer jams fixed, paper trays filled, and the queues show READY, the qdaemon can be restarted and the printing subsystem should be in working order again.

This is the time to add new queues. Make changes to the queue, and then start the qdaemon back up with:

```
startsrc -s qdaemon
```

## 12.6.1 Summary

The previous procedure can be summarized as follows:

- ▶ Never change the queues or add queues while jobs are printing.
- ▶ Prevent new jobs submitted from interfering by stopping the qdaemon.
- ▶ Clear all paper jams or disable queues with problems before making any changes.
- ▶ Restart the qdaemon after making changes.

## 12.7 Flushing a print job

You discovered that the first job you printed was the incorrect one. You printed the correct one but now want to delete the obsolete job. The following describes how to flush a print job.

Check the status of the print queue:

```
lpstat -vlpforu
Queue Dev Status Job Files User PP % Blks Cp Rnk

lpforu lp0 RUNNING 3 /etc/passwd root 1 100 1 1 1
```

Print the `/etc/hosts` file to the default printer:

```
lpr -dlpforu /etc/hosts
```

Check the status of the print queue:

```
lpstat -vlpforu
Queue Dev Status Job Files User PP % Blks Cp Rnk

lpforu lp0 RUNNING 3 /etc/passwd root 1 100 1 1 1
 QUEUED 4 /etc/hosts root 1 100 2 1 2
```

Cancel the print job for `/etc/passwd` using one of the following commands:

```
qcan -P lpforu -x 3
cancel 3
lprm -P lpforu 3
enq -P lpforu -x 3
```

Check the print queue using the `qchk` command:

```
qchk -P lpforu
Queue Dev Status Job Files User PP % Blks Cp Rnk

lpforu lp0 RUNNING 4 /etc/hosts root 1 100 2 1 2
```

## 12.8 Holding and releasing print jobs

You may want to prevent one or more jobs from printing without disabling the queue entirely. You use the `qhld` command to accomplish this. The `qhld` command holds print jobs in a spooled state. The job to be held is designated by job number, queue, or user name.

The `qhld` command syntax is as follows:

```
qhld [-r] { -#JobNumber [-PQueue] | -PQueue | -uUser [-PQueue]
```

The following is an example of using the `qhld` command to hold print job 13:

```
qhld -#13 -P lpforu
qchk -P lpforu
Queue Dev Status Job Files User PP % Blks Cp Rnk

lpforu lp0 READY
 HELD 13 smit.log root 22 1 1
```

The `-r` flag releases the hold on the print job:

```
qhld -r -#13 -P lpforu
qchk -P lpforu
Queue Dev Status Job Files User PP % Blks Cp Rnk

lpforu lp0 RUNNING 13 smit.log root 14 0 22 1 1
```

## 12.9 Troubleshooting printing problems

Some of the other general problems that you may encounter are covered in the following sections.

### 12.9.1 qdaemon will not start

This is usually because of:

1. Bad lines or stanzas in `/etc/qconfig` caused by:
  - Manual editing of the file.
  - Removing queues while jobs are still queued.
2. Incompatible `qdaemon`, `enq`, and `digest` after upgrade.

### 12.9.2 Cannot add printer queue

You attempt to add a new printer queue and receive the following error:

```
Not enough space in the /tmp directory
```

Since the `/tmp` file system is a mount point for a directory that contains system-generated temporary files, space will be required for those generated during the creation of the print queue. As such, these files cannot be written to `/tmp` and hence the previous error message. Troubleshoot this problem by increasing the size of `/tmp` or removing any unnecessary files in the `/tmp`.

## 12.9.3 Full file systems

Full file systems can produce a wide variety of problems. While some of these problems are obvious, many others are not, and the print subsystem is not immune. The amount of free space in file systems, particularly /tmp, should always be checked when investigating printing problems.

## 12.10 Setting default printers

An administrator can set a print queue as the default print queue. There are two methods to set a default printer: using the **smitty qdefault** fast path and using the LPDEST environment variable.

### 12.10.1 Using smitty qdefault fast path

To define a default printer:

1. Enter the command **smitty qdefault**. The screen in Figure 12-8 is produced.

```
Set System's Default Print Queue

Type or select values in entry fields.
Press Enter AFTER making all desired changes.

* System DEFAULT QUEUE name [virprt1] +

F1=Help F2=Refresh F3=Cancel F4=List
F5=Reset F6=Command F7=Edit F8=Image
F9=Shell F10=Exit Enter=Do
```

Figure 12-8 Set System's Default Print Queue screen

2. Specify the queue name for the print queue you wish to be the default.
3. Press the Enter Key and wait until the Command: Ok screen displays, then exit SMIT to complete the process.

## 12.10.2 The LPDEST environment variable

The LPDEST environment variable specifies the default print queue once it has been set. A number of print commands, such as **enq**, **lprm**, **lpr**, **qstatus**, **pac**, and many more, use this environment variable as the default if it is set and if a printer is not specified. For some commands, it overrides the printer variable value.

Using the **printenv** command to look at a system before the LPDEST environment variable is set will produce the following output:

```
printenv
_=/usr/bin/printenv
LANG=en_US
LOGIN=root
NLSPATH=/usr/lib/nls/msg/%L/%N:/usr/lib/nls/msg/%L/%N.cat
PATH=/usr/bin:/etc:/usr/sbin:/usr/ucb:/usr/bin/X11:/sbin
LC_FASTMSG=true
LOGNAME=root
MAIL=/usr/spool/mail/root
LOCPATH=/usr/lib/nls/loc
USER=root
AUTHSTATE=compat
SHELL=/bin/ksh
ODMDIR=/etc/objrepos
HOME=/
TERM=vt100
MAILMSG=[YOU HAVE NEW MAIL]
PWD=/
TZ=CST6CDT
A__z=! LOGNAME
```

To set the default queue using the LPDEST environment variable, do the following:

1. Change the value of the LPDEST environment variable in one of the following ways:

If you are in the sh (Bourne) shell, enter the following command:

```
LPDEST=NewValue; export LPDEST
```

If you are in csh (C) shell, enter the following command:

```
setenv LPDEST=NewValue
```

If you are in ksh (Korn) shell, enter the following command:

```
export LPDEST=NewValue
```

2. To verify the current value of the LPDEST environment variable, use the following commands:

```
echo $LPDEST
virprt1
```

3. Using the **printenv** command after setting the variable will produce the following output:

```
printenv
_=/usr/bin/printenv
LANG=en_US
LOGIN=root
NLSPATH=/usr/lib/nls/msg/%L/%N:/usr/lib/nls/msg/%L/%N.cat
PATH=/usr/bin:/etc:/usr/sbin:/usr/ucb:/usr/bin/X11:/sbin
LC__FASTMSG=true
LOGNAME=root
MAIL=/usr/spool/mail/root
LOCPATH=/usr/lib/nls/loc
USER=root
AUTHSTATE=compat
SHELL=/bin/ksh
ODMDIR=/etc/objrepos
HOME=/
TERM=vt100
MAILMSG=[YOU HAVE NEW MAIL]
PWD=/
TZ=CST6CDT
LPDEST=virprt1
A__z=! LOGNAME
```

Note that the LPDEST environment variable is now set to **virprt1**, as highlighted in the preceding example.

## 12.11 Quiz

The following certification assessment question helps verify your understanding of the topics discussed in this chapter.

1. When trying to print a file, the following message is displayed:

```
No virtual printers defined
```

Which of the following is the probable cause?

- A. The lpd and qdaemons are not running.
- B. The printer software is not installed.
- C. There is no space left in /tmp file system.
- D. The /etc/qconfig.bin file is corrupted.

The following are additional questions created by the authors to further test your understanding of the topics.

1. The system administrator is logged into host plainview.texas.com. The system administrator adds a remote print queue from plainview to host beaumont.texas.com and then runs the **lpstat** command to confirm the queues are ready to print. The results of the **lpstat** command are shown below.

| Queue | Dev   | Status    | Job Files     | User | PP % | Blks | Cp | Rnk |
|-------|-------|-----------|---------------|------|------|------|----|-----|
| lp0   | lp0   | STOPPED   | 1 /tmp/report | root |      | 7911 | 1  | 1   |
| rq0   | @beau | READY     |               |      |      |      |    |     |
| rq0   | rq0   | HOST_DOWN |               |      |      |      |    |     |

The **lpstat** output in the exhibit indicates that plainview cannot communicate with beaumont. The system administrator runs a **ping** command from plainview to beaumont and receives ping packets back. Which of the following actions can be performed so plainview can print to beaumont?

- A. Execute **enq -d** on plainview.
- B. Start the lpd daemon on beaumont.
- C. Start the lpd daemon on plainview.
- D. Add the beaumont host name to plainview's /etc/hosts.lpd file.



2. A system administrator is logged into host plainview.texas.com and executes **lpstat** as root. The system administrator adds a remote print queue from plainview to host beaumont.texas.com, re-executes **lpstat** to confirm the queues are ready to print, and gets the following results shown in the exhibit:

| Queue | Dev   | Status    | Job Files     | User | PP | % | Blks | Cp | Rnk |
|-------|-------|-----------|---------------|------|----|---|------|----|-----|
| lp0   | lp0   | STOPPED   | 1 /tmp/report | root |    |   | 7911 | 1  | 1   |
| rq0   | @beau | READY     |               |      |    |   |      |    |     |
| rq0   | rq0   | HOST_DOWN |               |      |    |   |      |    |     |

Which of the following commands should be run to get the queued job in lp0 to begin printing?

- A. **qchk -q**
- B. **enq -X lp0**
- C. **stopsrc -s lpd;startsrc -s lpd**
- D. **stopsrc -cs qdaemon;startsrc -s qdaemon**

## 12.11.1 Answers

The following answer is for the assessment quiz questions.

1. C

The following answers are for the additional quiz questions.

1. B
2. D

## 12.12 Exercises

The following exercises provide sample topics for self study. They will help ensure comprehension of this chapter.

1. Create a virtual printer with the name vprinter on a local system for the remote queue, qremote. If the remote queue does not exist on the remote system, then create the remote queue.
2. Create a text file containing your name, address, and telephone number on individual lines.
3. Start a trace for this virtual printer, vprinter.
4. Print the text file created in step 2 on the vprinter.
5. Using the results of the trace output determine:
  - a. The remote queue name
  - b. The number of bytes in the data file
  - c. The job number
  - d. The local host name
6. Stop the lpd daemon on the remote server.
7. Repeats steps 3 to 5.
8. Restart the lpd daemon.



# Asynchronous Point-to-Point Protocol

The asynchronous Point-to-Point Protocol (PPP) subsystem provides an alternative to SLIP. PPP provides a standard method for transporting multiprotocol datagrams over point-to-point media. PPP is comprised of three main layers:

- ▶ A method for encapsulating multiprotocol datagrams. AIX PPP supports the TCP/IP network layer protocols.
- ▶ A Link Control Protocol (LCP) for establishing, configuring, and testing the data-link connection. AIX PPP implements this through the streams' kernel extensions.
- ▶ A family of Network Control Protocols (NCPs) for establishing and configuring different network layer protocols. AIX PPP supports Internet Protocol Control Protocol (IPCP) for negotiating a TCP/IP connection.

AIX PPP differentiates between client and server. An AIX system can act as both a client and a server. The distinction is made to simplify configuration. PPP servers tend to allocate a pool of IP addresses among the connections that are being made. There is some correlation between the media devices and AIX PPP breaks this correlation. All server PPP connections are allocated on a first-available basis. This facilitates the separation of PPP from the media. The attachment process must request to be linked to the proper type of link.

The asynchronous Point-to-Point Protocol on AIX utilizes three user-level processes:

1. A control daemon, `pppcontrold`, executed by root under the system resource controller (`startsrc -s pppcontrold`). The control daemon's function encompasses loading and configuring all kernel extensions associated with the subsystem. It remains running as long as PPP function is required by the operating system.
2. An attachment process, `pppattachd`, which binds a TTY stream to an instance of the Link Control Protocol, Network Control Protocol, and a datagram protocol. An instance of `pppattachd` exists for each active PPP connection in the system. Any user of the attachment process must belong to the `uucp` group and contain `/usr/sbin` within their `PATH` environment variable.
3. A dialer process, `pppdial` that establishes an outgoing connection. The dialer is intended to be executed by `pppattachd` as the connector program. Its purpose is to interact over the asynchronous device prior to PPP negotiation. This interaction is defined similarly to the UUCP chat dialog format. The dialer capability is provided to assist in establishing a connection with a remote system. The actual session establishment is out of the scope of PPP.

## 13.1 Configuring an asynchronous PPP server

Before configuration, ensure that the `bos.net.ppp` fileset is installed on your AIX system.

Setting up the PPP server requires six steps:

1. Setting up the PPP link control configuration
2. Assigning the PPP IP addresses
3. Setting up the special PPP dial-in ID
4. Adding the TTY port
5. Configuring the modem
6. Starting PPP

Details for these steps are discussed in the following sections.

## 13.2 Setting up the PPP control link

The following terms are used in this section for discussion:

|                                   |                                                                                                                                                                                                          |
|-----------------------------------|----------------------------------------------------------------------------------------------------------------------------------------------------------------------------------------------------------|
| <b>PPP subsystem name</b>         | A unique name to identify the PPP server.                                                                                                                                                                |
| <b>Max server connections</b>     | The greatest number of clients that may be served at any one time. Typically, this is the number of dial-in modems on the system.                                                                        |
| <b>Max client connections</b>     | The greatest number of outgoing connections at any one time. Typically, this is the number of dial-out modems on the system.                                                                             |
| <b>Max demand interfaces</b>      | The greatest number of peer connections allowed at any one time. These connections are established on demand, meaning they are triggered by an event. For example, a <b>ping</b> to the remote PPP host. |
| <b>Max IP interfaces</b>          | The total of the PPP interfaces for the system that is the sum of max server connections, max client connections, and max demand connections.                                                            |
| <b>Max async HDLC attachments</b> | The number of concurrently active PPP sessions allowed. Typically equal to the Max IP interface.                                                                                                         |

The following settings are examples used in this section, for configuring the control PPP daemon:

|                                   |        |
|-----------------------------------|--------|
| <b>PPP subsystem name</b>         | mickey |
| <b>Max server connections</b>     | 1      |
| <b>Max client connections</b>     | 0      |
| <b>Max demand interface</b>       | 0      |
| <b>Max IP interface</b>           | 1      |
| <b>Max async HDLC attachments</b> | 1      |

**Note:**

- ▶ Normally, all other options on the SMIT dialog are left at their default values.
- ▶ You must be root to start PPP and to have access to most files.

The following procedure guides you through creating the PPP Control Link.

1. On server mickey, add the link through SMIT by entering the command:  
`smitty ppp`
2. Choose the option Link Control Configuration.
3. Choose the option Add A Link Configuration.
4. Fill in the accented fields, as shown in Figure 13-1 on page 345, with the values specified previously.

```

LINK Configuration

Type or select values in entry fields.
Press Enter AFTER making all desired changes.

[TOP] [Entry Fields]
PPP subsystem name [mickey]
max server connections [1] #
max client connections [0] #
max demand connections [0] #
max ip interfaces [1] #
max async hdlc attachments [1] #
mru [] #
async character map [] X
transmit async character map [] X
negotiate MRU yes +
negotiate magic number yes +
negotiate async map yes +
negotiate protocol compression yes +
[MORE...8]

F1=Help F2=Refresh F3=Cancel F4=List
Esc+5=Reset Esc+6=Command Esc+7=Edit Esc+8=Image
Esc+9=Shell Esc+0=Exit Enter=Do

```

Figure 13-1 Link Configuration screen

5. Press Enter to add the Link.

This process created a file `/etc/ppp/lcp_config`. You can examine this file as follows:

```

cat /etc/ppp/lcp_config
server_name mickey
lcp_server 1
lcp_client 0
lcp_demand 0
num_if 1
num_hdlc 1

```

### 13.3 Assigning the PPP IP addresses

The following information is required for this procedure: the IP address, gateway, and netmask for the host.

To obtain this information, perform the following steps:

- ▶ Enter `smitty tcpip`.
- ▶ Select Minimum Configuration & Startup.
- ▶ Choose the Available Network Interface, such as `en0` or `tr0`.

- ▶ Make note of the information required.

For the purposes of this discussion, the settings you will use are:

**Hostname** mickey  
**Internet address** 9.3.1.45  
**Network mask** 255.255.255.0  
**Nameserver** 9.3.1.74  
**DOMAIN name** itsc.austin.ibm.com  
**GATEWAY address** 9.3.1.74

Perform the following steps:

1. Choose an unused address in the same domain (9.3.1.46).
2. Add an entry in the /etc/hosts file with the new address and host name for the PPP client.
3. Add the PPP addresses by entering the command **smitty ppp**.
4. Choose the option PPP IP Interfaces.
5. Choose the option Add a Server Interface.
6. Fill in the fields, shown in Figure 13-2, with information provided previously.

```

 PPP IP Configuration
Type or select values in entry fields.
Press Enter AFTER making all desired changes.

 [Entry Fields]
Local IP address [9.3.1.45]
Starting Remote IP address [9.3.1.46]
Number of addresses [1] #
Netmask [255.255.255.0]

F1=Help F2=Refresh F3=Cancel F4=List
F5=Reset F6=Command F7=Edit F8=Image
F9=Shell F10=Exit Enter=Do

```

Figure 13-2 PPP IP Configuration



7. Press Enter to add the IP Server configuration. This creates a file entry in `/etc/ppp/if_conf`. The file can be viewed using the following:

```
cat /etc/ppp/if_conf
interface
server
local_ip 9.3.1.45
remote_ip 9.3.1.46
netmask 255.255.255.0
```

8. Make sure `ipforwarding` is on. By default, in AIX Version 4 and later, `ipforwarding` is turned off. If you want your server to act as a router, you need to turn `ipforwarding` on. Check the value of `ipforwarding` with:

```
no -a |grep ipf
 ipfragttl = 60
 ipforwarding = 0
```

If `ipforwarding` is 0, change it to 1 with the following command:

```
no -o ipforwarding=1
```

9. Because you are adding the client to the same subnet as the server, you will want the server to respond to ARP requests from other hosts in the network, so that all traffic to the client will get routed through the hosts. You can do this with a proxy ARP.

Find the hardware address of the local adapter for the client using:

```
netstat -i
```

| Name | Mtu   | Network | Address          | Ipkts   | Ierrs | Opkts  | Oerrs | Coll |
|------|-------|---------|------------------|---------|-------|--------|-------|------|
| lo0  | 16896 | link#1  |                  | 203625  | 0     | 203773 | 0     | 0    |
| lo0  | 16896 | 127     | loopback         | 203625  | 0     | 203773 | 0     | 0    |
| lo0  | 16896 | ::1     |                  | 203625  | 0     | 203773 | 0     | 0    |
| en0  | 1500  | link#2  | 2.60.8c.2f.47.42 | 712193  | 0     | 712606 | 0     | 0    |
| en0  | 1500  | 9.3.5   | goofy_en0        | 712193  | 0     | 712606 | 0     | 0    |
| tr0  | 1492  | link#3  | 10.0.5a.a8.3b.fa | 1088842 | 0     | 769364 | 0     | 0    |
| tr0  | 1492  | 9.3.1   | goofy            | 1088842 | 0     | 769364 | 0     | 0    |
| tr1  | 1492  | link#4  | 10.0.5a.a8.d1.f3 | 1076155 | 0     | 726539 | 0     | 0    |
| tr1  | 1492  | 9.3.4   | goofy_stby       | 1076155 | 0     | 726539 | 0     | 0    |

Add an ARP entry for the remote host using:

```
arp -s type hostname hardware address pub
```

where:

**type** The type of your network adapter. Valid types are: ether, 802.3, fddi, 802.5 (token ring).

**hostname** Host name of the client.

**hardware address** From `netstat -i`. Use colon separators.

**pub** Indicates public and permanent.

The token ring (tr0) hardware address is used for this example.

For server mickey, this command is:

```
arp -s 802.5 goofy 10:0:5a:8c:3b:fa pub
```

10. Verify the ARP entries with an **arp -a** command. The output is as follows:

```
goofy (9.3.1.46) at 10:0:5a:8c:3b:fa [token ring] permanent published
```

## 13.4 Adding a PPP login user

When setting up a PPP server, the answering pppattachd daemon is started from the profile script of a special PPP user. The security of this user is dependent on the type of Internet server you are using and who will know the password of the server. In many cases, you will want this special user ID only available while starting a PPP session. This is especially true if you are setting up a server for outside users to dial into.

Special tasks specific to the PPP user include:

1. Make this user a member of the uucp group.
2. Do not allow other users to **su** to this user.
3. Do not allow a remote login to the user (**telnet** or **rlogin**).
4. Disable FTP to the user.
5. Modify the .profile to start the pppattachd.

In this section, you will create a PPP user through SMIT.

You will use the command **smitty user** fast path as follows:

1. Enter the command **smitty user**.
2. Choose the option Add a User.
3. Fill in the screen ensuring that the following is set:

|                                    |                      |
|------------------------------------|----------------------|
| <b>User Name</b>                   | pppuser              |
| <b>Primary Group</b>               | uucp                 |
| <b>Group Set</b>                   | uucp                 |
| <b>Administrative Groups</b>       | uucp                 |
| <b>Another user can su to user</b> | false (for security) |
| <b>Su Groups</b>                   | Nogroup              |
| <b>Home directory</b>              | /home/pppuser        |
| <b>Initial Program</b>             | /usr/bin/ksh         |
| <b>User can Login?</b>             | true                 |

**User can Login Remotely?** false

Press Enter to create user. Press F3 to go to previous menu.

4. Select Change a User's Password. Give the user ID a password.
5. Edit the user .profile using:  

```
vi /home/pppuser/.profile
```

Insert the first line:

```
exec /usr/sbin/pppattachd server 2>/dev/null
```
6. At the initial login, the new user is prompted to change the assigned password. However, the chat script cannot do this and the connection will not be successful. Therefore, enter the following command to switch off this prompt:  

```
pwdadm -f NOCHECK username
```

For this example, the command is:

```
pwdadm -f NOCHECK pppuser
```
7. Put the PPP user name in the /etc/ftusers file.  
Create the file if it does not exist.

The user is ready for PPP login.

### 13.4.1 Adding the TTY port

In this section, you will add a TTY port with login capability.

#### Add the TTY device

The procedure adds a TTY device:

1. Enter the command **smitty tty**.
2. Choose the option Add a TTY.
3. Choose your TTY type from the resulting list.
4. Choose your parent adapter from the resulting script.
5. Make the following changes:
  - Set your port number.
  - Enable login.
  - Set baud rate to the baud rate of the modem.
  - Set flow control as rts.
6. Press Enter to add the TTY.

## Add TTY to /etc/uucp/Devices file

For the **cu** command to configure the modem and for PPP to work, you will need an entry in the /etc/uucp/Devices file for this TTY. Add this as follows:

1. Enter the command **cd /etc/uucp**.
2. Enter the command **vi Devices**.
3. Add a line at the following line at the bottom of the Devices file:

```
Direct tty# - baud-rate direct
```

For this example, it is:

```
Direct tty0 - 9600 direct
```

4. Save and exit the file.

### 13.4.2 Configure the dial-in modem

The setup of a modem will be different for different types of modems, and will also be different for the client or the server. Since the server is answering the call, you will need to make sure that the modem is set to answer a call. Modem setup strings vary, but a frequently-used generic setup string is as follows:

```
AT&F&C1&D2S0=1Q2&W
```

A different string may be required by your modem. Some modems allow you to configure them directly, and that eliminates the need to do any of these configuration from the software level. See the installation manual for your modem for details.

To set up the modem, do the following:

1. Disable the login with **pdisable tty0**.
2. Connect to the modem with **cu -m1 tty0**. The modem should respond with Connected.

If an entry is not made for `tty0` in the `/etc/uucp/Devices` file, then the following error is displayed when the command `cu -m1 tty0` is executed:

```
cu -m1 tty0
cu: 0835-028 The connection failed. NO DEVICES AVAILABLE.
```

**Note:** The command `cu -dm1 tty#` provides you with debug information for the `cu` command. If there is no response from the `cu -m1 tty#` command, then execute the command with the `-d` flag and troubleshoot the problem from the information supplied in the output.

3. Type `AT` and press Enter. The modem should respond with `OK`.
4. Set the modem to answer after one ring with `ATS0=1`.
5. Enter the generic setup string or use the specific setup string for your modem.
6. Exit the `cu` session with `~.` That is the tilde character followed by a dot.
7. Press Enter. This should return `Disconnected`.
8. Enable the login with `penable tty0`.

### Capturing diagnostic output

Before dialing out, provide diagnostic information to use in case of a failure to establish a connection. Do the following:

1. In the `/etc/syslog.conf` file, add the line: `*.debug /tmp/ppp`.
2. Create the file `/tmp/ppp` and set the permissions so it can be written to.
3. Tell `syslogd` that `/etc/syslog.conf` has been updated. Enter the command:  

```
refresh -s syslogd
```
4. `pppcontrold` can be set to provide more detailed output by sending it signal `30`. Enter the following commands:
  - `lssrc -s pppcontrold` (Note the process ID (PID)).
  - `kill -30 pppcontrold_PID`, where `pppcontrold_PID` is the PID number of `pppcontrold` returned by the previous command.

This will append a note to `/tmp/ppp` with a message indicating that debugging has been activated. This diagnostic output can be switched off using `kill -31 pppcontrold_PID`.

### 13.4.3 Start the PPP control daemon

Once the link and IP addresses are configured, you can start the `pppcontrold` control daemon. It is recommended that you do this from `SMIT`, following the same procedure used for the server.

1. Return to the PPP main Panel that is using **smitty ppp**.
2. Select the option Start PPP.
3. Select the type of startup you want.
4. At this point, if you exit SMIT, you can do the following to verify that the PPP subsystem is active on this system:

```
#lssrc -s pppcontrold
Subsystem Group PID Status
pppcontrold uucp 18914 active
This should show as active.
#ps -ef | grep ppp
root 18914 4456 0 Apr 18 - 0:00 /usr/sbin/pppcontrold
```

There should be a pppcontrold process running.

If there is a problem, look at the /tmp/pppsyslog daemon file you setup in “Capturing diagnostic output” on page 351.

## 13.5 AIX PPP client

Now that the server (mickey) is up and operational, you will configure a client (goofy) and test the connection between mickey and goofy.

### 13.5.1 Configuring an AIX PPP client

You will configure the PPP client through SMIT with the following procedure:

1. On Goofy, enter the command **smitty ppp**.
2. Select the option Link Control Configuration.
3. Select the option Add a Link Configuration.
4. Fill in the fields as follows:

```
PPP subsystem name goofy
Max server connections 0
Max client connections 1
Max IP interfaces 1
Max async HDLC attachments 1
```

You are configuring a client; therefore, you do not need more than one client connection, no server connections, and only one IP interface and async HDLC Attachments. You will only be dialing out to one server.

Take the defaults for everything else.

5. Press Enter to add the link.
6. The file `/etc/ppp/lcp_config` was created. A look at this file shows the following configuration for the client:

```
#cat /etc/ppp/lcp_config
server_name goofy
lcp_server 0
lcp_client 1
lcp_demand 0
num_if 1
num_hdlc 1
```

7. Add a TTY, as shown in Section 13.4.1, “Adding the TTY port” on page 349. Ensure that `Enable LOGIN=disable` is set when configuring the TTY.
8. Configure the dial-out modem using the method in Section 13.4.2, “Configure the dial-in modem” on page 350.

### Start the PPP control daemon

Once the link is configured, you can start the `pppcontrol` control daemon. It is recommended that you do this from SMIT by following the same procedure as in Section 13.4.3, “Start the PPP control daemon” on page 351.

Verify that the PPP interface is working by using the following command:

```
#ifconfig pp0
pp0: flags=6000030<POINTOPOINT,NOTRAILERS,GROUPRT,64BIT>
 inet 0.0.0.0 --> 0.0.0.0 netmask 0xff000000
```

The interface should display with Addresses of 0.0.0.0 set.

## 13.5.2 Create the chat dialog

A chat script is a file containing expect-send pairs separated by spaces or newline. These expect-send sequences instruct `pppdial` how to dial up and log into a remote PPP server. An example of a simple chat script follows:

```
, ,
AT
OK
ATDT4444444
CONNECT
, ,

ogin:
goofy
ssword:
goofy
```

Line by line, this script can be translated to mean:

- ▶ Expect nothing.
- ▶ Send the command AT to the modem.
- ▶ Expect OK to come back.
- ▶ Send the modem ATDT44444444 (to make the modem dial this number).
- ▶ Expect the CONNECT response from the modem.
- ▶ Send a null string.
- ▶ Expect the string ogin: from the remote system.
- ▶ Send the ppp ID goofy.
- ▶ Expect a prompt (ssword:) for the password.
- ▶ Send the ppp ID password that is goofy.

This is only an example and, as such, before you establish a PPP connection, dial out to the remote system and see what is required to log in and start PPP.

You should now be able to use the command `/usr/sbin/pppattachd tty0 client connect "/usr/sbin/pppdial -v -f chat_script_file"` to connect to the remote server.

A sample chat script (dial\_out.example) can be found in the `/etc/ppp` directory. You can edit this script to reflect your requirements and use it to invoke the PPP connection.

If there are any problems with the connection, see the `/tmp/ppp` file created in section “Capturing diagnostic output” on page 351 for diagnostic information to assist in troubleshooting the problem.

## 13.6 Quiz

The following are additional questions created by the authors to further test your understanding of the topics.

1. What filesets need to be installed to support PPP?
  - A. bos.net.ppp, bos.uucp.net
  - B. bos.net.ppp, bos.net.uucp
  - C. bos.net.ppp
  - D. bos.net



2. Given the following command and output:

```
cat /etc/ppp/lcp_config
server_name pppserver
lcp_server 1
lcp_client 0
lcp_demand 0
num_if 1
num_hd1c 1
```

Is this a server or client PPP system? How many server connections and client connects can this system make respectively?

- A. Client, 2, 0
- B. Client, 1, 0
- C. Server, 0, 1
- D. Server, 1, 0

### 13.6.1 Answers

The following answers are for the additional quiz questions.

- 1. C
- 2. D

## 13.7 Exercises

The following exercises provide sample topics for self study. They will help ensure comprehension of this chapter.

- 1. Create a link configuration for a PPP server with zero maximum client connections, three maximum server connections, no maximum demand, and maximum IP interface.
- 2. Add a TTY and use the **cu** command to configure and test your dial-in modem.
- 3. Use the `lcp_config` file to verify the configuration in 1.
- 4. Configure a PPP client to connect to this server with zero maximum server connections. Verify configuration using the `lcp_config` file.





## The cron daemon and crontab

The cron daemon runs shell commands at specified dates and times. The AIX cron daemon is similar to the System V Release 2 cron daemon. An entry in the `/etc/inittab` file starts the cron daemon at system initialization. The default record for AIX 5L Version 5.1 is shown in Table 14-1.

Table 14-1 Default cron record in the `/etc/inittab` file

| Field      | Value                       |
|------------|-----------------------------|
| Identifier | cron                        |
| RunLevel   | 23456789                    |
| Action     | respawn                     |
| Command    | <code>/usr/sbin/cron</code> |

In previous versions of AIX, cron had a RunLevel value of 2.

Regularly scheduled commands can be specified according to instructions contained in the crontab files. You can submit your crontab file with the `crontab` command. Use the `at` command to submit commands that are to be run only once. You can also use the `batch` command that is a shell script invoking the `at` command.

## 14.1 The at command

The **at** command reads, from standard input, the names of commands to be run at a later time and allows you to specify when the commands should be run. The **at** command mails you all output from standard output and standard error for the scheduled commands, unless you redirect that output. It also writes the job number and the scheduled time to standard error.

Submit a job to be run at a later time using the format:

```
at -f filename -t CCYYMMDDhhmmSS Increment
```

where the values of the -t and -f flags are:

- CC** Specifies the first two digits of the year (the century). If this is not specified, the default value is 19, if the value of YY is between 70 and 99. The default value is 20 if the value of YY is between 00 and 37.
- YY** Specifies the second two digits of the year.
- MM** Specifies the month of the year (01 through 12).
- DD** Specifies the day of the month (01 through 31).
- hh** Specifies the hour of the day (00 through 23).
- mm** Specifies the minute of the hour (00 through 59).
- SS** Specifies the second of the minute (00 through 59). The default value is 00 if it is not specified.

**filename** Specifies the command file to be run at a later time.

The optional Increment parameter can be one of the following:

- ▶ A + (plus sign) followed by a number and one of the following words:
  - minute[s]
  - hour[s]
  - day[s]
  - week[s]
  - month[s]
  - year[s]
- ▶ The special word next followed by one of these words:
  - minute[s]
  - hour[s]
  - day[s]
  - week[s]

- month[s]
- year[s]

Instead of the -t flag, you can also use the following keywords:

- ▶ noon
- ▶ midnight
- ▶ now

Other flags and values can be found in the AIX product documentation.

### 14.1.1 Location of the spool area directory for the at command

The spool area directory for the **at** command is `/var/spool/cron/atjobs`. After a job is scheduled to run, a file exists in the `/var/spool/cron/atjobs` directory and the **atq** command shows:

```
ls /var/spool/cron/atjobs
root.915213600.a
atq
root.915213600.a Fri Jan 1 12:00:00 CST 1999
```

After the job is deleted, the `/var/spool/cron/atjobs` directory is empty and the **atq** command no longer shows anything:

```
at -r root.915213600.a
The root.915213600.a at file is deleted.
ls /var/spool/cron/atjobs
atq
```

## 14.2 Location of crontab files

The crontab files are kept in the `/var/spool/cron/crontabs` directory. Each cron user has a crontab file with their user name as the file name in the `/var/spool/cron/crontabs` directory. The content of a sample `/var/spool/cron/crontabs` directory is shown in Figure 14-1.

```
ls -l /var/spool/cron/crontabs
total 12
-rw-r--r-- 1 adm cron 2031 Sep 18 1997 adm
-rw----- 1 root cron 1130 Nov 05 09:48 root
-rw-r--r-- 1 sys cron 864 Sep 18 1997 sys
-rw-r--r-- 1 root cron 1133 Jul 31 10:31 uucp
█
```

Figure 14-1 Sample `/var/spool/cron/crontabs` directory content

A sample of the `/var/spool/cron/crontabs/root` file is shown in Figure 14-2.

```
crontab -l
@(#)08 1.15.1.3 src/bos/usr/sbin/cron/root. cmdcntl, bos430, 9737A_430
2/11/94 17:19:47
IBM_PROLOG_BEGIN_TAG
This is an automatically generated prolog.
#
bos430 src/bos/usr/sbin/cron/root 1.15.1.3
#
Licensed Materials - Property of IBM
#
(C) COPYRIGHT International Business Machines Corp. 1989,1994
All Rights Reserved
#
US Government Users Restricted Rights - Use, duplication or
disclosure restricted by GSA ADP Schedule Contract with IBM Corp.
#
IBM_PROLOG_END_TAG
#
COMPONENT_NAME: (CMDCNTL) commands needed for basic system needs
#
FUNCTIONS:
#
ORIGINS: 27
#
(C) COPYRIGHT International Business Machines Corp. 1989,1994
All Rights Reserved
Licensed Materials - Property of IBM
#
US Government Users Restricted Rights - Use, duplication or
disclosure restricted by GSA ADP Schedule Contract with IBM Corp.
#
#0 3 * * * /usr/sbin/skulker
#45 2 * * 0 /usr/lib/spell/compress
#45 23 * * * ulimit 5000: /usr/lib/smdemon.cleau > /dev/null
0 11 * * * /usr/bin/errclear -d S.0 30
0 12 * * * /usr/bin/errclear -d H 90
0 4 * * * /usr/bin/rmxcrcd -d 4 1>/dev/null 2>/dev/null
█
```

Figure 14-2 A sample `/var/spool/cron/crontabs/root` file

## 14.3 Verifying job runs

You can examine each file in the `/var/spool/cron/crontabs` directory to verify what cron jobs are scheduled to run at a certain time. Together with the `atq` command, you can determine whether some jobs need to be rescheduled to better utilize the system resources. Both the users `root` and `deploy` have scheduled a job to run using the `at` command, as shown by the `atq` command in Figure 14-3 on page 361.

```
atq
deploy.910389157.a Fri Nov 6 15:52:37 CST 1998
root.910389186.a Fri Nov 6 15:53:06 CST 1998
█
```

Figure 14-3 Sample output of the atq command

The cron daemon also creates a log of its activities in the `/var/adm/cron/log` file. AIX 5L Version 5.1 enhances the amount of data logged to include the following information about individual jobs:

- ▶ The owner of the job run by the cron daemon.
- ▶ The time of execution of the job.
- ▶ The PID of the job.
- ▶ The actual command line that is run to accomplish the job.
- ▶ Whether the job has run successfully or not.

Either of the following display formats are used:

- ▶ User : CMD (actual command that is executed) : time when the job is executed : Cron Job with pid : Successful
- ▶ User : CMD (actual command that is executed) : time when the job is executed : Cron Job with pid : Failed

For example:

```
root : CMD (/usr/lib/ras/dumpcheck >/dev/null 2>&1) : Tue Feb. 20 15:00:00
2001
Cron Job with pid: 20664 Successful
```

Every time cron runs a job (either from the crontab file, for the system-related jobs, or from the `/var/spool/cron/crontab/userfile`, for user-related processes), all its activity will be logged into the `/var/adm/cron/log` file in the mentioned format. You can inspect this data to verify jobs after they have been run.

The cron daemon also mails any command output or errors to the user who submitted the job, unless the `at` command or crontab entry redirects the standard output or standard error. The following crontab entry redirects standard output and standard error, so no mail is sent:

```
0 15 * * * /usr/lib/ras/dumpcheck >/dev/null 2>&1
```

The following entry in root's crontab file runs the `mksysb` command and does not redirect its output, so cron mails the results to root after the command completes:

```
0 02 * * * /usr/bin/mksysb -i /dev/rmt0
```

## 14.4 Crontab file record format

A crontab file contains entries for each cron job. Entries are separated by newline characters. Each crontab file entry contains six fields separated by spaces or tabs in the following form:

```
minute hour day_of_month month weekday command
```

These fields accept the following values:

|                     |                                         |
|---------------------|-----------------------------------------|
| <b>minute</b>       | 0 through 59                            |
| <b>hour</b>         | 0 through 23                            |
| <b>day_of_month</b> | 1 through 31                            |
| <b>month</b>        | 1 through 12                            |
| <b>weekday</b>      | 0 through 6 for Sunday through Saturday |
| <b>command</b>      | A shell command                         |

You must specify a value for each field. Except for the command field, these fields can contain the following:

- ▶ A number in the specified range. To run a command in May, specify 5 in the month field.
- ▶ Two numbers separated by a dash to indicate an inclusive range. To run a cron job on Tuesday through Friday, place 2-5 in the weekday field.
- ▶ A list of numbers separated by commas. To run a command on the first and last day of January, you would specify 1,31 in the day\_of\_month field.
- ▶ An \* (asterisk), meaning all allowed values. To run a job every hour, specify an asterisk in the hour field.

Blank lines and lines whose first non-blank character is # (number sign) are ignored. By default, the records containing /usr/sbin/skulker, /usr/lib/spell/compress, and /usr/lib/smdemon.cleau in the command field are commented. This is shown in Figure 14-2 on page 360.

## 14.5 Scheduling job runs

Consider the following single line script called program in the /apl directory:

```
#!/usr/bin/ksh
print program executed at `date +%H:%M` >> /data/output
```



Some examples of the crontab entries for scheduling this /appl/program to run are shown in Table 14-2.

Table 14-2 Sample crontab entries for scheduling a running of a program

| Program run time                                   | crontab entry                   |
|----------------------------------------------------|---------------------------------|
| Every Tuesday at 02:00                             | 0 2 * * 2 /appl/program         |
| Every night at 02:00                               | 0 2 * * * /appl/program         |
| Every night at midnight                            | 0 0 * * * /appl/program         |
| On the 7th, 14th, and 21st day at 4:20 pm          | 20 16 7,14,21 * * /appl/program |
| Monday through Friday at 4:20 pm                   | 20 16 * * 1-5 /appl/program     |
| 1st January, 1st July, and 1st December at 4:20 pm | 20 16 1 1,7,12 * /appl/program  |

To schedule /appl/program to run every five minutes, you can either use the **crontab** command or the **at** command.

Technically, you can define all the values in the hour in five minute intervals starting at 0, 1, 2, 3, or 4, as one of the following crontab entries:

```
0,5,10,15,20,25,30,35,40,45,50,55 * * * * /appl/program
1,6,11,16,21,26,31,36,41,46,51,56 * * * * /appl/program
2,7,12,17,22,27,32,37,42,47,52,57 * * * * /appl/program
3,8,13,18,23,28,33,38,43,48,53,58 * * * * /appl/program
4,9,14,19,24,29,34,39,44,49,54,59 * * * * /appl/program
```

Alternatively, you can use the **at** command. For scheduling the /appl/program to run every five minutes, or some short intervals repeatedly, modify the /appl/program file by adding the **at** command as follows:

```
#!/usr/bin/ksh
at now + 5 minutes -f /appl/program > /dev/null 2>&1
print program executed at `date +%H:%M` >> /data/output
```

Start the first job with the command:

```
at now -f appl/program > /dev/null 2>&1
```

When the /appl/program runs for the first time, it schedules the next run five minutes later. This process repeats itself until you stop it by entering the **atq** command to get the scheduled job name and then the **at -r** command to remove the scheduled job.

## 14.6 Allowing access to the crontab command

The `/var/adm/cron/cron.allow` and `/var/adm/cron/cron.deny` files control which users can use the **crontab** command. A root user can create, edit, or delete these files. Entries in these files are user login names with one name to a line.

If the `cron.allow` file exists, only users whose login names appear in it can use the **crontab** command.

**Note:** The root user name must appear in the `cron.allow` file if the file exists.

You can explicitly stop a user from using the **crontab** command by listing the user's login name in the `cron.deny` file. If only the `cron.deny` file exists, any user whose name does not appear in the file can use the **crontab** command.

A user cannot use the **crontab** command if one of the following is true:

- ▶ The `cron.allow` file and the `cron.deny` file do not exist (allows root user only).
- ▶ The `cron.allow` file exists but the user's login name is not listed in it.
- ▶ The `cron.deny` file exists and the user's login name is listed in it.

If neither the `cron.allow` nor the `cron.deny` file exists, only someone with root user authority can submit a job with the **crontab** command.

The empty `/var/adm/cron/cron.deny` file has been deleted for security reasons. To allow the people in charge of application deployment to schedule applications to be run, a `/var/adm/cron/cron.allow` file is created, as in Figure 14-4.

```
cat > /var/adm/cron/cron.allow
root
deploy
█
```

Figure 14-4 Creating the `cron.allow` file

There are also the `/var/adm/cron/at.allow` and `/var/adm/cron/at.deny` files that control which users can use the **at** command, using the same rules as the `/var/adm/cron/cron.allow` and `/var/adm/cron/cron.deny` files.



## 14.8 Verifying job schedules

As a general user without root authority, the user `deploy` is not authorized to list the content of the `/var/spool/cron/crontabs/deploy` file. However, the user can still verify his job schedules by using the `crontab -l` command, as shown in Figure 14-7.

```
$ whoami
deploy
$ set -o vi
$ whoami
deploy
$ cat /var/spool/cron/crontabs/deploy
cat: 0652-050 Cannot open /var/spool/cron/crontabs/deploy.
$ crontab -l
30 13 * * * /appl/program
$ █
```

Figure 14-7 Using the `crontab -l` command

## 14.9 Checking the time of the crontab file

Merely verifying the job schedule is not enough to prove that cron will schedule the command to run at that time. If you have submitted your crontab file past the time the command is scheduled to run, nothing would have been scheduled. Use the `crontab -v` command to check the crontab submission time, as shown in Figure 14-8.

```
$ crontab -l
30 13 * * * /appl/program
$ crontab -v
Crontab file: deploy Submission time: Thu Nov 5 13:07:50 CST 1998
$ date
Thu Nov 5 13:57:55 CST 1998
$ cat /data/output
program executed at 13:30
$ █
```

Figure 14-8 The `crontab -v` command

The `/appl/program` is scheduled to run at 1:30 p.m. everyday. The crontab file is submitted at 1:07 p.m. The time now is 1:57 p.m. The command should have been scheduled to run. Checking the `/data/output` file confirms that the `/appl/program` has been run.

## 14.10 Removing the crontab file

The responsibility for scheduling jobs to run is now moved from the application deployment group to the operations group. The user name `deploy` in the `/var/adm/cron.allow` file has been replaced by another user name from operations. The user `deploy` then removes the `/var/spool/cron/crontabs/deploy` file with the `crontab -r` command. The `/var/spool/cron/crontabs/deploy` is simply deleted without any message. Until the operations people create their crontab file, the content of the `/var/spool/cron/crontabs` directory is reverted back to the state, as shown in Figure 14-1 on page 359.

**Note:** Avoid running `crontab -r` when you are logged in as root. It removes the `/var/spool/cron/crontabs/root` file. This file usually contains the scheduling of housekeeping jobs, such as diagnostics of hardware errors. You will have to restore the file from your backup.

## 14.11 Using crontab to append to a user's cron file

The operations group has been given a user name `ops`. They do not want to start from scratch for scheduling jobs. Instead, they just want to reschedule the time of run for the jobs that the application deployment people run. The application deployment group has actually saved a backup copy of their crontab file, as shown in Figure 14-9.

```
$ crontab -l > deploy.schedule
$ cat deploy.schedule
30 13 * * * /appl/program
$ █
```

Figure 14-9 A saved copy of the crontab file

The operations people are given access to this `deploy.schedule` file. They can then create their crontab file using the `crontab file` command, as shown in Figure 14-10.

```
$ whoami
ops
$ crontab -l
0481-103 Cannot open a file in the /var/spool/cron/crontabs directory.
A file or directory in the path name does not exist.
$ crontab ~/deploy/deploy.schedule
$ crontab -l
30 13 * * * /appl/program
$ █
```

Figure 14-10 Creating the crontab file using an existing file

After that, they will use the **crontab -e** command to edit the time to schedule the command to be run at a different time.

## 14.12 Quiz

The following certification assessment questions will help verify your understanding of the topics discussed in this chapter.

1. A representative from the accounting department informed systems support that backup jobs are not being run on a daily basis as they should. These backup jobs are scheduled to run using cron as the root user. If the system administrator is logged in as root, what command should be run to verify the jobs are scheduled properly?
  - A. **ls cron**
  - B. **ls crontab**
  - C. **crontab -l**
  - D. **cat /var/spool/cron/crontabs**
2. A script, /usr/local/bin/swaptool.ksh, is scheduled to run every hour on the hour on an S70 server. The system administrator has noticed that the script has failed to run for the past four hours. A **ps -ef** command indicates that cron is no longer running. What would be the first step in examining this problem?
  - A. Do a **tail** on /var/adm/cron/log to gather diagnostic information.
  - B. Run the command **/user/sbin/cron -d** to create debug output from **cron**.
  - C. Reboot the system; **cron** can only be initiated at system startup when the LED flashes 553.
  - D. Do a **crontab -v**, see what cron-initiated processes may still be running and kill those processes off.

The following are additional questions created by the authors to further test your understanding of the topics.

1. The system administrator of Company ABC needs to automatically run the script `/usr/local/bin/system.backup` every Sunday morning at 1:00 AM. What line should be added to the crontab of the root user to accomplish this task?
  - A. `0 1 * * 0 /usr/local/bin/system.backup`
  - B. `1 0 * * 0 /usr/local/bin/system.backup`
  - C. `0 1 * * 1 /usr/local/bin/system.backup`
  - D. `1 0 * * 1 /usr/local/bin/system.backup`
2. The system administrator at XYZ Company has noticed peaks in system activity occurring in the early evening on the development server. It is suspected that this activity is being caused by users scheduling jobs to be run via the `at` command. How can the system administrator find all jobs currently scheduled to run via the `at` command?
  - A. `lsat -l`.
  - B. `at -l ALL`.
  - C. Browse the files in the `/var/spool/at/atjobs` directory.
  - D. Browse the files in the `/var/spool/cron/atjobs` directory.
3. If a user runs the command `crontab /tmp/mycron`, what would be the result of this command?
  - A. The user's crontab file would be replaced with the contents of `/tmp/mycron`.
  - B. The entries contained in `/tmp/mycron` would be appended to the user's crontab file.
  - C. The current contents of the user's crontab file would be written to the file `/tmp/mycron`.
  - D. An error message would be generated. This is not valid syntax for the crontab.

## 14.12.1 Answers

The following answers are for the assessment quiz questions.

1. C
2. A

The following answers are for the additional quiz questions.

1. A
2. D
3. A

## 14.13 Exercises

The following exercises provide sample topics for self study. They will help ensure comprehension of this chapter.

1. Add entries to crontab to run at specific times.
2. Reschedule jobs to run at a later time.
3. Check the existence of the crontab files and note their location.
4. Check the existence of the **at** jobs files.
5. Use various **crontab** command flags to list, edit, verify, and delete crontab entries.
6. Use various **at** command flags to schedule, report, and remove job.





## Editing and viewing files and strings

In this chapter you are provided a basic overview of how to use the vi editor to edit ASCII files. You will also learn how to view a file using various commands and the differences between these commands.

## 15.1 The vi file editor

The vi editor is a full-screen file editor that was developed from the ex editor. It is also common to all versions of UNIX. The **vedit** command starts a version of the vi editor intended for beginners. In the **vedit** editor, the report option is set to 1, the showmode option is set, and the novice option is set, making it a line editor. **vedit** corresponds to **vi -v** (vi in verbose mode).

### 15.1.1 Editor limitations with vi

The following list provides the maximum limits of the vi editor. These counts assume single-byte characters.

- ▶ {LINE\_MAX} characters per line
- ▶ 256 characters per global command list
- ▶ 128 characters in the previously inserted and deleted text
- ▶ 128 characters in a shell escape command
- ▶ 128 characters in a string-valued option
- ▶ 30 characters in a tag name
- ▶ 128 map macros with 2048 characters total
- ▶ 1,048,560 lines of {LINE\_MAX} characters per line silently enforced

**Note:** Running the vi editor on a file larger than 64 MB may cause the following error message to display:

```
0602-103 file too large to place in /tmp
```

### 15.1.2 Editing modes in vi

The vi editor operates in the following modes:

**command mode** When you start the vi editor, it is in command mode. You can enter any subcommand except those designated for use only in the text input mode. The vi editor returns to command mode when subcommands and other modes end. Press the Esc key to cancel a subcommand.

**text-input mode** You use the vi editor in this mode to add text. Enter text input mode with any of the following subcommands: a, A, i, I, o, O, cx (where the x represents the scope of the subcommand), C, s, S, and R. After entering one of these subcommands, you can enter text into the editing buffer. To return to

command mode, press the Esc key for normal exit or press Interrupt (the Ctrl-C key sequence) to end abnormally.

### last-line mode

Subcommands with the prefix : (colon), / (slash), ? (question mark), ! (exclamation point), or !! (two exclamation points) read input on a line displayed at the bottom of the screen. When you enter the initial character, the vi editor places the cursor at the bottom of the screen, where you enter the remaining characters of the command. Press the Enter key to run the subcommand, or press Interrupt (the Ctrl-C key sequence) to cancel it. When the !! prefix is used, the cursor moves only after both exclamation points are entered. When you use the : prefix to enter the last-line mode, the vi editor gives special meaning to the following characters when they are used before commands that specify counts:

- % All lines regardless of cursor position
- \$ Last line
- .

## 15.1.3 The vi command flags

Table 15-1 provides the flags that can be used with the vi command.

Table 15-1 The vi editor flags

| Flag                | Flag description                                                                                                                                                                                                          |
|---------------------|---------------------------------------------------------------------------------------------------------------------------------------------------------------------------------------------------------------------------|
| <i>-cSubcommand</i> | Carries out the ex editor subcommand before viewing with vi begins. The cursor moves to the line affected by the last subcommand to be carried out.                                                                       |
| -l                  | Enters the vi editor in LISP mode. In this mode, the vi editor creates indents appropriate for LISP code, and the (, ), {, }, [[, and ]] subcommands are modified to act appropriately for LISP.                          |
| <i>-r[File]</i>     | Recovers a file after a vi editor or system malfunction. If you do not specify the File variable, the vi editor displays a list of all saved files.                                                                       |
| -R                  | Sets the read-only option to protect the file against overwriting.                                                                                                                                                        |
| <i>-t Tag</i>       | Edits the file containing the <i>Tag</i> variable and positions the vi editor at its definition. To use this flag, you must first create a database of function names and their locations using the <b>ctags</b> command. |
| -v                  | Enters the vi editor in the verbose mode.                                                                                                                                                                                 |

| Flag                  | Flag description                                                                                                                                                                                                                                         |
|-----------------------|----------------------------------------------------------------------------------------------------------------------------------------------------------------------------------------------------------------------------------------------------------|
| <i>-wNumber</i>       | Sets the default window size to the value specified by the Number variable. This flag is useful when you use the vi editor over a low-speed line.                                                                                                        |
| <i>-yNumber</i>       | Overrides the maximum line setting of 1,048,560 with any value greater than 1024. You should request twice the number of lines that you require because the vi editor uses the extra lines for buffer manipulation.                                      |
| <i>+ [Subcommand]</i> | Carries out the ex editor subcommand before editing begins. If you do not specify the Subcommand variable, the cursor is placed on the first line of the file. This + flag is incompatible with the -c flag. Do not specify both flags at the same time. |

### 15.1.4 Editor subcommands in vi

The list of subcommands is very extensive, so you are only going to learn some of the more common subcommands used. You would use the subcommands to perform these kinds of actions:

- ▶ Moving the cursor
- ▶ Editing text
- ▶ Manipulating files
- ▶ Other actions

Enter the following subcommands in command mode. You can cancel an incomplete command by pressing the Esc key.

#### Moving the cursor

Use subcommands to move the cursor within a file in these ways:

- ▶ Moving within a line
 

|                                         |                                                                 |
|-----------------------------------------|-----------------------------------------------------------------|
| <b>Left Arrow, h, or Ctrl-H</b>         | Moves the cursor one character to the left.                     |
| <b>Down Arrow, j, Ctrl-J, or Ctrl-N</b> | Moves the cursor down one line (it remains in the same column). |
| <b>Up Arrow, k, or Ctrl-P</b>           | Moves the cursor up one line (it remains in the same column).   |
| <b>Right Arrow or l</b>                 | Moves the cursor one character to the right.                    |

- ▶ Moving within a line by character position
  - ^** Moves the cursor to the first nonblank character.
  - 0** Moves the cursor to the beginning of the line.
  - \$** Moves the cursor to the end of the line.
  - fx** Moves the cursor to the next x character.
  - Fx** Moves the cursor to the last x character.
  - tx** Moves the cursor to one column before the next x character.
  - Tx** Moves the cursor to one column after the last x character.
  - ;** Repeats the last f, F, t, or T subcommand.
  - ,** Repeats the last f, F, t, or T subcommand in the opposite direction.
- ▶ Moving to words
  - w** Moves the cursor to the next small word.
  - b** Moves the cursor to the previous small word.
  - e** Moves the cursor to the next end of a small word.
  - W** Moves the cursor to the next big word.
  - B** Moves the cursor to the previous big word.
  - E** Moves the cursor to the next end of a big word.
- ▶ Moving by line position
  - H** Moves the cursor to the top line on the screen.
  - L** Moves the cursor to the last line on the screen.
  - M** Moves the cursor to the middle line on the screen.
  - G** Moves the cursor to the last line of the file.
  - 1G** Moves the cursor to the first line of the file.
  - nG** Moves the cursor to the *n*th line of the file.
  - +** Moves the cursor to the next line at its first nonblank character.
  - Moves the cursor to the previous line at its first nonblank character.
  - Enter** Moves the cursor to the next line at its first nonblank character.
- ▶ Moving to sentences, paragraphs, or sections
  - (** Places the cursor at the beginning of the previous sentence.
  - )** Places the cursor at the beginning of the next sentence.
  - {** Places the cursor at the beginning of the previous paragraph.

- } Places the cursor at the beginning of the next paragraph, or at the next section if you are in C mode.
- ]] Places the cursor at the next section.
- [[ Places the cursor at the previous section.

## Editing text

The subcommands for editing enable you to perform the following tasks:

- ▶ Marking a specific location in a file and returning
  - " Moves the cursor to the previous location of the current line.
  - " Moves the cursor to the beginning of the line containing the previous location of the current line.
  - mx** Marks the current position with the letter specified by the x parameter.
  - `x** Moves the cursor to the mark specified by the x parameter.
  - 'x** Moves the cursor to the beginning of the line containing the mark specified by the x parameter.
- ▶ Adding text to a file
  - aText** Inserts text specified by the *Text* parameter after the cursor. End text input mode by pressing the Esc key.
  - AText** Adds text specified by the *Text* parameter to the end of the line. End text input mode by pressing the Esc key.
  - iText** Inserts text specified by the *Text* parameter before the cursor. End text input mode by pressing the Esc key.
  - IText** Inserts text specified by the *Text* parameter before the first non-blank character in the line. End text input mode by pressing the Esc key.
  - o** Adds an empty line below the current line. End text input mode by pressing the Esc key.
  - O** Adds an empty line above the current line. End text input mode by pressing the Esc key.
- ▶ Changing text while in input mode
  - Ctrl-D** Goes back to previous autoindent stop.
  - ^ Ctrl-D** Ends autoindent for this line only.
  - 0Ctrl-D** Moves cursor back to left margin.
  - Esc** Ends insertion and returns to command state.
  - Ctrl-H** Erases the last character.

- Ctrl-Q** Enters any character if xon is disabled.
- Ctrl-V** Enters any character.
- Ctrl-W** Erases the last small word.
- \** Quotes the erase and kill characters.
- Ctrl-?** Interrupts and ends insert or the Ctrl-D key sequence.
- ▶ Changing text from command mode
  - C** Changes the rest of the line (same as c\$).
  - cc** Changes a line.
  - cw** Changes a word.
  - cwText** Changes a word to the text specified by the Text parameter.
  - D** Deletes the rest of the line (same as d\$).
  - dd** Deletes a line.
  - dw** Deletes a word.
  - J** Joins lines.
  - rx** Replaces the current character with the character specified by x.
  - RText** Overwrites characters with the text specified by the Text parameter.
  - s** Substitutes characters (same as cl).
  - S** Substitutes lines (same as cc).
  - u** Undoes the previous change.
  - x** Deletes a character at the cursor.
  - X** Deletes a character before the cursor (same as dh).
  - <<** Shifts one line to the left.
  - <L** Shifts all lines from the cursor to the end of the screen to the left.
  - >>** Shifts one line to the right.
  - >L** Shifts all lines from the cursor to the end of the screen to the right.
  - ~** Changes letter at the cursor to the opposite case.
- ▶ Copying and moving text
  - p** Puts back text from the undo buffer after the cursor.
  - P** Puts back text from the undo buffer before the cursor.
  - "xp** Puts back text from the x buffer.
  - "xd** Deletes text into the x buffer.

- y** Places the object that follows (for example, w for word) into the undo buffer.
- "xy** Places the object that follows into the x buffer, where x is any letter.
- Y** Places the line in the undo buffer.
- ▶ Restoring and repeating changes
  - u** Undoes the last change.

**Note:** After an undo, the cursor moves to the first non-blank character on the updated current line.

- U** Restores the current line, if the cursor has not left the line since the last change.
- .** Repeats the last change or increments the "np subcommand.

**Note:**

1. This subcommand will repeat the last change, including an undo. Therefore, after an undo, repeat performs an undo rather than repeat the last change.
2. This subcommand is not meant for use with a macro. Enter @@ (two at signs) to repeat a macro.

- "np** Retrieves the nth last delete of a complete line or block of lines.

## Manipulating files

The subcommands for manipulating files allow you to do the tasks outlined in the following sections:

- ▶ Saving changes to a file
  - :w** Writes the edit buffer contents to the original file.
  - :w File** Writes the edit buffer contents to the file specified by the File parameter.
  - :w! File** Overwrites the file specified by the File parameter with the edit buffer contents.
- ▶ Editing a second file
  - :e File** Edits the specified file.
  - :e!** Re-edits the current file and discards all changes.
  - :e + File** Edits the specified file starting at the end.



|                                |                                                                                                                                                                                                                                                                                                                      |
|--------------------------------|----------------------------------------------------------------------------------------------------------------------------------------------------------------------------------------------------------------------------------------------------------------------------------------------------------------------|
| <b>:e + <i>Number File</i></b> | Edits the specified file starting at the specified line number.                                                                                                                                                                                                                                                      |
| <b>:e #</b>                    | Edits the alternate file. The alternate file is usually the previous file name before accessing another file with a <b>:e</b> command. However, if changes are pending on the current file when a new file is called, the new file becomes the alternate file. This subcommand is the same as the Ctrl-A subcommand. |
| <b>:r <i>File</i></b>          | Reads the file into the editing buffer by adding new lines below the current line.                                                                                                                                                                                                                                   |
| <b>:r !<i>Command</i></b>      | Runs the specified AIX command and places its output into the file by adding new lines below the current cursor position.                                                                                                                                                                                            |
| <b>:ta <i>Tag</i></b>          | Edits a file containing the Tag tag starting at the location of the tag. To use this subcommand, you must first create a database of function names and their locations using the <b>ctags</b> command.                                                                                                              |
| <b>Ctrl-A</b>                  | Edits the alternate file. The alternate file is usually the previous current file name. However, if changes are pending on the current file when a new file is called, the new file becomes the alternate file. This subcommand is the same as the <b>:e #</b> subcommand.                                           |

► Editing a list of files

|                        |                                                              |
|------------------------|--------------------------------------------------------------|
| <b>:n</b>              | Edits the next file in the list entered on the command line. |
| <b>:n <i>Files</i></b> | Specifies a new list of files to edit.                       |

► Finding file information

|               |                                                                                                                                                        |
|---------------|--------------------------------------------------------------------------------------------------------------------------------------------------------|
| <b>Ctrl-G</b> | Shows the current file name, current line number, number of lines in the file, and percentage of the way through the file where the cursor is located. |
|---------------|--------------------------------------------------------------------------------------------------------------------------------------------------------|

## Other actions

The vi editor provides the subcommands described in the following sections:

► Adjusting the screen

|               |                                                                        |
|---------------|------------------------------------------------------------------------|
| <b>Ctrl-L</b> | Clears and redraws the screen.                                         |
| <b>Ctrl-R</b> | Redraws the screen and eliminates blank lines marked with @ (at sign). |

**z*Number*** Makes the window the specified number of lines long.

► Entering shell commands

**:sh** Enters the shell to allow you to run more than one AIX command. You can return to the vi editor by pressing the Ctrl-D key sequence.

**!:Command** Runs the specified AIX command and then returns to the vi editor.

**Note:** The # (alternate file), % (current file), and ! (previous command) special characters are expanded when following a :! subcommand. To prevent any of these characters from being expanded, use the \ (backslash).

**:!!** Repeats the last :!Command subcommand.

**Number!!Command** Runs the specified AIX command and replaces the lines specified by Number with the output of the command. If a number is not specified, the default value is 1. If the command expects standard input, the specified lines are used as input.

**!Object Command** Runs the specified AIX command and replaces the object specified by the Object parameter with the output of the command. If the command expects standard input, the specified object is used as input.

► Interrupting and ending the vi editor

**Q** Enters the ex editor in command mode.

**ZZ** Exits the vi editor, saving changes.

**:q** Quits the vi editor. If you have changed the contents of the editing buffer, the vi editor displays a warning message and does not quit.

**:q!** Quits the vi editor, discarding the editing buffer.

**Esc** Ends text input or ends an incomplete subcommand.

**Ctrl-?** Interrupts a subcommand.

## Other actions

To set the vi editor up as your default editor, use the **EDITOR** command. The EDITOR variable can also be put into the user .profile or the /etc/profile file:

```
EDITOR=vi
```

**Note:** The **EDITOR** command sets a variable and must not be confused with the **set -o vi** command, which sets up command line editing.

## 15.2 Editing a file using the vi editor

In this section, you will learn how to edit a file. You will learn how to replace multiple characters, replace one character, delete a character, delete a line, copy a line, find a word, insert characters, and insert a line.

In this example you have a file called *yourfile*. In this file, you are running a few simple commands and sending the output for each to your screen.

The yourfile file looks like this:

```
#
$HOME/yourfile
#
This file contains some commands that are run by the user.
df
lsfs rootvg
lslv hdisk1
lsdev -Cc disk
```

### 15.2.1 Inserting text using the vi editor

As you look at the file above, you see that you want the **df** command to display the file system space in 1024 KB blocks, not 512. You also want the script to list what is in the current directory at the end of the script. To edit the file, enter:

```
vi yourfile
```

Figure 15-1 on page 382 is the display for the vi editor.



Your line will look like this:

```
df -k
```

Press the Esc key once. You have now moved out of edit mode back into command mode. Your cursor will be under the k.

Now add the `1s -1` of the current directory at the end of the file. Using any one of the Down Arrow, j, Ctrl-J, or Ctrl-N keys, go to the bottom of the file. The cursor will be under the v in the `1sdev` command; either use the Left Arrow, h, Ctrl-H, or O keys to move to the beginning of the line. Your cursor should be under the l of the `1sdev` command. To insert a new line below the current line, press o; you will see the cursor under the l of the `1sdev` command but one line down. Type the following:

```
s -1
```

Press Esc once to go back into command mode. You will notice that this command is incorrect. What you need to do is insert the l for the `1s -1` command and press O to take you to the beginning of the line. Your cursor is under the s; press the i key, then type:

```
l
```

Press Esc once to go back to command line. Your line should look like this:

```
1s -1
```

To save the file, there are two options to save and quit.

► Option 1

Hold the Shift and ; ( : ); the cursor will go to the bottom left of the screen next to a :. At the :, you can type `wq!`, which overwrites the original file and then quits.

► Option 2

Hold the Shift and press z twice (ZZ). This will save and quit, taking you back to your AIX command prompt.

To view the file, type:

```
cat yourfile
```

The output of the `cat` command is as follows:

```
#
$HOME/yourfile
#
This file contains some commands that are run by the user.
df -k
lsfs rootvg
lspv hdisk1
lsdev -Cc disk
ls -l
```

## 15.2.2 Changing text using the vi editor

On closer inspection of the file `yourfile` you notice that there are a few mistakes, and you now want to correct them. To correct them, type:

```
vi yourfile
```

You will see the cursor at the top right side of your monitor.

The first thing you want to do is fix the `1sfs` command. You do not want it to be `1sfs`, because it should be the `1svg` command. You also want to check the volume group `uservg`, not `rootvg`.

Press any of the Down Arrow, `j`, `Ctrl-J`, or `Ctrl-N` keys until you are under the `l` of the `1sfs` command.

You can also use the find option. Press the `/` key; it will take you to the bottom right of the screen and you will see a `/` before the cursor. Here you can type `1sfs` and it will take you to the beginning of the `1sfs` command.

Using the Right Arrow or `l` key, move the cursor below the `f` of the `1sfs` command. Press the Shift key and `r` (`R`) simultaneously. The cursor will still be under the `f` of the `1sfs` command. Type `vg`; you will see that it has overwritten the `fs` with `vg`. Press `Esc` once to go back into command mode. Your cursor is now under the `g` in the `1svg` command.

Using the Right Arrow, move the cursor to underneath the `r` of `rootvg`. Type `cw`, and you will see a `$` sign at the end of the word `rootvg`. Type `uservg`; you will notice that it has overwritten `rootvg`. Press `Esc` once and your cursor will be under the `g` of `uservg`.

Issue the command **lspv** on both `hdisk1` and `hdisk0`. Press the Down Arrow key once to go down one line. You will notice that your cursor is under the 1 of `hdisk1`. Press your y key twice (`yy`); you have just yanked or copied the line. Press p key to place your yanked line and you will see that the line has been duplicated. Notice that your cursor is at the beginning of the new line. Your file should look like this:

```
lspv hdisk1
lspv hdisk1
```

Using the Right Arrow key, move your cursor until it is under the 1 of the second `hdisk1`. Use your Up Arrow key to go up to the first `hdisk1`. Press the r key and then the 0. You will notice that the 1 has changed to a 0. You do not need to press the Esc key, because this is a single character replacement. Your lines should now look like this:

```
lspv hdisk0
lspv hdisk1
```

Looking at the line with the **lsdev -Cc disk** command, you decide that you want this command to display all the devices, not just the disks. Using the Down Arrow key, go to the line with the **lsdev** command. Using the Right Arrow key, put the cursor under the c, press the x, and you will see the c disappear. Use the Right Arrow key to go under the d of the word `disk`. Press the d key twice (`dd`), you will notice the whole line has disappeared. Press the u key once and you will notice that the line has come back. Now press the d key, then the w key. The word `disk` has now disappeared. Press the Esc key once. Your line will now look like this:

```
lsdev -C
```

Press the Shift zz (`ZZ`) to save and exit.

Type the following command:

```
cat yourfile
```

to display your file. It should appear like this:

```
#
$HOME/yourfile
#
This file contains some commands that are run by the user.
df -k
lsvg uservg
lspv hdisk1
lspv hdisk0
lsdev -C
ls -l
```

To replace multiple occurrences of text, you can use the `s` subcommand. In the above example, if you wanted to change the `lspv` commands to have the `-p` flag, edit the file using `vi` and then change the command using a subcommand as follows:

```
vi yourfile
```

The cursor will be at the top left hand side. Type `Shift` and `;` (`:`); the cursor will go into the command line editor at the bottom left side of the screen. To edit, type:

```
%s/lspv/lspv -p
```

This will replace all `lspv` commands to `lspv -p`. Save the file and exit.

Type the command:

```
cat yourfile
```

to display your file. It should appear like this:

```

$HOME/yourfile

This file contains some commands that are run by the user.
df -k
lsvg uservg
lspv -p hdisk1
lspv -p hdisk0
lsdev -C
ls -l
```

To replace multiple occurrences of text that include the forward slash (`/`) character, the `s` subcommand can also be used with a slight variation. In the above example, you decide that you want to have the `df` and `ls` commands display only information for `/home`. First type:

```
vi yourfile
```

You can see that the `ls -l` command is at the last line of the file, so press the `Shift` key and `g` (`G`) simultaneously. This will take the cursor down to the last line of the file. Using the `Right Arrow`, `l`, or `$` key, go to the end of the line and press a `^` to go into insert mode. Type in `home/`, misplacing the forward slash at the end of the file system name. Your line will look like this:

```
ls -l home/
```



Press Esc twice to go back into command mode. Since you can see that the **df -k** command is at the fifth line of the file; press the 5 key, then press the Shift key and g (G) simultaneously. This will take the cursor to the fifth line of the file. Using the Right Arrow, l, or \$ key, go to the end of the line and press a to go into insert mode. Type in `home/`, misplacing the forward slash again. Your line will look like this:

```
df -k home/
```

Before you save and quit the file, you want to correct the two misplacements you just made, changing all instances of `home/` to `/home`. To do this, press Esc twice to go into command mode. Type Shift and ; (:), causing the cursor to go into the command line editor at the bottom left of the screen. To edit, type:

```
%s/home\\/\//home
```

This will replace all instances of `home/` to `/home`. The **vi** command interprets the backslash as a marker to read the next character normally, not as part of a command. It is important to put in the backslash (\) before every instance of forward slash (/) that is to be part of the replacement, otherwise **vi** will misinterpret the forward slash and may make unwanted modifications to your file.

Save and quit the file by typing `:wq!` while in command mode. View the contents of the file by typing:

```
cat yourfile
```

Your file should look like this:

```

$HOME/yourfile

This file contains some commands that are run by the user.
df -k /home
lsvg uservg
lspv -p hdisk1
lspv -p hdisk0
lsdev -C
ls -l /home
```

## 15.3 Viewing files and string settings

The **cat** command is used to view an ASCII file and there are various commands available. The **cat** command concatenates or displays files. The **cat** command reads each file parameter in sequence and writes it to standard output. If you do not specify a file name, the **cat** command reads from standard input. You can also specify a file name of - (dash) for standard input.

**Note:** Do not redirect output to one of the input files using the redirection symbol, > (caret). If you do this, you lose the original data in the input file because the shell truncates the file before the **cat** command can read it.

The **cat** command syntax is as follows:

```
cat [-q] [-r] [-s] [-S] [-u] [-n [-b]] [-v [-e] [-t]]
[- | File ...]
```

Table 15-2 provides the flags that can be used with the **cat** command.

*Table 15-2 The cat command flags and flag descriptions*

| Flag | Flag description                                                                                                       |
|------|------------------------------------------------------------------------------------------------------------------------|
| -b   | Omits line numbers from blank lines, when specified with the -n flag.                                                  |
| -e   | Displays a \$ (dollar sign) at the end of each line, when specified with the -v flag.                                  |
| -n   | Displays output lines preceded by line numbers, numbered sequentially from 1.                                          |
| -q   | Does not display a message if the <b>cat</b> command cannot find an input file. This flag is identical to the -s flag. |
| -r   | Replaces multiple consecutive empty lines with one empty line. This flag is identical to the -S flag.                  |
| -s   | Does not display a message if the <b>cat</b> command cannot find an input file. This flag is identical to the -q flag. |
| -S   | Replaces multiple consecutive empty lines with one empty line. This flag is identical to the -r flag.                  |
| -t   | Displays tab characters as ^, if specified with the -v flag.                                                           |
| -u   | Does not buffer output.                                                                                                |
| -v   | Displays non-printing characters as visible characters.                                                                |
| -    | Allows standard input to the <b>cat</b> command.                                                                       |

Examples using the **cat** command are listed in the following:

- To display a file at the workstation, enter:

```
cat /etc/hosts
```

This command displays the data in the /etc/hosts file. If the file is more than one less than the number of available display lines, some of the file scrolls off the screen. To list a file one page at a time, use the **pg** command:

```
@(#)47 1.1 src/bos/usr/sbin/netstart/hosts, cmdnet, bos430,
9737A_430
7/24/91 10:00:46
IBM_PROLOG_BEGIN_TAG
..... (Lines Removed)
/etc/hosts
#
This file contains the host names and their address for hosts in the
network. This file is used to resolve a host name into an Internet
address.
#
At minimum, this file must contain the name and address for each
device defined for TCP in your /etc/net file. It may also contain
entries for well-known (reserved) names such as timeserver
and printserver as well as any other host name and address.
#
The format of this file is:
Internet Address Hostname # Comments
Items are separated by any number of blanks and/or tabs. A '#'
indicates the beginning of a comment; characters up to the end of the
line are not interpreted by routines which search this file. Blank
lines are allowed.

Internet Address Hostname # Comments
192.9.200.1 net0sample # ethernet name/address
128.100.0.1 token0sample # token ring name/address
10.2.0.2 x25sample # x.25 name/address
127.0.0.1 loopback localhost # loopback (lo0)
19.33.1.12 yourhost yourhost.hometown.com
#
```

- ▶ To concatenate several files, enter:

```
cat /etc/passwd /etc/hosts > yourfile
```

This command creates a file named yourfile that is a copy of /etc/passwd followed by /etc/hosts.

- ▶ To suppress error messages about files that do not exist, enter:

```
cat -q /etc/password
```

If you do not use the -q option you would get this error:

```
cat: 0652-050 Cannot open /etc/password.
```

- ▶ To append one file to the end of another, enter:

```
cat /etc/filesystems >> yourfile
```

The >> (two carets) appends a copy of the file /etc/filesystems to the end of the file yourfile. If you want to replace the file, use the > (caret).

- ▶ To add text to the end of a file, enter:

```
cat >>yourfile
Create new user bob.
Ctrl-D
```

This command adds Create new user bob to the end of the file called yourfile. The **cat** command does not prompt; it waits for you to enter text. Press the Ctrl-D key sequence to indicate you are finished.

- ▶ To concatenate several files with text entered from the keyboard, enter:

```
cat /etc/passwd - /etc/hosts >yourfile
THIS IS THE SEPARATOR LINE
Ctrl-D
```

This command concatenates /etc/passwd, text from the keyboard (THIS IS THE SEPARATOR LINE (indicated by the minus sign)), and /etc/hosts.

- ▶ To concatenate several files with output from another command, enter:

```
ls | cat /etc/passwd - >yournewfile
```

This command copies /etc/passwd, and then the output of the **ls** command to the file yournewfile.

### 15.3.1 Using the pg command to view files

Formats files to the display. The **pg** command reads a file name from the file parameter and writes the file to standard output one screen at a time. If you specify a - (dash) as the file parameter, or run the **pg** command without options, the **pg** command reads standard input. Each screen is followed by a prompt. If you press the Enter key, another page is displayed. Subcommands used with the **pg** command let you review or search in the file.

To determine workstation attributes, the **pg** command scans the file for the workstation type specified by the TERM environment variable. The default type is dumb.

The **pg** command syntax is as follows:

```
pg [-Number] [-c] [-e] [-f] [-n] [-p String] [-s]
[+LineNumber] [+/Pattern/] [File ...]
```

Table 15-3 provides the flags that can be used with the **pg** command.

Table 15-3 The *pg* command flags and flag descriptions

| Flag                | Flag description                                                                                                                                                                                                                                                                                        |
|---------------------|---------------------------------------------------------------------------------------------------------------------------------------------------------------------------------------------------------------------------------------------------------------------------------------------------------|
| -c                  | Moves the cursor to the home position and clears the screen before each page. This flag is ignored if the <code>clear_screen</code> field is not defined for your workstation type in the <code>terminfo</code> file.                                                                                   |
| -e                  | Does not pause at the end of each file.                                                                                                                                                                                                                                                                 |
| -f                  | Does not split lines. Normally, the <b>pg</b> command splits lines longer than the screen width.                                                                                                                                                                                                        |
| -n                  | Stops processing when a <b>pg</b> command letter is entered. Normally, commands must end with a new line character.                                                                                                                                                                                     |
| -p <i>String</i>    | Uses the specified string as the prompt. If the <i>String</i> contains a <code>%d</code> value, that value is replaced by the current page number in the prompt. The default prompt is <code>:</code> (colon). If the specified string contains spaces, you must enclose the string in quotation marks. |
| -s                  | Highlights all messages and prompts.                                                                                                                                                                                                                                                                    |
| + <i>LineNumber</i> | Starts at the specified line number.                                                                                                                                                                                                                                                                    |
| - <i>Number</i>     | Specifies the number of lines in the window. On workstations that contain 24 lines, the default is 23.                                                                                                                                                                                                  |
| +/ <i>Pattern</i> / | Starts at the first line that contains the specified pattern.                                                                                                                                                                                                                                           |

When the **pg** command pauses and issues a prompt, you can issue a subcommand. Some of these subcommands change the display to a particular place in the file, some search for specific patterns in the text, and others change the environment in which the **pg** command works.

Table 15-4 provides a list of the subcommands for the **pg** command.

Table 15-4 Subcommands for *pg*

| Subcommand                                                             | Subcommand description                                                                   |
|------------------------------------------------------------------------|------------------------------------------------------------------------------------------|
| <b>The following subcommands display a selected place in the file.</b> |                                                                                          |
| Page                                                                   | Displays the page specified by the <code>Page</code> parameter.                          |
| + <i>Number</i>                                                        | Displays the page obtained by adding the <code>Number</code> value to the current page.  |
| - <i>Number</i>                                                        | Displays the page as specified by the <code>Number</code> value before the current page. |

| Subcommand                                                                       | Subcommand description                                                                                                                                                                                                                                                                         |
|----------------------------------------------------------------------------------|------------------------------------------------------------------------------------------------------------------------------------------------------------------------------------------------------------------------------------------------------------------------------------------------|
| <b>The following subcommands display a selected place in the file.</b>           |                                                                                                                                                                                                                                                                                                |
| l                                                                                | (Lowercase L) Scrolls the display one line forward.                                                                                                                                                                                                                                            |
| <i>Number</i> l                                                                  | Displays at the top of the screen the line specified by the <i>Number</i> parameter.                                                                                                                                                                                                           |
| + <i>Number</i> l                                                                | Scrolls the display forward for the specified number of lines.                                                                                                                                                                                                                                 |
| - <i>Number</i> l                                                                | Scrolls the display backward for the specified number of lines.                                                                                                                                                                                                                                |
| d or Ctrl-D                                                                      | Scrolls half a screen forward.                                                                                                                                                                                                                                                                 |
| -d or -Ctrl-D                                                                    | Scrolls half a screen backward.                                                                                                                                                                                                                                                                |
| Ctrl-L or . (dot)                                                                | Displays the current page again.                                                                                                                                                                                                                                                               |
| \$                                                                               | Displays the last page in the file. Do not use this when the input is from a pipeline.                                                                                                                                                                                                         |
| <b>The following subcommands search for text patterns in the text.</b>           |                                                                                                                                                                                                                                                                                                |
| [ <i>Number</i> ]/ <i>Pattern</i> /                                              | Searches for the occurrence of the <i>Pattern</i> value as specified by the <i>Number</i> variable. The search begins immediately after the current page and continues to the end of the current file, without wraparound. The default for the <i>Number</i> variable is 1.                    |
| <i>Number</i> ? <i>Pattern</i> ?<br><i>Number</i> ^ <i>Pattern</i> ^             | Searches backward for the occurrence of the <i>Pattern</i> value as specified by the <i>Number</i> variable. The searching begins immediately before the current page and continues to the beginning of the current file, without wraparound. The default for the <i>Number</i> variable is 1. |
| <b>You can change the pg command environment with the following subcommands.</b> |                                                                                                                                                                                                                                                                                                |
| [ <i>Number</i> ]n                                                               | Begins examining the next file in the command line, as specified by the <i>Number</i> variable. The default for the <i>Number</i> variable is first.                                                                                                                                           |
| [ <i>Number</i> ]p                                                               | Begins examining the previous file on the command line, as specified by the <i>Number</i> variable. The default for the <i>Number</i> variable is first.                                                                                                                                       |
| [ <i>Number</i> ]w or<br>[ <i>Number</i> ]z                                      | Displays another window of text. If the <i>Number</i> variable is specified, it sets the window size to the number of lines it specifies.                                                                                                                                                      |
| s <i>File</i>                                                                    | Saves the input in the specified file. Only the current file being examined is saved. This command must always end with a new-line character, even if you specify the -n flag.                                                                                                                 |

| Subcommand                                                             | Subcommand description                                                                                                                                                                                                      |
|------------------------------------------------------------------------|-----------------------------------------------------------------------------------------------------------------------------------------------------------------------------------------------------------------------------|
| <b>The following subcommands display a selected place in the file.</b> |                                                                                                                                                                                                                             |
| h                                                                      | Displays an abbreviated summary of available subcommands.                                                                                                                                                                   |
| q or Q                                                                 | Quits the <b>pg</b> command.                                                                                                                                                                                                |
| <i>!Command</i>                                                        | Sends the specified command to the shell named in the SHELL environment variable. If this is not available, the default shell is used. This command must always end with a new-line character, even if the -n flag is used. |

Examples using the **pg** command are provided in the following:

- ▶ To look at the contents of a file one page at a time, enter:

```
pg /etc/hosts
@(#)47 1.1 src/bos/usr/sbin/netstart/hosts, cmdnet, bos430,
9737A_430
7/24/91 10:00:46
IBM_PROLOG_BEGIN_TAG
..... (Lines Removed)
/etc/hosts
#
This file contains the host names and their address for hosts in the
indicates the beginning of a comment; characters up to the end of the
line are not interpreted by routines which search this file. Blank
lines are allowed.
..... (Lines Removed)
Internet Address Hostname # Comments
192.9.200.1 net0sample # ethernet name/address
128.100.0.1 token0sample # token ring name/address
10.2.0.2 x25sample # x.25 name/address
127.0.0.1 loopback localhost # loopback (lo0)
name/address
(EOF):
```

This is the end of the file. Press Enter to go back to the command prompt.

- ▶ To view the contents of a file with all messages and prompts highlighted, enter:

```
pg -s /etc/hosts
```

Figure 15-2 on page 394 shows the output of the **pg -s** command. Notice that the prompt (: ) at the bottom of the screen has been highlighted.

```

@(#)47 1.1 src/bos/usr/sbin/netstart/hosts, cmdnet, bos430, 9737A_430
7/24/91 10:00:46
IBM_PROLOG_BEGIN_TAG
This is an automatically generated prolog.
#
bos430 src/bos/usr/sbin/netstart/hosts 1.1
#
Licensed Materials - Property of IBM
#
(C) COPYRIGHT International Business Machines Corp. 1985,1989
All Rights Reserved
#
US Government Users Restricted Rights - Use, duplication or
disclosure restricted by GSA ADP Schedule Contract with IBM Corp.
#
IBM_PROLOG_END_TAG
#
COMPONENT_NAME: TCPIP hosts
#
FUNCTIONS: loopback
#
ORIGINS: 26 27
#
(C) COPYRIGHT International Business Machines Corp. 1985, 1989
#

```

Figure 15-2 The `pg -s` command with highlighted prompt

### 15.3.2 Using the view command to view files

The **view** command starts the vi full-screen editor in read-only mode (view = vi -R). The read-only mode is only advisory to prevent accidental changes to the file.

The **view** command syntax is as follows:

```
view [-cSubcommand] [-l] [-t Tag] [-wNumber] [-y] [-r [File]]
[+ [Subcommand]] [File ...]
```

Table 15-5 provides a list of the flags for the **view** command.

Table 15-5 Table of flags for the view command

| Flag         | Flag description                                                                                                                                                          |
|--------------|---------------------------------------------------------------------------------------------------------------------------------------------------------------------------|
| -cSubcommand | Carries out the ex editor subcommand before viewing with vi begins. When a null operand is entered, as in -c", the editor places the cursor on the last line of the file. |



| Flag                  | Flag description                                                                                                                                                                                                                                                               |
|-----------------------|--------------------------------------------------------------------------------------------------------------------------------------------------------------------------------------------------------------------------------------------------------------------------------|
| -l                    | Enters a version of the vi editor with specialized features designed for writing programs in the LISP language. In this mode, the vi editor indents appropriately for LISP programming, and the (, ), {, }, [[, and ]] subcommands are modified to act appropriately for LISP. |
| -r [ <i>File</i> ]    | Recovers a file after an editor or system crash. If you do not specify a File parameter, the editor displays a list of all saved files.                                                                                                                                        |
| -t <i>Tag</i>         | Edits the file containing the tag specified by the Tag parameter and positions the editor at its definition. To use this flag, you must first create a database of function names and their locations using the <b>ctags</b> command.                                          |
| -w <i>Number</i>      | Sets the default window size to the value specified by the Number parameter. This is useful when your terminal communicates with the system running the editor over a slow communications line.                                                                                |
| -y                    | Overrides the maximum line setting of 1,048,560 with any value greater than 1024.                                                                                                                                                                                              |
| + <i>[Subcommand]</i> | Carries out the ex editor subcommand specified by the Subcommand parameter before viewing with vi begins. If you do not specify a subcommand, the cursor is placed on the last line of the file.                                                                               |

See Section 15.1, “The vi file editor” on page 372 to understand the vi editor.

### 15.3.3 Using the echo command

The **echo** command writes character strings to standard output. *Strings* are separated by spaces, and a new-line character follows the last String parameter specified.

The **echo** command syntax is as follows:

```
echo [String ...]
```

The **echo** command recognizes the escape conventions, as shown in Table 15-6.

Table 15-6 *Escape conventions used with the echo command*

| Escape convention | Escape convention description   |
|-------------------|---------------------------------|
| \a                | Displays an alert character.    |
| \b                | Displays a backspace character. |

| Escape convention | Escape convention description                                                                                                                    |
|-------------------|--------------------------------------------------------------------------------------------------------------------------------------------------|
| \c                | Suppresses the new line character that otherwise follows the final argument in the output. All characters following the \c sequence are ignored. |
| \f                | Displays a form-feed character.                                                                                                                  |
| \n                | Displays a new-line character.                                                                                                                   |
| \r                | Displays a carriage return character.                                                                                                            |
| \t                | Displays a tab character.                                                                                                                        |
| \v                | Displays a vertical tab character.                                                                                                               |
| \\                | Displays a backslash character.                                                                                                                  |
| \0 <i>Number</i>  | Displays an 8-bit character whose ASCII value is a 0-, 1-, 2-, or 3-digit octal number.                                                          |

Examples using the **echo** command are provided in the following:

- ▶ To write a message to standard output, enter:

```
echo Please read your MAIL
Please read your MAIL
#
```

- ▶ To display a message containing special characters, enter:

```
echo "\n\n\nGone to lunch.\nWill be back at 2:00."
```

This skips three lines and displays the message:

```
Gone to lunch.
Will be back at 2:00.
```

**Note:** You must put the message in " (quotation marks) if it contains escape sequences. Otherwise, the shell interprets the \ (backslash) as a metacharacter and treats the \ differently.

- ▶ To use the **echo** command with pattern-matching characters, enter:

```
echo The back-up files are: *.bak
The back-up files are: my_file1.bak my_file2.bak my_file3.bak
```

This usage displays the message The back-up files are: followed by the file names in the current directory ending with .bak.

- ▶ To add a single line of text to a file, enter:

```
echo Remember to set the shell search path to $PATH. >>notes
```

This usage adds the message to the end of the file notes after the shell substitutes the value of the PATH shell variable.

- ▶ To write a message to the standard error output, enter:

```
echo Error: file already exists. >&2
```

This command redirects the error message to standard error. If the >&2 is omitted, the message is written to standard output.

### 15.3.4 Using the file command to determine a file type

The **file** command reads the files specified by the File parameter or the *FileList* variable, performs a series of tests on each file, and attempts to classify them by type. The command then writes the file types to standard output.

If a file appears to be in ASCII format, the **file** command examines the first 1024 bytes and determines the file type. If a file does not appear to be in ASCII format, the **file** command further attempts to distinguish a binary data file from a text file that contains extended characters.

If the File parameter specifies an executable or object module file and the version number is greater than 0, the **file** command displays the version stamp.

To classify the file type, use the following command syntax:

```
file [-m MagicFile] [-f FileList] [File...]
```

To check the magic file for Format Errors, use the following command syntax:

```
file-c [-m MagicFile]
```

Table 15-7 provides the flags that can be used by the **file** command.

Table 15-7 The file command flags and flag descriptions

| Flag                | Flag description                                                                                                                                                    |
|---------------------|---------------------------------------------------------------------------------------------------------------------------------------------------------------------|
| -c                  | Checks the specified magic file (the /etc/magic file, by default) for format errors. This validation is not normally done. File typing is not done under this flag. |
| -f <i>FileList</i>  | Reads the specified file list. The file must list one file per line and must not contain leading or trailing spaces.                                                |
| -m <i>MagicFile</i> | Specifies the file name of the magic file (the /etc/magic file, by default).                                                                                        |

Examples using the **file** command are provided in the following:

- ▶ To display the type of information a file contains, enter:

```
file /etc/hosts
/etc/hosts: commands text
```

This displays the file type of myfile (such as directory, data, ASCII text, C-program source, and archive).

- ▶ Create a file called filenames, with the three entries /etc/hosts, /etc/wall, and /usr/sbin/wall. To display the type of each file named in a list of file names, enter:

```
cat filenames
/etc/hosts
/etc/wall
/usr/sbin/wall
file -f filenames
/etc/hosts: commands text
/etc/wall: symbolic link to /usr/sbin/wall.
/usr/sbin/wall: executable (RISC System/6000) or object module
```

This displays the type of each file named in the filenames list. Each file name must appear alone on a line.

### 15.3.5 Using the strings command in object or binary files

The **strings** command looks for printable strings in an object or binary file. A string is any sequence of four or more printable characters that end with a new-line or a null character. The strings command is useful for identifying random object files.

The **strings** command syntax is as follows:

```
strings [-a] [-] [-o] [-t Format] [-n Number] [-Number]
[File ...]
```

Table 15-8 provides the flags that can be used with the **strings** command.

Table 15-8 *The strings command flags and flag descriptions*

| Flag | Flag description                                                            |
|------|-----------------------------------------------------------------------------|
| -a   | Searches the entire file, not just the data section, for printable strings. |
| -    | Searches the entire file, not just the data section, for printable strings. |

| Flag             | Flag description                                                                                                                                                                                                                                           |
|------------------|------------------------------------------------------------------------------------------------------------------------------------------------------------------------------------------------------------------------------------------------------------|
| -n <i>Number</i> | Specifies a minimum string length other than the default of 4 characters. The maximum value of a string length is 4096. This flag is identical to the - <i>Number</i> flag.                                                                                |
| -o               | Lists each string preceded by its octal offset in the file. This flag is identical to the -to flag.                                                                                                                                                        |
| -t <i>Format</i> | Lists each string preceded by its offset from the start of the file. The format is dependent on the character used as the Format variable.<br>d - Writes the offset in decimal.<br>o - Writes the offset in octal.<br>x - Writes the offset in hexadecimal |
| - <i>Number</i>  | Specifies a minimum string length other than the default of 4 characters. The maximum value of a string length is 4096. This flag is identical to the -n Number flag.                                                                                      |
| File             | Binary or object file to be searched.                                                                                                                                                                                                                      |

**Note:** When the -o and the -t format flags are defined more than once on a command line, the last flag specified controls the behavior of the **strings** command.

Examples using the **strings** command are as follows:

- To search a file, enter:

```
strings wall
@(#)61
1.11 src/bos/usr/ccs/lib/libc/___threads_init.c, libcthrd, bos43K, 9823A_43K 6/12/98
12:37:06
wall.cat
/etc/utmp
libIN.cat
Cannot open "%s".
/etc/utmp
0123456789
/dev/
..... (Lines Removed)
libIN.cat
Error %d
libIN.cat
No system error
libc.cat
@(#)53
1.8 src/bos/usr/ccs/lib/libIN/ERsysmsg.c, libIN, bos430, 9737A_430 11/10/93 15:13:03
@(#)71
1.6 src/bos/usr/ccs/lib/libIN/CSlen.c, libIN, bos430, 9737A_430 6/10/91 10:14:51
```

```
@(#)88
1.6 src/bos/usr/ccs/lib/libIN/CSsname.c, libIN, bos430, 9737A_430 6/10/91 10:15:13
@(#)47
1.6 src/bos/usr/ccs/lib/libIN/CSskpa.c, libIN, bos430, 9737A_430 6/10/91 10:52:46
```

- ▶ To search for strings at least 12 characters long, enter:

```
strings -l2 wall
1.11 src/bos/usr/ccs/lib/libc/___threads_init.c, libcthrd, bos43K, 9823A_43K 6/12/98
12:37:06
Cannot open "%s".
Cannot open "%s".
wall: Cannot allocate enough memory.
Broadcast message from %s@%s (%s) at %s ...
Message too long (max %d chars).
wall: Cannot create another process at this time.
@(#)11 1.16.1.7 src/bos/usr/sbin/wall/wall.c, cmdcomm, bos430, 9737A_430 9/5/97
13:48:32
1.7 src/bos/usr/ccs/lib/libIN/ERcmderr.c, libIN, bos430, 9737A_430 6/10/91 10:15:39
No system error
1.8 src/bos/usr/ccs/lib/libIN/ERsysmsg.c, libIN, bos430, 9737A_430 11/10/93 15:13:03
1.6 src/bos/usr/ccs/lib/libIN/CSlen.c, libIN, bos430, 9737A_430 6/10/91 10:14:51
1.6 src/bos/usr/ccs/lib/libIN/CSsname.c, libIN, bos430, 9737A_430 6/10/91 10:15:13
1.6 src/bos/usr/ccs/lib/libIN/CSskpa.c, libIN, bos430, 9737A_430 6/10/91 10:52:46
```

- ▶ To search for strings at least 20 characters long and show the offset in hexadecimal, enter:

```
strings -t x -n 20 wall
1ac7 1.11 src/bos/usr/ccs/lib/libc/___threads_init.c, libcthrd, bos43K, 9823A_43K
6/12/98 12:37:06

1bc0 wall: Cannot allocate enough memory.
1bec Broadcast message from %s@%s (%s) at %s ...
1c1c Message too long (max %d chars).
1c40 wall: Cannot create another process at this time.
1c74 @(#)11 1.16.1.7 src/bos/usr/sbin/wall/wall.c, cmdcomm, bos430, 9737A_430
9/5/97 13:48:32
1ce7 1.7 src/bos/usr/ccs/lib/libIN/ERcmderr.c, libIN, bos430, 9737A_430 6/10/91
10:15:39
1d87 1.8 src/bos/usr/ccs/lib/libIN/ERsysmsg.c, libIN, bos430, 9737A_430 11/10/93
15:13:03
1de7 1.6 src/bos/usr/ccs/lib/libIN/CSlen.c, libIN, bos430, 9737A_430 6/10/91
10:14:51
1e4b 1.6 src/bos/usr/ccs/lib/libIN/CSsname.c, libIN, bos430, 9737A_430 6/10/91
10:15:13
1ea7 1.6 src/bos/usr/ccs/lib/libIN/CSskpa.c, libIN, bos430, 9737A_430 6/10/91
10:52:46
```

In this section, you learned how to edit a file using the vi editor. You also learned how to view a file with the **pg** and **cat** commands, and the differences between the two. You can **echo** text to the screen or a file. The file characteristics can be found using the **file** command. You can also find strings within a file using the **strings** command. Much of what you have learned in this section will be used in Chapter 16, “The shell and shell scripts” on page 403.

## 15.4 Quiz

The following certification assessment questions help verify your understanding of the topics discussed in this chapter.

1. Which command displays the value of the HOME variable?
  - A. **echo HOME**
  - B. **echo \$HOME**
  - C. **echo '\$HOME'**
  - D. **echo ` \$HOME `**

The following are additional questions created by the authors to further test your understanding of the topics.

1. Use the following file contents to answer the following question:

```
#!/usr/bin/ksh
tctl -f /dev/rmt0 rewind
mkszfile
mksysb -i /dev/rmt0
tctl -f /dev/rmt0 offline
```

In the above script, the system administrator is editing a routine backup script using vi because the **mkszfile** command is unnecessary. What steps should the system administrator use to delete the line containing the **mkszfile** command?

- A. Move to line 3, and press dd.
- B. Move to line 3, and press xx.
- C. Move to line 2 and press o.
- D. Move to line 3 and press d.

2. Use the following directory listing to answer the following question:

```
-rwsr-xrw- 1 root system 76528 Nov 24 16:21
/usr/local/bin/scan_it
```

A long listing of the file `/usr/local/bin/scan_it` is shown above. When the command is executed as a nonroot user, it fails to run as root. What would be the first action to take?

- A. file `/usr/local/bin/scan_it`.
- B. `chmod 4764 /usr/local/bin/scan_it`.
- C. Run the command in the background.
- D. Copy `/usr/local/bin/scan_it` to the own home directory and execute it from there.

### 15.4.1 Answers

The following answers are for the assessment quiz questions.

- 1. B

The following answers are for the additional quiz questions.

- 1. A
- 2. A

## 15.5 Exercises

The following exercises provide sample topics for self study. They will help ensure comprehension of this chapter.

- 1. What is the difference between the `cat`, `echo`, `pg`, and `view` commands?
- 2. Use the `file` command to determine what type of file `/etc/swapspaces` is.
- 3. Set up your environment to use `vi` as your default system editor. Use the `env` command to check that it is set correctly.





## The shell and shell scripts

The primary interface to the operating system is called a *shell*. The shell is the outermost layer of the operating system. Shells incorporate a programming language to control processes and files, as well as to start and control other programs. The shell manages the interaction between you and the operating system by prompting you for input, interpreting that input for the operating system, and then handling any resulting output from the operating system.

Shells provide a way for you to communicate with the operating system. This communication is carried out either interactively (input from the keyboard is acted upon immediately) or as a shell script. A *shell script* is a sequence of shell and operating system commands that are stored in a file and may be reused.

In essence, a shell script is simply a combination of commands put into a single file. Variables and environments can also be set up in a shell script.

## 16.1 The Korn shell or POSIX shell

The Korn shell is an interactive command interpreter and command programming language. It conforms to the Portable Operating System Interface for Computer Environments (POSIX), an international standard for operating systems. POSIX is not an operating system, but is a standard aimed at portability of applications, at the source level, across many systems. POSIX features are built on top of the Korn shell. The Korn shell (also known as the POSIX shell) offers many of the same features as the Bourne and C shells, such as I/O redirection capabilities, variable substitution, and file name substitution.

## 16.2 Bourne shell

The Bourne shell is an interactive command interpreter and command programming language. The **bsh** command runs the Bourne shell.

The Bourne shell can be run either as a login shell or as a subshell under the login shell. Only the **login** command can call the Bourne shell as a login shell. It does this by using a special form of the **bsh** command name: **-bsh**. When called with an initial **-** (hyphen), the shell first reads and runs commands found in the system **/etc/profile** file and your **\$HOME/.profile**, if one exists.

The **/etc/profile** file sets variables needed by all users. Once the profiles are run, the shell is ready to read commands from your standard input.

## 16.3 C shell

The C shell is an interactive command interpreter and a command programming language. It uses syntax that is similar to the C programming language. The **cs** command starts the C shell.

When you log in, the C shell first searches for the system-wide setup file **/etc/csh.cshrc**. If it exists, the C shell runs the commands stored in that file. Next, the C shell runs the system-wide setup file **/etc/csh.login**, if it is available. Then, it searches your home directory for the **.cshrc** and **.login** files. If they exist, they contain any customized user information pertinent to running the C shell. All variables set in the **/etc/csh.cshrc** and **/etc/csh.login** files may be overridden by your **.cshrc** and **.login** files in your **\$HOME** directory. Only the root user can modify the **/etc/csh.cshrc** and **/etc/csh.login** files.

The `/etc/csh.login` and `$HOME/.login` files are run only once at login time. They are generally used to hold environment variable definitions, commands that you want carried out once at login, or commands that set up terminal characteristics.

The `/etc/csh.cshrc` and `$HOME/.cshrc` files are run at login time, and every time the `csh` command or a C shell script is invoked. They are generally used to define C shell characteristics, such as aliases and C shell variables (for example, history, `noclobber`, or `ignoreeof`). It is recommended that you only use the C shell built-in commands in the `/etc/csh.cshrc` and `$HOME/.cshrc` files, because using other commands increases the start-up time for shell scripts.

## 16.4 Restricted shell

The restricted shell is used to set up login names and execution environments whose capabilities are more controlled than those of the regular Bourne shell. The `rsh` or `bsh -r` command opens the restricted shell. The behavior of these commands is identical to those of the `bsh` command, except that the following actions are not allowed:

- ▶ Changing the directory (with the `cd` command)
- ▶ Setting the value of `PATH` or `SHELL` variables
- ▶ Specifying path or command names containing a `/` (slash)
- ▶ Redirecting output

If the restricted shell determines that a command to be run is a shell procedure, it uses the Bourne shell to run the command. In this way, it is possible to provide an end user with shell procedures that access the full power of the Bourne shell while imposing a limited menu of commands. This scheme assumes that the end user does not have write and execute permissions in the same directory.

## 16.5 Setting the shell environment

When you log in, the shell defines your user environment after reading the initialization files that you have set up. The characteristics of your user environment are defined by the values given to your environment variables. You maintain this environment until you log off the system.

The shell uses two types of profile files when you log in to the operating system. It evaluates the commands contained in the files and then runs the commands to set up your system environment. The files have similar functions, except that the `/etc/profile` file controls profile variables for all users on a system whereas the `.profile` file allows you to customize your own environment.

The shell first evaluates the commands contained in the `/etc/profile` file and then runs the commands to set up your system environment in the `/etc/environment` file.

After these files are run, the system then checks to see if you have a `.profile` file in your home directory. If the `.profile` file exists, it runs this file. The `.profile` file will specify if an environment file also exists. If an environment file exists, (usually called `.env`), the system then runs this file and sets up your environment variables.

The `/etc/profile`, `/etc/environment`, and the `.profile` files are run once at login time. The `.env` file, on the other hand, is run every time you open a new shell or a window.

## 16.5.1 The `/etc/profile` file

The first file that the operating system uses at login time is the `/etc/profile` file. This file controls system wide default variables, such as:

- ▶ Export variables
- ▶ File creation mask (`umask`)
- ▶ Terminal types
- ▶ Mail messages to indicate when new mail has arrived.

The system administrator configures the profile file for all users on the system. Only the system administrator can change this file.

An example of the `/etc/profile` file is shown in the following:

```
@(#)27 1.20 src/bos/etc/profile/profile, cmdsh, bos430, 9737A_430
8/9/
94 12:01:38
IBM_PROLOG_BEGIN_TAG
..... (Lines Removed)
(C) COPYRIGHT International Business Machines Corp. 1989, 1994
All Rights Reserved
Licensed Materials - Property of IBM
#
US Government Users Restricted Rights - Use, duplication or
disclosure restricted by GSA ADP Schedule Contract with IBM Corp.
#
#####

System wide profile. All variables set here may be overridden by
a user's personal .profile file in their $HOME directory. However,
all commands here will be executed at login regardless.
```

```

trap "" 1 2 3
readonly LOGNAME

Automatic logout, include in export line if uncommented
TMOUT=120

The MAILMSG will be printed by the shell every MAILCHECK seconds
(default 600) if there is mail in the MAIL system mailbox.
MAIL=/usr/spool/mail/$LOGNAME
MAILMSG="[YOU HAVE NEW MAIL]"

If termdef command returns terminal type (i.e. a non NULL value),
set TERM to the returned value, else set TERM to default lft.
TERM_DEFAULT=lft
TERM=~termdef~
TERM=${TERM:-$TERM_DEFAULT}

If LC_MESSAGES is set to "C@lft" and TERM is not set to "lft",
unset LC_MESSAGES.
if ["$LC_MESSAGES" = "C@lft" -a "$TERM" != "lft"]
then
 unset LC_MESSAGES
fi

export LOGNAME MAIL MAILMSG TERM

trap 1 2 3

```

## 16.5.2 The /etc/environment file

The second file that the operating system uses at login time is the /etc/environment file. The /etc/environment file contains variables specifying the basic environment for all processes. When a new process begins, the exec subroutine makes an array of strings available that have the form Name=Value. This array of strings is called the environment. Each name defined by one of the strings is called an environment variable or shell variable. The exec subroutine allows the entire environment to be set at one time.

When you log in, the system sets environment variables from the environment file before reading your login profile, .profile. The following variables make up the basic environment:

- HOME**        The full path name of the user's login or HOME directory. The login program sets this to the directory specified in the /etc/passwd file.
- LANG**        The locale name currently in effect. The LANG variable is initially set in the /etc/profile file at installation time.
- NLSPATH**     The full path name for message catalogs.

|                |                                                                                                                                                                                |
|----------------|--------------------------------------------------------------------------------------------------------------------------------------------------------------------------------|
| <b>LOCPATH</b> | The full path name of the location of National Language Support tables.                                                                                                        |
| <b>PATH</b>    | The sequence of directories that commands, such as <b>sh</b> , <b>time</b> , <b>nice</b> , and <b>nohup</b> , search when looking for a command whose path name is incomplete. |
| <b>LPDEST</b>  | The printer to use when a print-related command does not specify a destination printer.                                                                                        |
| <b>TERM</b>    | The terminal type.                                                                                                                                                             |
| <b>EDITOR</b>  | The default editor to be used by various commands which perform editing functions, such as <b>crontab</b> .                                                                    |
| <b>TZ</b>      | The time zone information.                                                                                                                                                     |

An example of the /etc/environment file is provided in the following example:

```
@(#)18 1.21 src/bos/etc/environment/environment, cmdsh, bos430,
9737A_
430 5/13/94 15:09:03
IBM_PROLOG_BEGIN_TAG
..... (Lines Removed)
US Government Users Restricted Rights - Use, duplication or
disclosure restricted by GSA ADP Schedule Contract with IBM Corp.
#
#####
System wide environment file. This file should only contain
1. comment lines which have a # in the first column,
2. blank lines, and
3. Lines in the form name=value.
#
WARNING: This file is only for establishing environment variables.
Execution of commands from this file or any lines other
than specified above may cause failure of the initialization
process.
#
Searching the current directory last is usually a BIG time saver.
If /usr/ucb is at the beginning of the PATH the BSD version of commands will
be found.
#
PATH=/usr/bin:/etc:/usr/sbin:/usr/ucb:/usr/bin/X11:/sbin
TZ=CST6CDT
LANG=en_US
LOCPATH=/usr/lib/nls/loc
NLSPATH=/usr/lib/nls/msg/%L/%N:/usr/lib/nls/msg/%L/%N.cat
LC__FASTMSG=true

ODM routines use ODMDIR to determine which objects to operate on
the default is /etc/objrepos - this is where the device objects
```

```
reside, which are required for hardware configuration

ODMDIR=/etc/objrepos
```

### 16.5.3 The .profile file

The third file that the operating system uses at login time is the .profile file. The .profile file is present in your home (\$HOME) directory and enables you to customize your individual working environment. Because the .profile file is hidden, use the `ls -a` command to list it.

After the login program adds the LOGNAME (login name) and HOME (login directory) variables to the environment, the commands in the \$HOME/.profile file are run if the file is present. The .profile file contains your individual profile that overrides the variables set in the /etc/profile file. The .profile file is often used to set exported environment variables and terminal modes. You can tailor your environment as desired by modifying the .profile file. Use the .profile file to control the following defaults:

- ▶ Shells to open
- ▶ Default editor
- ▶ Default printer
- ▶ Prompt appearance
- ▶ Keyboard sound

You can also use the .profile file (or if it is not present, the /etc/profile file) to determine login shell variables. You can also customize other shell environments. For example, use the .cshrc file and .kshrc file to tailor a C shell and a Korn shell, respectively, when each type of shell is started.

An example of a .profile file is shown in the following:

```
PATH=/usr/bin:/etc:/usr/sbin:/usr/ucb:$HOME/bin:/usr/bin/X11:/sbin:.

export PATH

if [-s "$MAIL"] # This is at Shell startup. In normal
then echo "$MAILMSG" # operation, the Shell checks
fi # periodically.
```

## 16.5.4 The .env file

A fourth file that the operating system uses at login time is the .env file, if your .profile has the following line:

```
export ENV=$HOME/.env
```

The .env file enables you to customize your individual working environment variables. Because the .env file is hidden, use the `ls -a` command to list it. The .env file contains the individual user environment variables that override the variables set in the /etc/environment file. You can tailor your environment variables as desired by modifying your .env file.

An example of the .env file is as follows:

```
export myid=`id | sed -n -e 's/).*$/' -e 's/^.*(//p'` \
bold=`tput smso` \
norm=`tput rmso`
#set prompt: login & system name (reverse video) & path (normal)
if [$myid = root]
then typeset -x PSCH='${bold}#:${norm}\${PWD}> '
PS1='${bold}#:${norm}\${PWD}> '
else typeset -x PSCH='>'
PS1='${bold}$LOGNAME@$UNAME:${norm}\${PWD}> '
PS2=">"
PS3="#?"
fi
export PS1 PS2 PS3
#setup my command aliases
alias ls="/bin/ls -CF" \
d="/bin/ls -Fal | pg" \
rm="/bin/rm -i" \
up="cd .."
```

**Note:** When modifying the .env file, ensure that newly created environment variables do not conflict with standard variables, such as MAIL, PS1, PS2, and IFS.

## 16.5.5 Changing your environment from the command line

You can also change the environment variable from the command line. These variables will only be valid until you exit the shell.

To change the default # prompt in the command line to a `mssystem>` prompt, enter:

```
PS1=mssystem\ \>
mssystem > pwd
/etc
```



```
mysystem > ls -l host*
-rw-rw-r-- 1 root system 1864 Nov 20 10:44 hosts
-rw-r--r-- 1 root system 2060 Aug 25 09:41 hosts.equiv
-rw-rw-r-- 1 root system 1906 Aug 25 09:41 hosts.lpd
mysystem >
```

To set the language environment variable to en\_UK for one session, enter:

```
LANG=en_UK
export LANG
```

To check current environment variable, enter:

```
env
_=/usr/bin/env
LANG=en_US
LOGIN=root
NLSPATH=/usr/lib/nls/msg/%L/%N:/usr/lib/nls/msg/%L/%N.cat
inetd_dummy=xxx
PATH=/usr/bin:/etc:/usr/sbin:/usr/ucb:/usr/bin/X11:/sbin
LC_FASTMSG=true
WINDOWID=4194312
LOGNAME=root
LOCPATH=/usr/lib/nls/loc
USER=root
AUTHSTATE=compat
DISPLAY=sv1051b:0.0
SHELL=/bin/ksh
ODMDIR=/etc/objrepos
HOME=/
TERM=aixterm
PWD=/
TZ=CST6CDT
#
```

To check the value of a single environment variable, use the **echo** command. The **echo** command writes character strings to standard output. To check the value of the LANG variable, use the following command:

```
echo $LANG
en_UK
```

The \$ character is required to tell the **echo** command that the string is a shell variable, and that it should evaluate and write the contents of the variable to standard output, rather the variable name itself.

## 16.6 Creating and running a shell script

Shell scripts provide an easy way to run tedious commands, large or complicated sequences of commands, and routine tasks. A shell script is a file that contains one or more commands. When you type the name of a shell script file, the system runs the command sequence contained in the file.

### 16.6.1 General script remarks

You can create a shell script using a text editor. Your script can contain both operating system commands and shell built-in commands.

The following steps are general guidelines for writing shell scripts:

1. Use a text editor to create and save a file. You can include any combination of shell and operating system commands in the shell script file.

By convention, shell scripts that are not set up for use by many users are stored in the \$HOME/bin directory.

**Note:** The operating system does not support the setuid or setgid subroutines within a shell script.

2. Use the **chmod** command to allow only the owner to run (or execute) the file. For example, if your file is named `myscript`, enter:

```
chmod u=rwx myscript
```

3. Enter the script name on the command line to run the shell script. To run the shell script, `myscript`, enter:

```
myscript
```

**Note:** You can run a shell script without making it executable if a shell command (**ksh**, **bsh**, or **cs**) precedes the shell script file name on the command line. For example, to run a nonexecutable file named `myscript` under the control of the Korn shell, type:

```
ksh myscript
```

When you run an executable shell script in either the Korn (the POSIX Shell) or Bourne shell, the commands in the script are carried out under the control of the current shell (the shell from which the script is started) unless you specify a different shell. When you run an executable shell script in the C shell, the commands in the script are carried out under the control of the Bourne shell (`/usr/bin/bsh`), unless you specify a different shell.

You can cause a shell script to run in a specific shell by including the shell within the shell script. To run an executable shell script under a specific shell, enter `#!Path` on the first line of the shell script. The `#!` characters identify the file type. The `Path` variable specifies the path name of the shell from which to run the shell script. For example, if the first line in a shell script is `#!/usr/bin/bsh`, the script is run under control of the Bourne shell.

When you precede a shell script file name with a shell command, the shell specified on the command line overrides any shell specified within the script file itself. Therefore, entering `ksh myfile` runs the file named `myfile` under the control of the Korn shell, even if the first line of `myfile` is `#!/usr/bin/csh`.

## 16.6.2 Creating a script

In this section, the Korn shell (`ksh`) will be the focus to create a script that will run a backup. The script will start with daily backups then move through to weekly and then finally a monthly backup. It will also need user input to continue or abort the operation.

The shell script should have the following format:

- ▶ The `#!/usr/bin/ksh`
- ▶ Script comments
- ▶ Search path
- ▶ Shell variables or arguments
- ▶ Standard input, standard output, and standard Error
- ▶ Exit status

### The `#!/usr/bin/ksh`

The first line of the Korn shell script should begin with:

```
#!/usr/bin/ksh
```

in order for the shell to run under the control of the Korn shell, irrespective of the shell that called it.

### Script comments

Script comments are a description of the script that begin with the pound (`#`) sign. It will have all comments about the script or explain actions of the script.

### Search path

The shell script should include a search path, because if a user with a different search path tries to use the script, it may fail.

## Shell variables

Variables are used to hold information that will be passed onto the script for utilization.

In the backup example, the variables are used to give the day of the week and day of the month variables to the rest of the script to determine the type of backup to use. The bye variable is also used for the exit routine.

## Standard I/O and redirection in scripts

There are three types of I/O in scripts, namely *stdin*, *stdout*, and *stderr*. Standard input (*stdin*) normally comes from the keyboard. Standard output (*stdout*) normally goes to the screen. Standard error (*stderr*) normally goes to the screen. Each of these errors has a descriptor, for *stdin* it is 0, for *stdout* it is 1 and for *stderr* it is 2. You can redirect these to or from a file if needed, as described below:

|      |                            |
|------|----------------------------|
| <    | Redirects input            |
| >    | Redirects output           |
| >>   | Appends output             |
| 2>   | Redirects stderr           |
| 1>&2 | Redirects stdout to stderr |
| 2>&1 | Redirects stderr to stdout |

## Exit status

A good shell script should have a single point of exit. The exit variable can be selected by a variable and used during the script.

## The if/then statement

The if/then statement is the most basic conditional statement. The if/then statement reads a variable, and if the variable is true it runs a command. It runs between if and fi.

The if/then statement format is as follows:

```
if [$variable = true]
then
command(s)
fi
```

## The if/else statement

The if/else statement is the next logical step after the if/then statement. The if/else statement reads the variable, and if the variable is true, then the commands under the if are carried out. If the variable is false, then the commands under the else are run. It runs between if and fi.

The if/else statement format is as follows:

```
if [$variable = true]
then
command(s)
else
command(s)
fi
```

## The if/elif/else statement

The if/elif/else statement is again a progression on the if/else statement. It reads the variable, and if true, then it runs a command. If the variable is false, the statement reads the variable after the elif, and if the second variable is true, it performs that command. If all the variables before the **else** command are false, then the statement runs the command that follows the **else**. It runs between if and fi.

The if/elif/else statement format is as follows:

```
if [$variable = true]
then
command(s)
elif [$other_variable = true]
then
command(s)
else
command(s)
fi
```

## The while loop

The while loop tells the script that while a statement is true, it will perform the loop until the statement becomes false. It runs the commands between do and done.

The while loop format is as follows:

```
while [$statement = true]
do
command(s)
done
```

## The for loop

The for loop is used to run commands a set number of times. The number of times is determined by the list after the **for** command. It runs the commands between do and done.

The for loop format is as follows:

```
for wordlist variables
do
command(s)
done
```

## The case statement

The case statement is used as a substitute for the if/elif statements. The case statement reads a variable, and then runs a command according to the response. It runs the commands between case and esac.

The case statement format is as follows:

```
case variable in
value 1)
command(s) ;;
value 2)
command(s) ;;
esac
```

## Arithmetic operations

The Korn shell **let** built-in command performs integer arithmetic. Constants are of the form [*Base*]*Number*, where *Base* is a decimal number between 2 and 36 inclusive, and *Number* is a number in that base. If you omit the *Base* parameter, the shell uses a base of 10.

Arithmetic expressions use the same syntax, precedence, and associativity as the C language, except for ++, --, ?:, and , (comma). Many arithmetic operators also have special meaning to the shell, so they must be quoted.

The arithmetic operation format is as follows:

```
let "y = y * 5"
let "z = q * (z - 10)"
```

## Logical operations

A logical, or conditional, expression is used to test file attributes and to compare strings and other expressions.



### ***Start of the case command. Reading stdin***

```
case "$inp" in
 y*|Y*)
 echo Backup will Run
 BYE=stay
 ;;
 n*|N*|*)
 echo Backup will Not Run
```

### ***Exit status***

```
BYE=go
```

### ***End of case command***

```
esac
```

### ***End first if statement***

```
fi
```

### ***Start first if/else statement***

```
if [$BYE = stay]
then
 # Backup Section Starts here
 echo "\nBackup procedure starting"
```

### ***Start first if/elif/else statement***

```
if [$MONTHLY = 25]
then
 echo This will run the MONTHLY BACKUP
savevg -f/dev/rmt0 $i
elif [$DAILY = Fri]
then
 echo Will run a WEEKLY BACKUP
savevg -mf/dev/rmt0 $i
else
 echo Will run a DAILY BACKUP
savevg -ef/dev/rmt0 $i
```

### ***End first if/elif/else statement***

```
fi
else
```

### ***Exit status***

```
BYE=go
```

### ***End first if/else statement***

```
fi
```



### ***End for loop***

```
done
```

### ***Set exit point for multiple exit status points in script***

```
Set single exit point
```

### ***Start second if statement***

```
if [$BYE = go]
then
 echo Backup procedure complete
```

### ***Actual exit point***

```
exit
```

### ***End second if statement***

```
fi
```

### ***End while loop and shell exits***

```
done
```

The preceding example is just a basic idea of what is needed to create a basic script and how you can utilize the various functions within the script to complete your tasks. Depending on your local IS organization, your shell scripts may need to conform to specific specifications, such as comments and programming style. Therefore, the preceding code may need further modification before it can be put into production.

## **16.6.3 Testing shell scripts**

There are useful **ksh** flags that allow you to test your shell scripts. For example, the **-n** flag reads commands and checks them for syntax errors, but does not run them. The **-u** flag runs commands, but treats unset variables as errors when substituting them. The **-x** flag prints performed commands and their arguments.

The following example demonstrates the use of **ksh -n** on a script containing errors:

```
cat testscript
touch new_file
NEW=1
echo $NEW $OLD
if [[$NEW == $OLD]]
then
 echo $NEW
fi
#ls new_file
ls: 0653-341 The file new_file does not exist.
```

```
ksh -n testscript
testscript[4]: 0403-057 Syntax error at line 4: `==' is not expected.
ls new_file
ls: 0653-341 The file new_file does not exist.
```

Notice that after running the script, the file `new_file` does not exist, because the `-n` flag does not actually perform the commands in the script.

The following example demonstrates the use of `ksh -u` on the same script:

```
ksh -u testscript
testscript[3]: OLD: 0403-041 Parameter not set.
ls new_file
new_file
```

The script fails because the `OLD` variable has not been given a value. Notice, however, that after running the script, the file `new_file` does exist, because it was created before the line in the script that had an unset parameter.

The following example demonstrates the use of `ksh -x` on the same script:

```
rm new_file
ksh -x testscript
+ touch new_file
+ NEW=1
+ echo 1
1
testscript[4]: 0403-057 Syntax error at line 4: `==' is not expected.
ls new_file
new_file
```

Notice that each line of the script was displayed as it was carried out prior to its failure. Also notice that variable contents were displayed rather than the variable names.

## 16.7 Quiz

The following are additional questions created by the authors to further test your understanding of the topics.

1. Use the following example for the questions in this topic.

```
#!/usr/bin/ksh
#
If srcmstr is running, ensure that it is active before issuing the
startsrc commands
#
if [-n "$src_running"]; then
echo "Checking for srcmstr active...\c"
i=10 # try ten times to contact it
while [$i != 10] ; do
lssrc -s inetd >/dev/null 2>&1 && break # break out on success
sleep 1
echo ".\c"
i=`expr $i -1`
done
if [$i=0]; then
echo "\n\n ERROR:srcmstr is not accepting connections.\n"
exit 1
fi
echo "complete"

else
src_running=""
fi
```

In the above section of code, what is the problem?

- A. The while loop is never performed.
  - B. There are no break statements in the loop.
  - C. The variable i should be initialized to zero.
  - D. The while loop does not have the done statement.
2. A marketing manager would like her shell prompt to reflect the directory she is in so that she needs to remove a file, she will be sure to be in the proper directory. Which of the following environment variables can be set to accomplish this?
    - A. PS1
    - B. PATH
    - C. DISPLAY
    - D. LOCPATH

3. A client has changed their personal `.profile` to allow for a search of the `/usr/local/bin` file system. This was needed to test new software on the development machine. The client will be going to production with the new software the next weekend, impacting about 500 users. Which of the following should be recommended to the client in order to avoid any potential problems?
  - A. Modify `/etc/hosts` to allow the production users to use the software.
  - B. Modify `/etc/profile` to allow the production users to use the software.
  - C. Modify `/etc/hosts.equiv` to allow the production users to use the software.
  - D. Modify `/etc/resolv.conf` to allow the production users to use the software.

### 16.7.1 Answers

The following answers are for the additional quiz questions.

1. A
2. A
3. B

## 16.8 Exercises

The following exercises provide sample topics for self study. They will help ensure comprehension of this chapter.

1. Create a script with a while loop that will greet people as they log in, as long as you are logged in.
2. What should go into the `.profile` file and what should go into `/etc/profile`?

# Related publications

The publications listed in this section are considered particularly suitable for a more detailed discussion of the topics covered in this redbook.

## IBM Redbooks

For information on ordering these publications, see “How to get IBM Redbooks” on page 424.

- ▶ *AIX 5L AIX Workload Manager (WLM)*, SG24-5977
- ▶ *AIX 5L Differences Guide*, SG24-5765
- ▶ *AIX Logical Volume Manager, From A to Z: Introduction and Concepts*, SG24-5432
- ▶ *IBM Certification Study Guide: AIX Installation and System Recovery*, SG24-6183
- ▶ *IBM Certification Study Guide: AIX Performance and System Tuning*, SG24-6184
- ▶ *IBM Certification Study Guide: AIX Problem Determination Tools and Techniques*, SG24-6185
- ▶ *IBM Certification Study Guide: AIX Communications*, SG24-6186
- ▶ *IBM @server Certification Study Guide - pSeries HACMP for AIX*, SG24-6187
- ▶ *IBM @server Certification Study Guide - pSeries AIX System Administration*, SG24-6191
- ▶ *IBM Certification Study Guide RS/6000 SP*, SG24-5348
- ▶ *Understanding IBM @server pSeries Performance and Sizing*, SG24-4810

## Other resources

These publications are also relevant as further information sources:

- ▶ *AIX System Management Concepts: Operating System and Devices*, SC23-4311
- ▶ *RS/6000 and pSeries PCI Adapter Placement Reference*, SA38-0538
- ▶ *SSA Adapters: User's Guide and Maintenance Information*, SA33-3272

You can access all of the AIX documentation through the Internet at the following URL:

<http://www.ibm.com/servers/aix/library>

The following types of documentation are located on the documentation CD-ROM that ships with the AIX operating system:

- ▶ User guides
- ▶ System management guides
- ▶ Application programmer guides
- ▶ All commands reference volumes
- ▶ Files reference
- ▶ Technical reference volumes used by application programmers

## Referenced Web sites

These Web sites are also relevant as further information sources:

- ▶ CD-ROM training for System Support certification  
<http://www.ibm.com/services/learning/spotlight/pseries/cdrom.html>
- ▶ The best place to start learning about certification:  
<http://www.ibm.com/certify>

## How to get IBM Redbooks

Search for additional Redbooks or Redpieces, view, download, or order hardcopy from the Redbooks Web site:

[ibm.com/redbooks](http://www.ibm.com/redbooks)

Also download additional materials (code samples or diskette/CD-ROM images) from this Redbooks site.

Redpieces are Redbooks in progress; not all Redbooks become Redpieces and sometimes just a few chapters will be published this way. The intent is to get the information out much quicker than the formal publishing process allows.

## **IBM Redbooks collections**

Redbooks are also available on CD-ROMs. Click the CD-ROMs button on the Redbooks Web site for information about all the CD-ROMs offered, as well as updates and formats.





# Special notices

References in this publication to IBM products, programs or services do not imply that IBM intends to make these available in all countries in which IBM operates. Any reference to an IBM product, program, or service is not intended to state or imply that only IBM's product, program, or service may be used. Any functionally equivalent program that does not infringe any of IBM's intellectual property rights may be used instead of the IBM product, program or service.

Information in this book was developed in conjunction with use of the equipment specified, and is limited in application to those specific hardware and software products and levels.

IBM may have patents or pending patent applications covering subject matter in this document. The furnishing of this document does not give you any license to these patents. You can send license inquiries, in writing, to the IBM Director of Licensing, IBM Corporation, North Castle Drive, Armonk, NY 10504-1785.

Licensees of this program who wish to have information about it for the purpose of enabling: (i) the exchange of information between independently created programs and other programs (including this one) and (ii) the mutual use of the information which has been exchanged, should contact IBM Corporation, Dept. 600A, Mail Drop 1329, Somers, NY 10589 USA.

Such information may be available, subject to appropriate terms and conditions, including in some cases, payment of a fee.

The information contained in this document has not been submitted to any formal IBM test and is distributed AS IS. The information about non-IBM ("vendor") products in this manual has been supplied by the vendor and IBM assumes no responsibility for its accuracy or completeness. The use of this information or the implementation of any of these techniques is a customer responsibility and depends on the customer's ability to evaluate and integrate them into the customer's operational environment. While each item may have been reviewed by IBM for accuracy in a specific situation, there is no guarantee that the same or similar results will be obtained elsewhere. Customers attempting to adapt these techniques to their own environments do so at their own risk.

Any pointers in this publication to external Web sites are provided for convenience only and do not in any manner serve as an endorsement of these Web sites.

Any performance data contained in this document was determined in a controlled environment, and therefore, the results that may be obtained in other operating environments may vary significantly. Users of this document should verify the applicable data for their specific environment.

This document contains examples of data and reports used in daily business operations. To illustrate them as completely as possible, the examples contain the names of individuals, companies, brands, and products. All of these names are fictitious and any similarity to the names and addresses used by an actual business enterprise is entirely coincidental.

Reference to PTF numbers that have not been released through the normal distribution process does not imply general availability. The purpose of including these reference numbers is to alert IBM customers to specific information relative to the implementation of the PTF when it becomes available to each customer according to the normal IBM PTF distribution process.

The following terms are trademarks of other companies:

Tivoli, Manage. Anything. Anywhere., The Power To Manage., Anything. Anywhere., TME, NetView, Cross-Site, Tivoli Ready, Tivoli Certified, Planet Tivoli, and Tivoli Enterprise are trademarks or registered trademarks of Tivoli Systems Inc., an IBM company, in the United States, other countries, or both. In Denmark, Tivoli is a trademark licensed from Kjøbenhavns Sommer - Tivoli A/S.

C-bus is a trademark of Corollary, Inc. in the United States and/or other countries.

Java and all Java-based trademarks and logos are trademarks or registered trademarks of Sun Microsystems, Inc. in the United States and/or other countries.

Microsoft, Windows, Windows NT, and the Windows logo are trademarks of Microsoft Corporation in the United States and/or other countries.

PC Direct is a trademark of Ziff Communications Company in the United States and/or other countries and is used by IBM Corporation under license.

ActionMedia, LANDesk, MMX, Pentium and ProShare are trademarks of Intel Corporation in the United States and/or other countries.

UNIX is a registered trademark in the United States and other countries licensed exclusively through The Open Group.

SET, SET Secure Electronic Transaction, and the SET Logo are trademarks owned by SET Secure Electronic Transaction LLC.

Other company, product, and service names may be trademarks or service marks of others



# Abbreviations and acronyms

|                |                                                              |               |                                                                   |
|----------------|--------------------------------------------------------------|---------------|-------------------------------------------------------------------|
| <b>ABI</b>     | Application Binary Interface                                 | <b>BOS</b>    | Base Operating System                                             |
| <b>AC</b>      | Alternating Current                                          | <b>BSC</b>    | Binary Synchronous Communications                                 |
| <b>ACL</b>     | Access Control List                                          | <b>CAD</b>    | Computer-Aided Design                                             |
| <b>AFPA</b>    | Adaptive Fast Path Architecture                              | <b>CAE</b>    | Computer-Aided Engineering                                        |
| <b>AH</b>      | Authentication Header                                        | <b>CAM</b>    | Computer-Aided Manufacturing                                      |
| <b>AIX</b>     | Advanced Interactive Executive                               | <b>CATIA</b>  | Computer-Graphics Aided Three-Dimensional Interactive Application |
| <b>ANSI</b>    | American National Standards Institute                        | <b>CCM</b>    | Common Character Mode                                             |
| <b>APAR</b>    | Authorized Program Analysis Report                           | <b>CD</b>     | Compact Disk                                                      |
| <b>API</b>     | Application Programming Interface                            | <b>CDE</b>    | Common Desktop Environment                                        |
| <b>ARP</b>     | Address Resolution Protocol                                  | <b>CDLI</b>   | Common Data Link Interface                                        |
| <b>ASCI</b>    | Accelerated Strategic Computing Initiative                   | <b>CD-R</b>   | CD Recordable                                                     |
| <b>ASCII</b>   | American National Standards Code for Information Interchange | <b>CD-ROM</b> | Compact Disk-Read Only Memory                                     |
| <b>ASR</b>     | Address Space Register                                       | <b>CE</b>     | Customer Engineer                                                 |
| <b>ATM</b>     | Asynchronous Transfer Mode                                   | <b>CEC</b>    | Central Electronics Complex                                       |
| <b>AuditRM</b> | Audit Log Resource Manager                                   | <b>CFD</b>    | Computational Fluid Dynamics                                      |
| <b>AUI</b>     | Attached Unit Interface                                      | <b>CGE</b>    | Common Graphics Environment                                       |
| <b>AWT</b>     | Abstract Window Toolkit                                      | <b>CHRP</b>   | Common Hardware Reference Platform                                |
| <b>BCT</b>     | Branch on Count                                              | <b>CISPR</b>  | International Special Committee on Radio Interference             |
| <b>BFF</b>     | Backup File Format                                           | <b>CLIO/S</b> | Client Input/Output Sockets                                       |
| <b>BI</b>      | Business Intelligence                                        | <b>CLVM</b>   | Concurrent LVM                                                    |
| <b>BIND</b>    | Berkeley Internet Name Daemon                                | <b>CMOS</b>   | Complimentary Metal-Oxide Semiconductor                           |
| <b>BIST</b>    | Built-In Self-Test                                           | <b>CMP</b>    | Certificate Management Protocol                                   |
| <b>BLAS</b>    | Basic Linear Algebra Subprograms                             |               |                                                                   |
| <b>BLOB</b>    | Binary Large Object                                          |               |                                                                   |

|              |                                           |               |                                                     |
|--------------|-------------------------------------------|---------------|-----------------------------------------------------|
| <b>COFF</b>  | Common Object File Format                 | <b>DMA</b>    | Direct Memory Access                                |
| <b>COLD</b>  | Computer Output to Laser Disk             | <b>DMT</b>    | Directory Management Tool                           |
| <b>CORBA</b> | Common Object Request Broker Architecture | <b>DN</b>     | Distinguished Name                                  |
| <b>CPU</b>   | Central Processing Unit                   | <b>DNS</b>    | Domain Naming System                                |
| <b>CRC</b>   | Cyclic Redundancy Check                   | <b>DOE</b>    | Department of Energy                                |
| <b>CSID</b>  | Character Set ID                          | <b>DOI</b>    | Domain of Interpretation                            |
| <b>CSR</b>   | Customer Service Representative           | <b>DOS</b>    | Disk Operating System                               |
| <b>CSS</b>   | Communication Subsystems Support          | <b>DPCL</b>   | Dynamic Probe Class Library                         |
| <b>CSU</b>   | Customer Set-Up                           | <b>DRAM</b>   | Dynamic Random Access Memory                        |
| <b>CWS</b>   | Control Workstation                       | <b>DS</b>     | Differentiated Service                              |
| <b>DAD</b>   | Duplicate Address Detection               | <b>DSA</b>    | Dynamic Segment Allocation                          |
| <b>DAS</b>   | Dual Attach Station                       | <b>DSE</b>    | Diagnostic System Exerciser                         |
| <b>DASD</b>  | Direct Access Storage Device              | <b>DSMIT</b>  | Distributed SMIT                                    |
| <b>DAT</b>   | Digital Audio Tape                        | <b>DSU</b>    | Data Service Unit                                   |
| <b>DBCS</b>  | Double Byte Character Set                 | <b>DTE</b>    | Data Terminating Equipment                          |
| <b>DBE</b>   | Double Buffer Extension                   | <b>DW</b>     | Data Warehouse                                      |
| <b>DC</b>    | Direct Current                            | <b>EA</b>     | Effective Address                                   |
| <b>DCE</b>   | Distributed Computing Environment         | <b>EC</b>     | Engineering Change                                  |
| <b>DDC</b>   | Display Data Channel                      | <b>ECC</b>    | Error Checking and Correcting                       |
| <b>DDS</b>   | Digital Data Storage                      | <b>EEPROM</b> | Electrically Erasable Programmable Read Only Memory |
| <b>DE</b>    | Dual-Ended                                | <b>EFI</b>    | Extensible Firmware Interface                       |
| <b>DES</b>   | Data Encryption Standard                  | <b>EHD</b>    | Extended Hardware Drivers                           |
| <b>DFL</b>   | Divide Float                              | <b>EIA</b>    | Electronic Industries Association                   |
| <b>DFP</b>   | Dynamic Feedback Protocol                 | <b>EISA</b>   | Extended Industry Standard Architecture             |
| <b>DFS</b>   | Distributed File System                   | <b>ELA</b>    | Error Log Analysis                                  |
| <b>DHCP</b>  | Dynamic Host Configuration Protocol       | <b>ELF</b>    | Executable and Linking Format                       |
| <b>DIMM</b>  | Dual In-Line Memory Module                | <b>EMU</b>    | European Monetary Union                             |
| <b>DIP</b>   | Direct Insertion Probe                    | <b>EOF</b>    | End of File                                         |
| <b>DIT</b>   | Directory Information Tree                | <b>EPOW</b>   | Environmental and Power Warning                     |
| <b>DIVA</b>  | Digital Inquiry Voice Answer              |               |                                                     |
| <b>DLT</b>   | Digital Linear Tape                       |               |                                                     |

|                    |                                                |                       |                                                               |
|--------------------|------------------------------------------------|-----------------------|---------------------------------------------------------------|
| <b>ERRM</b>        | Event Response resource manager                | <b>GAMESS</b>         | General Atomic and Molecular Electronic Structure System      |
| <b>ESID</b>        | Effective Segment ID                           | <b>GPFS</b>           | General Parallel File System                                  |
| <b>ESP</b>         | Encapsulating Security Payload                 | <b>GPR</b>            | General-Purpose Register                                      |
| <b>ESSL</b>        | Engineering and Scientific Subroutine Library  | <b>GUI</b>            | Graphical User Interface                                      |
| <b>ETML</b>        | Extract, Transformation, Movement, and Loading | <b>GUID</b>           | Globally Unique Identifier                                    |
| <b>F/C</b>         | Feature Code                                   | <b>HACMP</b>          | High Availability Cluster Multi Processing                    |
| <b>F/W</b>         | Fast and Wide                                  | <b>HACWS</b>          | High Availability Control Workstation                         |
| <b>FC</b>          | Fibre Channel                                  | <b>HCON</b>           | IBM AIX Host Connection Program/6000                          |
| <b>FCAL</b>        | Fibre Channel Arbitrated Loop                  | <b>HDX</b>            | Half Duplex                                                   |
| <b>FCC</b>         | Federal Communication Commission               | <b>HFT</b>            | High Function Terminal                                        |
| <b>FCP</b>         | Fibre Channel Protocol                         | <b>HIPPI</b>          | High Performance Parallel Interface                           |
| <b>FDDI</b>        | Fiber Distributed Data Interface               | <b>HiPS</b>           | High Performance Switch                                       |
| <b>FDPR</b>        | Feedback Directed Program Restructuring        | <b>HiPS LC-8</b>      | Low-Cost Eight-Port High Performance Switch                   |
| <b>FDX</b>         | Full Duplex                                    | <b>HostRM</b>         | Host Resource Manager                                         |
| <b>FIFO</b>        | First In/First Out                             | <b>HPF</b>            | High Performance FORTRAN                                      |
| <b>FLASH EPROM</b> | Flash Erasable Programmable Read-Only Memory   | <b>HPSSDL</b>         | High Performance Supercomputer Systems Development Laboratory |
| <b>FLIH</b>        | First Level Interrupt Handler                  | <b>HTTP</b>           | Hypertext Transfer Protocol                                   |
| <b>FMA</b>         | Floating point Multiply Add operation          | <b>Hz</b>             | Hertz                                                         |
| <b>FPR</b>         | Floating Point Register                        | <b>I/O</b>            | Input/Output                                                  |
| <b>FPU</b>         | Floating Point Unit                            | <b>I<sup>2</sup>C</b> | Inter Integrated-Circuit Communications                       |
| <b>FRCA</b>        | Fast Response Cache Architecture               | <b>IAR</b>            | Instruction Address Register                                  |
| <b>FRU</b>         | Field Replaceable Unit                         | <b>IBM</b>            | International Business Machines                               |
| <b>FSRM</b>        | File System Resource Manager                   | <b>ICCCM</b>          | Inter-Client Communications Conventions Manual                |
| <b>FTP</b>         | File Transfer Protocol                         | <b>ICE</b>            | Inter-Client Exchange                                         |
| <b>GAI</b>         | Graphic Adapter Interface                      | <b>ICELib</b>         | Inter-Client Exchange library                                 |
|                    |                                                | <b>ICMP</b>           | Internet Control Message Protocol                             |

|               |                                                                                                                |                |                                                |
|---------------|----------------------------------------------------------------------------------------------------------------|----------------|------------------------------------------------|
| <b>ID</b>     | Identification                                                                                                 | <b>ISO</b>     | International Organization for Standardization |
| <b>IDE</b>    | Integrated Device Electronics                                                                                  | <b>ISV</b>     | Independent Software Vendor                    |
| <b>IDS</b>    | Intelligent Decision Server                                                                                    | <b>ITSO</b>    | International Technical Support Organization   |
| <b>IEEE</b>   | Institute of Electrical and Electronics Engineers                                                              | <b>JBOD</b>    | Just a Bunch of Disks                          |
| <b>IETF</b>   | Internet Engineering Task Force                                                                                | <b>JDBC</b>    | Java Database Connectivity                     |
| <b>IHV</b>    | Independent Hardware Vendor                                                                                    | <b>JFC</b>     | Java Foundation Classes                        |
| <b>IIOB</b>   | Internet Inter-ORB Protocol                                                                                    | <b>JFS</b>     | Journaled File System                          |
| <b>IJG</b>    | Independent JPEG Group                                                                                         | <b>JTAG</b>    | Joint Test Action Group                        |
| <b>IKE</b>    | Internet Key Exchange                                                                                          | <b>KDC</b>     | Key Distribution Center                        |
| <b>ILS</b>    | International Language Support                                                                                 | <b>L1</b>      | Level 1                                        |
| <b>IM</b>     | Input Method                                                                                                   | <b>L2</b>      | Level 2                                        |
| <b>INRIA</b>  | Institut National de Recherche en Informatique et en Automatique                                               | <b>L3</b>      | Level 3                                        |
| <b>IP</b>     | Internetwork Protocol (OSI)                                                                                    | <b>LAN</b>     | Local Area Network                             |
| <b>IPL</b>    | Initial Program Load                                                                                           | <b>LANE</b>    | Local Area Network Emulation                   |
| <b>IPSec</b>  | IP Security                                                                                                    | <b>LAPI</b>    | Low-Level Application Programming Interface    |
| <b>IrDA</b>   | Infrared Data Association (which sets standards for infrared support including protocols for data interchange) | <b>LDAP</b>    | Lightweight Directory Access Protocol          |
| <b>IRQ</b>    | Interrupt Request                                                                                              | <b>LDIF</b>    | LDAP Directory Interchange Format              |
| <b>IS</b>     | Integrated Service                                                                                             | <b>LED</b>     | Light Emitting Diode                           |
| <b>ISA</b>    | Industry Standard Architecture, Instruction Set Architecture                                                   | <b>LFD</b>     | Load Float Double                              |
| <b>ISAKMP</b> | Internet Security Association Management Protocol                                                              | <b>LFT</b>     | Low Function Terminal                          |
| <b>ISB</b>    | Intermediate Switch Board                                                                                      | <b>LID</b>     | Load ID                                        |
| <b>ISDN</b>   | Integrated-Services Digital Network                                                                            | <b>LLNL</b>    | Lawrence Livermore National Laboratory         |
| <b>ISMP</b>   | InstallShield Multi-Platform                                                                                   | <b>LP</b>      | Logical Partition                              |
| <b>ISNO</b>   | Interface Specific Network Options                                                                             | <b>LP64</b>    | Long-Pointer 64                                |
|               |                                                                                                                | <b>LPI</b>     | Lines Per Inch                                 |
|               |                                                                                                                | <b>LPP</b>     | Licensed Program Product                       |
|               |                                                                                                                | <b>LPR/LPD</b> | Line Printer/Line Printer Daemon               |
|               |                                                                                                                | <b>LRU</b>     | Least Recently Used                            |
|               |                                                                                                                | <b>LTG</b>     | Logical Track Group                            |
|               |                                                                                                                | <b>LV</b>      | Logical Volume                                 |



|               |                                                 |              |                                   |
|---------------|-------------------------------------------------|--------------|-----------------------------------|
| <b>LVCB</b>   | Logical Volume Control Block                    | <b>NBC</b>   | Network Buffer Cache              |
| <b>LVD</b>    | Low Voltage Differential                        | <b>NCP</b>   | Network Control Point             |
| <b>LVM</b>    | Logical Volume Manager                          | <b>ND</b>    | Neighbor Discovery                |
| <b>MAP</b>    | Maintenance Analysis Procedure                  | <b>NDP</b>   | Neighbor Discovery Protocol       |
| <b>MASS</b>   | Mathematical Acceleration Subsystem             | <b>NFB</b>   | No Frame Buffer                   |
| <b>MAU</b>    | Multiple Access Unit                            | <b>NFS</b>   | Network File System               |
| <b>MBCS</b>   | Multi-Byte Character Support                    | <b>NHRP</b>  | Next Hop Resolution Protocol      |
| <b>Mbps</b>   | Megabits Per Second                             | <b>NIM</b>   | Network Installation Management   |
| <b>MBps</b>   | Megabytes Per Second                            | <b>NIS</b>   | Network Information System        |
| <b>MCA</b>    | Micro Channel Architecture                      | <b>NL</b>    | National Language                 |
| <b>MCAD</b>   | Mechanical Computer-Aided Design                | <b>NLS</b>   | National Language Support         |
| <b>MDI</b>    | Media Dependent Interface                       | <b>NT-1</b>  | Network Terminator-1              |
| <b>MES</b>    | Miscellaneous Equipment Specification           | <b>NTF</b>   | No Trouble Found                  |
| <b>MFLOPS</b> | Million of Floating point Operations Per Second | <b>NTP</b>   | Network Time Protocol             |
| <b>MII</b>    | Media Independent Interface                     | <b>NUMA</b>  | Non-Uniform Memory Access         |
| <b>MIP</b>    | Mixed-Integer Programming                       | <b>NUS</b>   | Numerical Aerodynamic Simulation  |
| <b>MLR1</b>   | Multi-Channel Linear Recording 1                | <b>NVRAM</b> | Non-Volatile Random Access Memory |
| <b>MMF</b>    | Multi-Mode Fibre                                | <b>NWP</b>   | Numerical Weather Prediction      |
| <b>MODS</b>   | Memory Overlay Detection Subsystem              | <b>OACK</b>  | Option Acknowledgment             |
| <b>MP</b>     | Multiprocessor                                  | <b>OCS</b>   | Online Customer Support           |
| <b>MPC-3</b>  | Multimedia PC-3                                 | <b>ODBC</b>  | Open DataBase Connectivity        |
| <b>MPI</b>    | Message Passing Interface                       | <b>ODM</b>   | Object Data Manager               |
| <b>MPOA</b>   | Multiprotocol over ATM                          | <b>OEM</b>   | Original Equipment Manufacturer   |
| <b>MPP</b>    | Massively Parallel Processing                   | <b>OLAP</b>  | Online Analytical Processing      |
| <b>MPS</b>    | Mathematical Programming System                 | <b>OLTP</b>  | Online Transaction Processing     |
| <b>MST</b>    | Machine State                                   | <b>ONC+</b>  | Open Network Computing            |
| <b>MTU</b>    | Maximum Transmission Unit                       | <b>OOUI</b>  | Object-Oriented User Interface    |
| <b>MWCC</b>   | Mirror Write Consistency Check                  | <b>OSF</b>   | Open Software Foundation, Inc.    |
| <b>MX</b>     | Mezzanine Bus                                   | <b>OSL</b>   | Optimization Subroutine Library   |

|              |                                                            |              |                                               |
|--------------|------------------------------------------------------------|--------------|-----------------------------------------------|
| <b>OSLp</b>  | Parallel Optimization Subroutine Library                   | <b>PPP</b>   | Point-to-Point Protocol                       |
| <b>P2SC</b>  | POWER2 Single/Super Chip                                   | <b>PREP</b>  | PowerPC Reference Platform                    |
| <b>PAM</b>   | Pluggable Authentication Mechanism                         | <b>PSE</b>   | Portable Streams Environment                  |
| <b>PAP</b>   | Privileged Access Password                                 | <b>PSSP</b>  | Parallel System Support Program               |
| <b>PBLAS</b> | Parallel Basic Linear Algebra Subprograms                  | <b>PTF</b>   | Program Temporary Fix                         |
| <b>PCI</b>   | Peripheral Component Interconnect                          | <b>PTPE</b>  | Performance Toolbox Parallel Extensions       |
| <b>PDT</b>   | Paging Device Table                                        | <b>PV</b>    | Physical Volume                               |
| <b>PDU</b>   | Power Distribution Unit                                    | <b>PVC</b>   | Permanent Virtual Circuit                     |
| <b>PE</b>    | Parallel Environment                                       | <b>QoS</b>   | Quality of Service                            |
| <b>PEDB</b>  | Parallel Environment Debugging                             | <b>QP</b>    | Quadratic Programming                         |
| <b>PEX</b>   | PHIGS Extension to X                                       | <b>RAID</b>  | Redundant Array of Independent Disks          |
| <b>PFS</b>   | Perfect Forward Security                                   | <b>RAM</b>   | Random Access Memory                          |
| <b>PGID</b>  | Process Group ID                                           | <b>RAN</b>   | Remote Asynchronous Node                      |
| <b>PHB</b>   | Processor Host Bridges                                     | <b>RAS</b>   | Reliability, Availability, and Serviceability |
| <b>PHY</b>   | Physical Layer                                             | <b>RDB</b>   | Relational DataBase                           |
| <b>PID</b>   | Process ID                                                 | <b>RDBMS</b> | Relational Database Management System         |
| <b>PII</b>   | Program Integrated Information                             | <b>RDISC</b> | ICMP Router Discovery                         |
| <b>PIOFS</b> | Parallel Input Output File System                          | <b>RDN</b>   | Relative Distinguished Name                   |
| <b>PKR</b>   | Protection Key Registers                                   | <b>RDP</b>   | Router Discovery Protocol                     |
| <b>PMTU</b>  | Path MTU                                                   | <b>RFC</b>   | Request for Comments                          |
| <b>POE</b>   | Parallel Operating Environment                             | <b>RIO</b>   | Remote I/O                                    |
| <b>POP</b>   | Power-On Password                                          | <b>RIP</b>   | Routing Information Protocol                  |
| <b>POSIX</b> | Portable Operating Interface for Computing Environments    | <b>RIPL</b>  | Remote Initial Program Load                   |
| <b>POST</b>  | Power-On Self-test                                         | <b>RISC</b>  | Reduced Instruction-Set Computer              |
| <b>POWER</b> | Performance Optimization with Enhanced Risc (Architecture) | <b>RMC</b>   | Resource Monitoring and Control               |
| <b>PPC</b>   | PowerPC                                                    | <b>ROLTP</b> | Relative Online Transaction Processing        |
| <b>PPM</b>   | Piecewise Parabolic Method                                 | <b>RPA</b>   | RS/6000 Platform Architecture                 |

|                  |                                          |              |                                             |
|------------------|------------------------------------------|--------------|---------------------------------------------|
| <b>RPA</b>       | RS/6000 Platform Architecture            | <b>SHLAP</b> | Shared Library Assistant Process            |
| <b>RPC</b>       | Remote Procedure Call                    | <b>SID</b>   | Segment ID                                  |
| <b>RPL</b>       | Remote Program Loader                    | <b>SIT</b>   | Simple Internet Transition                  |
| <b>RPM</b>       | Red Hat Package Manager                  | <b>SKIP</b>  | Simple Key Management for IP                |
| <b>RSC</b>       | RISC Single Chip                         | <b>SLB</b>   | Segment Lookaside Buffer                    |
| <b>RSCT</b>      | Reliable Scalable Cluster Technology     | <b>SLIH</b>  | Second Level Interrupt Handler              |
| <b>RSE</b>       | Register Stack Engine                    | <b>SLIP</b>  | Serial Line Internet Protocol               |
| <b>RSVP</b>      | Resource Reservation Protocol            | <b>SLR1</b>  | Single-Channel Linear Recording 1           |
| <b>RTC</b>       | Real-Time Clock                          | <b>SM</b>    | Session Management                          |
| <b>RVSD</b>      | Recoverable Virtual Shared Disk          | <b>SMB</b>   | Server Message Block                        |
| <b>SA</b>        | Secure Association                       | <b>SMIT</b>  | System Management Interface Tool            |
| <b>SACK</b>      | Selective Acknowledgments                | <b>SMP</b>   | Symmetric Multiprocessor                    |
| <b>SAN</b>       | Storage Area Network                     | <b>SMS</b>   | System Management Services                  |
| <b>SAR</b>       | Solutions Assurance Review               | <b>SNG</b>   | Secured Network Gateway                     |
| <b>SAS</b>       | Single Attach Station                    | <b>SOI</b>   | Silicon-on-Insulator                        |
| <b>SBCS</b>      | Single-Byte Character Support            | <b>SP</b>    | IBM RS/6000 Scalable POWER parallel Systems |
| <b>ScaLAPACK</b> | Scalable Linear Algebra Package          | <b>SPCN</b>  | System Power Control Network                |
| <b>SCB</b>       | Segment Control Block                    | <b>SPEC</b>  | System Performance Evaluation Cooperative   |
| <b>SCO</b>       | Santa Cruz Operations                    | <b>SPI</b>   | Security Parameter Index                    |
| <b>SCSI</b>      | Small Computer System Interface          | <b>SPM</b>   | System Performance Measurement              |
| <b>SCSI-SE</b>   | SCSI-Single Ended                        | <b>SPOT</b>  | Shared Product Object Tree                  |
| <b>SDLC</b>      | Synchronous Data Link Control            | <b>SPS</b>   | SP Switch                                   |
| <b>SDR</b>       | System Data Repository                   | <b>SPS-8</b> | Eight-Port SP Switch                        |
| <b>SDRAM</b>     | Synchronous Dynamic Random Access Memory | <b>SRC</b>   | System Resource Controller                  |
| <b>SE</b>        | Single Ended                             | <b>SRN</b>   | Service Request Number                      |
| <b>SEPBU</b>     | Scalable Electrical Power Base Unit      | <b>SSA</b>   | Serial Storage Architecture                 |
| <b>SGI</b>       | Silicon Graphics Incorporated            | <b>SSC</b>   | System Support Controller                   |
| <b>SGID</b>      | Set Group ID                             | <b>SSL</b>   | Secure Socket Layer                         |

|                |                                                    |              |                                         |
|----------------|----------------------------------------------------|--------------|-----------------------------------------|
| <b>STFDU</b>   | Store Float Double with Update                     | <b>VESA</b>  | Video Electronics Standards Association |
| <b>STP</b>     | Shielded Twisted Pair                              | <b>VFB</b>   | Virtual Frame Buffer                    |
| <b>SUID</b>    | Set User ID                                        | <b>VG</b>    | Volume Group                            |
| <b>SUP</b>     | Software Update Protocol                           | <b>VGDA</b>  | Volume Group Descriptor Area            |
| <b>SVC</b>     | Switch Virtual Circuit                             | <b>VGSA</b>  | Volume Group Status Area                |
| <b>SVC</b>     | Supervisor or System Call                          | <b>VHDCI</b> | Very High Density Cable Interconnect    |
| <b>SWVPD</b>   | Software Vital Product Data                        | <b>VLAN</b>  | Virtual Local Area Network              |
| <b>SYNC</b>    | Synchronization                                    | <b>VMM</b>   | Virtual Memory Manager                  |
| <b>TCE</b>     | Translate Control Entry                            | <b>VP</b>    | Virtual Processor                       |
| <b>Tcl</b>     | Tool Command Language                              | <b>VPD</b>   | Vital Product Data                      |
| <b>TCP/IP</b>  | Transmission Control Protocol/Internet Protocol    | <b>VPN</b>   | Virtual Private Network                 |
| <b>TCQ</b>     | Tagged Command Queuing                             | <b>VSD</b>   | Virtual Shared Disk                     |
| <b>TGT</b>     | Ticket Granting Ticket                             | <b>VT</b>    | Visualization Tool                      |
| <b>TLB</b>     | Translation Lookaside Buffer                       | <b>WAN</b>   | Wide Area Network                       |
| <b>TOS</b>     | Type Of Service                                    | <b>WLM</b>   | Workload Manager                        |
| <b>TPC</b>     | Transaction Processing Council                     | <b>WTE</b>   | Web Traffic Express                     |
| <b>TPP</b>     | Toward Peak Performance                            | <b>XCOFF</b> | Extended Common Object File Format      |
| <b>TSE</b>     | Text Search Engine                                 | <b>XIE</b>   | X Image Extension                       |
| <b>TTL</b>     | Time To Live                                       | <b>XIM</b>   | X Input Method                          |
| <b>UCS</b>     | Universal Coded Character Set                      | <b>XKB</b>   | X Keyboard Extension                    |
| <b>UDB EEE</b> | Universal Database and Enterprise Extended Edition | <b>XLF</b>   | XL Fortran                              |
| <b>UDI</b>     | Uniform Device Interface                           | <b>XOM</b>   | X Output Method                         |
| <b>UIL</b>     | User Interface Language                            | <b>XPM</b>   | X Pixmap                                |
| <b>ULS</b>     | Universal Language Support                         | <b>XSSO</b>  | Open Single Sign-on Service             |
| <b>UP</b>      | Uniprocessor                                       | <b>XTF</b>   | Extended Distance Feature               |
| <b>USB</b>     | Universal Serial Bus                               | <b>XVFB</b>  | X Virtual Frame Buffer                  |
| <b>USLA</b>    | User-Space Loader Assistant                        |              |                                         |
| <b>UTF</b>     | UCS Transformation Format                          |              |                                         |
| <b>UTM</b>     | Uniform Transfer Model                             |              |                                         |
| <b>UTP</b>     | Unshielded Twisted Pair                            |              |                                         |
| <b>UUCP</b>    | UNIX-to-UNIX Communication Protocol                |              |                                         |

# Index

## Symbols

- \$HOME/.forward 290
- \$HOME/.netrc 289
- \$HOME/.rhosts 290
- ./bosinst.data 214
- ./image.data 214
- /etc/hosts 288, 289
- /etc/hosts.equiv 290
- /etc/inittab
  - commands
    - chitab 33
    - lsitab 33
    - mkitab 33
    - rmitab 33
  - entry fields 31
    - command 33
    - identifier 31
    - runlevel 31
  - network file system (NFS) 35
  - order of entries 34
  - system resource controller (SRC) 35
  - TCP/IP daemons 35
- /etc/netsvc.conf 289
- /etc/preserve.list 13
- /etc/rc.tcpip 272
- /etc/resolv.conf 287
- /var/adm/cron/at.allow 364
- /var/adm/cron/at.deny 364
- /var/adm/cron/cron.allow 364
- /var/adm/cron/cron.deny 364
- /var/adm/sw/installp.summary 18
- /var/spool/cron/atjobs
  - at 359
- /var/spool/cron/crontabs
  - cron 359

## Numerics

- 128-port Asynchronous adapter 63
- 64-bit Kernel installation 14

## A

- access control, X-windows server 292

- accessing
  - for system recovery 37
  - RAN 65
  - root volume group 39
  - root volume group, choices 41
- actuator 137
- adapter
  - 128-port asynchronous 63
  - configuration 54
  - network
    - adding 262
    - configuration problems 265
    - removing 263
- adding
  - a TTY port 349
  - ISA adapter 61
  - physical volumes, volume group 94
  - tape drive 67
  - TTY 66
  - volume groups 92
  - volume groups, requirements 93
- Address Resolution Protocol (ARP)
  - entries 294
  - mapping table 294
  - permanent entry 294
- administrative groups
  - PPP, uucp 348
- AIX common filters 327
  - using filters 329
- allocating
  - physical partitions 87
  - setting permissions on a physical volume 81
- alog 182
- altering files, using vi 372
- alternate disk installation 13
- architecture
  - CHRP 48
  - RS/6000 Platform Architecture 48
  - specifications 48
- arp 294
- ARP cache 294
- asynchronous devices
  - PPP 342
- Asynchronous Point-to-Point Protocol (PPP) 341

- at 357
  - /var/adm/cron/at.allow 364
  - /var/adm/cron/at.deny 364
  - /var/spool/cron/atjobs 359
  - delete 359
  - schedule 358
- atq 359
- attachment process, PPP 342
  - pppattachd 342

## B

- backup
  - command 219
  - verifying 215
- batch 357
- BIND/DNS (named) 289
- bindprocessor 53
- block size
  - determining 225
- boot
  - accessing a system 37
  - action, /etc/inittab 32
- boot disk
  - determining 42
- boot image
  - damaged 41
  - recreating 41
- boot list
  - changing 36
  - types 36
  - viewing 36
- boot log file
  - alog syntax to view 184
  - contents 184
- boot logical volume
  - migrating 90
- bootable image
  - creating 250
- bootinfo command 48
- bootlist command 35, 90
- bootwait
  - action, /etc/inittab 32
- bos.rte 186
- bos\_sysmgt.serv\_aid 186
- bosboot command 41, 90
- bosdebug 15
- buffer pools
  - clusters 299

- mbufs 299
- bus I/O ranges
  - ISA devices 58
- bus memory address
  - ISA devices 58

## C

- cancel 333
- cat 387, 389, 390
- Center region - Disk 137
- changing
  - activation characteristics, volume groups 94
  - error log file name 187
  - primary dump device 195
- changing files, using vi 372
- chat dialog
  - dial\_out.example 354
  - PPP 353
- chfs 130
- chlv 246
- CHRP
  - PCI-bus models 48
- CHRP (Common Hardware Reference Platform) 48
- chvg command 94
- clearing and preventing queue hangs 330
- client server
  - PPP 341
- cloning 13
- command identifiers for LPD 325
- command syntax
  - echo 395
  - file 397
  - pg 390
  - strings 398
  - view 394
  - vmtune 242
- commands
  - /usr/sbin/pppdial 354
  - alog 182
  - alog -tboot 33
  - arp 294
  - at 357
  - atq 359
  - backup 219
  - batch 357
  - bootinfo 48
  - bootlist 35, 90

bosboot 41, 90, 250  
 bosdebug 15  
 cat 387  
 chfs 130  
 chitab 33  
 chlv 246  
 chvg 94  
 crash 201  
 crontab 357  
 cu 350  
 dd 43, 222  
 df 127, 130, 163  
 echo 395  
 errlogger 194  
 errpt 188  
 export 292  
 extendvg 94, 159  
 file 397  
 fsck 42  
 ftp 289  
 fuser 165  
 getty 33  
 hostname 293  
 ifconfig 264  
 init 30  
 installp 17, 18  
 iostat 237, 238  
 iptrace 321  
 kill 165  
 lppchk 15  
 lpr 333  
 lpstat 333  
 lsattr 59, 249, 303  
 lscfg 48  
 lsdev 116  
 lsfs 105  
 lsitab 33  
 lsipp 24  
 lslv 41, 158, 245  
 lspv 83, 104, 112, 115, 131  
 lsresource 59  
 lsvg 105, 116, 161  
 lsvirprt 315  
 migratepv 90, 104, 115  
 mkboot 90  
 mkdev 67, 120  
 mkitab 33  
 mklv 138  
 mksysb 214  
 mkszfile 214  
 mkvg 92  
 mkvgdata 221  
 mount 106, 158, 161  
 netstat 277, 296  
 no 297  
 odmadd 73  
 odmchange 73  
 odmcreate 73  
 odmdelete 73  
 odmdrop 73  
 odmget 73  
 odmshow 73  
 oslevel 20  
 owned by fileset 23  
 pax 203  
 pdisable 350  
 penable 351  
 pg 390  
 ping 275  
 qcan 333  
 qchk 333  
 reducevg 91, 95, 115, 131  
 restore 218, 224  
 restvg 224  
 rexec 289  
 rlogin 291  
 rmdev 67, 91  
 rmitab 33  
 rmlv 126, 131  
 savevg 221  
 sendmail 290  
 SMIT, fast path 171  
 smitty chpq 315  
 smitty chvirprt 316  
 smitty mkpq 315  
 smitty ppp 344  
 smitty qdefault 335  
 smitty rmpq 315  
 smitty tcpip 345  
 smitty user 348  
 snap 205, 206  
 spray 295  
 strings 398  
 swapon 250  
 sysdumpdev 195, 250  
 tcopy 226  
 tctl 217  
 telnet 291

- topas 232
- traceroute 281
- umount 106, 126
- view 394
- vmstat 234
- vmtune 242, 247
- whence 24
- xhost 292
- xinit 292
- communications configuration
  - ODM system data 71
- configuring
  - adapters 54
  - AIX PPP client 352
  - AIX PPP server 343
  - devices 54, 56
  - diagnostic output, PPP 351
  - dial-in ID, PPP 343
  - dial-in modem, PPP 343
  - error log file 187
  - IP addresses, PPP 343
  - ISA, devices 58
  - link control, PPP 343
  - PCI devices 57
  - physical volumes 79
  - RAN 65
- connector programs
  - pppattachd 342
- copying
  - error log onto tape 193
  - system dump onto tape 205
  - user initiated dump 203
- corrupted
  - file system, recovering 42
  - JFS log, recovering 42
  - super block, recovering 43
- CPU bound system 239
- crash codes
  - system dump 198
- crash command 201
- create
  - crontab 365
  - crontab using file 367
- creating
  - JFS log 42
  - new physical volumes 81
  - volume groups, mkgv command 92
  - volume groups, SMIT 93
- cron 357
  - /var/spool/cron/crontab 359
  - verify job runs 360
- crontab 357
  - create 365
  - create using file 367
  - record format 362
  - remove 367
  - scheduled run time 366
  - scheduling run 362
  - update 365
  - verify 366
- customized device database (CuDv)
  - ODM 73
- customizing
  - error log file 187

## D

- daemons
  - cron 357
  - gated 273
  - inetd 273, 274
  - lpd 273
  - lpd daemon 314
  - named 273
  - portmap 273
  - pppattachd 342
  - pppcontrold 342, 348
  - routed 273
  - rwhod 273
  - sendmail 273
  - syslogd 273, 351
  - timed 273
- datagram protocol
  - PPP 342
- dd 222
- dd command 43
- default route 281
- descriptors 72
- determining
  - block size 225
- device configuration
  - ODM information 72
  - ODM system data 71
- devices
  - configuring 56
  - displaying installed 54
  - installing, ISA device drivers 59
  - ISA, configuring 58



- ISA, finding out 58
- PCI, configuring 57
- removing, rmdev command 67
- SCSI 57
- df 127, 130, 163
- dialer
  - PPP dialer process
    - pppdial 342
- dirty superblock 162
- Disk subsystem
  - Where to place files 137
- disk subsystem
  - mirroring 138
  - policies
    - Inter-disk allocation 138
    - intra-disk allocation 137
    - write-scheduling 139
    - write-verify 139
- DISPLAY 291
  - hostname 293
- displaying
  - current system dump device 195
  - installed devices 54
  - logical volumes, rootvg 40
- DMA
  - channels, ISA devices 58
- domain name server 287
- drslot 57
- drslot command
  - commands 57
- dump device
  - primary 250

## E

- echo 395, 396, 397, 411
- editing files, using vi 372
- editing modes
  - command mode 372
  - last-line mode 373
  - text-input mode 372
- encapsulating multiprotocol datagrams
  - PPP 341
- enq 333
- entry fields
  - action
    - boot 32
    - bootwait 32
    - initdefault 33

- off 32
- once 32
- ondemand 33
- powerfail 32
- powerwait 32
- respawn 31
- sysinit 33
- wait 32
- environment variable
  - DISPLAY 291
- errlogger command 194
- error
  - cannot add printer queue 334
  - qdaemon will not start 334
- error codes
  - 0511-160, cannot read backup media 69
  - 0511-432, file system full 215
  - 0835-028, cu command returns connection failed 351
- error log
  - CHECKSTOP errors 41
  - cleaning 188
  - configuration 187
  - copy onto tape or diskette 193
  - understanding output report 192
- error logging daemon
  - starting, stopping 188
- error report 190
  - fields description 191
- errors
  - 0781-202, remote printing problem 320
  - 0781-374, remote printing problem 319
- errpt
  - commands 190
- errpt command 188, 190
- estimating
  - system dump size 195
- excluding information
  - /etc/exclude.rootvg file 215
- export 292
- extendvg 159
- extendvg command 94
  - failing 94

## F

- fast path commands, SMIT 173
- file 397, 398
- file descriptors

- stdferr 33
- stdin 33
- stdout 33
- file system
  - errors, /tmp full 215
  - journaled 79
  - mounting 43
  - verifying 42
- files
  - \$HOME/.forward 290
  - \$HOME/.netrc 289
  - \$HOME/.rhosts 290
  - .profile, PPP 348
  - /etc/exclude.rootvg 215
  - /etc/ftpusers 349
  - /etc/hosts 288, 289
  - /etc/hosts.equiv 290
  - /etc/hosts.lpd 313
  - /etc/inittab file 44
  - /etc/netsvc.conf 289
  - /etc/ppp/if\_conf 347
  - /etc/ppp/lcp\_config 345, 353
  - /etc/preserve.list 13
  - /etc/qconfig 315
  - /etc/rc.tcpip 272
  - /etc/resolv.conf 287
  - /etc/syslog.conf 351
  - /etc/uucp/Devices 350, 351
  - /usr/lib/lpd/pio/etc/\*.attach 315
  - /usr/lib/lpd/pio/etc/\*.config 315
  - /usr/lib/lpd/pio/predef/\* 315
  - /usr/sbin/mkvirprt 315
  - /var/adm/ras/errlog 187
  - /var/adm/sw/installp.summary 18
  - /var/spool/lpd/pio/@local/custom/\* 315
  - /var/spool/lpd/pio/@local/ddi\* 315
  - crontab 357
  - devices.isa fileset 59
  - ptfload.log 22
  - smit.log 19
  - stacklist 23
- fileset
  - bos.acct 231
  - bos.perf.tools 231
  - bos.rte 186
  - bos\_sysmgt.serv\_aid 186
  - commands owned by 23
- filters
  - AIX common filters 327
  - using filters 329
  - printers 327
- fixdist
  - base maintenance levels 21
  - disk space 22
  - download directory 23
  - maintenance level fixes 21
  - ptfload.log 22
  - stacklist 23
- fragment size
  - JFS 79
- fragmentation
  - logical volume 245
- fragmentation, file systems 241
- fsck command 42
- ftp
  - automatic login 289
- fuser command 165

## G

- gated 273
- generating
  - error report 190

## H

- hardware addresses, ARP 293
- hardware multithreading (HMT) 15
- hd6 paging space
  - moving 251
  - reducing 249
- host name resolution 288
  - /etc/hosts 289
  - /etc/netsvc.conf 289
  - /etc/resolv.conf 287
  - BIND/DNS (named) 289
  - domain name server 287
  - domain name server unreachable 287
  - Network Information Service (NIS) 289
  - ordering of services 289
  - resolver routine 289
- hostname 292, 293
- hot plug PCI cards 57

## I

- I/O scheduling policy 139
  - Parallel 139
  - Parallel/round robin 139

- Parallel/sequential 139
- Sequential 139
- identifying
  - physical volumes (PVID) 80
- ifconfig 264
- inetd 273, 274
  - subservers 274
- information
  - saving 212
- initdefault 30
  - action, /etc/inittab 33
- initialization problems 35
- initialization process
  - /etc/inittab 30
- Inner edge 137
- Inner middle 137
- installation methods
  - 64-bit Kernel installation 14
  - alternate disk install 13
  - migration install 12
  - new and complete overwrite 12
  - preservation install 12, 13
- installing
  - displaying devices 54
  - ISA device drivers 59
- installp 17, 18
  - smit.log 19
- inter-disk allocation policy 138
- Internet addresses, ARP 293
- internet protocol control protocol (IPCP)
  - PPP 341
- interpreting iptrace output 322
  - command identifiers for LPD 325
- intra-disk allocation policy 137
- invalid boot list
  - recovering 42
- invoking
  - smit update\_all 23
- iostat command 237, 238
- IP address pool
  - PPP 341
- IP addressing 277
- IP interfaces
  - PPP 346
- ipforwarding
  - PPP 347
- iptrace facility 321
  - interpreting output 322
    - command identifiers for LPD 325

- iptrace command 321
- IRQ
  - ISA devices 58
- ISA
  - adding, adapter 61
  - bus I/O ranges 58
  - bus memory address 58
  - DMA channels 58
  - installed devices 58
  - IRQ 58
  - recording settings 59
  - RSPC 48

## J

- JFS2
  - characteristics 142
  - compatibility 143
  - migration 143
  - rootvg support 143
  - user-defined 143
- journaled file system (JFS) 79

## K

- Kernels
  - /usr/lib/boot directory 15
  - enabling different 15
  - unix\_64 15
  - unix\_mp 15
  - unix\_up 15
- kill 165

## L

- LED
  - 201, damaged boot image 41
  - 223-229, invalid boot list 42
  - 551, corrupted file system 42
  - 552, corrupted super block 43
  - 553, corrupted /etc/inittab file 44
  - 554 (see LED 552) 43
  - 555 (see LED 551) 42
  - 556 (see LED 552) 43
  - 557 (see LED 551) 42
  - c31 38
  - problems 41
- link control configuration
  - client 352
  - server 344

- link control protocol (LCP)
  - PPP 342
- listing
  - allocation
    - physical partition 87
  - characteristics, physical volumes 83
  - contents of mksysb 216
  - information about physical volume 82
  - logical volume allocations 85
  - physical partition allocations 85
- local address 277
- logging operator messages 194
- logical partitions 78
- logical volume 78
  - boot, migrating 90
  - limitations of 79
  - mirroring 78
  - raw, saving 222
  - storage concepts 78
  - striped 90
  - striping 246
- logs
  - JFS log, recreating 42
- lpd 273
- lpd daemon 314
  - starting 314
  - system resource controller 314
- LPDEST environment variable 336
- lppchk 15
- lpr command 333
- lprm 333
- lpstat command 333
- lrubucket 242
- lsattr 49, 51
- lsattr command 59, 303
- lscfg 49, 50
- lscfg command 48
- lsdev 49, 50, 116
- lsfs 105
- lslpp 24
- lslv 41, 158
- lslv command 245
- lspv 104, 112, 115, 131
- lspv command 83
- lsresource command 59
- lsslot 57
- lsslot command
  - commands 57
- lsvg 105, 116, 161

lvm\_budcnt 242

## M

- maintenance level fixes 21
- maintenance level, oslevel 20
- maintenance run level 30
- managing
  - physical volume 79
  - volume groups 92
- max async HDLC attachments 343
- max client connections 343
- max demand interfaces 343
- max IP interfaces 343
- max server connections 343
- maxfree 242
- maximum transmission unit (MTU) 271
- maxperm 242
- maxpgahead 242
- maxpin 242
- maxrandwrt 242
- mbufs
  - increase 301
- media devices
  - PPP 341
- messages
  - 888 flashing 197
- Micro Channel
  - rs6k 48
  - rs6ksmp 48
- migratepv 104, 115, 251
- migratepv command 90
- migrating
  - boot logical volume 90
  - physical volumes 87
  - physical volumes, migratepv 90
  - physical volumes, SMIT 90
  - striped logical volumes 90
- migration install 12
  - data removed 13
  - data saved 12
  - preserve, volume group 12
- minfree 242
- Minimum range - Disk allocation 138
- minperm 242
- minpgahead 242
- mirrored write consistency 138
- mirroring 138
- mkboot command 90

- mkdev command 67, 120
- mklv command 138
- mkysyb
  - command 214
  - listing contents of 216
  - tape, contents of 214
  - tape, layout of a 214
- mkvg command 92
- mkvgdata 221
- modem
  - dial-in modem configuration, PPP 350
  - dial-out modem configuration, PPP 353
  - setup strings 350
- modification level, smit update\_all 21
- modifying
  - physical volumes 81
  - volume groups 94
- modifying files, using vi 372
- mount 106, 158, 161
- moving
  - physical partitions 92

## N

- named 273
- netstat 277, 296
- network
  - default route 281
  - moving adapter 297
  - subnets 283
- network address 277
- network control protocol (NCP)
  - PPP 342
- network file systems (NFS)
  - /etc/inittab 35
- Network Information Service (NIS) 289
- nice 244
- no 297
  - arptab\_nb 303
  - ipqmaxlen 303
  - rfc1323 302
  - sb\_max 301
  - sockthresh 301
  - tcp\_pmtu\_discover 302
  - tcp\_recvspace 302
  - tcp\_sendspace 301, 302
  - udp\_pmtu\_discover 303
  - udp\_recvspace 302
  - udp\_sendspace 302

- normal boot list 36
- npskill 242
- npswarn 242
- numclust 242
- numfsbuf 242
- numpbuff 242

## O

- object class 72
  - descriptors 72
- Object Data Manager (ODM) 71
- ODM
  - basic components
    - object classes 72
    - objects 72
  - Customized Device Database (CuDv) 73
  - device configuration information 72
  - object 72
  - object class 72
    - descriptors 72
  - predefined 56
  - primary functions 71
  - system data 71
    - communications configuration information 71
    - device configuration information 71
    - SMIT menus, selectors, and dialogs 71
    - system resource information 71
    - vital product data, installation and update 71
- ODM commands 73
  - odmadd 73
  - odmchange 73
  - odmcreate 73
  - odmdelete 73
  - odmdrop 73
  - odmget 73
  - odmshow 73
- ODM databases 72
  - customized device database (CuDv) 73
- ODM facilities 72
- ODM object 72
- off
  - action, /etc/inittab 32
- once
  - action, /etc/inittab 32
- ondemand
  - action, /etc/inittab 33
- oslevel 20

- flags 20
- Outer edge 137
- outer middle 137
- output report
  - error log 192
- overview
  - error logging subsystem 186
- P**
- Paging space
  - Placement on disk 137
- paging space
  - commands 251
  - tips 248
- pax 203
- PCI
  - CHRP 48
  - configuring devices 57
  - slot numbers 57
- pd\_npages 242
- persistent storage 236
- pg 390, 393
  - s option 393
- physical partition
  - listing allocation 85
  - listing allocations 87
  - moving 92
- Physical partitions 138
- physical partitions 78
- physical volume 78
  - adding to, volume group 94
  - configuration 79
  - identity (PVID) 80
  - listing characteristics 83
  - listing information 82
  - listing, logical volume allocation 85
  - making disks 81
  - managing 79
  - migrating 87
  - removing 82
  - removing from 95
  - setting allocation permissions 81
  - setting availability 82
- physical volumes
  - modifying 81
- ping 275
- platform
  - PowerPC 48
- portmap 273
- powerfail
  - action, /etc/inittab 32
- powerwait
  - action, /etc/inittab 32
- PPP
  - administrative groups 348
  - chat dialog 353
  - client 352
  - configuring
    - adding a TTY port 349
    - AIX PPP client 352
    - AIX PPP server 343
    - diagnostic output 351
    - dial-in ID 343
    - dial-in modem 343, 350
    - IP addresses 343
    - link control 343
  - encapsulating multiprotocol datagrams 341
  - internet protocol control protocol (IPCP) 341
  - IP address pool 341
  - IP interfaces 346
  - ipforwarding 347
  - link control protocol (LCP) 341
  - login user, .profile 348
  - max async HDLC attachments 343, 352
  - max client connections 343, 352
  - max demand interfaces 343
  - max IP interfaces 343, 352
  - max server connections 343, 352
  - network control protocols (NCPs) 341
    - network layer protocols 341
  - PPP daemons
    - pppattachd 342
    - pppcontrold 342
  - PPP files
    - .profile 348
    - /etc/ftpusers 349
    - /etc/ppp/if\_conf 347
    - /etc/ppp/lcp\_config 345, 353
    - /etc/syslog.conf 351
    - /etc/uucp/Devices 350
  - pppdial 342
  - pppattachd 342
  - pppcontrold 342
    - starting 351
  - pppdial 342
  - primary group 348
  - uucp 342

- PPP client
  - /etc/ppp/lcp\_config 353
- PPP server
  - /etc/ppp/lcp\_config 345
- PPP user 348
  - .profile 348
  - smitty user 348
- pppcontrol
  - diagnostic output 351
  - start PPP 351
- predefined
  - ODM database 56
- PReP (PowerPC Reference Platform) 48
- preservation install
  - /etc/preserve.list 13
  - data removed 13
  - data saved 13
  - disk space 13
  - preserve, volume group 13
  - system configuration 13
- previous boot device 36
- primary dump device 194, 250
- printer colon files 312
- printers 311, 313
  - filters 327
    - AIX common filters 327, 329
  - printer colon files 312
  - queues
    - cannot add print queue 334
    - clearing queues 330
    - preventing queue hangs 330
    - qdaemon will not start 334
  - remote printing 312
    - /etc/hosts.lpd 313
    - creating virtual printers 316
    - lpd daemon 314
    - remote printing problems 319
    - remote trace 321
    - virtual printers 315
  - setting default printers 335
    - using LPDEST environment variable 336
    - using smitty qdefault 335
  - virtual printers 315
    - files 315
    - iptrace facility
      - iptrace command 321
- problem determination tools 181
- problem diagnosis
  - X application

- DISPLAY 291
- X-windows server 291
  - X-windows server access control 291
- protocols
  - datagram protocol 342
  - internet protocol control protocol (IPCP) 341
  - link control protocol (LCP) 341
  - network control protocols (NCPs) 341
  - TCP/IP network layer protocols 341
- proxy arp
  - PPP 347
- ptfload.log 22

## Q

- qcan command 333
- qchk command 333
- qhld 333

## R

- RAN 63
  - considerations 65
- raw logical volume, saving 222
- read errors 69
- recording
  - ISA settings 59
- recovering
  - corrupted /etc/inittab file 44
  - corrupted CuDv database 43
  - corrupted file system 42
  - corrupted JFS log 42
  - corrupted super block 43
  - damaged boot image 41
  - invalid boot list 42
  - JFS log 42
  - system configuration 43
- Redbooks Web site 424
  - Contact us xx
- reducevg 115, 131
- reducevg command 91, 95
- reducing
  - physical volumes, reducevg command 91
- remote access node (RAN) 65
- remote printing 312
  - /etc/hosts.lpd 313
  - creating virtual printers 316
    - using smitty mkpq 317
  - hostname entries 313
  - iptrace facility

- command identifiers for LPD, interpreting trace 325
- lpd daemon 314
- remote printing problems
  - 0781-202 error message 320
  - 0781-374 error message 319
  - troubleshooting 319
- remote trace facility 321
  - iptrace 321, 322
- remote printing problems 319
- remote trace facility 321
  - iptrace 321
  - interpreting iptrace output 322
- remove, crontab 367
- removing
  - devices, rmdev command 67
  - disks from volume groups 91
  - physical volume 82
  - physical volumes 95
  - physical volumes, rmdev 91
- renice 244
- requirements
  - minimum space for, volume groups 93
- resolver routine 289
- respawn
  - action, /etc/inittab 31
- restore
  - command 218, 224
  - verifying mksysb tape 217
- restoring
  - data from tape 222
  - errors with 225
  - rootvg 223
- restvg 224
- rexec 289
  - automatic login 289
- rlogin 291
- rmdev command 67, 91
- rmfs 153
- rmlv 126, 131
- rootvg
  - restoring 223
- routed 273
- rs6k
  - Micro Channel-based 48
- rs6ksmp
  - Micro Channel-based SMP 48
- RSPC
  - ISA bus model 48

rwhod 273

## S

- savevg 221
- saving
  - information 212
  - raw logical volume 222
  - user data 219
- saving ODM database 43
- schedule, at job 358
- script creation
  - #!/usr/bin/ksh 413, 417
  - case command 416, 418
  - comments 417
  - exiting 414, 418, 419
  - for loop 416, 417
  - if/elif/else 415, 418
  - if/else 415, 418
  - if/then 414, 417, 419
  - script comments 413
  - search path 413
  - shell variables 414
  - standard i/o 414, 417
  - variables 417
  - while loop 415, 417
- SCSI
  - devices, configuring 57
- sendmail 273, 290
- service boot list 36
- setting default printers 335
  - using LPDEST environment variable 336
  - using smitty qdefault 335
- settings
  - TERM variable 67
- setup strings
  - modem 350
- shell
  - .env 410
  - /etc/environment 408
  - /etc/profile 406
  - profiles 405
  - shell environment 403
    - bourne shell 404
    - C shell 404
    - korn shell 404
    - restricted shell 405
    - setting up
      - .env 410



- .profile 409
- /etc/environment 407
- /etc/profile 406
- command line 410
- slot numbers
  - PCI devices 57
- SMIT
  - ODM system data 71
- SMIT fast path
  - smitty devinst\_isa 59
  - smitty isa 60
  - smitty lsattr 54
  - smitty lsmksysb 216
  - smitty migratepv 90
  - smitty mkvg 93
  - smitty tape 67
  - smitty vgsc 94
- SMIT fast path commands 171
- smit update\_all
  - download directory 23
  - modification level 21
- smit.log 19
- smitty
  - jfs 127
  - lvm 106
  - mkiv 159
  - vg 112, 116, 120
- snap command 205, 206
- Software Vital Product Data (SWVPD) 15
- spray 295
- stacklist 23
- starting
  - error logging daemon 188
  - lpd daemon 314
- startsrc
  - nfsd 164
- stdferr 33
- stdin 33
- stdout 33
- stopsrc
  - nfsd 164
- storage
  - limitations of logical volumes 79
  - logical volume, concepts 78
- Strict - Disk allocation 138
- strings 398, 399
- striped
  - logical volume 90
- subnetting 283
- subsystem name
  - PPP 343, 352
- superblock
  - dirty 162
- Superstrict - Disk allocation 138
- sysdumpdev command 195
- sysinit
  - action, /etc/inittab 33
- syslogd 273
- system configuration
  - copying 43
- system data 71
- system dump 194
  - copying onto tape 205
  - crash codes 198
  - messages 197
  - statistical information 196
  - user initiated 200
  - user initiated, copying 203
  - user initiated, starting 200
  - user initiated, types of 201
  - user initiated, verifying 201
- system dump device
  - changing default dump device 195
- system dump size
  - estimating 195
- system initialization and boot 29
  - system startup process 30
- system performance tools
  - bos.acct 231
  - iostat, CPU statistics 238
  - iostat, disk statistics 239
  - output report
    - iostat 238
    - vmstat 235
  - persistent storage I/O 236
  - vmstat, CPU statistics 235
  - vmstat, paging activity 231
- system resource controller (SRC)
  - /etc/inittab 35
  - lpd daemon 314
- system resource information
  - ODM system data 71
- system run level 30
- system startup 30
  - /etc/inittab
    - entry fields 31
    - initdefault 30
    - maintenance run level 30

- system run level 30
  - init command 30
  - initialization problems 35
  - startup process 30
  - system run level 30
- T**
- tape
  - restoring 222
- tape drive
  - adding 67
- tcopy 226
- TCP/IP
  - gated 273
  - inetd 273
  - lpd 273
  - named 273
  - portmapd 273
  - routed 273
  - rwhod 273
  - sendmail 273
  - TCP/IP network layer protocols 341
  - timed 273
- TCP/IP daemons
  - /etc/inittab 35
- tctl 217
- telinit 35
- telnet 291
- TERM environment variable 67
- thewall
  - default value 299
  - takes effect 300
- time, crontab schedule 366
- timed 273
- tools
  - bos.perf.tools 231
- topas command 232
- traceroute 281
- troubleshooting
  - corrupted /etc/inittab file 44
  - corrupted file system 42
  - corrupted JFS log 42
  - corrupted super block 43
  - damaged boot image 41
  - invalid boot list 42
- TTY
  - adding 66
- TTY ports

- PPP 349
- tuning options, network
  - arptab\_nb 303
  - ipqmaxlen 303
  - rec\_que\_size (AIX Version 3 only) 304
  - rfc1323 302
  - sb\_max 301
  - sockthresh 301
  - tcp\_pmtu\_discover 302
  - tcp\_recvspace 302
  - tcp\_sendspace 301, 302
  - udp\_pmtu\_discover 303
  - udp\_recvspace 302
  - udp\_sendspace 302
  - xmt\_que\_size 303
- tuning options, VMM
  - I/O requests 246
  - maxfree 247
  - maxpgahead 246
  - minfree 247
  - minpgahead 246
  - striping 246

- U**
- umount 106, 126
- unreachable domain name server 287
- update, crontab 365
- user
  - PPP
    - uucp group 348
- user-level processes
  - attachment process 342
  - control daemon 342
  - dialer process 342
  - PPP 342
- using filters, printers 329
- uucp
  - /etc/uucp/Devices, PPP 350
  - chat dialog format, PPP 342
  - PPP 342
  - uucp group
    - attachment process, PPP 342
- uucp group
  - PPP user 348

- V**
- verify, crontab 366
- verifying

- file system 42
- mksysb, using restore 217
- system backup 215
- user initiated dump 201
- vi editor 372, 381, 384, 386
  - adjusting screen 379
  - appending text 382
  - command flags 373
  - editing text
    - adding text 376
    - changing from command mode 377
    - changing in input mode 376
    - copying & moving 377
    - marking location 376
    - restoring & repeating 378
  - find text 384
  - inserting a line 383
  - inserting text 381, 383
  - interrupting & ending 380
  - limitations 372
  - manipulating files
    - current info 379
    - editing list 379
    - editing second 378
    - saving 378
  - moving cursor
    - by character position 375
    - by line position 375
    - to sentences 375
    - to words 375
    - within a line 374
  - operational modes 372
  - quitting 383
  - replacing text 384
    - multiple characters 384
    - multiple occurrences 386
    - replacing slash marks 387
    - single character 385
    - word 384
  - saving 383
  - shell commands 380
  - subcommands 374
  - yank line 385
- view 394
- Virtual Memory Manager (VMM) 299
- virtual printers 315
  - basic functions 316
  - commands 315
  - lsvirprt 315
  - smitty chpq 315
  - smitty chvirprt 316
  - smitty mkpq 315
  - smitty rmpq 315
- creating 316
  - using smitty mkpq 317
- files 315
  - /etc/qconfig 315
  - /usr/lib/lpd/pio/etc/\*.attach 315
  - /usr/lib/lpd/pio/etc/\*.config 315
  - /usr/lib/lpd/pio/predef/\* 315
  - /usr/sbin/mkvirprt 315
  - /var/spool/lpd/pio/@local/custom/\* 315
  - /var/spool/lpd/pio/@local/ddi\* 315
- iptrace facility 321
- vital products
  - ODM system data 71
- vmstat 247
- vmstat command 234
- vmtune 246, 247
- vmtune command 242
- volume group 78
  - adding 92
  - adding, physical volumes 94
  - information 40
  - managing 92
  - modifying 94
  - removing, physical volumes 95

## W

- wait
  - action, /etc/inittab 32
  - whence 24
  - Workload Manager 244
  - write verify policy 139

## X

- xhost 292
- xinit 292





**Redbooks**

# IBM <sup>®</sup>server Certification Study Guide - pSeries AIX System Support

(1.0" spine)  
0.875" <-> 1.498"  
460 <-> 788 pages







# IBM <sup>®</sup>@server Certification Study Guide - pSeries AIX System Support



**Developed specifically for the purpose of preparing for AIX certification**

**Makes an excellent companion to classroom education**

**For AIX professionals**

This redbook is designed as a study guide for professionals wishing to prepare for the certification exam to achieve: IBM <sup>®</sup>@server Certified Specialist - pSeries AIX System Support. The system support certification validates a broad scope of AIX problem determination and resolution skills and the ability to perform general AIX software system maintenance.

This redbook helps AIX support professionals seeking a comprehensive and task-oriented guide for developing the knowledge and skills required for the certification. It is designed to provide a combination of theory and practical experience needed for a general understanding of the subject matter. It also provides sample questions that will help in the evaluation of personal progress and provide familiarity with the types of questions that will be encountered in the exam.

This redbook does not replace practical experience you should have, but is an effective tool that, when combined with education activities and experience, should prove to be a very useful preparation guide for the exam. Due to the practical nature of the certification content, this publication can also be used as a desk-side reference. So, whether you are planning to take the pSeries AIX System Support certification exam, or if you just want to validate your AIX system support skills, this redbook is for you.

## **INTERNATIONAL TECHNICAL SUPPORT ORGANIZATION**

### **BUILDING TECHNICAL INFORMATION BASED ON PRACTICAL EXPERIENCE**

IBM Redbooks are developed by the IBM International Technical Support Organization. Experts from IBM, Customers and Partners from around the world create timely technical information based on realistic scenarios. Specific recommendations are provided to help you implement IT solutions more effectively in your environment.

**For more information:  
[ibm.com/redbooks](http://ibm.com/redbooks)**