

AIX 5L™ Version 5.3



Communications Programming Concepts

AIX 5L™ Version 5.3



Communications Programming Concepts

Note

Before using this information and the product it supports, read the information in "Notices," on page 327.

Seventh Edition (October 2009)

This edition applies to AIX 5L Version 5.3 and to all subsequent releases of this product until otherwise indicated in new editions.

A reader's comment form is provided at the back of this publication. If the form has been removed, address comments to Information Development, Department 04XA-905-6B013, 11501 Burnet Road, Austin, Texas 78758-3400. To send comments electronically, use this commercial Internet address: pserinfo@us.ibm.com. Any information that you supply may be used without incurring any obligation to you.

(c) Copyright AT&T, 1984, 1985, 1986, 1987, 1988, 1989. All rights reserved.

Copyright Sun Microsystems, Inc., 1985, 1986, 1987, 1988. All rights reserved.

The Network File System (NFS) was developed by Sun Microsystems, Inc.

This software and documentation is based in part on the Fourth Berkeley Software Distribution under license from The Regents of the University of California. We acknowledge the following institutions for their role in its development: the Electrical Engineering and Computer Sciences Department at the Berkeley Campus.

The Rand MH Message Handling System was developed by the Rand Corporation and the University of California. Portions of the code and documentation described in this book were derived from code and documentation developed under the auspices of the Regents of the University of California and have been acquired and modified under the provisions that the following copyright notice and permission notice appear:

Copyright Regents of the University of California, 1986, 1987, 1988, 1989. All rights reserved.

Redistribution and use in source and binary forms are permitted provided that this notice is preserved and that due credit is given to the University of California at Berkeley. The name of the University may not be used to endorse or promote products derived from this software without specific prior written permission. This software is provided "as is" without express or implied warranty.

(c) Copyright Apollo Computer, Inc., 1987. All rights reserved.

(c) Copyright TITN, Inc., 1984, 1989. All rights reserved.

© **Copyright International Business Machines Corporation 1994, 2009.**

US Government Users Restricted Rights – Use, duplication or disclosure restricted by GSA ADP Schedule Contract with IBM Corp.

Contents

About This Book	vii
Highlighting	vii
Case-Sensitivity in AIX.	vii
ISO 9000	vii
Related Publications	vii
Chapter 1. Data Link Control	1
Generic Data Link Control Environment Overview	2
Implementing GDLC Interface	4
GDLC Interface ioctl Entry Point Operations	5
GDLC Special Kernel Services	7
GDLC Problem Determination	8
Data Link Control Programming and Reference Information	11
Token-Ring Data Link Control Overview	12
DLCTOKEN Device Manager Nodes	13
DLCTOKEN Device Manager Functions	14
DLCTOKEN Protocol Support	15
DLCTOKEN Name-Discovery Service	16
DLCTOKEN Direct Network Services	19
DLCTOKEN Connection Contention.	19
Initiating DLCTOKEN Link Sessions.	19
Stopping DLCTOKEN Link Sessions	20
DLCTOKEN Programming Interfaces	20
IEEE 802.3 Ethernet Data Link Control Overview.	24
DLC8023 Device Manager Nodes	25
DLC8023 Device Manager Functions	25
DLC8023 Protocol Support	26
DLC8023 Name-Discovery Services	27
DLC8023 Direct Network Services	30
DLC8023 Connection Contention.	30
DLC8023 Link Sessions	30
DLC8023 Programming Interfaces	31
Standard Ethernet Data Link Control Overview.	34
DLCETHER Device Manager Nodes	35
DLCETHER Device Manager Functions	35
DLCETHER Protocol Support	36
DLCETHER Name-Discovery Services	37
DLCETHER Direct Network Services	40
DLCETHER Connection Contention.	40
DLCETHER Link Session Initiation	40
DLCETHER Link Session Termination	41
DLCETHER Programming Interfaces	41
Synchronous Data Link Control Overview	44
DLCSDLC Device Manager Functions	45
DLCSDLC Protocol Support	45
DLCSDLC Programming Interfaces	48
DLCSDLC Asynchronous Function Subroutine Calls.	51
Qualified Logical Link Control (DLCQLLC) Overview	51
Data Link Control FDDI (DLC FDDI) Overview	57
DLC FDDI Device Manager Nodes	58
DLC FDDI Device Manager Functions	58
DLC FDDI Protocol Support	59
DLC FDDI Name-Discovery Services	60

DLC FDDI Direct Network Services	63
DLC FDDI Connection Contention	63
DLC FDDI Link Sessions.	63
DLC FDDI Programming Interfaces	64
Chapter 2. Data Link Provider Interface Implementation	69
Primitive Implementation Specifics	69
Packet Format Registration Specifics	69
Address Resolution Routine Registration Specifics	70
ioctl Specifics	71
Dynamic Route Discovery	73
DRD Configuration	73
Connectionless Mode Only DLPI Driver versus Connectionless/Connection-Oriented DLPI Driver	73
DLPI Primitives	74
Obtaining Copies of the DLPI Specifications	76
Chapter 3. New Database Manager	77
Using NDBM Subroutines	77
Diagnosing NDBM Problems	77
List of NDBM and DBM Programming References	77
Chapter 4. eXternal Data Representation	79
eXternal Data Representation Overview for Programming.	79
XDR Subroutine Format	81
XDR Library	81
XDR Language Specification	82
XDR Data Types.	84
List of XDR Programming References	94
XDR Library Filter Primitives	95
XDR Non-Filter Primitives	98
Passing Linked Lists Using XDR Example	100
Using an XDR Data Description Example	102
Showing the Justification for Using XDR Example	103
Using XDR Example	105
Using XDR Array Examples	106
Using an XDR Discriminated Union Example	107
Showing the Use of Pointers in XDR Example	108
Chapter 5. Network Computing System	109
Remote Procedure Call Runtime Library	109
The Location Broker	110
Chapter 6. Network Information Services (NIS and NIS+)	115
List of NIS and NIS+ Programming References	115
Chapter 7. Network Management	119
Simple Network Management Protocol	119
Management Information Base	120
Terminology Related to Management Information Base Variables	122
Working with Management Information Base Variables	123
Management Information Base Database	123
How a Manager Functions.	125
How an Agent Functions	125
List of SNMP Agent Programming References	127
SMUX Error Logging Subroutines Examples	128

Chapter 8. Remote Procedure Call	131
RPC Model	132
RPC Message Protocol	133
RPC Authentication	138
RPC Port Mapper Program	144
Programming in RPC	146
RPC Features	153
RPC Language	155
rpcgen Protocol Compiler	160
List of RPC Programming References	162
Using UNIX Authentication Example	166
DES Authentication Example	168
Using the Highest Layer of RPC Example	170
Using the Intermediate Layer of RPC Example	170
Using the Lowest Layer of RPC Example	171
Showing How RPC Passes Arbitrary Data Types Example	175
Using Multiple Program Versions Example	176
Broadcasting a Remote Procedure Call Example	177
Using the select Subroutine Example	178
rcp Process on TCP Example	178
RPC Callback Procedures Example	180
RPC Language ping Program Example	183
Converting Local Procedures into Remote Procedures Example	184
Generating XDR Routines Example	187
Chapter 9. Sockets	191
Sockets Overview	191
Sockets Interface	193
Socket Subroutines	194
Socket Header Files	195
Socket Communication Domains	196
Socket Addresses	198
Socket Types and Protocols	201
Socket Creation	205
Binding Names to Sockets	205
Socket Connections	207
Socket Options	210
Socket Data Transfer	210
Socket Shutdown	212
IP Multicasts	213
Network Address Translation	214
Domain Name Resolution	218
Socket Examples	220
Socketpair Communication Example	220
Reading Internet Datagrams Example Program	221
Sending Internet Datagrams Example Program	222
Reading UNIX Datagrams Example Program	223
Sending UNIX Datagrams Example Program	223
Initiating Internet Stream Connections Example Program	224
Accepting Internet Stream Connections Example Program	225
Checking for Pending Connections Example Program	226
Initiating UNIX Stream Connections Example Program	227
Accepting UNIX Stream Connections Example Program	228
Sending Data on an ATM Socket PVC Client Example Program	229
Receiving Data on an ATM Socket PVC Server Example Program	230
Sending Data on an ATM Socket Rate-Enforced SVC Client Example Program	231

Receiving Data on an ATM Socket Rate-Enforced SVC Server Example Program	235
Sending Data on an ATM Socket SVC Client Example Program	237
Receiving Data on an ATM Socket SVC Server Example Program	240
Receiving Packets Over Ethernet Example Program	243
Sending Packets Over Ethernet Example Program	245
Analyzing Packets Over the Network Example Program	247
List of Socket Programming References.	248
Chapter 10. STREAMS.	251
STREAMS Introduction	251
Benefits and Features of STREAMS	254
STREAMS Flow Control	256
STREAMS Synchronization	257
Using STREAMS	264
STREAMS Tunable Parameters.	265
streamio (STREAMS ioctl) Operations	267
Building STREAMS	267
STREAMS Messages	270
Put and Service Procedures	273
STREAMS Drivers and Modules	274
log Device Driver	277
Configuring Drivers and Modules in the Portable Streams Environment	279
An Asynchronous Protocol STREAMS Example	282
Differences Between Portable Streams Environment and V.4 STREAMS.	287
List of Streams Commands	288
List of STREAMS Programming References	289
Transport Service Library Interface Overview	291
Chapter 11. Transmission Control Protocol/Internet Protocol	295
DHCP Server API	295
Dynamic Load API	301
Service Location Protocol (SLP) APIs	305
Lists of Programming References	309
Chapter 12. Packet Capture Library	313
Packet Capture Library Overview	313
Packet Capture Library Subroutines	314
Packet Capture Library Header Files	314
Packet Capture Library Data Structures	314
Packet Capture Library Filter Expressions	315
Sample 1: Capturing Packet Data and Printing It in Binary Form to the Screen	317
Sample 2: Capturing Packet Data and Saving It to a File for Processing Later	320
Sample 3: Reading Previously Captured Packet Data from a Savefile and Processing It	324
Appendix. Notices	327
Trademarks	328
Index	329

About This Book

This book provides programmers with complete information about creating and implementing communications programs for the AIX® operating system. Users of this book need to be familiar with the C programming language. Programmers can use this book to gain knowledge of DLCs (Data Link Controls), DLPI (Data Link Provider Interface), NDBM (new Database Manager), XDR (eXternal Data Representation), NCS (Network Computing System), NIS (Network Information Services), SNMP (Simple Network Management Protocol), RPC (Remote Procedure Call), Sockets, STREAMS, and TCP/IP (Transmission Control Protocol/Internet Protocol).

Highlighting

The following highlighting conventions are used in this book:

Bold	Identifies commands, subroutines, keywords, files, structures, directories, and other items whose names are predefined by the system. Also identifies graphical objects such as buttons, labels, and icons that the user selects.
<i>Italics</i>	Identifies parameters whose actual names or values are to be supplied by the user.
Monospace	Identifies examples of specific data values, examples of text similar to what you might see displayed, examples of portions of program code similar to what you might write as a programmer, messages from the system, or information you should actually type.

Case-Sensitivity in AIX

Everything in the AIX operating system is case-sensitive, which means that it distinguishes between uppercase and lowercase letters. For example, you can use the **ls** command to list files. If you type **LS**, the system responds that the command is "not found." Likewise, **FILEA**, **FiLea**, and **filea** are three distinct file names, even if they reside in the same directory. To avoid causing undesirable actions to be performed, always ensure that you use the correct case.

ISO 9000

ISO 9000 registered quality systems were used in the development and manufacturing of this product.

Related Publications

The following books contain information about or related to communications:

- *Networks and communication management*
- *AIX 5L Version 5.3 Technical Reference: Communications Volume 1*
- *AIX 5L Version 5.3 Technical Reference: Communications Volume 2*
- *AIX 5L Version 5.3 General Programming Concepts: Writing and Debugging Programs*
- *AIX 5L Version 5.3 Kernel Extensions and Device Support Programming Concepts*
- *AIX 5L Version 5.3 Technical Reference: Base Operating System and Extensions Volume 1*
- *AIX 5L Version 5.3 Technical Reference: Base Operating System and Extensions Volume 2*

Chapter 1. Data Link Control

Generic data link control (GDLC) defines a generic interface with a common set of commands that allows application and kernel users to control DLC device managers within the operating system.

This chapter discusses the following topics:

- “Generic Data Link Control Environment Overview” on page 2
- “Implementing GDLC Interface” on page 4
- “GDLC Interface ioctl Entry Point Operations” on page 5
- “GDLC Special Kernel Services” on page 7
- “GDLC Problem Determination” on page 8
- “Data Link Control Programming and Reference Information” on page 11
- “Token-Ring Data Link Control Overview” on page 12
- “DLCTOKEN Device Manager Nodes” on page 13
- “DLCTOKEN Device Manager Functions” on page 14
- “DLCTOKEN Protocol Support” on page 15
- “DLCTOKEN Name-Discovery Service” on page 16
- “DLCTOKEN Direct Network Services” on page 19
- “DLCTOKEN Connection Contention” on page 19
- “Initiating DLCTOKEN Link Sessions” on page 19
- “Stopping DLCTOKEN Link Sessions” on page 20
- “DLCTOKEN Programming Interfaces” on page 20
- “IEEE 802.3 Ethernet Data Link Control Overview” on page 24
- “DLC8023 Device Manager Nodes” on page 25
- “DLC8023 Device Manager Functions” on page 25
- “DLC8023 Protocol Support” on page 26
- “DLC8023 Name-Discovery Services” on page 27
- “DLC8023 Direct Network Services” on page 30
- “DLC8023 Connection Contention” on page 30
- “DLC8023 Link Sessions” on page 30
- “DLC8023 Programming Interfaces” on page 31
- “Standard Ethernet Data Link Control Overview” on page 34
- “DLCETHER Device Manager Nodes” on page 35
- “DLCETHER Device Manager Functions” on page 35
- “DLCETHER Protocol Support” on page 36
- “DLCETHER Name-Discovery Services” on page 37
- “DLCETHER Direct Network Services” on page 40
- “DLCETHER Connection Contention” on page 40
- “DLCETHER Link Session Initiation” on page 40
- “DLCETHER Link Session Termination” on page 41
- “DLCETHER Programming Interfaces” on page 41
- “Synchronous Data Link Control Overview” on page 44
- “DLCSDLC Device Manager Functions” on page 45
- “DLCSDLC Protocol Support” on page 45
- “DLCSDLC Programming Interfaces” on page 48

- “DLCSDLC Asynchronous Function Subroutine Calls” on page 51
- “Qualified Logical Link Control (DLCQLLC) Overview” on page 51
- “Data Link Control FDDI (DLC FDDI) Overview” on page 57
- “DLC FDDI Device Manager Nodes” on page 58
- “DLC FDDI Device Manager Functions” on page 58
- “DLC FDDI Protocol Support” on page 59
- “DLC FDDI Name-Discovery Services” on page 60
- “DLC FDDI Direct Network Services” on page 63
- “DLC FDDI Connection Contention” on page 63
- “DLC FDDI Link Sessions” on page 63
- “DLC FDDI Programming Interfaces” on page 64

Generic Data Link Control Environment Overview

Generic data link control (GDLC) defines a generic interface with a common set of commands that allows application and kernel users to control DLC device managers within the operating system.

The GDLC interface specifies requirements for entry point definitions, functions provided, and data structures for all DLC device managers. DLCs that conform to the GDLC interface include:

- “Token-Ring Data Link Control Overview” on page 12
- “IEEE 802.3 Ethernet Data Link Control Overview” on page 24
- “Standard Ethernet Data Link Control Overview” on page 34
- “Synchronous Data Link Control Overview” on page 44
- “Qualified Logical Link Control (DLCQLLC) Overview” on page 51
- “Data Link Control FDDI (DLC FDDI) Overview” on page 57

DLC device managers perform higher layer protocols and functions beyond the scope of a kernel device driver. However, the managers reside within the kernel for maximum performance and use a kernel device driver for their I/O requests to the adapter. A DLC user is located above or within the kernel.

SDLC and IEEE 802.2 data link control are examples of DLC device managers. Each DLC device manager operates with a specific device driver or set of device drivers. SDLC, for example, operates with the Multiprotocol device driver for the system’s product and its associated adapter.

For more information about the GDLC environment, see:

- “Implementing GDLC Interface” on page 4
- “GDLC Interface ioctl Entry Point Operations” on page 5
- “GDLC Special Kernel Services” on page 7
- “GDLC Problem Determination” on page 8
- “Data Link Control Programming and Reference Information” on page 11

The DLC Device Manager Environment figure (Figure 1 on page 3) illustrates the basic structure of a DLC environment. Users within the kernel have access to the Communications memory buffers (mbufs) and call the **dd** entry points by way of the **fp** kernel services. Users above the kernel access the standard interface-to-kernel device drivers, and the file system calls the **dd** entry points. Data transfers require data movements between user and kernel space.

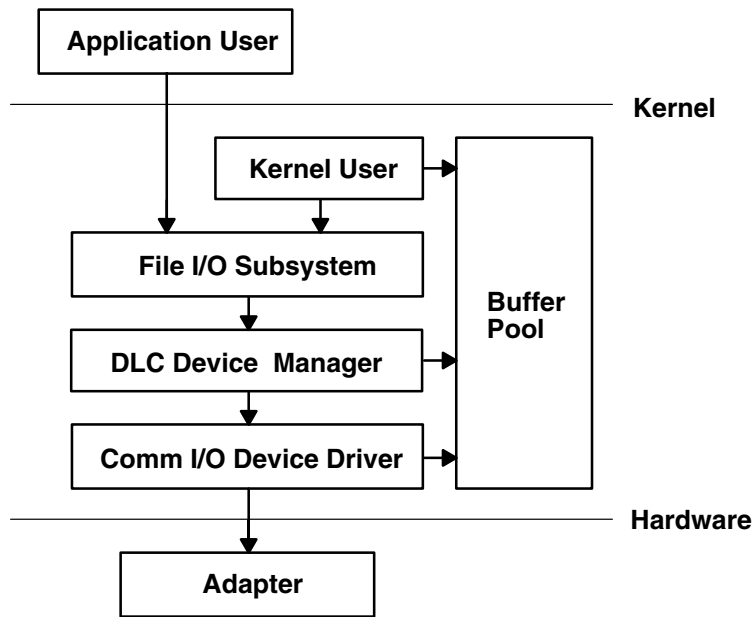

DLC Device Manager Environment

Figure 1. DLC Device Manager Environment. This diagram shows the application user accessing the file I/O subsystem. The kernel user accesses both the file I/O subsystem and the buffer pool. The file I/O subsystem accesses the DLC device manager which accesses the buffer pool and the comm I/O device manager. The comm I/O device driver accesses the buffer pool and the adapter which is below the kernel in the hardware.

The components of the DLC device manager environment are as follows:

application user	Resides above the kernel as an application or access method.
kernel user	Resides within the kernel as a kernel process or device manager.
file I/O subsystem	Converts the file-descriptor and file-pointer subroutines to file-pointer accesses of the switch table.
buffer pool	Provides data-buffer services for the communications subsystem.
comm I/O device driver	Controls hardware adapter input/output (I/O) and direct memory access (DMA) registers, and routes receive packets to multiple DLCs.
adapter	Attaches to the communications media.

A device manager written in accordance with GDLC specifications runs on all the operating system hardware configurations containing a communications device driver and its target adapter. Each device manager supports multiple users above and below the kernel. In general, users operate concurrently over a single adapter, or each user operates over multiple adapters. DLC device managers vary based on their protocol constraints.

The Multiple User and Multiple Adapter Configuration figure (Figure 2 on page 4) illustrates a multiple user configuration.

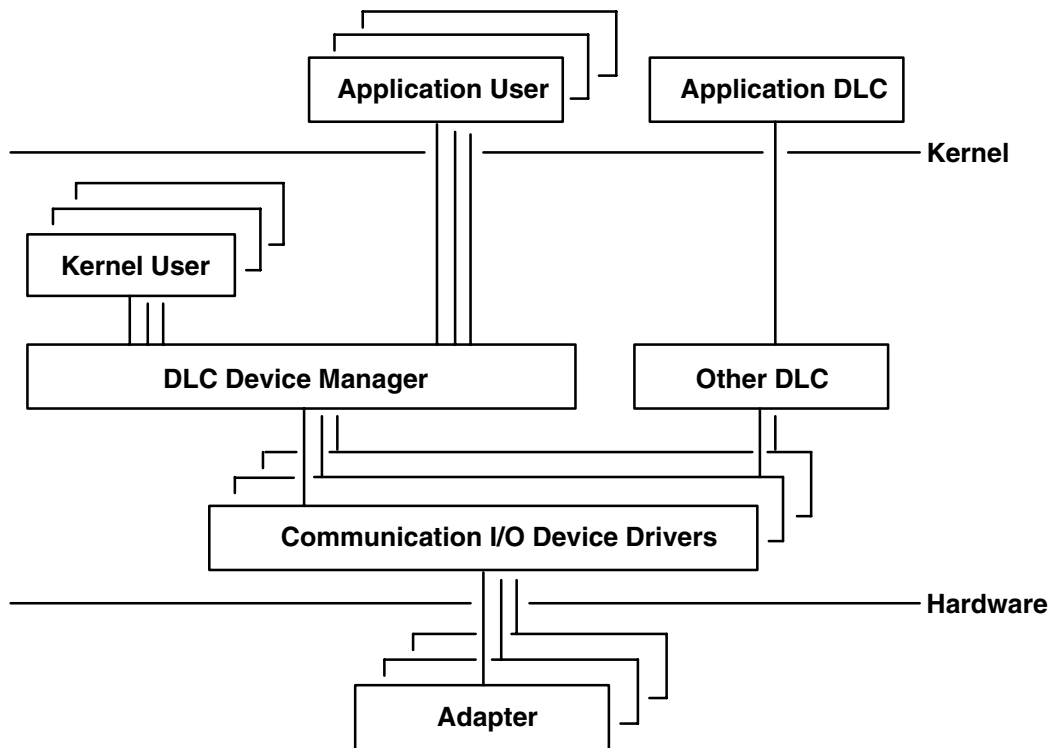

Multiple User and Multiple Adapter Configuration

Figure 2. Multiple User and Multiple Adapter Configuration. This diagram shows multiple application users and an application DLC above the kernel. The application users access the DLC device manager while the application DLC accesses multiple communication I/O device drivers. Multiple kernel users also access the DLC device manager. The other DLC also accesses multiple communication I/O device drivers. Multiple adapters, below the kernel in hardware, access the communication I/O device drivers.

Meeting the GDLC Criteria

A GDLC interface must meet the following criteria:

- Be flexible and accessible to both application and kernel users.
- Have multiple user and multiple adapter capability, allowing protocols to take advantage of multiple sessions and ports.
- Support connection-oriented and connectionless DLC device managers.
- For special requirements beyond the scope of the DLC device manager in use, must allow transparent data transfer.

Implementing GDLC Interface

Each data link control (DLC) device manager operates in the kernel as a standard `/dev` entry of a multiplexed device manager for a specified protocol. For an adapter not in use by DLC, each `open` subroutine to a DLC device manager creates a kernel process. An `open` subroutine is also issued to the target adapter's device handler. If needed, issue additional `open` subroutines for multiple DLC adapter ports of the same protocol. Any `open` subroutine targeting the same port does not create additional kernel processes, but links the `open` subroutine with the existing process. Each active port always uses one kernel process.

The internal structure of a DLC device manager has the same basic structure as a kernel device handler, except that a kernel process replaces the interrupt handler in asynchronous events. The Read, Write, I/O

Control, and Select blocks function as set forth in the Standard Kernel Device Manager (Figure 3) figure.

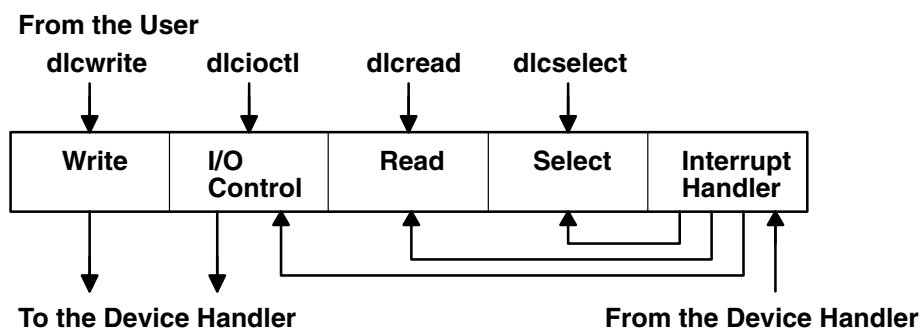

Standard Kernel Device Manager

Figure 3. Standard Kernel Device Manager. This diagram shows the *dlcwrite*, *dlcioctl*, *dlcread*, and *dlcselect* (from the user) traveling to write, I/O control, read and select, respectively (in the standard kernel device manager). The interrupt handler gets input from the device handler and its output is directed to select, read, and I/O control. The output of I/O control and write goes to the device handler.

Use the information in the following table to add an installed DLC.

Note: A data link control (DLC) must be installed before adding it to the system.

Adding an Installed DLC Task		
Web-based System Manager	wsm , then select network	
-OR-		
Task	SMIT Fast Path	Command or File
Adding an Installed DLC	Choose one (depending on type): smit cmddlc_sdlc smit cmddlc_token smit cmddlc_qllc smit cmddlc_ether (see note) smit cmddlc_fddi	mkdev

Note: The SMIT fast path to add an Ethernet device manager includes both Standard Ethernet and IEEE 802.3 Ethernet device managers.

GDLC Interface ioctl Entry Point Operations

The generic data link control (GDLC) interface supports the following ioctl subroutine operations:

DLC_ENABLE_SAP	Enables a service access point (SAP). See “Service Access Points” on page 6.
DLC_DISABLE_SAP	Disables a SAP. See “Service Access Points” on page 6.
DLC_START_LS	Starts a link station (LS) on a particular SAP as a caller or listener. See “Link Stations” on page 6.
DLC_HALT_LS	Halts an LS. See “Link Stations” on page 6.
DLC_TRACE	Traces a link station’s activity for short or long activities. See “Testing and Tracing Links” on page 7.
DLC_CONTACT	Contacts a remote station for a particular local link station.
DLC_TEST	Tests the link to a remote for a particular local link station. “Testing and Tracing Links” on page 7.

DLC ALTER	Alters a link station's configuration parameters.
DLC_QUERY_SAP	Queries statistics of a particular SAP.
DLC_QUERY_LS	Queries statistics of a particular link station.
DLC_ENTER_LBUSY	Enters local-busy mode on a particular link station. See "Local-Busy Mode" on page 7.
DLC_EXIT_LBUSY	Exits local-busy mode on a particular link station. See "Local-Busy Mode" on page 7.
DLC_ENTER_SHOLD	Enters short-hold mode on a particular link station. See "Short-Hold Mode" on page 7.
DLC_EXIT_SHOLD	Exits short-hold mode on a particular link station. See "Short-Hold Mode" on page 7.
DLC_GET_EXCEP	Returns asynchronous exception notifications to the application user. Note: This ioctl subroutine operation is not used by the kernel user since all exception conditions are passed to the kernel user by way of their exception handler.
DLC_ADD_GRP	Adds a group or multicast receive address to a port.
DLC_ADD_FUNC_ADDR	Adds a group or multicast receive functional address to a port.
DLC_DEL_FUNC_ADDR	Removes a group or multicast receive functional address from a port.
DLC_DEL_GRP	Removes a group or multicast address from a port.
IOCINFO	Returns a structure that describes the GDLC device manager. See the <code>/usr/include/sys/devinfo.h</code> file format for more information.

Service Access Points

A *service access point* (SAP) identifies a particular user service that sends and receives a specific class of data. This user service allows different classes of data to be routed separately to their corresponding service handlers. Those DLCs that support multiple concurrent SAPs have addresses known as *destination* SAP and *source* SAP embedded in their packet headers. DLCs that can only support a single SAP do not need or use SAP addressing, but still have the concept of enabling the one SAP. In general, SAP is enabled for each DLC user on each port.

Most SAP address values are defined by IEEE standardized network-management entities or user-defined values as specified in the *Token-Ring Network Architecture Reference*. Some of the common SAP addresses are:

null SAP (0x00)	Provides some ability to respond to remote nodes even when no SAP has been enabled. This SAP supports only connectionless service and responds only to exchange identification (XID) and TEST Link Protocol Data Units (LPDU).
SNA path control (0x04)	Denotes the default individual SAP address used by Systems Network Architecture (SNA) nodes.
PC network NETBIOS (0xF0)	Used for all DLC communication that is driven by Network Basic I/O System (NetBIOS) emulation.
discovery SAP (0xFC)	Used by the local area network (LAN) name-discovery services.
global SAP (0xFF)	Identifies all active SAPs.

Note: See Request for Comment (RFC) 1060 for examples of IEEE 802 Local SAP values. RFCs are available from the Network Information Center at SRI International, Menlo Park, California.

Link Stations

A *link station* (LS) identifies an attachment between two nodes for a particular SAP pair. This attachment can operate as a connectionless service (datagram) or connection-oriented service (fully sequenced data transfer with error recovery). In general, one LS is started for each remote attachment.

Local-Busy Mode

When an LS operates in a connection-oriented mode, it needs to stop the remote station's sending of information packets for reasons such as resource outage. Notification can then be sent to the remote station to cause the local station to enter local-busy mode. Once resources are available, the local station notifies the remote that it is no longer busy and that information packets can flow again. Only sequenced information packets are halted with local-busy mode. All other types of data are unaffected.

Short-Hold Mode

Use the short-hold mode of operation when operating over data networks with the following characteristics:

- Short call-setup time
- Tariff structure that specifies a relatively small fee for the call setup compared to the charge for connect time

During short-hold mode, an attachment between two stations is maintained only to transfer data available between the two stations. When no data is sent, the attachment is cleared after a specified time-out period and is only reestablished to transfer new data.

Testing and Tracing Links

To test an attachment between two stations, instruct an LS to send a test packet from the local station. This packet is echoed back from the remote station if the attachment is operating correctly.

Some data links are limited in their support of this function due to protocol constraints. Synchronous data link control (SDLC), for example, only generates the test packet from the host or primary station. Most other protocols, however, allow test packets to be initiated from either station.

To trace a link, line data and special events (such as station activation, termination, and time outs) can be logged in the generic trace facility for each LS. This function helps determine the cause of certain communications attachment problems. The GDLC user can select either short or long entries to be traced.

Short entries consist of up to 80 bytes of line data, while long entries allow full packets of data to be traced.

Tracing can be activated when an LS is started, or it can be dynamically activated or terminated at any time afterward.

Statistics

Both SAP and LS statistics can be queried by a GDLC user. The statistics for a SAP consist of the current SAP state and information about the device handler. LS statistics consist of the current station states and various reliability, availability, and serviceability counters that monitor the activity of the station from the time it is started.

GDLC Special Kernel Services

Generic data link control (GDLC) provides special services for a kernel user. However, a trusted environment must exist within the kernel. Instead of the DLC device manager copying asynchronous event data into user space, the kernel user must specify function pointers to special routines called *function handlers*. Function handlers are called by DLC at the time of execution. This process allows maximum performance between the kernel user and the DLC layers. Each kernel user is required to restrict the number of function handlers to a minimum path length and use the communications memory buffer (mbuf) scheme.

Note: A function handler must never call another DLC entry directly. Direct calls made under lock cause a fatal sleep. The only exception to this rule is when a kernel user may call the `dlcwritex` entry point

during its service of any of the four receive data functions. Calling the `dlcwritex` entry point allows immediate responses to be generated without an intermediate task switch. Special logic is required within the DLC device manager to check the process identification of the user calling a write operation. If it is a DLC process and the internal queuing capability of the DLC has been exceeded, the write is sent back with an error code (**EAGAIN** value) instead of putting the calling process (DLC) to sleep. It is then up to the calling user subroutine to return a special notification to the DLC from its receive-data function to ensure a retry of the receive buffer at a later time.

The user-provided function handlers are:

datagram data received exception condition	Called any time a datagram packet is received for the kernel user. Called any time an asynchronous event occurs that must notify the kernel user, such as SAP Closed or Station Contacted .
I-frame data received	Called each time a normal sequenced data packet is received for the kernel user.
network data received	Called any time network-specific data is received for the kernel user.
XID data received	Called any time an exchange identification (XID) packet is received for the kernel user.

The `dlcread` and `dlcselect` entry points for DLC are not called by the kernel user because the asynchronous functional entries are called directly by the DLC device manager. Generally, any queuing of these events must occur in the user's function handler. If, however, the kernel user cannot handle a particular receive packet, the DLC device manager may hold the last receive buffer and enter one of two special user-busy modes:

user-terminated busy mode (I-frame only)	If the kernel user cannot handle a received I-frame (due to problems such as queue blockage), a DLC_FUNC_BUSY return code is given back, and DLC holds the buffer pointer and enters local-busy mode to stop the remote station's I-frame transmissions. The kernel user must call the <code>exit local-busy</code> function to reset local-busy mode and start the reception of I-frames again. Only normal sequenced I-frames can be stopped. XID, datagram, and network data are not affected by local-busy mode.
timer-terminated busy mode (all frame types)	If the kernel user cannot handle a particular receive packet and wants DLC to hold the receive buffer for a short period and then recall the user's receive function, a DLC_FUNC_RETRY return code is sent back to DLC. If the receive packet is a sequenced I-frame, the station enters local-busy mode for that period. In all cases, a timer is started; when the timer expires, the receive-data functional entry is called again.

GDLC Problem Determination

Each generic data link control (GDLC) provides problem determination data that can be used to isolate network problems. Four types of diagnostic information are provided:

- "DLC Status Information"
- "DLC Error Log" on page 9
- "DLC Link Station Trace Facility" on page 10
- "LAN Monitor Trace" on page 10

DLC Status Information

Status information can be obtained for a service access point (SAP) or a link station (LS) using the **DLC_QUERY_SAP** and **DLC_QUERY_LS** `ioctl` subroutines to call the specific DLC kernel device manager in use.

The **DLC_QUERY_SAP** `ioctl` subroutine obtains individual device driver statistics from various devices:

- Token ring (See “Token-Ring Data Link Control Overview” on page 12)
- Ethernet (See “IEEE 802.3 Ethernet Data Link Control Overview” on page 24)
- Multiprotocol (See Multiprotocol in *AIX 5L Version 5.3 Kernel Extensions and Device Support Programming Concepts*)

The **DLC_QUERY_LS** ioctl subroutine obtains LS statistics from various DLCs. These statistics include data link protocol counters. Each counter is reset by the DLC during the **DLC_START_LS** ioctl subroutine and generally runs continuously until the LS is terminated and its storage is freed. If a counter reaches the maximum count, the count is frozen and no wraparound occurs.

The suggested counters provided by a DLC device manager are listed as follows. Some DLCs can modify this set of counters based on the specific protocols supported. For example, the number of rejects or receive-not-ready packets received might be meaningful.

test commands sent	Contains a binary count of the test commands sent to the remote station by GDLC, in response to test commands issued by the user.
test command failures	Contains a binary count of the test commands that did not complete properly due to problems such as: <ul style="list-style-type: none"> • Incorrect response • Bad data comparison • Inactivity
test commands received	Contains a binary count of valid test commands received, regardless of whether the response is completed correctly.
sequenced data packets transmitted	Contains a binary count of the total number of normal sequenced data packets transmitted to the remote LS.
sequenced data packets retransmitted	Contains a binary count of the total number of normal sequenced data packets retransmitted to the remote LS.
maximum contiguous retransmissions	Contains a binary count of the maximum number of times a single data packet has been retransmitted to the remote LS before acknowledgment. This counter is reset each time a valid acknowledgment is received.
sequenced data packets received	Contains a binary count of the total number of normal sequenced data packets correctly received.
invalid packets received	Contains a binary count of the number of invalid commands or responses received, including invalid control bytes, incorrect I-fields, and overflowed I-fields.
adapter-detected receive errors	Contains a binary count of the number of receive errors reported back from the device driver.
adapter-detected transmit errors	Contains a binary count of the number of transmit errors reported back from the device driver.
receive inactivity timeouts	Contains a binary count of the number of receive time outs that have occurred.
command polls sent	Contains a binary count of the number of command packets sent that requested a response from the remote LS.
command repolls sent	Contains a binary count of the total number of command packets retransmitted to the remote LS due to a lack of response.
command contiguous repolls	Contains a binary count of the number of times a single command packet was retransmitted to the remote LS due to a lack of response. This counter is reset each time a valid response is received.

DLC Error Log

Each DLC provides entries to the system error log whenever errors are encountered. To call the kernel error collector, use the **errsave** kernel service.

The error conditions are reported by the system-product error log using the error log daemon (**errdemon**).

The user can obtain formatted error-log data by issuing the **errpt** command. When used with the **-N DLCName** flag, the **errpt** command produces a summary report of all the error log entries for the resource name indicated by the **DLCName** parameter. Valid values for the **DLCName** parameter include:

SYSXDLCE	Indicates a Standard Ethernet datalink.
SYSXDLCI	Indicates an IEEE 802.3 Ethernet datalink.
SYSXDLCT	Indicates a token-ring datalink.
SYSXDLCS	Indicates an synchronous data link control (SDLC) datalink.

For more information on the error log facility, refer to Error Logging Overview in *AIX 5L Version 5.3 General Programming Concepts: Writing and Debugging Programs*.

DLC Link Station Trace Facility

GDLC provides optional entries to a generic system trace channel as required by the system product Reliability/Availability/Serviceability (RAS). The default is trace-disabled, provides maximum performance, and reduces the number of system resources used. For information on additional trace facilities, see “LAN Monitor Trace.”

Trace Channels

The operating system supports up to seven generic trace channels in operation at the same time. Before starting an LS trace, a user must allocate a channel with the **DLC_START_LS** ioctl operation or the **DLC_TRACE** ioctl operation. Begin the trace sessions with the **trcstart** and **trcon** subroutines.

Trace activity in the LS must be stopped either by halting the LS or by issuing an ioctl (**DLC_TRACE**, flags=0) operation to that station. When the LS stops tracing, the channel is disabled with the **trcoff** subroutine and returned to the system with the **trcstop** subroutine.

Trace Entry Size

The GDLC user can select either short or long entries to be traced.

Short entries consist of up to 80 bytes of line data, while long entries allow full packets of data to be traced.

Tracing can be activated when an LS is started via configuration, or it can be dynamically activated or terminated via ioctl at any time afterward.

Trace Reports

The user can obtain formatted trace log data by issuing the **trcrpt** command with the appropriate file name, such as:

```
trcrpt /tmp/link1.log
```

This example produces a detailed report of all link trace entries in the **/tmp/link1.log** file, provided a prior **trcstart** subroutine specified the **/tmp/link1.log** file as the **-o** name for the trace log.

Trace Entries

For each trace entry, GDLC generates the **trcgenkt** kernel service to the kernel generic trace.

LAN Monitor Trace

Each of the local area network data link controls (DLCETHER, DLC8023, DLCFDDI, and DLCTOKEN) provides an internal monitor trace capability that can be used to identify the execution sequence of pertinent entry points within the code. This is useful if the network is having problems that indicate the data link is not operating properly, and the sequence of events may indicate the cause of the problems. This trace is shared among the LAN data link controls, and inactive is the default.

The LAN monitor trace can be enabled by issuing the following command:

```
trace -j 246
```

where 246 is the hook ID to be traced.

Tracing can be stopped with the **trcstop** command and a report can be obtained with the following command:

```
trcrpt -d 246
```

where 246 is the hook ID of the trace for which you want a report.

Note: Exercise caution when enabling the monitor trace, since it directly affects the performance of the DLCs and their associates.

For information on additional ways to use trace facilities, see DLC device driver management in *Networks and communication management*.

Data Link Control Programming and Reference Information

You can use several procedures, as well as the data link control (DLC) reference information, to manage DLC.

DLC Reference Information

The following sections list available DLC reference information:

- “DLC Entry Points”
- “Kernel Services for DLC”
- “Kernel Routines for DLC” on page 12
- “DLC Extended Parameters for Subroutines and Kernel Services” on page 12
- “Application Subroutines” on page 12
- “DLC Operations” on page 12

For more information on DLC reference items, see *AIX 5L Version 5.3 Technical Reference*.

DLC Entry Points

dlcclose	Closes a generic data link control (GDLC) channel.
dlcconfig	Issues specific commands to GDLC.
dlcioctl	Issues specific commands to GDLC.
dlcmpx	Decodes the device handler’s special file name appended to the opened call.
dlcopen	Opens a GDLC channel.
dlcread	Reads receive data from GDLC.
dlcselect	Selects for asynchronous criteria from GDLC, such as receive data completion and exception conditions.
dlcwrite	Writes transmit data to GDLC.

Kernel Services for DLC

fp_close	Allows kernel to close the GDLC device manager using a file pointer.
fp_ioctl	Transfers special commands from the kernel to GDLC.
fp_open	Allows kernel to open the GDLC device manager by its device name.
fp_write	Allows kernel data to be sent using a file pointer.

Kernel Routines for DLC

Following are kernel routines for DLC. Descriptions for each are in *AIX 5L Version 5.3 Technical Reference: Communications Volume 1*.

- Datagram Data Received Routine for DLC
- Exception Condition Routine for DLC
- I-Frame Data Received Routine for DLC
- Network Data Received Routine for DLC
- XID Data Received Routine for DLC

DLC Extended Parameters for Subroutines and Kernel Services

Following are DLC extended parameters for subroutines and kernel services. Descriptions for each are in *AIX 5L Version 5.3 Technical Reference: Communications Volume 1*

open Subroutine Extended Parameters for DLC

read Subroutine Extended Parameters for DLC

write Subroutine Extended Parameters for DLC

Application Subroutines

close	Subroutine Interface for Data Link Control Manager
ioctl	Subroutine Interface for Data Link Control Manager
open	Subroutine Interface for Data Link Control Manager
readx	Subroutine Interface for Data Link Control Manager
select	Subroutine Interface for Data Link Control Manager
writex	Subroutine Interface for Data Link Control Manager

DLC Operations

ioctl Operations (op) for DLC

Parameter Blocks by **ioctl** Operation for DLC

DLC Programming Procedures

Adding an Installed DLC in Implementing GDLC Interface (See “Implementing GDLC Interface” on page 4).

Listing, changing or removing DLC Attributes in DLC device driver management in *Networks and communication management*.

Token-Ring Data Link Control Overview

The token-ring data link control (DLCTOKEN) is a device manager that follows the generic data link control (GDLC) interface definition. This DLC device manager provides an access procedure to transfer four types of data over a token ring:

- Datagrams
- Sequenced data
- Identification data
- Logical link controls

This DLC device manager also provides a pass-through capability that allows transparent data flow.

The token-ring device handler and the Token-Ring High Performance Network Adapter transfer the data, with address checking, token generation, or frame-check sequences.

For more information on DLCTOKEN, see:

- “DLCTOKEN Device Manager Nodes”
- “DLCTOKEN Device Manager Functions” on page 14
- “DLCTOKEN Protocol Support” on page 15
- “DLCTOKEN Name-Discovery Service” on page 16
- “DLCTOKEN Direct Network Services” on page 19
- “DLCTOKEN Connection Contention” on page 19
- “Initiating DLCTOKEN Link Sessions” on page 19
- “Stopping DLCTOKEN Link Sessions” on page 20
- “DLCTOKEN Programming Interfaces” on page 20

DLCTOKEN Device Manager Nodes

The token-ring data link control (DLCTOKEN) device manager operates between two or more nodes on the token-ring local area network (LAN) using IEEE 802.2 procedures and control information as defined in the *Token-Ring Network Architecture Reference*. Protocol support includes:

- Asynchronous disconnected mode (ADM) and asynchronous balanced mode extended (ABME)
- Two-way simultaneous (full-duplex) data flow
- Multiple point-to-point logical attachments on the LAN using network and service access point addresses
- Peer-to-peer relationship with remote station
- Both name-discovery and address-resolve services
- Source-routing generation for up to eight bridge hops.

DLCTOKEN provides full-duplex, peer-data transfer capabilities over a token-ring LAN. The token-ring LAN must use the token-ring IEEE 802.5 medium access control (MAC) procedure and a superset of the IEEE 802.2 logical link control (LLC) protocol, as described in the *Token-Ring Network Architecture Reference*.

Multiple token-ring adapters are supported with a maximum of 254 service access point (SAP) users per adapter. A total of 255 link stations (LS) per adapter are supported and are distributed among active SAP users. Multiple ring segments can be accessed using token-ring network bridge facilities, with up to eight consecutive ring segments supported between any two nodes.

LLC refers to the manager, access-channel, and LS subcomponents of a generic data link control (GDLC) component, such as DLCTOKEN device manager, as illustrated in the DLC[OKEN, 8032, ETHER, or FDDI] Component Structure (Figure 4 on page 14) figure.

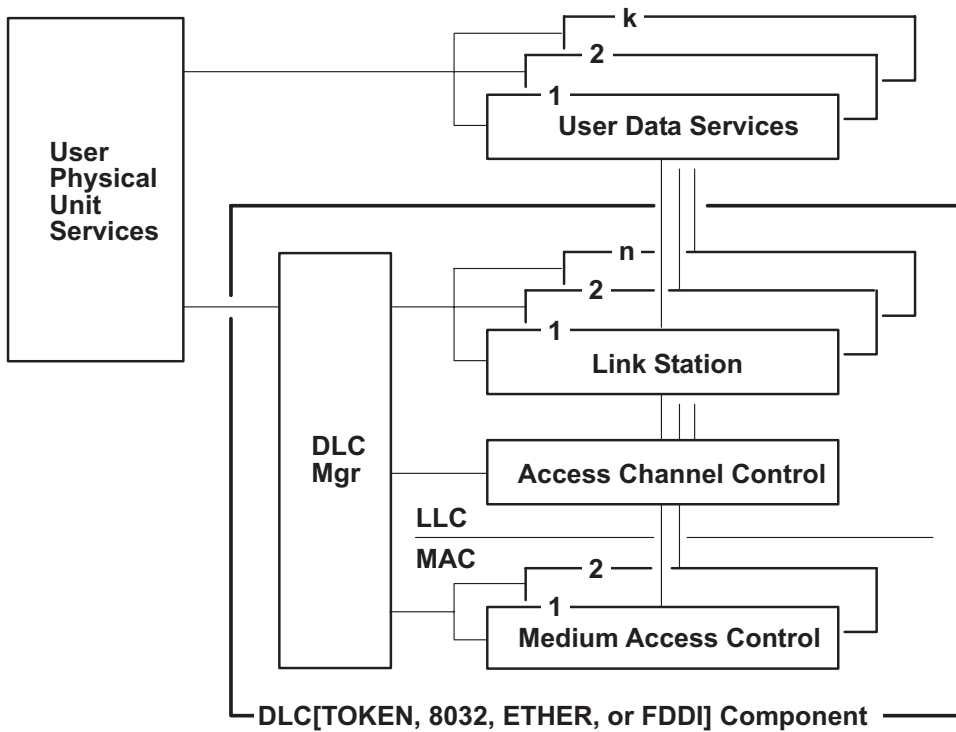

DLC[Token, 8032, Ether, or FDDI] Component Structure

Figure 4. DLC[Token, 8032, Ether, or FDDI] Component Structure. This diagram shows the component structure of the following four DLC device managers: DLCTOKEN, DLC8032, DLCETHER, and DLC FDDI. Each device manager has the same component structure with one exception: the DLC Component is named for the device manager it illustrates. The diagram has two parts: the components outside the DCL[Token, 8032, Ether, or FDDI] Component, and the components inside of it. Outside, the User Physical Unit Services connects to the DLC Manager on the inside and to the User Data Services on the outside. The diagram shows multiple (numbered from one to k) User Data Services, with the first connecting to the last. Each User Data Service connects to a corresponding Link Station, which connects to the DLC Manager. The diagram shows multiple (numbered from one to n) Link Stations, with the first connecting to the last. Each Link Station connects to a single Access Channel Control, which connects to the DLC Manager. The connection for Access Channel Control crosses the line from LLC to MAC to connect with two Medium Access Controls. The two Medium Access Controls connect with each other, then with the DLC Manager.

Each LS controls the transfer of data on a single logical link. The access channel performs multiplexing and demultiplexing for message units flowing from each LS and manager to the MAC. The DLC manager performs the following actions:

- Establishes and stops connections
- Creates and deletes an LS
- Routes commands to the proper station

DLCTOKEN Device Manager Functions

The token-ring data link control (DLCTOKEN) device manager and transport medium-use two-functional layers, medium access control (MAC) and logical link control (LLC), to maintain reliable link-level connections, guarantee data integrity, and negotiate exchanges of identification. Both connectionless (Type 1) and connection-oriented (Type 2) services are supported.

The token-ring adapter and the DLCTOKEN device handler perform the following MAC functions:

- Handling ring-insertion protocol
- Handling token detection and creation
- Encoding and decoding the serial bit-stream data
- Checking received network, group, and functional addresses

- Routing of received frames based on the LLC or MAC indicator and using the destination service access point (SAP) address if an LLC frame was received
- Generating cyclic redundancy checks (CRC)
- Handling frame delimiters, such as start or end delimiters and frame status fields.
- Handling fail-safe time outs.

DLCTOKEN performs additional MAC functions, such as:

- Framing control fields on transmit frames
- Network-addressing on transmit frames
- Routing information on transmit frames.

DLCTOKEN is also responsible for all LLC functions:

- Handling remote connection services and bridge routing, using the address-resolve and name-discovery procedures
- Sequencing of link stations on a given port
- Generating SAP addresses on transmit frames
- Generating IEEE 802.2 LLC commands and responses on transmit frames
- Recognizing and routing of received frames to the proper SAP
- Servicing IEEE 802.2 LLC commands and responses on receive frames
- Handling frame sequencing and retries
- Handling fail-safe and inactivity time outs
- Handling reliability/availability/serviceability (RAS) counters, error logs, and link traces.

DLCTOKEN Protocol Support

The token-ring data link control (DLCTOKEN) supports the logical link control (LLC) protocol and state tables described in the *Token-Ring Network Architecture Reference*, which also contains the local area network (LAN) IEEE 802.2 LCC standard. Both address-resolve services and name-discovery services are supported for establishing remote connections. DLCTOKEN supports a direct network interface to allow a user to transmit and receive unnumbered information packets directly through DLCTOKEN without the data link layer performing any protocol handling.

Station Types

A combined station is supported for a balanced (peer-to-peer) configuration on a logical point-to-point connection. That allows either station to initiate asynchronously the transmission of commands at any response opportunity. The sender in each combined station controls the receiver in the other station. Data transmissions then flow as primary commands, and acknowledgments and status flow as secondary responses.

Response Modes

Both asynchronous disconnect mode (ADM) and asynchronous balanced mode extended (ABME) are supported. ADM is entered by default whenever a link session is initiated, and is switched to ABME only after the set asynchronous balanced mode extended (SABME) command sequence is complete. Once operating in ABME, information frames containing user data can be transferred. ABME then remains active until the LLC session terminates, which occurs because of a disconnect (DISC) command packet sequence or a major link error.

Token-Ring Data Packet

All communication between a local and remote station is accomplished by the transmission of a packet that contains token-ring headers and trailers as well as an encapsulated LLC Link Protocol Data Unit (LPDU). The DLCTOKEN Frame Encapsulation figure (Figure 5 on page 16) illustrates the token-ring data

packet.

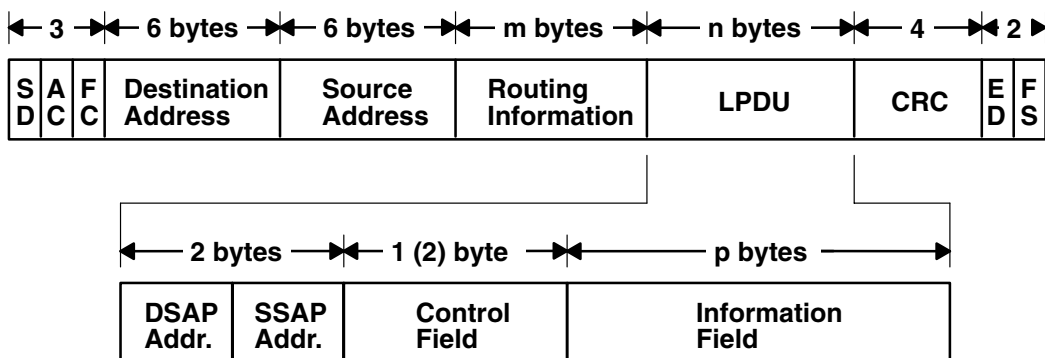

DLCTOKEN Frame Encapsulation

Figure 5. DLCTOKEN Frame Encapsulation. This diagram shows the DLCTOKEN data packet containing the following: SD, AC, and FC (together with SD and AC consist of 3 bytes), destination address (6 bytes), and source address (6 bytes), routing information (m bytes), LPDU length (n bytes), CRC (4 bytes), ED and FS (together with ED consist of 2 bytes). A second line shows that LPDU consists of the following: DSAP address, SSAP address (together with DSAP address consist of 2 bytes), control field [1 (2) byte], and the information field (p bytes).

The token-ring data packet consists of the following fields:

SD	Starting delimiter
AC	Access control field
FC	Frame control field
LPDU	LLC Link Protocol Data Unit
DSAP	Destination service access point (SAP) address field
SSAP	Source SAP address field
CRC	Cyclic redundancy check or frame-check sequence
ED	Ending delimiter
FS	Frame status field
m bytes	Integer value greater than or equal to 0 and less than or equal to 18
n bytes	Integer value greater than or equal to 3 and less than or equal to 4064
p bytes	Integer value greater than or equal to 0 and less than or equal to 4060

Note: SD, CRC, ED, and FS headers are added and deleted by the hardware adapter.

DLCTOKEN Name-Discovery Service

In addition to the standard IEEE 802.2 Common Logical Link Protocol support and address resolution services, token-ring data link control (DLCTOKEN) also provides a name-discovery service that allows the operator to identify local and remote stations by name instead of by 6-byte physical addresses. Each port must have a unique name of up to 20 characters on the network. The character set used varies depending on the user's protocol. Systems Network Architecture (SNA), for example, requires character set A. Additionally, each new service access point (SAP) supported on a particular port can have a unique name if desired.

Each name is added to the network by broadcasting a find (local name) request when the new name is being introduced to a given network port. If no response other than an echo results from the find (local name) request after it is sent the specified number of times, the physical link is declared opened. The name is then assigned to the local port and SAP. If another port on the network has already added the name, a name-found response is sent to the station that issued the find request. A result code (**DLC_NAME_IN_USE**) indicates that the new attachment was unsuccessful and a different name must be chosen. Calls are established by broadcasting a find (remote name) request to the network and waiting for

a response from the port with the specified name. Only ports that have listen attachments pending, receive colliding find requests, or are already attached to the requesting remote station answer a find request.

LAN Find Data Format

Find Header

- 0-1** Byte length of the find packet including the length field
- 2-3** Key 0x0001
- 4-n** Remaining control vectors

Target Name

- 0-1** Vector length = 0x000F to 0x0022
- 2-3** Key 0x0004
- 4-9** Name structure architecture ID:
 - 4-5** Subvector length = 0x0006
 - 6-7** Key 0x4011
 - 8-9** Identifier = 0x8000 (locally administered)
- 10-m** Object name:
 - 10-11** Subvector length = 0x0005 to 0x000C
 - 12-13** Key 0x4010
 - 14-m** Target's name (1 to 20 bytes)

Source Name

- 0-1** Vector length = 0x000F to 0x0022
- 2-3** Key 0x000D
- 4-9** Name structure architecture ID:
 - 4-5** Subvector length = 0x0006
 - 6-7** Key 0x4011
 - 8-9** Identifier = 0x8000 (locally administered)
- 10-p** Object name:
 - 10-11** Subvector length = 0x0005 to 0x000C
 - 12-13** Key 0x4010
 - 14-p** Source's name (1 to 20 bytes)

Correlator

- 0-1** Vector length = 0x0008
- 2-3** Key 0x4003

4-7 Correlator value:

Byte 4 Bit 0

1 means this is a SAP correlator for a find (self)

Byte 4 Bit 0

0 means this is an LS correlator for a find (remote)

Source Medium Access Control (MAC) Address

0-1 Vector length = 0x000A

2-3 Key 0x4006

4-9 Source's MAC address (6 bytes)

Source SAP

0-1 Vector length = 0x0005

2-3 Key 0x4007

4 Source's SAP address

LAN Found Data Format

Found Header

0-1 Byte length of the found packet including the length field

2-3 Key 0x0002

4-n Remaining control vectors

Correlator

0-1 Vector length = 0x0008

2-3 Key 0x4003

4-7 Correlator value:

Byte 4 Bit 0

1 means this is a SAP correlator for a find (self).

Byte 4 Bit 0

0 means this is an LS correlator for a find (remote).

Source MAC Address

0-1 Vector length = 0x000A

2-3 Key 0x4006

4-9 Source's MAC address (6 bytes)

Source SAP

0-1 Vector length = 0x0005

2-3 Key 0x4007

4 Source's SAP address

Response Code

0-1	Vector length = 0x0005
2-3	Key 0x400B
4	Response code:
	B'0xxx xxxx' Positive response
	B'0000 0001' Resources available
	B'1xxx xxxx' Negative response
	B'1000 0001' Insufficient resources

Bridge Route Discovery

DLCTOKEN caches any returned bridge-routing information from a remote station for each command or datagram packet received and generates send-packet headers with the reverse route. This operation allows dynamic alteration of the bridge route taken throughout the link station attachment. There is also a provision to alter the cached routing field with the **DLC_ALT_RTE** ioctl operation. This ioctl operation allows the user to dynamically change the bridge route taken by link station send packets. Once the **DLC_ALT_RTE** ioctl operation is issued and accepted by the link station, dynamic caching of the received route is stopped, and subsequent send packets carry the ioctl operation's routing value.

Network data packets are not associated with a link station attachment, so any bridge routing field has to come from the user sending the packet. DLCTOKEN has no involvement in the bridge routing of network data packets.

DLCTOKEN Direct Network Services

Some users wish to handle their own unnumbered information packets on the network without the aid of the data link layer within the token-ring data link control (DLCTOKEN). A direct network interface allows an entire packet to be generated and sent by a user after the user service access point (SAP) has been opened. The interface allows full control of every field in the data link header for each write call issued. Also provided is the ability to view the entire packet contents on received frames. The criteria for a direct network write are:

- The local SAP must be valid and opened.
- The data link control byte must indicate unnumbered information (0x03).

DLCTOKEN Connection Contention

Dual paths to the same nodes are detected by the token-ring device manager in one of two ways. First, when a call is in progress to a remote node that is also trying to call the local node, the incoming find (remote name) request is treated as if a local listen were outstanding. Second, when a pending local listen is acquired by a call from a remote node and the local user issues a call to the active remote node, a result code (**DLC_REMOTE_CONN**) is returned with the link station correlator of the active attachment, allowing the user to relink attachment pointers.

Initiating DLCTOKEN Link Sessions

When a link station (LS) is opened, the token-ring data link control (DLCTOKEN) is initialized at the open LS as a combined station in asynchronous disconnect mode (ADM). As a secondary or combined station, DLCTOKEN is in a receive state waiting for a command frame from the primary or combined station. The following command frames are accepted by the secondary or combined station at this time:

SABME	Set asynchronous balanced mode extended
XID	Exchange station identification
TEST	Test link
UI	Unnumbered information - datagram
DISC	Disconnect

Any other command frame is ignored. Once a SABME is received, the station is ready for normal data transfer and the following frames are also accepted:

I	Information
RR	Receive ready
RNR	Receive not ready
REJ	Reject

As a primary or combined station, DLCTOKEN can perform ADM XID, ADM TEST exchanges, send datagrams, or connect the remote to the asynchronous balanced mode extended (ABME). XID exchanges allow the primary or combined station to send out its station-specific identification to the secondary or combined station and obtain a response. Once an XID response is received, any attached information field is passed to the user for further action.

TEST exchanges allow the primary or combined station to send out a buffer of information that will be echoed by the secondary or combined station in order to test the integrity of the link.

Initiation of the normal data exchange mode, ABME, causes the primary or combined station to send an SABME to the secondary or combined station. Once sent successfully, the connection is said to be contacted and the user is notified. Information frames can now be sent and received between the linked stations.

Stopping DLCTOKEN Link Sessions

The user or the remote station can be stopped by the token-ring data link control (DLCTOKEN):

- Issue a **DLCTOKEN HALT_LS** command. This command will cause the primary or combined station to initiate a disconnect (DISC) packet sequence.
- Sending a DISC command packet as a primary or combined station.
- Receiving an inactivity timeout can stop a DLCTOKEN link session. This action is useful in detecting a loss of connection in the middle of a session.

Note: Abnormal stopping is caused by certain protocol violations or by resource outages.

DLCTOKEN Programming Interfaces

The token-ring data link control (DLCTOKEN) conforms to the generic data link control (GDLC) guidelines except where noted below. Additional structures and definitions for DLCTOKEN can be found in the `/usr/include/sys/trlxtcb.h` file.

Note: The `dlc` prefix is replaced with the `trl` prefix for DLCTOKEN.

trlclose	DLCTOKEN is fully compatible with the dlcclose GDLC interface.
trlconfig	DLCTOKEN is fully compatible with the dlcconfig GDLC interface. No initialization parameters are required.
trlmpx	DLCTOKEN is fully compatible with the dlcmpx GDLC interface.
trlopen	DLCTOKEN is fully compatible with the dlcopen GDLC interface.

- trlread** DLCTOKEN is compatible with the **dlcread** GDLC interface with the following conditions:
- The **readx** subroutines can have DLCTOKEN data link header information prefixed to the I-field being passed to the application. This is optional based on the **readx** subroutine *data link header length* extension parameter in the **gdl_io_ext** structure.
 - If this field is nonzero, DLCTOKEN copies the data link header and the I-field to user space and sets the actual length of the data link header into the length field.
 - If the field is 0, no data link header information is copied to user space. See the DLCTOKEN Frame Encapsulation figure (Figure 5 on page 16) for more details.

The following kernel **receive packet** function handlers always have the DLCTOKEN data link header information within the communications memory buffer (mbuf) and can locate it by subtracting the length passed (in the **gdl_io_ext** structure) from the data offset field of the mbuf structure.

- trlselect** DLCTOKEN is fully compatible with the **dlcselect** GDLC interface.
- trlwrite** DLCTOKEN is compatible with the **dlcwrite** GDLC interface, with the exception that network data can only be written as an unnumbered information (UI) packet and must have the complete data link header prefixed to the data. DLCTOKEN verifies that the local (source) service access point (SAP) is enabled and that the control byte is UI (0x03). See the DLCTOKEN Frame Encapsulation figure (Figure 5 on page 16) for more details.
- trlioctl** DLCTOKEN is compatible with the **dlciocctl** GDLC interface, with conditions on the following operations:
- **DLC_ENABLE_SAP**
 - **DLC_START_LS**
 - **DLC_ALTER**
 - **DLC_QUERY_SAP**
 - **DLC_QUERY_LS**
 - **DLC_ENTER_SHOLD**
 - **DLC_EXIT_SHOLD**
 - **DLC_ADD_GROUP**
 - **DLC_ADD_FUNC_ADDR**
 - **DLC_DEL_FUNC_ADDR**
 - **DLC_DEL_GRP**
 - **IOCINFO**

The following sections describe these conditions in detail.

DLC_ENABLE_SAP

The **ioctl** subroutine argument structure for enabling a SAP (**dlc_esap_arg**) has the following specifics:

- The **grp_addr** (group address) field for the token ring contains the four least significant bytes of the desired six-byte group address. Only bits 1 through 31 are valid. Bit 0 is ignored. The most significant two bytes are automatically compared for 0xC000 by the adapter.
- The **func_addr_mask** (functional address mask) field must be the logical OR operation with the functional address on the adapter, which allows packets that are destined for specified functions to be received by the local adapter. Only bits 1 through 29 are valid. Bits 0, 30, and 31 are ignored. The most significant two bytes of the full six-byte functional address are automatically compared for 0xC000 by the adapter.

The following is an example of a Network Basic Input/Output System (NetBIOS) functional address:

To select the NETBIOS functional address of 0xC000_0000_0080, the functional address mask is set to 0x0000_0080.

Note: DLCTOKEN does not check to determine whether a received packet was accepted by the adapter due to a preset network address, group address, or functional address.

- The `max_ls` (maximum link stations) field cannot exceed a value of 255.
- The following common SAP flags are not supported:

ENCD Specifies a synchronous data link control (SDLC) serial encoding.
NTWK Indicates a teleprocessing network type.
LINK Indicates a teleprocessing link type.
PHYC Indicates a physical network call (teleprocessing).
ANSW Indicates a teleprocessing autocall and autoanswer.

- Group SAPs are not supported, so the `num_grp_saps` (number of group SAPs) field must be set to 0.
- The `laddr_name` (local address and name) field and its associated length are only used for name discovery when the common SAP flag **ADDR** is set to 0. When resolve procedures are used (that is, the **ADDR** flag is set to 1), DLCTOKEN obtains the local network address from the device handler and not from the `dlc_esap_arg` structure.
- The `local_sap` (local service access point) field can be set to any value except null SAP (0x00) or discovery SAP (0xFC). Also, the low-order bit must be set to 0 (B`nnnnnn0') to indicate an individual address.
- No protocol-specific data area is required for DLCTOKEN to enable a SAP.

DLC_START_LS

The `ioctl` subroutine argument structure for starting a link station (`dlc_sls_arg`) has the following specifics:

- The following common link station (LS) flags are not supported:

STAT Specifies a station type for SDLC.
NEGO Specifies a negotiable station type for SDLC.

- The `raddr_name` (remote address and name) field is only used for outgoing calls when the **DLC_SLS_LSVC** common LS flag is active.
- The `maxif` (maximum I-field length) field can be set to any value greater than 0. See the DLCTOKEN Frame Encapsulation figure (Figure 5 on page 16) for more details. DLCTOKEN adjusts this value to a maximum of 4060 bytes if set too large.
- The `rcv_wind` (receive window) field can be set to any value between 1 and 127 inclusive. The recommended value is 127.
- The `xmit_wind` (transmit window) field can be set to any value between 1 and 127 inclusive. The recommended value is 26.
- The `rsap` (remote SAP) field can be set to any value except null SAP (0x00) or name-discovery SAP (0xFC). Also, the low-order bit must be set to 0 (B`nnnnnn0') to indicate an individual address.
- The `max_repoll` field can be set to any value from 1 to 255. The recommended value is 8.
- The `repoll_time` field is defined in increments of 0.5 seconds and can be set to any value from 1 to 255, inclusive. The recommended value is 2, giving a time-out duration of 1 to 1.5 seconds.
- The `ack_time` (acknowledgment time) field is defined in increments of 0.5 seconds, and can be set to any value between 1 and 255, inclusive. The recommended value is 1, giving a time-out duration of 0.5 to 1 second.
- The `inact_time` (inactivity time) field is defined in increments of 1 second and can be set to any value between 1 and 255 inclusive. The recommended value is 48, giving a time-out duration of 48 to 48.5 seconds.
- The `force_time` (force halt time) field is defined in increments of 1 second and can be set to any value between 1 and 16383, inclusive. The recommended value is 120, giving a time-out duration of approximately 2 minutes.
- A protocol-specific data area must be appended to the generic *start link station* argument (`dlc_sls_arg`). This structure provides DLCTOKEN with additional protocol-specific configuration parameters:

```

    struct trl_start_psd
    {
        uchar_t    pkt_prty; /* ring access packet priority */
        uchar_t    dyna_wnd; /* dynamic window increment */
        ushort_t   reserved; /* currently not used */
    };

```

The protocol-specific parameters are as follows:

pkt_prty Specifies the ring access priority that the user wishes to reserve on transmit packets. Values of 0 to 3 are supported, where 0 is the lowest priority and 3 is the highest priority.

dyna_wnd Specifies the number of consecutive sequenced packets that must be acknowledged by the remote station before the local transmit window count can be incremented. Network congestion causes the local transmit window count to drop automatically to a value of 1. The dynamic window increment allows a gradual increase in network traffic after a period of congestion. This field can be set to any value between 1 and 255, inclusive. The recommended value is 1.

DLC ALTER

The `ioctl` subroutine argument structure for altering an LS (`dlc_alter_arg`) has the following specifics:

- The following alter flags are not supported:

SM1, SM2 Sets SDLC control mode.

- A protocol-specific data area must be appended to the generic *alter link station* argument structure (`dlc_alter_arg`). This structure provides DLCTOKEN with additional protocol-specific alter parameters.

```

#define TRL_ALTER_PRTY 0x80000000 /* alter packet priority */
#define TRL_ALTER_DYNA 0x40000000 /* alter dynamic window incr.*/
    struct trl_start_psd
    {
        ulong_t    flags; /* specific alter flags */
        uchar_t    pkt_prty; /* ring access packet priority value */
        uchar_t    dyna_wnd; /* dynamic window increment value */
        ushort_t   reserved; /* currently not used */
    };

#define TRL_ALTER_PRTY 0x80000000 /* alter packet priority */
#define TRL_ALTER_DYNA 0x40000000 /* alter dynamic window incr.*/
    struct trl_start_psd
    {
        __ulong32_t flags; /* specific alter flags */
        uchar_t    pkt_prty; /* ring access packet priority value */
        uchar_t    dyna_wnd; /* dynamic window increment value */
        ushort_t   reserved; /* currently not used */
    };

```

Specific alter flags are as follows:

TRL_ALTER_PRTY Specifies alter priority. If this flag is set to 1, the `pkt_prty` value field replaces the current priority value being used by the LS. The LS must be started for this alter command to be valid.

TRL_ALTER_DYNA Specifies alter dynamic window. If this flag is set to 1, the `dyna_wnd` value field replaces the current dynamic window value being used by the LS. The LS must be started for this alter command to be valid.

The protocol-specific parameters are as follows:

pkt_prty Specifies the new priority reservation value for transmit packets.

dyna_wnd Specifies the new dynamic window value to control network congestion.

DLC_QUERY_SAP

The device driver-dependent data returned from DLCTOKEN for this ioctl operation is the `tok_ndd_stats_t` structure defined in the `/usr/include/sys/cdli_tokuser.h` file.

DLC_QUERY_LS

There is no protocol-specific data area supported by DLCTOKEN for this ioctl operation.

DLC_ENTER_SHOLD

The `enter_short_hold` option is not supported by DLCTOKEN.

DLC_EXIT_SHOLD

The `exit_short_hold` option is not supported by DLCTOKEN.

DLC_ADD_GROUP

The `add_group`, or multicast address, option is supported by the DLCTOKEN device manager. This ioctl operation is a four-byte value as described in the `DLC_ENABLE_SAP` ioctl operation definition.

DLC_ADD_FUNC_ADDR

The `len_func_addr_mask` (functional address mask length) field must be set to 4, and the `func_addr_mask` (functional address mask) field must be the logical OR operation with the functional address on the adapter. Only bits 1 through 29 are valid. Bits 0, 30, and 31 are ignored. The most significant two bytes of the full six-byte functional address are automatically compared for 0xC000 by the adapter and cannot be added.

DLC_DEL_FUNC_ADDR

The `len_func_addr_mask` (functional address mask length) field must be set to 4, and the `func_addr_mask` (functional address mask) field must have each bit that you wish to reset set to 1 within the functional address on the adapter. Only bits 1 through 29 are valid. Bits 0, 30, and 31 are ignored. The most significant two bytes of the full six-byte functional address are automatically compared for 0xC000 by the adapter and cannot be deleted.

DLC_DEL_GRP

The delete group or multicast option is supported by the DLCTOKEN device manager. The address being removed must match an address that was added with a `DLC_ENABLE_SAP` or `DLC_ADD_GRP` ioctl operation.

IOCINFO

The `ioctype` variable returned is defined as a `DD_DLC` definition, and the subtype returned is `DS_DLCTOKEN`.

IEEE 802.3 Ethernet Data Link Control Overview

IEEE 802.3 Ethernet data link control (DLC8023) is a device manager that follows the generic data link control (GDLC) interface definition. This DLC device manager provides a passthrough capability that allows transparent data flow and provides an access procedure to transfer four types of data over an Ethernet local area network (LAN):

- Datagrams
- Sequenced data
- Identification data
- Logical link controls.

The Ethernet device handler and the Ethernet high performance LAN adapter transfer data.

For more information about DLC8023, see:

- “DLC8023 Device Manager Nodes”
- “DLC8023 Device Manager Functions”
- “DLC8023 Protocol Support” on page 26
- “DLC8023 Name-Discovery Services” on page 27
- “DLC8023 Direct Network Services” on page 30
- “DLC8023 Connection Contention” on page 30
- “DLC8023 Link Sessions” on page 30
- “DLC8023 Programming Interfaces” on page 31

DLC8023 Device Manager Nodes

The DLC8023 device manager on an Ethernet local area network (LAN) operates between two or more nodes using medium access control (MAC) procedures and IEEE 802.2 logical link control (LLC) procedures. MAC and LLC procedures are defined in the IEEE Project 802 Local Area Network Standards. Specific state tables used are found in the *Token-Ring Network Architecture Reference*. The DLC8023 device manager supports:

- Asynchronous disconnected mode (ADM) and asynchronous balanced mode extended (ABME)
- Two-way, simultaneous (full-duplex) data flow
- Multiple point-to-point logical attachments on the LAN, using the network address and service access point (SAP) address
- Peer-to-peer relationship with remote stations
- Both name-discovery and address-resolve services.

The DLC8023 device manager provides full-duplex, peer-data transfer capabilities over an Ethernet LAN. The Ethernet LAN must use the IEEE 802.3 carrier sense multiple access with collision detection (CSMA/CD) medium access control protocol and a superset of the IEEE 802.2 LLC protocol.

Note: Multiple adapters are supported with a maximum of 255 logical attachments per adapter.

LLC refers to the DLC manager, access-channel, and link station (LS) subcomponents of a GDLC component, such as the DLC8023 device manager, as illustrated in the DLC[TOKEN, 8032, ETHER, or FDDI] Component Structure figure (Figure 4 on page 14).

Each LS controls the transfer of data on a single logical link. The access channel performs multiplexing and demultiplexing for message units flowing from the link stations and DLC manager to MAC. The DLC manager performs the following actions:

- Establishes and terminates connections
- Creates and deletes LSs
- Routes commands to the proper station.

DLC8023 Device Manager Functions

The IEEE 802.3 Ethernet data link control (DLC8023) device manager and transport medium use two functional layers, medium access control (MAC) and logical link control (LLC), to maintain reliable link-level connections, guarantee data integrity, and negotiate exchanges of identification. Both connectionless (Type 1) and connection-oriented (Type 2) services are supported.

The Ethernet adapter and DLC8023 device handler can perform the following MAC functions:

- Managing the carrier-sense multiple access with collision detection (CSMA/CD) LLC algorithm

- Encoding and decoding the serial-bit stream data
- Receiving network-address checking
- Routing received frames based on the LLC Link Protocol Data Unit (LPDU) destination service access point (SAP) field
- Generating preamble
- Generating cyclic redundancy checks (CRC)
- Handling fail-safe time outs

The DLC8023 device manager can also perform the following LLC functions:

- Remote connection services
- Sequencing each link station on a given port
- Creating the network addresses on transmit frames
- Creating service access points addresses on transmit frames
- Creating IEEE 802.2 LLC commands and responses on transmit frames
- Recognizing and routing received frames to the proper SAP
- Servicing IEEE 802.2 LLC commands and responses on receive frames
- Handling frame sequencing and retries
- Handling fail-safe and inactivity time outs
- Handling reliability counters, availability counters, serviceability counters, error logs, and link traces

DLC8023 Protocol Support

IEEE 802.3 Ethernet data link control (DLC8023) supports the system network architecture (SNA) logical link control (LLC) protocol and state tables as described in the *Token-Ring Network Architecture Reference*, which contains the local area network (LAN) IEEE 802.2 LLC standard. Additional name-discovery services have been added for establishing remote connections.

Station Types

A combined station supports a balanced (peer-to-peer) configuration on a logical point-to-point connection and allows either station to initiate asynchronously the transmission of commands at any response opportunity. The data source in each combined station controls the data sink in the other station. Data transmissions flow as primary commands; acknowledgments and status flow as secondary responses.

Response Modes

Both asynchronous disconnect mode (ADM) and asynchronous balanced mode extended (ABME) are supported. ADM is the default whenever a link session is initiated and is switched to ABME only after the set asynchronous balanced mode extended (SABME) command sequence is complete. Once operating in the ABME command mode, information frames containing user data can be transferred. The ABME command mode then remains active until the LLC session terminates, which occurs due to either the disconnect (DISC) command packet sequence or a major link error.

IEEE 802.3 Data Packet

All communication between a local and a remote station is accomplished by the transmission of a packet that contains the IEEE 802.3 headers and trailers as well as an encapsulated LLC link protocol data unit (LPDU).

The DLC8023 Frame Encapsulation figure (Figure 6 on page 27) illustrates the DLC8023 data packet:

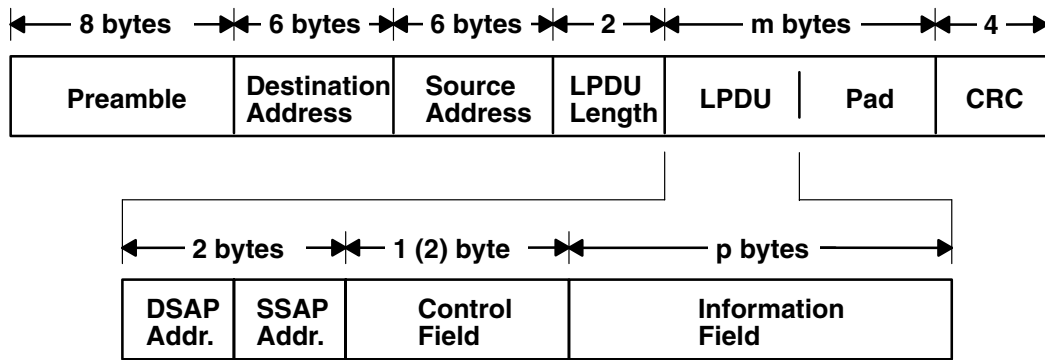

DLC8023 Frame Encapsulation

Figure 6. A Block. This diagram shows the DLC8023 data packet containing the following: preamble (8 bytes), destination address (6 bytes), source address (6 bytes), LPDU length (2 bytes), LPDU, Pad (together with LPDU consist of m bytes), and CRC (4 bytes). A second line shows that LPDU consists of the following: DSAP address, SSAP address (together with DSAP address consist of 2 bytes), control field [1 (2) byte], and the information field (p bytes).

The IEEE 802.3 data packet consists of the following fields:

LPDU	LLC Link Protocol Data Unit
DSAP	Destination Service Access Point (SAP) address field
SSAP	Source SAP Address Field
CRC	Cyclic Redundancy Check or frame1-check sequence
m bytes	Integer value greater than or equal to 46 and less than or equal to 1500
p bytes	Integer value greater than or equal to 0 and less than or equal to 1496

Note: Preamble and CRC are added and deleted by the hardware adapter.

DLC8023 Name-Discovery Services

In addition to the standard IEEE 802.2 common logical link protocol (CLLP) support and the address resolution services, IEEE 802.3 Ethernet data link control (DLC8023) also provides a name-discovery service that allows the operator to identify local and remote stations by name instead of by six-byte physical addresses. Each port must have a unique name of up to 20 characters on the network. The character set used depends on the user's protocol. For example, systems network architecture (SNA) requires character set A. Each new service access point (SAP) supported on a particular port may have a unique name, if desired.

Each name is added to the network by broadcasting a find (local name) request. After the find (local name) request is sent the required number of times, if no response is returned, the physical link is declared opened. The name is then assigned to the local port and SAP. If another port on the network has already added the name, a name-found response is sent to the station that issued the find request, and the new attachment fails with a result code (**DLC_NAME_IN_USE**). This code indicates that a different name must be selected. Calls are established by broadcasting a find (remote name) request to the network and waiting for a response from the port with the specified name. Ports with attachments pending, colliding find requests, or an attachment to the requesting remote station will answer a find request.

LAN Find Data Format

Find Header

- 0-1 Byte length of the find packet including the length field
- 2-3 Key 0x0001

4-n Remaining control vectors

Target Name

- 0-1 Vector length = 0x000F to 0x0022
- 2-3 Key 0x0004
- 4-9 Name structure architecture ID:
 - 4-5 Subvector length = 0x0006
 - 6-7 Key 0x4011
 - 8-9 Identifier = 0x8000 (locally administered)
 - 10-m Object name:
 - 10-11 Subvector length = 0x0005 to 0x000C
 - 12-13 Key 0x4010
 - 14-m Target name (1 to 20 bytes)

Source Name

- 0-1 Vector length = 0x000F to 0x0022
- 2-3 Key 0x000D
- 4-9 Name structure architecture ID:
 - 4-5 Subvector length = 0x0006
 - 6-7 Key 0x4011
 - 8-9 Identifier = 0x8000 (locally administered)
 - 10-p Object name:
 - 10-11 Subvector length = 0x0005 to 0x000C
 - 12-13 Key 0x4010
 - 14-p Source name (1 to 20 bytes)

Correlator

- 0-1 Vector length = 0x0008
- 2-3 Key 0x4003
- 4-7 Correlator value:
 - Byte 4 Bit 0**
 - 1 represents a SAP correlator for a find (self)
 - Byte 4 Bit 0**
 - 0 represents a link station (LS) correlator for a find (remote)

Source Medium Access Control (MAC) Address

- 0-1 Vector length = 0x000A
- 2-3 Key 0x4006
- 4-9 Source MAC address (6 bytes)

Source SAP

- 0-1 Vector length = 0x0005
- 2-3 Key 0x4007
- 4 Source SAP address

LAN Found Data Format

Found Header

- 0-1 Byte length of the found packet including the length field
- 2-3 Key 0x0002
- 4-n Remaining control vectors

Correlator

- 0-1 Vector length = 0x0008
- 2-3 Key 0x4003
- 4-7 Correlator value:

Byte 4 Bit 0

1 represents a SAP correlator for a find (self)

Byte 4 Bit 0

0 represents an LS correlator for a find (remote)

Source MAC Address

- 0-1 Vector length = 0x000A
- 2-3 Key 0x4006
- 4-9 Source MAC address (6 bytes)

Source SAP

- 0-1 Vector length = 0x0005
- 2-3 Key 0x4007
- 4 Source SAP address

Response Code

- 0-1 Vector length = 0x0005
- 2-3 Key 0x400B
- 4 Response code:

B'0xxx xxxx'

Positive response

B'0000 0001'

Resources available

B'1xxx xxxx'

Negative response

B'1000 0001'

Insufficient resources

DLC8023 Direct Network Services

Some users wish to handle their own unnumbered information packets on the network without the aid of the data link layer within IEEE 802.3 Ethernet data link control (DLC8023). Once a service access point (SAP) is opened, a direct network interface allows an entire packet to be generated and sent. This action allows full control of every field in the data link header for each write issued. Also provided is the ability to view the entire packet contents on received frames. The criteria for a direct network write are:

- The local SAP must be valid and open.
- The data link control byte must indicate unnumbered information (0x03).

DLC8023 Connection Contention

Dual paths to the same nodes are detected by the IEEE 802.3 Ethernet data link control (DLC8023) device manager in one of two ways. First, when a call in progress to a remote node also tries to call the local node, the incoming find (remote name) request is treated as if a local listen were outstanding. Second, when a pending local listen is acquired by a call from a remote node and the local user issues a call to the active remote node, a result code (**DLC_REMOTE_CONN**) is returned with the link station correlator of the active attachment, allowing the user to relink attachment pointers.

DLC8023 Link Sessions

The IEEE 802.3 Ethernet data link control (DLC8023) device manager is initialized at an open link station (LS) as a combined station in asynchronous disconnect mode (ADM). As a secondary or combined station, DLC8023 is in a receive state, waiting for a command frame from the primary or combined station. Command frames accepted by the secondary or combined station at this time are:

SABME	Set asynchronous balanced mode extended.
XID	Exchange station identifications.
TEST	Test links.
UI	Unnumbered information - datagram.
DISC	Disconnect.

Any other command frame is ignored. Once a SABME command is received, the station is ready for normal data transfer, and the following frames are also accepted:

I	Provides information.
RR	Indicates a receive ready.
RNR	Indicates a receive not ready.
REJ	Indicates a reject.

As a primary or combined station, the DLC8023 device manager can perform ADM XID or ADM TEST exchanges, send datagrams, or connect the remote to asynchronous balanced mode extended (ABME).

XID exchanges allow the primary or combined station to send out its station-specific identification to the secondary or combined station and accept a response. Once an XID response is received, attached information fields are then sent to the user for further action.

TEST exchanges allow the primary or combined station to send out a buffer of information to be echoed by the secondary or combined station. This transfer of information tests the integrity of the link.

Initiation of the normal data exchange mode, ABME, prompts the primary or combined station to send a SABME command to the secondary or combined station. Upon successful delivery, the connection is said to be contacted; the user is notified. Information frames can now be sent and received between the linked stations.

Link Session Termination

The IEEE 802.3 Ethernet data link control (DLC8023) device manager is stopped by the user or by the remote station in the following ways:

- The user issues a **close link station** command to the DLC8023 device manager. The command initiates a disconnect (DISC) packet sequence to the primary or combined station.
- The user directs the link to stop automatically after a specified period of inactivity. This is useful in detecting a loss of connection in the middle of a session.
- The remote station terminates the link by sending a DISC command packet as a primary combined station.

Note: Abnormal termination is a result of certain protocol violations or resource outages.

DLC8023 Programming Interfaces

The IEEE 802.3 Ethernet data link control (DLC8023) device manager conforms to generic data link control (GDLC) guidelines, except as follows:

Note: The **dlc** prefix is replaced with the **e3l** prefix for the DLC8023 device manager.

e3lclose	DLC8023 is fully compatible with the dlcclose GDLC interface.
e3lconfig	DLC8023 is fully compatible with the dlconfig GDLC interface. No initialization parameters are required.
e3lmpx	DLC8023 is fully compatible with the dlcmpx GDLC interface.
e3lopen	DLC8023 is fully compatible with the dlcopen GDLC interface.
e3lread	DLC8023 is compatible with the dlcread GDLC interface, under the following conditions: <ul style="list-style-type: none">• The readx subroutines can have DLC8023 data link header information prefixed to the I-field. The data can be passed to the application in the user-defined readx subroutine <i>data link header length</i> extension parameter in the gdl_io_ext structure.• If this field has a nonzero value, DLC8023 copies the data link header and the I-field to user space and sets the actual length of the data link header in the length field.• If the field has a value of 0, no data link header information is copied. See the DLC8023 Frame Encapsulation figure (Figure 6 on page 27) for more details.

The following kernel **receive packet** function handlers always have the DLC8023 data link header information in the communications memory buffer (mbuf), and can locate this information by subtracting the length passed in the **gdl_io_ext** structure from the data offset field.

e3lselect	DLC8023 is fully compatible with the dlcselect GDLC interface.
e3lwrite	DLC8023 is compatible with the dlcwrite GDLC interface. The exceptions are that network data can only be written as an unnumbered information (UI) packet and must have the complete data link header prefixed. DLC8023 verifies that the local, or source, service access point (SAP) is enabled and that the control byte is UI (0x03). See the DLC8023 Frame Encapsulation figure (Figure 6 on page 27) for more details.

e3lioctl DLC8023 is compatible with the **dlcioctl** GDLC interface, with conditions on the following operations:

- **DLC_ENABLE_SAP**
- **DLC_START_LS**
- **DLC_ALTER**
- **DLC_QUERY_SAP**
- **DLC_QUERY_LS**
- **DLC_ENTER_SHOLD**
- **DLC_EXIT_SHOLD**
- **DLC_ADD_GROUP**
- **DLC_ADD_FUNC_ADDR**
- **DLC_DEL_FUNC_ADDR**
- **DLC_DEL_GRP**
- **IOCINFO**

The following sections describe these conditions.

DLC_ENABLE_SAP

The **ioctl** subroutine argument structure to enable a SAP (**dlc_esap_arg**) has the following specifics:

- The **grp_addr** field is a 6-byte value as specified in the draft IEEE Standard 802.3 specifications. Octet **grp_addr[0]** specifies the most significant byte and octet **grp_addr[5]** specifies the least significant byte. Each octet of the address field is transmitted, least significant bit first. Group addresses sometimes are called multicast addresses.

An example of a group address follows:

```
0x0900_2B00_0004
```

Note: The DLC8023 device manager does not check whether a received packet was accepted by the adapter due to a preset network address or group address.

- The **max_ls** (maximum link station) field cannot exceed a value of 255.
- The following common SAP flags are not supported:

ENCD	Indicates synchronous data link control (SDLC) serial encoding.
NTWK	Indicates a teleprocessing network type.
LINK	Indicates teleprocessing link type.
PHYC	Indicates a physical network call (teleprocessing).
ANSW	Indicates a teleprocessing autocall and autoanswer.

- Group SAPs are not supported. Therefore the **num_grp_saps** (number of group SAPs) field must be set to 0.
- The **laddr_name** (local address name) field and its associated length are used for name-discovery when the common SAP flag **ADDR** is set to 0. When resolve procedures are used (that is, the **ADDR** flag is set to 1), the DLC8023 device manager obtains the local network address from the device handler and not from the **dlc_esap_arg** structure.
- The **local_sap** (local service access point) field can be set to any value except null SAP (0x00) or the name-discovery SAP (0xFC). Also, the low-order bit must be set to 0 (B'nnnnnn0') to indicate an individual address.
- No protocol-specific data area is required for the DLC8023 device manager to enable a SAP.

DLC_START_LS

The **ioctl** subroutine argument structure specifics to start a link station (**dlc_sls_arg**) are as follows:

- These common link station flags are not supported:

STAT Indicates a station type for an SDLC.
NEGO Indicates a negotiable station type for an SDLC.

- The `raddr_name` (remote address and name) field is used for outgoing calls when the **DLC_SLS_LSVC** common link station flag is active.
- The `maxif` (maximum information field length) field can be set to any value greater than 0. See the DLC8023 Frame Encapsulation figure (Figure 6 on page 27) for the supported byte lengths. If a byte is set too large, DLC8023 adjusts it to a maximum of 1496 bytes.
- The `rcv_wind` (receive window) field can be set to any value between 1 and 127 inclusive. The recommended value is 127.
- The `xmit_wind` (transmit window) field can be set to any value between 1 and 127 inclusive. The recommended value is 26.
- The `rsap` (remote SAP) field can be set to any value except null SAP (0x00) or the name-discovery SAP (0xFC). The low-order bit must be set to 0 (B'nnnnnnn0') to indicate an individual address.
- The `max_repoll` field can be set to any value between 1 and 255 inclusive. The recommended value is 8.
- The `repoll_time` field is defined in increments of 0.5 seconds and can be set to any value between 1 and 255, inclusive. The recommended value is 2, giving a time-out duration of 1 to 1.5 seconds.
- The `ack_time` (acknowledgment time) field is defined in increments of 0.5 seconds and can be set to any value between 1 and 255, inclusive. The recommended value is 1, giving a time-out duration of 0.5 to 1 second.
- The `inact_time` (inactivity time) field is defined in increments of 1 second and can be set to any value between 1 and 255, inclusive. The recommended value is 48, giving a time-out duration of 48 to 48.5 seconds.
- The `force_time` (force halt time) field is defined in increments of 1 second and can be set to any value between 1 and 16383, inclusive. The recommended value is 120, giving a time-out duration of approximately 2 minutes.
- No protocol-specific data area is required for the DLC8023 device manager to start a link station.

DLC_ALTER

The **ioctl** subroutine argument structure for altering a link station (**dlc_alter_arg**) has the following specifics:

- These alter flags are not supported:

RTE Alter routing.
SM1, SM2 Set SDLC control mode.

- A protocol-specific data area is not required for DLC8023 to alter a link station.

DLC_QUERY_SAP

The device driver-dependent data returned from DLC8023 for this **ioctl** operation is the **ent_ndd_stats_t** structure defined in the `/usr/include/sys/cdli_entuser.h` file.

DLC_QUERY_LS

No protocol-specific data area is supported by DLC8023 for this **ioctl** operation.

DLC_ENTER_SHOLD

The **enter_short_hold** option is not supported by the DLC8023 device manager.

DLC_EXIT_SHOULD

The `exit_short_hold` option is not supported by the DLC8023 device manager.

DLC_ADD_GROUP

The `add_group`, or multicast address, option is supported by the DLC8023 device manager. It is a six-byte value as described previously in the `DLC_ENABLE_SAP` (group address) `ioctl` operation.

DLC_ADD_FUNC_ADDR

The `add_functional_address` option is not supported by DLC8023.

DLC_DEL_FUNC_ADDR

The `delete_functional_address` option is not supported by DLC8023.

DLC_DEL_GRP

The delete group or multicast option is supported by the DLC8023 device manager. The address being removed must match an address that was added with a `DLC_ENABLE_SAP` or `DLC_ADD_GRP` `ioctl` operation.

IOCINFO

The returned `ioctype` variable is defined as a `DD_DLC` definition, and the subtype returned is `DS_DLC8023`.

Standard Ethernet Data Link Control Overview

Standard Ethernet data link control (DLCETHER) is a device manager that follows the generic data link control (GDLC) interface definition. This DLC device manager provides a passthrough capability that allows transparent data flow and provides an access procedure to transfer four types of data over a Standard Ethernet:

- Datagrams
- Sequenced data
- Identification data
- Logical link controls

The Ethernet device handler and Ethernet high performance LAN adapter transfer the data.

For more information about DLCETHER see the following:

- “DLCETHER Device Manager Nodes” on page 35
- “DLCETHER Device Manager Functions” on page 35
- “DLCETHER Protocol Support” on page 36
- “DLCETHER Name-Discovery Services” on page 37
- “DLCETHER Direct Network Services” on page 40
- “DLCETHER Connection Contention” on page 40
- “DLCETHER Link Session Initiation” on page 40
- “DLCETHER Link Session Termination” on page 41
- “DLCETHER Programming Interfaces” on page 41

DLCETHER Device Manager Nodes

The Standard Ethernet data link control (DLCETHER) device manager on an Ethernet local area network (LAN) operates between two or more nodes using medium access control (MAC) procedures and IEEE 802.2 logical link control (LLC) procedures, as defined in IEEE Project 802 Local Area Network Standards. The specific state tables implemented can be found in the *Token-Ring Network Architecture Reference*. The DLCETHER device manager supports:

- Asynchronous disconnected mode (ADM) and asynchronous balanced mode extended (ABME)
- Two-way simultaneous (full-duplex) data flow
- Multiple point-to-point logical attachments on the LAN using network and service access point (SAP) addresses
- Peer-to-peer relationship with remote station
- Both name-discovery and address-resolve services.

The Ethernet data link control provides full-duplex, peer data-transfer capabilities over an Ethernet Version 2 local area network, using the Ethernet Version 2 MAC protocol and a superset of the IEEE 802.2 LLC.

Note: Multiple adapters are supported with a maximum of 255 logical attachments per adapter.

LLC refers to the collection of manager, access channel, and link station subcomponents of a GDLC component such as DLCETHER device manager, as illustrated in the DLC[TOKEN, 8032, ETHER, or FDDI] Component Structure figure (Figure 4 on page 14).

Each link station (LS) controls the transfer of data on a single logical link. The access channel performs multiplexing and demultiplexing for message units flowing from the link stations and manager to the MAC. The DLC manager performs these actions:

- Establishes and terminates connections
- Creates and deletes link stations
- Routes commands to the proper station.

DLCETHER Device Manager Functions

The Standard Ethernet data link control (DLCETHER) device manager and transport medium use two functional layers, medium access control (MAC) and logical link control (LLC) to maintain reliable link-level connections, guarantee data integrity, and negotiate exchanges of identification. Both connectionless (Type 1) and connection-oriented (Type 2) services are supported.

The Ethernet adapter and the DLCETHER device handler perform the following MAC functions:

- Managing the carrier sense multiple access with collision detection (CSMA/CD) algorithm
- Encoding and decoding the serial bit stream data
- Receiving network address checking
- Routing received frames based on the LLC type field
- Generating cyclic redundancy check (CRC)
- Handling fail-safe time outs.

The DLCETHER device manager also performs the following LLC functions:

- Remote connection services
- Sequencing each link station (LS) on a given port
- Creating network addresses on transmit frames
- Creating service access point (SAP) addresses on transmit frames
- Creating IEEE 802.2 LLC commands and responses on transmit frames

- Recognizing and routing received frames to the proper SAP
 - Servicing IEEE 802.2 LLC commands and responses on receive frames
 - Sequencing frames and retries
 - Handling fail-safe and inactivity time outs
 - Handling reliability counters, availability counters, serviceability counters, error logs, and link traces.
-

DLCETHER Protocol Support

The Standard Ethernet data link control (DLCETHER) supports the systems network architecture (SNA) logical link control (LLC) protocol and state tables as described in the *Token-Ring Network Architecture Reference*, which also contains the local area network (LAN) IEEE 802.2 LLC standard. Additional direct-name services have been added for establishing remote connections.

Station Type

A combined station is supported for a balanced (peer-to-peer) configuration on a logical point-to-point connection. Either station can asynchronously initiate the transmission of commands at any response opportunity. The data source in each combined station controls the data sink in the other station. Data transmissions then flow as primary commands, and acknowledgments and status flow as secondary responses.

Response Modes

Both asynchronous disconnect mode (ADM) and asynchronous balanced mode extended (ABME) are supported. ADM is entered by default whenever a link session is initiated, and is switched to ABME only after the set asynchronous balanced mode extended (SABME) command sequence is complete. Once operating in ABME, information frames containing user data can be transferred. ABME then remains active until the LLC session ends, which occurs because of a disconnect (DISC) command sequence or a major link error.

Ethernet Data Packet

All communication between a local and remote station is accomplished by the transmission of a packet that contains the Ethernet headers and trailers and an encapsulated LLC protocol data unit (LPDU). This packet format is specifically designed for the SNA protocol, but other protocols can use this format as well.

The The DLCETHER Frame Encapsulation figure (Figure 7 on page 37) illustrates the Ethernet data packet.

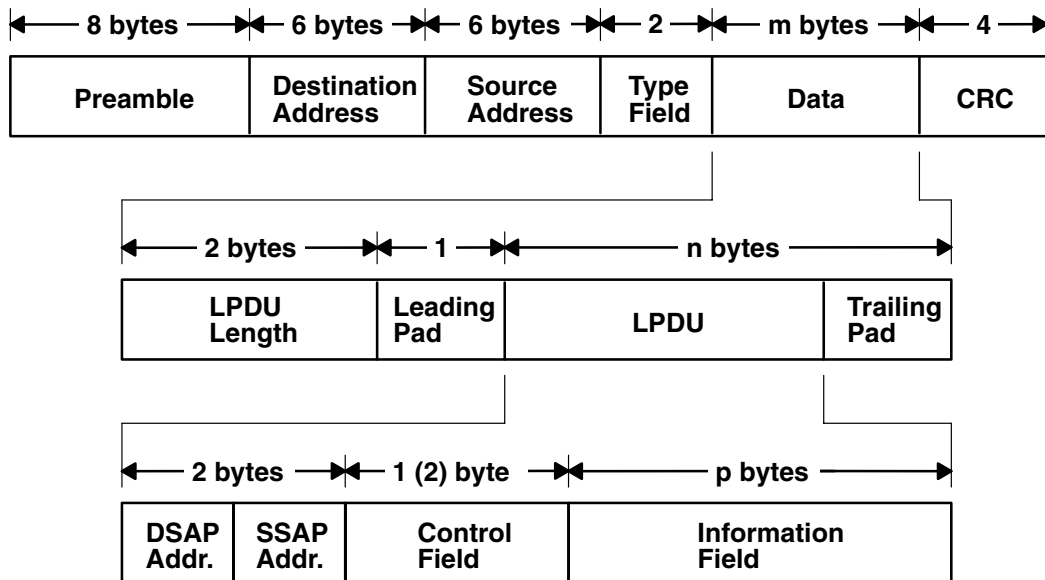

DLCETHER Frame Encapsulation

Figure 7. DLCETHER Frame Encapsulation. This diagram shows the Ethernet data packet. The first line contains the following: preamble (8 bytes), destination address (6 bytes), source address (6 bytes), and type field (2 bytes), data (m bytes), CRC (4 bytes). The second line defines data as including the following: LPDU length (2 bytes), leading pad (1 byte), LPDU, and the trailing pad (which together with the LPDU equal n bytes). The third line shows that LPDU consists of the following: DSAP address, SSAP address (together with DSAP address consist of 2 bytes), control field [1 (2) byte], and the information field (p bytes).

The Ethernet data packet consists of the following:

LPDU	LLC protocol data unit
DSAP	Destination service access point (SAP) address field
SSAP	Source SAP address field
CRC	Cyclic redundancy check or frame-check sequence
m bytes	Integer value greater than or equal to 46 and less than or equal to 1500
n bytes	Integer value greater than or equal to 43 and less than or equal to 1497
p bytes	Integer value greater than or equal to 0 and less than or equal to 1493

Note: The Preamble and CRC identify both of these as something that is added and deleted by the hardware adapter.

DLCETHER Name-Discovery Services

In addition to the standard IEEE 802.2 Common Logical Link Protocol support and address resolution services, Standard Ethernet data link control (DLCETHER) also provides a name-discovery service that allows the operator to identify local and remote stations by name instead of by six-byte physical addresses. Each port must have a unique name on the network of up to 20 characters. The character set used varies depending on the user's protocol. Systems network architecture (SNA), for example, requires character set A. Additionally, each new service access point (SAP) supported on a particular port can have a unique name if desired.

Each name is added to the network by broadcasting a find *local_name* request when the new name is being introduced to a given network port. If no response other than an echo results from the request, the physical link is declared opened, and the name is assigned to the local port and SAP. If another port on the network has already added the name, a "name found" response is returned. The

DLC_NAME_IN_USE result code indicates that the new attachment was unsuccessful and that a different

name must be chosen. Calls are established by broadcasting a find *remote_name* request to the network and waiting for a response from the port with the specified name. The only respondents to a find request are those ports that have listen attachments pending, receive colliding find requests, or are already attached to the requesting remote station.

LAN Find Data Format

Find Header

- 0-1 Byte length of the find packet including the length field
- 2-3 Key 0x0001
- 4-n Remaining control vectors

Target Name

- 0-1 Vector length = 0x000F to 0x0022
- 2-3 Key 0x0004
- 4-9 Name structure architecture ID:
 - 4-5 Subvector length = 0x0006
 - 6-7 Key 0x4011
 - 8-9 Identifier = 0x8000 (locally administered)
 - 10-m Object name:
 - 10-11 Subvector length = 0x0005 to 0x000C
 - 12-13 Key 0x4010
 - 14-m Target name (1 to 20 bytes)

Source Name

- 0-1 Vector length = 0x000F to 0x0022
- 2-3 Key 0x000D
- 4-9 Name structure architecture ID:
 - 4-5 Subvector length = 0x0006
 - 6-7 Key 0x4011
 - 8-9 Identifier = 0x8000 (locally administered)
 - 10-p Object name:
 - 10-11 Subvector length = 0x0005 to 0x000C
 - 12-13 Key 0x4010
 - 14-p Source name (1 to 20 bytes)

Correlator

- 0-1 Vector length = 0x0008
- 2-3 Key 0x4003

4-7 Correlator value:

Byte 4 Bit 0

1 represents a SAP correlator for a find (self)

Byte 4 Bit 0

0 represents a link station (LS) correlator for a find (remote)

Source Medium Access Control (MAC) Address

0-1 Vector length = 0x000A

2-3 Key 0x4006

4-9 Source MAC address (6 bytes).

Source SAP

0-1 Vector length = 0x0005

2-3 Key 0x4007

4 Source SAP address

LAN Found Data Format

Found Header

0-1 Byte length of the found packet including the length field

2-3 Key 0x0002

4-n Remaining control vectors

Correlator

0-1 Vector length = 0x0008

2-3 Key 0x4003

4-7 Correlator value:

Byte 4 Bit 0

1 represents a SAP correlator for a find (self)

Byte 4 Bit 0

0 represents an LS correlator for a find (remote)

Source MAC Address

0-1 Vector length = 0x000A

2-3 Key 0x4006

4-9 Source MAC address (6 bytes)

Source SAP

0-1 Vector length = 0x0005

2-3 Key 0x4007

4 Source SAP address

Response Code

0-1	Vector length = 0x0005
2-3	Key 0x400B
4	Response code:
	B'0xxx xxxx' Positive response
	B'0000 0001' Resources available
	B'1xxx xxxx' Negative response
	B'1000 0001' Insufficient resources

DLCETHER Direct Network Services

Some users wish to handle their own unnumbered information packets on the network without the aid of the data link layer within the Standard Ethernet Data Link Control (DLCETHER). This decision results in protocol constraints from their individual service access points (SAPs). A direct network interface is provided that allows an entire packet to be generated and sent by a user after the user SAP has been opened. This provision allows full control of every field in the data link header for each write issued. Also provided is the ability to view the entire packet contents on received frames.

The criteria for a direct network write require that:

- The local SAP must be valid and open.
- The data link control byte must indicate unnumbered information (0x03).

DLCETHER Connection Contention

Dual paths to the same nodes are detected by the Standard Ethernet Data Link Control (DLCETHER) device manager in one of two ways. First, if a call is in progress to a remote node that is also trying to call the local node, the incoming find (remote name) request is treated as if a local listen were outstanding. Second, if a pending local listen has been acquired by a remote node call and the local user issues a call to that remote node after the link session is already active, a result code (**DLC_REMOTE_CONN**) is returned to the user along with the link station correlator of the attachment already active. This allows the user to relink attachment pointers.

DLCETHER Link Session Initiation

Standard Ethernet data link control (DLCETHER) is initialized at the open link station as a combined station in asynchronous disconnect mode (ADM). As a secondary or combined station, DLCETHER is in a receive state waiting for a command frame from the primary or combined station. The following command frames are accepted by the secondary or combined station at this time:

SABME	Set asynchronous balanced mode extended
XID	Exchange station identification
TEST	Test link
UI	Unnumbered information - datagram
DISC	Disconnect

Any other command frame is ignored. Once a SABME command frame is received, the station is ready for normal data transfer, and the following frames are also accepted:

I	Information
RR	Receive ready
RNR	Receive not ready
REJ	Reject

As a primary or combined station, DLCETHER can perform ADM_XID, ADM_TEST exchanges, send datagrams, or connect the remote into the asynchronous balanced mode extended (ABME) command frame. XID exchanges allow the primary or combined station to send out its station-specific identification to the secondary or combined station and obtain a response. Once an XID response is received, any attached information field is passed to the user for further action.

The TEST exchanges allow the primary or combined station to send out a buffer of information that is echoed by the secondary or combined station to test the integrity of the link.

Initiation of the normal data exchange mode, ABME, causes the primary or combined station to send a SABME command frame to the secondary or combined station. Once sent successfully, the connection is said to be contacted, and the user is notified. I-frames can now be sent and received between the linked stations.

DLCETHER Link Session Termination

The Standard Ethernet data link control (DLCETHER) device manager can be terminated by the user or by the remote station in the following ways:

- Issuing a **DLC_HALT_LS** command operation to the DLCETHER device manager will cause the primary/combined station to initiate a disconnect (DISC) command packet sequence.
- Receiving an inactivity time out can terminate a DLCETHER link session. This action is useful in detecting a loss of connection in the middle of a session.
- Sending a DISC command packet as a primary combined station will terminate a DLCETHER link session.

Note: Abnormal termination is caused by certain protocol violations or by resource outages.

DLCETHER Programming Interfaces

The Standard Ethernet data link control (DLCETHER) conforms to the generic data link control (GDLC) guidelines except as follows:

Note: The **dlc** prefix is replaced with the **edl** prefix for the DLCETHER device manager.

edlclose	DLCETHER is fully compatible with the dlcclose GDLC interface.
edlconfig	DLCETHER is fully compatible with the dlconfig GDLC interface. No initialization parameters are required.
edlmpx	DLCETHER is fully compatible with the dlcmpx GDLC interface.
edlopen	DLCETHER is fully compatible with the dlcopen GDLC interface.
edlread	DLCETHER is compatible with the dlcread GDLC interface with the following conditions: <ul style="list-style-type: none"> • The readx subroutines can have DLCETHER data link header information prefixed to the I-field being passed to the application. This is optional based on the readx subroutine <i>data link header length</i> extension parameter in the gdl_io_ext structure. • If this field is nonzero, DLCETHER copies the data link header and the I-field to user space and sets the actual length of the data link header into the length field. • If the field is 0, no data link header information is copied to user space. See the DLCETHER Frame Encapsulation figure (Figure 7 on page 37) for more details.

The following kernel **receive packet** subroutines always have the DLCETHER data link header information within the communications memory buffer (mbuf) and can locate it by subtracting the length passed (in the **gdl_io_ext** structure) from the data offset field of the mbuf structure.

edlselect	DLCETHER is fully compatible with the dlcselect GDLC interface.
edlwrite	DLCETHER is compatible with the dlcwrite GDLC interface with the exception that network data can only be written as an unnumbered information (UI) packet and must have the complete data link header prefixed to the data. DLCETHER verifies that the local (source) service access point (SAP) is enabled and that the control byte is UI (0x03). See the DLCETHER Frame Encapsulation figure (Figure 7 on page 37).
edlioctl	DLCETHER is compatible with the dlcioctl GDLC interface with conditions on these operations (described in the following sections): <ul style="list-style-type: none"> • “DLC_ENABLE_SAP” • “DLC_START_LS” on page 43 • “DLC_ALTER” on page 43 • “DLC_QUERY_SAP” on page 43 • “DLC_QUERY_LS” on page 43 • “DLC_ENTER_SHOLD” on page 44 • “DLC_EXIT_SHOLD” on page 44 • “DLC_ADD_GRP” on page 44 • “DLC_ADD_FUNC_ADDR” on page 44 • “DLC_DEL_FUNC_ADDR” on page 44 • “DLC_DEL_GRP” on page 44 • “IOCINFO” on page 44

DLC_ENABLE_SAP

The **ioctl** subroutine argument structure for enabling a SAP (**dlc_esap_arg**) has the following specifics:

- The **grp_addr** field is a 6-byte value as specified in the draft IEEE Standard 802.3 specifications. Octet **grp_addr[0]** specifies the most significant byte and octet **grp_addr[5]** specifies the least significant byte. Each octet of the address field is transmitted, least significant bit first. Group addresses sometimes are called multicast addresses. An example of a group address follows:

```
0x0900_2B00_0004
```

Note: No checks are made by the DLCETHER device manager as to whether a received packet was accepted by the adapter due to a preset network address or group address.

- The **max_ls** (maximum link station) field cannot exceed a value of 255.
- The following common SAP flags are not supported:

ENCD Indicates a synchronous data link control (SDLC) serial encoding.

NTWK Indicates a teleprocessing network type.

LINK Indicates a teleprocessing link type.

PHYC Indicates a physical network call (teleprocessing).

ANSW Indicates a teleprocessing autocall and autoanswer.

- Group SAPs are not supported, so the **num_grp_saps** (number of group SAPs) field must be set to 0.
- The **laddr_name** (local address and name) field and its associated length are only used for name discovery when the common SAP flag **ADDR** field is set to 0. When resolve procedures are used (that is, the **ADDR** flag is set to 1), DLCETHER obtains the local network address from the device handler and not from the **dlc_esap_arg** structure.
- The **local_sap** (local service access point) field can be set to any value except the null SAP (0x00) or the name-discovery SAP (0xFC). Also, the low-order bit must be set to 0 (B`nnnnnnn0') to indicate an individual address.

- No protocol-specific data area is required for the DLCETHER device manager to enable a SAP.

DLC_START_LS

The `ioctl` subroutine argument structure for starting a link station (`dlc_sls_arg`) has the following specifics:

- These common link station flags are not supported:

STAT Indicates a station type for SDLC.

NEGO Indicates a negotiable station type for SDLC.

- The `raddr_name` (remote address or name) field is used only for outgoing calls when the **DLC_SLS_LSVC** common link station flag is active.
- The `maxif` (maximum I-field) length can be set to any value greater than 0. See the DLCETHER Frame Encapsulation figure (Figure 7 on page 37) for supported byte lengths. The DLCETHER device manager adjusts this value to a maximum of 1493 bytes if set too large.
- The `rcv_wind` (receive window) field can be set to any value between 1 and 127, inclusive. The recommended value is 127.
- The `xmit_wind` (transmit window) field can be set to any value between 1 and 127, inclusive. The recommended value is 26.
- The `rsap` (remote SAP) field can be set to any value except null SAP (0x00) or the name-discovery SAP (0xFC). Also, the low-order bit must be set to 0 (B`nnnnnn0') to indicate an individual address.
- The `max_repoll` field can be set to any value between 1 and 255, inclusive. The recommended value is 8.
- The `repoll_time` field is defined in increments of 0.5 seconds and can be set to any value between 1 and 255, inclusive. The recommended value is 2, giving a time-out duration of 1 to 1.5 seconds.
- The `ack_time` (acknowledgment time) field is defined in increments of 0.5 seconds and can be set to any value between 1 and 255, inclusive. The recommended value is 1, giving a time-out duration of 0.5 to 1 second.
- The `inact_time` (inactivity time) field is defined in increments of 1 second, and can be set to any value between 1 and 255, inclusive. The recommended value is 48, giving a time-out duration of 48 to 48.5 seconds.
- The `force_time` (force halt time) field is defined in increments of 1 second, and can be set to any value between 1 and 16383, inclusive. The recommended value is 120, giving a time-out duration of approximately 2 minutes.
- No protocol-specific data area is required for the DLCETHER device manager to start a link station.

DLC_ALTER

The `ioctl` subroutine argument structure for altering a link station (`dlc_alter_arg`) has the following specifics:

- These alter flags are not supported:

RTE Alters routing.

SM1, SM2 Sets synchronous data link control (SDLC) control mode.

- No protocol-specific data area is required for the DLCETHER device manager to alter a link station.

DLC_QUERY_SAP

The device driver-dependent data returned from DLCETHER for this `ioctl` operation is the `ent_ndd_stats_t` structure defined in the `/usr/include/sys/cdli_entuser.h` file.

DLC_QUERY_LS

No protocol-specific data area is supported by DLCETHER for this `ioctl` operation.

DLC_ENTER_SHOLD

The `enter_short_hold` option is not supported by the DLCETHER device manager.

DLC_EXIT_SHOLD

The `exit_short_hold` option is not supported by the DLCETHER device manager.

DLC_ADD_GRP

The `add_group` or multicast address option is supported by the DLCETHER device manager as a six-byte value as described above in `DLC_ENABLE_SAP` (group address) `ioctl` operation.

DLC_ADD_FUNC_ADDR

The `add_functional_address` option is not supported by DLCETHER.

DLC_DEL_FUNC_ADDR

The `delete_functional_address` option is not supported by DLCETHER.

DLC_DEL_GRP

The delete group or multicast option is supported by the DLCETHER device manager. The address being removed must match an address that was added with a `DLC_ENABLE_SAP` or `DLC_ADD_GRP` `ioctl` operation.

IOCINFO

The `ioctl` variable returned is defined as `DD_DLC` definition and the subtype returned is `DS_DLCETHER`.

Synchronous Data Link Control Overview

Synchronous data link control (DLCSDL) is one of the generic data link controls. It provides an access procedure for transparent and code-independent information interchange across teleprocessing and data networks, as defined in the *SDLC Concepts* document.

The list of architecture supported by DLCSDL includes:

- Normal disconnected mode (NDM) and normal response mode (NRM)
- Two-way alternate (half-duplex) data flow
- Secondary station point-to-point, multipoint, and multi-multipoint configurations
- Primary station point-to-point and multipoint configurations
- Modulo 8 transmit-and-receive sequence counts
- Nonextended (single-byte) station address.

For more information about DLCSDL controls, see:

- “DLCSDL Device Manager Functions” on page 45
- “DLCSDL Protocol Support” on page 45
- “DLCSDL Programming Interfaces” on page 48
- “DLCSDL Asynchronous Function Subroutine Calls” on page 51

DLCSDLC Device Manager Functions

Synchronous data link control (SDLC) is split between a physical adapter with its associated device handler and a data link control (DLC) component. The synchronous data link control (DLCSDLC) device manager is responsible for functions that include:

- Sequencing information frames
- Creating address and control for transmit frames
- Servicing control for receive frames
- Handling repoll and inactivity time outs
- Generating frame-rejects
- Handling transmit windows
- Handling reliability counters, availability counters, serviceability counters, error logs, and link traces.

The device handler and adapter are jointly responsible for the remaining SDLC functions:

- Recognizing station addresses
- Encoding and decoding non-return-to-zero (inverted) recording (NRZI) and non-return-to-zero (NRZ)
- Inserting and deleting 0 bits
- Generating and checking frame-check sequences
- Generating and checking flags and pads
- Filling interframe time
- Handling line-attachment protocols, such as RS-232C, X.21, and Smartmodem
- Handling fail-safe time outs
- Handling autoresponse for nonproductive supervisory command frames.

DLCSDLC Protocol Support

The synchronous data link control (SDLC) device manager (DLCSDLC) supports SDLC protocol and state tables.

Station Types

DLCSDLC supports two station types:

- Primary stations responsible for control of data interchange on the link
- Secondary, or subordinate, stations on the link

Operation Modes

DLCSDLC supports two modes of operation:

- Single-physical unit (PU) mode
- Multiple-PU mode

Single-PU mode allows a single open per port. In this mode, only one **DLC_ENABLE_SAP** ioctl operation is allowed per port. All additional **DLC_ENABLE_SAP** ioctl operations are rejected with an **errno** value of **EINVAL**. In addition, only one file descriptor can be used to issue read, write, and ioctl operations. When multiple applications wish to use the same port, only one application can obtain the file descriptor, making it difficult to share the port.

SDLC multiple-PU secondary support allows multiple secondary stations (up to 254) to occupy a single physical port, and operate concurrently by multiplexing on the single-byte link-station address field found in each receive packet. Multiple-PU support also allows multiple applications to issue opens and **DLC_ENABLE_SAP** and **DLC_START_LS** ioctl operations on the same physical port, independent of other applications on that port.

For migration purposes, multiple-PU support is activated only if the first open per port to the `/dev/dlcsdli` file is extended with the `dlc_open_ext` structure and the `maxsaps` (maximum service access points) field is set to a value between 2 and 127, inclusive. This type of open operation allows DLCS DLC to switch from the original single-PU operation to multiple-PU operation. Only secondary link stations are allowed to be started in multiple-PU mode.

One channel owns the service access point (SAP) on a single port since a single network configuration is supported for each port. However, subsequent `DCL_ENABLE_SAP` ioctl operations issued when the port is already activated fail with an `errno` value of `EBUSY` instead of `EINVAL`. The current SAP correlator value (`gdlc_sap_corr`) is returned on these `EBUSY` conditions, enabling subsequent commands to be issued to DLCS DLC, even though a different user process may own the SAP.

Any address between 0x01 and 0xFE may be specified as the local secondary link station address. Secondary station address 0x00 is not valid. Station address 0xFF is reserved for broadcast communication. Any packets received with address 0xFF are passed to a single active link station for subsequent response on a port. Any additional active link stations on that port do not receive the packet.

Transmission Frames

All communication between the local and remote stations is accomplished by the transmission of frames. The SDLC frame format consists of:

Unique flag sequence (B'01111110')	1 byte
Station link address field	1 byte
Control field	1 byte
Information field	<i>n</i> bytes
Frame check sequence	2 bytes
Unique flag sequence (B'01111110')	1 byte

Three kinds of SDLC frames exist: information, supervisory, and unnumbered. Information frames transport sequenced user data between the local and remote stations. Supervisory frames carry control parameters relative to the sequenced data transfer. Unnumbered frames transport the controls relative to nonsequenced transfers.

Response Modes

Both normal disconnect mode (NDM) and normal response mode (NRM) are supported. NDM is entered by default whenever a session is initiated, and is switched to NRM only after completion of the set normal response mode/unnumbered acknowledge (SNRM/UA) command sequence. Once operating in NRM, information frames containing user data can be transferred. NRM then remains active until termination of the SDLC session, which occurs due to the disconnect/unnumbered acknowledge (DISC/UA) command sequence or a major link error. Once termination is complete, SDLC activity halts, and the NDM/NRM modes are not re-entered until another session is initiated.

Station Link Address Field

The supported station link address field is nonextended and consists of either the all-stations (broadcast) address or a single unique 8-bit value other than the all-zeros (null) address. The secondary station's address can be any value from 1 through 254. Address value 255 (broadcast) is only used by the primary station for initial contact of a point-to-point secondary station type, where the secondary's address is unknown. Once contact has been made, the secondary station's returned address is used exclusively for the remainder of the session.

Control Field (Commands Supported)

All commands are generated by the primary station for the secondary station. Each command carries the poll indicator to request immediate response, except when sending multiple information frames.

Information frames that are concatenated have the poll indicator turned on in the last frame of the burst. The commands supported are:

Information	Sends sequenced user data from the primary station to the secondary station, and acknowledges any received information frames.
Receive Ready	Indicates that receive storage is available and acknowledges any received information frames. This receive ready command is a supervisory command.
Receive Not Ready	Indicates receive storage is not available and acknowledges any received information frames. The receive not ready command is a supervisory command.
Disconnect	Requests the logical and physical disconnection of the link. The disconnect command is an unnumbered command.
Set Normal Response Mode	Requests entry into normal response mode and resets the information sequence counts. The setnormal response mode command is an unnumbered command.
Test	Solicits an echoed TEST response from the secondary station and can carry an optional information field. The test command is an unnumbered command.
Exchange Station Identification	Solicits an exchange identification (XID) response that contains either the station identification of the secondary station or link negotiation information that allows the alteration of the primary or secondary relationship by the user. The exchange station identification command is an unnumbered command.

Control Field (Responses Supported)

All responses are generated by the secondary station for the primary station. Each response carries the final indicator to specify send completion, except when sending multiple information frames. Information frames that are concatenated have the final indicator on in the last frame of the burst. The responses supported are:

Information	Sends sequenced user data from the secondary station to the primary station. It also acknowledges any received information frames.
Receive Ready	Indicates receive storage is available and acknowledges any received information frames. The receive ready response is a supervisory response.
Receive Not Ready	Indicates receive storage is not available and acknowledges any received information frames. The receive not ready response is a supervisory response.
Frame Reject	Indicates that the secondary station detects a problem in a command frame that otherwise had a valid frame check sequence in normal response mode. The frame reject response is an unnumbered response. The types of frame reject supported are: 0x01 Incorrect or nonimplemented command received. 0x03 Incorrect information field attached to command received. 0x04 I-field exceeded buffer capacity (this value is not supported by DLCSDL). Each overflowed receive buffer is passed to the user with an indication of overflow. 0x08 Number received (NR) sequence count is out of range.
Disconnected Mode	Indicates that the secondary station is in normal disconnect mode. The disconnected mode response is an unnumbered response.
Unnumbered Acknowledge	Acknowledges receipt of the set normal response mode or disconnect commands that were sent by the primary station. The unnumbered acknowledge response is an unnumbered response.

Test	Echoes the TEST command frame sent by the primary station, and carries the information field received only if sufficient storage is available. The test response is an unnumbered response.
Exchange Station Identification	Contains the station identification of the secondary station. The exchange station identification response is an unnumbered response.

DLCSDLC Programming Interfaces

The synchronous data link control (SDLC) device manager (DLCSDLC) conforms to the generic data link control (GDLC) guidelines except where noted in the following list. Additional structures and definitions for DLCSDLC can be found in the `/usr/include/sys/sdlextc.h` file.

Note: The GDLC entry-point prefix **dlc** is replaced with the **sdl** prefix to denote DLCSDLC device manager operation.

sdclose	DLCSDLC is fully compatible with the dlcclose GDLC interface.
sdconfig	DLCSDLC is fully compatible with the dlcconfig GDLC interface. No initialization parameters are required.
sdlmpx	DLCSDLC is fully compatible with the dlcmpx GDLC interface.
sdlopen	DLCSDLC is fully compatible with the dlcopen GDLC interface with the following conditions: <ul style="list-style-type: none"> • Single-physical unit (PU) mode allows only one open per port. The open can come from either an application or kernel user, but multiple users cannot share the same port. Single-PU mode is entered by issuing the open without an extension, or by issuing an extended open with the maxsaps (maximum service access points) field set to a value of 0 or 1. Single-PU mode is the default. • Multiple-PU mode allows multiple processes to open a secondary port. Multiple-PU mode is entered by issuing an extended open with the maxsaps field set to a value greater than 1.
sdhread	<p>Note: Only one user process is allowed to open a primary port.</p> <p>DLCSDLC is compatible with the dlcread GDLC interface, with the following conditions:</p> <ul style="list-style-type: none"> • Network data is defined as any data received from data communication equipment (DCE) that is not specific to the SDLC session protocol. Examples are X.21 call-progress signals or Smartmodem call-establishment messages. This data must be interpreted differently, depending on the physical attachment in use. • Datagram receive data is not supported.
sdselect	DLCSDLC is fully compatible with the dlcselect GDLC interface.
sdlwrite	DLCSDLC is compatible with the dlcwrite GDLC interface, with the exception that network data and datagram data are not supported in the send direction. Network data such as X.21 or Smartmodem call-establishment data is sent using the DLC_ENABLE_SAP ioctl operation.
sdlioctl	<p>DLCSDLC is compatible with the dlcioctl GDLC interface, with conditions on the following operations:</p> <ul style="list-style-type: none"> • “DLC_ENABLE_SAP” on page 49 • “DLC_START_LS” on page 49 • “DLC_ALTER” on page 51 • “DLC_QUERY_SAP” on page 51 • “DLC_QUERY_LS” on page 51 • “DLC_ENTER_SHOLD” on page 51 • “DLC_EXIT_SHOLD” on page 51 • “DLC_ADD_GRP” on page 51 • “DLC_ADD_FUNC_ADDR” on page 51 • “DLC_DEL_FUNC_ADDR” on page 51 • “IOCINFO” on page 51

The following sections describe these conditions.

DLC_ENABLE_SAP

DLCSDLC supports two modes of operation:

- Single-PU mode is entered through the open to DLCSDLC. In this mode, only one **DLC_ENABLE_SAP** ioctl operation is allowed per port. All additional **DLC_ENABLE_SAP** ioctl operations are rejected with an **errno** value of **EINVAL**.
- Multiple-PU mode is also entered through the open to DLCSDLC. In this mode, up to 254 **DLC_ENABLE_SAP** ioctl operations can be issued. The first **DLC_ENABLE_SAP** ioctl operation establishes the physical connection. All subsequent **DLC_ENABLE_SAP** ioctls return an **errno** value of **EBUSY**, but pass back the `gdlc_sap_corr` value of the first successful **DLC_ENABLE_SAP** so that link stations can be started.

The **ioctl** subroutine argument structure for enabling a service access point (SAP) (**dlc_esap_arg**) has the following specifics:

- The `func_addr_mask` (function address mask) field is not supported.
- The `grp_addr` (group address) field is not supported.
- The `max_ls` (maximum link stations) field cannot exceed a value of 254 on a multidrop primary link or a multiple-PU secondary link, and cannot exceed 1 on a point-to-point link.
- The following common SAP flag is not supported:

ADDR Specifies local address or name indicator.

- The `laddr_name` (local address or name) field is not supported, so the length of the local address/name field is ignored.
- Group SAPs are not supported, so the `num_grp_saps` (number of group SAPs) and `grp_sap` (group SAP - *n*) fields are ignored.
- The `local_sap` (local service access point) field is not supported and is ignored.
- The protocol specific data area is identical to the start device structure required by the multiprotocol device handler. See the `/usr/include/sys/mpqp.h` file and the **t_start_dev** structure for more details.

DLC_START_LS

DLCSDLC supports up to 254 concurrent link stations (LSs) on a single port when it operates as a multidrop primary node or a multiple-PU secondary node. Only one LS can be started when DLCSDLC operates on a point-to-point connection, or when it is a single-PU secondary node on a multidrop connection.

- The following common link station flags are not supported:

LSVC LS virtual call is ignored.

ADDR Address indicator must be set to 1 to indicate that no name-discovery services are provided.

- The `len_raddr_name` (length of remote address or name) field must be set to 1.
- The `raddr_name` (remote address or name) field is the one-byte station address of the remote node in hexadecimal.
- The `maxif` (maximum I-field length) field can be set to any value greater than 0. DLCSDLC adjusts this value to a maximum of 4094 bytes if set too large.
- The `rcv_wind` (maximum receive window) field can be set to any value from 1 to 7. The recommended value is 7.
- The `xmit_wind` (maximum transmit window) field can be set to any value from 1 to 7. The recommended value is 7.
- The `rsap` (remote SAP) field is ignored.
- The `rsap_low` (remote SAP low range) field is ignored.
- The `rsap_high` (remote SAP high range) field is ignored.

- The `max_repoll` field can be set to any value from 1 to 255, inclusive. The recommended value is 15.
- The `repoll_time` field is defined in increments of 0.1 second and can be set to any value from 1 to 255. The recommended value is 30, giving a time-out duration of approximately 30 seconds.
- The `ack_time` (acknowledgment time) field is ignored.
- The `inact_time` (inactivity time) field is defined in increments of 1 second and can be set to any value from 1 to 255, inclusive. The recommended value is 30, giving a time-out duration of approximately 30 seconds.
- The `force_time` (force halt time) field is defined in increments of 1 second and can be set to any value from 1 to 16383, inclusive. The recommended value is 120, giving a time-out duration of approximately 2 minutes.
- The following protocol-specific data area must be appended to the generic start LS argument structure (**dlc_sls_arg**). This structure provides DLCS DLC with additional protocol-specific configuration parameters:

```

struct    sdl_start_psd
}
  uchar_t  duplex;    /*link station xmit/receive capability */
  uchar_t  secladd;   /* secondary station local address */
  uchar_t  prirpth;   /* primary repoll timeout threshold */
  uchar_t  priilto;   /* primary idle list timeout */
  uchar_t  prislto;   /* primary slow list timeout */
  uchar_t  retxct;    /* retransmit count ceiling */
  uchar_t  retxth;    /* retransmit count threshold */
  uchar_t  reserved; /* currently not used */
};

```

The protocol-specific parameters are as follows:

<i>duplex</i>	Specifies LS transmit-receive capability. This field must be set to 0, indicating two-way alternating capability.
<i>secladd</i>	Specifies the secondary station link address of the local station. If the local station is negotiable, this address is used only if the local station becomes a secondary station from role negotiation. This field overlays the <code>mpioctl (CIO_START)</code> poll address variable, <code>poll_addr</code> .
<i>prirpth</i>	Specifies primary repoll threshold. This field specifies the number of contiguous repolls that cause the local primary to log a temporary error. Any value from 1 to 100 can be specified. The recommended value is 10.
<i>priilto</i>	Specifies primary idle list time out. If the primary station has specified the <i>Hold Link on Inactivity</i> parameter and then discovers that a secondary station is not responding, the primary station places that secondary station on an <i>idle list</i> . The primary station polls a station on the idle list less frequently than the other secondary stations to avoid tying up the network with useless polls. This field sets the amount of time (in seconds) that the primary station should wait between polls to stations on the idle list. Any value from 1 to 255, inclusive, may be specified. The recommended value is 60, giving a time-out duration of approximately 60 seconds.
<i>prislto</i>	Specifies primary slow list time out. When the primary station discovers that communication with a secondary station is not productive, it places that station on a <i>slow list</i> . The primary station polls a station on the slow list less frequently than the other secondary stations to avoid tying up the network with useless polls. This field sets the amount of time (in seconds) that the primary station should wait between polls to stations on the slow list. Any value from 1 to 255, inclusive, can be specified. The recommended value is 20, giving a time-out duration of approximately 20 seconds.
<i>retxct</i>	Indicates retransmit count. This field specifies the number of contiguous information frame bursts containing the same data that the local station retransmits before it declares a permanent transmission error. Any value from 1 to 255, inclusive, can be specified. The recommended value is 10.
<i>retxth</i>	Indicates retransmit threshold. This field specifies the maximum number of information frame retransmissions allowed as a percentage of total information frame transmission (sampled only after a block of information frames has been sent). If the number of retransmissions exceeds the specified percentage, the system declares a temporary error. Any value from 1 to 100% can be specified. The recommended value is 10%.

DLC_ALTER

Specifics for the **ioctl** subroutine argument structure to alter a link station (**dlc_alter_arg**) include:

- These alter flags are not supported:

AKT Alter acknowledgment time out.

RTE Alter routing.

- The **act_time** (acknowledge time out) field is ignored.
- The routing data field is ignored.
- No protocol-specific data area is required for DLCSDLC to alter its configuration.

DLC_QUERY_SAP

No device driver-dependent data area is supported by DLCSDLC for the **query sap** **ioctl** operation.

DLC_QUERY_LS

No protocol-specific data area is supported by DLCSDLC for the **query link station** **ioctl** operation.

DLC_ENTER_SHOLD

DLCSDLC does not currently support the **enter_short_hold** option.

DLC_EXIT_SHOLD

DLCSDLC does not currently support the **exit_short_hold** option.

DLC_ADD_GRP

The **add_group** or multicast address option is not supported by DLCSDLC.

DLC_ADD_FUNC_ADDR

The **add_functional_address** option is not supported by DLCSDLC.

DLC_DEL_FUNC_ADDR

The **delete_functional_address** option is not supported by DLCSDLC.

IOCINFO

The *ioctype* variable is defined as a **DD_DLC** definition and the subtype returned is **DS_DLCSDLC**.

DLCSDLC Asynchronous Function Subroutine Calls

Datagram data received is not supported, and the synchronous data link control (SDLC) device manager (DLCSDLC) never calls the **rcvd_fa** function.

DLCSDLC is compatible with each of the other asynchronous function subroutines for the kernel user.

Qualified Logical Link Control (DLCQLLC) Overview

Qualified logical link control (QLLC) data link control (DLCQLLC) is one of the generic data link controls. It provides an access procedure to attach to X.25 packet-switching networks.

DLCQLLC fully supports the 1980 and 1984 versions of the CCITT recommendation relevant to Systems Network Architecture (SNA)-to-SNA connections. It allows point-to-point connections over an X.25 network between a pair of primary and secondary link stations.

DLCQLLC provides two-way alternate (half-duplex) data flow over switched or permanent virtual circuits.

For more information about the DLCQLLC controls, see:

- “DLCQLLC Device Manager Functions”
- “DLCQLLC Programming Interfaces”
- “DLCQLLC Asynchronous Function Subroutine Calls” on page 57

DLCQLLC supports the following X.25 optional facilities:

- Modulo 8/128 packet sequence numbering
- Closed user groups
- Recognized private operating agencies
- Network user identification
- Reverse charging
- Packet-size negotiation
- Window-size negotiation
- Throughput class negotiation

DLCQLLC Device Manager Functions

DLCQLLC, as described in the *X.25 Interface for Attaching SNA Nodes to Packet-Switch Data Networks* and *X.25 1984 Interface Architectural Reference*, is split between a physical adapter with its associated device handler and a data link control component. The DLC component is responsible for the following QLLC functions:

- Creation of address and control for transmit frames
- Service of control for receive frames
- Repoll and inactivity time outs
- Frame-reject generation
- Facility negotiation

The data link control and device handler components are jointly responsible for:

- Establishment of an X.25 virtual circuit
- Clearing of an X.25 virtual circuit
- Notification of exceptional conditions to higher levels
- Reliability/availability/serviceability (RAS) counters, error logs, and link traces

The device handler and adapter are jointly responsible for:

- Packetization of I-frames
- Packet sequencing
- Link access protocol balance (LAPB) procedures as defined by CCITT recommendation X.25
- Physical-line attachment protocols

DLCQLLC Programming Interfaces

QLLC data link control (DLCQLLC) conforms to the GDLC guidelines except where noted below.

Note: The **dlc** prefix is replaced with **qlc** prefix for DLCQLLC device manager.

qlcclose	DLCQLLC is fully compatible with the dlcclose GDLC interface.
qlccconfig	DLCQLLC is fully compatible with the dlccconfig GDLC interface. No initialization parameters are required.
qlcmpx	DLCQLLC is fully compatible with the dlcmpx GDLC interface.

qlcopen	DLCQLLC is fully compatible with the dlcopen GDLC interface.
qlcread	DLCQLLC is compatible with the dlcread GDLC interface, except that network data and datagram receive data are not supported.
qlcselect	DLCQLLC is fully compatible with the dlcselect GDLC interface.
qlcwrite	DLCQLLC is compatible with the dlcwrite GDLC interface with the exception that network data and datagram data are not supported.
qlcioctl	DLCQLLC is compatible with the dlcioctl GDLC interface with conditions on the following operations: <ul style="list-style-type: none"> • “DLC_ENABLE_SAP” • “DLC_START_LS” • “DLC_ALTER” on page 56 • “DLC_QUERY_SAP” on page 56 • “DLC_QUERY_LS” on page 56 • “DLC_ENTER_SHOLD” on page 57 • “DLC_EXIT_SHOLD” on page 57 • “DLC_ADD_GRP” on page 57 • “DLC_ADD_FUNC_ADDR” on page 57 • “DLC_DEL_FUNC_ADDR” on page 57 • “IOCINFO” on page 57

The following sections describe these conditions.

DLC_ENABLE_SAP

The **ioctl** subroutine argument structure for enabling a service access point (SAP), **dlc_esap_arg**, has the following specifics:

- The function address mask field is not supported.
- The group address field is not supported.
- The **max_ls** field cannot exceed a value of 255.
- The common SAP flags are not supported.
- Group SAPs are not supported, so the number of group SAPs and group SAP-*n* fields are ignored.
- The local SAP field is not supported and is ignored.
- The protocol-specific data area is not required.

DLC_START_LS

DLCQLLC supports up to 255 concurrent link stations (LS) on a single SAP. Each active link station becomes a virtual circuit to the X.25 device. The actual number of possible link stations may be less than 255, based on the number of virtual circuits available from the X.25 device.

The **ioctl** subroutine argument structure for starting an LS, **dlc_sls_arg**, has the following specifics:

- The following common link station flag is not supported:

ADDR The address indicator flag is ignored.

- The **raddr_name** (remote address) field is used only for outgoing calls when the **DLC_SLS_LSVC** common link station flag is active. Two formats are supported:
 - For an X.25 switched virtual circuit, the **raddr_name** field is the remote’s X.25 network user address (NUA), encoded as a string of ASCII digits.
 - For an X.25 permanent virtual circuit, the **raddr_name** field is the logical channel number, encoded as a string of ASCII digits prefaced by the lowercase letter **p** or an uppercase **P**.

Examples of valid remote addresses are:

Switched Virtual Circuit	23422560010502
Permanent Virtual Circuit	P13

- If the CCITT attribute is set to 1980 when configuring the X.25 adapter, the `rcv_window` (maximum receive window) field can be set to any value from 1 to 7. If the CCITT configuration attribute is set to 1984, the `rcv_window` field can be set to any value from 1 to 128.
- If the CCITT attribute is set to 1980 when configuring the X.25 adapter, the `xmit_wind` (maximum transmit window) field can be set to any value from 1 to 7. If the CCITT configuration attribute is set to 1984, the `xmit_wind` field can be set to any value from 1 to 128.
- The RSAP (remote SAP) field is ignored.
- The RSAP low (remote SAP low range) field is ignored.
- The RSAP high (remote SAP high range) field is ignored.
- The repoll time field is defined in increments of 1 second.
- The `ack_time` (acknowledgment time) field is ignored.
- A protocol-specific data area must be appended to the generic *start link station* argument (**`dlc_sls_arg`**).

Example of Protocol-Specific Configuration Parameters

The following is an example of a structure that provides DLCQLLC with additional protocol-specific configuration parameters:

```
struct qlc_start_psd
{
    char    listen_name[8];
    unsigned short support_level;
    struct  sna_facilities_type facilities;
};
```

The protocol-specific parameters are:

<i>listen_name</i>	The name of the entry in the X.25 routing list that specifies the characteristics of incoming calls. This field is used only when a station is listening; that is, when the LSVC flag in the <code>dlc_sls_arg</code> argument structure is 0.
<i>support_level</i>	The version of CCITT recommendation X.25 to support. It must be the same as or earlier than the CCITT attribute specified for the X.25 adapter.
<i>facilities</i>	A structure that contains the X.25 facilities required for use on the virtual circuit for the duration of this attachment (See "Facilities Structure").

Facilities Structure

The following is an example of a structure that provides DLCQLLC with facilities parameters:

```
struct sna_facilities_type
{
    unsigned    facs:1;
    unsigned    rpoa:1;
    unsigned    psiz:1;
    unsigned    wsiz:1;
    unsigned    tcls:1;
    unsigned    cug :1;
    unsigned    cugo:1;
    unsigned    res1:1;
    unsigned    res2:1;
    unsigned    nui :1;
    unsigned    :21;
    unsigned char recipient_tx_psiz;
    unsigned char originator_tx_psiz;
    unsigned char recipient_tx_wsiz;
    unsigned char originator_tx_wsiz;
    unsigned char recipient_tx_tcls;
```



```

unsigned char  originator_tx_tcls;
unsigned short reserved;
unsigned short cug_index;
unsigned short rpoa_id_count;
unsigned short rpoa_id[30];
unsigned int   nui_length;
char          nui_data[109];
};

```

In the following list of fields, bits with a value of 0 indicate False and with a value of 1 indicate True.

<i>fac</i>	Indicates whether there are any facilities being requested. If this field is set to 0, all the remaining facilities structure is ignored.
<i>rpoa</i>	Indicates whether to use a recognized private operating agency.
<i>psiz</i>	Indicates whether to use a packet size other than the default.
<i>wsiz</i>	Indicates whether to use a window size other than the default.
<i>tcls</i>	Indicates whether to use a throughput class other than the default.
<i>cug</i>	Indicates whether to supply an index to a closed user group.
<i>cugo</i>	Indicates whether to supply an index to a closed user group with outgoing access.
<i>res1</i>	Reserved.
<i>res2</i>	Reserved.
<i>nui</i>	Indicates whether network user identification (NUI) is supplied to the network.

The remaining fields provide the values or data associated with each of the above facilities bits that are set to 1. If the corresponding facilities bit is set to 0, each of these fields is ignored:

<i>recipient_tx_psiz</i>	Indicates the coded value of packet size to use when sending data to the node that initiated the call. The values are coded as follows: 0x06 = 64 octets 0x07 = 128 octets 0x08 = 256 octets 0x09 = 512 octets 0x0A = 1024 octets 0x0B = 2048 octets 0x0C = 4096 octets Note: 4096-octet packets are allowed only in the 1984 CCITT recommendation. For the call to be valid, the value of the X.25 CCITT attribute and the corresponding QLLC attribute must be set to 1984.
<i>originator_tx_psiz</i>	Indicates the coded value of packet size to use when sending data from the node that initiated the call. The values are coded as for the <i>recipient_tx_psiz</i> field. See 55.
<i>recipient_tx_wsiz</i>	Reserved for QLLC use.
<i>originator_tx_wsiz</i>	Reserved for QLLC use.

recipient_tx_tcls	Indicates the coded values of the throughput class requested for this virtual circuit when sending data to the node that initiated the call. The values are coded as follows: 0x07 = 1200 bits per second 0x08 = 2400 bits per second 0x09 = 4800 bits per second 0x0A = 9600 bits per second 0x0B = 19200 bits per second 0x0C = 48000 bits per second
originator_tx_tcls	Indicates the coded values of the throughput class requested for this virtual circuit when sending data from the node that initiated the call. The values are coded as for the recipient_tx_tcls field. See 56.
cug_index	Indicates the decimal value of the index of the closed user group (CUG) within which this call is to be placed. This field is used for either CUG or CUG with outgoing access (CUGO) facilities.
rpoa_id_count	Indicates the number of recognized private operating agency (RPOA) identifiers to supply in the rpoa_id field. See 56.
rpoa_id	Indicates an array of RPOA identifiers that contains the number of identifiers specified in the rpoa_id_count field. The RPOA identifiers appear in the order in which they will be traversed when the call is initiated. The content of each array element is the decimal value of an RPOA identifier. See 56.
nui_length	The length, in bytes, of the nui_data field. See 56.
nui_data	Network user identification (NUI) data. The contents of this array are defined by the user in conjunction with the network provider. Note that the maximum allowable X.25 facilities string is 109 bytes. Even if NUI is the only facility requested, the facility code occupies one byte, so it is impossible to send more than 108 bytes of NUI data. Each additional facility requested reduces the space available for NUI data.

DLC_ALTER

The **ioctl** subroutine argument structure for altering a link station, **dlc_alter_arg**, has the following specifics:

- The following alter flags are not supported:

AKT Alter acknowledgment time out.
RTE Alter routing.
XWIN Alter transmit window size.

- The acknowledge time out field is ignored.
- The routing data field is ignored.
- The transmit window size field is ignored.
- No protocol-specific data area is required for DLCQLLC to alter its configuration.

DLC_QUERY_SAP

The device driver dependent data returned from DLCQLLC for this **ioctl** operation is the **cio_stats_t** structure defined in the **/usr/include/sys/comio.h** file.

DLC_QUERY_LS

There is no protocol specific data area supported by DLCQLLC for the *query link station* **ioctl** operation.

DLC_ENTER_SHOLD

The `enter_short_hold` option is not supported by DLCQLLC.

DLC_EXIT_SHOLD

The `exit_short_hold` option is not supported by DLCQLLC.

DLC_ADD_GRP

The `add_group` or multicast address option is not supported by DLCQLLC.

DLC_ADD_FUNC_ADDR

The `add_functional_address` option is not supported by DLCQLLC.

DLC_DEL_FUNC_ADDR

The `delete_functional_address` option is not supported by DLCQLLC.

IOCFINFO

The *ioctype* variable is defined as a `DD_DLC` definition and the subtype is `DS_DLCQLLC`.

DLCQLLC Asynchronous Function Subroutine Calls

Network and datagram data are not supported, so the `rcvn_fa` and `rcvd_fa` data functions are never called by DLCQLLC.

DLCQLLC is compatible with each of the other asynchronous function subroutine calls for the kernel user.

Data Link Control FDDI (DLC FDDI) Overview

Fiber distributed data interface (FDDI) data link control (DLC FDDI) is a device manager that follows the generic interface definition (GDLC). This data link control (DLC) device manager provides a passthrough capability that allows transparent data flow as well as an access procedure to transfer four types of data over a FDDI network:

- Datagrams
- Sequenced data
- Identification data
- Logical link controls

The access procedure relies on functions provided by the FDDI Device Handler and the FDDI Network Bus Master adapter to transfer data with address checking, token generation, or frame check sequences.

The DLC FDDI device manager provides the following functions and services:

- “DLC FDDI Device Manager Functions” on page 58
- “DLC FDDI Protocol Support” on page 59
- “DLC FDDI Name-Discovery Services” on page 60
- “DLC FDDI Direct Network Services” on page 63
- “DLC FDDI Connection Contention” on page 63
- “DLC FDDI Link Sessions” on page 63
- “DLC FDDI Programming Interfaces” on page 64

DLC FDDI Device Manager Nodes

The DLC FDDI device manager operates between two nodes on a fiber distributed data interface (FDDI) local area network (LAN), using IEEE 802.2 logical link control (LLC) procedures and control information as defined in the *Token-Ring Network Architecture Reference* and media access control procedures as defined in the ANSI standard publication *Fiber Distributed Data Interface-Token Ring Media Access Control*. The DLC FDDI device manager supports:

- Asynchronous disconnected mode (ADM) and asynchronous balanced mode extended (ABME)
- Two-way simultaneous (full-duplex) data flow
- Multiple point-to-point logical attachments on the LAN using network and service access point (SAP) addresses
- Peer-to-peer relationship with remote station
- Full six-byte addressing
- Both name-discovery and address-resolve services
- Source-routing generation for up to 14 bridge hops
- Asynchronous transmission with eight possible priority levels.

The DLC FDDI provides full-duplex, peer-data transfer capabilities over a FDDI LAN. The FDDI LAN must use the ANSI X3.139 medium access control (MAC) procedure and a superset of the IEEE 802.2 LLC protocol as described in the *Token-Ring Network Architecture Reference*.

Multiple FDDI adapters are supported, with a maximum of 126 SAP users per adapter. A total of 255 link stations per adapter are supported, which are distributed among the active SAP users.

The term *logical link control* (LLC) is used to describe the collection of manager, access channel, and link station subcomponents of a generic data link control GDLC component such as DLC FDDI device manager, as illustrated in the DLC[TOKEN, 8032, ETHER, or FDDI] Component Structure figure (Figure 4 on page 14).

Each link station (LS) controls the transfer of data on a single logical link. The access channel performs multiplexing and demultiplexing for message units flowing from the link stations and manager to MAC. The DLC manager:

- Establishes and terminates connections
- Creates and deletes an LS
- Routes commands to the proper link station.

DLC FDDI Device Manager Functions

The data link control (DLC) fiber distributed data interface (FDDI) device manager and transport medium use two functional layers, medium access control (MAC) and logical link control (LLC), to maintain reliable link-level attachments, guarantee data integrity, negotiate exchanges of identification, and support both connection and non-connection oriented services.

The FDDI adapter and device handler are responsible for the following MAC functions:

- Handling ring-insertion protocol
- Detecting and creating tokens
- Encoding and decoding the serial bit-stream data
- Checking received network and group addresses
- Routing of received frames based on the LLC/MAC/SMT indicator and using the destination service access point (SAP) address if an LLC frame was received
- Generating frame-check sequences (FCS)

- Handling frame delimiters, such as start or end delimiters and frame-status field
- Handling fail-safe time outs
- Handling network recovery.

The FDDI Device Manager is responsible for additional MAC functions, such as:

- Framing control fields on transmit frames
- Network addressing on transmit frames
- Routing information on transmit frames
- Handling network recovery.

The FDDI Device Manager is also responsible for all LLC functions:

- Handling remote connection services using the address-resolve and name-discovery procedures
- Sequencing of link stations on a given port
- Generating SAP addresses on transmit frames
- Generating IEEE 802.2 LLC commands and responses on transmit frames
- Recognizing and routing received frames to the proper service access point
- Servicing of IEEE 802.2 LLC commands and responses on receive frames
- Handling frame sequencing and retries
- Handling fail-safe and inactivity time outs
- Handling reliability counters, availability counters, serviceability counters, error logs, and link trace.

DLC FDDI Protocol Support

The data link control (DLC) fiber distributed data interface (FDDI) device manager supports the logical link control (LLC) protocol and state tables described in the *Token-Ring Network Architecture Reference*, which also contains the local area network (LAN) IEEE 802.2 LLC standard. Both address-resolve services and name-discovery services are supported for establishing remote attachments. A direct network interface is also supported to allow users to transmit and receive unnumbered information packets through DLC FDDI without any protocol handling by the data link layer.

Station Type

A combined station is supported for a balanced (peer-to-peer) configuration on a logical point-to-point connection. This allows either station to initiate asynchronously the transmission of commands at any response opportunity. The sender in each combined station controls the receiver in the other station. Data transmissions then flow as primary commands, and acknowledgments and status flow as secondary responses.

Response Modes

Both asynchronous disconnect mode (ADM) and asynchronous balanced mode extended (ABME) are supported. ADM is entered by default whenever a link session is initiated. It switches to ABME only after the set asynchronous balanced mode extended (SABME) packet sequence is complete by way of the **DLC_CONTACT** command or a remote-initiated SABME packet. Once operating in ABME, information frames containing user data can be transferred. ABME then remains active until the LLC session ends, which occurs because of a disconnect (DISC) packet sequence or a major link error.

FDDI Data Packet

All communication between a local and remote station is accomplished by the transmission of a packet that contains FDDI headers and trailers, as well as an encapsulated LLC link protocol data unit (LPDU). The DLC FDDI Frame Encapsulation figure (Figure 8 on page 60) describes the FDDI data packet.

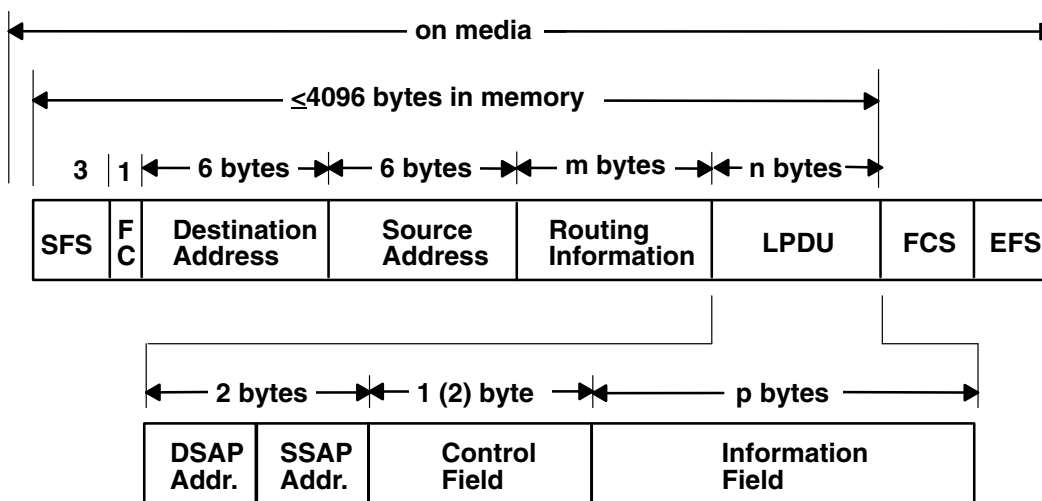

DLC FDDI Frame Encapsulation

Figure 8. DLC FDDI Frame Encapsulation. This diagram shows the FDDI data packet containing the following: SFS (3 bytes), FC (1 byte), destination address (6 bytes), and source address (6 bytes), routing information (m bytes), LPDU length (n bytes), FCS, and EFS. Another line shows that LPDU consists of the following: DSAP address, SSAP address (together with DSAP address consist of 2 bytes), control field [1 (2) byte], and the information field (p bytes).

The FDDI data packet consists of the following:

SFS	Start-of-frame sequence, including the preamble and starting delimiter
FC	Frame control field
LPDU	LLC protocol data unit
DSAP	Destination service access point (SAP) address field
SSAP	Source SAP address field
FCS	Frame-check sequence or cyclic redundancy check
EFS	End-of-frame sequence, including the ending delimiter and frame status
m bytes	Integer value greater than or equal to 0 and less than or equal to 30
n bytes	Integer value greater than or equal to 3 and less than or equal to 4080
p bytes	Integer value greater than or equal to 0 and less than or equal to 4077

Notes:

1. SFS, FCS, and EFS are added and deleted by the hardware adapter. Three bytes of alignment always precede the FC field when located in memory buffers.
2. The maximum byte length of a transfer unit has been set to 4096 bytes to align to the size of an mbuf cluster (where a transfer unit is defined as fields FC through LPDU, plus a three-byte front alignment pad).

DLC FDDI Name-Discovery Services

In addition to the standard IEEE 802.2 Common Logical Link Protocol support and address resolution services, the data link control (DLC) fiber distributed data interface (FDDI) also provides a name-discovery service that allows the operator to identify local and remote stations by name instead of by six-byte physical addresses. Each port must have a unique name on the network of up to 20 characters. The character set used varies depending on the user's protocol. Systems Network Architecture (SNA), for example, requires character set A. Additionally, each new service access point (SAP) supported on a particular port can have a unique name if desired.

Each name is added to the network by broadcasting a find (local name) request when the new name is being introduced to a given network port. If no response other than an echo results from the find (local

name) request after sending it the number of times specified, the physical link is declared opened. The name is then assigned to the local port and SAP. If another port on the network has already added the name or is in the process of adding a name, a name-found response is sent to the station that issued the find request, and the new attachment fails with a result code (**DLC_NAME_IN_USE**). The code indicates a different name must be chosen. Calls are established by broadcasting a find (remote name) request to the network and waiting for a response from the port with the specified name. Only those ports that have listen attachments pending, receive colliding find requests, or are already attached to the requesting remote station answer a find request.

LAN Find Data Format

Find Header

- 0-1** Byte length of the find packet including the length field
- 2-3** Key 0x0001
- 4-n** Remaining control vectors

Target Name

- 0-1** Vector length = 0x000F to 0x0022
- 2-3** Key 0x0004
- 4-9** Name structure architecture ID:
 - 4-5** Subvector length = 0x0006
 - 6-7** Key 0x4011
 - 8-9** Identifier = 0x8000 (locally administered)
- 10-m** Object name:
 - 10-11** Subvector length = 0x0005 to 0x000C
 - 12-13** Key 0x4010
 - 14-m** Target name (1 to 20 bytes)

Source Name

- 0-1** Vector length = 0x000F to 0x0022
- 2-3** Key 0x000D
- 4-9** Name structure architecture ID:
 - 4-5** Subvector Length = 0x0006
 - 6-7** Key 0x4011
 - 8-9** Identifier = 0x8000 (locally administered)
- 10-p** Object name:
 - 10-11** Subvector length = 0x0005 to 0x000C
 - 12-13** Key 0x4010
 - 14-p** Source name (1 to 20 bytes)

Correlator

- 0-1 Vector length = 0x0008
- 2-3 Key 0x4003
- 4-7 Correlator value:

Byte 4, bit 0

1 means this is a SAP correlator for a find (self)

Byte 4, bit 0

0 means this is an LS correlator for a find (remote)

Source Medium Access Control (MAC) Address

- 0-1 Vector length = 0x000A
- 2-3 Key 0x4006
- 4-9 Source MAC address (6 bytes)

Source SAP

- 0-1 Vector length = 0x0005
- 2-3 Key 0x4007
- 4 Source SAP address

LAN Found Data Format

Found Header

- 0-1 Byte length of the found packet including the length field
- 2-3 Key 0x0002
- 4-n Remaining control vectors

Correlator

- 0-1 Vector length = 0x0008
- 2-3 Key 0x4003
- 4-7 Correlator value:

Byte 4, bit 0

1 means this is a SAP correlator for a find (self)

Byte 4, bit 0

0 means this is a link station correlator for a find (remote)

Source MAC Address

- 0-1 Vector length = 0x000A
- 2-3 Key 0x4006
- 4-9 Source MAC address (6 bytes)

Source SAP

- 0-1 Vector length = 0x0005
- 2-3 Key 0x4007
- 4 Source SAP address

Response Code

0-1	Vector length = 0x0005
2-3	Key 0x400B
4	Response code:
	B'0xxx xxxx' Positive response
	B'0000 0001' Resources available
	B'1xxx xxxx' Negative response
	B'1000 0001' Insufficient resources

Bridge Route Discovery

DLCFDDI caches any returned bridge-routing information from a remote station for each command or datagram packet received and generates send-packet headers with the reverse route. This operation allows dynamic alteration of the bridge route taken throughout the link station attachment. There is also a provision to alter the cached routing field with the **DLC_ALT_RTE** ioctl operation. This ioctl operation allows the user to dynamically change the bridge route taken by link station send packets. Once the **DLC_ALT_RTE** ioctl operation is issued and accepted by the link station, dynamic caching of the received route is stopped, and subsequent send packets carry the ioctl operation's routing value.

Network data packets are not associated with a link station attachment, so any bridge routing field has to come from the user sending the packet. DLCFDDI has no involvement in the bridge routing of network data packets.

DLC FDDI Direct Network Services

Some users wish to handle their own unnumbered information packets on the network without the aid of the data link layer within the fiber distributed data interface (FDDI). A direct network interface allows an entire packet to be generated and sent by users once their service access point (SAP) has been opened. This allows full control of every field in the data link header for each write issued. Also provided is the ability to view the entire packet contents on received frames. The criteria for a direct network write are:

- The local SAP must be valid and opened
- The data link control byte must indicate unnumbered information (0x03).

DLC FDDI Connection Contention

Dual paths to the same nodes are detected by the data link control (DLC) fiber distributed data interface (FDDI) in one of two ways. If a call is in progress to a remote node, which is also trying to call a local node, the incoming find (remote name) request is treated as if a local listen was outstanding. If a pending local listen has been acquired by a remote node's call, and the local user issues a call to that remote node after the link station is already active, a result code (**DLC_REMOTE_CONN**) is returned to the user along with the link station correlator of the attachment already active, so that the user can relink attachment pointers.

DLC FDDI Link Sessions

A link session is initialized by issuing a **DLC_START_LS** command to the fiber distributed data interface (FDDI) device manager. This creates a combined station and sets it to asynchronous disconnect mode (ADM). As a secondary or combined station, data link control (DLC) FDDI is in receive state waiting for a command frame from the primary or combined station.

The command frames currently accepted are:

SABME	Set asynchronous balanced mode extended
XID	Exchange identification
TEST	Test link
UI	Unnumbered information or datagram
DISC	Disconnect

Any other command frame is ignored. Once a SABME is received, the contact sequence is complete and the station is ready for normal data transfer and the following frames are also accepted as valid packet types in this asynchronous balanced mode extended (ABME) mode:

I	Information
RR	Receive ready
RNR	Receive not ready
REJ	Reject

As a primary or combined station, DLC FDDI can perform ADM XID and ADM TEST exchanges, send datagrams, or connect the remote into ABME. XID exchanges allow the primary or combined station to send out its station-specific identification to the secondary or combined station and obtain a response. Once an XID response is received, any attached information field is passed to the user for further action.

TEST exchanges allow the primary or combined station to send out an information buffer that is echoed by the secondary or combined station to test the integrity of the link.

Initiation of the normal data exchange mode, ABME, causes the primary or combined station to send a SABME to the secondary or combined station. Once sent successfully, the attachment is said to be contacted and the user is notified. I-frames can now be sent and received between the linked stations.

Link Session Termination

The user or the remote station can end DLC FDDI in the following ways:

- The user can cause normal termination by issuing a **DLC_HALT_LS** command to the DLC FDDI device manager. The **DLC_HALT_LS** command causes the primary or combined station to initiate a disconnect (DISC) packet sequence.
- Receive inactivity can be optioned to cause termination. This is useful in detecting a loss of attachment in the middle of a session.
- The remote station can cause termination by sending a DISC command packet as a primary or combined station.

Note: Protocol violations and resource outages can cause abnormal termination.

DLC FDDI Programming Interfaces

The data link control (DLC) fiber distributed data interface (FDDI) conforms to generic data link control (GDLC) guidelines except where noted below. Additional structures and definitions for DLC FDDI are found in the `/usr/include/sys/fdlectcb.h` file.

The following entry points are supported by DLC FDDI:

Note: The **dlc** prefix is replaced with the **fdl** prefix for the DLC FDDI device manager.

fdlclose	Fully compatible with the dlcclose GDLC interface.
fdlconfig	Fully compatible with the dlcconfig GDLC interface. No initialization parameters are required.

fdlmpx	Fully compatible with the dlcmtx GDLC interface.
fdlopen	Fully compatible with the dlcopen GDLC interface.
fdlread	<p>Compatible with the dlcread GDLC interface with the following conditions:</p> <ul style="list-style-type: none"> • The readx subroutines may have DLC FDDI data link header information prefixed to the information field (I-field) being passed to the application. This is optional based on the readx subroutine <i>data link header length</i> extension parameter in the gdl_io_ext structure. • If this field is nonzero, DLC FDDI copies the data link header and the I-field to user space, and sets the actual length of the data link header into the length field. • If the field is 0, no data link header information is copied to user space. See the DLC FDDI Frame Encapsulation (Figure 8 on page 60) figure for more details. <p>Kernel receive packet function handlers always have the DLC FDDI data link header information within the communications memory buffer (mbuf), and can locate it by subtracting the length passed (in the gdl_io_ext structure) from the data offset field of the mbuf structure.</p>
fdlselect	Fully compatible with the dlcselect GDLC interface.
fdlwrite	Compatible with the dlcwrite GDLC interface, with the exception that network data can only be written as an unnumbered information (UI) packet and must have the complete data link header prefixed to the data. DLC FDDI verifies that the local (source) service access point (SAP) is enabled and that the control byte is UI (0x03). See the DLC FDDI Frame Encapsulation figure (Figure 8 on page 60) for more details.
fdlioctl	<p>Compatible with the dlciocctl GDLC interface. The following ioctl operations contain FDDI-specific conditions on GDLC operations:</p> <ul style="list-style-type: none"> • “DLC_ENABLE_SAP” • “DLC_START_LS” on page 66 • “DLC_ALTER” on page 67 • “DLC_ENTER_SHOLD” on page 67 • “DLC_EXIT_SHOLD” on page 67 • “DLC_ADD_GROUP” on page 68 • “DLC_ADD_FUNC_ADDR” on page 68 • “DLC_DEL_FUNC_ADDR” on page 68 • “DLC_DEL_GRP” on page 68 • “DLC_QUERY_SAP” on page 68 • “DLC_QUERY_LS” on page 68 • “IOCINFO” on page 68

The following sections describe these conditions.

DLC_ENABLE_SAP

The **ioctl** subroutine argument structure for enabling a SAP, **dlc_esap_arg**, has the following specifics:

- The **grp_addr** (group address) field contains the full six-byte group address with the individual control bits, group control bits, universal control bits, and local control bits located in the most significant bit positions of the first (leftmost) byte.
- The **func_addr_mask** (functional address mask) field is not supported.
- The **max_ls** (maximum link stations) field cannot exceed a value of 255.
- The following common SAP flags are not supported:

NTWK	Indicates a teleprocessing network type.
LINK	Indicates a teleprocessing link type.
PHYC	Represents a physical network call (teleprocessing).
ANSW	Indicates a teleprocessing autocal and autoanswer.

- Group SAPs are not supported, so the **num_grp_saps** (number of group SAPs) field must be set to 0.

- The `laddr_name` (local address or name) field and its associated length are only used for name discovery when the common SAP flag **ADDR** is set to 0. When resolve procedures are used (the **ADDR** flag set to 1), DLC FDDI obtains the local network address from the device handler and not from the **dlc_esap_arg** structure.
- The `local_sap` (local service access point) field can be set to any value except the null SAP (0x00) or the name-discovery SAP (0xFC). Also, the low-order bit must be set to 0 (B`nnnnnn0') to indicate an individual address.
- No protocol-specific data area is required for DLC FDDI to enable an SAP.

DLC_START_LS

The `ioctl` subroutine argument structure for starting a link station, **dlc_sls_arg**, has the following specifics:

- The following common link station flags are not supported:

STAT Indicates a station type for SDLC.
NEGO Indicates a negotiable station type for SDLC.

- The `raddr_name` (remote address or name) field is used only for outgoing calls when the **DLC_SLS_LSVC** common link station flag is active.
- The `maxif` (maximum I-field length) field can be set to any value greater than 0. The DLC FDDI device manager adjusts this value to a maximum of 4077 bytes if set too large. See the DLC FDDI frame encapsulation figure ("FDDI Data Packet" on page 59) for more details.
- The `rcv_wind` (receive window) field can be set to any value from 1 to 127, inclusive. The recommended value is 127.
- The `xmit_wind` (transmit window) field can be set to any value from 1 to 127, inclusive. The recommended value is 26.
- The `rsap` (remote SAP) field can be set to any value except the null SAP (0x00) or the name-discovery SAP (0xFC). Also, the low-order bit must be set to 0 (B`nnnnnn0') to indicate an individual address.
- The `max_repoll` field can be set to any value from 1 to 255, inclusive. The recommended value is 8.
- The `repoll_time` field is defined in increments of 0.5 seconds and can be set to any value from 1 to 255, inclusive. The recommended value is 2, giving a time-out duration of 1 to 1.5 seconds.
- The `ack_time` (acknowledgment time) field is defined in increments of 0.5 seconds, and can be set to any value from 1 to 255, inclusive. The recommended value is 1, giving a time-out duration of 0.5 to 1 second.
- The `inact_time` (inactivity time) field is defined in increments of 1 second and can be set to any value from 1 to 255, inclusive. The recommended value is 48, giving a time-out duration of 48 to 48.5 seconds.
- The `force_time` (force halt time) field is defined in increments of 1 second and can be set to any value from 1 to 16383, inclusive. The recommended value is 120, giving a time-out duration of approximately 2 minutes.
- A protocol-specific data area must be appended to the generic start link station (LS) argument (**dlc_sls_arg**). This structure provides DLC FDDI with additional protocol-specific configuration parameters:

```
struct fd1_start_psd
{
    uchar_t      pkt_prty;      /* ring access packet priority */
    uchar_t      dyna_wnd;     /* dynamic window increment    */
    ushort_t     reserved;     /* currently not used           */
};
```

The protocol-specific parameters are:

`pkt_prty` Specifies the ring-access priority that the user wishes to reserve on transmit packets. Values of 0 to 7 are supported, where 0 is the lowest priority and 7 is the highest priority.

dyna_wnd

Network congestion causes the local transmit window count to automatically drop to a value of 1. The dynamic window increment specifies the number of consecutive sequenced packets that must be acknowledged by the remote station before the local transmit window count can be incremented. This allows a gradual increase in network traffic after a period of congestion. This field can be set to any value from 1 to 255; the recommended value is 1.

DLC ALTER

The **ioctl** subroutine argument structure for altering a link station, **dlc_alter_arg**, has the following specifics:

- The following common alter flags are not supported:

SM1, SM2 Sets SDLC control mode.

- A protocol-specific data area must be appended to the generic alter link station argument structure (**dlc_alter_arg**). This structure provides DLC FDDI with additional protocol-specific alter parameters.

```
#define FDL_ALTER_PRTY 0x80000000 /* alter packet priority */
#define FDL_ALTER_DYNA 0x40000000 /* alter dynamic window incr*/
struct fdl_alter_psd
{
    ulong_t      flags; /* specific alter flags */
    uchar_t      pkt_prt; /* ring access packet priority value */
    uchar_t      dyna_wnd; /* dynamic window increment value */
    ushort_t     reserved; /* currently not used */
};

#define FDL_ALTER_PRTY 0x80000000 /* alter packet priority */
#define FDL_ALTER_DYNA 0x40000000 /* alter dynamic window incr*/
struct fdl_alter_psd
{
    __ulong32_t  flags; /* specific alter flags */
    uchar_t      pkt_prt; /* ring access packet priority value */
    uchar_t      dyna_wnd; /* dynamic window increment value */
    ushort_t     reserved; /* currently not used */
};
```

- Specific alter flags include:

FDL_ALTER_PRTY Specifies alter priority. If set to 1, the *pkt_prt* value field replaces the current priority value being used by the link station. The link station must be started for this alter command to be valid.

FDL_ALTER_DYNA Specifies alter dynamic window. If set to 1, the *dyna_wnd* value field replaces the current dynamic window value being used by the link station. The link station must be started for this alter command to be valid.

The protocol-specific parameters are:

pkt_prt Specifies the new priority reservation value for transmit packets.
dyna_wnd Specifies the new dynamic window value to control network congestion.

DLC_ENTER_SHOULD

The **enter_short_hold** option is not supported.

DLC_EXIT_SHOULD

The **exit_short_hold** option is not supported.

DLC_ADD_GROUP

The **add_group**, or multicast address, option is supported by DLC FDDI as a six-byte value as described above in **DLC_ENABLE_SAP** (group address).

The `grp_addr` (group address) field for FDDI contains the full six-byte group address with the individual/group and universal/local control bits located in the most significant bit positions of the first (leftmost) byte.

DLC_ADD_FUNC_ADDR

The **add_functional_address** option is not supported.

DLC_DEL_FUNC_ADDR

The **delete_functional_address** option is not supported.

DLC_DEL_GRP

The delete group or multicast option is supported by the DLC FDDI device manager. The address being removed must match an address that was added with a **DLC_ENABLE_SAP** or **DLC_ADD_GRP** ioctl operation.

DLC_QUERY_SAP

The device driver-dependent data returned from DLC FDDI for this ioctl operation is the **fdi_ndd_stats_t** structure defined in the `/usr/include/sys/cdli_fddiuser.h` file.

DLC_QUERY_LS

There is no protocol-specific data area supported by DLC FDDI for this ioctl operation.

IOCINFO

The *ioctype* variable returned is defined as a **DD_DLC** definition and the subtype returned is **DS_DLCFDDI**.

Asynchronous Function Calls

DLC FDDI is fully compatible with the GDLC interface concerning asynchronous function calls to the kernel mode user.

Chapter 2. Data Link Provider Interface Implementation

The Data Link Provider Interface (DLPI) implementation of the operating system is designed to follow AT&T's "UNIX® International OSI Work Group Data Link Provider Interface" Version 2 (DRAFT) specification. You can obtain a copy electronically if you have Internet access. For information about obtaining the DLPI specification, see "Obtaining Copies of the DLPI Specifications" on page 76.

It is assumed that you are familiar with the DLPI Version 2 specification published by UNIX International, RFC1042, and the various IEEE 802.x documents.

Note: In the text below, the term *dlpi* refers to the driver, while *DLPI* refers to the specification.

The *dlpi* driver is implemented as a style 2 provider and supports both the connectionless and connection-oriented modes of communication. For a list of the primitives supported by the *dlpi* driver, see "DLPI Primitives" on page 74.

Primitive Implementation Specifics

Information pertinent to specific primitives implemented in the *dlpi* driver is documented in the man page for that primitive.

Packet Format Registration Specifics

The *dlpi* driver supports generic Common Data Link Interface (CDLI) network interfaces by allowing the user to specify the particular packet format necessary for the transmission media over which the stream is created. Using the **M_IOCTL** or **M_CTL** streams message, the user can specify the packet format. If no packet format is specified, the default is **NS_PROTO**.

The DLPI user specifies the packet format through the **STREAMS I_STR** ioctl. The DLPI user is allowed one packet format specification per stream. This packet format must be specified after the attach and before the bind. Otherwise, an error is generated.

The packet formats defined in **/usr/include/sys/cdli.h** follow:

NS_PROTO	Remove all link-level headers. Sub-Network Access Protocol (SNAP) is not used.
NS_PROTO_SNAP	Remove all link-level headers including SNAP.
NS_INCLUDE_LLC	Leave LLC headers in place.
NS_INCLUDE_MAC	Do not remove any headers.

The packet formats defined in the **/usr/include/sys/dlpi_aix.h** file are:

NS_PROTO_DL_COMPAT	Use the AIX 3.2.5 DLPI address format.
NS_PROTO_DL_DONTCARE	No addresses present in DL_UNITDATA_IND . For the DL_UNITDATA_IND primitive, DLPI provides the header information in the dl_unitdata_ind_t structure.

All packet formats except **NS_INCLUDE_MAC** accept downstream addresses in the following form:
`mac_addr.dsap[.snap].`

Individually, packet formats have the following requirements:

NS_PROTO or **NS_PROTO_SNAP** Medium access control (MAC) and logical link control (LLC) are included in the DLPI header, and the data portion of the message contains only data. The **NS_PROTO** header does not include SNAP; the **NS_PROTO_SNAP** header does. Both packet formats present destination addresses as `mac_addr` and source addresses as `mac_addr.ssap.dsap.ctr1[.snap]`.

For the **DL_UNITDATA_REQ** primitive, the DLPI user must provide the destination address and an optional destination service access point (DSAP) in the DLPI header. If the DLPI user does not specify the DSAP, the DSAP specified at bind time is used.

NS_PROTO_DONTCARE The dlpi driver places no addresses in the upstream **DL_UNITDATA_IND**. Addresses are still required on the **DL_UNITDATA_REQ**.

NS_PROTO_DL_COMPAT The dlpi driver uses the address format used in the AIX 3.2.5 dlpi driver, which is identical both upstream and downstream. The source and destination addresses are presented as `mac_addr.dsap[.snap]`.

NS_INCLUDE_LLC The DLPI header contains only the destination and source addresses. Only the LLC is placed in the **M_DATA** portion of the **DL_UNITDATA_IND** message. Both the source and destination addresses are presented as `mac_addr`.

For the **DL_UNITDATA_REQ** primitive, the DLPI user must provide the destination address and an optional DSAP in the DLPI header. If the DLPI user does not specify the DSAP, the DSAP specified at bind time is used.

NS_INCLUDE_MAC The MAC and LLC are both placed in the data portion of the message. Thus, the DLPI user must have knowledge of the MAC header and LLC architecture for a specific interface to retrieve the MAC header and LLC from the data portion of the message. This format sets the stream to raw mode, which does not process incoming or outgoing messages.

For the **DL_UNITDATA_REQ** primitive, the DLPI user must provide the destination address and an optional DSAP in the DLPI header. If the DLPI user does not specify the DSAP, the DSAP specified at bind time is used.

Downstream messages do not require the **DL_UNITDATA_REQ** header and must be received as **M_DATA** messages. Downstream messages must contain a completed MAC header, which will be copied to the medium without further translation.

Address Resolution Routine Registration Specifics

The dlpi driver can support all generic interface types. DLPI is implemented to allow the user to specify address resolution routines for input and output using the **STREAMS_I_STR** ioctl or to rely on the system default routines. The operating system provides default address resolution routines (stored in the `/usr/include/sys/ndd.h` file) that are interface specific.

The default input address resolution routine is as follows:

```
ndd->ndd_demuxer->nd_address_input
```

The dlpi driver calls the input address resolution routine with a pointer to the MAC header (and, optionally, the LLC header) and a pointer to a memory buffer (mbuf) structure containing data. The actual contents of the data area depend on which type of packet format was specified. (See “Packet Format Registration Specifics” on page 69.)

The default output address resolution routine is:

```
ndd->ndd_demuxer->nd_address_resolve
```

The dlpi driver calls the output address resolution routine with a pointer to an `output_bundle` structure (described in `/usr/include/net/nd_lan.h`), an mbuf structure, and an ndd structure. The driver assigns the destination address to `key_to_find` and copies the `pkt_format` and bind time `llc` into helpers. If the user has provided a different DSAP than what was set at bind time, the driver also copies the DSAP values into helpers. The output resolution routine completes the MAC header and calls the `ndd_output` subroutine.

If you choose to specify an input or output address resolution routine or both, use the following sample code:

```
noinres(int fd) {
    return istr(fd, DL_INPUT_RESOLVE, 0);
}
```

ioctl Specifics

The dlpi driver supports the following ioctl operations:

- **DL_ROUTE**
- **DL_TUNE_LLC**
- **DL_ZERO_STATS**
- **DL_SET_REMADDR**

These commands and their associated data structures are described in the `/usr/include/sys/dlpi_aix.h` header file.

Note: The ioctl commands that require an argument longer than one long word, or that specify a pointer for either reading or writing, must use the **I_STR** format, as in the following example:

```
int
istr(int fd, int cmd, char *data, int len) {
    struct strioctl ic;
    ic.cmd = cmd;
    ic.timeout = -1;
    ic.dp = data;
    ic.dp = data;
    ic.len = len;
    return ioctl(fd, I_STR, &ic);
}
```

DL_ROUTE

Disables the source routing on the current stream, queries the “Dynamic Route Discovery” on page 73 for a source route, or statically assigns a source route to this stream. It is only accepted when the stream is idle (**DL_IDLE**).

- If the argument length is 0, no source route is used on outgoing frames.
- If the argument length is equal to the length of the MAC address for the current medium (for example, 6 for most 802.x providers), the DRD algorithm is used to obtain the source route for the address specified in the argument. The MAC address is replaced with the source route on return from the ioctl.
- Otherwise, the argument is assumed to contain an address of the form `mac_addr.source_route`, and the `source_route` portion is used as the source route for this stream in all communications.

As an example, the following code can be used to discover the source route for an arbitrary address:

```
char *
getroute(int fd, char *addr, int len) {
    static char route[MAXROUTE_LEN];
    bcopy(addr, route, len);
    if (istr(fd, DL_ROUTE, route, len))
        return 0;
    return route;
}
```

DL_TUNE_LLC

Allows the DLS user to alter the default LLC tunable parameters. The argument must point to an **llctune_t** data structure.

The flags field is examined to determine which, if any, parameters should be changed. Each bit in the flags field corresponds to a similarly named field in the **llctune_t**; if the bit is set, the corresponding parameter is set to the value in **llctune_t**. Only the current stream is affected, and changes are discarded when the stream is closed.

If the **F_LLC_SET** flag is set and the user has root authority, the altered parameters are saved as the new default parameters for all new streams.

This command returns as its argument an update of the current tunable parameters.

For example, to double the t1 value, the following code might be used:

```
int
more_t1(int fd) {
    llctune_t t;
    t.flags = 0;
    if (istr(fd, DL_TUNE_LLC, &t, sizeof(t)))
        return -1;
    t.flags = F_LLC_T1;
    t.t1 *= 2;
    return istr(fd, DL_TUNE_LLC, &t, sizeof(t));
}
```

To query the tunables, issue **DL_TUNE_LLC** with the flags field set to zero. This will alter no parameters and return the current tunable values.

DL_ZERO_STATS

Resets the statistics counters to zero. The driver maintains two independent sets of statistics, one for each stream (local), and another that is the cumulative statistics for all streams (global).

This command accepts a simple boolean argument. If the argument is True (nonzero), the global statistics are zeroed. Otherwise, only the current stream's statistics are zeroed.

For example, to zero the statistics counters on the current stream, the following code might be used:

```
int
zero_stats(int fd) {
    return ioctl(fd, DL_ZERO_STATS, 0);
}
```

DL_SET_REMADDR

Allows XID/TEST exchange on connection-oriented streams while still in the **DL_IDLE** state.

The dlpi driver uses both the source (remote) address and the dl_sap to determine where to route incoming messages for connection-oriented streams. The remote address is ordinarily specified in **DL_CONNECT_REQ**. If the DLS user needs to exchange XID or TEST messages before connecting to the remote station, **DL_SET_REMADDR** must be used.

Note: Note that this command is *not* necessary if XID and TEST messages are to be exchanged only when the state is **DL_DATAXFER**.

The argument to this command is the remote MAC address. One possible code fragment might be:

```
int
setaddr(int fd, char *addr, int len) {
    return istr(fd, DL_SET_REMADDR, addr, len);
}
```

Dynamic Route Discovery

Dynamic Route Discovery (DRD) is an algorithm used to automatically discover the proper source route that reaches a remote station on either a token ring or a Fiber Distributed Data Interface (FDDI) network. It relieves the DLS user from discovering and maintaining source routes. The algorithm implements the spanning tree, as recommended by 802.5.

When the DLS user issues a transmission request (for example, **DL_CONNECT_REQ** or **DL_UNITDATA_REQ**) on a medium supporting source routing, the DRD algorithm consults a local cache of source routes. If there is a hit, the cached source route is used immediately. Otherwise, the DRD queues the transmission request and starts the discovery algorithm. If the algorithm finds a source route, the new route is cached, and the queued requests are transmitted using this new route. If the algorithm times out with no replies (approximately 10 seconds), the queued requests are rejected.

The cache is periodically flushed of stale entries. An entry becomes stale after 5 minutes of no new requests.

Note: After a connection is established, the source route discovered during the connection setup is used to the exclusion of the DRD. This has two effects:

- If the source route changes during a connection, the connection continues to use the original source route.
- If the original source route becomes invalid, the connection breaks, and no rediscovery is attempted until a new connection is started.

DRD Configuration

The DRD is selectable on a per-media basis when the dlpi driver is first loaded into the kernel. By default, the DRD is disabled for all media types. It can be enabled by appending the string ",r" (uses routing) to the argument field in **/etc/dlpi.conf**. Once selected, it is used by all physical points of attachment (PPAs) for that media type. The following example configurations both show token ring and FDDI configured, first in a default configuration and then with DRD enabled.

Default configuration:

```
d+   dlpi   tr       /dev/dlpi/tr
d+   dlpi   fi       /dev/dlpi/fi
```

DRD-enabled configuration:

```
d+   dlpi   tr,r     /dev/dlpi/tr
d+   dlpi   fi,r     /dev/dlpi/fi
```

Connectionless Mode Only DLPI Driver versus Connectionless/Connection-Oriented DLPI Driver

Notes:

1. For binary compatibility purposes, there are no new statistics added for the connection-oriented functions. Statistics for the connection-oriented functions will be provided in a future release of the operating system.
2. For binary compatibility purposes, a **DL_UNITDATA_IND** header is provided in the messages for promiscuous mode and raw mode. Be aware that this header will be removed in a future release of the operating system.

The following sample code fragment works with the 4.1 and later versions of DLPI:

```
if (raw_mode) {
    if (mp->b_datap->db_type == M_PROTO) {
        union DL_primitives *p;
```

```

        p = (union DL_primitives *)mp->b_rptr;
        if (p->dl_primitive == DL_UNITDATA_IND) {
            mblk_t *mpl = mp->b_cont;
            freeb(mp);
            mp = mpl;
        }
    }
}

```

The above code fragment discards the **DL_UNITDATA_IND** header. For compatibility with future releases, it is recommended that you parse the frame yourself. The MAC and LLC headers are presented in the **M_DATA** message for both promiscuous mode and raw mode.

Raw mode currently accepts, but does not require, a **DL_UNITDATA_REQ**. In a future release of the operating system, raw mode will not accept a **DL_UNITDATA_REQ**; only **M_DATA** will be accepted.

The dlpi driver supports the 802.2 connection-oriented service over the CDLI-based media 802.3, token ring, and FDDI. Other CDLI-based media can be supported provided the media implementation follows the IEEE 802.x recommendations.

The **DL_BIND_REQ** primitive accepts values for some fields (refer to the **DL_BIND_REQ** primitive in *AIX 5L Version 5.3 Technical Reference: Communications Volume 1*).

The **DL_OUTPUT_RESOLVE** and **DL_INPUT_RESOLVE** ioctl commands replace the default address resolution routines for the current stream. They are no longer accepted from user space; the message type must be **M_CTL** (not **M_IOCTL**), and they are only accepted before the stream is bound. **DL_INPUT_RESOLVE** is accepted as an **M_IOCTL** message only if its argument is zero; this allows the user to disable input address resolution. Output address resolution cannot be disabled—use the raw mode if transparent access to the medium is required.

The **DL_PKT_FORMAT** ioctl command now recognizes and handles the following packet formats: **NS_PROTO**, **NS_PROTO_SNAP**, **NS_PROTO_DL_DONTCARE**, **NS_PROTO_DL_COMPAT**, **NS_INCLUDE_LLC**, and **NS_INCLUDE_MAC**.

New ioctl commands are now supported: **DL_ROUTE**, **DL_TUNE_LLC**, **DL_ZERO_STATS**, and **DL_SET_REMADDR**. Refer to “ioctl Specifics” on page 71.

DLPI Primitives

The following primitives are supported by DLPI:

- **DL_ATTACH_REQ**
- **DL_BIND_ACK**
- **DL_BIND_REQ**
- **DL_DETACH_REQ**
- **DL_DISABMULTI_REQ**
- **DL_ENABMULTI_REQ**
- **DL_ERROR_ACK**
- **DL_GET_STATISTICS_REQ**
- **DL_GET_STATISTICS_ACK**
- **DL_INFO_ACK**
- **DL_INFO_REQ**
- **DL_OK_ACK**
- **DL_PHYS_ADDR_REQ**
- **DL_PHYS_ADDR_ACK**
- **DL_PROMISCOFF_REQ**

- **DL_PROMISCON_REQ**
- **DL_SUBS_BIND_ACK**
- **DL_SUBS_BIND_REQ**
- **DL_SUBS_UNBIND_REQ**
- **DL_TEST_CON**
- **DL_TEST_IND**
- **DL_TEST_REQ**
- **DL_TEST_RES**
- **DL_UDERROR_IND**
- **DL_UNBIND_REQ**
- **DL_UNITDATA_IND**
- **DL_UNITDATA_REQ**
- **DL_XID_CON**
- **DL_XID_IND**
- **DL_XID_REQ**
- **DL_XID_RES**

The following connection-oriented service primitives are supported:

- **DL_CONNECT_REQ**
- **DL_CONNECT_IND**
- **DL_CONNECT_RES**
- **DL_CONNECT_CON**
- **DL_TOKEN_REQ**
- **DL_TOKEN_ACK**
- **DL_DATA_REQ**
- **DL_DATA_IND**
- **DL_DISCONNECT_REQ**
- **DL_DISCONNECT_IND**
- **DL_RESET_REQ**
- **DL_RESET_IND**
- **DL_RESET_RES**
- **DL_RESET_CON**

The following primitives are *not* supported:

- **DL_UDQOS_REQ**
- **DL_SET_PHYS_ADDR_REQ**

The following acknowledged connectionless-mode primitives are *not* supported:

- **DL_DATA_ACK_REQ**
- **DL_DATA_ACK_IND**
- **DL_DATA_ACK_STATUS_IND**
- **DL_REPLY_REQ**
- **DL_REPLY_IND**
- **DL_REPLY_STATUS_IND**
- **DL_REPLY_UPDATE_REQ**
- **DL_REPLY_UPDATE_STATUS_IND**

Note: If any unsupported primitive is issued to the provider, the provider will return the **DL_ERROR_ACK** primitive with the **DL_NOTSUPPORTED** error code.

Obtaining Copies of the DLPI Specifications

You can obtain copies of the Data Link Provider Interface (DLPI) specifications electronically using File Transfer Protocol (FTP) commands. A postscript version of the DLPI specifications may be retrieved electronically by anonymous **ftp** from any of the following list of Internet hosts.

Hosts	IP Address	Pathname
liason3.epfl.ch	128.178.155.12	/pub/sun/dlpi
marsh.cs.curtin.edu.au	134.7.1.1	/pub/netman/dlpi
ftp.eu.net	192.16.202.2	/network/netman/dlpi
opcom.sun.ca	142.77.1.61	/pub/drivers/dlpi
ftp.cac.psu.edu	128.118.2.23	/pub/unix/netman/dlpi

To retrieve the postscript DLPI specifications through anonymous **ftp**, use the following example:

```
ftp ftp.eu.net
Connected to eunet.EU.net.
220-
220-Welcome to the central EUnet Archive,
220-
220 eunet.EU.net FTP server (Version wu-2.4(2) Jul 09 1993) ready.
Name (ftp.eu.net:jhaug):anonymous
ftp> user anonymous
331 Guest login ok, send your complete e-mail address as password.
Password:
ftp> cd /network/netman/dlpi
250 CWD command successful.
ftp> bin
200 Type set to I.
ftp> get dlpi.ps.Z
200 PORT command successful.
150 Opening BINARY mode data connection for dlpi.ps.Z (479345 bytes).
226 Transfer complete.
1476915 bytes received in 39.12 seconds (11.97 Kbyte/s)
ftp> quit
221 Goodbye.
```

There is no guarantee that a public Internet server will always be available. If the above public Internet server host is not available, you might try using one of the Internet archive server listing services, such as Archie, to search for a public server that has the DLPI specifications.

Chapter 3. New Database Manager

The New Database Manager (NDBM) subroutines maintain key and content pairs in a database. The NDBM subroutines handle large databases and access keyed items in one or two file system accesses. Keyed items are consecutive characters, taken from a data record, that identify the record and establish its order with respect to other records.

NDBM databases are stored in two files. One file is a directory containing a bit map and it has the extension **.dir**. The second file contains only data and has the extension **.pag**.

For example, Network Information Service (NIS) maps maintain database information in NDBM format. NIS maps are created using the **makedbm** command. The **makedbm** command converts input into NDBM format files. An NIS map consists of two files: *map.key.pag* and *map.key.dir*. The file with the **.dir** extension serves as an index for the **.pag** files. The file with the **.pag** extension contains the key and value pairs.

Note: The NDBM library replaces the earlier Database Manager (DBM) library, which managed a single database.

Using NDBM Subroutines

To access a database, issue the **dbm_open** subroutine. The **dbm_open** subroutine opens or creates the *file.dir* and *file.pag* files, depending on the flags parameter. To close a database, issue the **dbm_close** subroutine. Close one database before opening another database.

Other NDBM subroutines include the following:

dbm_delete	Deletes a key and its associated contents.
dbm_fetch	Accesses data stored under a key.
dbm_firstkey	Returns the first key in the database.
dbm_nextkey	Returns the next key in the database.
dbm_store	Stores data under a key.

Diagnosing NDBM Problems

A return value of 0 indicates no error. Subroutines that return a negative value indicate an error has occurred. A positive integer return indicates the status of the return. For example, if the **dbm_store** subroutine, issued with an insert flag, finds an existing entry with the same key, it returns a 1.

The **dbm_fetch**, **dbm_firstkey**, and **dbm_nextkey** subroutines return a **datum** structure containing the value returned for the specified key. If the subroutine is unsuccessful, a null value is indicated in the *dptr* field of the **datum** structure.

List of NDBM and DBM Programming References

This list includes both New Database Manager (NDBM) subroutines and their equivalent Database Manager (DBM) subroutines.

NDBM Subroutines

dbm_close	Closes a database.
dbm_delete	Deletes a key and its associated contents.
dbm_fetch	Accesses data stored under a key.

dbm_firstkey	Returns the first key in the database.
dbm_nextkey	Returns the next key in the database.
dbm_open	Opens a database for access.
dbm_store	Stores data under a key.

DBM Subroutines

dbmclose	Closes a database.
dbmopen	Opens a database.
delete	Deletes a key and its associated contents.
fetch	Accesses the data stored under a key.
firstkey	Returns the first key that matches the specification.
nextkey	Returns the next key in the database.
store	Stores data under a key.

Chapter 4. eXternal Data Representation

The eXternal Data Representation (XDR) is a standard for the description and encoding of data. XDR uses a language to describe data formats, but the language is used only for describing data and is not a programming language. Protocols such as Remote Procedure Call (RPC) and the Network File System (NFS) use XDR to describe their data formats.

This chapter discusses the following topics:

- “eXternal Data Representation Overview for Programming”
- “XDR Subroutine Format” on page 81
- “XDR Library” on page 81
- “XDR Language Specification” on page 82
- “XDR Data Types” on page 84
- “List of XDR Programming References” on page 94
- “XDR Library Filter Primitives” on page 95
- “XDR Non-Filter Primitives” on page 98
- “Passing Linked Lists Using XDR Example” on page 100
- “Using an XDR Data Description Example” on page 102
- “Showing the Justification for Using XDR Example” on page 103
- “Using XDR Example” on page 105
- “Using XDR Array Examples” on page 106
- “Using an XDR Discriminated Union Example” on page 107
- “Showing the Use of Pointers in XDR Example” on page 108

eXternal Data Representation Overview for Programming

This overview provides the following information about programming XDR:

- “XDR Subroutine Format” on page 81
- “XDR Library” on page 81
- “XDR Language Specification” on page 82
- “XDR Data Types” on page 84
- “XDR Library Filter Primitives” on page 95
- “XDR Non-Filter Primitives” on page 98
- “List of XDR Programming References” on page 94

XDR not only solves data portability problems, it also permits the reading and writing of arbitrary C language constructs in a consistent and well-documented manner. Therefore, it makes sense to use the XDR library routines even when the data is not shared among machines on a network.

The XDR standard does not depend on machine languages, manufacturers, operating systems, or architectures. This condition enables networked computers to share data regardless of the machine on which the data is produced or consumed. The XDR language permits transfer of data between different computer architectures and has been used to communicate data between such diverse machines as the VAX, IBM®, and Cray.

Remote Procedure Call (RPC) uses XDR to establish uniform representations for data types in order to transfer message data between machines. For basic data types, such as integers and strings, XDR provides filter primitives that serialize, or translate, information from the local host’s representation to XDR’s representation. Likewise, XDR filter primitives deserialize XDR’s data representation to the local

host's data representation. XDR constructor primitives allow the use of the basic data types to create more complex data types such as arrays and discriminated unions.

The XDR routines that are called directly by remote procedure call routines can be found in "List of XDR Programming References" on page 94.

A Canonical Standard

The XDR approach to standardizing data representations is *canonical*. That is, XDR defines representations for a single byte (most significant bit first), a single floating-point representation (IEEE), and so on. Any program running on any machine can use XDR to create portable data by translating its local representation to the XDR standards. Similarly, any program running on any machine can read portable data by translating the XDR standard representations to its local equivalents. The canonical standard completely decouples programs that create or send portable data from those that use or receive portable data.

The advent of a new machine or new language has no effect upon the community of existing portable data creators and users. A new machine can be programmed to convert both the standard representations and its local representations regardless of the local representations of other machines. Conversely, the local representations of the new machine are also irrelevant to existing programs running on other machines. These existing programs can immediately read portable data produced by the new machine, because such data conforms to canonical standards.

Strong precedents exist for XDR's canonical approach. All protocols below layer five of the ISO model, including Transmission Control Protocol (TCP), Internet Protocol (IP), User Datagram Protocol (UDP), and Ethernet, are canonical protocols. The advantage of any canonical approach is simplicity. XDR fits into the ISO presentation layer and is roughly analogous in purpose to X.409, ISO Abstract Syntax Notation. The major difference here is that XDR uses implicit typing, while X.409 uses explicit typing. With XDR, a single set of conversion routines need only be written once.

The time spent converting to and from a canonical representation is insignificant, especially in networking applications. When preparing a data structure for transfer, traversing the elements of the structure requires more time than converting the data. In networking applications, additional time is required to move the data down through the sender's protocol layers, across the network, and up through the receiver's protocol layers. Every machine must traverse and copy data structures, regardless of whether conversion is required.

Basic Block Size

The XDR language is based on the assumption that bytes (eight bits of data or an octet) can be ported to and encoded on media that preserve the meaning of the bytes across the hardware boundaries of data. XDR does not represent bit fields or bit maps. It represents data in blocks of multiples of four bytes (32 bits). The bytes are numbered from 0 to the value of $n - 1$, where the value $(n \bmod 4)$ equals 0. They are read from or written to a byte stream in order, such that byte m precedes byte $m + 1$.

Bytes are ported and encoded from low order to high order in local area networks. Representing data in standardized formats resolves situations that occur when different byte-ordering formats exist on networked machines. This also enables machines with different structure-alignment algorithms to communicate with each other.

See the A Block figure (Figure 9 on page 81) for a representation of a block.

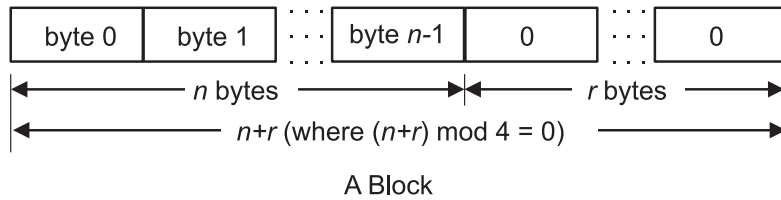

Figure 9. A Block. The first line of the diagram shows the following: byte 0, byte 1, dots signifying the bytes between byte 1 and byte n-1, and then byte n-1. After byte n-1 are two residual bytes labeled zero; between these bytes are dots signifying any additional residual bytes would be included. The second line of the diagram shows the byte values of the first line. Byte 0 to byte n-1 is equal to n bytes and the residual zero bytes have a length of r bytes. The last line of the diagram shows an equation that spans the length of the diagram, the equation follows: $n+r$ (where $(n+r) \bmod 4 = 0$) identifies the length.

In a graphics box illustration, each box is delimited by a + (plus sign) at the four corners and by vertical bars and dashes. Each box depicts a byte. The three sets of . . . (ellipsis) between boxes indicate 0 or more additional bytes, where required.

Unsupported Representations

The XDR standard currently lacks representations for bit fields and bit maps because the standard is based on bytes. Packed, or binary-coded, decimals are also missing.

The XDR standard describes only the most commonly used data types of high-level languages, such as C or Pascal. This standard enables applications that are written in these languages to communicate easily.

XDR Subroutine Format

An eXternal Data Representation (XDR) subroutine is associated with each data type. XDR subroutines have the following format:

```
xdr_XXX (XDRS, FP)
    XDR *XDRS;
    XXX *FP;
{
}
```

The parameters are described as follows:

XXX	Requires an XDR data type.
XDRS	Specifies an opaque handle that points to an XDR stream. The opaque handle pointer is passed to the primitive XDR routines.
FP	Specifies an address of the data value that provides data to the stream or receives data from it.

The XDR subroutines usually return a value of 1 if successful. If unsuccessful, the return value is 0. Return values other than these are noted within the description of the appropriate subroutine.

XDR Library

The eXternal Data Representation (XDR) library includes subroutines that permit programmers not only to read and write C language constructs, but also to write XDR subroutines that define other data types.

The XDR library includes the following:

- Library primitives for basic data types and constructed data types. The basic data types include number filters for integers, floating-point and double-precision numbers, enumeration filters, and a subroutine for passing no data. Constructed data types include the filters for strings, arrays, unions, pointers, and opaque data.

- Data stream creation routines that call streams for serializing and deserializing data to or from standard I/O file streams, Transmission Control Protocol (TCP), Internet Protocol (IP) connections, and memory.
- Subroutines for the implementation of new XDR streams.
- Subroutines for passing linked lists.

See “Showing the Justification for Using XDR Example” on page 103.

XDR with RPC

The XDR subroutines and macros may be called explicitly or by a Remote Procedure Call (RPC) subroutine. When using XDR with RPC, clients do not create data streams. Instead, the RPC interface creates the streams. The RPC interface passes the information about a data stream as opaque data in the form of handles. This opaque data handle is referred to in subroutines as the *xdrs* parameter.

Programmers who use C language programs with XDR subroutines must include the **rpc/xdr.h** file, which contains the necessary XDR interfaces.

XDR Operation Directions

The XDR subroutines are not dependent on direction. The operation direction represented by **xdrs->xop** can have an **XDR_ENCODE**, **XDR_DECODE**, or **XDR_FREE** value. These operation values are handled internally by the XDR subroutines, which means the same XDR subroutine can be called to serialize or deserialize data. To achieve this independence, XDR passes the address of the object instead of passing the object itself.

XDR Language Specification

The eXternal Data Representation (XDR) language specification uses an extended Backus Naur form notation for describing the XDR language. The following is a brief description of the notation:

- The following characters are special characters:

- | A vertical bar separates alternative items.
 - () Parentheses enclose items that are grouped together.
 - [] Brackets enclose optional items.
 - ,
 - *
- A comma separates more than one variable.
An asterisk following an item means 0 or more occurrences of the item.

- Terminal symbols are strings of special and nonspecial characters surrounded by " " (double quotation marks).
- Nonterminal symbols are strings of nonspecial characters.

The following specification illustrates the XDR notation:

```
"a" "very" ("," "very")* ["cold" "and"] "rainy" ("day" | "night")
```

An infinite number of strings match this pattern, including the following examples:

- "a very rainy day"
- "a very, very rainy day"
- "a very, cold and rainy day"
- "a very, very, very cold and rainy night"

Lexical Notes

The following lexical notes apply to XDR language specification:

- Comments begin with a /* (backslash, asterisk) and terminate with an */ (asterisk, backslash).
- White space is used to separate items and is otherwise ignored.

- An identifier is a letter followed by an optional sequence of letters, digits, or an _ (underscore). Identifiers are case-sensitive.
- A constant is a sequence of one or more decimal digits, optionally preceded by a - (minus sign).

Declarations, Enumerations, Structures, and Unions

The following XDR syntax describes declarations, enumerations, structures, and unions:

```

declaration:type-specifier identifier
| type-specifier identifier "[" value "]"
| type-specifier identifier "<" [ value ] "<"
| "opaque" identifier "[" value "]"
| "string" identifier "[" value "]"
| type-specifier "*" identifier
|"void"
value:
constant
| identifier
type-specifier:
[ "unsigned" ] "int"
| [ "unsigned" ] "hyper"
| "float"
| "double"
| "bool"
| enum-type-spec
| struct-type-spec
| union-type-spec
| identifier
enum-type-spec:
"enum" enum-body
enum-body:
"{"
( identifier "=" value )
(", " identifier "=" value ) *
"}"
struct-type-spec:
"struct" struct-body
struct-body:
"{"
( declaration ";" )
( declaration ";" ) *
"}"
union-type-spec:
"union" union-body
union-body:
"switch" "(" declaration ")" "{"
( "case" value ":" declaration ";" )
( "case" value ":" declaration ";" ) *
[ "default" ":" declaration ";" ]
"}"

```

```

constant-def:
"const" identifier "=" constant ";"
type-def
"typedef" declaration ";"
| "enum" identifier enum-body ";"
| "struct" identifier struct-body ";"
| "union" identifier union-body ";"
definition:
type-def
| constant-def
specification:
definition *

```

Syntax Notes

The following considerations pertain to XDR language syntax:

- The following keywords cannot be used as identifiers:
 - **bool**
 - **case**
 - **const**
 - **default**
 - **double**
 - **enum**
 - **float**
 - **hyper**
 - **opaque**
 - **string**
 - **struct**
 - **switch**
 - **typedef**
 - **union**
 - **unsigned**
 - **void**
- Only unsigned constants can be used as size specifications for arrays. If an identifier is used, it must be declared previously as an unsigned constant in a **const** definition.
- In the scope of a specification, constant and type identifiers are in the same name space and must be declared uniquely.
- Variable names must be unique in the scope of **struct** and **union** declarations. Nested **struct** and **union** declarations create new scopes.

XDR Data Types

The following basic and constructed data types are defined in the eXternal Data Representation (XDR) standard:

- “Integer Data Types” on page 85
- “Enumeration Data Types” on page 86
- “Boolean Data Types” on page 86
- “Floating-Point Data Types” on page 86

- “Opaque Data Types” on page 88
- “Array Data Types” on page 89
- “Strings” on page 90
- “Structures” on page 91
- “Discriminated Unions” on page 91
- “Voids” on page 92
- “Constants” on page 92
- “Type Definitions” on page 92
- “Optional Data” on page 93

A general paradigm declaration is shown for each type. The < and > (angle brackets) denote variable-length sequences of data, while the [and] (square brackets) denote fixed-length sequences of data. The letters *n*, *m*, and *r* denote integers. See “Using an XDR Data Description Example” on page 102 for an extensive example of the data types.

Integer Data Types

XDR defines two integer data types. The first type is signed and unsigned integers. The second type is signed and unsigned hyperintegers.

Signed and Unsigned Integers

The XDR standard defines signed integers as *integer*. A signed integer is a 32-bit datum that encodes an integer in the range [-2147483648 to 2147483647]. The signed integer is represented in twos complement notation. The most significant byte is 0 and the least significant is 3.

An unsigned integer is a 32-bit datum that encodes a nonnegative integer in the range [0 to 4294967295]. The unsigned integer is represented by an unsigned binary number whose most significant byte is 0; the least significant is 3. See the Signed Integer and Unsigned Integer figure (Figure 10).

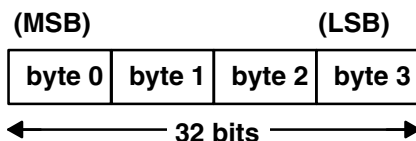

Signed Integer and Unsigned Integer

Figure 10. Signed Integer and Unsigned Integer. This diagram shows the most significant byte on the left, which is byte 0. To the right of byte 0, is byte 1, followed by byte 2, and then byte 3 (the least significant byte). The length of the 4 bytes is 32 bits.

Signed and Unsigned Hyperintegers

The XDR standard also defines 64-bit (8-byte) numbers called signed and unsigned *hyperinteger*. Their representations are extensions of signed integers and unsigned integers. Hyperintegers are represented in twos complement notation. The most significant byte is 0 and the least significant is 7. See the Signed Hyperinteger and Unsigned Hyperinteger figure (Figure 11 on page 86).

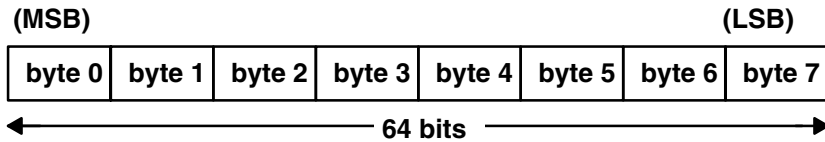

Signed Hyperinteger and Unsigned Hyperinteger

Figure 11. Signed Hyperinteger and Unsigned Hyperinteger. This diagram shows the most significant byte on the left which is byte 0. To the right of byte 0, is byte 1, followed by byte 2, and byte 3 continued up to byte 7 (the least significant byte). The length of the 8 bytes is 64 bits.

Enumeration Data Types

The XDR standard provides enumerations for describing subsets of integers. XDR defines enumerations as **enum**. Enumerations have the same representation as signed integers and are declared as follows:

```
enum { name-identifier = constant, ... } identifier;
```

Encoding any integers as **enum**, besides those assigned in the **enum** declaration, causes an error condition.

Boolean Data Types

Booleans occur frequently enough to warrant an explicit data type in the XDR standard.

Booleans are declared as follows:

```
bool identifier;
```

This declaration is equivalent to:

```
enum { FALSE = 0, TRUE = 1 } identifier;
```

Floating-Point Data Types

The XDR standard defines two floating-point data types: single-precision and double-precision floating points.

Single-Precision Floating Point

XDR defines the single-precision floating-point data type as a *float*. The length of a float is 32 bits, or 4 bytes. Floats are encoded using the IEEE standard for normalized single-precision floating-point numbers.

The single-precision floating-point number is declared as follows:

$$(-1)^{**S} * 2^{*(E-Bias)} * 1.F$$

- S Sign of the number. This 1-bit field specifies either 0 for positive or 1 for negative.
- E Exponent of the number in base 2. This field contains 8 bits. The exponent is biased by 127.
- F Fractional part of the number's mantissa in base 2. This field contains 23 bits.

See the Single-Precision Floating-Point figure (Figure 12 on page 87).

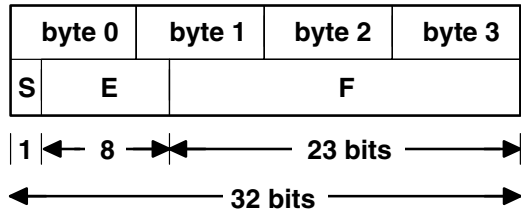

Single-Precision Floating Point

Figure 12. Single-Precision Floating-Point. The first line of this diagram lists bytes 0 through 3, with the most significant byte 0 first, and the least significant byte 3 last. The second line of the diagram shows the corresponding fields and their respective lengths: S (1 bit) and E (8 bits) extend under byte 0 and byte 1, while F (23 bits) extends from byte 1 to byte 3. The third line shows the total length of bytes 0 through 3, which is 32 bits.

The most and least significant bytes of an integer are 0 and 3. The most and least significant bits of a single-precision floating-point number are 0 and 31. The beginning (and most significant) bit offsets of S, E, and F are 0, 1, and 9, respectively. These numbers refer to the mathematical positions of the bits but *not* to their physical locations, which vary from medium to medium.

The IEEE specifications should be considered when encoding signed zero, signed infinity (overflow), and denormalized numbers (underflow). According to IEEE specifications, the NaN (not-a-number) is system-dependent and should not be used externally.

Double-Precision Floating Point

The XDR standard defines the encoding for the double-precision floating-point data type as a *double*. The length of a double is 64 bits or 8 bytes. Doubles are encoded using the IEEE standard for normalized double-precision floating-point numbers.

The double-precision floating-point data type is declared as follows:

$$(-1)**S * 2**(E-Bias) * 1.F$$

- S Sign of the number. This one-bit field specifies either 0 for positive or 1 for negative.
- E Exponent of the number in base 2. This field contains 11 bits. The exponent is biased by 1023.
- F Fractional part of the number's mantissa in base 2. This field contains 52 bits.

See the Double-Precision Floating Point figure (Figure 13).

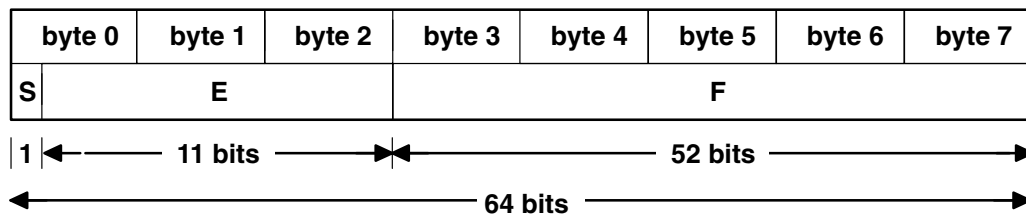

Double-Precision Floating Point

Figure 13. Double-Precision Floating-Point. The first line of this diagram lists bytes 0 through 7. The second line of the diagram shows the corresponding fields and their respective lengths: S (1 bit) and E (11 bits) extend under byte 0 through byte 2, while F (52 bits) extends from byte 3 to byte 7. The third line shows the total length of bytes 0 through 7, which is 64 bits.

The most and least significant bytes of a number are 0 and 3. The most and least significant bits of a double-precision floating-point number are 0 and 63. The beginning (and most significant) bit offsets of S, E, and F are 0, 1, and 12, respectively. These numbers refer to the mathematical positions of the bits but *not* to their physical locations, which vary from medium to medium.

The IEEE specifications should be consulted when encoding signed zero, signed infinity (overflow), and denormalized numbers (underflow). According to IEEE specifications, the NaN (not-a-number) is system-dependent and should not be used externally.

Opaque Data Types

The XDR standard defines two types of opaque data: fixed-length and variable-length opaque data.

Fixed-Length Opaque Data

XDR defines fixed-length uninterpreted data as *opaque*. Fixed-length opaque data is declared as follows:

```
opaque identifier[n];
```

The constant n is the static number of bytes necessary to contain the opaque data. If n is not a multiple of 4, then the n bytes are followed by enough (0 to 3) residual 0 bytes, r , to make the total byte count of the opaque object a multiple of 4. See the Fixed-Length Opaque figure (Figure 14).

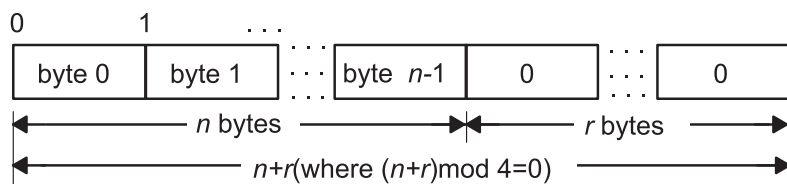

Fixed-Length Opaque

Figure 14. Fixed-Length Opaque. This diagram contains 4 lines of information. The second line of the diagram is the main line, listing bytes as follows: byte 0, byte 1, dots signifying the bytes between byte 1 and byte n-1. The next byte is labeled: byte n-1, and is followed by residual byte 0. Dots signify more residual bytes that end in a final byte 0. The remaining lines of the diagram describe this main line of bytes. The first line assigns numbers to the bytes as follows: number 0 for byte 0, number 1 for byte 1, and dots signifying a continuing sequence. The third line assigns byte values to the bytes in the main line as follows: byte 0 through byte n-1 yield n bytes. All the residual bytes together equal r bytes. The fourth line, which spans the entire diagram, shows the following equation: $n+r$ (where $(n+r) \bmod 4 = 0$).

Variable-Length Opaque Data

XDR also defines variable-length uninterpreted data as *opaque*. Variable-length (counted) opaque data is defined as a sequence of n arbitrary bytes, numbered 0 through $n-1$. Opaque data is encoded as an unsigned integer and followed by the n bytes of the sequence.

Byte m of the sequence always precedes byte $m+1$, and byte 0 of the sequence always follows the sequence length (count). Enough (0 to 3) residual 0 bytes, r , are added to make the total byte count a multiple of 4.

Variable-length opaque data is declared in one of the following forms:

```
opaque identifier<m>;
```

OR

```
opaque identifier<>;
```

The constant m denotes an upper bound for the number of bytes that the sequence can contain. If m is not specified, as in the second declaration, it is assumed to be $(2^{32}) - 1$, which is the maximum length. The constant m would normally be found in a protocol specification. See the Variable-Length Opaque figure (Figure 15 on page 89).

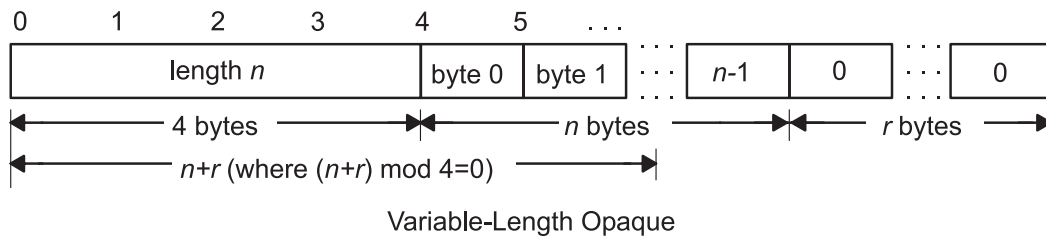

Figure 15. Variable-Length Opaque. This diagram contains 4 lines of information. The second line of the diagram is the main line, listing segments as follows: length n , byte 0, byte 1, and then dots signifying the bytes between byte 1 and byte $n-1$. The next byte is labeled: $n-1$, followed by residual byte 0. Dots signify more residual bytes that end in a final byte 0. The remaining lines of the diagram describe this main line. The first line assigns numbers as follows: numbers 0 through 3 for length n , number 4 for byte 0, number 5 for byte 1, and dots signifying a continuing sequence. The third line assigns byte values to the main line as follows: length n is 4 bytes, byte 0 through byte $n-1$ yield n bytes. All the residual bytes together equal r bytes. The fourth line, which spans the entire diagram, shows the following equation: $n+r$ (where $(n+r) \bmod 4 = 0$).

Note: Encoding a length n that is greater than the maximum described in the protocol specification causes an error.

Array Data Types

The XDR standard defines two type of arrays: fixed-length and variable-length.

Fixed-Length Array

Fixed-length arrays of homogeneous elements are declared as follows:

```
type-name identifier[n];
```

Fixed-length arrays of elements are encoded by individually coding the elements of the array in their natural order, 0 through $n-1$. Each element size is a multiple of 4 bytes. Although the elements are of the same type, they may have different sizes. For example, in a fixed-length array of strings, all elements are of the string type, yet each element varies in length. See the Fixed-Length Array figure (Figure 16).

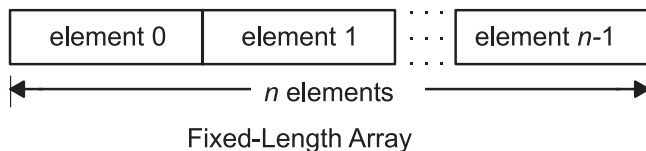

Figure 16. Fixed-Length Array. This diagram shows from the left, element 0, element 1, a series of dots to signify the elements between element 1 and element $n-1$. The length is equal to n elements.

Variable-Length Array

The XDR standard provides counted byte arrays for encoding variable-length arrays of homogeneous elements. The array is encoded as the element count n (an unsigned integer) followed by the encoding of each of the array's elements, starting with element 0 and progressing through element $n-1$.

Variable-length arrays are declared as follows:

```
type-name identifier<m>;
```

OR

```
type-name identifier<>;
```

The constant m specifies the maximum acceptable element count of an array. If m is not specified, it is assumed to be $(2^{**}32) - 1$. See the Variable-Length Array figure (Figure 17 on page 90).

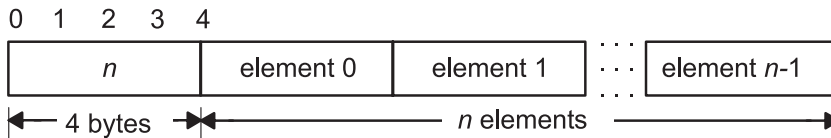

Variable-Length Array

Figure 17. Variable-Length Array. This diagram contains 3 lines of information. The second line of the diagram is the main line, listing the following: n , element 0, element 1, and a series of dots to signify a continuing sequence ending in element $n-1$. The first line of the diagram contains the numbers 0 through 4, with 0 on the first border of n and 4 on the shared border of n and element 0. The third line assigns values to parts of the main line as follows: n equals 4 bytes, and element 0 through element $n-1$ equal n elements.

Note: Encoding a length n greater than the maximum described in the protocol specification causes an error.

Strings

The XDR standard defines a string of n (numbered 0 through $n-1$) ASCII bytes to be the number n encoded as an unsigned integer and followed by the n bytes of the string. Byte m of the string always precedes byte $m+1$, and byte 0 of the string always follows the string length. If n is not a multiple of 4, then the n bytes are followed by enough (0 to 3) residual zero bytes, r , to make the total byte count a multiple of 4.

Counted byte strings are declared as one of the following:

```
string object< $m$ >;
```

OR

```
string object<>;
```

The constant m denotes an upper bound of the number of bytes that a string may contain. If m is not specified, as in the second declaration, it is assumed to be $(2^{32}) - 1$, which is the maximum length. The constant m would normally be found in a protocol specification. For example, a filing protocol may state that a file name can be no longer than 255 bytes, as follows:

```
string filename<255>;
```

See the Counted Byte String figure (Figure 18).

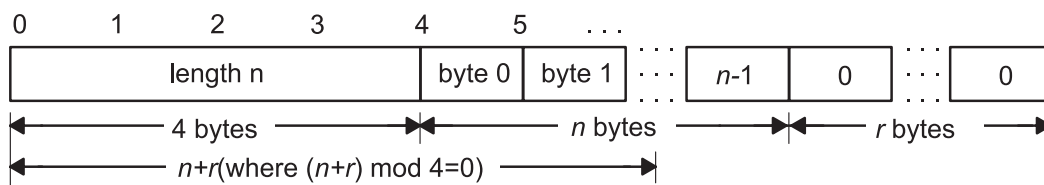

Counted Byte String

Figure 18. Counted Byte String. This diagram contains 4 lines of information. The second line of the diagram is the main line, listing as follows: length n , byte 0, byte 1, dots signifying the bytes between byte 1 and byte $n-1$. The next byte is labeled: $n-1$, followed by residual byte 0. Dots signify more residual bytes that end in a final byte 0. The remaining lines of the diagram describe this main line. The first line assigns numbers as follows: numbers 0 through 3 for length n , number 4 for byte 0, number 5 for byte 1, and dots signifying a continuing sequence. The third line assigns byte values to the main line as follows: length n is 4 bytes, byte 0 through byte $n-1$ equal n bytes. All the residual bytes together equal r bytes. The fourth line, which spans the entire diagram, shows the following equation: $n+r$ (where $(n+r) \bmod 4 = 0$).

Note: Encoding a length n greater than the maximum described in the protocol specification causes an error.

Structures

Using the primitive routines, the programmer can write unique XDR routines to describe arbitrary data structures such as elements of arrays, arms of unions, or objects pointed to from other structures. The structures themselves may contain arrays of arbitrary elements or pointers to other structures.

Structures are declared as follows:

```
struct {  
    component-declaration-A;  
    component-declaration-B;  
    ...  
} identifier;
```

In a structure, the components are encoded in the order of their declaration in the structure. Each component size is a multiple of four bytes, although the components may have different sizes. See the Structure figure (Figure 19).

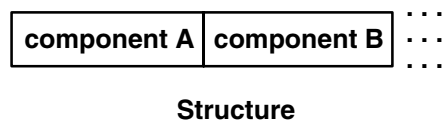

Figure 19. Structure. This diagram shows a line of components side by side as follows: component A, component B, and dots signifying a continuing sequence.

Discriminated Unions

A *discriminated union* is a union data structure that holds various objects, with one of the objects identified directly by a discriminant. The discriminant is the first item to be serialized or deserialized. A discriminated union includes both a discriminant and a component. The type of discriminant is either integer, unsigned integer, or an enumerated type, such as **bool**. The component is selected from a set of types that are prearranged according to the value of the discriminant. The component types are called *arms* of the union. The arms of a discriminated union are preceded by the value of the discriminant that implies their encoding. See “Using an XDR Discriminated Union Example” on page 107.

Discriminated unions are declared as follows:

```
union switch (discriminant-declaration) {  
    case discriminant-value-A:  
        arm-declaration-A;  
    case discriminant-value-B:  
        arm-declaration-B;  
    ...  
    default: default-declaration;  
} identifier;
```

Each **case** keyword is followed by a legal value of the discriminant. The default arm is optional. If an arm is not specified, a valid encoding of the union cannot take on unspecified discriminant values. The size of the implied arm is always a multiple of four bytes.

The discriminated union is encoded as the discriminant, followed by the encoding of the implied arm.

See the Discriminated Union figure (Figure 20 on page 92).

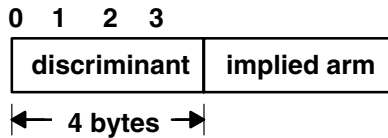

Discriminated Union

Figure 20. Discriminated Union. This diagram shows a discriminant (which is 4 bytes) and an implied arm side by side.

Voids

An XDR *void* is a zero-byte quantity. Voids are used for describing operations that take no data as input or output. Voids are also useful in unions, where some arms contain data and others do not.

The declaration for a void follows:

```
void;
```

Voids are illustrated as follows:

```
++
 | |
++
--><-- 0 bytes
```

Constants

A *constant* is used to define a symbolic name for a constant, and it does not declare any data. The symbolic constant can be used anywhere a regular constant is used.

The data declaration for a constant follows this form:

```
const name-identifier = n;
```

The following example defines a symbolic constant, DOZEN, that is equal to 12:

```
const DOZEN = 12;
```

Type Definitions

A type definition (a **typedef** statement) does not declare any data, but serves to define new identifiers for declaring data.

The syntax for a type definition is:

```
typedef declaration;
```

The new type name is the variable name in the declaration part of the type definition. For example, the following defines a new type called `eggbox`, using an existing type called `egg`:

```
typedef egg eggbox[DOZEN];
```

Variables declared using the new type name are equivalent to variables declared using the existing type. For example, the following two declarations for the variable `fresheggs` are equivalent:

```
eggbox fresheggs;
egg    fresheggs[DOZEN];
```

A type definition can also have the following form:

```
typedef <<struct, union, or enum definition>> identifier;
```

An alternative type definition form is preferred for structures, unions, and enumerations. The type definition form can be converted to the alternative form by removing the **typedef** keyword and placing the identifier after the **struct**, **union**, or **enum** keyword, instead of at the end. For example, here are the two ways to define the type **bool**:

```
enum bool {          /* preferred alternative */
FALSE = 0,
TRUE = 1
};
```

OR

```
typedef enum {F=0, T=1} bool;
```

The first syntax is preferred because the programmer does not have to wait until the end of a declaration to determine the name of the new type.

Optional Data

Optional data is a type of union that occurs so frequently it has its own syntax. The optional data type is closely coordinated to the representation of recursive data structures by the use of pointers in high-level languages, such as C or Pascal. The syntax for pointers is the same as that for C language.

The syntax for optional data is as follows:

```
type-name *identifier;
```

The declaration for optional data is equivalent to the following union:

```
union switch (bool opted) {
    case TRUE:
        type-name element;
    case FALSE:
        void;
} identifier;
```

Because `bool opted` can be interpreted as the length of the array, the declaration for optional data is also equivalent to the following variable-length array declaration:

```
type-name identifier<1>;
```

Optional data is very useful for describing recursive data structures such as linked lists and trees. For example, the following defines a **stringlist** type that encodes lists of arbitrary length strings:

```
struct *stringlist {
    string item<>;
    stringlist next;
};
```

The example can be equivalently declared as a union, as follows:

```
union stringlist switch (bool opted) {
    case TRUE:
        struct {
            string item<>;
            stringlist next;
        } element;
    case FALSE:
        void;
};
```

The example can also be declared as a variable-length array, as follows:

```
struct stringlist<1> {
    string item<>;
    stringlist next;
};
```

Because both the union and the array declarations obscure the intention of the **stringlist** type, the optional data declaration is preferred.

List of XDR Programming References

The list of eXternal Data Representation (XDR) programming references includes:

- “XDR Library Filter Primitives”
- “XDR Library Non-Filter Primitives”
- “Examples” on page 95

XDR Library Filter Primitives

xdr_array	Translates between variable-length arrays and their corresponding external representations.
xdr_bool	Translates between Booleans and their external representations.
xdr_bytes	Translates between internal counted byte string arrays and their external representations.
xdr_char	Translates between C language characters and their external representations.
xdr_double	Translates between C language double-precision numbers and their external representations.
xdr_enum	Translates between C language enumerations and their external representations.
xdr_float	Translates between C language floats and their external representations.
xdr_int	Translates between C language integers and their external representations.
xdr_long	Translates between C language long integers and their external representations.
xdr_opaque	Translates between opaque data and its external representation.
xdr_reference	Provides pointer chasing within structures.
xdr_short	Translates between C language short integers and their external representations.
xdr_string	Translates between C language strings and their external representations.
xdr_u_char	Translates between unsigned C language characters and their external representations.
xdr_u_int	Translates between C language unsigned integers and their external representations.
xdr_u_long	Translates between C language unsigned long integers and their external representations.
xdr_u_short	Translates between C language unsigned short integers and their external representations.
xdr_union	Translates between discriminated unions and their external representations.
xdr_vector	Translates between fixed-length arrays and their corresponding external representations.
xdr_void	Supplies an XDR subroutine to the Remote Procedure Call (RPC) system without transmitting data.
xdr_wrapstring	Calls the xdr_string subroutine.

XDR Library Non-Filter Primitives

xdr_destroy	Destroys the XDR stream pointed to by the <i>xdrs</i> parameter.
xdr_free	Deallocates or frees memory.
xdr_getpos	Returns an unsigned integer that describes the current position in the data stream.
xdr_inline	Returns a pointer to an internal piece of the buffer of a stream, pointed to by the <i>xdrs</i> parameter.
xdr_pointer	Provides pointer chasing within structures and serializes null pointers.
xdr_setpos	Changes the current position in the XDR stream.
xdrmem_create	Initializes in local memory the XDR stream pointed to by the <i>xdrs</i> parameter.
xdrrec_create	Provides an XDR stream that can contain long sequences of records.
xdrrec_endofrecord	Causes the current outgoing data to be marked as a record.
xdrrec_eof	Checks the buffer for an input stream.

xdrrec_skiprecord	Causes the position of an input stream to move to the beginning of the next record.
xdrstdio_create	Initializes the XDR data stream pointed to by the <i>xdrs</i> parameter.

Examples

See the following examples:

- “Passing Linked Lists Using XDR Example” on page 100
- “Using an XDR Data Description Example” on page 102
- “Showing the Justification for Using XDR Example” on page 103
- “Using XDR Example” on page 105
- “Using XDR Array Examples” on page 106
- “Using an XDR Discriminated Union Example” on page 107
- “Showing the Use of Pointers in XDR Example” on page 108

XDR Library Filter Primitives

The eXternal Data Representation (XDR) primitives are subroutines that define the basic and constructed data types. The XDR language provides programmers with a specification for uniform representations that includes filter primitives for basic and constructed data types. The basic data types include integers, enumerations, Booleans, hyperintegers, floating points, and void data. The constructed data types include strings, structures, byte arrays, arrays, opaque data, unions, and pointers.

The XDR standard translates both basic and constructed data types. For basic data types, XDR provides basic filter primitives (see “XDR Basic Filter Primitives”) that serialize information from the local host’s representation to the XDR representation and deserialize information from the XDR representation to the local host’s representation. For constructed data types, XDR provides constructed filter primitives (see “XDR Constructed Filter Primitives” on page 96) that allow the use of basic data types, such as integers and floating-point numbers, to create more complex constructs such as arrays and discriminated unions.

Remote Procedure Calls (RPCs) use XDR to establish uniform representations for data types to transfer the call message data between machines. Although the XDR constructs resemble the C programming language, C language constructs define the code for programs. XDR, however, standardizes the representation of data types directly in the programming code.

XDR Basic Filter Primitives

The XDR primitives are subroutines that define the basic and constructed data types. The basic data type filter primitives include the following:

- “Number Filter Primitives”
- “Floating-Point Filter Primitives” on page 96
- “Enumeration Filter Primitives” on page 96
- “Passing No Data” on page 96

Number Filter Primitives

The XDR library provides basic filter primitives that translate between types of numbers and their external representations. The XDR number filters cover signed and unsigned integers, as well as signed and unsigned short and long integers.

The subroutines for the XDR number filters are:

xdr_int	Translates between C language integers and their external representations.
xdr_u_int	Translates between C language unsigned integers and their external representations.

xdr_long	Translates between C language long integers and their external representations.
xdr_u_long	Translates between C language unsigned long integers and their external representations.
xdr_short	Translates between C language short integers and their external representations.
xdr_u_short	Translates between C language unsigned short integers and their external representations.

Floating-Point Filter Primitives

The XDR library provides primitives that translate between floating-point data and their external representations. Floating-point data encodes an integer with an exponent. Floats and double-precision numbers compose floating-point data.

Note: Numbers are represented as IEEE standard floating points. Subroutines may fail when decoding IEEE representations into machine-specific representations, or vice versa.

The subroutines for the XDR floating-point filters are:

xdr_double	Translates between C language double-precision numbers and their external representations.
xdr_float	Translates between C language floats and their external representations.

Enumeration Filter Primitives

The XDR library provides a primitive for generic enumerations based on the assumption that a C enumeration value (**enum**) has the same representation. There is a special enumeration in XDR known as the *Boolean*.

The subroutines for the XDR library enumeration filters are:

xdr_bool	Translates between Booleans and their external representations.
xdr_enum	Translates between C language enumerations and their external representations.

Passing No Data

Sometimes an XDR subroutine must be supplied to the RPC system, but no data is required or passed. The XDR library provides the following primitive for this function:

xdr_void	Supplies an XDR subroutine to the RPC system without transmitting data.
-----------------	---

XDR Constructed Filter Primitives

The XDR filter primitives are subroutines that define the basic and constructed data types. Constructed data type filters allow complex data types to be created from basic data types. Constructed data types require more parameters to perform more complicated functions than do basic data types. Memory management is an example of a more complicated function that can be performed with the constructed primitives. Memory is allocated when deserializing data with the **xdr_decode** subroutine. Memory is deallocated through the **xdr_free** subroutine.

The constructed data-type filter primitives include the following:

- “String Filter Primitives” on page 97
- “Array Filter Primitives” on page 97
- “Opaque-Data Filter Primitives” on page 97
- “Primitive for Pointers to Structures” on page 97
- “Primitive for Discriminated Unions” on page 98

String Filter Primitives

A *string* is a constructed filter primitive that consists of a sequence of bytes terminated by a null byte. The null byte does not figure into the length of the string. Externally, strings are represented by a sequence of ASCII characters. Internally, XDR uses the `char *` designation to represent pointers to strings.

The XDR library includes primitives for the following string routines:

xdr_string	Translates between C language strings and their external representations.
xdr_wrapstring	Calls the xdr_string subroutine.

Array Filter Primitives

Arrays are constructed filter primitives and can be either generic arrays or byte arrays. The XDR library provides filter primitives for handling both types of arrays.

Generic Arrays: Generic arrays consist of arbitrary elements. Generic arrays are handled in much the same way as byte arrays, which handle a subset of generic arrays where the size of the arbitrary elements is 1, and their external descriptions are predetermined. The primitive for generic arrays requires an additional parameter to define the size of the element in the array and to call an XDR subroutine to encode or decode each element in the array.

The XDR library includes the following subroutines for generic arrays:

xdr_array	Translates between variable-length arrays and their corresponding external representations.
xdr_vector	Translates between fixed-length arrays and their corresponding external representations.

Byte Arrays: The XDR library provides a primitive for byte arrays. Although similar to strings, byte arrays differ by having a byte count. That is, the length of the array is set by an unsigned integer. They also differ in that byte arrays are not terminated with a null character. External and internal representations of byte arrays are the same.

The XDR library includes the following subroutine for byte arrays:

xdr_bytes	Translates between counted byte string arrays and their external representations.
------------------	---

Opaque-Data Filter Primitives

Opaque data is composed of bytes of a fixed size that are not interpreted as they pass through the data streams. Opaque data bytes, such as handles, are passed between server and client without being inspected by the client. The client uses the data as it is and then returns it to the server. By definition, the actual data contained in the opaque object is not portable between computers.

The XDR library includes the following subroutine for opaque data:

xdr_opaque	Translates between opaque data and its external representation.
-------------------	---

Primitive for Pointers to Structures

The XDR library provides a primitive for pointers so that structures referenced within other structures can be easily serialized, deserialized, and freed. The XDR library includes the following subroutine for pointers to structures:

xdr_reference	Provides pointer chasing within structures.
----------------------	---

Primitive for Discriminated Unions

A discriminated union is a C language union, which is an object that holds several data types. One arm of the union is an enumeration value, or discriminant, that holds a specific object to be processed over the system first. The discriminant is an enumeration value (**enum_t**).

The XDR library includes the following subroutine for discriminated unions:

xdr_union Translates between discriminated unions and their external representations.

XDR Non-Filter Primitives

The eXternal Data Representation (XDR) nonfilter primitives are used to create, manipulate, implement, and destroy XDR data streams. These primitives allow programmers to destroy a data stream (freeing its private structure) for example, or change a data stream position.

The following sections are discussed in this section:

- “Creating and Using XDR Data Streams”
- “Manipulating an XDR Data Stream” on page 99
- “Implementing an XDR Data Stream” on page 99
- “Destroying an XDR Data Stream” on page 100

Creating and Using XDR Data Streams

XDR data streams are obtained by calling creation subroutines that take arguments specifically designed to the properties of the stream. There are existing XDR data streams for serializing or deserializing data in standard input and output streams, memory streams, and record streams.

Note: Remote Procedure Call (RPC) clients do not have to create XDR streams because the RPC system creates and passes these streams to the client.

The types of data streams include standard I/O streams, memory streams, and record streams.

Standard I/O Streams

XDR data streams serialize and deserialize standard input and output by calling the standard I/O creation subroutine to initialize the XDR data stream pointed to by the *xdrs* parameter.

The XDR library includes the following subroutine for standard I/O data streams:

xdrstdio_create Initializes the XDR data stream pointed to by the *xdrs* parameter.

Memory Streams

XDR data streams serialize and deserialize data from memory by calling the XDR memory creation subroutine to initialize in local memory the XDR stream pointed to by the *xdrs* parameter. In RPC, the User Datagram Protocol (UDP) Internet Protocol (IP) implementation uses this subroutine to build entire call-and-reply messages in memory before sending a message to the recipient.

The XDR library includes the following subroutine for memory data streams:

xdrmem_create Initializes in local memory the XDR stream pointed to by the *xdrs* parameter.

Record Streams

Record streams are XDR streams built on top of record fragments, which are built on TCP/IP streams. TCP/IP is a connection protocol for transporting large streams of data at one time, instead of transporting a single data packet at a time.

Record streams are primarily used to make connections between remote procedure calls and TCP. They can also be used to stream data into or out of normal files.

XDR provides the following subroutines for use with record streams:

xdrrec_create	Provides an XDR stream that can contain long sequences of records.
xdrrec_endofrecord	Causes the current outgoing data to be marked as a record.
xdrrec_eof	Checks the buffer for an input stream that identifies the end of file (EOF).
xdrrec_skiprecord	Causes the position of an input stream to move to the beginning of the next record.

Manipulating an XDR Data Stream

XDR provides the following subroutines for describing and changing data stream position:

xdr_getpos	Returns an unsigned integer that describes the current position of the data stream.
xdr_setpos	Changes the current position of the data stream.

Implementing an XDR Data Stream

Programmers can create and implement XDR data streams. The following example shows the abstract data types (XDR handle) required. The example contains operations being applied to the stream, an operation vector for the implementation, and two private fields for use by the implementation.

```
enum xdr_op { XDR_ENCODE=0, XDR_DECODE=1, XDR_FREE=2 };
typedef struct {
    enum xdr_op x_op;
    struct xdr_ops {
        bool_t (*x_getlong) ();
        bool_t (*x_putlong) ();
        bool_t (*x_getbytes) ();
        bool_t (*x_putbytes) ();
        u_int (*x_getpostn) ();
        bool_t (*x_setpostn) ();
        caddr_t (*x_inline) ();
        VOID (*x_destroy) ();
    } *XOp;
    caddr_t x_public;
    caddr_t x_private;
    caddr_t x_base;
    int x_handy;
} XDR;
```

The following parameters are pointers to XDR stream manipulation subroutines:

<i>x_destroy</i>	Frees private data structures.
<i>x_getbytes</i>	Gets bytes from the data stream.
<i>x_getlong</i>	Gets long integer values from the data stream.
<i>x_getpostn</i>	Returns stream offset.
<i>x_inline</i>	Points to internal data buffer, which can be used for any purpose.
<i>x_putbytes</i>	Puts bytes into the data stream.
<i>x_putlong</i>	Puts long integer values into the data stream.
<i>x_setpostn</i>	Repositions offset.
<i>XOp</i>	Specifies the current operation being performed on the stream. This field is important to the XDR primitives. However, the stream's implementation does not depend on the value of this parameter.

The following fields are specific to a stream's implementation:

<i>x_base</i>	Contains position information in the data stream that is private to the user implementation.
---------------	--

<code>x_handy</code>	Contains extra information, as necessary.
<code>x_public</code>	Specifies user data that is private to the stream's implementation and is not used by the XDR primitive.
<code>x_private</code>	Points to the private data.

Destroying an XDR Data Stream

The following subroutine destroys a specific XDR data stream:

xdr_destroy Destroys the XDR data stream pointed to by the *xdrs* parameter, freeing the private data structures allocated to the stream.

The use of the XDR data stream handle is undefined after it is destroyed.

Passing Linked Lists Using XDR Example

Linked lists of arbitrary length can be passed using eXternal Data Representation (XDR). To help illustrate the functions of the XDR routine for encoding, decoding, or freeing linked lists, this example creates a data structure and defines its associated XDR routine.

“Using XDR Example” on page 105 presents a C data structure and its associated XDR routines for an individual's gross assets and liabilities. The example is duplicated below:

```
struct gnumbers {
    long g_assets;
    long g_liabilities;
};
bool_t
xdr_gnumbers (xdrs, gp)
    XDR *xdrs;
    struct gnumbers *gp;
{
    if (xdr_long (xdrs, &(gp->g_assets)))
        return (xdr_long (xdrs, &( gp->g_liabilities)));
    return(FALSE);
}
```

xdrs Points to the XDR data stream handle.

gp Points to the address of the structure that provides the data to or from the XDR stream.

For implementing a linked list of such information, a data structure could be constructed as follows:

```
struct gnumbers_node {
    struct gnumbers gn_numbers;
    struct gnumbers_node *gn_next;
};
typedef struct gnumbers_node *gnumbers_list;
```

The head of the linked list can be thought of as the data object; that is, the head is not merely a convenient shorthand for a structure. Similarly, the *gn_next* field indicates whether or not the object has terminated. However, if the object continues, the *gn_next* field also specifies the address where it continues. The link addresses carry no useful information when the object is serialized.

The XDR data description of this linked list can be described by the recursive declaration of the *gnumbers_list* field, as follows:

```
struct gnumbers {
    int g_assets;
    int g_liabilities;
};
```

```

struct gnumbers_node {
    gnumbers gn_numbers;
    gnumbers_node *gn_next;
};

```

In the following description, the Boolean indicates if more data follows it. If the Boolean is a False value, it is the last data field of the structure. If it is a True value, it is followed by a **gnumbers** structure and, recursively, by a **gnumbers_list**. The C declaration has no Boolean explicitly declared in it (though the `gn_next` field implicitly carries the information), while the XDR data description has no pointer explicitly declared in it.

Hints for writing the XDR routines for a **gnumbers_list** structure follow easily from the previous XDR description. The following primitive, **xdr_pointer**, implements the previous XDR union:

```

bool_t
xdr_gnumbers_node (xdrs, gn)
    XDR *xdrs;
    gnumbers_node *gn;
{
    return (xdr_gnumbers (xdrs, &gn->gn_numbers) &&
           xdr_gnumbers_list (xdrs, &gn->gn_next));
}

bool_t
xdr_gnumbers_list (xdrs, gnp)
    XDR *xdrs;
    gnumbers_list *gnp;
{
    return (xdr_pointer (xdrs, gnp,
                        SizeOf(struct gnumbers_node),
                        xdr_gnumbers_node));
}

```

As a result of using XDR on a list with these subroutines, the C stack grows linearly with respect to the number of nodes in the list. This is due to the recursion. The following subroutine collapses the previous two recursive programs into a single, nonrecursive one:

```

bool_t
xdr_gnumbers_list (xdrs, gnp)
    XDR *xdrs;
    gnumbers_list *gnp;
{
    bool_t more_data;
    gnumbers_list *nextp;
    for (;;) {
        more_data = (*gnp != NULL);
        if (!xdr_bool (xdrs, &more_data)) {
            return (FALSE);
        }
        if (!more_data) {
            break;
        }
        if (xdrs->x_op == XDR_FREE) {
            nextp = &(*gnp)->gn_next;
        }
        if (!xdr_reference (xdrs, gnp,
                          sizeof (struct gnumbers_node), xdr_gnumbers)) {
            return (FALSE);
        }
        gnp = xdrs->x_op == XDR_FREE ?
            nextp : &(*gnp)->gn_next;
    }
    *gnp = NULL;
    return (TRUE)
}

```

The first statement determines whether more data exists, so that this Boolean information can be serialized. This statement is unnecessary in the XDR_DECODE case, because the value of the `more_data` field is not known until the next statement deserializes it.

The next statement translates the `more_data` field of the XDR union. If no more data exists, set this last pointer to Null to indicate the end of the list and return True because the operation is done.

Note: Setting the pointer to Null is important only in the XDR_ENCODE case because the pointer is already null in the XDR_ENCODE and XDR_FREE cases.

Next, if the direction is XDR_FREE, the value of the `nextp` field is set to indicate the location of the next pointer in the list. This step dereferences the `gnp` field to find the location of the next item in the list. After the next statement, the storage pointed to by `gnp` is freed and no longer valid. This step is not taken for all directions because, in the XDR_DECODE direction, the value of the `gnp` field will not be set until the next statement.

The next statement translates the data in the node using the `xdr_reference` primitive. The `xdr_reference` subroutine is similar to the `xdr_pointer` subroutine, used previously, but it does not send over the Boolean indicating whether there is more data. The program uses the `xdr_reference` subroutine instead of the `xdr_pointer` subroutine because the information is already translated by XDR. Notice that the XDR subroutine passed is not the same type as an element in the list. The subroutine passed is `xdr_gnumbers`, for translating `gnumbers`, but each element in the list is actually of the `gnumbers_node` type. The `xdr_gnumbers_gnode` subroutine is not passed because it is recursive. The program instead uses `xdr_gnumbers`, which translates all nonrecursive portions.

Note: This method works only if the `gn_numbers` field is the first item in each element, so that their addresses are identical when passed to the `xdr_reference` primitive.

Finally, the program updates the `gnp` field to point to the next item in the list. If the direction is XDR_FREE, it is set to the previously saved value. Otherwise, the program dereferences the `gnp` field to get the proper value. Though harder to understand than the recursive version, this nonrecursive subroutine is far less likely to cause errors in the C stack. The nonrecursive subroutine also runs more efficiently because much procedure call overhead has been removed. For small lists, containing hundreds of items or less, the recursive version of the subroutine should be sufficient.

Using an XDR Data Description Example

The following short eXternal Data Representation (XDR) data description of a file can be used to transfer files from one machine to another:

```
const MAXUSERNAME = 32;    /* max length of a user name */
const MAXFILELEN = 65535; /* max length of a file */
const MAXNAMELEN = 255;   /* max length of a file name */
/*
 * Types of files:
 */
enum filekind {
    TEXT = 0,    /* ascii data */
    DATA = 1,   /* raw data */
    EXEC = 2     /* executable */
};
/*
 * File information, per kind of file:
 */
union filetype switch (filekind kind) {
    case TEXT:
        void;          /* no extra information */
    case DATA:
        string creator<MAXNAMELEN>; /* data creator */
    case EXEC:

```



```

        string interpretor<MAXNAMELEN>; /* program interpretor */
};
/*
 * A complete file:
 */
struct file {
    string filename<MAXNAMELEN>; /* name of file */
    filetype type; /* info about file */
    string owner<MAXUSERNAME>; /* owner of file */
    opaque data<MAXFILELEN>; /* file data */
};

```

If a user named john wants to store his sillyprog LISP program, which contains just the data (quit), his file can be encoded as follows:

Offset	Hex Bytes	ASCII	Description
0	00 00 00 09	...	Length of file name = 9
4	73 69 6c 6c	sill	File name characters
8	79 70 72 6f	ypro	... and more characters ...
12	67 00 00 00	g...	... and 3 zero-bytes of fill
16	00 00 00 02	...	File type is EXEC = 2
20	00 00 00 04	...	Length of owner = 4
24	6c 69 73 70	lisp	Interpretor characters
28	00 00 00 04	...	Length of owner = 4
32	6a 6f 68 6e	john	Owner characters
36	00 00 00 06	...	Length of file data = 6
40	28 71 75 69	(qui	File data bytes ...
44	74 29 00 00	t)..	... and 2 zero-bytes of fill

Showing the Justification for Using XDR Example

Consider two programs, **writer** and **reader**. The **writer** program is written as follows:

```

#include <stdio.h>
main() /* writer.c */
{
    long i;
    for (i = 0; i < 8; i++) {
        if (fwrite((char *)&i, sizeof(i), 1, stdout) != 1) {
            fprintf(stderr, "failed!\n");
            exit(1);
        }
    }
    exit(0);
}

```

The **reader** program is written as follows:

```

#include <stdio.h>
main() /* reader.c */
{
    long i, j;
    for (j = 0; j < 8; j++) {
        if (fread((char *)&i, sizeof(i), 1, stdin) != 1) {
            fprintf(stderr, "failed!\n");
            exit(1);
        }
        printf("%ld ", i);
    }
}

```

```

    }
    printf("\n");
    exit(0);
}

```

The two programs appear to be portable because they pass **lint** checking and exhibit the same behavior when executed on two different hardware architectures, such as an IBM machine and a VAX machine.

Piping the output of the **writer** program to the **reader** program gives identical results on an IBM machine or a VAX machine, as follows:

```

ibm%  writer | reader
0 1 2 3 4 5 6 7
ibm%
vax%  writer | reader
0 1 2 3 4 5 6 7
vax%

```

The following output results if the first program produces data on an IBM machine and the second consumes data on a VAX machine:

```

ibm%  writer | rsh vax reader
0 16777216 33554432 50331648 67108864 83886080 100663296
117440512
ibm%

```

Executing the **writer** program on the VAX machine and the **reader** program on the IBM machine produces results identical to the previous example. These results occur because the byte ordering of long integers differs between the VAX machine and the IBM machine, even though word size is the same.

Note: The value 16777216 equals 2^{24} . When 4 bytes are reversed, the 1 winds up in the 24th bit.

Data must be portable when shared by two or more machine types. Programs can be made data-portable by replacing the **read** and **write** system calls with calls to the **xdr_long** subroutine, which is a filter that interprets the standard representation of a long integer in its external form.

Following is the revised version of the **writer** program:

```

#include <stdio.h>
#include <rpc/rpc.h> /* xdr is a sub-library of rpc */
main() /* writer.c */
{
    XDR xdrs;
    long i;
    xdrstdio_create(&xdrs, stdout, XDR_ENCODE);
    for (i = 0; i < 8; i++) {
        if (!xdr_long(&xdrs, &i)) {
            fprintf(stderr, "failed!\n");
            exit(1);
        }
    }
    exit(0);
}

```

Following is the result of the **reader** program:

```

#include <stdio.h>
#include <rpc/rpc.h> /* xdr is a sub-library of rpc */
main() /* reader.c */
{
    XDR xdrs;
    long i, j;
    xdrstdio_create(&xdrs, stdin, XDR_DECODE);
    for (j = 0; j < 8; j++) {
        if (!xdr_long(&xdrs, &i)) {

```

```

        fprintf(stderr, "failed!\n");
        exit(1);
    }
    printf("%ld ", i);
}
printf("\n");
exit(0);
}

```

The new programs, executed on an IBM machine, then on a VAX machine, and then from an IBM to a VAX, yield the following results:

```

ibm%  writer | reader
0 1 2 3 4 5 6 7
ibm%
vax%  writer | reader
0 1 2 3 4 5 6 7
vax%
ibm%  writer | rsh vax reader
0 1 2 3 4 5 6 7
ibm%

```

Integers are one type of portable data. Arbitrary data structures present portability problems, particularly with respect to alignment and pointers. Alignment on word boundaries can cause the size of a structure to vary from machine to machine. Pointers, though convenient to use, have meaning only on the machine where they are defined.

Using XDR Example

Assume that a person's gross assets and liabilities are to be exchanged among processes. Also, assume that these values are important enough to warrant their own data type:

```

struct gnumbers {
    long g_assets;
    long g_liabilities;
};

```

The corresponding eXternal Data Representaton (XDR) routine describing this structure would be:

```

bool_t      /* TRUE is success, FALSE is failure */
xdr_gnumbers(xdrs, gp)
    XDR *xdrs;
    struct gnumbers *gp;
{
    if (xdr_long(xdrs, &gp->g_assets) &&
        xdr_long(xdrs, &gp->g_liabilities))
        return(TRUE);
    return(FALSE);
}

```

The *xdrs* parameter is neither inspected nor modified before being passed to the subcomponent routines. However, programs should always inspect the return value of each XDR routine call, and immediately give up and return False if the subroutine fails.

This example also shows that the **bool_t** type is declared as an integer whose only values are TRUE (1) and FALSE (0). This document uses the following definitions:

```

#define bool_t    int
#define TRUE      1
#define FALSE     0

```

Keeping these conventions in mind, the **xdr_gnumbers** routine can be rewritten as follows:

```

xdr_gnumbers(xdrs, gp)
    XDR *xdrs;
    struct gnumbers *gp;
{
    return(xdr_long(xdrs, &gp->g_assets) &&
           xdr_long(xdrs, &gp->g_liabilities));
}

```

Using XDR Array Examples

The following four examples illustrate eXternal Data Representation (XDR) arrays.

Example A

A user on a networked machine can be identified by the machine name (using the **gethostname** subroutine), the user's UID (using the **geteuid** subroutine), and the numbers of the group to which the user belongs (using the **getgroups** subroutine). A structure with this information and its associated XDR subroutine could be coded as follows:

```

struct netuser {
    char    *nu_machinename;
    int     nu_uid;
    u_int   nu_glen;
    int     *nu_gids;
};
#define NLEN 255    /* machine names < 256 chars */
#define NGRPS 20   /* user can't be in > 20 groups */
bool_t
xdr_netuser(xdrs, nup)
    XDR *xdrs;
    struct netuser *nup;
{
    return(xdr_string(xdrs, &nup->nu_machinename, NLEN) &&
           xdr_int(xdrs, &nup->nu_uid) &&
           xdr_array(xdrs, &nup->nu_gids, &nup->nu_glen,
                     NGRPS, sizeof (int), xdr_int));
}

```

Example B

To code a subroutine to use fixed-length arrays, rewrite Example A as follows:

```

#define NLEN 255
#define NGRPS 20
struct netuser {
    char *NUMachineName;
    int nu_uid;
    int nu_gids;
};
bool_t
xdr_netuser (XDRS, nup
    XDR *xdrs;
    struct netuser *nup;
{
    int i;
    if (!xdr_string(xdrs,&nup->NUMachineName, NLEN))
        return (FALSE);
    if (!xdr_int (xdrs, &nup->nu_uid))
        return (FALSE);
    for (i = 0; i < NGRPS; i++) {
        if (!xdr_int (xdrs, &nup->nu_uids[i]))
            return (FALSE);
    }
    return (TRUE);
}

```

Example C

A party of network users can be implemented as an array in the **netuser** structure. The declaration and its associated XDR routines are as follows:

```
struct party {
    u_int p_len;
    struct netuser *p_nusers;
};
#define PLEN 500 /* max number of users in a party */
bool_t
xdr_party(xdrs, pp)
    XDR *xdrs;
    struct party *pp;
{
    return(xdr_array(xdrs, &pp->p_nusers, &pp->p_len, PLEN,
        sizeof(struct netuser), xdr_netuser));
}
```

Example D

The **main** function's well-known parameters, *argc* and *argv*, can be combined into a structure. An array of these structures can make up a history of commands. The declarations and XDR routines can have the following syntax:

```
struct cmd {
    u_int c_argc;
    char **c_argv;
};
#define ALEN 1000 /* args cannot be > 1000 chars */
#define NARGC 100 /* commands cannot have > 100 args */
struct history {
    u_int h_len;
    struct cmd *h_cmds;
};
#define NCMDS 75 /* history is no more than 75 commands */
bool_t
xdr_wrap_string(xdrs, sp)
    XDR *xdrs;
    char **sp;
{
    return(xdr_string(xdrs, sp, ALEN));
}
bool_t
xdr_cmd(xdrs, cp)
    XDR *xdrs;
    struct cmd *cp;
{
    return(xdr_array(xdrs, &cp->c_argv, &cp->c_argc, NARGC,
        sizeof(char *), xdr_wrap_string));
}
bool_t
xdr_history(xdrs, hp)
    XDR *xdrs;
    struct history *hp;
{
    return(xdr_array(xdrs, &hp->h_cmds, &hp->h_len, NCMDS,
        sizeof(struct cmd), xdr_cmd));
}
```

Using an XDR Discriminated Union Example

If the type of a union can be an **integer**, **string** (a character pointer), or **gnumbers** structure, and the union and its current type are declared in a structure, the following declaration applies:

```

enum utype { INTEGER=1, STRING=2, GNUMBERS=3 };
struct u_tag {
    enum utype utype; /* the union's discriminant */
    union {
        int ival;
        char *pval;
        struct gnumbers gn;
    } uval;
};

```

The following constructs and eXternal Data Representation (XDR) procedure serialize and deserialize the discriminated union:

```

struct xdr_discrim u_tag_arms[4] = {
    { INTEGER, xdr_int },
    { GNUMBERS, xdr_gnumbers },
    { STRING, xdr_wrap_string },
    { __dontcare__, NULL }
    /* always terminate arms with a NULL xdr_proc */
}
bool_t
xdr_u_tag(xdrs, utp)
    XDR *xdrs;
    struct u_tag *utp;
{
    return(xdr_union(xdrs, &utp->utype, &utp->uval,
        u_tag_arms, NULL));
}

```

The **xdr_gnumbers** subroutine is presented in the “Passing Linked Lists Using XDR Example” on page 100. The **xdr_wrap_string** subroutine is presented in Example D of “Using XDR Array Examples” on page 106. The default *arms* parameter to the *xdr_union* parameter is NULL in this example. Therefore, the value of the union’s discriminant may legally take on only values listed in the *u_tag_arms* array. This example also demonstrates that the elements of the *arms* array do not need to be sorted.

The values of the discriminant may be sparse (though not in this example). It is good practice assigning explicit integer values to each element of the discriminant’s type. This practice documents the external representation of the discriminant and guarantees that different C compilers emit identical discriminant values.

Showing the Use of Pointers in XDR Example

If a structure contains a person’s name and a pointer to a **gnumbers** structure, which in turn specifies the person’s gross assets and liabilities, the structure can be written as follows:

```

struct pgn {
    char *name;
    struct gnumbers *gnp;
};

```

The corresponding eXternal Data Representation (XDR) routine for this structure is:

```

bool_t
xdr_pgn(xdrs, pp)
    XDR *xdrs;
    struct pgn *pp;
{
    if (xdr_string(xdrs, &pp->name, NLEN) &&
        xdr_reference(xdrs, &pp->gnp,
            sizeof(struct gnumbers), xdr_gnumbers))
        return(TRUE);
    return(FALSE);
}

```

Chapter 5. Network Computing System

The Network Computing System (NCS) is an implementation of the Network Computing Architecture that distributes computer processing tasks across resources in either a single network or several interconnected networks (an internet), which may include a variety of computers and programming environments.

This chapter discusses two key NCS components:

- “Remote Procedure Call Runtime Library”
- “The Location Broker” on page 110

Remote Procedure Call Runtime Library

The Remote Procedure Call (RPC) run-time library, included in the `/usr/lib/libnck.a` library, contains the routines, tables, and data that support the communication of RPCs between clients and servers.

RPC run-time routines are responsible for transmitting RPC packets between the client and server *stubs* (program modules that transfer RPCs and responses between a client and a server).

Routines

The RPC run-time library contains routines that are normally used only by clients (client routines), some that are normally used only by servers (server routines), and others that both clients and servers can use (conversion routines).

Client Routines

The client and its stub use *handles* as temporary location identifiers to represent the object and the server to the RPC run-time routines. The object or server is linked with its specific location through a process called *binding*.

Manual binding occurs when the client makes the RPC library handle management calls directly.

Automatic binding occurs when the client stub calls a routine (written by the application developer) that makes all of the client’s calls to the RPC run-time routines.

The RPC run-time routines that are called by clients include routines that either create handles or manage their binding state. In addition, one routine sends and receives packets.

Server Routines

The RPC run-time routines that are called by servers initialize the server, except for one routine that identifies the object to which a client has requested access.

Most of the server routines in the RPC run-time library initialize the server so that it can respond to client requests for one or more interfaces. In the server code, routines should be included to do the following:

- Create one or more sockets to which clients can send messages.
- Register each interface that the server exports.
- Begin listening for client requests.

The RPC run-time library provides two routines that create sockets. One creates a socket with a well-known port while the other creates a socket with an opaque port number.

A single server can support several interfaces. It can also listen on several sockets at a time. Most servers use one socket for each address family. A server is not required to use different sockets for different interfaces.

The server must register each interface that it exports with the RPC run-time library so that the run-time library can direct client calls to the procedures that implement the requested operations. The library also includes a routine to unregister an interface that the server no longer exports.

When the server creates sockets, registers its interfaces, and begins listening, it is not required to make additional calls to the initialization routines. However, a server can register and unregister interfaces while it is running.

Conversion Routines

The RPC run-time library also provides two routines that convert between names and socket addresses. These routines enable programs to use names rather than addresses to identify server hosts.

The Location Broker

The Location Broker provides clients with information about the locations of objects and interfaces. Servers register their socket addresses and the objects and interfaces to which they provide access with the Location Broker. Clients issue requests to the Location Broker for the locations of objects and interfaces they wish to access. The broker returns database entries that match an object, type, interface, or combination, as specified in the request.

The Location Broker also implements the Remote Procedure Call (RPC) message-forwarding mechanism. If a client sends a request for an interface to the forwarding port on a host, the Location Broker automatically forwards the request to the appropriate server on the host.

Location Broker Components

The Location Broker consists of these interrelated components:

Local Location Broker (LLB)	An RPC server that maintains a database of information about objects and interfaces located on the local host. The LLB provides access to its database for application programs and also provides the Location Broker forwarding service. An LLB must run on any host that runs RPC servers. The LLB runs as the daemon program, llbd .
Global Location Broker (GLB)	An RPC server that maintains information about objects and interfaces throughout the network or internet. The GLB can run as either the glbd or nrglbd daemon program. The glbd daemon supports replicatable GLB databases in the network; the nrglbd daemon does not.
Location Broker Client Agent	A set of library routines that application programs call to access LLB and GLB databases. Any client using Location Broker library routines is actually making calls to the client agent. The client agent interacts with LLBs and GLBs to provide access to their databases.

The following Location Broker Software figure shows the relationships among application programs, the Location Broker components, and the Location Broker databases.

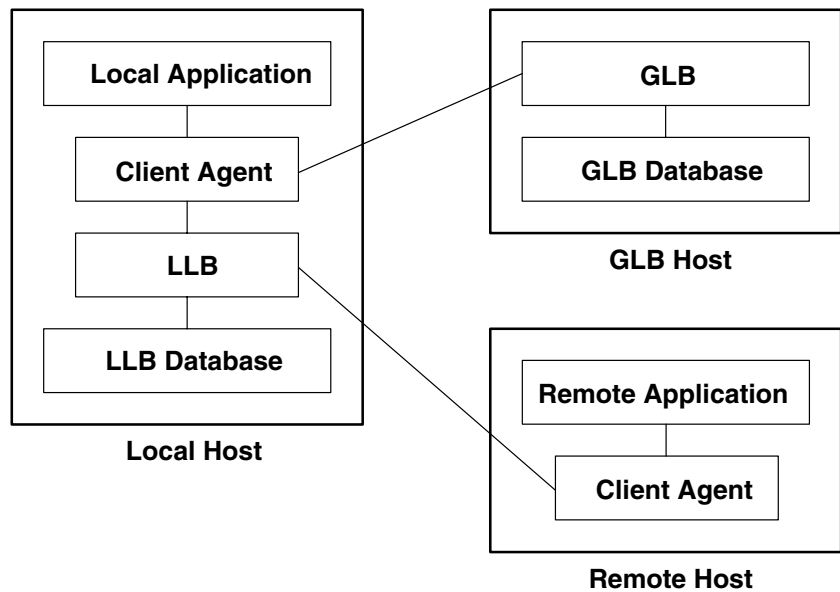

Location Broker Software

Figure 21. Location Broker Software. This diagram shows the local host contains the following components which are connected: local application, client agent, LLB, and LLB database. The GLB Host contains the following components which are connected: GLB and the GLB Database. The remote host contains the following components which are connected: remote application and the client agent. The client agent in the local host is connected to the GLB. The LLB in the local host is connected to the client agent of the remote host.

Location Broker Data

Each entry in a Location Broker database contains information about an object and an interface, and it contains the location of a server that exports the interface to the object. The records in a database entry are as follows:

Object UUID	Specifies a universally unique identifier (UUID) of the object.
Type UUID	Identifies a unique identifier that specifies the type of the object.
Interface UUID	Indicates a unique identifier of the interface to the object.
Flag	Specifies a flag that indicates if the object is global (and should be registered in the GLB database).
Annotation	Contains 64 characters of user-defined information.
Socket Address Length	Specifies the length of the socket address field.
Socket Address	Indicates the location of the server that exports the interface to the object.

Each database entry contains one object UUID, one interface UUID, and one socket address. This means a Location Broker database must have an entry for each possible combination of object, interface, and socket address. For example, the database must have 10 entries for a server that does the following:

- Listens on two sockets, **socket_a** and **socket_b**.
- Exports **interface_1** for **object_x**, **object_y**, and **object_z**.
- Exports **interface_2** for **object_p** and **object_q**.

The server must make a total of 10 calls to the **lb_register** routine to completely register its interfaces and objects.

You can look up Location Broker information by using any combination of the object UUID, type UUID, and interface UUID as keys. You can also request the information from the GLB database or from a particular

LLB database. Therefore, you can obtain information about all objects of a specific type, all hosts with a specific interface to an object, or even all objects and interfaces at a specific host. For example, you can find the addresses of all remotely available array processors by looking up all entries with the **arrayproc** type.

Location Broker Client Agent

The Location Broker client agent is a set of library routines that applications use to access and modify the LLB and GLB databases. When a program issues any Location Broker call, the call goes to the local host's client agent. The client agent does the work to add, delete, or look up information in the appropriate Location Broker database.

The Client Agent and a Global Location Broker figure (Figure 22) illustrates a typical case in which a client requires a particular interface to a particular object, but does not know the location of a server exporting the interface to the object. In this figure, an RPC server registers itself with the Location Broker by calling the client agent in its host (step 1a). The client agent, through the LLB, adds the registration information to the LLB database at the server host (not shown). The client agent also sends the information to the GLB (step 1b). To locate the server, the client issues a Location Broker lookup call (step 2a). The client agent on the client host sends the lookup request to the GLB, which returns the server location through the client agent to the client (step 2b). Then the client can use RPC calls to communicate directly with the located server (steps 3a and 3b).

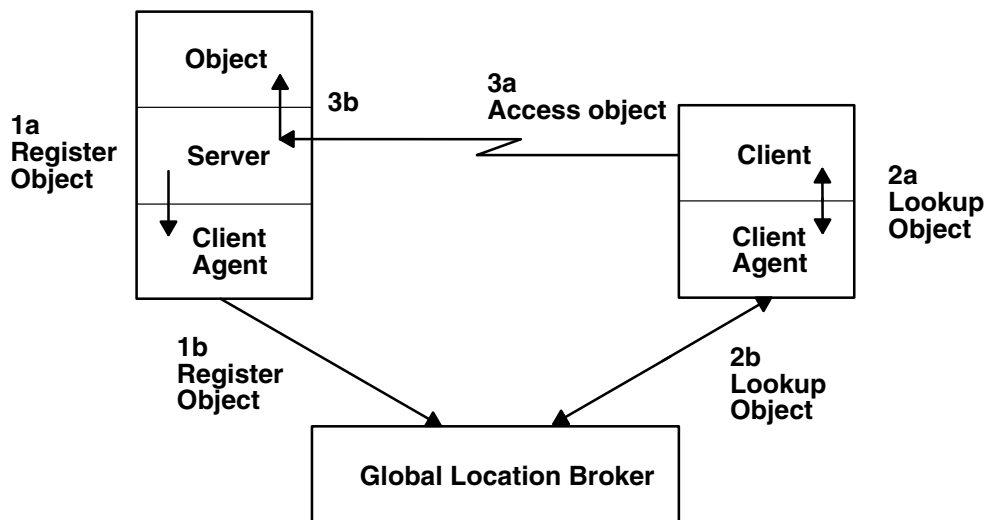

Client Agent and a Global Location Broker

Figure 22. Client Agent and a Global Location Broker

If a client knows the host where the object is located but does not know the port number used by the server, the client agent can query the remote host's LLB directly, as illustrated in the following Client Agent Performing a Lookup at a Known Host figure.

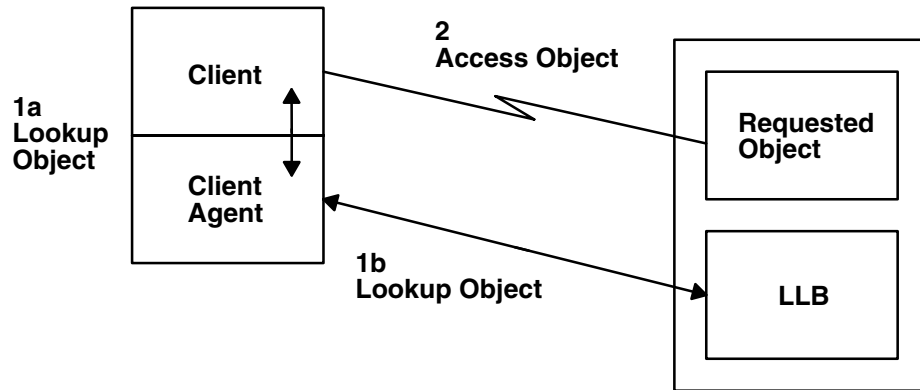

Client Agent Performing a Lookup at a Known Host

Figure 23. Client Agent Performing a Lookup at a Known Host. This diagram shows that after the client agent queries the remote host's LLB, the client can use RPC calls to communicate directly with the requested object.

Local Location Broker

The LLB, which runs as the **llbd** daemon, maintains a database of the objects and interfaces exported by servers running on the host. In addition, it acts as a forwarding agent for requests.

An **llbd** daemon must be running on hosts that run RPC servers. However, it is recommended to run an **llbd** daemon on every host in the network or internet.

Local Database

The database maintained by the LLB provides location information about interfaces on the local host. This information is used by both local and remote applications. To look up information in an LLB database, an application queries the LLB through a client agent. For applications on a local host, the client agent accesses the LLB database directly. For applications on a remote host, the remote client agent accesses the LLB database through the LLB process. You can also access the LLB database manually by using the **lb_admin** command.

LLB Forwarding Agent

The LLB's forwarding facility eliminates the need for a client to know the specific port a server uses. It is intended to limit the number of well-known port numbers reserved for specific purposes.

The forwarding agent listens on one well-known port for each address family. It forwards any messages received to the local server that exports the requested object. Forwarding is particularly useful when the requester of a service already knows the host on which the server is running. For example, you do not need to assign a well-known port to a server that reports load statistics, nor do you need to register the server with the GLB. Each such server registers only with its host's LLB. Remote clients access the server by specifying the object, the interface, and the host, but not a specific port, when making a Remote Procedure Call.

Global Location Broker

The Global Location Broker (GLB), which can run as either the **glbd** daemon or the **nrglbd** daemon, manages information about the objects and interfaces available to users on the network. In an internet, at least one GLB must be running on each network.

The GLB database is accessed manually by using the **lb_admin** command. The **lb_admin** command is useful to manually correct errors in the database. For example, if a server starts while the GLB is not

running, you can manually enter the information for the server in the GLB database. Similarly, if a server terminates abnormally without unregistering itself, you can use the **lb_admin** command to manually remove its entry from the GLB database.

Chapter 6. Network Information Services (NIS and NIS+)

The NFS Network Information Services (NIS) is a distributed database system used to distribute system information on networked hosts. NIS+ expands the network name service provided by NIS by enabling you to store information about workstation addresses, security information, mail information, Ethernet interfaces, and network services in central locations where all workstations on a network can access it.

This chapter lists technical reference sources for programming NIS and NIS+ (See “List of NIS and NIS+ Programming References”). See *AIX 5L Version 5.3 Network Information Services (NIS and NIS+) Guide* for more information.

List of NIS and NIS+ Programming References

The list of Network Information Service (NIS and NIS+) references includes:

- “Subroutines”
- “Files”
- “NIS+ Commands” on page 116
- “NIS+ Tables” on page 116
- “NIS+ APIs” on page 117

See List of NIS Commands in *AIX 5L Version 5.3 Network Information Services (NIS and NIS+) Guide* for information about NIS commands and daemons.

Subroutines

yp_all	Transfers all of the key-value pairs from the NIS server to the client as the entire map.
yp_bind	Calls the ypbind daemon directly for processes that use backup strategies when NIS is not available.
yp_first	Returns the first key-value pair from the named NIS map in the named domain.
yp_get_default_domain	Gets the default domain of the node.
yp_master	Returns the machine name of the NIS master server for a map.
yp_match	Searches for the value associated with a key.
yp_next	Returns each subsequent value it finds in the named NIS map until it reaches the end of the list.
yp_order	Returns the order number for an NIS map that identifies when the map was built.
yp_unbind	Manages socket descriptors for processes that access multiple domains.
yp_update	Makes changes to the NIS map.
yperr_string	Returns a pointer to an error message string.
ypprot_err	Takes an NIS protocol error code as input and returns an error code to be used as input to a yperr_string subroutine.

Files

ethers	Lists Ethernet addresses of hosts on the network.
netgroup	Lists the groups of users on the network.
netmasks	Lists network masks used to implement Internet Protocol standard subnetting.
publickey	Stores public or secret keys from NIS maps.
updaters	Contains a makefile for updating NIS maps.
xtab	Lists directories that are currently exported.

NIS+ Commands

Command	Description
nisaddcred	Creates credentials for NIS+ principals and stores them in the cred table.
nisaddent	Adds information from /etc files or NIS maps into NIS+ tables.
niscat	Displays the contents of NIS+ tables.
nischgrp	Changes the group owner of an NIS+ object.
nischmod	Changes an object's access rights.
nischown	Changes the owner of an NIS+ object.
nischttl	Changes an NIS+ object's time-to-live value.
nisdefaults	Lists an NIS+ object's default values: domain name, group name, workstation name, NIS+ principal name, access rights, directory search path, and time-to-live.
nisgrep	Searches for entries in an NIS+ table.
nisgrpadm	Creates or destroys an NIS+ group, or displays a list of its members. Also adds members to a group, removes them, or tests them for membership in the group.
nisinit	Initializes an NIS+ client or server.
nisln	Creates a symbolic link between two NIS+ objects.
nisls	Lists the contents of an NIS+ directory.
nismatch	Searches for entries in an NIS+ table.
nismkdir	Creates an NIS+ directory and specifies its master and replica servers.
nismkuser	Creates an NIS+ user.
nispasswd	Not supported in AIX. Use the passwd command.
nisrm	Removes NIS+ objects (except directories) from the namespace.
nisrmdir	Removes NIS+ directories and replicas from the namespace.
nisrmuser	Removes an NIS+ user.
nissetup	Creates org_dir and groups_dir directories and a complete set of (unpopulated) NIS+ tables for an NIS+ domain.
nisshowcache	Lists the contents of the NIS+ shared cache maintained by the NIS+ cache manager.
nistbladm	Creates or deletes NIS+ tables, and adds, modifies or deletes entries in an NIS+ table.
nisupdkeys	Updates the public keys stored in an NIS+ object.
passwd	Changes password information stored in the NIS+ passwd table.

NIS+ Tables

Table	Information in the Table
hosts	Network address and host name of every workstation in the domain
bootparams	Location of the root, swap, and dump partition of every diskless client in the domain
passwd	Password information about every user in the domain.
cred	Credentials for principals who belong to the domain
group	The group name, group password, group ID, and members of every UNIX group in the domain
netgroup	The netgroups to which workstations and users in the domain may belong
mail_aliases	Information about the mail aliases of users in the domain
timezone	The time zone of every workstation in the domain
networks	The networks in the domain and their canonical names
netmasks	The networks in the domain and their associated netmasks
ethers	The Ethernet address of every workstation in the domain
services	The names of IP services used in the domain and their port numbers
protocols	The list of IP protocols used in the domain
RPC	The RPC program numbers for RPC services available in the domain
auto_home	The location of all user's home directories in the domain
auto_master	Automounter map information
sendmailvars	The mail domain
client_info	Information about NIS+ clients

NIS+ APIs

The NIS+ application program interface (API) functions include:

- **nis_add_entry**
- **nis_first_entry**
- **nis_list**
- **nis_local_directory**
- **nis_lookup**
- **nis_modify_entry**
- **nis_next_entry**
- **nis_perror**
- **nis_remove_entry**
- **nis_sperror**

Chapter 7. Network Management

The Network Management facility meets programming needs by managing system networks through the use of Simple Network Management Protocol (SNMP) by network hosts to exchange information.

The following topics are discussed in this chapter:

- “Simple Network Management Protocol”
- “Management Information Base” on page 120
- “Terminology Related to Management Information Base Variables” on page 122
- “Working with Management Information Base Variables” on page 123
- “Management Information Base Database” on page 123
- “How a Manager Functions” on page 125
- “How an Agent Functions” on page 125
- “List of SNMP Agent Programming References” on page 127
- “SMUX Error Logging Subroutines Examples” on page 128

Simple Network Management Protocol

The Simple Network Management Protocol (SNMP) is used by network hosts to exchange information in the management of networks. SNMP is defined in several Requests for Comments (RFCs) available from the Network Information Center at SRI International, Menlo Park, California.

The following RFCs define SNMP:

RFC 1155	Structure and Identification of Management Information for TCP/IP-based Internets
RFC 1157	A Simple Network Management Protocol (SNMP)
RFC 1213	Management Information Base for Network Management of TCP/IP-based internets: MIB-II
RFC 1227	Simple Network Management Protocol (SNMP) single multiplexer (SMUX) protocol and Management Information Base (MIB)
RFC 1229	Extensions to the Generic-Interface Management Information Base (MIB)
RFC 1231	IEEE 802.5 Token Ring Management Information Base (MIB)
RFC 1398	Definitions of Managed Objects for the Ethernet-like Interface Types
RFC 1512	FDDI Management Information Base (MIB)
RFC 1514	Host Resources Management Information Base (MIB)
RFC 1592	Simple Network Management Protocol Distributed Protocol Interface Version 2.0
RFC 1907	Management Information Base for Version 2 of the Simple Network Management Protocol (SNMPv2)
RFC 2572	Message Processing and Dispatching for the Simple Network Management Protocol (SNMP)
RFC 2573	SNMP Applications
RFC 2574	User-based Security Model (USM) for version 3 of the Simple Network Management Protocol (SNMPv3)
RFC 2575	View-based Access Control Model (VACM) for the Simple Network Management Protocol (SNMP)

SNMP network management is based on the familiar client-server model that is widely used in Transmission Control Protocol/Internet Protocol (TCP/IP)-based network applications. Each managed host runs a process called an *agent*. The agent is a server process that maintains the MIB database for the host. Hosts that are involved in network management decision-making may run a process called a *manager*. A manager is a client application that generates requests for MIB information and processes responses. In addition, a manager may send requests to agent servers to modify MIB information.

Management Information Base

The Management Information Base (MIB) is a database containing the information pertinent to network management. The database is conceptually organized as a tree. The upper structure of this tree is defined in Requests for Comments (RFC) 1155 and RFC 1213. The internal nodes of the tree represent subdivision by organization or function. MIB variable values are stored in the leaves of this tree. Thus, every distinct variable value corresponds to a unique path from the root of the tree. The children of a node are numbered sequentially from left to right, starting at 1, so that every node in the tree has a unique name, which consists of the sequence of node numbers that comprise the path from the root of the tree to the node. The Example Section of an MIB Tree figure (Figure 24) illustrates the relationship of sections of the MIB tree.

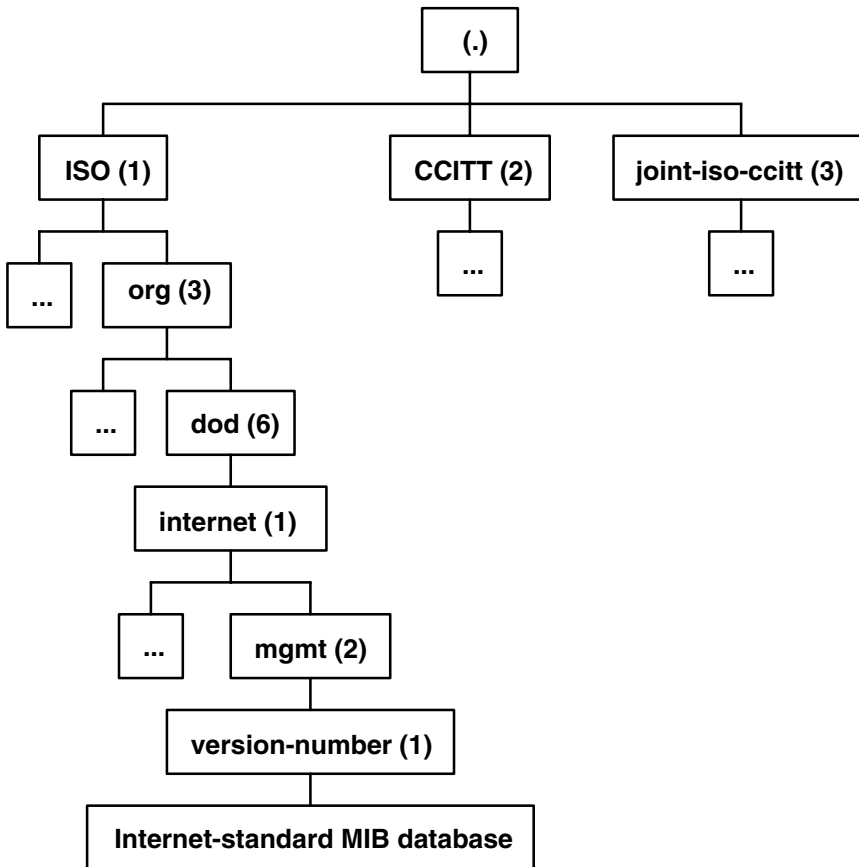

Example Section of an MIB Tree

Figure 24. Example Section of an MIB Tree. This diagram shows three roots coming off the MIB tree. Their nodes are labeled (from the left) as follows: ISO (1), CCITT (2), joint-iso-ccitt (3). A child of ISO is labeled org (3), whose child is labeled dod (6). Below dod (6) is internet (1) whose child is mgmt (2). Below mgmt (6) is version-number (1), internet-standard MIB tree is the last child.

Here, the network management data for the Internet is stored in the subtree reached by the path 1.3.6.1.2.1. This notation is the conventional way of writing the numeric path name, separating node numbers by periods. All variables defined in RFC 1213 have numeric names that begin with this prefix.

Note: Future versions of the Internet-standard MIB may have higher version numbers with variable names distinct from earlier versions.

A typical variable value is stored as a leaf, as illustrated in the Leaves on an MIB tree figure (Figure 25 on page 121).

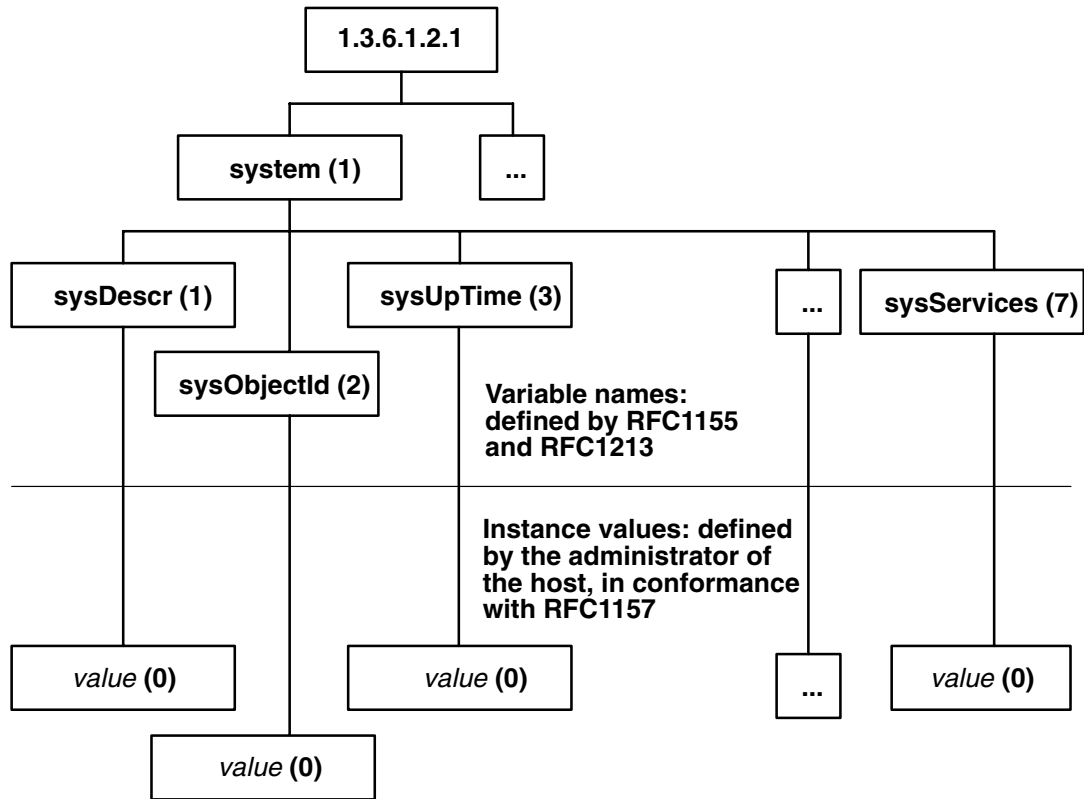

Leaves on an MIB Tree

Figure 25. Leaves on an MIB Tree. This diagram shows one branch off the path that is labeled system (1). The variable names that branch off from system (1) are from the left: sysDescr (1), sysObjectid (2), sysUpTime (3), and sysServices (7). These variable names are defined by RFC1155 and RFC1213. The instance values which are below the variable names listed previously are value (0) in all four cases. The instance values are defined by the administrator of the host, in conformance with RFC1157.

The MIB manager data associates the values of the variables with each uniquely named instance of a variable. For example, 1.3.6.1.2.1.1.1.0 is the unique name of the system description, a text string describing the host's operational environment. Because only one such string exists, the instance of the variable name 1.3.6.1.2.1.1.1 (which is denoted by a 0) is reserved for this use only. Many other variables have multiple instances, as illustrated in the Multiple Instance Variables figure (Figure 26 on page 122).

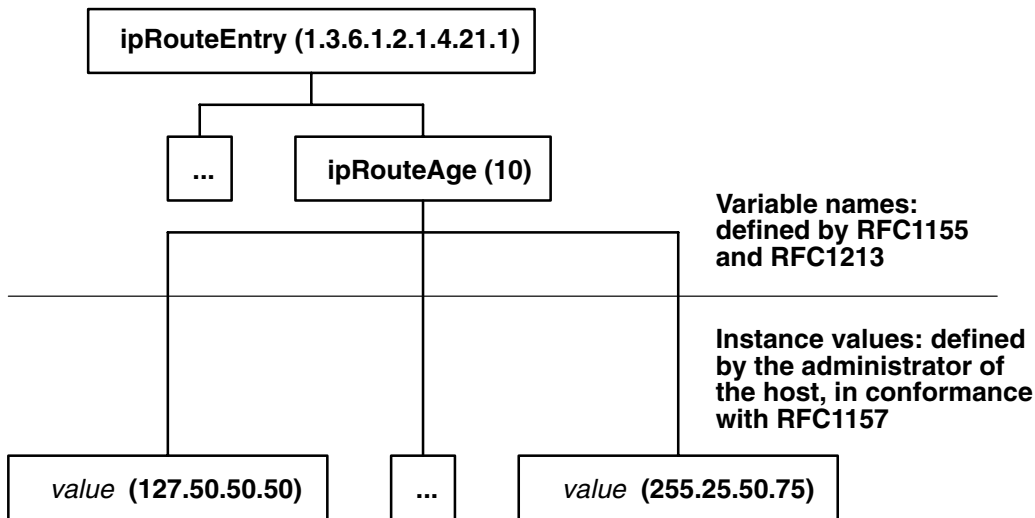

Figure 26. Multiple Instance Variables. This diagram shows *ipRouteEntry* (1.3.5.1.2.1.4.21.1) at the top of the tree and a branch with the variable name *ipRouteAge* (10). Both of these variables are defined by RFC1155 and RFC1213. The following instance values branch-off of *ipRouteAge* (10): *value* (127.50.50.50) and *value* (255.25.50.75). Instance values are defined by the administrator of the host, in conformance with RFC1157.

Each variable containing information about a route has an instance that is the Internet Protocol (IP) address of the route's destination. Other variables have more complex rules for forming instances. The variable *name* uniquely identifies a group of related data, while the variable *instance* is a unique name for a particular item within the group. For example, 1.3.6.1.2.1.4.21.1.10 is the name of the variable whose instances are route ages, while 1.3.6.1.2.1.4.21.1.10.127.50.50.50 is the name of the instance that contains the age of the route to a host with the IP address of 127.50.50.50.

For more information on Internet addresses and routing see "TCP/IP addressing" and "TCP/IP routing" in *Networks and communication management*.

Terminology Related to Management Information Base Variables

Requests for Comments (RFC) 1155 and 1213 define the Management Information Base (MIB) as an object-oriented database. Both RFCs refer to the node names as *object identifiers*. Most nodes also have descriptive textual names called *object descriptors*. The object descriptors are convenient aliases, but Simple Network Management Protocol (SNMP) request packets refer to variable instances only by object identifier. Variable names and variable instances are both denoted by object identifiers or object descriptors. To distinguish the four possible combinations unambiguously, the following non-RFC terminology is used here:

Non-RFC Terminology	RFC Terminology	Example
Text-format variable name (denotes the descriptive textual name of a variable)	Object descriptor of a variable	sysDescr
Numeric-format variable name (denotes a variable name expressed as a sequence of decimal numbers separated by periods)	Object Identifier of a variable	1.3.6.1.2.1.1.1
Text-format instance ID (denotes a text-format variable name qualified by an instance)	Object descriptor of a variable with an instance appended	sysDescr.0

Non-RFC Terminology	RFC Terminology	Example
Numeric-format instance ID (denotes a numeric-format variable name qualified by an instance)	Object identifier of a variable with an instance appended	1.3.6.1.2.1.1.1.0

Instance IDs are variable names with an instance appended. A *variable name* refers to a set of related data, while an instance ID refers to a specific item from the set.

For information on the subroutines, see “List of SNMP Agent Programming References” on page 127.

Working with Management Information Base Variables

The **clsnmp** command is a simple Simple Network Management Protocol (SNMP) manager application tool that makes SNMP requests of SNMP agents.

You can add object definitions for MIB variables to the **/etc/mib.defs** file by using the **mosy** command.

You can also add object definitions for experimental MIB modules or private-enterprise-specific MIB modules to the **/etc/mib.defs** file. This file is created by the **mosy** command. You first must obtain the private MIB module from a vendor that supports those MIB variables.

Updating the **/etc/mib.defs** file to incorporate a vendor’s private or experimental MIB object definitions can be done two ways. The first approach is to create a subfile and then concatenate that subfile to the existing MIB **/etc/mib.defs** file. To create the subfile for the private MIBs and update the **/etc/mib.defs** file, issue the following commands:

```
mosy -o /tmp/private.obj /tmp/private.my
cat /etc/mib.defs /tmp/private.obj > /tmp/mib.defs
cp /tmp/mib.defs /etc/mib.defs
```

A second approach re-creates the **/etc/mib.defs** file with the **mosy** command:

```
mosy -o /etc/mib.defs /usr/lpp/snmpd/smi.my \
/usr/lpp/snmpd/mibII.my /tmp/private.my
```

The MIB object groups in the private MIB object definition module may have order dependencies.

Remember the SNMP agent being queried must have these MIB variables implemented before it can return a value for the requested MIB variables.

Management Information Base Database

Network management can be passive or active. *Passive* network management involves the collection of statistical data to profile the network activity of each host. Every variable in the Internet-standard Management Information Base (MIB) has a value that can be queried and used for this purpose.

Active network management uses a subset of MIB variables that are designated read-write. When an Simple Network Management Protocol (SNMP) agent is instructed to modify the value of one of these variables, an action is taken on the agent’s host as a side effect. For example, a request to set the **ifAdminStatus.3** variable to the value of 2 has the side effect of disabling the network adapter card whose **ifIndex** variable is set to a value of 3.

Requests to read or change variable values are generated by manager applications. Three kinds of requests exist:

get Returns the value of the specified variable instance.
get-next Returns the value of the variable instance following the specified instance, a get-next request.

set Modifies the value of the specified variable instance.

Requests are encoded according to the ISO ASN.1 CCITT standard for data representation (ISO document DIS 8825). Each get request contains a list of pairs of variable instances and variable values called the *variable binding list*. The variable values are empty when the request is transmitted. The values are filled in by the receiving agent and the entire binding list is copied into a response packet for transmission back to the monitor. If the request is a set request, the request packet also contains a list of variable values. These values are copied into the binding list when the response is generated. If an error occurs, the agent immediately stops processing the request packet, copies the partially processed binding list into the response packet, and transmits it with an error code and the index of the binding that caused the error.

get-next Request

The get-next request deserves special consideration. It is designed to navigate the entire Internet-standard MIB subtree. Because all instance IDs are sequences of numbers, they can be ordered.

The first eight instance IDs are:

sysDescr.0	1.3.6.1.2.1.1.1.0
sysObjectid.0	1.3.6.1.2.1.1.2.0
sysUpTime.0	1.3.6.1.2.1.1.3.0
sysContact.0	1.3.6.1.2.1.1.4.0
sysName.0	1.3.6.1.2.1.1.5.0
sysLocation.0	1.3.6.1.2.1.1.6.0
sysServices.0	1.3.6.1.2.1.1.7.0
ifNumber.0	1.3.6.1.2.1.2.1.0

A get-next request for a MIB variable instance returns a binding list containing the next MIB variable instance in sequence and its associated value. For example, a get-next request for the **sysDescr.0** variable returns a binding list containing the pair (**sysObjectid.0**, *Value*). A get-next request for the **sysObjectid.0** variable returns a binding list containing the pair (**sysUpTime.0**, *Value*), and so forth.

A get-next request for the **sysServices.0** variable in the previous list does not look for the next instance ID in sequence (1.3.6.1.2.1.1.8.0) because no such instance ID is defined in the Internet-standard MIB subtree. The next MIB variable instance in the Internet-standard MIB subtree is the first instance ID in the next MIB group in sequence, the *interfaces* group. The first instance ID in the interfaces group is the **ifNumber.0** variable.

Thus, a get-next request for the **sysServices.0** variable returns a binding list containing the pair (**ifNumber.0**, *Value*). Instance IDs are similar to decimal number representations, with the digits to the right increasing more rapidly than the digits on the left. Unlike decimal numbers, the digits have no real base. The possible values for each digit are determined by the RFCs and the instances that are appended to the variable names. The get-next request allows traversal of the whole tree, even though instances are not known.

The following example is an illustration of an algorithm, not of actual code:

```
struct binding {
    char instance[length1];
    char value[length2];
}bindlist[maxlistsize];
bindlist[0] = get(sysDescr.0);
for (i = 1; i < maxlistsize && bindlist[i-1].instance != NULL; i++) {
    bindlist[i] = get_next(bindlist[i-1].instance);
}
```

The fictitious `get` and `get-next` functions in this example return a single binding pair, which is stored in an array of bindings. Each `get-next` request uses the instance returned by the previous request. By daisy-chaining in this way, the entire MIB database is traversed.

How a Manager Functions

Managers, or the *clients* in a client and server relationship, are divided into two functional layers: application and protocol.

The protocol layer accepts requests from the application layer, encodes them in ASN.1 format, and transmits them on the network. It receives and decodes replies and trap packets, detects erroneous packets, and passes the data to the application layer.

The application layer does the real work of the manager. It decides when to generate requests for variable values and what to do with the results. A manager may perform a passive statistics-gathering function, or it may attempt to actively manage the network by setting new values in read-write variables on some hosts. For example, a network interface may be enabled or disabled by means of the **ifAdminStatus** variable. The variables in the **ipRoute** family can be used to download kernel route tables, using data obtained from a router.

For more information on protocols and routing, see "TCP/IP protocols" and "TCP/IP routing" in *Networks and communication management*.

How an Agent Functions

Agents are the servers in the client and server relationship. Agents listen on well-known port 161 for request packets from managers. In addition to the protocol and application layers, agents must also communicate with the operating system kernel. Most of the information in the Internet-standard MIB is maintained by kernel processes. The actions associated with a set request are often implemented as `ioctl` commands. In addition, the kernel may generate asynchronous notifications called *traps*. Some MIB information may be managed by another application, such as the **gated** daemon. The Agent Function figure (Figure 27 on page 126) outlines the function of an agent.

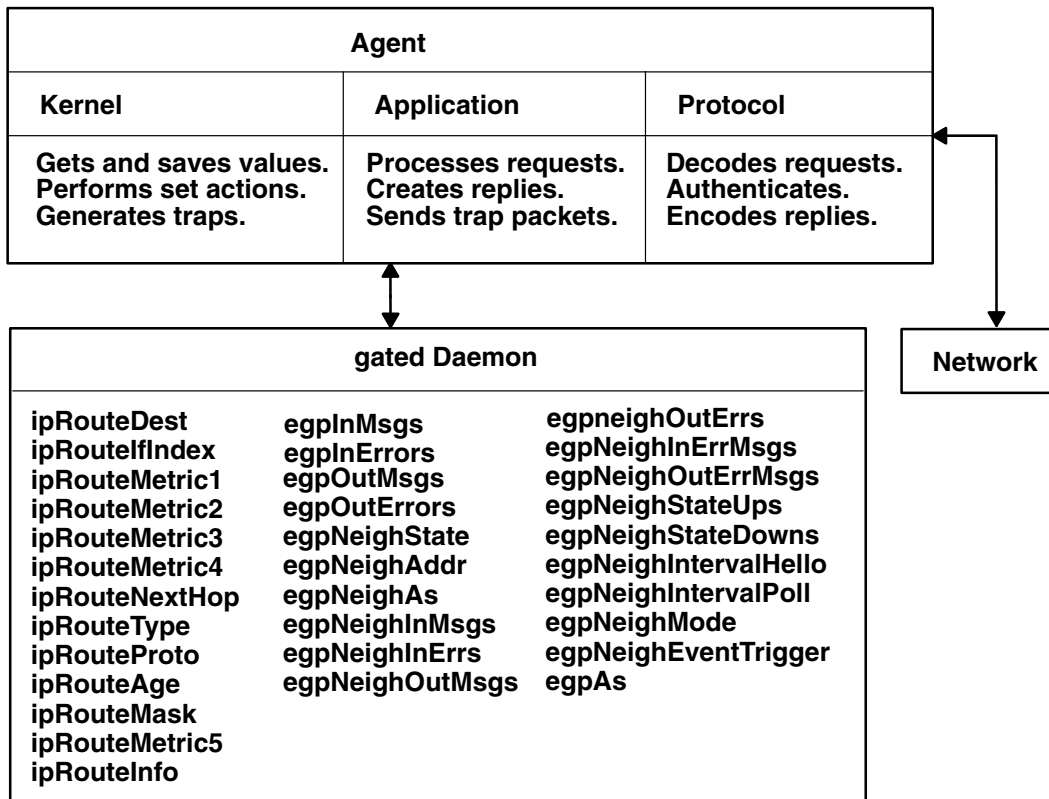

Agent Function

Figure 27. Agent Function. This diagram shows that the kernel within the agent additionally gets and saves values, and performs set actions. The agent's application processes requests, creates replies, and sends trap packets. Two of the protocol layer tasks are decoding requests and encoding replies. There is communication between the agent and the network and also the gated Daemon that contains community names.

One of the tasks of the protocol layer is to authenticate requests. This is optional and not all agents implement this task. If the protocol layer authenticates requests, the community name included in every request packet is used to determine what access privileges the sender has. The community name might be used to reject all requests (if it is an unknown name), restrict the sender's view of the database, or reject set requests from some senders. A manager might belong to many different communities, each of which may have a different set of access privileges granted by the agents. A manager might generate or forward requests for other processes, using different community names for each.

Traps

The agent may generate asynchronous event notifications called **traps**. For example, if an interface adapter fails, the kernel may detect this and cause the agent to generate a trap to indicate the link is down (in some implementations, the agent may detect the condition). Also, other applications may generate traps. For example, in addition to the **gated** request types shown in the Agent Function figure (Figure 27), the **gated** daemon generates an **egpNeighborLoss** trap whenever it puts an Exterior Gateway Protocol (EGP) neighbor into the down state. The agent itself generates traps (**coldStart**, **warmStart**) when it initializes and when authentication fails (**authenticationFailure**). Each agent has a list of hosts to which traps should be sent. The hosts are assumed to be listening on well-known port 162 for trap packets.

For more information on EGP, see "Exterior Gateway Protocol" in *Networks and communication management*.

List of SNMP Agent Programming References

The list of Simple Network Management Protocol (SNMP) programming references includes:

- “Programming Commands”
- “Files and File Formats”
- “SMUX Subroutines”

Refer to the *AIX 5L Version 5.3 Commands Reference* for information about the system commands.

Programming Commands

mosy	Converts the ASN.1 definitions of Structure and Identification of Management Information (SMI) and Management Information Base (MIB) modules into an object definition file for the clsnmp command.
clsnmp	Requests or modifies values of MIB variables managed by an SNMP agent.

Files and File Formats

mib.defs	Defines the MIB variables the SNMP agent should recognize and handle. The format of the /etc/mib.defs file is required by the snmpinfo command.
mibll.my	Defines the ASN.1 definitions for the MIB variables as defined in RFC 1213.
smi.my	Defines the ASN.1 definitions by which the SMI is defined as in RFC 1155.
snmpd.conf	Defines a sample configuration file for the snmpd agent.
ethernet.my	Defines the ASN.1 definitions for the MIB variables defined in RFC 1398.
fdi.my	Defines the ASN.1 definitions for the MIB variables defined in RFC 1512.
generic.my	Defines the ASN.1 definitions for the MIB variables defined in RFC 1229.
ibm.my	Defines the ASN.1 definitions for the IBM enterprise section of the MIB tree.
token-ring.my	Defines the ASN.1 definitions for the MIB variables defined in RFC 1231.
unix.my	Defines the ASN.1 definitions for a set of MIB variables for memory buffer (mbuf) statistics, SNMP multiplexing (SMUX) peer information, and various other information.
view.my	Defines the ASN.1 definitions for the SNMP access list and view tables.
snmpd.peers	Defines a sample peers file for the snmpd agent.

SMUX Subroutines

getsmuxEntrybyidentity	Retrieves SMUX peers by object identifier.
getsmuxEntrybyname	Retrieves SMUX peers by name.
isodetailor	Initializes variables for various logging facilities.
_ll_log	Reports errors to log files.
ll_dbinit	Reports errors to log files.
ll_hdinit	Reports errors to log files.
ll_log	Reports errors to log files.
o_generic	Encodes values retrieved from the MIB into the specified variable binding.
o_igeneric	Encodes values retrieved from the MIB into the specified variable binding.
o_integer	Encodes values retrieved from the MIB into the specified variable binding.
o_ipaddr	Encodes values retrieved from the MIB into the specified variable binding.
o_number	Encodes values retrieved from the MIB into the specified variable binding.
o_specific	Encodes values retrieved from the MIB into the specified variable binding.
o_string	Encodes values retrieved from the MIB into the specified variable binding.
ode2oid	Returns a static pointer to the object identifier. If unsuccessful, the NULLOID value is returned.
oid2ode	Takes an object identifier and returns its dot-notation description as a string.
oid2prim	Encodes an object identifier structure into a presentation element.
oid_cmp	Manipulates the object identifier structure.

oid_cpy	Manipulates the object identifier structure.
oid_extend	Extends the base /usr/lib/libisode.a library subroutines.
oid_free	Manipulates the object identifier structure.
oid_normalize	Extends and adjusts the values of the object identifier structure entries for the base /usr/lib/libisode.a library subroutines.
prim2oid	Decodes an object identifier from a presentation element.
readobjects	Allows an SMUX peer to read the MIB variable structure.
s_generic	Sets the value of the MIB variable in the database.
smux_close	Ends communication with the SNMP agent.
smux_error	Creates a readable string from information found in the smux_errno global variable.
smux_free_tree	Frees the object tree when an SMUX tree is unregistered.
smux_init	Initiates the Transmission Control Protocol (TCP) socket that the SMUX agent uses and clears the basic SMUX data structures.
smux_register	Registers a section of the MIB tree with the SNMP agent.
smux_response	Sends a response to a SNMP agent.
smux_simple_open	Sends the open protocol data unit (PDU) to the SNMP daemon.
smux_trap	Allows the SMUX peer to send traps to the SNMP agent.
smux_wait	Waits for a message from the SNMP agent.
sprintoid	Manipulates the object identifier structure.
str2oid	Manipulates the object identifier structure.
text2oid	Converts a text string into an object identifier.
text2obj	Converts a text string into an object.
text2inst	Retrieves instances of variables from a character string.
name2inst	Retrieves instances of variables from various forms of data.
next2inst	Retrieves instances of variables from various forms of data.
nexttot2inst	Retrieves instances of variables from various forms of data.

SMUX Error Logging Subroutines Examples

The **advise** and **adios** subroutines are example subroutines created to illustrate how the SNMP multiplexing (SMUX) **_ll_log** logging subroutine can be used. The **adios** and **advise** sample subroutines are in the **unixd.c** and **sampled.c** sample programs.

The **adios** subroutine exits on a fatal error. This subroutine sends a fatal message to the log file and exits. If needed, other functionality can be added to the subroutine to help the failing program exit cleanly.

The **advise** subroutine sends an advisory message to the log. This subroutine allows the programmer to specify the message logging event type.

adios Sample Subroutine

```

/* Function: adios
*
* Inputs:
* what - the thing that went wrong
* fmt - the string to be printed in printf format (char*)
* variables - variable needed to fill in the fmt.
*
* Outputs: none
* Returns: none
*
* NOTE: The adios function calls the logging function with the
* variables above and a LLOG_FATAL error code. The function then
* exits with a return code of 1, thereby terminating the sampled
* process.
*/
#ifdef lint

```

```

void    adios (va_list)
va_dcl
{
    va_list ap;
    va_start (ap);
    _ll_log (pgm_log, LLOG_FATAL, ap); /*Prints to the log*/
                                        /*specified by pgm_log.a*/
                                        /* Fatal error      */
    va_end (ap);
    _exit (1);
}
#else
/* VARARGS */
void adios (what,fmt)
char *what,
    *fmt;
{
    adios (what, fmt);
}
#endif

```

advise Sample Subroutine

```

/* Function: advise
*
* Inputs:
* code - the logging level to associate with this error (int)
* what - the thing that went wrong
* fmt - the string to be printed in printf format (char*)
* variables - variable needed to fill in the fmt.
*
* Outputs: none
* Returns: none
*
* NOTE: The advise function calls the logging function with the
* variables above. This is a usability front end to the logging
* functions.
*/
#ifdef lint
void    advise (va_list)
va_dcl
{
    int code;
    va_list ap;
    va_start (ap);
    code = va_arg (ap, int); /*Gets the code variable */
                                /* from the list of parameters */
    _ll_log (pgm_log, code, ap);
    va_end (ap);
}
#else
/* VARARGS */
void advise (code, what, fmt)
char *what,
    *fmt;
int    code;
{
    advise (code, what, fmt);
}
#endif

```

Chapter 8. Remote Procedure Call

Remote Procedure Call (RPC) is a protocol that provides the high-level communications paradigm used in the operating system. RPC presumes the existence of a low-level transport protocol, such as Transmission Control Protocol/Internet Protocol (TCP/IP) or User Datagram Protocol (UDP), for carrying the message data between communicating programs. RPC implements a logical client-to-server communications system designed specifically for the support of network applications.

This chapter provides the following information about programming RPC:

- “RPC Model” on page 132
- “RPC Message Protocol” on page 133
- “RPC Authentication” on page 138
- “RPC Port Mapper Program” on page 144
- “Programming in RPC” on page 146
- “RPC Features” on page 153
- “RPC Language” on page 155
- “rpcgen Protocol Compiler” on page 160
- “List of RPC Programming References” on page 162

The RPC protocol is built on top of the eXternal Data Representation (XDR) protocol, which standardizes the representation of data in remote communications. XDR converts the parameters and results of each RPC service provided.

The RPC protocol enables users to work with remote procedures as if the procedures were local. The remote procedure calls are defined through routines contained in the RPC protocol. Each call message is matched with a reply message. The RPC protocol is a message-passing protocol that implements other non-RPC protocols such as batching and broadcasting remote calls. The RPC protocol also supports callback procedures and the **select** subroutine on the server side.

A *client* is a computer or process that accesses the services or resources of another process or computer on the network. A *server* is a computer that provides services and resources, and that implements network services. Each network *service* is a collection of remote programs. A remote program implements remote procedures. The procedures, their parameters, and the results are all documented in the specific program’s protocol.

RPC provides an authentication process that identifies the server and client to each other. RPC includes a slot for the authentication parameters on every remote procedure call so that the caller can identify itself to the server. The client package generates and returns authentication parameters. RPC supports various types of authentication such as the UNIX and Data Encryption Standard (DES) systems.

In RPC, each server supplies a program that is a set of remote service procedures. The combination of a host address, program number, and procedure number specifies one remote service procedure. In the RPC model, the client makes a procedure call to send a data packet to the server. When the packet arrives, the server calls a dispatch routine, performs whatever service is requested, and sends a reply back to the client. The procedure call then returns to the client.

The RPC interface is generally used to communicate between processes on different workstations in a network. However, RPC works just as well for communication between different processes on the same workstation.

The Port Mapper program maps RPC program and version numbers to a transport-specific port number. The Port Mapper program makes dynamic binding of remote programs possible.

To write network applications using RPC, programmers need a working knowledge of network theory. For most applications, an understanding of the RPC mechanisms usually hidden by the `rpcgen` command's protocol compiler is also helpful. However, use of the `rpcgen` command circumvents the need for understanding the details of RPC.

RPC Model

The remote procedure call (RPC) model is similar to a local procedure call model. In the local model, the caller places arguments to a procedure in a specified location such as a result register. Then, the caller transfers control to the procedure. The caller eventually regains control, extracts the results of the procedure, and continues execution.

RPC works in a similar manner, in that one thread of control winds logically through two processes: the caller process and the server process. First, the caller process sends a call message that includes the procedure parameters to the server process. Then, the caller process waits for a reply message (blocks). Next, a process on the server side, which is dormant until the arrival of the call message, extracts the procedure parameters, computes the results, and sends a reply message. The server waits for the next call message. Finally, a process on the caller receives the reply message, extracts the results of the procedure, and the caller resumes execution.

The Remote Procedure Call Flow figure (Figure 28) illustrates the RPC paradigm.

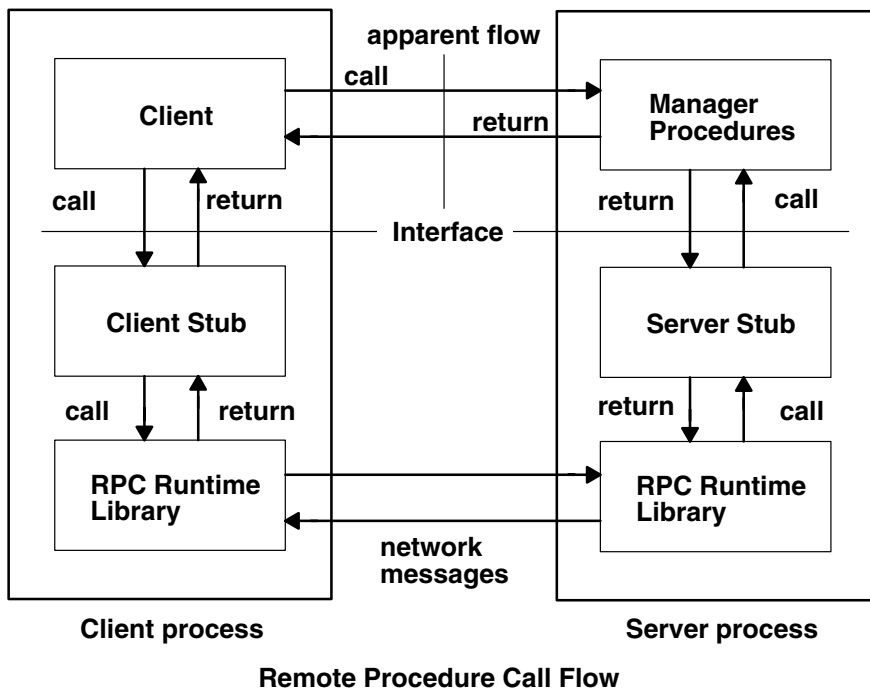

Figure 28. Remote Procedure Call Flow. This diagram shows the client process on the left which contains (listed from top to bottom) the client, client stub, RPC run-time library. The server process on the right contains the following (listed from top to bottom): manager procedures, server stub, and the RPC run-time library. The calls can go from the client to the manager procedures crossing the apparent flow and above the interface. The call from the client can also go through the interface to the client stub. From the client stub, the call can travel to the RPC run-time library in the client process. The call can travel to the library in the server process as a network message. Calls in the server process can go from the RPC run-time library to the server stub and from the server stub to the manager procedures. Note that there is a return in the opposite direction of each call mentioned previously.

In the RPC model, only one of the two processes is active at any given time. Furthermore, this model is only an example. The RPC protocol makes no restrictions on the concurrency model implemented, and others are possible. For example, an implementation can choose asynchronous Remote Procedure Calls

so that the client can continue working while waiting for a reply from the server. Additionally, the server can create a task to process incoming requests and thereby remain free to receive other requests.

Transports and Semantics

The RPC protocol is independent of transport protocols. How a message is passed from one process to another makes no difference in RPC operations. The protocol deals only with the specification and interpretation of messages.

RPC does not try to implement any kind of reliability. The application must be aware of the type of transport protocol underneath RPC. If the application is running on top of a reliable transport, such as Transmission Control Protocol/Internet Protocol (TCP/IP), then most of the work is already done. If the application is running on top of a less-reliable transport, such as User Datagram Protocol (UDP), then the application must implement a retransmission and time-out policy, because RPC does not provide these services.

Due to transport independence, the RPC protocol does not attach specific semantics to the remote procedures or their execution. The semantics can be inferred from (and should be explicitly specified by) the underlying transport protocol. For example, consider RPC running on top of a transport such as UDP. If an application retransmits RPC messages after short time outs and receives no reply, the application infers that the procedure was executed zero or more times. If the application receives a reply, the application infers that the procedure was executed at least once.

A transaction ID is packaged with every RPC request. To ensure some degree of execute-at-most-once semantics, RPC allows a server to use the transaction ID to recall a previously granted request. The server can then refuse to grant that request again. The server is allowed to examine the transaction ID only as a test for equality. The RPC client mainly uses the transaction ID to match replies with requests. However, a client application can reuse a transaction ID when transmitting a request.

When using a reliable transport such as TCP/IP, the application can infer from a reply message that the procedure was executed exactly once. If the application receives no reply message, the application cannot assume that the remote procedure was not executed. Even if a connection-oriented protocol like TCP/IP is used, an application still needs time outs and reconnection to handle server crashes.

Transports besides datagram or connection-oriented protocols can also be used. For example, a request-reply protocol, such as Versatile Message Transaction Protocol (VMTP), is perhaps the most natural transport for RPC.

RPC in the Binding Process

The act of binding a client to a service is *not* part of the Remote Procedure Call specification. This important and necessary function is left to higher-level software. However, the higher level software may use RPC in the binding process. The RPC port mapper program is an example of software that uses RPC.

The RPC protocol's relationship to the binding software is similar to the relationship of the network jump-subroutine instruction (JSR) to the loader (binder). The loader uses JSR to accomplish its task. Similarly, the network uses RPC to accomplish the bind.

RPC Message Protocol

The Remote Procedure Call (RPC) message protocol consists of two distinct structures: the call message and the reply message (see "RPC Call Message" on page 134 and "RPC Reply Message" on page 136). A client makes a remote procedure call to a network server and receives a reply containing the results of the procedure's execution. By providing a unique specification for the remote procedure, RPC can match a reply message to each call (or request) message.

The RPC message protocol is defined using the eXternal Data Representation (XDR) data description, which includes structures, enumerations, and unions. See “RPC Language Descriptions” on page 155 for more information.

When RPC messages are passed using the TCP/IP byte-stream protocol for data transport, it is important to identify the end of one message and the start of the next one.

RPC Protocol Requirements

The RPC message protocol requires:

- Unique specification of a procedure to call
- Matching of response messages to request messages
- Authentication of caller to service and service to caller

To help reduce network administration and eliminate protocol roll-over errors, implementation bugs, and user errors, features that detect the following conditions are useful:

- RPC protocol mismatches
- Remote program protocol version mismatches
- Protocol errors (such as misspecification of a procedure’s parameters)
- Reasons why remote authentication failed
- Any other reasons why the desired procedure was not called

RPC Messages

The initial structure of an RPC message is as follows:

```
struct rpc_msg {
    unsigned int  xid;
    union switch (enum msg_type mtype) {
        case CALL:
            call_body cbody;
        case REPLY:
            reply_body rbody;
    } body;
};
```

All RPC call and reply messages start with a transaction identifier, `xid`, which is followed by a two-armed discriminated union. The union’s discriminant is **msg_type**, which switches to one of the following message types: CALL or REPLY. The **msg_type** has the following enumeration:

```
enum msg_type {
    CALL    = 0,
    REPLY   = 1
};
```

The `xid` parameter is used by clients matching a reply message to a call message or by servers detecting retransmissions. The server side does not treat the `xid` parameter as a sequence number.

The initial structure of an RPC message is followed by the body of the message. The body of a call message has one form. The body of a reply message, however, takes one of two forms, depending on whether a call is accepted or rejected by the server.

RPC Call Message

Each remote procedure call message contains the following unsigned integer fields to uniquely identify the remote procedure:

- Program number
- Program version number

- Procedure number

The body of an RPC call message takes the following form:

```
struct call_body {
    rpcvers_t rpcvers;
    rpcprog_t prog;
    rpcvers_t vers;
    rpcproc_t proc;
    opaque_auth cred;
    opaque_auth verf;
    1 parameter
    2 parameter . . .
};
```

The parameters for this structure are as follows:

<i>rpcvers</i>	Specifies the version number of the RPC protocol. The value of this parameter is 2 to indicate the second version of RPC.
<i>prog</i>	Specifies the number that identifies the remote program. This is an assigned number represented in a protocol that identifies the program needed to call a remote procedure. Program numbers are administered by a central authority and documented in the program's protocol specification.
<i>vers</i>	Specifies the number that identifies the remote program version. As a remote program's protocols are implemented, they evolve and change. Version numbers are assigned to identify different stages of a protocol's evolution. Servers can service requests for different versions of the same protocol simultaneously.
<i>proc</i>	Specifies the number of the procedure associated with the remote program being called. These numbers are documented in the specific program's protocol specification. For example, a protocol's specification can list the read procedure as procedure number 5 or the write procedure as procedure number 12.
<i>cred</i>	Specifies the credentials-authentication parameter that identifies the caller as having permission to call the remote program. This parameter is passed as an opaque data structure, which means the data is not interpreted as it is passed from the client to the server.
<i>verf</i>	Specifies the verifier-authentication parameter that identifies the caller to the server. This parameter is passed as an opaque data structure, which means the data is not interpreted as it is passed from the client to the server.
<i>1 parameter</i>	Denotes a procedure-specific parameter.
<i>2 parameter</i>	Denotes a procedure-specific parameter.

The client can send a broadcast packet to the network and wait for numerous replies from various servers. The client can also send an arbitrarily large sequence of call messages in a batch to the server.

Derived Types

For Itanium-based, the LDT (large data types) feature is turned on for compiling.

For Itanium-based, the derived types are as follows:

Derived Types in a 64-bit Environment		
typedef	unsigned integer	rpcprog_t
typedef	unsigned integer	rpcvers_t
typedef	unsigned integer	rpcproc_t

In a 32-bit environment, the derived types are as follows:

Derived Types in a 32-bit Environment		
typedef	unsigned long	rpcprog_t
typedef	unsigned long	rpcvers_t
typedef	unsigned long	rpcproc_t

RPC Reply Message

The RPC protocol for a reply message varies depending on whether the call message is accepted or rejected by the network server. See “The Reply to an Accepted Request” and “The Reply to a Rejected Request” on page 137.

The reply message to a request contains information to distinguish the following conditions:

- RPC executed the call message successfully.
- The remote implementation of RPC is not protocol version 2. The lowest and highest supported RPC version numbers are returned.
- The remote program is not available on the remote system.
- The remote program does not support the requested version number. The lowest and highest supported remote program version numbers are returned.
- The requested procedure number does not exist. This is usually a caller-side protocol or programming error.

The RPC reply message takes the following form:

```
enum reply_stat stat {
    MSG_ACCEPTED = 0,
    MSG_DENIED   = 1
};
```

The enum **reply_stat** discriminant acts as a switch to the rejected or accepted reply message forms.

The Reply to an Accepted Request

An RPC reply message for a request accepted by the network server has the following structure:

```
struct accepted_reply areply {
    opaque_auth verf;
    union switch (enum accept_stat stat) {
        case SUCCESS:
            opaque results {0};
            /* procedure specific results start here */
        case PROG_MISMATCH:
            struct {
                unsigned int low;
                unsigned int high;
            } mismatch_info;
        default:
            void;
    } reply_data;
};
```

The structures within the accepted reply are:

<code>opaque_auth <i>verf</i></code>	Authentication verifier generated by the server to identify itself to the caller.
<code>enum accept_stat</code>	A discriminant that acts as a switch between SUCCESS, PROG_MISMATCH, and other appropriate conditions.

The **accept_stat** enumeration data type has the following definitions:

```

enum accept_stat {
    SUCCESS = 0, /* RPC executed successfully */
    PROG_UNAVAIL = 1, /* remote has not exported program */
    PROG_MISMATCH = 2, /* remote cannot support version # */
    PROC_UNAVAIL = 3, /* program cannot support procedure */
    GARBAGE_ARGS = 4, /* procedure cannot decode params */
};

```

The structures within the **accept_stat** enumeration data type are defined as follows:

SUCCESS	RPC call is successful.
PROG_UNAVAIL	The remote server has not exported the program.
PROG_MISMATCH	The remote server cannot support the client's version number. Returns the lowest and highest version numbers of the remote program that are supported by the server.
PROC_UNAVAIL	The program cannot support the requested procedure.
GARBAGE_ARGS	The procedure cannot decode the parameters specified in the call.

Note: An error condition can exist even when a call message is accepted by the server.

The Reply to a Rejected Request

A call message can be rejected by the server for two reasons: either the server is not running a compatible version of the RPC protocol, or there is an authentication failure.

An RPC reply message for a request rejected by the network server has the following structure:

```

struct rejected_reply rreply {
union switch (enum reject_stat stat) {
    case RPC_MISMATCH:
        struct {
            unsigned int low;
            unsigned int high;
        } mismatch_info;
    case AUTH_ERROR:
        enum auth_stat stat;
};

```

The **enum reject_stat** discriminant acts as a switch between **RPC_MISMATCH** and **AUTH_ERROR**. The rejected call message returns one of the following status conditions:

```

enum reject_stat {
    RPC_MISMATCH = 0, /* RPC version number is not 2 */
    AUTH_ERROR = 1, /* remote cannot authenticate caller */
};

```

RPC_MISMATCH	The server is not running a compatible version of the RPC protocol. The server returns the lowest and highest version numbers available.
AUTH_ERROR	The server refuses to authenticate the caller and returns a failure status with the value enum auth_stat . Authentication may fail because of bad or rejected credentials, bad or rejected verifier, expired or replayed verifier, or security problems.

If the server does not authenticate the caller, **AUTH_ERROR** returns one of the following conditions as the failure status:

```

enum auth_stat {
    AUTH_BADCRED = 1, /* bad credentials */
    AUTH_REJECTEDCRED = 2, /* begin new session */
    AUTH_BADVERF = 3, /* bad verifier */
    AUTH_REJECTEDVERF = 4, /* expired or replayed */
    AUTH_TOOWEAK = 5, /* rejected for security*/
};

```

Marking Records in RPC Messages

When RPC messages are passed using the TCP/IP byte-stream protocol for data transport, it is important to identify the end of one message and the start of the next one. This is called *record marking* (RM).

A *record* is composed of one or more record fragments. A *record fragment* is a four-byte header, followed by 0 to 232 -1 bytes of fragment data. The bytes encode an unsigned binary number, similar to XDR integers, in which the order of bytes is from highest to lowest. This binary number encodes a Boolean and an unsigned binary value of 31 bits.

The Boolean value is the highest-order bit of the header. A Boolean value of 1 indicates the last fragment of the record. The unsigned binary value is the length, in bytes, of the data fragment.

Note: A protocol disagreement between client and server can cause remote procedure parameters to be unintelligible to the server.

RPC Authentication

The caller may not want to identify itself to the server, and the server may not require an ID from the caller. However, some network services, such as the Network File System (NFS), require stronger security. Remote Procedure Call (RPC) authentication provides a certain degree of security.

The following are part of RPC authentication:

- “RPC Authentication Protocol”
- “NULL Authentication” on page 139
- “UNIX Authentication” on page 139
- “Data Encryption Standard (DES) Authentication” on page 140
- “DES Authentication Protocol” on page 142
- “Diffie-Hellman Encryption” on page 143

RPC deals only with authentication and not with access control of individual services. Each service must implement its own access control policy and reflect this policy as return statuses in its protocol. The programmer can build additional security and access controls on top of the message authentication.

The authentication subsystem of the RPC package is open-ended. Different forms of authentication can be associated with RPC clients. That is, multiple types of authentication are easily supported at one time. Examples of authentication types include UNIX, DES, and NULL. The default authentication type is none (**AUTH_NULL**).

RPC Authentication Protocol

The RPC protocol provisions for authentication of the caller to the server, and vice versa, are provided as part of the RPC protocol. Every remote procedure call is authenticated by the RPC package on the server. Similarly, the RPC client package generates and sends authentication parameters. The call message has two authentication fields: credentials and verifier. The reply message has one authentication field: response verifier.

The following RPC protocol specification defines as an opaque data type the credentials of the call message and the verifiers of both the call and reply messages:

```
enum auth_flavor {
    AUTH_NULL    = 0,
    AUTH_UNIX    = 1,
    AUTH_SHORT    = 2,
    AUTH_DES     = 3
    /* and more to be defined */
};
```

```

struct opaque_auth {
    auth_flavor flavor;
    opaque body<400>;
};

```

Any **opaque_auth** structure is an **auth_flavor** enumeration followed by bytes that are opaque to the RPC protocol implementation. The interpretation and semantics of the data contained within the authentication fields are specified by individual, independent authentication protocol specifications.

If authentication parameters are rejected, response messages state the reasons. A server can support multiple types of authentication at one time.

NULL Authentication

Sometimes, the RPC caller does not know its own identity or the server does not need to know the caller's identity. In these cases, the **AUTH_NULL** authentication type can be used in both the call message and response messages. The bytes of the **opaque_auth** body are undefined. The opaque length should be 0.

UNIX Authentication

A process calling a remote procedure might need to identify itself as it is identified on the UNIX system. The value of the credential's discriminant of an RPC call message is **AUTH_UNIX**. The bytes of the credential's opaque body encode the following structure:

```

struct auth_unix {
    unsigned    stamp;
    string      machinename;
    unsigned    uid;
    unsigned    gid;
    unsigned    gids;
};

```

The parameters in the structure are defined as follows:

<i>stamp</i>	Specifies the arbitrary ID generated by the caller's workstation.
<i>machinename</i>	Specifies the name of the caller's workstation. The name must not exceed 255 bytes in length.
<i>uid</i>	Specifies the caller's effective user ID.
<i>gid</i>	Specifies the caller's effective group ID.
<i>gids</i>	Specifies the counted array of group IDs that contain the caller as a member. A maximum of 10 groups is allowed.

The verifier accompanying the credentials should be **AUTH_NULL**.

The value of the discriminant in the response verifier of the reply message from the server is either **AUTH_NULL** or **AUTH_SHORT**. If the value is **AUTH_SHORT**, the bytes of the response verifier's string encode an opaque structure. The new opaque structure can then be passed to the server in place of the original **AUTH_UNIX** credentials. The server maintains a cache that maps shorthand opaque structures (passed back by way of an **AUTH_SHORT**-style response verifier) to the original credentials of the caller. The caller saves network bandwidth and server CPU time when the shorthand credentials are used.

Note: The server can eliminate, or flush, the shorthand opaque structures at any time. If this happens, the RPC message will be rejected due to an **AUTH_REJECTEDCRED** authentication error. The original **AUTH_UNIX** credentials can be used when this happens.

UNIX Authentication on the Client Side

When a caller creates a new RPC client handle, the authentication handle of the appropriate transport is set to the default by the **authnone_create** subroutine. The default for an RPC authentication handle is NULL. After creating the client handle, the client can select UNIX authentication with the **authunix_create**

routine. This routine creates an authentication handle with operating system permissions and causes each remote procedure call associated with the handle to carry UNIX credentials.

Note: Authentication information can be destroyed with the **auth_destroy** subroutine. Authentication information should be destroyed if one is attempting to conserve memory.

For more information, see the “Using UNIX Authentication Example” on page 166.

UNIX Authentication on the Server Side

Dealing with authentication issues on the server side is more difficult than dealing with them on the client side. The caller’s RPC package passes the service dispatch routine a request that has an arbitrary authentication style associated with it. The server must then determine which style of authentication the caller used and whether the style is supported by the RPC package.

If the authentication parameter type is not suitable for the calling service, the service dispatch routine calls the **svcerr_weakauth** routine to refuse the remote procedure call. It is *not* customary for the server to check the authentication parameters associated with procedure 0 (**NULLPROC**).

If the service does not have the requested protocol, the service dispatch returns a status for access denied. The **svcerr_systemerr** primitive is called to detect a system error that is not covered by a service protocol.

Data Encryption Standard (DES) Authentication

DES authentication offers more security features than UNIX authentication. For DES authentication to work, the **keyserv** daemon must be running on both the server and client machines. The users at these workstations need public keys assigned in the public key database by the person administering the network. Additionally, each user’s secret key must be decrypted using their **keylogin** command password.

DES authentication can handle the following UNIX problems:

- The naming scheme within UNIX authentication is UNIX-system oriented.
- UNIX authentication lacks a verifier, thereby allowing falsification of credentials.

For more information, see the “DES Authentication Example” on page 168.

DES Authentication Naming Scheme

DES addresses the caller with a simple string of characters instead of an integer specific to a particular operating system. This string of characters is known as the caller’s network name, or *net name*. The server is allowed to interpret the contents of the net name only to identify the caller. Therefore, net names should be unique for each caller in the network.

Each operating system is responsible for implementing DES authentication to generate unique net names for calling on remote servers. Because operating systems can already distinguish local users to their systems, extending this mechanism to the network is simple.

For example, a UNIX user at company xyz with a user ID of 515 might be assigned the following net name: `unix.515@xyz.com`. This net name contains three items that ensure uniqueness. First, only one naming domain in the Internet is called `xyz.com`. In this domain, there is only one UNIX user with user ID 515. Another user on another operating system, such as VMS, in the same naming domain can have the same user ID. However, two users are distinguished by the operating system name. In this example, one user is `unix.515@xyz.com` and the other is `vms.515@xyz.com`.

The first field is actually a naming method rather than an operating system name. Currently, a one-to-one correspondence between naming methods and operating systems exists. If a universal naming standard is agreed upon, the first field will become the name of that standard instead of an operating system name.

DES Authentication Verifiers

Unlike UNIX authentication, DES authentication has a verifier that permits the server to validate the client's credential and the client to validate the server's credential. The content of this verifier is primarily an encrypted time stamp. The time stamp is encrypted by the client and decrypted by the server. If the time stamp is close to real time, then the client encrypted it correctly. To encrypt the time stamp correctly, the client must have the conversation key of the RPC session. The client with the conversation key is the authentic client.

The *conversation key* is a DES key that the client generates and includes in its first remote procedure call to the server. The conversation key is encrypted using a public key scheme in the first transaction. The particular public key scheme used in DES authentication is the Diffie-Hellman system with 192-bit keys. For more information, see "Diffie-Hellman Encryption" on page 143.

For successful validation, both the client and the server need the same notion of current time. If network time synchronization cannot be guaranteed, the client can synchronize with the server before beginning the conversation, perhaps by consulting the Internet Time Server (TIME).

DES Authentication on the Server Side

The method for determining the validity of a client's time stamp depends on which transaction is under consideration. For the first transaction, the server checks only that the time stamp has not expired. For subsequent transactions, the server verifies that the time stamp is greater than the previous time stamp from the same client, and that the time stamp has not expired. A time stamp has expired if the server's time is later than the sum of the client's time stamp plus the client's window. The sum of the time stamp plus the client's window can be thought of as the lifetime of the credential.

DES Authentication on the Client Side

In the first transaction to the server, the client sends an encrypted item, the *window verifier*, that must equal the client's window minus one, as an added check. Otherwise, the client could successfully send random data instead of the time stamp. Other values for the credential are rejected by the server. If the window verifier is accepted by the server, the server returns to the client a verifier equal to the encrypted time stamp, minus one second. If the client receives a different time stamp from the server, the client rejects it.

For subsequent transactions, the client's time stamp is valid if it is greater than the previous time stamp, and has not expired. A time stamp has expired if the server's time is later than the sum of the client's time stamp plus the client's window. The sum of the time stamp plus the client window can be thought of as the lifetime of the credential.

To use DES authentication, the programmer must set the client authentication handle using the **authdes_create** subroutine. This subroutine requires the network name of the owner of the server process, a lifetime for the credential, the address of the host with which to synchronize, and the address of a DES encryption key to use for encrypting time stamps and data.

Nicknames

The server's DES authentication subsystem returns a *nickname* to the client in the verifier response to the first transaction. The nickname is an unsigned integer. The nickname is likely to be an index into a table on the server that stores each client's net name, decrypted DES key, and window. The client can use the nickname in all subsequent transactions instead of passing its net name, encrypted DES key, and window each time. The nickname is not required, but it saves time.

Clock Synchronization

Although the client and server clocks are originally synchronized, they can lose this synchronization. When this happens, the client RPC subsystem normally receives the **RPC_AUTHERROR** error message and should resynchronize.

A client can receive the **RPC_AUTHERROR** message even when the clocks are synchronized. The message indicates that the server's nickname table has been flushed either because of the table's size limitations or a server crash. To receive new nicknames, all clients must resend their original credentials to the server.

DES Authentication Protocol

DES authentication has the following form of eXternal Data Representation (XDR) enumeration:

```
enum authdes_namekind {
    ADN_FULLNAME = 0,
    ADN_NICKNAME = 1
};
typedef opaque des_block[8];
const MAXNETNAMELEN = 255;
```

A credential is either a client's full network name or its nickname. For the first transaction with the server, the client must use its full name. For subsequent transactions, the client can use its nickname. DES authentication protocol includes a 64-bit block of encrypted DES data and specifies the maximum length of a network user's name.

The **authdes_cred union** provides a switch between the full-name and nickname forms, as follows:

```
union authdes_cred switch (authdes_namekind adc_namekind) {
    case ADN_FULLNAME:
        authdes_fullname adc_fullname;
    case ADN_NICKNAME:
        unsigned int adc_nickname;
};
```

The full name contains the network name of the client, an encrypted conversation key, and the window. The window is actually a lifetime for the credential. The server can terminate a client's time stamp and not grant the request if the time indicated by the verifier time stamp plus the window has expired. In the first transaction, the server confirms that the window verifier is one second less than the window. To ensure that requests are granted only once, the server can require time stamps in subsequent requests to be greater than the client's previous time stamps.

The structure for a credential using the client's full network name follows:

```
struct authdes_fullname {
    string name<MAXNETNAMELEN>; /* name of client */
    des_block key; /*PK encrypted conversation key*/
    unsigned int window; /* encrypted window */
};
```

A time stamp encodes the time since midnight, January 1, 1970. The structure for the time stamp follows:

```
struct timestamp {
    unsigned int seconds; /* seconds */
    unsigned int useconds; /* and microseconds */
};
```

The client verifier has the following structure:

```
struct {
    adv_timestamp; /* one DES block */
    adc_fullname.window; /* one half DES block */
    adv_winverf; /* one half DES block */
};
```

The window verifier is only used in the first transaction. In conjunction with the **fullname** credential, these items are packed into the structure shown previously before being encrypted.

This structure is encrypted using CBC mode encryption with an input vector of 0. All other time stamp encryptions use ECB mode encryption. The client's verifier has the following structure:

```

struct authdes_verf_clnt {
    timestamp adv_timestamp;    /* encrypted timestamp */
    unsigned int adv_winverf;   /* encrypted window verifier */
};

```

The server returns the client's time stamp, minus one second, in an encrypted response verifier. This verifier also sends the client an unencrypted nickname to be used in future transactions. The verifier from the server has the following structure:

```

struct authdes_verf_svr {
    timestamp adv_timeverf;    /* encrypted verifier */
    unsigned int adv_nickname; /* new nickname for client */
};

```

Diffie-Hellman Encryption

The public key scheme used in DES authentication is Diffie-Hellman with 192-bit keys. The Diffie-Hellman encryption scheme includes two constants: BASE and MODULUS. Their values for these for the DES authentication protocol are:

```

const BASE = 3;
const MODULUS = "d4a0ba0250b6fd2ec626e7efd637df76c716e22d0944b88b"; /* hex */

```

Two programmers, A and B, can send encrypted messages to each other in the following manner. First, programmers A and B independently generate secret keys at random, which can be represented as SK(A) and SK(B). Both programmers then publish their public keys PK(A) and PK(B) in a public directory. These public keys are computed from the secret keys as follows:

```

PK(A) = ( BASE ** SK(A) ) mod MODULUS
PK(B) = ( BASE ** SK(B) ) mod MODULUS

```

The ** (double asterisk) notation represents exponentiation. Programmers A and B can both arrive at the common key, represented here as CK(A, B), without revealing their secret keys.

Programmer A computes:

```

CK(A, B) = ( PK(B) ** SK(A) ) mod MODULUS

```

while programmer B computes:

```

CK(A, B) = ( PK(A) ** SK(B) ) mod MODULUS

```

These two can be shown to be equivalent:

```

(PK(B) ** SK(A)) mod MODULUS = (PK(A) ** SK(B)) mod MODULUS

```

If the mod MODULUS parameter is omitted, modulo arithmetic can simplify things as follows:

```

PK(B) ** SK(A) = PK(A) ** SK(B)

```

Then, if the result of the previous computation on B replaces PK(B) and the previous computation of A replaces PK(A), the equation is:

```

((BASE ** SK(B)) ** SK(A) = (BASE ** SK(A)) ** SK(B)

```

This equation can be simplified as follows:

```

BASE ** (SK(A) * SK(B)) = BASE ** (SK(A) * SK(B))

```

This produces a common key CK(A, B). This common key is not used directly to encrypt the time stamps used in the protocol. Instead, it is used to encrypt a conversation key that is then used to encrypt the time stamps. In this way, the common key is used as little as possible to prevent it from being broken. Breaking the conversation key usually has less serious consequences because conversations are relatively shortlived.

The conversation key is encrypted using 56-bit DES keys, while the common key is 192 bits. To reduce the number of bits, 56 bits are selected from the common key as follows. The middle eight bytes are selected from the common key and parity is added to the lower order bit of each byte, producing a 56-bit key with eight bits of parity.

RPC Port Mapper Program

Client programs must find the port numbers of the server programs that they intend to use. Network transports do not provide such a service; they merely provide process-to-process message transfer across a network. A message typically contains a transport address consisting of a network number, a host number, and a port number.

A *port* is a logical communications channel in a host. A server process receives messages from the network by waiting on a port. How a process waits on a port varies from one operating system to another, but all systems provide mechanisms that suspend processes until a message arrives at a port. Therefore, messages are sent to the ports at which receiving processes wait for messages.

Ports allow message receivers to be specified in a way that is independent of the conventions of the receiving operating system. The port mapper protocol defines a network service that permits clients to look up the port number of any remote program supported by the server. Because the port mapper program can be implemented on any transport that provides the equivalent of ports, it works for all clients, all servers, and all networks.

The port mapper program maps Remote Procedure Call (RPC) program and version numbers to transport-specific port numbers. The port mapper program makes dynamic binding of remote programs possible. This is desirable because the range of reserved port numbers is small and the number of potential remote programs large. When running only the port mapper on a reserved port, the port numbers of other remote programs can be determined by querying the port mapper.

The port mapper also aids in broadcast RPC. A given RPC program usually has different port number bindings on different machines, so there is no way to directly broadcast to all of these programs. The port mapper, however, has a fixed port number. To broadcast to a given program, the client sends its message to the port mapper located at the broadcast address. Each port mapper that picks up the broadcast then calls the local service specified by the client. When the port mapper receives a reply from the local service, it sends the reply back to the client.

Registering Ports

Every port mapper on every host is associated with port number 111. The port mapper is the only network service that must have a dedicated port. Other network services can be assigned port numbers either statically or dynamically, as long as the services register their ports with their host's port mapper. Typically, a server program based on an RPC library gets a port number at run time by calling an RPC library procedure.

Note: A service on a host can be associated with a different port every time its server program is started. For example, a given network service can be associated with port number 256 on one server and port number 885 on another.

The delegation of port-to-remote program mapping to a port mapper also automates port number administration. Statically mapping ports and remote programs in a file duplicated on each client requires updating all mapping files whenever a new remote program is introduced to a network. The alternative solution, placing the port-to-program mappings in a shared Network File System (NFS) file, would be too centralized. If the file server were to go down in this case, the entire network would also.

The port-to-program mappings, which are maintained by the port mapper server, are called a *portmap*. The port mapper is started automatically whenever a machine is booted. Both the server programs and the

client programs call port mapper procedures. As part of its initialization, a server program calls its host's port mapper to create a portmap entry. Whereas server programs call port mapper programs to update portmap entries, clients call port mapper programs to query portmap entries. To find a remote program's port, a client sends an RPC call message to a server's port mapper. If the remote program is supported on the server, the port mapper returns the relevant port number in an RPC reply message. The client program can then send RPC call messages to the remote program's port. A client program can minimize port mapper calls by caching the port numbers of recently called remote programs.

Note: The port mapper provides an inherently useful service because a portmap is a set of associations between registrants and ports.

Port Mapper Protocol

The following is the port mapper protocol specification in RPC language:

```
const PMAP_PORT = 111;    /* port mapper port number    */
```

The mapping of program (*prog*), version (*vers*), and protocol (*prot*) to the port number (*port*) is shown by the following structure:

```
struct mapping {
    unsigned int prog;
    unsigned int vers;
    unsigned int prot;
    unsigned int port;
};
```

The values supported for the *prot* parameter are:

```
const IPPROTO_TCP = 6;    /* protocol number for TCP/IP    */
const IPPROTO_UDP = 17;   /* protocol number for UDP       */
```

The list of mappings takes the following structure:

```
struct *pmaplist {
    mapping map;
    pmaplist next;
};
```

The structure for arguments to the *callit* parameter follows:

```
struct call_args {
    unsigned int prog;
    unsigned int vers;
    unsigned int proc;
    opaque args<>;
};
```

The results of the *callit* parameter have the following structure:

```
struct call_result {
    unsigned int port;
    opaque res<>;
};
```

The structure for port mapper procedures follows:

```
program PMAP_PROG {
    version PMAP_VERS {
        void
        PMAPPROC_NULL(void)          = 0;
        bool
        PMAPPROC_SET(mapping)        = 1;
        bool
        PMAPPROC_UNSET(mapping)      = 2;
```

```

unsigned int
PMAPPROC_GETPORT(mapping)      = 3;
pmaplist
PMAPPROC_DUMP(void)           = 4;
    call_result
    PMAPPROC_CALLIT(call_args) = 5;
} = 2;
} = 100000;

```

Port Mapper Procedures

The port mapper program currently supports two protocols: User Datagram Protocol (UDP) and Transmission Control Protocol/Internet Protocol (TCP/IP). The port mapper is contacted by port number 111 on both protocols.

A description of the port mapper procedures follows.

PMAPPROC_NULL	This procedure does no work. By convention, procedure 0 of any protocol takes no parameters and returns no results.
PMAPPROC_SET	When a program first becomes available on a machine, it registers itself with the port mapper program on that machine. The program passes its program number (<i>prog</i>), version number (<i>vers</i>), transport protocol number (<i>prot</i>), and the port (<i>port</i>) on which it awaits service request. The procedure returns a Boolean response whose value is either True if the procedure successfully established the mapping, or False if otherwise. The procedure does not establish a mapping if the values for the <i>prog</i> , <i>vers</i> , and <i>prot</i> parameters indicate a mapping already exists.
PMAPPROC_UNSET	When a program becomes unavailable, it should unregister itself with the port mapper program on the same machine. The parameters and results have meanings identical to those of the PMAPPROC_SET procedure. The protocol and port number fields of the argument are ignored.
PMAPPROC_GETPORT	Given a program number (<i>prog</i>), version number (<i>vers</i>), and transport protocol number (<i>prot</i>), this procedure returns the port number on which the program is awaiting call requests. A <i>port</i> value of zero means the program has not been registered. The <i>port</i> parameter of the argument is then ignored.
PMAPPROC_DUMP	This procedure enumerates all entries in the port mapper database. The procedure takes no parameters and returns a list of <i>prog</i> , <i>vers</i> , <i>prot</i> , and <i>port</i> values.
PMAPPROC_CALLIT	This procedure allows a caller to call another remote procedure on the same machine without knowing the remote procedure's port number. It supports broadcasts to arbitrary remote programs through the well-known port mapper port. The <i>prog</i> , <i>vers</i> , and <i>prot</i> parameters, and the bytes of the <i>args</i> parameter of an RPC call represent the program number, version number, procedure number, and arguments, respectively. The PMAPPROC_CALLIT procedure sends a response only if the procedure is successfully run. The port mapper communicates with the remote program using UDP only. The procedure returns the remote program's port number, and the bytes of results are the results of the remote procedure.

Programming in RPC

Remote procedure calls can be made from any language. Remote Procedure Call (RPC) protocol is generally used to communicate between processes on different workstations. However, RPC works just as well for communication between different processes on the same workstation.

The RPC interface can be seen as being divided into three layers: highest, intermediate, and lowest. See the following:

- “Using the Highest Layer of RPC” on page 149
- “Using the Intermediate Layer of RPC” on page 149
- “Using the Lowest Layer of RPC” on page 151

The highest layer of RPC is totally transparent to the operating system, workstation, and network on which it runs. This level is actually a method for using RPC routines, rather than a part of RPC proper.

The intermediate layer is RPC proper. At the intermediate layer, the programmer need not consider details about sockets or other low-level implementation mechanisms. The programmer makes remote procedure calls to routines on other workstations.

The lowest layer of RPC allows the programmer greatest control. Programs written at this level can be more efficient.

Both intermediate and lower-level RPC programming entail assigning program numbers (“Assigning Program Numbers”), version numbers (“Assigning Version Numbers”), and procedure numbers (“Assigning Procedure Numbers” on page 148). An RPC server can be started from the **inetd** daemon (“Starting RPC from the inetd Daemon” on page 153).

Assigning Program Numbers

A central system authority administers the program number (*prog* parameter). A program number permits the implementation of a remote program. The first implementation of a program is usually version number 1.

A program number is assigned by groups of 0x20000000 (decimal 536870912), according to the following list:

0-1xxxxxxx	This group of numbers is predefined and administered by the operating system. The numbers should be identical for all system customers.
20000000-3xxxxxxx	The user defines this group of numbers. The numbers are used for new applications and for debugging new programs.
40000000-5xxxxxxx	This group of numbers is transient and is used for applications that generate program numbers dynamically.
60000000-7xxxxxxx	Reserved.
80000000-9xxxxxxx	Reserved.
a0000000-bxxxxxxx	Reserved.
c0000000-dxxxxxxx	Reserved.
e0000000-fxxxxxxx	Reserved.

The first group of numbers is predefined, and should be identical for all customers. If a customer develops an application that might be of general interest, that application can be registered by assigning a number in the first range. The second group of numbers is reserved for specific customer applications. This range is intended primarily for debugging new programs. The third group is reserved for applications that generate program numbers dynamically. The final groups are reserved for future use and should not be used.

Assigning Version Numbers

Most new protocols evolve into more efficient, stable, and mature protocols. As a program evolves, a new version number (*vers* parameter) is assigned. The version number identifies which version of the protocol the caller is using. The first implementation of a remote program is usually designated as version number 1 (or a similar form). Version numbers make it possible to use old and new protocols through the same server. See “Using Multiple Program Versions Example” on page 176.

Just as remote program protocols may change over several versions, the actual RPC message protocol can also change. Therefore, the call message also contains the RPC version number. In the second version of the RPC protocol specification, the version number is always 2.

Assigning Procedure Numbers

The procedure number (*proc* parameter) identifies the procedure to be called. The procedure number is documented in each program's protocol specification. For example, a file service protocol specification can list the read procedure as procedure 5 and the write procedure as procedure 12.

Using Registered RPC Programs

The RPC program numbers and protocol specifications of standard RPC services are in the header files in the `/usr/include/rpcsvc` directory. The `/etc/rpc` file describes the RPC program numbers in text so that users can identify the number with the name. The names identified in the text can be used in place of RPC program numbers. These programs, however, constitute only a small subset of those that have been registered.

The following is a list of registered RPC programs including the program number, program name, and program description:

Program number	Program name	Program description
100000	PMAPPROG	Port mapper
100001	RSTATPROG	Remote stats
100002	RUSERSPROG	Remote users
100003	NFSPROG	Network File System (NFS)
100004	YPPROG	Network Information Service (NIS)
100005	MOUNTPROG	Mount daemon
100006	DBXPROG	Remote dbx
100007	YPBINDPROG	NLS binder
100008	WALLPROG	Shutdown message
100009	YPPASSWDPROG	yppasswd server
100010	ETHERSTATPROG	Ether stats
100011	RQUOTAPROG	Disk quotas
100012	SPRAYPROG	Spray packets
100013	IBM3270PROG	3270 mapper
100014	IBMRJEPROG	RJE mapper
100015	SELNSVCPROG	Selection service
100016	RDATABASEPROG	Remote database access
100017	REXECPROG	Remote execution
100018	ALICEPROG	Alice Office Automation
100019	SCHEDPROG	Scheduling service
100020	LOCKPROG	Local lock manager
100021	NETLOCKPROG	Network lock manager
100023	STATMON1PROG	Status monitor1
100024	STATMON2PROG	Status monitor2
100025	SELNLIBPROG	Selection library
100026	BOOTPARAMPROG	Boot parameters service
100027	MAZEPROG	Mazewars games
100028	YUPDATEPROG	YP update
100029	KEYSERVEPROG	Key server

Program number	Program name	Program description
100030	SECURECMDPROG	Secure login
100031	NETFWDIPROG	NFS net forwarder init
100032	NETFWDTPROG	NFS net forwarder trans
100033	SUNLINKMAP_PROG	Sunlink MAP
100034	NETMONPROG	Network monitor
100035	DBASEPROG	Lightweight database
100036	PWDAUTHPROG	Password authorization
100037	TFSPROG	Translucent file service
100038	NSEPROG	NSE server
100039	NSE_ACTIVATE_PROG	NSE activate daemon
150001	PCNFSDPROGx	PC password authorization
200000	PYRAMIDLOCKINGPROG	Pyramid-locking
200001	PYRAMIDSYS5	Pyramid-sys5
200002	CADDS_IMAGE	CV cadds_image
300001	ADT_RFLOCKPROG	ADT file locking

Using the Highest Layer of RPC

Programmers who write remote procedure calls can make the highest layer of RPC available to other users through a simple C language front-end routine that entirely hides the networking. To illustrate a call at the highest level, a program can call the **rnusers** routine, a C routine that returns the number of users on a remote workstation. The user need not be explicitly aware of using RPC.

Other RPC service library routines available to the C programmer are as follows:

rnusers	Returns information about users on a remote workstation.
havedisk	Determines whether the remote workstation has a disk.
rstat	Gets performance data from a remote kernel.
rwall	Writes to a specified remote workstation.
yppasswd	Updates a user password in the Network Information Service (NIS).

RPC services, such as the **mount** and **spray** commands, are not available to the C programmer as service library routines. Though unavailable, these services have RPC program numbers and can be invoked with the **callrpc** subroutine. Most of these services have compilable **rpcgen** protocol description files that simplify the process of developing network applications.

For more information, see “Using the Highest Layer of RPC Example” on page 170.

Using the Intermediate Layer of RPC

The intermediate layer RPC routines are used for most applications. The intermediate layer is sometimes overlooked in programming due to its simplicity and lack of flexibility. At this level, RPC does not allow time-out specifications, choice of transport, or process control in case of errors. Nor does the intermediate layer of RPC support multiple types of call authentication. The programmer often needs these kinds of control.

Remote procedure calls are made with the **registerrpc**, **callrpc**, and **svc_run** system routines, which belong to the intermediate layer of RPC. The **registerrpc** and **callrpc** routines are the most fundamental. The **registerrpc** routine obtains a unique system-wide procedure identification number. The **callrpc** routine executes the remote procedure call.

Each RPC procedure is uniquely defined by a program number, version number, and procedure number. The program number specifies a group of related remote procedures, each of which has a different procedure number. Each program also has a version number. Therefore, when a minor change, such as adding a new procedure, is made to a remote service, a new program number need not be assigned.

The RPC interface also handles arbitrary data structures (“Passing Arbitrary Data Types” on page 151), regardless of the different byte orders or structure layout conventions at various workstations. For more information, see the “Using the Intermediate Layer of RPC Example” on page 170.

Using the **registerrpc** Routine

Only the User Datagram Protocol (UDP) transport mechanism can use the **registerrpc** routine. This routine is always safe in conjunction with calls generated by the **callrpc** routine. The UDP transport mechanism can deal only with arguments and results that are less than 8KB in length.

The RPC **registerrpc** routine includes the following parameters:

- Program number
- Version number
- Procedure number to be called
- Procedure name
- XDR (eXternal Data Representation) subroutine that decodes the procedure parameters
- XDR subroutine that encodes the procedure calls

After registering the local procedure, the server program’s main procedure calls the **svc_run** routine, which is the RPC library’s remote procedure dispatcher. The **svc_run** routine then calls the remote procedure in response to RPC messages. The dispatcher uses the XDR data filters that are specified when the remote procedure is registered to handle decoding procedure arguments and encoding results.

Using the **callrpc** Routine

The RPC **callrpc** routine executes remote procedure calls. See “Using the Intermediate Layer of RPC Example” on page 170.

The **callrpc** routine includes the following parameters:

- Name of the remote server workstation
- Program number
- Version number of the program
- Procedure number
- Input XDR filter primitive
- Argument to be encoded and passed to the remote procedure
- Output XDR filter for decoding the results returned by the remote procedure
- Pointer to the location where the procedure’s results are to be stored

Multiple arguments and results can be embedded in structures. If the **callrpc** routine completes successfully, it returns a value of zero. Otherwise, it returns a nonzero value. The return codes are cast in integer data-type values in the **rpc/clnt.h** file.

If the **callrpc** routine gets no answer after several attempts to deliver a message, it returns with an error code. The delivery mechanism is UDP. Adjusting the number of retries or using a different protocol requires the use of the lower layer of the RPC library.

Passing Arbitrary Data Types

The RPC interface can handle arbitrary data structures, regardless of the different byte orders or structure layout conventions on different machines, by converting the structures to a network standard called XDR before sending them over the wire. The process of converting from a particular machine representation to XDR format is called *serializing*, and the reverse process is called *deserializing*.

The input and output parameters of the **callrpc** and **registerrpc** routines can be a built-in or user-supplied procedure. For more information, see “Showing How RPC Passes Arbitrary Data Types Example” on page 175.

The XDR language has the following built-in subroutines:

- **xdr_bool**
- **xdr_char**
- **xdr_u_char**
- **xdr_enum**
- **xdr_int**
- **xdr_u_int**
- **xdr_long**
- **xdr_u_long**
- **xdr_short**
- **xdr_u_short**
- **xdr_wrapstring**

Although the **xdr_string** subroutine exists, it passes three parameters to its XDR routine. The **xdr_string** subroutine cannot be used with the **callrpc** and **registerrpc** subroutines, which pass only two parameters. However, the **xdr_string** routine can be called with the **xdr_wrapstring** routine, which also has only two parameters.

If completion is successful, XDR subroutines return a nonzero value (that is, a True value in the C language). Otherwise, they return a value of zero (False).

In addition to the built-in primitives are the following prefabricated building blocks:

- **xdr_array**
- **xdr_bytes**
- **xdr_opaque**
- **xdr_pointer**
- **xdr_reference**
- **xdr_string**
- **xdr_union**
- **xdr_vector**

Note: An RPC client and server system that uses the TCP protocol cannot get or put more than 64 megabytes (MB) in one RPC call. The constant **TCP_MAX_REQUEST_SIZE** limits this.

In addition to this constant, there is also a user limit on the size, which is 44 bytes less than the limit. In addition, security protocols may take an additional 800 bytes off the limit.

Using the Lowest Layer of RPC

For the higher layers, RPC takes care of many details automatically. However, the lowest layer of the RPC library allows the programmer to change the default values for these details. The lowest layer of RPC

requires familiarity with sockets and their system calls. For more information, see “Using the Lowest Layer of RPC Example” on page 171 and “Using Multiple Program Versions Example” on page 176.

The lowest layer of RPC may be necessary in the following situations:

- The programmer needs to use Transmission Control Protocol/Internet Protocol (TCP/IP). Higher layers use UDP, which restricts RPC calls to 8KB of data. TCP/IP permits calls to send long streams of data.
- The programmer wants to allocate and free memory while serializing or deserializing messages with XDR routines. No system call at the higher levels explicitly permits freeing memory. XDR routines are used for memory allocation as well as for input and output.
- The programmer needs to perform authentication on the client or server side by supplying credentials or verifying them, respectively.

Allocating Memory with XDR

XDR routines not only do input and output, they also do memory allocation. Consider the following XDR routine, **xdr_chararr1**, which deals with a fixed array of bytes with length **SIZE**.

```
xdr_chararr1 (xdrsp, chararr)
    XDR *xdrsp;
    char chararr[];
{
    char *p;
    int len;

    p = chararr;
    len = SIZE;
    return (xdr_bytes (xdrsp, &p, &len, SIZE));
}
```

If space has already been allocated in it, **chararr** can be called from a server. For example:

```
char chararr [SIZE];
svc_getargs (transp, xdr_chararr1, chararr);
```

If you want XDR to do the allocation, you need to rewrite this routine in the following way:

```
xdr_chararr2 (xdrsp, chararrp)
    XDR *xdrsp;
    char **chararrp;
{
    int len;

    len = SIZE;
    return (xdr_bytes (xdrsp, chararrp, &len, SIZE));
}
```

Then the RPC call might look like this:

```
char *arrptr;
arrptr = NULL;
svc_getargs (transp, xdr_chararr2, &arrptr);
/*
*Use the result here
*/
svc_freeargs (transp, xdr_chararr2, &arrptr);
```

The character array can be freed with the **svc_freeargs** macro. This operation does not attempt to free any memory in the variable, indicating the variable is null.

Each XDR routine is responsible for serializing, deserializing, and freeing memory. When an XDR routine is called from the **callrpc** routine, the serializing part is used. When an XDR routine is called from the **svc_getargs** routine, the deserializer is used. When an XDR routine is called from the **svc_freeargs** routine, the memory deallocator is used.

Starting RPC from the inetd Daemon

An RPC server can be started from the **inetd** daemon. The only difference between using the **inetd** daemon and the usual code is that the service creation routine is called. Because the **inet** passes a socket as file descriptor 0, the following form is used:

```
transp = svcudp_create(0);      /* For UDP                */
transp = svctcp_create(0,0,0);  /* For listener TCP sockets */
transp = svcfd_create(0,0,0);  /* For connected TCP sockets */
```

In addition, call the **svc_register** routine as follows:

```
svc_register(transp, PROGNUM, VERSNUM, service, 0)
```

The final flag is 0 because the program is already registered by the **inetd** daemon. To exit from the server process and return control to the **inet**, the user must explicitly exit. The **svc_run** routine never returns.

Entries in the **/etc/inetd.conf** file for RPC services take one of the following two forms:

```
p_name sunrpc_udp udp wait user server args version
p_name sunrpc_tcp tcp wait user server args version
```

where *p_name* is the symbolic name of the program as it appears in the RPC routine, *server* is the program implementing the server, and *version* is the version number of the service.

If the same program handles multiple versions, then the version number can be a range, as in the following:

```
rstatd sunrpc_udp udp wait root /usr/sbin/rpc.rstatd rstatd 100001 1-2
```

Compiling and Linking RPC Programs

RPC subroutines are part of the **libc.a** library. Add the following line to the **Makefile** file:

```
CFLAGS=-D_BSD -DBSD_INCLUDES
```

RPC Features

The features of Remote Procedure Call (RPC) include batching calls (“Batching Remote Procedure Calls”), broadcasting calls (“Broadcasting Remote Procedure Calls” on page 154), callback procedures (“RPC Call-back Procedures” on page 154), and using the **select** subroutine (“Using the select Subroutine on the Server Side” on page 155). Batching allows a client to send an arbitrarily large sequence of call messages to a server. Broadcasting allows a client to send a data packet to the network and wait for numerous replies. Callback procedures permit a server to become a client and make an RPC callback to the client’s process. The **select** subroutine examines the I/O descriptor sets whose addresses are passed in the *readfds*, *writfds*, and *exceptfds* parameters to see if some of their descriptors are ready for reading or writing, or have an exceptional condition pending. It then returns the total number of ready descriptors in all the sets.

RPC is also used for the **rcp** program on Transmission Control Protocol/Internet Protocol (TCP/IP). See “rcp Process on TCP Example” on page 178.

Batching Remote Procedure Calls

Batching allows a client to send an arbitrarily large sequence of call messages to a server. Batching typically uses reliable byte stream protocols, such as TCP/IP, for its transport. When batching, the client never waits for a reply from the server, and the server does not send replies to batched requests. Normally, a sequence of batch calls should be terminated by a legitimate, nonbatched RPC to flush the pipeline.

The RPC architecture is designed so that clients send a call message and then wait for servers to reply that the call succeeded. This implies that clients do not compute while servers are processing a call.

However, the client may not want or need an acknowledgment for every message sent. Therefore, clients can use RPC batch facilities to continue computing while they wait for a response.

Batching can be thought of as placing RPC messages in a pipeline of calls to a desired server. Batching assumes the following:

- Each remote procedure call in the pipeline requires no response from the server, and the server does not send a response message.
- The pipeline of calls is transported on a reliable byte stream transport such as TCP/IP.

For a client to use batching, the client must perform remote procedure calls on a TCP/IP-based transport. Batched calls must have the following attributes:

- The resulting XDR routine must be 0 (null).
- The remote procedure call's time out must be 0.

Because the server sends no message, the clients are not notified of any failures that occur. Therefore, clients must handle their own errors.

Because the server does not respond to every call, the client can generate new calls that run parallel to the server's execution of previous calls. Furthermore, the TCP/IP implementation can buffer many call messages, and send them to the server with one **write** subroutine. This overlapped execution decreases the interprocess communication overhead of the client and server processes as well as the total elapsed time of a series of calls. Batched calls are buffered, so the client should eventually perform a nonbatched remote procedure call to flush the pipeline with positive acknowledgment.

Broadcasting Remote Procedure Calls

In broadcast RPC-based protocols, the client sends a broadcast packet to the network and waits for numerous replies. Broadcast RPC uses only packet-based protocols, such as User Datagram Protocol/Internet Protocol (UDP/IP), for its transports. Servers that support broadcast protocols respond only when the request is successfully processed and remain silent when errors occur. Broadcast RPC requires the RPC port mapper service to achieve its semantics. The **portmap** daemon converts RPC program numbers into Internet protocol port numbers. See "Broadcasting a Remote Procedure Call Example" on page 177.

The main differences between broadcast RPC and normal RPC are as follows:

- Normal RPC expects only one answer, while broadcast RPC expects one or more answers from each responding machine.
- The implementation of broadcast RPC treats unsuccessful responses as garbage by filtering them out. Therefore, if there is a version mismatch between the broadcaster and a remote service, the user of broadcast RPC may never know.
- All broadcast messages are sent to the port-mapping port. As a result, only services that register themselves with their port mapper are accessible through the broadcast RPC mechanism.
- Broadcast requests are limited in size to the maximum transfer unit (MTU) of the local network. For the Ethernet system, the MTU is 1500 bytes.
- Broadcast RPC is supported only by packet-oriented (connectionless) transport protocols such as UDP/IP.

RPC Call-back Procedures

Occasionally, the server may need to become a client by making an RPC callback to the client's process. To make an RPC callback, the user needs a program number on which to make the call. The program number is dynamically generated and should be in the transient range, 0x40000000 to 0x5fffffff. See "RPC Callback Procedures Example" on page 180 for more information.

Using the select Subroutine on the Server Side

The **select** subroutine checks the specified file descriptors and message queues to see if they are ready for reading (receiving) or writing (sending), or if they have an exceptional condition pending. A **select** procedure allows the server to interrupt an activity, check for data, and then continue processing the activity. For example, if the server processes RPC requests while performing another activity that involves periodically updating a data structure, the process can set an alarm signal to notify the server before calling the **svc_run** routine. However, if the current activity is waiting on a file descriptor, the call to the **svc_run** routine does not work. See “Using the select Subroutine Example” on page 178 for more information.

A programmer can bypass the **svc_run** routine and call the **svc_getreqset** routine directly. It is necessary to know the file descriptors of the sockets associated with the programs being waited on. The programmer can have a **select** statement that waits on both the RPC socket and specified descriptors.

Note: The *svc_fds* parameter is a bit mask of all the file descriptors that RPC is using for services. It can change each time an RPC library routine is called because descriptors are continually opened and closed. TCP/IP connections are an example.

RPC Language

The Remote Procedure Call Language (RPCL) is identical to the eXternal Data Representation (XDR) language, except for the added program definition.

RPC Language Descriptions

Because XDR data types are described in a formal language, procedures that operate on these data types must be described in a formal language. The RPCL, an extension to the XDR language, is used for this purpose.

RPC uses RPCL as the input language for its protocol and routines. RPCL specifies data types used by RPC and generates XDR routines that standardize representation of the types. To implement service protocols and routines, RPCL uses the **rpcgen** command to compile input in corresponding C language code.

RPC language descriptions include:

- “Definitions”
- “Structures” on page 156
- “Unions” on page 156
- “Enumerations” on page 157
- “Type Definitions” on page 157
- “Constants” on page 157
- “Programs” on page 157
- “Declarations” on page 158

For more information, see “RPC Language ping Program Example” on page 183. For instances where these rules do not apply, see “Exceptions to the RPCL Rules” on page 159.

Definitions

An RPCL file consists of a series of definitions in the following format:

```
definition-list:  
    definition ";"  
    definition ";" definition-list
```

RPCL recognizes the following six types of definitions:

```

definition:
    enum-definition
    struct-definition
    union-definition
    typedef-definition
    const-definition
    program-definition

```

Structures

The C language structures are usually located in header files in either the `/usr/include` or `/usr/include/sys` directory, but they can be located in any directory in the file system. An XDR structure is declared almost exactly like its C language counterpart; for example:

```

struct-definition:
    "struct" struct-ident "{"
    declaration-list
    "}"
declaration-list:
    declaration ";"
    declaration ";" declaration-list

```

Compare the following XDR structure to a two-dimensional coordinate with the C structure that it is compiled into in the output header file.

```

struct coord {          struct coord {
    int x;      -->    int x;
    int y;          int y;
};                  };
                    typedef struct coord coord;

```

Here, the output is identical to the input, except for the added typedef at the end of the output. As a result, the programmer can use `coord` instead of `struct coord` when declaring items.

Unions

XDR unions are discriminated unions and look different from C unions. XDR unions are more analogous to Pascal variant records than to C unions. Following is an XDR union definition:

```

union-definition:
    "union" union-ident "switch" "(" declaration ")" "{"
    case-list
    "}"
case-list:
    "case" value ":" declaration ";"
    "default" ":" declaration ";"
    "case" value ":" declaration ";" case-list

```

Following is an example of a type that might be returned as the result of a read data operation. If there is no error, the type returns a block of data; otherwise, it returns nothing.

```

union read_result switch (int errno) {
case 0
    opaque data[1024];
default:
    void;
};

```

The type is compiled into the following structure:

```

struct read_result {
    int errno;
    union {

```

```

        char data[1024];
    }read_result_u;
};
typedef struct read_result read_result;

```

Note: The union component of this output structure is identical to the type, except for the trailing `_u`.

Enumerations

XDR enumerations have the same syntax as C enumerations.

```

enum-definition:
    "enum" enum-ident "{"
    enum-value-list
    "\""
enum-value-list:
    enum-value
    enum-value "," enum-value-list
enum-value:
    enum-value-ident
    enum-value-ident "=" value

```

Compare the following example of an XDR enumeration with the C enumeration it is compiled into.

```

enum colortype {          enum colortype {
    RED = 0,              RED = 0,
    GREEN = 1,          --> GREEN = 1,
    BLUE = 2,            BLUE = 2,
};                        };
                          typedef enum colortype colortype;

```

Type Definitions

XDR type definitions (typedefs) have the same syntax as C typedefs.

```

typedef-definition:
    "typedef" declaration

```

The following example defines an `fname_type` used for declaring file-name strings with a maximum length of 255 characters.

```
typedef string fname_type<255>; --> typedef char *fname_type;
```

Constants

XDR constants can be used wherever an integer constant is required. The definition for a constant is:

```

const-definition:
    "const" const-ident "=" integer

```

For example, the following defines a constant `DOZEN` equal to 12.

```
const DOZEN = 12; --> #define DOZEN 12
```

Programs

RPC programs are declared using the following syntax:

```

program-definition:
    "program" program-ident "{"
    version-list
    "}" "=" value
version-list:
    version ";"
    version ";" version-list

```

```

version:
    "version" version-ident "{"
        procedure-list
    "}" "=" value
procedure-list:
    procedure ";"
    procedure ";" procedure-list
procedure:
    type-ident procedure-ident "(" type-ident ")" "=" value

```

The time protocol is defined as follows:

```

/*
 * time.x: Get or set the time. Time is represented as number
 * of seconds since 0:00, January 1, 1970.
 */
program TIMEPROG {
    version TIMEEVERS {
        unsigned int TIMEGET (void) = 1;
        void TIMESET (unsigned) = 2;
    } = 1;
} = 44;

```

This file compiles into the following **#define** statements in the output header file:

```

#define TIMEPROG 44
#define TIMEEVERS 1
#define TIMEGET 1
#define TIMESET 2

```

Declarations

XDR includes four types of declarations: simple declarations, fixed-length array declarations, variable-length array declarations, and pointer declarations. These declarations have the following forms:

```

declaration:
    simple-declaration
    fixed-array-declaration
    variable-array-declaration
    pointer-declaration

```

Simple Declarations

Simple XDR declarations are like simple C declarations, as follows:

```

simple-declaration:
    type-ident variable-ident

```

An example of a simple declaration is:

```

colortype color; --> colortype color;

```

Fixed-length Array Declarations

Fixed-length array declarations are like C array declarations, as follows:

```

fixed-array-declaration:
    type-ident variable-ident "[" value "]"

```

An example of a fixed-length array declaration is:

```

colortype palette[8]; --> colortype palette[8]

```

Variable-length Array Declarations

Variable-length array declarations have no explicit syntax in C, so XDR invents its own syntax using angle brackets. The maximum size is specified between the angle brackets. A specific size can be omitted to indicate that the array may be of any size.

```
variable-array-declaration:
    type-ident variable-ident "<" value ">"
    type-ident variable-ident "<" ">"
```

An example of a set of variable-length array declarations is:

```
int heights<12>;          /* at most 12 items */
int widths<>;             /* any number of items */
```

Note: The maximum size is specified between the angle brackets. The number, but not the angle brackets, may be omitted to indicate that the array can be of any size.

Because variable-length arrays have no explicit syntax in C, these declarations are actually compiled into structure definitions, signified by `struct`. For example, the `heights` declaration is compiled into the following structure:

```
struct {
    u_int heights_len; /* # of items in array */
    int *heights_val; /* # pointer to array */
} heights;
```

Pointer Declarations

Pointer declarations are made in XDR exactly as they are in C. The programmer cannot send pointers over a network, but can use XDR pointers for sending recursive data types such as lists and trees. In XDR language, the type is called `optional-data`, instead of `pointer`. Pointer declarations have the following form in XDR language:

```
pointer-declaration:
    type-ident "*" variable-ident
```

An example of a pointer declaration is:

```
listitem *next; --> listitem *next;
```

RPCL Syntax Requirements for Program Definition

The RPCL has the following syntax requirements:

- The **program** and **version** keywords are added and cannot be used as identifiers.
- A version name cannot occur more than once within the scope of a program definition. Nor can a version number occur more than once within the scope of a program definition.
- A procedure name cannot occur more than once within the scope of a version definition. Nor can a procedure number occur more than once within the scope of a version definition.
- Program identifiers are in the same name space as the **constant** and **type** identifiers.
- Only unsigned constants can be assigned to **program**, **version**, and **procedure** definitions.

Exceptions to the RPCL Rules

Exceptions to the RPC language rules include Booleans, strings, opaque data, and voids.

Booleans

The C language has no built-in Boolean type. However, the RPC library uses a Boolean type called `bool_t`, which is either `True` or `False`. Objects that are declared as type `bool` in XDR language are compiled into `bool_t` in the output header file; for example:

```
bool married; --> bool_t married;
```

Strings

The C language has no built-in string type. Instead, it uses the null-terminated `char *` convention. In XDR language, strings are declared using the **string** keyword, and then compiled into `char *` in the output

header file. The maximum size contained in the angle brackets specifies the maximum number of characters allowed in the strings (not counting the null character). The maximum size may be left off, indicating a string of arbitrary length.

Compare the following examples:

```
string name<32>; --> char *name;
string longname<>; --> char *longname;
```

Opaque Data

Opaque data is used in RPC and XDR to describe untyped data, which consists of sequences of arbitrary bytes. Opaque data may be declared either as a fixed-length or variable-length array, as in the following examples:

```
opaque diskblock[512]; --> char diskblock[512];
opaque filedata<1024>; --> struct {
    u_int filedata_len;
    char *filedata_val;
} filedata
```

Voids

In a void declaration, the variable is not named. The declaration is `void`. Void declarations can occur as the argument or result of a remote procedure in only two places: union definitions and program definitions.

rpcgen Protocol Compiler

The **rpcgen** protocol compiler accepts a remote program interface definition written in the Remote Procedure Call language (RPCL), which is similar to the C language. The **rpcgen** compiler helps programmers write RPC applications in a simple and direct manner. The **rpcgen** compiler debugs the network interface code, thereby allowing programmers to spend their time debugging the main features of their applications.

The **rpcgen** compiler produces a C language output that includes the following:

- Stub versions of the client and server routines
- Server skeleton
- eXternal Data Representation (XDR) filter routines for parameters and results
- A header file that contains common definitions of constants and macros

Client stubs interface with the RPC library to effectively hide the network from its callers. Server stubs similarly hide the network from server procedures invoked by remote clients. The **rpcgen** output files can be compiled and linked in the usual way. Using any language, programmers write server procedures and link them with the server skeleton to get an executable server program.

When application programs use the **rpcgen** compiler, there are many details to consider. Of particular importance is the writing of XDR routines needed to convert procedure arguments and results into the network format, and vice versa.

Converting Local Procedures into Remote Procedures

Applications running at a single workstation can be converted to run over the network. A converted procedure can be called from anywhere in the network. Generally, it is necessary to identify the types for all procedure inputs and outputs. A null procedure (procedure 0) is not necessary because the **rpcgen** compiler generates it automatically. For more information, see “Converting Local Procedures into Remote Procedures Example” on page 184.

Generating XDR Routines

The **rpcgen** compiler can be used to generate the XDR routines necessary to convert local data structures into network format, and vice versa. Some types can be defined using the **struct**, **union**, and **enum** keywords. However, these keywords should not be used in subsequent declarations of variables of these same types. The **rpcgen** compiler compiles RPC unions into C structures. It is an error to declare these unions using the **union** keyword. For more information, see “Generating XDR Routines Example” on page 187.

C Preprocessor

The C language preprocessor is run on all input files before they are compiled, making all preprocessor directives within a **.x** file legal. Four symbols can be defined, depending upon which output file is generated. The symbols and their uses are:

RPC_HDR	Represents header file output.
RPC_XDR	Represents XDR routine output.
RPC_SVC	Represents server skeleton output.
RPC_CLNT	Represents client stub output.

The **rpcgen** compiler also does some preprocessing. Any line that begins with a % (percent sign) is passed directly into the output file without an interpretation of the line. Use of the percent feature is not generally recommended, since there is no guarantee that the compiler will put the output where it is intended.

Changing Time Outs

When using the **clnt_create** subroutine, RPC sets a default time out of 25 seconds for remote procedure calls. The time-out default can be changed using the **clnt_control** subroutine. The following code fragment illustrates the use of this routine:

```
struct timeval tv
CLIENT *cl;
cl=clnt_create("somehost", SOMEPROG, SOMEVERS, "tcp");
if (cl=NULL) {
    exit(1);
}
tv.tv_sec=60; /* change timeout to 1 minute */
tv.tv_usec=0;
clnt_control(cl, CLSET_TIMEOUT, &tv);
```

Handling Broadcast on the Server Side

When a client calls a procedure through broadcast RPC, the server normally replies only if it can provide useful information to the client. This prevents flooding the network with useless replies.

To prevent the server from replying, a remote procedure can return null as its result. The server code generated by the **rpcgen** compiler detects this and does not send a reply. For example, the following procedure replies only if it interprets itself to be a server:

```
void *
reply_if_nfserver()
{
    char notnull; /* just here so we can use its address */
    if {access("/etc/exports", F_OK) < 0} {
        return (NULL); /* prevent RPC from replying */
    }
    /*
    *return non-null pointer so RPC will send out a reply
    */
    return ((void *) &notnull);
}
```

If a procedure returns type `void`, the server must return a nonnull pointer in order for RPC to reply.

Other Information Passed to Server Procedures

Server procedures often want more information about a remote procedure call than just its arguments. For example, getting authentication information is important to procedures that implement some level of security. This additional information is supplied to the server procedure as a second argument. The following example program that allows only root users to print a message on the console, demonstrates the use of the second argument:

```
int *
printmessage_1(msg, rq)
    char **msg;
    struct svc_req *rq;
{
    static in result; /* Must be static */
    FILE *f;
    struct authunix_parms *aup;
    aup=(struct authunix_parms *)rq->rq_clntcred;
    if (aup->aup_uid !=0) {
        result=0;
        return (&result);
    }
    /*
    *Same code as before.
    */
}
```

List of RPC Programming References

The list includes:

- “Subroutines and Macros”
- “Examples” on page 165

Subroutines and Macros

The list of subroutines and macros is arranged by function:

- “Authenticating Remote Procedure Calls”
- “Managing the Client” on page 163
- “Managing the Server” on page 164
- “Using RPC Utilities” on page 165
- “Using DES Interface to the keyser Daemon” on page 165
- “Interfacing to the portmap Daemon” on page 165
- “Describing and Encoding Remote Procedure Calls” on page 165

Authenticating Remote Procedure Calls

RPC provides these subroutines and macros for creating and destroying authentication information:

authnone_create	Creates null authentication information.
authunix_create	Creates an authentication handle with operating system permissions.
authunix_create_default	Sets the authentication to the default.
authdes_create	Enables the use of DES from the client side.
authdes_getucrd	Maps a DES credential into a UNIX credential.
auth_destroy	Destroys authentication information.

Managing the Client

RPC provides subroutines and macros for the following client management tasks:

- “Creating an RPC Client for a Remote Program”
- “Changing or Retrieving Client Information”
- “Destroying a Client RPC Handle”
- “Broadcasting a Remote Procedure Call”
- “Calling a Remote Procedure”
- “Freeing Memory Allocated by RPC and XDR”
- “Handling Client Errors”

Creating an RPC Client for a Remote Program:

<code>clntraw_create</code>	Creates a sample RPC client handle for simulation.
<code>clnttcp_create</code>	Creates a Transmission Control Protocol/Internet Protocol (TCP/IP) client transport handle.
<code>clntudp_create</code>	Creates a User Datagram Protocol/Internet Protocol (UDP/IP) client transport handle.
<code>clnt_create</code>	Creates a generic client transport handle.

Changing or Retrieving Client Information:

<code>clnt_control</code>	Changes or retrieves information about a client object.
---------------------------	---

Destroying a Client RPC Handle:

<code>clnt_destroy</code>	Destroys a client’s RPC handle.
---------------------------	---------------------------------

Broadcasting a Remote Procedure Call:

<code>clnt_broadcast</code>	Broadcasts a remote procedure call to all network hosts.
-----------------------------	--

Calling a Remote Procedure:

<code>callrpc</code>	Calls the remote procedure on the machine associated with the <i>host</i> parameter.
<code>clnt_call</code>	Calls the remote procedure associated with the <i>clnt</i> parameter.

Freeing Memory Allocated by RPC and XDR:

<code>clnt_freeres</code>	Frees memory allocated by RPC and XDR.
---------------------------	--

Handling Client Errors:

<code>clnt_pcreateerror</code>	Identifies why a client RPC handle was not created.
<code>clnt_perrno</code>	Specifies the condition of the <i>stat</i> parameter.
<code>clnt_perror</code>	Determines why a remote procedure call failed.
<code>clnt_geterr</code>	Copies error information from a client transport handle.
<code>clnt_screateerror</code>	Identifies why a client RPC handle was not created.
<code>clnt_serrno</code>	Specifies the condition of the <i>stat</i> parameter.
<code>clnt_serror</code>	Indicates why a remote procedure call failed.

Managing the Server

RPC provides subroutines and macros for the following server management tasks:

- “Creating an RPC Service Transport Handle”
- “Destroying an RPC Service Transport Handle”
- “Registering and Unregistering RPC Procedures and Handles”
- “Handling an RPC Request”
- “Handling Server Errors”

Creating an RPC Service Transport Handle:

svcrow_create	Creates a sample RPC service handle for simulation.
svctcp_create	Creates a TCP/IP service transport handle.
svcudp_create	Creates a UDP/IP service transport handle.
svcfcd_create	Creates a service on any open file descriptor.

Destroying an RPC Service Transport Handle:

svc_destroy	Destroys a service transport handle.
--------------------	--------------------------------------

Registering and Unregistering RPC Procedures and Handles:

registerrpc	Registers a procedure with the RPC service.
xprt_register	Registers an RPC service transport handle.
xprt_unregister	Removes an RPC service transport handle.
svc_register	Maps a remote procedure.
svc_unregister	Removes mappings between procedures and objects.

Handling an RPC Request:

svc_run	Signals a wait for the arrival of RPC requests.
svc_getreqset	Serves an RPC request.
svc_getargs	Decodes the arguments of an RPC request.
svc_sendreply	Sends back the results of a remote procedure call.
svc_freeargs	Frees data allocated by the RPC and XDR system.
svc_getcaller	Gets the network address of the caller of a procedure.

Handling Server Errors:

svcerr_auth	Indicates that the remote procedure call cannot be completed due to an authentication error.
svcerr_decode	Indicates that the parameters of a request cannot be decoded.
svcerr_noproc	Indicates that the remote procedure call cannot be completed because the program cannot support the requested procedure.
svcerr_noprog	Indicates that the remote procedure call cannot be completed because the program is not registered.
svcerr_progvers	Indicates that the remote procedure call cannot be completed because the program version is not registered.
svcerr_systemerr	Indicates that the remote procedure call cannot be completed due to an error not covered by any protocol.
svcerr_weakauth	Indicates that the remote procedure call cannot be completed due to insufficient authentication security parameters.

Using RPC Utilities

host2netname	Converts a host name to a network name.
netname2host	Converts a network name to a host name.
netname2user	Converts a network name to a user ID.
user2netname	Converts a user ID to a network name.
getnetname	Installs the network name of the caller in the array.
get_myaddress	Gets the user's IP address.
getrpcent, getrpcbyname, getrpcbynumber, setrpcent, or endrpcent	Accesses the /etc/rpc file.
rtime	Returns the remote time in the timeval structure.

Using DES Interface to the keyserv Daemon

key_decryptsession	Decrypts a server network name and a DES key.
key_encryptsession	Encrypts a server network name and a DES key.
key_gendes	Requests a secure conversation key from the keyserv daemon.
key_setsecret	Sets the key for the user ID of the calling process.

Interfacing to the portmap Daemon

pmap_getmaps	Returns a list of the current RPC port mappings.
pmap_getport	Requests the port number on which a service waits.
pmap_rmtcall	Instructs the portmap daemon to make an RPC.
pmap_set	Maps an RPC to a port.
pmap_unset	Destroys the mapping between the RPC and the port.
xdr_pmap	Describes parameters for portmap procedures.
xdr_pmaplist	Describes a list of port mappings externally.

Describing and Encoding Remote Procedure Calls

RPC provides subroutines for describing and encoding RPC call and reply messages, authentication, and port mappings:

xdr_accepted_reply	Encodes RPC reply messages.
xdr_authunix_parms	Describes UNIX-style credentials.
xdr_callhdr	Describes RPC call header messages.
xdr_callmsg	Describes RPC call messages.
xdr_opaque_auth	Describes RPC authentication messages.
xdr_rejected_reply	Describes RPC message rejection replies.
xdr_replymsg	Describes RPC message replies.

Examples

- “Using UNIX Authentication Example” on page 166
- “DES Authentication Example” on page 168
- “Using the Highest Layer of RPC Example” on page 170
- “Using the Intermediate Layer of RPC Example” on page 170
- “Using the Lowest Layer of RPC Example” on page 171
- “Showing How RPC Passes Arbitrary Data Types Example” on page 175
- “Using Multiple Program Versions Example” on page 176
- “Broadcasting a Remote Procedure Call Example” on page 177
- “Using the select Subroutine Example” on page 178

- “rcp Process on TCP Example” on page 178
- “RPC Callback Procedures Example” on page 180
- “RPC Language ping Program Example” on page 183
- “Converting Local Procedures into Remote Procedures Example” on page 184
- “Generating XDR Routines Example” on page 187

Using UNIX Authentication Example

This example shows how UNIX authentication works on both the client and server sides.

UNIX Authentication on the Client Side

To use UNIX authentication, the programmer first creates the Remote Procedure Call (RPC) client handle and then sets the authentication parameter.

The RPC client handle is created as follows:

```
clnt = clntudp_create (address, prognum, versnum, wait, sockp)
```

The UNIX authentication parameter is set as follows:

```
clnt->cl_auth = authunix_create_default();
```

Each remote procedure call associated with the client (**clnt**) then carries the following UNIX-style authentication credentials structure:

```
/*
 * UNIX style credentials.
 */
struct authunix_parms {
    u_long  aup_time;      /* credentials creation time */
    char   *aup_machname; /* host name where client is */
    int    aup_uid;       /* client's UNIX effective uid */
    int    aup_gid;       /* client's current group id */
    u_int  aup_len;       /* element length of aup_gids */
    int    *aup_gids;     /* array of groups user is in */
};
```

The **authunix_create_default** subroutine sets these fields by invoking the appropriate subroutines. The UNIX-style authentication is valid until destroyed with the following routine:

```
auth_destroy(clnt->cl_auth);
```

UNIX Authentication on the Server Side

This example shows how to use UNIX authorization on the server side.

The following is a structure definition of a request handle passed to a service dispatch routine at the server:

```
/*
 * An RPC Service request
 */
struct svc_req {
    u_long  rq_prog;      /* service program number */
    u_long  rq_vers;      /* service protocol vers num */
    u_long  rq_proc;      /* desired procedure number */
    struct opaque_auth rq_cred; /* raw credentials from wire */
    caddr_t rq_clntcred; /* credentials (read only) */
};
```

Except for the style or flavor of authentication credentials, the **rq_cred** routine is opaque.

```

/*
 * Authentication info. Mostly opaque to the programmer.
 */
struct opaque_auth {
    enum_t oa_flavor; /* style of credentials */
    caddr_t oa_base; /* address of more auth stuff */
    u_int oa_length; /* not to exceed MAX_AUTH_BYTES */
};

```

Before passing a request to the service dispatch routine, RPC guarantees:

- The request's `rq_cred` field is in an acceptable form. Therefore, the service implementor may inspect the request's `rq_cred.oa_flavor` to determine which style of authentication the caller used. The service implementor may also wish to inspect the other `rq_cred` fields if the authentication style is not one of the styles supported by the RPC package.
- The request's `rq_clntcred` field is either null or points to a well-formed structure that corresponds to a supported style of authentication credentials. The `rq_clntcred` field can currently be set as a pointer to an **authunix_parms** structure for UNIX-style authentication. If `rq_clntcred` is null, the service implementor can inspect the other opaque fields of the `rq_cred` credential for any new types of authentication that may be unknown to the RPC package.

The following example uses UNIX authentication on the server side. Here, the remote users service example is extended so that it computes results for all users except user ID (UID) 16:

```

nuser(rqstp, transp)
    struct svc_req *rqstp;
    SVCXPRT *transp;
{
    struct authunix_parms *unix_cred;
    int uid;
    unsigned long nusers;

    /*
     * we don't care about authentication for null proc
     */
    if (rqstp->rq_proc == NULLPROC) {
        if (!svc_sendreply(transp, xdr_void, 0)) {
            fprintf(stderr, "can't reply to RPC call\n");
            return (1);
        }
        return;
    }
    /*
     * now get the uid
     */
    switch (rqstp->rq_cred.oa_flavor) {
    case AUTH_UNIX:
        unix_cred =
            (struct authunix_parms *)rqstp->rq_clntcred;
        uid = unix_cred->aup_uid;
        break;
    case AUTH_NULL:
    default:
        svcerr_weakauth(transp);
        return;
    }

    switch (rqstp->rq_proc) {
    case RUSERSPROC_NUM:
        /*
         * make sure caller is allowed to call this proc
         */
        if (uid == 16) {
            svcerr_systemerr(transp);
            return;
        }
    }
    /*

```

```

    * Code here to compute the number of users
    * and assign it to the variable nusers
    */
    if (!svc_sendreply(transp, xdr_u_long, &nusers)) {
        fprintf(stderr, "can't reply to RPC call\n");
        return (1);
    }
    return;
default:
    svcerr_noproc(transp);
    return;
}
}
}

```

DES Authentication Example

This example illustrates how Data Encryption Standard (DES) authentication works on both the client side and the server side.

DES Authentication on the Client Side

To use DES authentication, the client first sets its authentication handle as follows:

```

cl->cl_auth =
    authdes_create(servername, 60, &server_addr, NULL);

```

The first argument (servername) to the **authdes_create** routine is the network name, or net name, of the owner of the server process. Typically, server processes are root processes. The net name can be derived using the following call:

```

char servername[MAXNETNAMELEN];
host2netname(servername, rhostname, NULL);

```

The rhostname parameter is the host name of the machine on which the server process is running. The host2netname routine supplies the servername that will contain this net name for the root process. If the server process is run by a regular user, the **user2netname** routine can be called instead.

The following example illustrates a server process with the same user ID as the client:

```

char servername[MAXNETNAMELEN];
user2netname(servername, getuid(), NULL);

```

The **user2netname** and **host2netname** routines identify the naming domain at the server location. The NULL parameter in this example means that the local domain name should be used.

The second argument (60) to the **authdes_create** routine identifies the lifetime of the credential, which is 60 seconds. This means the credential has 60 seconds until expiration. The server Remote Procedure Call (RPC) subsystem does not grant either a second request within the 60-second lifetime or requests made after the credential has expired.

The third argument (&server_addr) to the **authdes_create** routine is the address of the host with which to synchronize. DES authentication requires that the server and client agree on the time. The time is determined by the server when it receives the address. If the server and client times are already synchronized, the argument can be set to null.

The final argument (NULL) to the **authdes_create** routine is the address of a DES encryption key that is used to encrypt time stamps and data. Because this argument is null, a random key is chosen. The programmer can get the encryption key from the ah_key field of the authentication handle.

DES Authentication on the Server Side

The following example illustrates DES authentication on the server side. The server side is simpler than the client side. This example uses **AUTH_DES** instead of **AUTH_UNIX**:

```
#include <sys/time.h>
#include <rpc/auth_des.h>
...
...
nuser(rqstp, transp)
    struct svc_req *rqstp;
    SVCXPRT *transp;
{
    struct authdes_cred *des_cred;
    int uid;
    int gid;
    int gidlen;
    int gidlist[10];
    /*
     * we don't care about authentication for null proc
     */
    if (rqstp->rq_proc == NULLPROC) {
        /* same as before */
    }
    /*
     * now get the uid
     */
    switch (rqstp->rq_cred.oa_flavor) {
    case AUTH_DES:
        des_cred =
            (struct authdes_cred *) rqstp->rq_clntcred;
        if (! netname2user(des_cred->adc_fullname.name,
            &uid, &gid, &gidlen, gidlist))
        {
            fprintf(stderr, "unknown user: %s\n",
                des_cred->adc_fullname.name);
            svcerr_systemerr(transp);
            return;
        }
        break;
    case AUTH_NULL:
    default:
        svcerr_weakauth(transp);
        return;
    }
    /*
     * The rest is the same as UNIX-style authentication
     */
    switch (rqstp->rq_proc) {
    case RUSERSPROC_NUM:
        /*
         * make sure caller is allowed to call this proc
         */
        if (uid == 16) {
            svcerr_systemerr(transp);
            return;
        }
        /*
         * Code here to compute the number of users
         * and assign it to the variable nusers
         */
        if (!svc_sendreply(transp, xdr_u_long, &nusers)) {
            fprintf(stderr, "can't reply to RPC call\n");
            return (1);
        }
    }
    return;
}
```

```

    default:
        svcerr_noproc(transp);
        return;
    }
}

```

Note: The **netname2user** routine, which is the inverse of the **user2netname** routine, converts a network ID to a user ID. The **netname2user** routine also supplies group IDs, which are not used in this example but may be useful in other programs.

Using the Highest Layer of RPC Example

The following example shows how a program calls the Remote Procedure Call (RPC) library **rnusers** routine to determine how many users are logged in to a remote workstation:

```

#include <stdio.h>
main(argc, argv)
    int argc;
    char **argv;
{
    int num;
    if (argc != 2) {
        fprintf(stderr, "usage: rnusers hostname\n");
        exit(1);
    }
    if ((num = rnusers(argv[1])) < 0) {
        fprintf(stderr, "error: rnusers\n");
        exit(-1);
    }
    printf("%d users on %s\n", num, argv[1]);
    exit(0);
}
/* to compile: cc -o rnusers rnusers.c -lrpcsvc */

```

Using the Intermediate Layer of RPC Example

The following example shows a simple interface that makes explicit remote procedure calls using the **callrpc** routine at the intermediate layer of Remote Procedure Call (RPC). The interface can be used on both the client and server sides.

Intermediate Layer of RPC on the Server Side

Normally, the server registers each procedure, and then goes into an infinite loop waiting to service requests. Because there is only a single procedure to register, the main body of the server message would look like the following:

```

#include <stdio.h>
#include <rpc/rpc.h>
#include <utmp.h>
#include <rpcsvc/rusers.h>
char *nuser();
main()
{
    registerrpc(RUSERSPROG, RUSERSVERS, RUSERSPROC_NUM,
        nuser, xdr_void, xdr_u_long);
    svc_run(); /* Never returns */
    fprintf(stderr, "Error: svc_run returned!\n");
    exit(1);
}

```

The **registerrpc** routine registers a C procedure as corresponding to a given RPC procedure number. The first three parameters, **RUSERSPROG**, **RUSERSVERS**, and **RUSERSPROC_NUM**, specify the program, version, and procedure numbers of the remote procedure to be registered. The **nuser** parameter is the name of the

local procedure that implements the remote procedure, and the `xdr_void` and `xdr_u_long` parameters are the eXternal Data Representation (XDR) filters for the remote procedure's arguments and results, respectively.

Intermediate Layer of RPC on the Client Side

```
#include <stdio.h>
#include <rpc/rpc.h>
#include <utmp.h>
#include <rpcsvc/rusers.h>

main(argc, argv)
    int argc;
    char **argv;
{
    unsigned long nusers;
    int stat;
    if (argc != 2) {
        fprintf(stderr, "usage: nusers hostname\n");
        exit(-1);
    }
    if (stat = callrpc(argv[1],
        RUSERSPROG, RUSERSVERS, RUSERSPROC_NUM,
        xdr_void, 0, xdr_u_long, &nusers) != 0) {
        clnt_perrno(stat);
        exit(1);
    }
    printf("%d users on %s\n", nusers, argv[1]);
    exit(0);
}
```

The **callrpc** subroutine has eight parameters. The first, `host`, specifies the name of the remote server machine. The next three parameters, `prognum`, `versnum`, and `procnum`, specify the program, version, and procedure numbers. The fifth and sixth parameters, `inproc` and `in`, are an XDR filter and an argument to be encoded and passed to the remote procedure. The final two parameters, `outproc` and `out`, are a filter for decoding the results returned by the remote procedure and a pointer to the place where the procedure's results are to be stored. Multiple arguments and results are handled by embedding them in structures. If the **callrpc** subroutine completes successfully, it returns zero. Otherwise, it returns a nonzero value.

Because data types may be represented differently on different machines, the **callrpc** subroutine needs both the type of the RPC argument and a pointer to the argument itself. The return value for the `RUSERSPROC_NUM` parameter is unsigned long, so the **callrpc** subroutine has `xdr_u_long` as its first return parameter. This parameter specifies that the result is of the unsigned long type. The second return parameter, `&nusers`, is a pointer to where the long result is placed. Because the `RUSERSPROC_NUM` parameter takes no argument, the argument parameter of the **callrpc** subroutine is `xdr_void`.

Using the Lowest Layer of RPC Example

The following is an example of the lowest layer of Remote Procedure Call (RPC) on the server and client side using the **nusers** program.

The Lowest Layer of RPC from the Server Side

The server for the **nusers** program in the following example does the same thing as a program using the **registerrpc** subroutine at the highest level of RPC. However, the following is written using the lowest layer of the RPC package:

```
#include <stdio.h>
#include <rpc/rpc.h>
#include <utmp.h>
#include <rpcsvc/rusers.h>
```

```

main()
{
    SVCXPRT *transp;
    int nuser();

    transp = svcudp_create(RPC_ANYSOCK);
    if (transp == NULL){
        fprintf(stderr, "can't create an RPC server\n");
        exit(1);
    }
    pmap_unset(RUSERSPROG, RUSERSVERS);
    if (!svc_register(transp, RUSERSPROG, RUSERSVERS,
        nuser, IPPROTO_UDP)) {
        fprintf(stderr, "can't register RUSER service\n");
        exit(1);
    }
    svc_run(); /* Never returns */
    fprintf(stderr, "should never reach this point\n");
}

switch (rqstp->rq_proc) {
case NULLPROC:
    if (!svc_sendreply(transp, xdr_void, 0))
        fprintf(stderr, "can't reply to RPC call\n");
    return;
case RUSERSPROC_NUM:
    /*
     * Code here to compute the number of users
     * and assign it to the nusers variable
     */
    if (!svc_sendreply(transp, xdr_u_long, &nusers))
        fprintf(stderr, "can't reply to RPC call\n");
    return;
default:
    svcerr_noproc(transp);
    return;
}
}

```

First, the server gets a transport handle, which is used for receiving and replying to RPC messages. The **registerrpc** routine calls the **svcudp_create** routine to get a User Datagram Protocol (UDP) handle. If a more reliable protocol is required, the **svctcp_create** routine can be called instead. If the argument to the **svcudp_create** routine is `RPC_ANYSOCK`, the RPC library creates a socket on which to receive and reply to remote procedure calls. Otherwise, the **svcudp_create** routine expects its argument to be a valid socket number. If a programmer specifies a socket, it can be bound or unbound. If it is bound to a port by the programmer, the port numbers of the **svcudp_create** routine and the **clnttcp_create** routine (the low-level client routine) must match.

If the programmer specifies the `RPC_ANYSOCK` argument, the RPC library routines open sockets. The **svcudp_create** and **clntudp_create** routines cause the RPC library routines to bind the appropriate socket, if not already bound.

A service may register its port number with the local port mapper service. This is done by specifying a nonzero protocol number in the **svc_register** routine. A programmer at the client machine can discover the server port number by consulting the port mapper at the server workstation. This is done automatically by specifying a zero port number in the **clntudp_create** or **clnttcp_create** routines.

After creating a service transport (SVCXPRT) handle, the next step is to call the **pmap_unset** routine. If the **nusers** server crashed earlier, this routine erases any trace of the crash before restarting. Specifically, the **pmap_unset** routine erases the entry for `RUSERSPROG` from the port mapper's tables.

Finally, the program number for nusers is associated with the **nuser** procedure. The final argument to the **svc_register** routine is normally the protocol being used, in this case `IPPROTO_UDP`. Registration is performed at the program level, rather than the procedure level.

The **nuser** user service routine must call and dispatch the appropriate eXternal Data Representation (XDR) routines based on the procedure number. The **nuser** routine has two requirements, unlike the **registerrpc** routine which performs them automatically. The first is that the **NULLPROC** procedure (currently 0) return with no results. This is a simple test for detecting whether a remote program is running. Second, the subroutine checks for invalid procedure numbers. If one is detected, the **svcerr_noprocedure** routine is called to handle the error.

The user service routine serializes the results and returns them to the RPC caller through the **svc_sendreply** routine. The first parameter of this routine is the `SVCXPRT` handle, the second is the XDR routine that indicates return data type, and the third is a pointer to the data to be returned.

As an example, a **RUSERSPROC_BOOL** procedure can be added, which has an `nusers` argument and returns a value of True or False, depending on whether there are `nusers` logged on. The following example shows this addition:

```
case RUSERSPROC_BOOL: {
    int bool;
    unsigned nuserquery;
    if (!svc_getargs(transp, xdr_u_int, &nuserquery) {
        svcerr_decode(transp);
        return;
    }
    /*
     * Code to set nusers = number of users
     */
    if (nuserquery == nusers)
        bool = TRUE;
    else
        bool = FALSE;
    if (!svc_sendreply(transp, xdr_bool, &bool)) {
        fprintf(stderr, "can't reply to RPC call\n");
        return (1);
    }
    return;
}
```

The **svc_getargs** routine takes the following arguments: an `SVCXPRT` handle, the XDR routine, and a pointer that indicates where to place the input.

The Lowest Layer of RPC from the Client Side

A programmer using the **callrpc** routine has control over neither the RPC delivery mechanism nor the socket used to transport the data. However, the lowest layer of RPC allows the user to adjust these parameters. The following code can be used to request the **nusers** service:

```
#include <stdio.h>
#include <rpc/rpc.h>
#include <utmp.h>
#include <rpcsvc/rusers.h>
#include <sys/socket.h>
#include <sys/time.h>
#include <netdb.h>

main(argc, argv)
    int argc;
    char **argv;
{
    struct hostent *hp;
    struct timeval pertry_timeout, total_timeout;
    struct sockaddr_in server_addr;
```

```

int sock = RPC_ANYSOCK;
register CLIENT *client;
enum clnt_stat clnt_stat;
unsigned long nusers;
if (argc != 2) {
    fprintf(stderr, "usage: users hostname\n");
    exit(-1);
}
if ((hp = gethostbyname(argv[1])) == NULL) {
    fprintf(stderr, "can't get addr for %s\n", argv[1]);
    exit(-1);
}
pertry_timeout.tv_sec = 3;
pertry_timeout.tv_usec = 0;
bcopy(hp->h_addr, (caddr_t)&server_addr.sin_addr,
      hp->h_length);
server_addr.sin_family = AF_INET;
server_addr.sin_port = 0;
if ((clnt = clntudp_create(&server_addr, RUSERSPROC,
                          RUSERSVERS, pertry_timeout, &sock)) == NULL) {
    clnt_pcreateerror("clntudp_create");
    exit(-1);
}
total_timeout.tv_sec = 20;
total_timeout.tv_usec = 0;

clnt_stat = clnt_call(client, RUSERSPROC_NUM, xdr_void,
                     0, xdr_u_long, &nusers, total_timeout);
if (clnt_stat != RPC_SUCCESS) {
    clnt_perror(client, "rpc");
    exit(-1);
}
clnt_destroy(client);
close(sock);
exit(0);
}

```

The low-level version of the **callrpc** routine is the **clnt_call** macro, which takes a CLIENT pointer rather than a host name. The parameters to the **clnt_call** macro are a CLIENT pointer, the procedure number, the XDR routine for serializing the argument, a pointer to the argument, the XDR routine for deserializing the return value, a pointer to where the return value is to be placed, and the total time in seconds to wait for a reply. Thus, the number of tries is the time out divided by the **clntudp_create** time out.

The CLIENT pointer is encoded with the transport mechanism. The **callrpc** routine uses UDP, thus it calls the **clntudp_create** routine to get a CLIENT pointer. To get Transmission Control Protocol (TCP), the programmer can call the **clnttcp_create** routine.

The parameters to the **clntudp_create** routine are the server address, the program number, the version number, a time-out value (between tries), and a pointer to a socket.

The **clnt_destroy** call always deallocates the space associated with the client handle. If the RPC library opened the socket associated with the client handle, the **clnt_destroy** macro closes it. If the socket was opened by the programmer, it stays open. In cases where there are multiple client handles using the same socket, it is possible to destroy one handle without closing the socket that other handles are using.

The stream connection is made when the call to the **clntudp_create** macro is replaced by a call to the **clnttcp_create** routine.

```

clnttcp_create(&server_addr, prognum, versnum, &sock,
              inputsize, outputsize);

```

In this example, no time-out argument exists. Instead, the send and receive buffer sizes must be specified. When the **clnttcp_create** call is made, a TCP connection is established. All remote procedure calls using the client handle use the TCP connection. The server side of a remote procedure call using TCP is similar, except that the **svctcp_create** routine is replaced by the **svctcp_create** routine, as follows:

```
transp = svctcp_create(RPC_ANYSOCK, 0, 0);
```

The last two arguments to the **svctcp_create** routine are send and receive sizes, respectively. If 0 is specified for either of these, the system chooses a reasonable default.

Showing How RPC Passes Arbitrary Data Types Example

The first two examples show how Remote Procedure Call (RPC) handles arbitrary data types.

Passing a Simple User-Defined Structure Example

```
struct simple {
    int a;
    short b;
} simple;
callrpc(hostname, PROGNUM, VERSNUM, PROCNUM,
        xdr_simple, &simple ...);
```

The **xdr_simple** function is written as:

```
#include <rpc/rpc.h>
xdr_simple(xdrsp, simplep)
    XDR *xdrsp;
    struct simple *simplep;
{
    if (!xdr_int(xdrsp, &simplep->a))
        return (0);
    if (!xdr_short(xdrsp, &simplep->b))
        return (0);
    return (1);
}
```

Passing a Variable-Length Array Example

```
struct varintarr {
    int *data;
    int arrlenth;
} arr;
callrpc(hostname, PROGNUM, VERSNUM, PROCNUM,
        xdr_varintarr, &arr...);
```

The **xdr_varintarr** subroutine is defined as:

```
xdr_varintarr(xdrsp, arrp)
    XDR *xdrsp;
    struct varintarr *arrp;
{
    return (xdr_array(xdrsp, &arrp->data, &arrp->arrlenth,
        MAXLEN, sizeof(int), xdr_int));
}
```

This routine's parameters are the eXternal Data Representation (XDR) handle (*xdrsp*), a pointer to the array (*arrp->data*), a pointer to the size of the array (*arrp->arrlenth*), the maximum allowable array size (*MAXLEN*), the size of each array element (*sizeof*), and an XDR routine for handling each array element (*xdr_int*).

Passing a Fixed-Length Array Example

If the size of the array is known in advance, the programmer can call the `xdr_vector` subroutine to serialize fixed-length arrays, as in the following example:

```
int intarr[SIZE];
xdr_intarr(xdrsp, intarr)
    XDR *xdrsp;
    int intarr[];
{
    int i;
    return (xdr_vector(xdrsp, intarr, SIZE, sizeof(int),
        xdr_int));
}
```

Passing Structure with Pointers Example

The following example calls the previously written `xdr_simple` routine as well as the built-in `xdr_string` and `xdr_reference` functions. The `xdr_reference` routine chases pointers.

```
struct finalexample {
    char *string;
    struct simple *simplep;
} finalexample;
xdr_finalexample(xdrsp, finalp)
    XDR *xdrsp;
    struct finalexample *finalp;
{
    if (!xdr_string(xdrsp, &finalp->string, MAXSTRLEN))
        return (0);
    if (!xdr_reference(xdrsp, &finalp->simplep,
        sizeof(struct simple), xdr_simple);
        return (0);
    return (1);
}
```

Using Multiple Program Versions Example

By convention, the first version number of the **PROG** program is referred to as **PROGVERS_ORIG**, and the most recent version is **PROGVERS**. For example, the programmer can create a new version of the **user** program that returns an unsigned short value rather than a long value. If the programmer names this version **RUSERSVERS_SHORT**, then the following program permits the server to support both programs:

```
if (!svc_register(transp, RUSERSPROG, RUSERSVERS_ORIG,
    nuser, IPPROTO_TCP)) {
    fprintf(stderr, "can't register RUSER service\n");
    exit(1);
}
if (!svc_register(transp, RUSERSPROG, RUSERSVERS_SHORT,
    nuser, IPPROTO_TCP)) {
    fprintf(stderr, "can't register RUSER service\n");
    exit(1);
}
```

Both versions can be handled by the same C procedure, as in the following example using the **nusers** procedure:

```
nuser(rqstp, transp)
    struct svc_req *rqstp;
    SVCXPRT *transp;
{
    unsigned long nusers;
    unsigned short nusers2;
```

```

switch (rqstp->rq_proc) {
case NULLPROC:
    if (!svc_sendreply(transp, xdr_void, 0)) {
        fprintf(stderr, "can't reply to RPC call\n");
        return (1);
    }
    return;
case RUSERSPROC_NUM:
    /*
     * Code here to compute the number of users
     * and assign it to the variable nusers
     */
    nusers2 = nusers;
    switch (rqstp->rq_vers) {
case RUSERSVERS_ORIG:
        if (!svc_sendreply(transp, xdr_u_long,
            &nusers)) {
            fprintf(stderr, "can't reply to RPC call\n");
        }
        break;
case RUSERSVERS_SHORT:
        if (!svc_sendreply(transp, xdr_u_short,
            &nusers2)) {
            fprintf(stderr, "can't reply to RPC call\n");
        }
        break;
    }
default:
    svcerr_noproc(transp);
    return;
}
}

```

Broadcasting a Remote Procedure Call Example

The following example illustrates broadcast Remote Procedure Call (RPC):

```

#include <rpc/pmap_clnt.h>
...
enum clnt_stat    clnt_stat;
...
clnt_stat = clnt_broadcast(prognum, versnum, procnum,
    inproc, in, outproc, out, eachresult)
    u_long    prognum;        /* program number          */
    u_long    versnum;       /* version number       */
    u_long    procnum;       /* procedure number     */
    xdrproc_t inproc        /* xdr routine for args */
    caddr_t   in;           /* pointer to args      */
    xdrproc_t outproc       /* xdr routine for results */
    caddr_t   out;         /* pointer to results   */
    bool_t   (*eachresult)(); /* call with each result gotten */

```

The **eachresult** procedure is called each time a result is obtained. This procedure returns a Boolean value that indicates whether the caller wants more responses.

```

bool_t done;
...
done = eachresult(resultsp, raddr)
    caddr_t resultsp;
    struct sockaddr_in *raddr; /* Addr of responding machine */

```

If the **done** parameter returns a value of True, then broadcasting stops and the **clnt_broadcast** routine returns successfully. Otherwise, the routine waits for another response. The request is rebroadcast after a few seconds of waiting. If no response comes back, the routine returns with a value of **RPC_TIMEDOUT**.

Using the select Subroutine Example

The code for the `svc_run` routine with the `select` subroutine is as follows:

```
void
svc_run()
{
    fd_set readfds;
    int dtbsz = getdtablesize();
    for (;;) {
        readfds = svc_fds;
        switch (select(dtbsz, &readfds, NULL, NULL, NULL)) {
            case -1:
                if (errno == EINTR)
                    continue;
                perror("select");
                return;
            case 0:
                break;
            default:
                svc_getreqset(&readfds);
        }
    }
}
```

Beginning in AIX 5.2, the maximum number of open file descriptors that an RPC server can use has been set to 32767 in order to maintain compatibility with RPC-server applications built on earlier releases of AIX. The `fd_set` type passed into the `svc_getreqset` subroutine needs to have been compiled with `FD_SETSIZE` set to 32767 or larger. Passing in a smaller `fd_set` variable may result in the passed in buffer being overrun by the `svc_getreqset` subroutine.

rcp Process on TCP Example

The following is an example using the `rcp` process. This example includes an eXternal Data Representation (XDR) procedure that behaves differently on serialization than on deserialization. The initiator of the Remote Procedure Call (RPC) `snd` call takes its standard input and sends it to the `rcv` process on the server, which prints the data to standard output. The `snd` call uses Transmission Control Protocol (TCP).

The routine follows:

```
/*
 * The xdr routine:
 *   on decode, read from wire, write onto fp
 *   on encode, read from fp, write onto wire
 */
#include <stdio.h>
#include <rpc/rpc.h>

xdr_rcp(xdrs, fp)
    XDR *xdrs;
    FILE *fp;
{
    unsigned long size;
    char buf[BUFSIZ], *p;
    if (xdrs->x_op == XDR_FREE) /* nothing to free */
        return 1;
    while (1) {
        if (xdrs->x_op == XDR_ENCODE) {
            if ((size = fread(buf, sizeof(char), BUFSIZ,
                fp)) == 0 && ferror(fp)) {
                fprintf(stderr, "can't fread\n");
                return (1);
            }
        }
    }
}
```

```

    }
    p = buf;
    if (!xdr_bytes(xdrs, &p, &size, BUFSIZ))
        return 0;
    if (size == 0)
        return 1;
    if (xdrs->x_op == XDR_DECODE) {
        if (fwrite(buf, sizeof(char), size, fp) != size) {
            fprintf(stderr, "can't fwrite\n");
            return (1);
        }
    }
}
}
}
/*
 * The sender routines
 */
#include <stdio.h>
#include <netdb.h>
#include <rpc/rpc.h>
#include <sys/socket.h>
#include <sys/time.h>
main(argc, argv)
    int argc;
    char **argv;
{
    int xdr_rcp();
    int err;
    if (argc < 2) {
        fprintf(stderr, "usage: %s servername\n", argv[0]);
        exit(-1);
    }
    if ((err = callrpcTCP(argv[1], RCPPROG, RCPPROC,
        RCPVERS, xdr_rcp, stdin, xdr_void, 0) != 0)) {
        clnt_perrno(err);
        fprintf(stderr, "can't make RPC call\n");
        exit(1);
    }
    exit(0);
}
callrpcTCP(host, prognum, procnum, versnum, inproc, in,
    outproc, out)
    char *host, *in, *out;
    xdrproc_t inproc, outproc;
{
    struct sockaddr_in server_addr;
    int socket = RPC_ANYSOCK;
    enum clnt_stat clnt_stat;
    struct hostent *hp;
    register CLIENT *client;
    struct timeval total_timeout;
    if ((hp = gethostbyname(host)) == NULL) {
        fprintf(stderr, "can't get addr for '%s'\n", host);
        return (-1);
    }
    bcopy(hp->h_addr, (caddr_t)&server_addr.sin_addr,
        hp->h_length);
    server_addr.sin_family = AF_INET;
    server_addr.sin_port = 0;
    if ((client = clnttcp_create(&server_addr, prognum,
        versnum, &socket, BUFSIZ, BUFSIZ)) == NULL) {
        perror("rpcTCP_create");
        return (-1);
    }
    total_timeout.tv_sec = 20;

```

```

    total_timeout.tv_usec = 0;
    clnt_stat = clnt_call(client, procnum,
        inproc, in, outproc, out, total_timeout);
    clnt_destroy(client);
    return (int)clnt_stat;
}
/*
 * The receiving routines
 */
#include <stdio.h>
#include <rpc/rpc.h>
main()
{
    register SVCXPRT *transp;
    int rcp_service(), xdr_rcp();
    if ((transp = svctcp_create(RPC_ANYSOCK,
        BUFSIZ, BUFSIZ)) == NULL) {
        fprintf("svctcp_create: error\n");
        exit(1);
    }
    pmap_unset(RCPPROG, RCPVERS);
    if (!svc_register(transp,
        RCPPROG, RCPVERS, rcp_service, IPPROTO_TCP)) {
        fprintf(stderr, "svc_register: error\n");
        exit(1);
    }
    svc_run(); /* never returns */
    fprintf(stderr, "svc_run should never return\n");
}
rcp_service(rqstp, transp)
    register struct svc_req *rqstp;
    register SVCXPRT *transp;
{
    switch (rqstp->rq_proc) {
    case NULLPROC:
        if (svc_sendreply(transp, xdr_void, 0) == 0) {
            fprintf(stderr, "err: rcp_service");
            return (1);
        }
        return;
    case RCPPROC_FP:
        if (!svc_getargs(transp, xdr_rcp, stdout)) {
            svcerr_decode(transp);
            return;
        }
        if (!svc_sendreply(transp, xdr_void, 0)) {
            fprintf(stderr, "can't reply\n");
            return;
        }
        return (0);
    default:
        svcerr_noproc(transp);
        return;
    }
}

```

RPC Callback Procedures Example

Occasionally, it is useful to have a server become a client and make a Remote Procedure Call (RPC) back to the process client. For example, with remote debugging, the client is a window system program and the server is a debugger running on the remote machine. Usually, the user clicks a mouse button at the debugging window. This step invokes a debugger command that makes a remote procedure call to the server (where the debugger is actually running), telling it to execute that command. When the debugger

hits a breakpoint, however, the roles are reversed. The debugger then makes a remote procedure call to the window program to inform the user that a breakpoint has been reached.

An RPC callback requires a program number to make the remote procedure call on. Because this will be a dynamically generated program number, it should be in the transient range, 0x40000000 to 0x5fffffff. The **gettransient** routine returns a valid program number in the transient range, and registers it with the port mapper. This routine only talks to the port mapper running on the same machine as the **gettransient** routine itself. The call to the **pmap_set** routine is a test-and-set operation. That is, it indivisibly tests whether a program number has already been registered, and reserves the number if it has not. On return, the `sockp` argument contains a socket that can be used as the argument to an **svcudp_create** or **svctcp_create** routine.

```
#include <stdio.h>
#include <rpc/rpc.h>
#include <sys/socket.h>
gettransient(proto, vers, sockp)
    int proto, vers, *sockp;
{
    static int prognum = 0x40000000;
    int s, len, socktype;
    struct sockaddr_in addr;
    switch(proto) {
        case IPPROTO_UDP:
            socktype = SOCK_DGRAM;
            break;
        case IPPROTO_TCP:
            socktype = SOCK_STREAM;
            break;
        default:
            fprintf(stderr, "unknown protocol type\n");
            return 0;
    }
    if (*sockp == RPC_ANYSOCK) {
        if ((s = socket(AF_INET, socktype, 0)) < 0) {
            perror("socket");
            return (0);
        }
        *sockp = s;
    }
    else
        s = *sockp;
    addr.sin_addr.s_addr = 0;
    addr.sin_family = AF_INET;
    addr.sin_port = 0;
    len = sizeof(addr);
    /*
     * may be already bound, so don't check for error
     */
    bind(s, &addr, len);
    if (getsockname(s, &addr, &len) < 0) {
        perror("getsockname");
        return (0);
    }
    while (!pmap_set(prognum++, vers, proto,
        ntohs(addr.sin_port))) continue;
    return (prognum-1);
}
```

Note: The call to the **ntohs** subroutine ensures that the port number in `addr.sin_port`, which is in network byte order, is passed in host byte order. The **pmap_set** subroutine expects host byte order.

The following programs illustrate how to use the **gettransient** routine. The client makes a remote procedure call to the server, passing it a transient program number. Then the client waits around to receive a callback from the server at that program number. The server registers the **EXAMPLEPROG** program so

that it can receive the remote procedure call informing it of the callback program number. Then, at some randomly selected time (on receiving a **SIGALRM** signal in this example), the server sends a callback remote procedure call, using the program number it received earlier.

```

/*
 * client
 */
#include <stdio.h>
#include <rpc/rpc.h>

int callback();
char hostname[256];

main()
{
    int x, ans, s;
    SVCXPRT *xpirt;
    gethostname(hostname, sizeof(hostname));
    s = RPC_ANYSOCK;
    x = gettransient(IPPROTO_UDP, 1, &s);
    fprintf(stderr, "client gets prognum %d\n", x);
    if ((xpirt = svcudp_create(s)) == NULL) {
        fprintf(stderr, "rpc_server: svcudp_create\n");
        exit(1);
    }
    /* protocol is 0 - gettransient does registering
    */
    (void)svc_register(xpirt, x, 1, callback, 0);
    ans = callrpc(hostname, EXAMPLEPROG, EXAMPLEVERS,
        EXAMPLEPROC_CALLBACK, xdr_int, &x, xdr_void, 0);
    if ((enum clnt_stat) ans != RPC_SUCCESS) {
        fprintf(stderr, "call: ");
        clnt_perrno(ans);
        fprintf(stderr, "\n");
    }
    svc_run();
    fprintf(stderr, "Error: svc_run shouldn't return\n");
}

callback(rqstp, transp)
    register struct svc_req *rqstp;
    register SVCXPRT *transp;

{
    switch (rqstp->rq_proc) {
        case 0:
            if (!svc_sendreply(transp, xdr_void, 0)) {
                fprintf(stderr, "err: exampleprog\n");
                return (1);
            }
            return (0);
        case 1:
            if (!svc_getargs(transp, xdr_void, 0)) {
                svcerr_decode(transp);
                return (1);
            }
            fprintf(stderr, "client got callback\n");
            if (!svc_sendreply(transp, xdr_void, 0)) {
                fprintf(stderr, "err: exampleprog");
                return (1);
            }
    }
}

/*
 * server

```



```

    */
#include <stdio.h>
#include <rpc/rpc.h>
#include <sys/signal.h>

char *getnewprog();
char hostname[256];
int docallback();
int pnum;          /* program number for callback routine */

main()
{
    gethostname(hostname, sizeof(hostname));
    registerrpc(EXAMPLEPROG, EXAMPLEVERS,
        EXAMPLEPROC_CALLBACK, getnewprog, xdr_int, xdr_void);
    fprintf(stderr, "server going into svc_run\n");
    signal(SIGALRM, docallback);
    alarm(10);
    svc_run();
    fprintf(stderr, "Error: svc_run shouldn't return\n");
}

char *
getnewprog(pnum)
    char *pnum;
{
    pnum = *(int *)pnum;
    return NULL;
}

docallback()
{
    int ans;
    ans = callrpc(hostname, pnum, 1, 1, xdr_void, 0,
        xdr_void, 0);
    if (ans != 0) {
        fprintf(stderr, "server: ");
        clnt_perrno(ans);
        fprintf(stderr, "\n");
    }
}

```

RPC Language ping Program Example

The following is an example of the specification of a simple **ping** program described in the Remote Procedure Call language (RPCL):

```

/*
 * Simple ping program
 */
program PING_PROG {
    /* Latest and greatest version */
    version PING_VERS_PINGBACK {
        void
        PINGPROC_NULL(void) = 0;

        /*
         * Ping the caller, return the round-trip time
         * (in microseconds). Returns -1 if the operation
         * timed out.
         */
        int
        PINGPROC_PINGBACK(void) = 1;
    } = 2;

    /*
     * Original version
     */
    version PING_VERS_ORIG {

```

```

        void
        PINGPROC_NULL(void) = 0;
    } = 1;
} = 1;
const PING_VERS = 2;    /* latest version */

```

In this example, the first part of the **ping** program, PING_VERS_PINGBACK, consists of two procedures: PINGPROC_NULL and PINGPROC_PINGBACK. The PINGPROC_NULL procedure takes no arguments and returns no results. However, it is useful for computing round-trip times from the client to the server. By convention, procedure 0 of an RPC protocol should have the same semantics and require no kind of authentication. The second procedure, PINGPROC_PINGBACK, requests a reverse **ping** operation from the server. It returns the amount of time in microseconds that the operation used.

The second part, or original version of the ping program, PING_VERS_ORIG, does not contain the PINGPROC_PINGBACK procedure. The original version is useful for compatibility with older client programs. When the new **ping** program matures, this older version may be dropped from the protocol entirely.

Converting Local Procedures into Remote Procedures Example

This example illustrates one way to convert an application that runs on a single machine into one that runs over a network. For example, a programmer first creates a program that prints a message to the console, as follows:

```

/*
 * printmsg.c: print a message on the console
 */
#include <stdio.h>
main(argc, argv)
    int argc;
    char *argv[];
{
    char *message;
    if (argc < 2) {
        fprintf(stderr, "usage: %s <message>\n",
            argv[0]);
        exit(1);
    }
    message = argv[1];
    if (!printmessage(message)) {
        fprintf(stderr, "%s: couldn't print your
            message\n", argv[0]);
        exit(1);
    }
    printf("Message Delivered!\n");
    exit(0);
}
/*
 * Print a message to the console.
 * Return a boolean indicating whether the
 * message was actually printed.
 */
printmessage(msg)
    char *msg;
{
    FILE *f;
    f = fopen("/dev/console", "w");
    if (f == NULL) {
        return (0);
    }
    fprintf(f, "%s\n", msg);
    fclose(f);
    return(1);
}

```

The reply message follows:

```
example% cc printmsg.c -o printmsg
example% printmsg "Hello, there."
Message delivered!
example%
```

If the **printmessage** program is turned into a remote procedure, it can be called from anywhere in the network. Ideally, one would insert a keyword such as **remote** in front of a procedure to turn it into a remote procedure. Unfortunately the constraints of the C language do not permit this. However, a procedure can be made remote without language support.

To do this, the programmer must know the data types of all procedure inputs and outputs. In this case, the **printmessage** procedure takes a string as input and returns an integer as output. Knowing this, the programmer can write a protocol specification in Remote Procedure Call language (RPCL) that describes the remote version of PRINTMESSAGE, as follows:

```
/*
 * msg.x: Remote message printing protocol
 */
program MESSAGEPROG {
    version MESSAGEVERS {
        int PRINTMESSAGE(string) = 1;
    } = 1;
} = 99;
```

Remote procedures are part of remote programs, so the previous protocol declares a remote program containing the single procedure PRINTMESSAGE. This procedure was declared to be in version 1 of the remote program. No null procedure (procedure 0) is necessary, because the **rpcgen** command generates it automatically.

Conventionally, all declarations are written with uppercase letters.

The argument type is string and not char * because a char * in C is ambiguous. Programmers usually intend it to mean a null-terminated string of characters, but it could also represent a pointer to a single character or a pointer to an array of characters. In RPCL, a null-terminated string is unambiguously called a string.

Next, the programmer writes the remote procedure itself. The definition of a remote procedure to implement the PRINTMESSAGE procedure declared previously can be written as follows:

```
/*
 * msg_proc.c: implementation of the remote
 * procedure "printmessage"
 */
#include <stdio.h>
#include <rpc/rpc.h> /* always needed */
#include "msg.h" /* msg.h will be generated by rpcgen */

/*
 * Remote version of "printmessage"
 */ int *
printmessage_1(msg)
    char **msg;
{
    static int result; /* must be static! */
    FILE *f;
    f = fopen("/dev/console", "w");
    if (f == NULL) {
        result = 0;
        return (&result);
    }
    fprintf(f, "%s\n", *msg);
}
```

```

    fclose(f);
    result = 1;
    return (&result);
}

```

The declaration of the remote procedure `printmessage_1` in this step differs from that of the local procedure `printmessage` in the first step, in three ways:

- It takes a pointer to a string instead of the string itself. This is true of all remote procedures, which always take pointers to their arguments rather than the arguments themselves.
- It returns a pointer to an integer instead of the integer itself. This is also true of remote procedures, which generally return a pointer to their results.
- It has a `_1` appended to its name. Remote procedures called by the **rpcgen** command are named by the following rule: the name in the program definition (here `PRINTMESSAGE`) is converted to all lowercase letters, and an `_` (underscore) and the version number are appended.

Finally, the programmers declare the main client program that will call the remote procedure, as follows:

```

/*
 * rprintmsg.c: remote version of "printmsg.c"
 */
#include <stdio.h>
#include <rpc/rpc.h>    /* always needed */
#include "msg.h" /* msg.h will be generated by rpcgen */
main(argc, argv)
    int argc;
    char *argv[];
{
    CLIENT *cl;
    int *result;
    char *server;
    char *message;
    if (argc < 3) {
        fprintf(stderr,
            "usage: %s host message\n", argv[0]);
        exit(1);
    }
    /*
     * Save values of command line arguments
     */
    server = argv[1];
    message = argv[2];
    /*
     * Create client "handle" used for calling MESSAGEPROG on
     * the server designated on the command line. We tell
     * the RPC package to use the "tcp" protocol when
     * contacting the server.
     */
    cl = clnt_create(server, MESSAGEPROG, MESSAGEVERS, "tcp");
    if (cl == NULL) {
        /*
         * Couldn't establish connection with server.
         * Print error message and die.
         */
        clnt_pcreateerror(server);
        exit(1);
    }
    /*
     * Call the remote procedure "printmessage" on the server
     */
    result = printmessage_1(&message, cl);
    if (result == NULL) {
        /*
         * An error occurred while calling the server.
         * Print error message and die.
         */
    }
}

```

```

        */
        clnt_perror(cl, server);
        exit(1);
    }
    /*
    * Okay, we successfully called the remote procedure.
    */
    if (*result == 0) {
        /*
        * Server was unable to print our message.
        * Print error message and die.
        */
        fprintf(stderr, "%s: %s couldn't print your message\n",
            argv[0], server);
        exit(1);
    }
    /*
    * The message got printed on the server's console
    */
    printf("Message delivered to %s!\n", server);
    exit(0);
}

```

Notes:

1. First a client handle is created using the Remote Procedure Call (RPC) library **clnt_create** routine. This client handle is passed to the stub routines that call the remote procedure.
2. The remote procedure `printmessage_1` is called exactly the same way as it is declared in the **msg_proc.c** program, except for the inserted client handle as the first argument.

The client program **rprintmsg** and the server program **msg_server** are compiled as follows:

```

example% rpcgen msg.x
example% cc rprintmsg.c msg_clnt.c -o rprintmsg
example% cc msg_proc.c msg_svc.c -o msg_server

```

Before compilation, however, the **rpcgen** protocol compiler is used to perform the following operations on the **msg.x** input file:

- It creates a header file called **msg.h** that contains **#define** statements for **MESSAGEPROG**, **MESSAGEVERS**, and **PRINTMESSAGE** for use in the other modules.
- It creates a client stub routine in the **msg_clnt.c** file. In this case, there is only one stub routine, the `printmessage_1`, which is referred to from the **rprintmsg** client program. The name of the output file for client stub routines is always formed in this way. For example, if the name of the input file is **FOO.x**, the client stub's output file would be called **FOO_clnt.c**.
- It creates the server program that calls `printmessage_1` in the **msg_proc.c** file. This server program is named **msg_svc.c**. The rule for naming the server output file is similar to the previous one. For example, if an input file is called **FOO.x**, the output server file is named **FOO_svc.c**.

Generating XDR Routines Example

The “Converting Local Procedures into Remote Procedures Example” on page 184 demonstrates the automatic generation of client and server Remote Procedure Call (RPC) code. The **rpcgen** protocol compiler may also be used to generate eXternal Data Representation (XDR) routines that convert local data structures into network format, and vice versa. The following protocol description file presents a complete RPC service that is a remote directory listing service that uses the **rpcgen** protocol compiler to generate not only stub routines, but also XDR routines.

```

/*
 * dir.x: Remote directory listing protocol
 */
const MAXNAMELEN = 255; /* maximum length of a directory entry */
typedef string nametype<MAXNAMELEN>; /* a directory entry */
typedef struct namenode *namelist; /* a link in the listing */

```

```

/*
 * A node in the directory listing
 */
struct nametype {
    nametype name;    /* name of directory entry */
    namelist next;   /* next entry */
};
/*
 * The result of a READDIR operation.
 */
union readdir_res switch (int errno) {
    case 0:
        namelist list; /* no error: return directory listing */
    default:
        void;          /* error occurred: nothing else to return */
};
/*
 * The directory program definition
 */
program DIRPROG {
    version DIRVERS {
        readdir_res
        READDIR(nametype) = 1;
    } = 1;
} = 76;

```

Note: Types (like `readdir_res` in the previous example) can be defined using the **struct**, **union** and **enum** keywords, but do not use these keywords in subsequent declarations of variables of those types. For example, if you define a union, `foo`, declare it using only `foo` and not `union foo`. In fact, the **rpcgen** protocol compiler compiles RPC unions into C structures, in which case it is an error to declare these unions using the **union** keyword.

Running the **rpcgen** protocol compiler on the **dir.x** file creates four output files. Three are the same as before: header file, client stub routines, and server skeleton. The fourth file contains the XDR routines necessary for converting the specified data types into XDR format, and vice versa. These are output in the **dir_xdr.c** file.

Following is the implementation of the READDIR procedure:

```

/*
 * dir_proc.c: remote readdir implementation
 */
#include <rpc/rpc.h>
#include <sys/dir.h>
#include "dir.h"
extern int errno;
extern char *malloc();
extern char *strdup();
readdir_res *
readdir_1(dirname)
    nametype *dirname;
{
    DIR *dirp;
    struct direct *d;
    namelist nl;
    namelist *nlp;
    static readdir_res res; /* must be static */
    /*
     * Open directory
     */
    dirp = opendir(*dirname);
    if (dirp == NULL) {
        res.errno = errno;
        return (&res);
    }
}

```

```

}
/*
 * Free previous result
 */
xdr_free(xdr_readdir_res, &res);
/*
 * Collect directory entries.
 * Memory allocated here will be freed by xdr_free
 * next time readdir_1 is called
 */
nlp = &res.readdir_res_u.list;
while (d = readdir(dirp)) {
    nl = *nlp = (namenode *) malloc(sizeof(namenode));
    nl->name = strdup(d->d_name);
    nlp = &nl->next;
}
*nlp = NULL;

/*
 * Return the result
 */
res.errno = 0;
closedir(dirp);
return (&res);
}

```

The client side program calls the server as follows:

```

/*
 * rls.c: Remote directory listing client
 */
#include <stdio.h>
#include <rpc/rpc.h> /* always need this */
#include "dir.h" /* will be generated by rpcgen */
extern int errno;
main(argc, argv)
    int argc;
    char *argv[];
{
    CLIENT *cl;
    char *server;
    char *dir;
    readdir_res *result;
    namelist nl;
    if (argc != 3) {
        fprintf(stderr, "usage: %s host directory\n",
            argv[0]);
        exit(1);
    }
    /*
     * Remember what our command line arguments refer to
     */
    server = argv[1];
    dir = argv[2];

    /*
     * Create client "handle" used for calling MESSAGEPROG
     * on the server designated on the command line. We
     * tell the RPC package to use the "tcp" protocol
     * when contacting the server.
     */
    cl = clnt_create(server, DIRPROG, DIRVERS, "tcp");
    if (cl == NULL) {
        /*
         * Could not establish connection with server.

```

```

        * Print error message and die.
        */
        clnt_pcreateerror(server);
        exit(1);
    }
    /*
    * Call the remote procedure readdir on the server
    */
    result = readdir_1(&dir, cl);
    if (result == NULL) {
        /*
        * An error occurred while calling the server.
        * Print error message and die.
        */
        clnt_perror(cl, server);
        exit(1);
    }
    /*
    * Okay, we successfully called the remote procedure.
    */
    if (result->errno != 0) {
        /*
        * A remote system error occurred.
        * Print error message and die.
        */
        errno = result->errno;
        perror(dir);
        exit(1);
    }
    /*
    * Successfully got a directory listing.
    * Print it out.
    */
    for (nl = result->readdir_res_u.list; nl != NULL;
         nl = nl->next) {
        printf("%s\n", nl->name);
    }
    exit(0);
}

```

Finally, in regard to the **rpcgen** protocol compiler, the client program and the server procedure can be tested together as a single program by linking them with each other rather than with client and server stubs. The procedure calls are executed as ordinary local procedure calls and the program can be debugged with a local debugger such as **dbx**. When the program is working, the client program can be linked to the client stub produced by the **rpcgen** protocol compiler. The server procedures can be linked to the server stub produced by the **rpcgen** protocol compiler.

Note: If you do this, you might want to comment out calls to RPC library routines and have client-side routines call server routines directly.

Chapter 9. Sockets

The operating system includes the Berkeley Software Distribution (BSD) interprocess communication (IPC) facility known as *sockets*. Sockets are communication channels that enable unrelated processes to exchange data locally and across networks. A single socket is one end point of a two-way communication channel.

This chapter discusses the following topics:

- “Sockets Overview”
- “Sockets Interface” on page 193
- “Socket Subroutines” on page 194
- “Socket Header Files” on page 195
- “Socket Communication Domains” on page 196
- “Socket Addresses” on page 198
- “Socket Types and Protocols” on page 201
- “Socket Creation” on page 205
- “Binding Names to Sockets” on page 205
- “Socket Connections” on page 207
- “Socket Options” on page 210
- “Socket Data Transfer” on page 210
- “Socket Shutdown” on page 212
- “IP Multicasts” on page 213
- “Network Address Translation” on page 214
- “Domain Name Resolution” on page 218
- “Socket Examples” on page 220
- “List of Socket Programming References” on page 248

Sockets Overview

In the operating system, sockets have the following characteristics:

- A socket exists only as long as a process holds a descriptor referring to it.
- Sockets are referenced by file descriptors and have qualities similar to those of a character special device. Read, write, and select operations can be performed on sockets by using the appropriate subroutines.
- Sockets can be created in pairs, given names, or used to rendezvous with other sockets in a communication domain, accepting connections from these sockets or exchanging messages with them.

Critical Attributes

Sockets share certain critical attributes that no other IPC mechanisms feature:

- Provide a two-way communication path.
- Include a socket type and one or more associated processes.
- Exist within communication domains.
- Do not require a common ancestor to set up the communication.

Application programs request the operating system to create a socket when one is needed. The operating system returns an integer that the application program uses to reference the newly created socket. Unlike

file descriptors, the operating system can create sockets without binding them to a specific destination address. The application program can choose to supply a destination address each time it uses the socket.

Sockets Background

Sockets were developed in response to the need for sophisticated interprocess facilities to meet the following goals:

- Provide access to communications networks such as the Internet.
- Enable communication between unrelated processes residing locally on a single host computer and residing remotely on multiple host machines.

Sockets provide a sufficiently general interface to allow network-based applications to be constructed independently of the underlying communication facilities. They also support the construction of distributed programs built on top of communication primitives.

Note: The socket subroutines serve as the application program interface for Transmission Control Protocol/Internet Protocol (TCP/IP).

Socket Facilities

Socket subroutines and network library subroutines provide the building blocks for IPC. An application program must perform the following basic functions to conduct IPC through the socket layer:

- Create and name sockets.
- Accept and make socket connections.
- Send and receive data.
- Shut down socket operations.
- Translate network addresses.

Creating and Naming Sockets

A socket is created with the **socket** subroutine. This subroutine creates a socket of a specified domain, type, and protocol. Sockets have different qualities depending on these specifications. A *communication domain* indicates the protocol families to be used with the created socket. The *socket type* defines its communication properties such as reliability, ordering, and prevention of duplication of messages. Some protocol families have multiple protocols that support one type of service. To supply a protocol in the creation of a socket, the programmer must understand the protocol family well enough to know the type of service each protocol supplies.

An application can bind a name to a socket. The socket names used by most applications are readable strings. However, the name for a socket that is used within a communication domain is usually a low-level address. The form and meaning of socket addresses are dependent on the communication domain in which the socket is created. The socket name is specified by a **sockaddr** structure (see “Socket Address Data Structures” on page 195).

Accepting and Making Socket Connections

Sockets can be connected or unconnected. Unconnected sockets are produced by the **socket** subroutine. An unconnected socket can yield a connected socket pair by:

- Actively connecting to another socket
- Becoming associated with a name in the communication domain and accepting a connection from another socket

Other types of sockets, such as datagram sockets, need not establish connections before use.

Transferring Data

Sockets include a variety of calls for sending and receiving data. The usual **read** and **write** subroutines can be used on sockets that are in a connected state. Additional socket subroutines permit callers to specify or receive the address of the peer socket. These calls are useful for connectionless sockets, in which the peer sockets can vary on each message transmitted or received. The **sendmsg** and **recvmsg** subroutines support the full interface to the IPC facilities. Besides offering scatter-gather operations, these calls allow an address to be specified or received and support flag options.

Shutting Down Socket Operations

Once sockets are no longer of use they can be closed or shut down using the **shutdown** or **close** subroutine.

Translating Network Addresses

Application programs need to locate and construct network addresses when conducting the interprocess communication. The socket facilities include subroutines to:

- Map addresses to host names and back
- Map network names to numbers and back
- Extract network, host, service, and protocol names
- Convert between varying length byte quantities
- Resolve domain names

Sockets Interface

The kernel structure consists of three layers: the socket layer, the protocol layer, and the device layer. The *socket layer* supplies the interface between the subroutines and lower layers, the *protocol layer* contains the protocol modules used for communication, and the *device layer* contains the device drivers that control the network devices. Protocols and drivers are dynamically loadable. The Socket Label figure (Figure 29) illustrates the relationship between the layers.

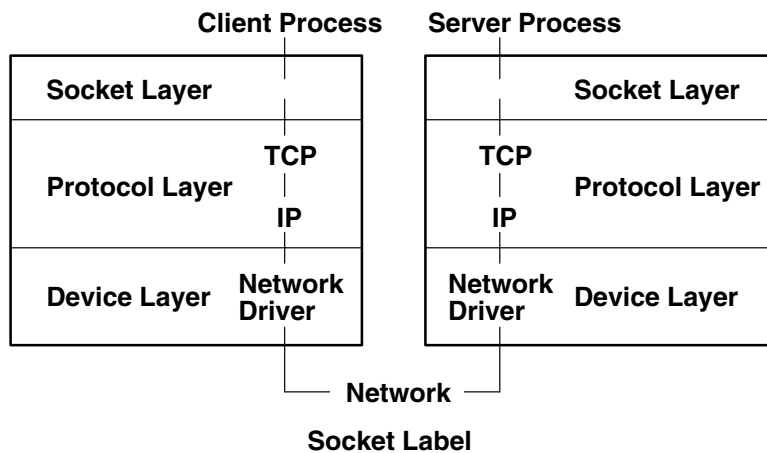

Figure 29. Socket Label. This diagram shows the client process on the left with the socket layer beneath it, and the protocol layer and device layer below. The protocol layer is between the other two layers. Corresponding layers are below the server process on the right. A U-shaped dashed line representing the network runs through all six layers and connects the server and client processes. Along this line are network drivers in the device layers and TCP/IP, which is in the protocol layers.

Processes communicate using the client and server model. In this model, a server process, one end point of a two-way communication path, listens to a socket. The client process, the other end of the communication path, communicates to the server process over another socket. The client process can be on another machine. The kernel maintains internal connections and routes data from client to server.

Within the socket layer, the socket data structure is the focus of activity. The system-call interface subroutines manage the activities related to a subroutine, collecting the subroutine parameters and converting program data into the format expected by second-level subroutines.

Most of the socket facilities are implemented within second-level subroutines. These second-level subroutines directly manipulate socket data structures and manage the synchronization between asynchronous activities.

Socket Interface to Network Facilities

The socket interprocess communication (IPC) facilities, illustrated by the Operating System Layer Examples figure (Figure 30), are layered on top of networking facilities. Data flows from an application program through the socket layer to the networking support. A protocol-related state is maintained in auxiliary data structures that are specific to the supporting protocols. The socket level passes responsibility for storage associated with transmitted data to the network level.

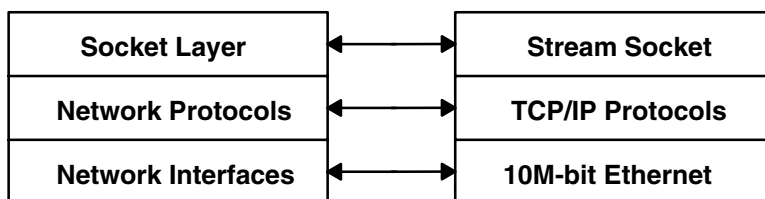

Operating System Layer Examples

Figure 30. Operating System Layer Examples. This diagram shows three layers on the left as follows from the top: socket layer, network protocols, and network interfaces. The three layers on the right are as follows from the top: stream socket, TCP/IP protocols, and 10M-bit Ethernet. Data flows both ways between layers of the same level (for example, between the socket layer and the stream socket).

Some of the communication domains supported by the socket IPC facility provide access to network protocols. These protocols are implemented as a separate software layer logically below the socket software in the kernel. The kernel provides ancillary services, such as buffer management, message routing, standardized interfaces to the protocols, and interfaces to the network interface drivers for the use of the various network protocols.

User request and control output subroutines serve as the interface from the socket subroutines to the communication protocols.

Note: Socket error codes issued for network communication errors are defined as codes 57 through 81 and are in the `/usr/include/sys/errno.h` file.

Socket Subroutines

Socket subroutines enable interprocess and network interprocess communications (IPC). Some socket routines are grouped together as the Socket Kernel Service subroutines (see “Kernel Service Subroutines” on page 248).

Note: Do not call any Socket Kernel Service subroutines from kernel extensions.

The socket subroutines still maintained in the `libc.a` library are grouped together under the heading of Network Library Subroutines (see “Network Library Subroutines” on page 249). Application programs can use both types of socket subroutines for IPC.

Socket Header Files

Socket header files contain data definitions, structures, constants, macros, and options used by socket subroutines. An application program must include the appropriate header file to make use of structures or other information a particular socket subroutine requires. Commonly used socket header files are:

/usr/include/netinet/in.h	Defines Internet constants and structures.
/usr/include/arpa/nameser.h	Contains Internet name server information.
/usr/include/netdb.h	Contains data definitions for socket subroutines.
/usr/include/resolv.h	Contains resolver global definitions and variables.
/usr/include/sys/socket.h	Contains data definitions and socket structures.
/usr/include/sys/socketvar.h	Defines the kernel structure per socket and contains buffer queues.
/usr/include/sys/types.h	Contains data type definitions.
/usr/include/sys/un.h	Defines structures for the UNIX interprocess communication domain.
/usr/include/sys/ndd_var.h	Defines structures for the operating system Network Device Driver (NDD) domain.
/usr/include/sys/atmsock.h	Contains constants and structures for the Asynchronous Transfer Mode (ATM) protocol in the operating system NDD domain.

In addition to commonly used socket header files, Internet address translation subroutines require the inclusion of the **inet.h** file. The **inet.h** file is located in the **/usr/include/arpa** directory.

Socket Address Data Structures

The socket data structure defines the socket. During a socket subroutine, the system dynamically creates the socket data structure. The socket address is specified by a data structure that is defined in a header file. See the sockaddr Structure figure (Figure 31) for an illustration of this data structure.

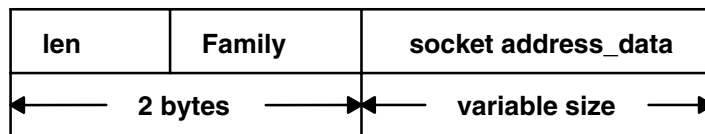

sockaddr Structure

Figure 31. sockaddr Structure. This diagram shows the sockaddr structure containing the following from the left: len, family, and socket address_data. The second line of the diagram gives the size of the sections in the first line as follows: len and family together equal 2 bytes, socket address_data is a variable size.

The **/usr/include/sys/socket.h** file contains the **sockaddr** structure. The contents of the **sa_data** structure depend on the protocol in use.

The types of socket-address data structures are as follows:

struct sockaddr_in	Defines sockets used for machine-to-machine communication across a network and interprocess communication (IPC). The /usr/include/netinet/in.h file contains the sockaddr_in structure.
struct sockaddr_un	Defines UNIX domain sockets used for local IPC only. These sockets require complete path name specification and do not traverse networks. The /usr/include/sys/un.h file contains the sockaddr_un structure.
struct sockaddr_ndd	Defines the operating system NDD sockets used for machine-to-machine communication across a physical network. The /usr/include/sys/ndd_var.h file contains the sockaddr_ndd structure. Depending upon socket types and protocol, other header files may need to be included.

Socket Communication Domains

Sockets that share common communication properties, such as naming conventions and protocol address formats, are grouped into *communication domains*. A communication domain is sometimes referred to as name or address space.

The communication domain includes the following:

- Rules for manipulating and interpreting names
- Collection of related address formats that comprise an address family
- Set of protocols, called the protocol family

Communication domains also consist of two categories, socket types and descriptors. Socket types include stream, datagram, sequenced packet, raw, and connection-oriented datagram.

Address Formats

An address format indicates what set of rules was used in creating network addresses of a particular format. For example, in the Internet communication domain, a host address is a 32-bit value that is encoded using one of four rules based on the type of network on which the host resides.

Each communication domain has different rules for valid socket names and interpretation of names. After a socket is created, it can be given a name according to the rules of the communication domain in which it was created. For example, in the UNIX communication domain, sockets are named with operating system path names. A socket can be named `/dev/foo`. Sockets normally exchange data only with sockets in the same communication domain.

Address Families

The **socket** subroutine takes an address family as a parameter. Specifying an address family indicates to the system how to interpret supplied addresses. The `/usr/include/sys/socket.h` and `/usr/include/sys/socketvar.h` files define the address families.

A socket subroutine that takes an address family (AF) as a parameter can use **AF_UNIX** (UNIX), **AF_INET** (Internet), **AF_NS** (Xerox Network Systems), or **AF_NDD** (Network Device Drivers of the operating system) protocol. These address families are part of the following communication domains:

UNIX	Provides socket communication between processes running on the same operating system when an address family of AF_UNIX is specified. A socket name in the UNIX domain is a string of ASCII characters whose maximum length depends on the machine in use.
Internet	Provides socket communication between a local process and a process running on a remote host when an address family of AF_INET is specified. The Internet domain requires that Transmission Control Protocol/Internet Protocol (TCP/IP) be installed on your system. A socket name in the Internet domain is an Internet address, made up of a 32-bit IP address and a 16-bit port address.
NDD	Provides socket communication between a local process and a process running on a remote host when an address family of AF_NDD is specified. The NDD domain enables applications to run directly on top of physical networks. This is in contrast to the Internet domain, in which applications run on top of transport protocols such as TCP, or User Datagram Protocol (UDP). A socket name in the NDD domain consists of operating system NDD name and a second part that is protocol dependent.

Communication domains are described by a domain data structure that is loadable. Communication protocols within a domain are described by a structure that is defined within the system for each protocol implementation configured. When a request is made to create a socket, the system uses the name of the communication domain to search linearly the list of configured domains. If the domain is found, the

domain's table of supported protocols is consulted for a protocol appropriate for the type of socket being created or for a specific protocol request. (A wildcard entry may exist for a raw domain.) Should multiple protocol entries satisfy the request, the first is selected.

UNIX Domain Properties

Characteristics of the UNIX domain are:

- Types of sockets** In the UNIX domain, the **SOCK_STREAM** socket type provides pipe-like facilities, while the **SOCK_DGRAM** and **SOCK_SEQPACKET** socket types usually provide reliable message-style communications.
- Naming** Socket names are strings and appear in the file system name space through portals.

Passing File Descriptors

In the Unix system it is possible to pass an open file between processes in a couple of ways:

1. From a parent to a child by opening it in the parent and then either fork or exec another process. This has obvious shortcomings.
2. Between any processes using a Unix domain socket, as described below. This is a more general technique.

Passing a file descriptor from one process to another means taking an open file in the sending process and generating another pointer to the file table entry in the receiving process. To pass a file descriptor from any arbitrary process to another, it is necessary for the processes to be connected with a Unix domain socket (a socket whose family type is **AF_UNIX**). Thereafter, one can pass a descriptor from the sending process by using the `sendmsg()` system call to the receiving process, which must perform the `recvmsg()` system call. These two system calls are the only ones supporting the concept of "access rights" which is how descriptors are passed.

Basically "access rights" imply that the owning process has acquired the rights to the corresponding system resource by opening it. This right is then passed by this process (the sending process) to a receiving process using the aforesaid system calls. Typically, file descriptors are passed through the access rights mechanism.

The `msghdr` structure in `sys/socket.h` contains the following field:

`caddr_t msg_accrights` access rights sent/received

The file descriptor is passed through this field of the message header, which is used as a parameter in the corresponding `sendmsg()` system call.

Internet Domain Properties

Characteristics of the Internet domain are:

- Socket types and protocols** The **SOCK_STREAM** socket type is supported by the Internet TCP protocol; the **SOCK_DGRAM** socket type, by the UDP protocol. Each is layered atop the transport-level IP. The Internet Control Message Protocol (ICMP) is implemented atop or beside IP and is accessible through a raw socket.
- Naming** Sockets in the Internet domain have names composed of a 32-bit Internet address and a 16-bit port number. Options can be used to provide IP source routing or security options. The 32-bit address is composed of network and host parts; the network part is variable in size and is frequency encoded. The host part can be interpreted optionally as a subnet field plus the host on a subnet; this is enabled by setting a network address mask.

Raw access

The Internet domain allows a program with root-user authority access to the raw facilities of IP. These interfaces are modeled as **SOCK_RAW** sockets. Each raw socket is associated with one IP protocol number and receives all traffic for that protocol. This allows administrative and debugging functions to occur and enables user-level implementations of special-purpose protocols such as inter-gateway routing protocols.

The Operating System Network Device Driver (NDD) Domain Properties

Characteristics of the operating system NDD domain are:

- Socket types and protocols** The **SOCK_DGRAM** socket type is supported by the connectionless datagram protocols. These include Ethernet, token ring, Fiber Distributed Data Interface (FDDI), and FCS protocols. This socket type allows applications to send and receive datagrams directly over these media types. The **SOCK_CONN_DGRAM** socket type is supported by connection-oriented datagram protocols. Currently, Asynchronous Transfer Mode (ATM) is the only protocol defined for this socket type. This socket type has the property of connection-oriented, unreliable, message delivery service.
- Naming** Sockets in the NDD domain have names composed of the operating system NDD name and a second part that is protocol dependent. For example, for ATM, this part contains a 20-byte destination address and subaddress.

Socket Addresses

Sockets can be named with an address so that processes can connect to them. The socket layer treats an address as an opaque object. Applications supply and receive addresses as tagged, variable-length byte strings. Addresses always reside in a memory buffer (mbuf) on entry to the socket layer. A data structure called a **sockaddr** (see “Socket Address Data Structures” on page 195) can be used as a template for referring to the identifying tag of each socket address.

Each address-family implementation includes subroutines for address family-specific operations. When addresses must be manipulated (for example, to compare them for equality) a pointer to the address (a **sockaddr** structure) is used to extract the address family tag. This tag is then used to identify the subroutine to invoke the desired operation.

Socket Address Storage

Addresses passed by an application program commonly reside in mbufs only long enough for the socket layer to pass them to the supporting protocol for transfer into a fixed-sized address structure. This occurs, for example, when a protocol records an address in a protocol control block. The **sockaddr** structure is the common means by which the socket layer and network-support facilities exchange addresses. The size of the generic data array was chosen to be large enough to hold most addresses directly. Communications domains that support larger addresses may ignore the array size (see “Socket Communication Domains” on page 196).

- The UNIX communication domain stores file-system path names in mbufs and allows socket names as large as 108 bytes.
- The Internet communication domain uses a structure that combines an Internet address and a port number. The Internet protocols reserve space for addresses in an Internet control-block data structure and free up mbufs that contain addresses after copying their contents.

Socket Addresses in TCP/IP

Transmission Control Protocol/Internet Protocol (Chapter 11, “Transmission Control Protocol/Internet Protocol,” on page 295) provides a set of 16-bit port numbers within each host. Because each host assigns port numbers independently, it is possible for ports on different hosts to have the same port

number. TCP/IP creates the *socket address* as an identifier that is unique throughout all Internet networks. TCP/IP concatenates the Internet address of the local host interface with the port number to devise the Internet socket address.

With TCP/IP, sockets are not tied to a destination address. Applications sending messages can specify a different destination address for each datagram, if necessary, or they can tie the socket to a specific destination address for the duration of the connection (see SOCK_DGRAM in “Socket Types” on page 201).

Because the Internet address is always unique to a particular host on a network, the socket address for a particular socket on a particular host is unique. Additionally, because each connection is fully specified by the pair of sockets it joins, every connection between Internet hosts is also uniquely identified.

The port numbers up to 255 are reserved for official Internet services. Port numbers in the range of 256-1023 are reserved for other well-known services that are common on Internet networks. When a client process needs one of these well-known services at a particular host, the client process sends a service request to the socket address for the well-known port at the host.

If a process on the host is listening at the well-known port, the server process either services the request using the well-known port or transfers the connection to another port that is temporarily assigned for the duration of the connection to the client. Using temporarily-assigned (or secondary) ports frees the well-known port and allows the host well-known port to handle additional requests concurrently.

The port numbers for well-known ports are listed in the */etc/services* file. The port numbers above 1023 are generally used by processes that need a temporary port after an initial service request has been received. These port numbers are generated randomly and used on a first-come, first-served basis.

Socket Addresses in the Operating System Network Device Driver (NDD)

In the operating system NDD domain, socket addresses contain the NDD name, which associates the socket with the local device (or adapter). Socket addresses also contain a protocol-dependent part.

Typically, applications use the **bind** subroutine to bind a socket to a particular local device and 802.2 service access point (SAP). The information used to bind to a particular NDD and packet type are specified in the NDD socket address passed into the **bind** subroutine. After the socket is bound, it can be used to receive packets for the bound SAP addressed to the local host’s medium access control (MAC) address (or the broadcast address) for that device. Raw packets can be transmitted using the **send**, **sendto**, and **sendmsg** socket subroutines.

The protocol-dependent parts of the operating system NDD socket address structure are defined as follows:

- | | |
|-------------------|---|
| Ethernet | The Ethernet NDD sockaddr is defined in the sys/ndd_var.h file. The sockaddr structure name is sockaddr_ndd_8022 . This sockaddr allows you to bind to an Ethernet type number or an 802.2 SAP number. When bound to a particular type or SAP, a socket can be used to receive packets of that type or SAP. Packets to be transmitted must be complete Ethernet packets that include the MAC and logical link control (LLC) headers. |
| Token Ring | The token-ring NDD sockaddr is defined in the sys/ndd_var.h file. The sockaddr structure name is sockaddr_ndd_8022 . This sockaddr allows you to bind to an 802.2 SAP number. When bound to a particular type or SAP, a socket can be used to receive packets of that type or SAP. Packets to be transmitted must be complete token ring packets that include the MAC and LLC headers. |

FDDI	The Fiber Distributed Data Interface (FDDI) NDD sockaddr is defined in the sys/ndd_var.h file. The sockaddr structure name is sockaddr_ndd_8022 . This sockaddr allows you to bind to an 802.2 SAP number. When bound to a particular type or SAP, a socket can be used to receive packets of that type or SAP. Packets to be transmitted must be complete FDDI packets that include the MAC and LLC headers.
FCS	The FCS NDD sockaddr is defined in the sys/ndd_var.h file. The sockaddr structure name is sockaddr_ndd_8022 . This sockaddr allows you to bind to an 802.2 SAP number. When bound to a type or SAP, a socket can be used to receive packets of that type or SAP. Packets to be transmitted must be complete FCS packets that include the MAC and LLC headers.
ATM	Defined in the sockaddr_ndd_atm structure in the /sys/atmsock.h file. The sndd_atm_vc_type field specifies CONN_PVC or CONN_SVC , for Asynchronous Transfer Mode (ATM) permanent virtual circuit (PVC) and ATM switched virtual circuit (SVC), respectively. For ATM PVCs, the first four octets of the sndd_atm_addr field contain the virtual path identifier:virtual channel identifier (VPI:VCI) for a virtual circuit. For ATM SVCs, the sndd_atm_addr field contains the 20-octet ATM address, and the sndd_atm_subaddr field contains the 20-octet ATM subaddress, if applicable.

NDD protocols of the operating system that support 802.2 LLC encapsulation use the **sockaddr_ndd_8022** structure for defining the NDD and 802.2 SAP to be used for input filtering. Currently, the only NDD protocol that does not use this structure is ATM. The **sockaddr_ndd_8022** structure contains the following fields:

sndd_8022_len	Contains the socket address length.
sndd_8022_family	Contains the socket address family (for example, AF_NDD).
sndd_8022_nddname[NDD_MAXNAMELEN]	Contains the NDD device name for the Ethernet device (for example, ent0).
sndd_8022_filterlen	Contains the size of the remaining fields that define the input filter. For 802.2 encapsulated protocols, this is the size of struct ns_8022 .

sndd_8022_ns

Contains the filter structure and allows the application to specify the types of packets to be received by this socket. This structure contains the following fields:

filtertype

Contains the type of filter. This includes 802.2 LLC, 802.2 Logical Link Control/Sub-Network Access Protocol (LLC/SNAP), as well as standard Ethernet. A special "wildcard" filter type is supported that allows ALL packets to be received. This type, **NS_TAP**, and all standard filter types are defined in the **sys/ndd_var.h** file.

dsap For 802.2 LLC filters, this specifies the SAP used for filtering incoming packets. The application "binds" to this SAP and then receives packets addressed to this SAP, for example, 0xaa for 802.2 LLC/SNAP encapsulations.

orgcode[3]

For 802.2 LLC filters, this specifies the organization code.

ethertype

For 802.2 LLC SNAP and standard Ethernet filter types, this field specifies the **ethertype**. An example is 0x800 for IP over Ethernet and IP over 802.2 LLC/SNAP encapsulations.

Socket Types and Protocols

Socket subroutines take socket types and socket protocols as parameters. An application program specifying a socket type indicates the desired communication style for that socket or socket pair. An application program specifying a socket protocol indicates the desired type of service. This service must be within the allowable services of the protocol family.

Socket Types

Sockets are classified according to communication properties. Processes usually communicate between sockets of the same type. However, if the underlying communication protocols support the communication, sockets of different types can communicate.

Each socket has an associated type, which describes the semantics of communications using that socket. The socket type determines the socket communication properties such as reliability, ordering, and prevention of duplication of messages. The basic set of socket types is defined in the **sys/socket.h** file:

```
/*Standard socket types */
#define SOCK_STREAM      1 /*virtual circuit*/
#define SOCK_DGRAM      2 /*datagram*/
#define SOCK_RAW         3 /*raw socket*/
#define SOCK_RDM         4 /*reliably-delivered message*/
#define SOCK_CONN_DGRAM 5 /*connection datagram*/
```

Other socket types can be defined.

The operating system supports the following basic set of sockets:

SOCK_DGRAM

Provides datagrams, which are connectionless messages of a fixed maximum length. This type of socket is generally used for short messages, such as a name server or time server, because the order and reliability of message delivery is not guaranteed.

In the UNIX domain, the **SOCK_DGRAM** socket type is similar to a message queue. In the Internet domain, the **SOCK_DGRAM** socket type is implemented on the User Datagram Protocol/Internet Protocol (UDP/IP) protocol.

A *datagram* socket supports the bidirectional flow of data, which is not sequenced, reliable, or unduplicated. A process receiving messages on a datagram socket may find messages duplicated or in an order different than the order sent. Record boundaries in data, however, are preserved. Datagram sockets closely model the facilities found in many contemporary packet-switched networks.

SOCK_STREAM

Provides sequenced, two-way byte streams with a transmission mechanism for stream data. This socket type transmits data on a reliable basis, in order, and with out-of-band capabilities.

In the UNIX domain, the **SOCK_STREAM** socket type works like a pipe. In the Internet domain, the **SOCK_STREAM** socket type is implemented on the Transmission Control Protocol/Internet Protocol (TCP/IP) protocol.

A *stream* socket provides for the bidirectional, reliable, sequenced, and unduplicated flow of data without record boundaries. Aside from the bidirectionality of data flow, a pair of connected stream sockets provides an interface nearly identical to pipes.

SOCK_RAW

Provides access to internal network protocols and interfaces. This type of socket is available only to users with root-user authority, or to non-root users who have the **CAP_NUMA_ATTACH** capability. (For non-root raw socket access, the `chuser` command assigns the **CAP_NUMA_ATTACH** capability, along with **CAP_PROPAGATE**. For further information, refer to the `chuser` command.)

Raw sockets allow an application to have direct access to lower-level communication protocols. Raw sockets are intended for advanced users who want to take advantage of some protocol feature that is not directly accessible through a normal interface, or who want to build new protocols on top of existing low-level protocols.

Raw sockets are normally datagram-oriented, though their exact characteristics are dependent on the interface provided by the protocol.

SOCK_SEQPACKET

Provides sequenced, reliable, and unduplicated flow of information.

SOCK_CONN_DGRAM

Provides connection-oriented datagram service. This type of socket supports the bidirectional flow of data, which is sequenced and unduplicated, but is not reliable. Because this is a connection-oriented service, the socket must be connected prior to data transfer. Currently, only the Asynchronous Transfer Mode (ATM) protocol in the Network Device Driver (NDD) domain supports this socket type.

The **SOCK_DGRAM** and **SOCK_RAW** socket types allow an application program to send datagrams to correspondents named in **send** subroutines. Application programs can receive datagrams through sockets using the **recv** subroutines. The *Protocol* parameter is important when using the **SOCK_RAW** socket type to communicate with low-level protocols or hardware interfaces. The application program must specify the address family in which the communication takes place.

The **SOCK_STREAM** socket types are full-duplex byte streams. A stream socket must be connected before any data can be sent or received on it. When using a stream socket for data transfer, an application program needs to perform the following sequence:

1. Create a connection to another socket with the **connect** subroutine.

2. Use the **read** and **write** subroutines or the **send** and **recv** subroutines to transfer data.
3. Use the **close** subroutine to finish the session.

An application program can use the **send** and **recv** subroutines to manage out-of-band data.

SOCK_STREAM communication protocols are designed to prevent the loss or duplication of data. If a piece of data for which the peer protocol has buffer space cannot be successfully transmitted within a reasonable period of time, the connection is broken. When this occurs, the **socket** subroutine indicates an error with a return value of -1 and the **errno** global variable is set to **ETIMEDOUT**. If a process sends on a broken stream, a **SIGPIPE** signal is raised. Processes that cannot handle the signal terminate. When out-of-band data arrives on a socket, a **SIGURG** signal is sent to the process group.

The process group associated with a socket can be read or set by either the **SIOCGPGRP** or **SIOCSPGRP** ioctl operation. To receive a signal on any data, use both the **SIOCSPGRP** and **FIOASYNC** ioctl operations. These operations are defined in the **sys/ioctl.h** file.

Socket Protocols

A *protocol* is a standard set of rules for transferring data, such as UDP/IP and TCP/IP. An application program can specify a protocol only if more than one protocol is supported for this particular socket type in this domain.

Each socket can have a specific protocol associated with it. This protocol is used within the domain to provide the semantics required by the socket type. Not all socket types are supported by each domain; support depends on the existence and implementation of a suitable protocol within the domain.

The **/usr/include/sys/socket.h** file contains a list of socket protocol families. The following list provides examples of protocol families (PF) found in the **socket** header file:

PF_UNIX	Local communication
PF_INET	Internet (TCP/IP)
PF_NDD	The operating system NDD

These protocols are defined to be the same as their corresponding address families in the **socket** header file. Before specifying a protocol family, the programmer should check the **socket** header file for currently supported protocol families. Each protocol family consists of a set of protocols. Major protocols in the suite of Internet Network Protocols include:

- TCP
- UDP
- IP
- Internet Control Message Protocol (ICMP)

Read more about these protocols in "Internet Transport-Level Protocols" in *Networks and communication management*.

Reliable Datagram Sockets over Infiniband

Reliable Datagram Sockets (RDS) is a connectionless protocol that provides an in-order and no-duplicate service over Infiniband. RDS exposes the User Datagram Protocol (UDP) subset of the socket API.

RDS is part of the **AF_BYPASS** domain that is used for protocols that bypass the kernel network.

Creating an RDS socket

To create an RDS socket, invoke the **socket()** system call by adding the following lines to the application program:

```
#include <sys/bypass.h>
sock = socket (AF_BYPASS, SOCK_SEQPACKET, BYPASSPROTO_RDS);
```

If the **BYPASSPROTO_RDS** protocol is the only reliable datagram protocol supported in the **AF_BYPASS** family, you can also invoke the `socket()` system call as follows:

```
#include <sys/bypass.h>
sock = socket (AF_BYPASS, SOCK_SEQPACKET, 0);
```

RDS also supports the following system calls:

- `sendmsg()`
- `recvmsg()`
- `close()`

For more information about creating a socket subroutine, see `socket Subroutine` in *AIX 5L Version 5.3 Technical Reference: Communications Volume 2*.

The `rdscctl` Utility

To modify the tunables and the diagnostics for RDS Statistics, the `rdscctl` utility is provided (`/usr/sbin/rdscctl`). The utility can be used after RDS is loaded (`bypassctrl load rds`). To provide the usage, run the command `rdscctl` with no arguments.

Statistics

To display various RDS statistics:

```
# rdscctl stats
```

To reset the statistics:

```
# rdscctl stats reset
```

Tuning Parameters

The following RDS parameters can be tuned after RDS is loaded, but before any RDS application is run:

rdscctl sendspace This refers to the high-water mark of the per-flow sendbuffer. (There may be multiple flows per socket.) The default value is 524288 bytes (512KB). The value is set using the command: `# rdscctl set rds_sendspace=<value in bytes>`

rdscctl recvspace This refers to the per-flow high-water mark of the per-socket receive-buffer. For every additional flow to this socket, the receive high-water mark is bumped up by this value. The default value is 524288 bytes (512 KB). The value is set using the command: `# rdscctl set rds_recvspace=<value in bytes>`

Note: For good RDS streaming performance, the `rdscctl sendspace` and `rdscctl recvspace` must be at least four-times the largest RDS `sendmsg` size. RDS sends an ACK for each 4 messages received and if the `rdscctl recvspace` is not at least 4X the message size, the throughput will be very low.

rdscctl mclustsize This refers to the size of the individual memory cluster which is also the message fragment size. The default size is 16384 bytes (16 KB). The value, always a multiple of 4096, is set using the command: `# rdscctl set rds_mclustsize=<multiple of 4096, in bytes>`

Attention: The `rds_mclustsize` value must be the same on all machines (nodes) in the cluster. Changing this value also has performance implications.

The current values for the parameters above can be retrieved using the command: `# rdsctrl get <parameter>`.

To provide the list of tunables:

```
# rdsctrl get
```

Socket Creation

The basis for communication between processes centers on the socket mechanism. The socket is comparable to the operating system file-access mechanism that provides an end point for communication. Application programs request the operating system to create a socket through the use of socket subroutines. Subroutines used to create sockets are:

- **socket**
- **socketpair**

When an application program requests the creation of a new socket, the operating system returns an integer that the application program uses to reference the newly created socket. The socket descriptor is an unsigned integer that is the lowest unused number usable for a descriptor. The descriptor is indexed to the kernel descriptor table. A process can obtain a socket descriptor table by creating a socket or inheriting one from a parent process.

To create a socket with the **socket** subroutine, the application program must include a communication domain and a socket type. Also, it may include a specific communication protocol within the specified communication domain.

For additional information about creating sockets, read the following concepts:

- “Socket Header Files” on page 195
- “Socket Connections” on page 207

Binding Names to Sockets

The **socket** subroutine creates a socket without a name. An unnamed socket is one without any association to local or destination addresses. Until a name is bound to a socket, processes have no way to reference it and consequently, no message can be received on it.

Communicating processes are bound by an association. The **bind** subroutine allows a process to specify half of an association: local address, local port, or local path name. The **connect** and **accept** subroutines are used to complete a socket’s association. Each domain association can have a different composite of addresses. The domain associations are as follows:

Internet domain	Produces an association composed of local and foreign addresses and local and foreign ports.
UNIX domain	Produces an association composed of local and foreign path names.
NDD domain	(Network Device Driver of the operating system) Provides an association composed of local device name (operating system NDD name) and foreign addresses, the form of which depends on the protocol being used.

An application program may not care about the local address it uses and may allow the protocol software to select one. This is not true for server processes. Server processes that operate at a well-known port need to be able to specify that port to the system.

In most domains, associations must be unique. Internet domain associations must never include duplicate protocol, local address, local port, foreign address, or foreign port tuples.

UNIX domain sockets need not always be bound to a name, but when bound can never include duplicate protocol, local path name, or foreign path name tuples. The path names cannot refer to files already on the system.

The **bind** subroutine accepts the *Socket*, *Name*, and *NameLength* parameters. The *Socket* parameter is the integer descriptor of the socket to be bound. The *Name* parameter specifies the local address, and the *NameLength* parameter indicates the length of address in bytes. The local address is defined by a data structure termed **sockaddr** (see “Socket Address Data Structures” on page 195).

In the Internet domain, a process does not have to bind an address and port number to a socket, because the **connect** and **send** subroutines automatically bind an appropriate address if they are used with an unbound socket.

In the NDD domain, a process must bind a local NDD name to a socket.

The bound name is a variable-length byte string that is interpreted by the supporting protocols. Its interpretation can vary from communication domain to communication domain (this is one of the properties of the domain). In the Internet domain, a name contains an Internet address, a length, and a port number. In the UNIX domain, a name contains a path name, a length, and an address family, which is always **AF_UNIX**.

Binding Addresses to Sockets

Binding addresses to sockets in the Internet domain demands a number of considerations. Port numbers are allocated out of separate spaces, one for each system and one for each domain on that system.

Note: Because the association is created in two steps, the association uniqueness requirement indicated previously could be violated unless care is taken. Further, user programs do not always know proper values to use for the local address and local port because a host can reside on multiple networks, and the set of allocated port numbers is not directly accessible to a user.

Wildcard addressing is provided to aid local address binding in the Internet domain. When an address is specified as **INADDR_ANY** (a constant defined in the **netinet/in.h** file), the system interprets the address as any valid address.

Sockets with wildcard local addresses may receive messages directed to the specified port number and sent to any of the possible addresses assigned to a host. If a server process wished to connect only hosts on a given network, it would bind the address of the hosts on the appropriate network.

A local port can be specified or left unspecified (denoted by 0), in which case the system selects an appropriate port number for it.

The restriction on allocating ports was done to allow processes executing in a secure environment to perform authentication based on the originating address and port number. For example, the **rlogin(1)** command allows users to log in across a network without being asked for a password, if two conditions hold:

- The name of the system the user is logging in from is located in the **/etc/hosts.equiv** file on the system that the user is trying to log in to (or the system name and the user name are in the user’s **.rhosts** file in the user’s home directory).

- The user's login process is coming from a privileged port on the machine from which the user is logging in.

The port number and network address of the machine from which the user is logging in can be determined either by the *From* parameter result of the **accept** subroutine, or from the **getpeername** subroutine.

In certain cases, the algorithm used by the system in selecting port numbers is unsuitable for an application program. This is because associations are created in a two-step process. For example, the Internet File Transfer Protocol (FTP) specifies that data connections must always originate from the same local port. However, duplicate associations are avoided by connecting to different foreign ports. In this situation, the system disallows binding the same local address and port number to a socket if a previous data connection socket still exists. To override the default port selection algorithm, a **setsockopt** subroutine must be performed before address binding.

The **socket** subroutine creates a socket without any association to local or destination addresses. For the Internet protocols, this means no local protocol port number has been assigned. In many cases, application programs do not care about the local address they use and are willing to allow the protocol software to choose one for them. However, server processes that operate at a well-known port must be able to specify that port to the system. Once a socket has been created, a server uses the **bind** subroutine to establish a local address for it.

Not all possible bindings are valid. For example, the caller might request a local protocol port that is already in use by another program, or it might request an invalid local Internet address. In such cases, the **bind** subroutine is unsuccessful and returns an error message.

Obtaining Socket Addresses

New sockets sometimes inherit the set of open sockets that created them. The sockets program interface includes subroutines that allow an application to obtain the address of the destination to which a socket connects and the local address of a socket. The following socket subroutines allow a program to retrieve socket addresses:

- **getsockname**
- **getpeername**

For additional information that you might need before binding or obtaining socket addresses, read the following concepts:

- “Socket Header Files” on page 195
- “Socket Addresses” on page 198
- “Socket Connections”

Socket Connections

Initially, a socket is created in the unconnected state, meaning the socket is not associated with any foreign destination. The **connect** subroutine binds a permanent destination to a socket, placing it in the connected state. An application program must call the **connect** subroutine to establish a connection before it can transfer data through a reliable stream socket. Sockets used with connectionless datagram services need not be connected before they are used, but connecting sockets makes it possible to transfer data without specifying the destination each time.

The semantics of the **connect** subroutine depend on the underlying protocols. An application program desiring reliable stream delivery service in the Internet family should select the Transmission Control Protocol (TCP). In such cases, the **connect** subroutine builds a TCP connection with the destination and returns an error if it cannot. In the case of connectionless services, the **connect** subroutine does nothing more than store the destination address locally. Similarly, application programs desiring connection-oriented datagram service in the operating system Network Device Driver (NDD) family should

select the Asynchronous Transfer Mode (ATM) protocol. Connection in the ATM protocol establishes a permanent virtual circuit (PVC) or switched virtual circuit (SVC). For PVCs, the local station is set up, and there is no network activity. For SVCs, the virtual circuit is set up end-to-end in the network with the remote station.

Connections are established between a client process and a server process. In a connection-oriented network environment, a *client* process initiates a connection and a *server* process receives, or responds to, a connection. The client and server interactions occur as follows:

- The server, when willing to offer its advertised services, binds a socket to a well-known address associated with the service, and then passively listens on its socket. It is then possible for an unrelated process to rendezvous with the server.
- The server process socket is marked to indicate incoming connections are to be accepted on it.
- The client requests services from the server by initiating a connection to the server's socket. The client process uses a **connect** subroutine to initiate a socket connection.
- If the client process' socket is unbound at the time of the **connect** call, the system automatically selects and binds a name to the socket if necessary. This is the usual way that local addresses are bound to a socket.
- The system returns an error if the connection fails (any name automatically bound by the system, however, remains). Otherwise, the socket is associated with the server and data transfer can begin.

Server Connections

In the Internet domain, the server process creates a socket, binds it to a well-known protocol port, and waits for requests. If the server process uses a reliable stream delivery or the computing response takes a significant amount of time, it may be that a new request arrives before the server finishes responding to an old request. The **listen** subroutine allows server processes to prepare a socket for incoming connections. In terms of underlying protocols, the **listen** subroutine puts the socket in a passive mode ready to accept connections. When the server process starts the **listen** subroutine, it also informs the operating system that the protocol software should queue multiple simultaneous requests that arrive at a socket. The **listen** subroutine includes a parameter that allows a process to specify the length of the request queue for that socket. If the queue is full when a connection request arrives, the operating system refuses the connection by discarding the request. The **listen** subroutine applies only to sockets that have selected reliable stream delivery or connection-oriented datagram service.

A server process uses the **socket**, **bind**, and **listen** subroutines to create a socket, bind it to a well-known protocol address, and specify a queue length for connection requests. Invoking the **bind** subroutine associates the socket with a well-known protocol port, but the socket is not connected to a specific foreign destination. The server process may specify a wildcard allowing the socket to receive a connection request from an arbitrary client.

All of this applies to the connection-oriented datagram service in the NDD domain, except that the server process binds the locally created socket to the operating system NDD name and specifies ATM *B-LLI* and *B-HLI* parameters before calling the **listen** subroutine. If only *B-LLI* is specified, all incoming calls (or connections), regardless of the *B-HLI* value, will be passed to this application.

After a socket has been set up, the server process needs to wait for a connection. The server process waits for a connection by using the **accept** subroutine. A call to the **accept** subroutine blocks until a connection request arrives. When a request arrives, the operating system returns the address of the client process that has placed the request. The operating system also creates a new socket that has its destination connected to the requesting client process and returns the new socket descriptor to the calling server process. The original socket still has a wildcard foreign destination that remains open.

When a connection arrives, the call to the **accept** subroutine returns. The server process can either handle requests interactively or concurrently. In the interactive approach, the server handles the request itself, closes the new socket, and then starts the **accept** subroutine to obtain the next connection request.

In the concurrent approach, after the call to the **accept** subroutine returns, the server process forks a new process to handle the request. The new process inherits a copy of the new socket, proceeds to service the request, and then exits. The original server process must close its copy of the new socket and then invoke the **accept** subroutine to obtain the next connection request.

If a **select** call is made on a file descriptor of a socket waiting to perform an **accept** subroutine on the connection, when the ready message is returned it does not mean that data is there, only that the request was successfully completed. Now it is possible to start the **select** subroutine on the returned socket descriptor to see if data is available for a conversation on the message socket.

The concurrent design for server processes results in multiple processes using the same local protocol port number. In TCP-style communication, a pair of end points define a connection. Thus, it does not matter how many processes use a given local protocol port number as long as they connect to different destinations. In the case of a concurrent server, there is one process per client and one additional process that accepts connections. The main server process has a wildcard for the destination, allowing it to connect with an arbitrary foreign site. Each remaining process has a specific foreign destination. When a TCP data segment arrives, it is sent to the socket connected to the segment's source. If no such socket exists, the segment is sent to the socket that has a wildcard for its foreign destination. Furthermore, because the socket with a wildcard foreign destination does not have an open connection, it only honors TCP segments that request a new connection.

Connectionless Datagram Services

The operating system provides support for connectionless interactions typical of the datagram facilities found in packet-switched networks. A datagram socket provides a symmetric interface to data exchange. Although processes are still likely to be client and server, there is no requirement for connection establishment. Instead, each message includes the destination address.

An application program can create datagram sockets using the **socket** subroutine. In the Internet domain, if a particular local address is needed, a **bind** subroutine must precede the first data transmission. Otherwise, the operating system sets the local address or port when data is first sent. In the NDD domain, **bind** must precede the first data transmission. The application program uses the **sendto** and **recvfrom** subroutines to transmit data; these calls include parameters that allow the client process to specify the address of the intended recipient of the data.

In addition to the **sendto** and **recvfrom** calls, datagram sockets can also use the **connect** subroutine to associate a socket with a specific destination address. In this case, any data sent on the socket is automatically addressed to the connected peer socket, and only data received from that peer is delivered to the client process. Only one connected address is permitted for each socket at one time; a second **connect** subroutine changes the destination address.

A **connect** subroutine request on a datagram socket results in the operating system recording the peer socket's address (as compared to a stream socket, where a connect request initiates establishment of an end-to-end connection). The **accept** and **listen** subroutines are not used with datagram sockets.

While a datagram socket is connected, errors from recent **send** subroutines can be returned asynchronously. These errors can be reported on subsequent operations on the socket, or a special socket option, **SO_ERROR**. This option, when used with the **getsockopt** subroutine, can be used to interrogate the error status. A **select** subroutine for reading or writing returns true when a process receives an error indication. The next operation returns the error, and the error status is cleared.

Read the following concepts for more information that you might need before connecting sockets:

- "Socket Header Files" on page 195
- "Socket Types and Protocols" on page 201

Socket Options

In addition to binding a socket to a local address or connecting it to a destination address, application programs need a method to control the socket. For example, when using protocols that use time out and retransmission, the application program may want to obtain or set the time-out parameters. An application program may also want to control the allocation of buffer space, determine if the socket allows transmission of broadcast, or control processing of out-of-band data (see “Out-of-Band Data” on page 211). The ioctl-style **getsockopt** and **setsockopt** subroutines provide the means to control socket operations. The **getsockopt** subroutine allows an application program to request information about socket options. The **setsockopt** subroutine allows an application program to set a socket option using the same set of values obtained with the **getsockopt** subroutine. Not all socket options apply to all sockets. The options that can be set depend on the current state of the socket and the underlying protocol being used.

For additional information that you might need when obtaining or setting socket options, read the following concepts:

- “Socket Header Files” on page 195
- “Socket Types and Protocols” on page 201
- “Out-of-Band Data” on page 211
- “IP Multicasts” on page 213

Socket Data Transfer

Most of the work performed by the socket layer is in sending and receiving data. The socket layer itself explicitly refrains from imposing any structure on data transmitted or received through sockets. Any data interpretation or structuring is logically isolated in the implementation of the communication domain.

Once a connection is established between sockets, an application program can send and receive data. Sending and receiving data can be done with any one of several subroutines. The subroutines vary according to the amount of information to be transmitted and received and the state of the socket being used to perform the operation.

- The **write** subroutine can be used with a socket that is in a connected state, as the destination of the data is implicitly specified by the connection.
- The **sendto** and **sendmsg** subroutines allow the process to specify the destination for a message explicitly.
- The **read** subroutine allows a process to receive data on a connected socket without receiving the sender’s address.
- The **recvfrom** and **recvmsg** subroutines allow the process to retrieve the incoming message and the sender’s address.

The applicability of the above subroutines varies from domain to domain and from protocol to protocol.

Although the **send** and **recv** subroutines are virtually identical to the **read** and **write** subroutines, the extra *flags* argument in the **send** and **recv** subroutines is important. The flags, defined in the **sys/socket.h** file, can be defined as a nonzero value if the application program requires one or more of the following:

MSG_OOB	Sends or receives out-of-band data.
MSG_PEEK	Looks at data without reading.
MSG_DONTROUTE	Sends data without routing packets.
MSG_MPEG2	Sends MPEG2 video data blocks.

Out-of-band data is specific to stream sockets. The option to have data sent without routing applied to the outgoing packets is currently used only by the routing table management process, and is unlikely to be of interest to the casual user. The ability to preview data is, however, of general interest. When the

MSG_PEEK flag is specified with a **recv** subroutine, any data present is returned to the user, but treated as still unread. That is, the next **read** or **recv** subroutine applied to the socket returns the data previously previewed.

Out-of-Band Data

The stream socket abstraction includes the concept of *out-of-band data*. Out-of-band (OOB) data is a logically independent transmission channel associated with each pair of connected stream sockets. Out-of-band data can be delivered to the socket independently of the normal receive queue or within the receive queue depending upon the status of the **SO_OOBINLINE** socket-level option. The abstraction defines that the out-of-band data facilities must support the reliable delivery of at least one out-of-band message at a time. This message must contain at least one byte of data, and at least one message can be pending delivery to the user at any one time.

For communication protocols that support only in-band signaling (that is, the urgent data is delivered in sequence with the normal data), the operating system normally extracts the data from the normal data stream and stores it separately. This allows users to choose between receiving the urgent data in order and receiving it out of sequence without having to buffer all the intervening data.

It is possible to peek at out-of-band data. If the socket has a process group, a **SIGURG** signal is generated when the protocol is notified of out-of-band data. A process can set the process group or process ID to be informed by the **SIGURG** signal through a **SIOCSPGRP** ioctl call.

Note: The `/usr/include/sys/ioctl.h` file contains the ioctl definitions and structures for use with socket ioctl calls.

If multiple sockets have out-of-band data awaiting delivery, an application program can use a **select** subroutine for exceptional conditions to determine those sockets with such data pending. Neither the signal nor the select indicates the actual arrival of the out-of-band data, but only notification that is pending.

In addition to the information passed, a logical mark is placed in the data stream to indicate the point at which the out-of-band data was sent. When a signal flushes any pending output, all data up to the mark in the data stream is discarded.

To send an out-of-band message, the **MSG_OOB** flag is supplied to a **send** or **sendto** subroutine. To receive out-of-band data, an application program must set the **MSG_OOB** flag when performing a **recvfrom** or **recv** subroutine.

An application program can determine if the read pointer is currently pointing at the logical mark in the data stream, by using the **SIOCATMARK** ioctl call.

A process can also read or peek at the out-of-band data without first reading up to the logical mark. This is more difficult when the underlying protocol delivers the urgent data in-band with the normal data, and only sends notification of its presence ahead of time (that is, the TCP protocol used to implement streams in the Internet domain). With such protocols, the out-of-band byte may not have arrived when a **recv** subroutine is performed with the **MSG_OOB** flag. In that case, the call will return an **EWOULDBLOCK** error code. There may be enough in-band data in the input buffer that normal flow control prevents the peer from sending the urgent data until the buffer is cleared. The process must then read enough of the queued data that the urgent data can be delivered.

Certain programs that use multiple bytes of urgent data and must handle multiple urgent signals need to retain the position of urgent data within the stream. The socket-level option, **SO_OOINLINE** provides the capability. With this option, the position of the urgent data (the logical mark) is retained. The urgent data immediately follows the mark within the normal data stream that is returned without the **MSG_OOB** flag. Reception of multiple urgent indications causes the mark to move, but no out-of-band data is lost.

Socket I/O Modes

Sockets can be set to either blocking or nonblocking I/O mode. The **FIONBIO** ioctl operation is used to determine this mode. When the **FIONBIO** ioctl is set, the socket is marked nonblocking. If a read is tried and the desired data is not available, the socket does not wait for the data to become available, but returns immediately with the **EWOULDBLOCK** error code.

Note: The **EWOULDBLOCK** error code is defined with the **_BSD** define and is equivalent to the **EAGAIN** error code.

When the **FIONBIO** ioctl is not set, the socket is in blocking mode. In this mode, if a read is tried and the desired data is not available, the calling process waits for the data. Similarly, when writing, if **FIONBIO** is set and the output queue is full, an attempt to write causes the process to return immediately with an error code of **EWOULDBLOCK**.

When performing nonblocking I/O on sockets, a program must check for the **EWOULDBLOCK** error code (stored in the **errno** global variable). This occurs when an operation would normally block, but the socket it was performed on is marked as nonblocking. The following socket subroutines return a **EWOULDBLOCK** error code:

- **accept**
- **send**
- **recv**
- **read**
- **write**

Processes using these subroutines should be prepared to deal with the **EWOULDBLOCK** error code. For a nonblocking socket, the **connect** subroutine returns an **EINPROGRESS** error code.

If an operation such as a **send** operation cannot be done completely, but partial writes are permissible (for example when using a stream socket), the data that can be sent immediately is processed, and the return value indicates the amount actually sent.

Socket Shutdown

Once a socket is no longer required, the calling program can discard the socket by applying a **close** subroutine to the socket descriptor. If a reliable delivery socket has data associated with it when a close takes place, the system continues to attempt data transfer. However, if the data is still undelivered, the system discards the data. Should the application program have no use for any pending data, it can use the **shutdown** subroutine on the socket prior to closing it.

Closing Sockets

Closing a socket and reclaiming its resources is not always a straightforward operation. In certain situations, such as when a process exits, a **close** subroutine is never expected to be unsuccessful. However, when a socket promising reliable delivery of data is closed with data still queued for transmission or awaiting acknowledgment of reception, the socket must attempt to transmit the data. If the socket discards the queued data to allow the **close** subroutine to complete successfully, it violates its promise to deliver data reliably. Discarding data can cause naive processes, which depend upon the implicit semantics of the **close** call, to work unreliably in a network environment. However, if sockets block until all data has been transmitted successfully, in some communication domains a **close** subroutine may never complete.

The socket layer compromises in an effort to address this problem and maintain the semantics of the **close** subroutine. In normal operation, closing a socket causes any queued but unaccepted connections to be discarded. If the socket is in a connected state, a disconnect is initiated. The socket is marked to indicate that a file descriptor is no longer referencing it, and the close operation returns successfully. When

the disconnect request completes, the network support notifies the socket layer, and the socket resources are reclaimed. The network layer may attempt to transmit any data queued in the socket's send buffer, although this is not guaranteed.

Alternatively, a socket may be marked explicitly to force the application program to linger when closing until pending data are flushed and the connection has shutdown. This option is marked in the socket data structure using the **setsockopt** subroutine with the **SO_LINGER** option. The **setsockopt** subroutine, using the **linger** option, takes a **linger** structure. When an application program indicates that a socket is to linger, it also specifies a duration for the lingering period. If the lingering period expires before the disconnect is completed, the socket layer forcibly shuts down the socket, discarding any data still pending.

IP Multicasts

The use of IP multicasting enables a message to be transmitted to a group of hosts, instead of having to address and send the message to each group member individually. Internet addressing provides for Class D addressing that is used for multicasting.

When a datagram socket is defined, the **setsockopt** subroutine can be modified. To join or leave a multicast group, use the **setsockopt** subroutine with the **IP_ADD_MEMBERSHIP** or **IP_DROP_MEMBERSHIP** flags. The interface that is used and the group used are specified in an **ip_mreq** structure that contains the following fields:

```
struct ip_mreq{
    struct in_addr imr.imr_interface.s_addr;
    struct in_addr imr.imr_multiaddr.s_addr;
}
```

The **in_addr** structure is defined as:

```
struct in_addr{
    ulong s_addr;
}
```

In order to send to a multicasting group it is not necessary to join the groups. For receiving transmissions sent to a multicasting group, membership is required. For multicast sending, use an **IP_MULTICAST_IF** flag with the **setsockopt** subroutine. This specifies the interface to be used. It may be necessary to call the **setsockopt** subroutine with the **IP_MULTICAST_LOOP** flag in order to control the loopback of multicast packets. By default, packets are delivered to all members of the multicast group including the sender, if it is a member. However, this can be disabled with the **setsockopt** subroutine using the **IP_MULTICAST_LOOP** flag.

The **setsockopt** subroutine flags that are required for multicast communication and used with the **IPPROTO_IP** protocol level follow:

IP_ADD_MEMBERSHIP	Joins a multicast group as specified in the <i>OptionValue</i> parameter of type struct ip_mreq . A maximum of 20 groups may be joined per socket.
IP_DROP_MEMBERSHIP	Leaves a multicast group as specified in the <i>OptionValue</i> parameter of type struct ip_mreq . Only allowable for processes with a user ID (UID) value of zero.
IP_MULTICAST_IF	Permits sending of multicast messages on an interface as specified in the <i>OptionValue</i> parameter of type struct ip_addr . An address of INADDR_ANY (0x00000000) removes the previous selection of an interface in the multicast options. If no interface is specified then the interface leading to the default route is used.
IP_MULTICAST_LOOP	Sets multicast loopback, determining whether or not transmitted messages are delivered to the sending host. An <i>OptionValue</i> parameter of type char is used to control loopback being on or off.
IP_MULTICAST_TTL	Sets the time-to-live (TTL) for multicast packets. An <i>OptionValue</i> parameter of type char is used to set this value between 0 and 255.

The following examples demonstrate the use of the **setsockopt** function with the protocol level set to Internet Protocol (**IPPROTO_IP**).

To mark a socket for sending to a multicast group on a particular interface:

```
struct ip_mreq imr;
setsockopt(s, IPPROTO_IP, IP_MULTICAST_IF, &imr.imr_interface.s_addr, sizeof(struct in_addr));
```

To disable the loopback on a socket:

```
char loop = 0;
setsockopt(s, IPPROTO_IP, IP_MULTICAST_LOOP, &loop, sizeof(char));
```

To allow address reuse for binding multiple multicast applications to the same IP group address:

```
int on = 1;
setsockopt(s, SOL_SOCKET, SO_REUSEADDR, &on, sizeof(int));
```

To join a multicast group for receiving:

```
struct ip_mreq imr;
setsockopt(s, IPPROTO_IP, IP_ADD_MEMBERSHIP, &imr, sizeof(struct ip_mreq));
```

To leave a multicast group:

```
struct ip_mreq imr;
setsockopt(s, IPPROTO_IP, IP_DROP_MEMBERSHIP, &imr, sizeof(struct ip_mreq));
```

The **getsockopt** function can also be used with the multicast flags to obtain information about a particular socket.

IP_MULTICAST_IF	Retrieves the interface's IP address.
IP_MULTICAST_LOOP	Retrieves the specified looping mode from the multicast options.
IP_MULTICAST_TTL	Retrieves the time-to-live in the multicast options.

Network Address Translation

Network library subroutines enable an application program to locate and construct network addresses while using interprocess communication facilities in a distributed environment.

Locating a service on a remote host requires many levels of mapping before client and server can communicate. A network service is assigned a name that is intended to be understandable for a user; such as "the login server on host prospero." This name and the name of the peer host must then be translated into network addresses. Finally, the address must then be used to determine a physical location and route to the service.

Network library subroutines map:

- Host names to network addresses
- Network names to network numbers
- Protocol names to protocol numbers
- Service names to port numbers

Additional network library subroutines exist to simplify the manipulation of names and addresses.

An application program must include the **netdb.h** file when using any of the network library subroutines.

Note: All networking services return values in standard network byte order.

Name Resolution

The process of obtaining an Internet address from a host name is known as name resolution and is done by the **gethostbyname** subroutine. The process of translating an Internet address into a host name is known as reverse name resolution and is done by the **gethostbyaddr** subroutine.

When a process receives a symbolic host name and needs to resolve it into an address, it calls a resolver routine.

Resolver routines on hosts running TCP/IP attempt to resolve names using the following sources:

- BIND/DNS (domain name server, named)
- Network Information Service (NIS)
- Local **/etc/hosts** file

To resolve a name in a domain network, the resolver routine first queries the domain name server database, which may be local if the host is a domain name server or may be on a foreign host. Name servers translate domain names into Internet addresses. The group of names for which a name server is responsible is its zone of authority. If the resolver routine is using a remote name server, the routine uses the Domain Name Protocol (DOMAIN) to query for the mapping. To resolve a name in a flat network, the resolver routine checks for an entry in the local **/etc/hosts** file. When NIS is used, the **/etc/hosts** file on the master server is checked.

By default, resolver routines attempt to resolve names using the above resources. BIND/DNS will be tried first. If the **/etc/resolv.conf** file does not exist or if BIND/DNS could not find the name, NIS is queried if it is running. If NIS is not running, then the local **/etc/hosts** file is searched. If none of these services could find the name then the resolver routines return with `HOST_NOT_FOUND`. If all of the services were unavailable, then the resolver routines return with `SERVICE_UNAVAILABLE`.

The default order can be overwritten by creating the configuration file, **/etc/netsvc.conf** and specifying the desired order. Both the default and **/etc/netsvc.conf** can be overwritten with the environment variable **NSORDER**. If either the **/etc/netsvc.conf** file or environment variable **NSORDER** are defined, then at least one value must be specified along with the option.

To specify host ordering with the **/etc/netsvc.conf** file:

```
hosts = value,value,value
```

where *value* is one of the listed sources.

To specify host ordering with the **NSORDER** environment variable:

```
NSORDER=value,value,value
```

The order is specified on one line with values separated by commas. White spaces are permitted between the commas and the equal sign. The values specified and their ordering depends on the network configuration. For example, if the local network is organized as a flat network, then only the **/etc/hosts** file is needed.

The **etc/netsvc.conf** file would contain the following line:

```
hosts=local
```

The **NSORDER** environment variable would be set as:

```
NSORDER=local
```

If the local network is a domain network using a name server for name resolution and an **/etc/hosts** file for backup, then both services should be specified.

The **etc/netsvc.conf** file would contain the following line:

```
hosts=bind,local
```

The **NSORDER** environment variable would be set as:

```
NSORDER=bind,local
```

Note: The values listed must be in lowercase.

The first source in the list will be tried. The algorithm will try another specified service if the:

- current service is not running, therefore, it is unavailable
- current service could not find the name and is not authoritative.

If the **/etc/resolv.conf** file does not exist, then BIND/DNS is considered to be not set up or running and therefore not available. If the subroutines, **getdomainname** and **yp_bind** fail, then it is assumed that the NIS service is not set up or running and therefore not available. If the **/etc/hosts** file could not be opened, then a local search is impossible and therefore the file and service are unavailable.

A service listed as *authoritative* means that it is the expert of its successors and should have the information requested. (The other services may contain only a subset of the information in the authoritative service.) Name resolution will end after trying a service listed as authoritative even if it does not find the name. If an authoritative service is not available, then the next service specified will be queried, otherwise the resolver routine will return with **HOST_NOT_FOUND**.

An authoritative service is specified with the string **=auth** directly behind a value. The entire word **authoritative** can be typed in, but only the **auth** will be used. For example, the **/etc/netsvc.conf** file could contain the following line:

```
hosts = nis=auth,bind,local
```

If NIS is running, then search is ended after the NIS query regardless of whether the name was found. If NIS is not running, then the next source is queried, which is BIND.

TCP/IP name servers use caching to reduce the cost of searching for names of hosts on remote networks. Instead of searching anew for a host name each time a request is made, a name server looks at its cache to see if the host name was resolved recently. Because domain and host names do change, each item remains in the cache for a limited length of time specified by the record's time to live (TTL). In this way, authorities can specify how long they expect the name resolution to be accurate.

In a DOMAIN name server environment, the host name set using the **hostname** command from the command line or in the **rc.net** file format must be the official name of the host as returned by the name server. Generally, this name is the full domain name of the host in the form:

```
host.subdomain.subdomain.rootdomain
```

If the host name is not set up as a fully qualified domain name, and if the system is set up to use a DOMAIN name server in conjunction with the **sendmail** program, the **sendmail** configuration file (**/etc/sendmail.cf**) must be edited to reflect this official host name. In addition, the domain name macros in this configuration file must be set for the **sendmail** program to operate correctly.

Note: The domain specified in the **/etc/sendmail.cf** file takes precedence over the domain set by the **hostname** command for all **sendmail** functions.

For a host that is in a domain network but is not a name server, the local domain name and domain name server are specified in the **/etc/resolv.conf** file. In a domain name server host, the local domain and other name servers are defined in files read by the named daemon when it starts.

Host Names

The following related network library subroutines map Internet host names to addresses:

- **gethostbyaddr**
- **gethostbyname**
- **sethostent**
- **endhostent**

The official name of the host and its public aliases are returned by the **gethostbyaddr** and **gethostbyname** subroutines, along with the address family and a null-terminated list of variable length addresses. The list of variable length addresses is required because it is possible for a host to have many addresses with the same name.

The database for these calls is provided either by the **/etc/hosts** file or by use of a **named** name server. Because of the differences in the databases and their access protocols, the information returned may differ. When using the host table version of the **gethostbyname** subroutine, only one address is returned, but all listed aliases are included. The name server version may return alternate addresses but does not provide any aliases other than the one given as a parameter value.

Network Names

Related network library subroutines to map network names to numbers and network numbers to names are:

- **getnetbyaddr**
- **getnetbyname**
- **getnetent**
- **setnetent**
- **endnetent**

The **getnetbyaddr**, **getnetbyname**, and **getnetent** subroutines extract their information from the **/etc/networks** file.

Protocol Names

Related network library subroutines to map protocol names are:

- **getprotobynumber**
- **getprotobyname**
- **getprotoent**
- **setprotoent**
- **endprotoent**

The **getprotobynumber**, **getprotobyname**, and **getprotoent** subroutines extract their information from the **/etc/protocols** file.

Service Names

Related network library subroutines to map service names to port numbers are:

- **getservbyname**
- **getservbyport**
- **getservent**
- **setservent**
- **endservent**

A service is expected to reside at a specific port and employ a particular communication protocol. The expectation is consistent within the Internet domain, but inconsistent within other network architectures. Further, a service can reside on multiple ports. If a service resides on multiple ports, the higher level library subroutines must be bypassed or extended. Services available are contained in the `/etc/services` file.

Network Byte-Order Translation

Related network library subroutines to convert network address byte order are:

- `htonl`
- `htons`
- `ntohl`
- `ntohs`

Internet Address Translation

Related network library subroutines to convert Internet addresses and dotted decimal notation are:

- `inet_addr`
- `inet_lnaof`
- `inet_makeaddr`
- `inet_netof`
- `inet_network`
- `inet_ntoa`

Network Host and Domain Names

The `hostid` parameter is an integer that identifies the host machine. Host IDs fall under the category of Internet network addressing because, by convention, the 32-bit Internet address is used. The socket subroutines that manage the host ID are:

- `gethostid`
- `sethostid`

Socket subroutines to manage the internal host name are:

- `gethostname`
- `sethostname`

When a site obtains authority for part of the domain name space, it invents a string that identifies its piece of the space and uses that string as the name of the domain. To manage the domain name, applications can use the following socket subroutines:

- `getdomainname`
- `setdomainname`

Domain Name Resolution

When a process receives a symbolic name and needs to resolve it into an address, it calls a resolver subroutine. The method used by the set of resolver subroutines to resolve names depends on the local host configuration. In addition, the organization of the network determines how a resolver subroutine communicates with remote name server hosts (the hosts that resolve names for other hosts). See TCP/IP name resolution in *Networks and communication management* for more information on name resolution.

A resolver subroutine determines which type of network it is dealing with by determining whether the `/etc/resolv.conf` file exists. If the file exists, a resolver subroutine assumes that the local network has a name server. Otherwise, it assumes that no name server is present.

To resolve a name with no name server present, a resolver subroutine checks the **/etc/hosts** file for an entry that maps the name to an address.

To resolve a name in a name server network, a resolver subroutine first queries the domain name server (DNS) database, which may be local host (if the host is a domain name server) or a foreign host. If the subroutine is using a remote name server, the subroutine uses the Domain Name Protocol (DOMAIN) to query for the mapping (see Domain Name Protocol in *Networks and communication management*). If this query is unsuccessful, the subroutine then checks for an entry in the local **/etc/hosts** file.

The resolver subroutines are used to make, send, and interpret packets for name servers in the Internet domain. Together, the following resolver subroutines form the set of functions that resolve domain names:

- **res_init**
- **res_mkquery**
- **res_search**
- **res_query**
- **res_send**
- **dn_comp**
- **dn_expand**
- **getshort**
- **getlong**
- **putshort**
- **putlong**

Note: The **res_send** subroutine does not perform interactive queries and expects the name server to handle recursion.

Global information used by these resolver subroutines is kept in the **_res** structure. This structure is defined in the **/usr/include/resolv.h** file and contains the following members:

Member	Contents
int	Denotes the retrans field.
int	Denotes the retry field.
long	Denotes the options field.
int	Denotes the nscount field.
struct	Denotes the sockaddr_in and nsaddr_list [MAXNS] fields.
ushort	Denotes the ID field.
char	Denotes the defdname [MAXDNAME] field.
#define	Denotes the nsaddr nsaddr_list [0] field.

The options field of the **_res** structure is constructed by logically ORing the following values:

RES_INIT	Indicates whether the initial name server and default domain name have been initialized (that is, whether the res_init subroutine has been called).
RES_DEBUG	Prints debugging messages.
RES_USEVC	Uses Transmission Control Protocol/Internet Protocol (TCP/IP) connections for queries instead of User Datagram Protocol/Internet Protocol (UDP/IP).
RES_STAYOPEN	Used with the RES_USEVC value, keeps the TCP/IP connection open between queries. Although UDP/IP is the mode normally used, TCP/IP mode and this option are useful for programs that regularly perform many queries.
RES_RECURSE	Sets the Recursion Desired bit for queries. This is the default.
RES_DEFNAMES	Appends the default domain name to single-label queries. This is the default.

Three environment variables affect values related to the `_res` structure:

LOCALDOMAIN	Overrides the default local domain, which is read from the <code>/etc/resolv.conf</code> file and stored in the <code>defname</code> field of the <code>_res</code> structure.
RES_TIMEOUT	Overrides the default value of the <code>retrans</code> field of the <code>_res</code> structure, which is the value of the <code>RES_TIMEOUT</code> constant defined in the <code>/usr/include/resolv.h</code> file. This value is the base time-out period in seconds between queries to the name servers. After each failed attempt, the time-out period is doubled. The time-out period is divided by the number of name servers defined. The minimum time-out period is 1 second.
RES_RETRY	Overrides the default value for the <code>retry</code> field of the <code>_res</code> structure, which is 4. This value is the number of times the resolver tries to query the name servers before giving up. Setting <code>RES_RETRY</code> to 0 prevents the resolver from querying the name servers.

Socket Examples

The socket examples are programming fragments that illustrate a socket function. They cannot be used in an application program without modification. They are intended only for illustrative purposes and are not for use within a program.

- “Socketpair Communication Example”
- “Reading Internet Datagrams Example Program” on page 221
- “Sending Internet Datagrams Example Program” on page 222
- “Reading UNIX Datagrams Example Program” on page 223
- “Sending UNIX Datagrams Example Program” on page 223
- “Initiating Internet Stream Connections Example Program” on page 224
- “Accepting Internet Stream Connections Example Program” on page 225
- “Checking for Pending Connections Example Program” on page 226
- “Initiating UNIX Stream Connections Example Program” on page 227
- “Accepting UNIX Stream Connections Example Program” on page 228
- “Sending Data on an ATM Socket PVC Client Example Program” on page 229
- “Receiving Data on an ATM Socket PVC Server Example Program” on page 230
- “Sending Data on an ATM Socket Rate-Enforced SVC Client Example Program” on page 231
- “Receiving Data on an ATM Socket Rate-Enforced SVC Server Example Program” on page 235
- “Sending Data on an ATM Socket SVC Client Example Program” on page 237
- “Receiving Data on an ATM Socket SVC Server Example Program” on page 240
- “Receiving Packets Over Ethernet Example Program” on page 243
- “Sending Packets Over Ethernet Example Program” on page 245
- “Analyzing Packets Over the Network Example Program” on page 247

Note: All socket applications must be compiled with `_BSD` set to a specific value. Acceptable values are 43 and 44. In addition, most applications should probably include the Berkeley Software Distribution (BSD) `libbsd.a` library.

Socketpair Communication Example

```
/* This program fragment creates a pair of connected sockets then
 * forks and communicates over them. Socket pairs have a two-way
 * communication path. Messages can be sent in both directions.
 */
```

```

#include <stdio.h>
#include <sys/socket.h>
#include <sys/types.h>
#define DATA1 "In Xanadu, did Kublai Khan..."
#define DATA2 "A stately pleasure dome decree..."

main()
{
    int sockets[2], child;
    char buf[1024];
    if (socketpair(AF_UNIX, SOCK_STREAM, 0, sockets) < 0) {
        perror("opening stream socket pair");
        exit(1);
    }
    if ((child = fork()) == -1)
        perror("fork");
    else if (child) { /* This is the parent. */
        close(sockets[0]);
        if (read(sockets[1], buf, 1024, 0) < 0)
            perror("reading stream message");
        printf("-->%s\n", buf);
        if (write(sockets[1], DATA2, sizeof(DATA2)) < 0)
            perror("writing stream message");
        close(sockets[1]);
    } else { /* This is the child. */
        close(sockets[1]);
        if (write(sockets[0], DATA1, sizeof(DATA1)) < 0)
            perror("writing stream message");
        if (read(sockets[0], buf, 1024, 0) < 0)
            perror("reading stream message");
        printf("-->%s\n", buf);
        close(sockets[0]);
    }
}

```

Reading Internet Datagrams Example Program

```

/*
 * This program creates a datagram socket, binds a name to it, and
 * then reads from the socket.
 */
#include <sys/types.h>
#include <sys/socket.h>
#include <netinet/in.h>
#include <stdio.h>
main()
{
    int sock, length;
    struct sockaddr_in name;
    char buf[1024];
    /* Create a socket from which to read. */
    sock = socket(AF_INET, SOCK_DGRAM, 0);
    if (sock < 0) {
        perror("opening datagram socket");
        exit(1);
    }
    /* Create name with wildcards. */
    name.sin_family = AF_INET;
    name.sin_addr.s_addr = INADDR_ANY;
    name.sin_port = 0;

```

```

if (bind(sock, (struct sockaddr *)&name, sizeof(name))) {
    perror("binding datagram socket");
    exit(1);
}

/* Find assigned port value and print it out. */
length = sizeof(name);
if (getsockname(sock, (struct sockaddr *)&name, &length)) {
    perror("getting socket name");
    exit(1);
}

printf("Socket has port #d\n", ntohs(name.sin_port));
/* Read from the socket. */
if (read(sock, buf, 1024) < 0)
    perror("receiving datagram packet");
printf("-->%s\n", buf);
close(sock);
}

/*
 * recvfrom() can also be used in place of the read.  recvfrom()
 * provides an extra field for setting flags.
 */

```

More explanation is available in “Socket Data Transfer” on page 210.

Sending Internet Datagrams Example Program

```

/*
 * This program fragment sends a datagram to a receiver whose
 * name is retrieved from the command line arguments.  The form
 * of the command line is dgramsend hostname portnumber.
 */
#include <sys/types.h>
#include <sys/socket.h>
#include <netinet/in.h>
#include <netdb.h>
#include <stdio.h>
#define DATA "The sea is calm tonight, the tide is full..."
main(argc, argv)
    int argc;
    char *argv[];
{
    int sock;
    struct sockaddr_in name;
    struct hostent *hp, *gethostbyname();
    /* Create a socket on which to send. */
    sock = socket(AF_INET, SOCK_DGRAM, 0);
    if (sock < 0) {
        perror("opening datagram socket");
        exit(1);
    }

    /*
     * Construct name, with no wildcards, of the socket to send to.
     * gethostbyname() returns a structure including the network
     * address of the specified host.  The port number is taken
     * from the command line.
     */
    hp = gethostbyname(argv[1]);
    if (hp == 0) {
        fprintf(stderr, "%s: unknown host", argv[1]);
        exit(2);
    }
}

```



```

bcopy(hp->h_addr, &name.sin_addr, hp->h_length);
name.sin_family = AF_INET;
name.sin_len = sizeof(name);
name.sin_port = htons(atoi(argv[2]));
/* Send message. */
if (sendto(sock, DATA, sizeof(DATA), 0,
    (struct sockaddr *)&name,
    sizeof(name)) < 0)
    perror("sending datagram message");
close(sock);
}

```

Reading UNIX Datagrams Example Program

```

#include <sys/types.h>
#include <sys/socket.h>
#include <sys/un.h>
#include <stdio.h>
#define NAME "socket"
/*
 * This program creates a UNIX domain datagram socket, binds a
 * name to it, then reads from the socket.
 */
main()
{
    int sock, length;
    struct sockaddr_un name;
    char buf[1024];
    /* Create socket from which to read. */
    sock = socket(AF_UNIX, SOCK_DGRAM, 0);
    if (sock < 0) {
        perror("opening datagram socket");
        exit(1);
    }

    /* Create name. */
    name.sun_family = AF_UNIX;
    strcpy(name.sun_path, NAME);
    name.sun_len = strlen(name.sun_path);
    if (bind(sock, (struct sockaddr *)&name, SUN_LEN(&name))) {
        perror("binding name to datagram socket");
        exit(1);
    }

    printf("socket -->%s\n", NAME);
    /* Read from the socket. */
    if (read(sock, buf, 1024) < 0)
        perror("receiving datagram packet");
    printf("-->%s\n", buf);
    close(sock);
    unlink(NAME);
}

```

Sending UNIX Datagrams Example Program

```

/*
 * This program fragment sends a datagram to a receiver whose
 * name is retrieved from the command line arguments. The form
 * of the command line is udgramsend pathname.
 */
#include <sys/types.h>
#include <sys/socket.h>
#include <sys/un.h>
#include <stdio.h>
#define DATA "The sea is calm tonight, the tide is full..."

```

```

main(argc, argv)
    int argc;
    char *argv[];
{
    int sock;
    struct sockaddr_un name;
    /* Create socket on which to send. */
    sock = socket(AF_UNIX, SOCK_DGRAM, 0);
    if (sock < 0) {
        perror("opening datagram socket");
        exit(1);
    }
    /* Construct name of socket to send to. */
    name.sun_family = AF_UNIX;
    strcpy(name.sun_path, argv[1]);
    name.sun_len = strlen(name.sun_path);

    /* Send message. */
    if (sendto(sock, DATA, sizeof(DATA), 0, (struct sockaddr *)&name,
        sizeof(struct sockaddr_un) < 0) {
        perror("sending datagram message");
    }
    close(sock);
}

```

Initiating Internet Stream Connections Example Program

```

/*
 * This program creates a socket and initiates a connection with
 * the socket given in the command line. One message is sent over
 * the connection and then the socket is closed, ending the
 * connection. The form of the command line is streamwrite
 * hostname portnumber.
 */
#include <sys/types.h>
#include <sys/socket.h>
#include <netinet/in.h>
#include <netdb.h>
#include <stdio.h>
#define DATA "Half a league, half a league..."
main(argc, argv)
    int argc;
    char *argv[];
{
    int sock;
    struct sockaddr_in server;
    struct hostent *hp, *gethostbyname();
    char buf[1024];

    /* Create socket. */
    sock = socket(AF_INET, SOCK_STREAM, 0);
    if (sock < 0) {
        perror("opening stream socket");
        exit(1);
    }
    /* Connect socket using name specified by command line. */
    server.sin_family = AF_INET;
    server.sin_len = sizeof(server);
    hp = gethostbyname(argv[1]);
    if (hp == 0) {
        fprintf(stderr, "%s: unknown host", argv[1]);
        exit(2);
    }
    bcopy(hp->h_addr, &server.sin_addr, hp->h_length);
    server.sin_port = htons(atoi(argv[2]));
}

```

```

    if (connect(sock, (struct sockaddr *)&server, sizeof(server)) < 0) {
        perror("connecting stream socket");
        exit(1);
    }
    if (write(sock, DATA, sizeof(DATA)) < 0)
        perror("writing on stream socket");
    close(sock);
}

```

Accepting Internet Stream Connections Example Program

```

/*
 * This program creates a socket and begins an infinite loop.
 * Each time through the loop it accepts a connection and prints
 * out messages from it. When the connection breaks, or a
 * termination message comes through, the program accepts a new
 * connection.
 */
#include <sys/types.h>
#include <sys/socket.h>
#include <netinet/in.h>
#include <netdb.h>
#include <stdio.h>
#define TRUE 1
main()
{
    int sock, length;
    struct sockaddr_in server;
    int msgsock;
    char buf[1024];
    int rval;
    int i;
    /* Create socket. */
    sock = socket(AF_INET, SOCK_STREAM, 0);
    if (sock < 0) {
        perror("opening stream socket");
        exit(1);
    }
    /* Name socket using wildcards. */
    server.sin_family = AF_INET;
    server.sin_len = sizeof(server);
    server.sin_addr.s_addr = INADDR_ANY;
    server.sin_port = 0;
    if (bind(sock, (struct sockaddr *)&server, sizeof(server))) {
        perror("binding stream socket");
        exit(1);
    }
    /* Find out assigned port number and print it out. */
    length = sizeof(server);
    if (getsockname(sock, (struct sockaddr *)&server, &length)) {
        perror("getting socket name");
        exit(1);
    }
    printf("Socket has port %#d\n", ntohs(server.sin_port));
    /* Start accepting connection. */
    listen(sock, 5);
    do {
        msgsock = accept(sock, 0, 0);
        if (msgsock == -1) perror("accept");
        else do {
            bzero(buf, sizeof(buf));
            if ((rval = read(msgsock, buf, 1024)) < 0)
                perror("reading stream message");
            i = 0;
            if (rval == 0)
                printf("Ending connection\n");
        }
    }
}

```

```

        else
            printf("-->%s\n", buf);
    } while (rval != 0);
    close(msgsock);
} while (TRUE);
/*
 * Since this program has an infinite loop, the socket "sock"
 * is never explicitly closed. However, all sockets will be
 * closed automatically when a process is killed or terminates
 * normally.
 */
}

```

Checking for Pending Connections Example Program

This program must be compiled with the **-D_BSD** and **-lbsd** options. For example, use the **cc prog.c -o prog -D_BSD -lbsd** command.

```

/*
 * This program uses select() to check that someone is trying to
 * connect before calling accept().
 */
#include <sys/select.h>
#include <sys/types.h>
#include <sys/socket.h>
#include <sys/time.h>
#include <netinet/in.h>
#include <netdb.h>
#include <stdio.h>
#define TRUE 1
main()
{
    int sock, length;
    struct sockaddr_in server;
    int msgsock;
    char buf[1024];
    int rval;
    fd_set ready;
    struct timeval to;
    /* Create socket. */
    sock = socket(AF_INET, SOCK_STREAM, 0);
    if (sock < 0) {
        perror("opening stream socket");
        exit(1);
    }
    /* Name socket using wildcards. */
    server.sin_family = AF_INET;
    server.sin_len = sizeof(server);
    server.sin_addr.s_addr = INADDR_ANY;
    server.sin_port = 0;
    if (bind(sock, &server, sizeof(server))) {
        perror("binding stream socket");
        exit(1);
    }

    /* Find out assigned port number and print it out. */
    length = sizeof(server);
    if (getsockname(sock, &server, &length)) {
        perror("getting socket name");
        exit(1);
    }
    printf("Socket has port %#d\n", ntohs(server.sin_port));
}

```

```

/* Start accepting connections. */
listen(sock, 5);
do {
    FD_ZERO(&ready);
    FD_SET(sock, &ready);
    to.tv_sec = 5;
    to.tv_usec = 0;
    if (select(sock + 1, &ready, 0, 0, &to) < 0) {
        perror("select");
        continue;
    }
}

/*
 * When a select is done on a file descriptor of a socket
 * waiting to do an accept on the connection, a select
 * can be performed on the new descriptor to insure availability
 * of the data.
 *
 * In this example, after accept returns, a read is done, but
 * it would now be possible to select on the returned socket
 * descriptor to see if data is available.
 */
if (FD_ISSET(sock, &ready)) {
    msgsock = accept(sock, (struct sockaddr *)0, (int *)0);
    if (msgsock == -1)
        perror("accept");
    else do {
        bzero(buf, sizeof(buf));
        if ((rval = read(msgsock, buf, 1024)) < 0)
            perror("reading stream message");
        else if (rval == 0)
            printf("Ending connection\n");
        else
            printf("-->%s\n", buf);
    } while (rval > 0);
    close(msgsock);
} else
    printf("Do something else\n");
} while (TRUE);
}

```

Initiating UNIX Stream Connections Example Program

```

/*
 * This program connects to the socket named in the command line
 * and sends a one line message to that socket. The form of the
 * command line is ustreamwrite pathname.
 */
#include <sys/types.h>
#include <sys/socket.h>
#include <sys/un.h>
#include <stdio.h>
#define DATA "Half a league, half a league..."
main(argc, argv)
    int argc;
    char *argv[];
{
    int sock;
    struct sockaddr_un server;
    char buf[1024];
    /* Create socket. */
    sock = socket(AF_UNIX, SOCK_STREAM, 0);
    if (sock < 0) {
        perror("opening stream socket");
        exit(1);
    }
}

```

```

/* Connect socket using name specified by command line. */
server.sun_family = AF_UNIX;
strcpy(server.sun_path, argv[1]);
server.sun_len = strlen(server.sun_path);
if (connect(sock, (struct sockaddr *)&server,
    sizeof(struct sockaddr_un)) < 0) {
    close(sock);
    perror("connecting stream socket");
    exit(1);
}
if (write(sock, DATA, sizeof(DATA)) < 0)
    perror("writing on stream socket");
}

```

Accepting UNIX Stream Connections Example Program

```

/*
 * This program creates a socket in the UNIX domain and binds a
 * name to it. After printing the socket's name, a loop begins.
 * Each time through the loop it accepts a connection and prints
 * out messages from it. When the connection breaks, or a
 * termination message comes through, the program accepts a new
 * connection.
 */
#include <sys/types.h>
#include <sys/socket.h>
#include <sys/un.h>
#include <stdio.h>
#define NAME "socket"
main()
{
    int sock, msgsock, rval;
    struct sockaddr_un server;
    char buf[1024];
    /* Create socket. */
    sock = socket(AF_UNIX, SOCK_STREAM, 0);
    if (sock < 0) {
        perror("opening stream socket");
        exit(1);
    }
    /* Name socket using file system name. */
    server.sun_family = AF_UNIX;
    strcpy(server.sun_path, NAME);
    server.sun_len = strlen(server.sun_path);
    if (bind(sock, (struct sockaddr *)&server, SUN_LEN(&server))) {
        perror("binding stream socket");
        exit(1);
    }

    printf("Socket has name %s\n", server.sun_path);
    /* Start accepting connections. */
    listen(sock, 5);
    for (;;) {
        msgsock = accept(sock, 0, 0); if (msgsock == -1) perror("accept");
        else do {
            bzero(buf, sizeof(buf));
            if ((rval = read(msgsock, buf, 1024)) < 0)
                perror("reading stream message");
            else if (rval == 0)
                printf("Ending connection\n");
            else
                printf("-->%s\n", buf);
        } while (rval > 0);
        close(msgsock);
    }
}

```

```

/* The following statements are not executed, because they
 * follow an infinite loop. However, most ordinary programs
 * will not run forever. In the UNIX domain it is necessary to
 * tell the file system that you are through using NAME. In
 * most programs you use the call unlink() as below. Since
 * the user will have to kill this program, it will be
 * necessary to remove the name with a shell command.
 */
close(sock);
unlink(NAME);
}

```

Sending Data on an ATM Socket PVC Client Example Program

This program must be compiled with the **-D_BSD** and **-lbsd** options. For example, use the **cc prog.c -o prog -D_BSD -lbsd** command.

```

/*
 *
 * ATM Sockets PVC Client Example
 *
 * This program opens a PVC and sends data on it.
 *
 */
#include <stdio.h>
#include <stddef.h>
#include <stdlib.h>
#include <errno.h>
#include <sys/socket.h>
#include <sys/ioctl.h>
#include <sys/ndd_var.h>
#include <sys/atmsock.h>
#define BUFF_SIZE 8192
char buff[BUFF_SIZE];
main(argc, argv)
    int argc;
    char *argv[];
{
    int          s;          // Socket file descriptor
    int          error;     // Function return code
    sockaddr_ndd_atm_t  addr; // ATM Socket Address

    // Create a socket in the AF_NDD domain of type SOCK_CONN_DGRAM
    // and NDD_PROT_ATM protocol.
    s = socket(AF_NDD, SOCK_CONN_DGRAM, NDD_PROT_ATM);
    if (s == -1) {          // Socket either returns the file descriptor
        perror("socket"); // or a -1 to indicate an error.
        exit(-1);
    }
    // The bind command associates this socket with a particular
    // ATM device, as specified by addr.sndd_atm_nddname.
    addr.sndd_atm_len = sizeof(addr);
    addr.sndd_atm_family = AF_NDD;
    strcpy( addr.sndd_atm_nddname, "atm0" ); // The name of the ATM device
                                           // which is to be used.
    error = bind( s, (struct sockaddr *)&addr, sizeof(addr) );
    if (error) {          // An error from bind would indicate the
        perror("bind");  // requested ATM device is not available.
        exit(-1);        // Check smitty devices.
    } /* endif */

    // To open a PVC, the addr.sndd_atm_vc_type field of the
    // sockaddr_ndd_atm is set to CONN_PVC. The VPI and VCI are
    // specified in the fields sndd_atm_addr.number.addr[0] and
    // sndd_atm_addr.number.addr[1].

```

```

addr.sndd_atm_vc_type = CONN_PVC;          // Indicates PVC
addr.sndd_atm_addr.number.addr[0] = 0;    // VPI
addr.sndd_atm_addr.number.addr[1] = 15;   // VCI
error = connect( s, (struct sockaddr *)&addr, sizeof(addr) );
if (error) {                               // A connect error may indicate that
    perror("connect"); // the VPI/VCI is already in use.
    exit(-1);
} /* endif */
while (1) {
    error = send( s, buff, BUFF_SIZE, 0 );
    if (error < 0 ) {                       // Send returns -1 to
        perror("send");                     // to indicate an error.
        exit(-1);                           // The errno is set and can
    } else {                                // be displayed with perror.
        printf("sent %d bytes\n", error); // Or it returns the number
    }                                       // of bytes transmitted
    sleep(1); // Just sleep 1 second, then send more data.
} /* endwhile */
exit(0);
}

```

Receiving Data on an ATM Socket PVC Server Example Program

This program must be compiled with the **-D_BSD** and **-lbsd** options. For example, use the **cc prog.c -o prog -D_BSD -lbsd** command.

```

/*
 * ATM Sockets PVC Server Example
 *
 * This program opens a PVC and receives data on it.
 *
 */
#include <stdio.h>
#include <stddef.h>
#include <stdlib.h>
#include <errno.h>
#include <sys/socket.h>
#include <sys/ioctl.h>
#include <sys/ndd_var.h>
#include <sys/atmsock.h>
#define BUFF_SIZE 8192
char buff[BUFF_SIZE];
main(argc, argv)
    int argc;
    char *argv[];
{
    int s; // Socket file descriptor
    int error; // Function return code
    sockaddr_ndd_atm_t addr; // ATM Socket Address
    // Create a socket in the AF_NDD domain of type SOCK_CONN_DGRAM
    // and NDD_PROT_ATM protocol.
    s = socket(AF_NDD, SOCK_CONN_DGRAM, NDD_PROT_ATM);
    if (s == -1) { // Socket either returns the file descriptor
        perror("socket"); // or a -1 to indicate an error.
        exit(-1);
    }
    // The bind command associates this socket with a particular
    // ATM device, as specified by addr.sndd_atm_nddname.
    addr.sndd_atm_len = sizeof(addr);
    addr.sndd_atm_family = AF_NDD;
    strcpy( addr.sndd_atm_nddname, "atm0" ); // The name of the ATM device
    // which is to be used.
    error = bind( s, (struct sockaddr *)&addr, sizeof(addr) );
    if (error) { // An error from bind would indicate the
        perror("bind"); // requested ATM device is not available.
        exit(-1); // Check smitty devices.
    } /* endif */
}

```



```

// To open a PVC, the addr.sndd_atm_vc_type field of the
// sockaddr_ndd_atm is set to CONN_PVC. The VPI and VCI are
// specified in the fields sndd_atm_addr.number.addr[0] and
// sndd_atm_addr.number.addr[1].
addr.sndd_atm_vc_type = CONN_PVC;           // Indicates PVC
addr.sndd_atm_addr.number.addr[0] = 0;     // VPI
addr.sndd_atm_addr.number.addr[1] = 15;    // VCI
error = connect( s, (struct sockaddr *)&addr, sizeof(addr) );
if (error) {                               // A connect error may indicate that
    perror("connect"); // the VPI/VCI is already in use.
    exit(-1);
} /* endif */
while (1) {
    error = recv( s, buff, BUFF_SIZE, 0 );
    if (error < 0 ) {                       // Send returns -1 to
        perror("recv");                    // to indicate an error.
        exit(-1);                          // The errno is set and can
    } else {                                // be displayed with perror.
        printf("received %d bytes\n", error ); // Or it returns the number
    }                                       // of bytes received
} /* endwhile */
exit(0);
}

```

Sending Data on an ATM Socket Rate-Enforced SVC Client Example Program

This program must be compiled with the **-D_BSD** and **-lbsd** options. For example, use the **cc prog.c -o prog -D_BSD -lbsd** command.

```

/*
 * ATM Sockets rate enforced SVC Client Example
 *
 * This program opens a rate enforced (not best effort) SVC
 * and sends data on it.
 */
#include <stdio.h>
#include <stddef.h>
#include <stdlib.h>
#include <errno.h>
#include <sys/socket.h>
#include <sys/ioctl.h>
#include <sys/ndd_var.h>
#include <sys/atmsock.h>
#define BUFF_SIZE 100000
char buff[BUFF_SIZE];
main(argc, argv)
    int argc;
    char *argv[];
{
    int s; // Socket file descriptor
    int error; // Function return code
    int i;
    sockaddr_ndd_atm_t addr; // ATM Socket Address
    unsigned long size; // Size of socket argument
    aal_parm_t aal_parm; // AAL parameters
    blli_t blli[3]; // Broadband Lower Layer Info
    traffic_des_t traffic; // Traffic Descriptor
    bearer_t bearer; // Broadband Bearer Capability
    int o[20]; // Temporary variable for ATM
                // address
    cause_t cause; // Cause of failure
    unsigned char max_pend; // Maximum outstanding transmits
    // Create a socket in the AF_NDD domain of type SOCK_CONN_DGRAM
    // and NDD_PROT_ATM protocol.

```

```

s = socket(AF_NDD, SOCK_CONN_DGRAM, NDD_PROT_ATM);
if (s == -1) {
    perror("socket");
    exit(-1);
}
addr.sndd_atm_len = sizeof(addr);
addr.sndd_atm_family = AF_NDD;
strcpy( addr.sndd_atm_nddname, "atm0" );
// The bind command associates this socket with a particular
// ATM device, as specified by addr.sndd_atm_nddname.
error = bind( s, (struct sockaddr *)&addr, sizeof(addr) );
if (error) { // An error from bind would indicate the
    perror("bind"); // requested ATM device is not available.
    exit(-1); // Check smitty devices.
} /* endif */
// Set the AAL parameters.
// See the ATM UNI 3.0 for valid combinations.
// For a rate enforced connection the adapter will segment
// according to the fwd_max_sdu_size field. This means that
// although the client sends 100000 bytes at once, the server
// will receive them in packets the size of fwd_max_sdu_size.
bzero( aal_parm, sizeof(aal_parm_t) );
aal_parm.length = sizeof(aal_5_t);
aal_parm.aal_type = CM_AAL_5;
aal_parm.aal_info.aal5.fwd_max_sdu_size = 7708;
aal_parm.aal_info.aal5.bak_max_sdu_size = 7520;
aal_parm.aal_info.aal5.mode = CM_MESSAGE_MODE;
aal_parm.aal_info.aal5.sscs_type = CM_NULL_SSCS;
error = setsockopt( s, 0, SO_ATM_AAL_PARM, (void *)&aal_parm,
    sizeof(aal_parm_t) );

if (error) {
    perror("setsockopt SO_AAL_PARM");
    exit(-1);
} /* endif */
// Up to three BLLI may be specified in the setup message.
// If a BLLI contains valid information, its length must be
// set to sizeof(blli_t). Otherwise set its length to 0.
// In this example the application specifies two BLLIs.
// After the connection has been established, the application
// can use getsockopt to see which BLLI was accepted by the
// called station.
bzero(blli, sizeof(blli_t) );
blli[0].length = sizeof(blli_t);
blli[1].length = sizeof(blli_t);
blli[2].length = 0;
blli[0].L2_prot = CM_L2_PROT_USER;
blli[0].L2_info = 1;
// Fields that are not used must be set to NOT_SPECIFIED_B (byte)
blli[0].L2_mode = NOT_SPECIFIED_B;
blli[0].L2_win_size = NOT_SPECIFIED_B;
blli[0].L3_prot = NOT_SPECIFIED_B;
blli[0].L3_mode = NOT_SPECIFIED_B;
blli[0].L3_def_pkt_size = NOT_SPECIFIED_B;
blli[0].L3_pkt_win_size = NOT_SPECIFIED_B;
blli[0].L3_info = NOT_SPECIFIED_B;
blli[0].ipi = NOT_SPECIFIED_B;
blli[0].snap_oui[0] = NOT_SPECIFIED_B;
blli[0].snap_oui[1] = NOT_SPECIFIED_B;
blli[0].snap_oui[2] = NOT_SPECIFIED_B;
blli[0].snap_pid[0] = NOT_SPECIFIED_B;
blli[0].snap_pid[1] = NOT_SPECIFIED_B;
// Up to three blli may be specified in the setup message.
// The caller must query the blli with getsockopt to see which
// blli the other side accepted.
blli[1].L2_prot = CM_L2_PROT_USER;
blli[1].L2_info = 2;
// Fields that are not used must be set to NOT_SPECIFIED_B (byte)

```

```

blli[1].L2_mode = NOT_SPECIFIED_B;
blli[1].L2_win_size = NOT_SPECIFIED_B;
blli[1].L3_prot = NOT_SPECIFIED_B;
blli[1].L3_mode = NOT_SPECIFIED_B;
blli[1].L3_def_pkt_size = NOT_SPECIFIED_B;
blli[1].L3_pkt_win_size = NOT_SPECIFIED_B;
blli[1].L3_info = NOT_SPECIFIED_B;
blli[1].ipi = NOT_SPECIFIED_B;
blli[1].snap_oui[0] = NOT_SPECIFIED_B;
blli[1].snap_oui[1] = NOT_SPECIFIED_B;
blli[1].snap_oui[2] = NOT_SPECIFIED_B;
blli[1].snap_pid[0] = NOT_SPECIFIED_B;
blli[1].snap_pid[1] = NOT_SPECIFIED_B;
error = setsockopt( s, 0, SO_ATM_BLLI, (void *)&blli,
                  sizeof(blli) );

if (error) {
    perror("setsockopt SO_ATM_BLLI");
    exit(-1);
} /* endif */
// See ATM UNI 3.0 Appendix xx for details of valid combinations
// Here you specify a rate enforced 1 Mbps connection.
traffic.best_effort = FALSE; // Specifies Rate enforcement
traffic.fwd_peakrate_lp = 1000; // Kbps
traffic.bak_peakrate_lp = 1000; // Kbps
traffic.tagging_bak = FALSE;
traffic.tagging_fwd = FALSE;
// Fields that are not used must be set to NOT_SPECIFIED_L (long)
traffic.fwd_peakrate_hp = NOT_SPECIFIED_L;
traffic.bak_peakrate_hp = NOT_SPECIFIED_L;
traffic.fwd_sus_rate_hp = NOT_SPECIFIED_L;
traffic.bak_sus_rate_hp = NOT_SPECIFIED_L;
traffic.fwd_sus_rate_lp = NOT_SPECIFIED_L;
traffic.bak_sus_rate_lp = NOT_SPECIFIED_L;
traffic.fwd_bur_size_hp = NOT_SPECIFIED_L;
traffic.bak_bur_size_hp = NOT_SPECIFIED_L;
traffic.fwd_bur_size_lp = NOT_SPECIFIED_L;
traffic.bak_bur_size_lp = NOT_SPECIFIED_L;
error = setsockopt( s, 0, SO_ATM_TRAFFIC_DES, (void *)&traffic,
                  sizeof(traffic_des_t) );

if (error) {
    perror("set traffic");
    exit(-1);
} /* endif */
// Set the Broadband Bearer Capability
// See the UNI 3.0 for valid combinations
bearer.bearer_class = CM_CLASS_C;
bearer.traffic_type = NOT_SPECIFIED_B;
bearer.timing = NOT_SPECIFIED_B;
bearer.clipping = CM_NOT_SUSCEPTIBLE;
bearer.connection_cfg = CM_CON_CFG_PTP;
error = setsockopt( s, 0, SO_ATM_BEARER, (void *)&bearer,
                  sizeof(bearer_t) );

if (error) {
    perror("set bearer");
    exit(-1);
} /* endif */
printf("Input ATM address to be called:\n");
i = scanf("%x.%x.%x.%x.%x.%x.%x.%x.%x.%x.%x.%x.%x.%x.%x.%x",
         &o[0], &o[1], &o[2], &o[3], &o[4],
         &o[5], &o[6], &o[7], &o[8], &o[9],
         &o[10], &o[11], &o[12], &o[13], &o[14],
         &o[15], &o[16], &o[17], &o[18], &o[19] );

if (i != 20) {
    printf("invalid atm address\n");
    exit(-1);
}
for (i=0; i<20; i++) {

```

```

    addr.sndd_atm_addr.number.addr[i] = o[i];
} /* endfor */
addr.sndd_atm_addr.length = ATM_ADDR_LEN;
addr.sndd_atm_addr.type = CM_INTL_ADDR_TYPE;
addr.sndd_atm_addr.plan_id = CM_NSAP;
addr.sndd_atm_addr.pres_ind = NOT_SPECIFIED_B;
addr.sndd_atm_addr.screening = NOT_SPECIFIED_B;
addr.sndd_atm_vc_type = CONN_SVC;
error = connect( s, (struct sockaddr *)&addr, sizeof(addr) );
if (error) {
    perror("connect");
    // If a connect fails, the cause structure may contain useful
    // information for determining the reason of the failure.
    // See the ATM UNI 3.0 for a description of the cause values.
    size = sizeof(cause_t);
    error = getsockopt(s, 0, SO_ATM_CAUSE, (void *)&cause, &size);
    if (error) {
        perror("SO_ATM_CAUSE");
    } else {
        printf("cause = %d\n", cause.cause );
    } /* endif */
    exit(-1);
} /* endif */
// The caller can now check to see which BLLI was accepted by
// the called station.
size = sizeof(blli_t);
error = getsockopt(s, 0, SO_ATM_BLLI,
                  (void *)&blli, &size);
if (error) {
    perror("get blli");
    exit(0);
} /* endif */
printf("The call was accepted by L2_info %d\n", blli[0].L2_info );
size = sizeof(aal_parm_t);
error = getsockopt(s, 0, SO_ATM_AAL_PARM,
                  (void *)&aal_parm, &size);
// If any of these negotiated parameters is unacceptable to
// the caller, he should disconnect the call by closing the socket.
printf("fwd      %d\n",
       aal_parm.aal_info.aal5.fwd_max_sdu_size );
printf("bak      %d\n",
       aal_parm.aal_info.aal5.bak_max_sdu_size );
// Specifies how many outstanding transmits are allowed before
// the adapter device driver will return an error. The error
// informs the application that it must wait before trying to
// transmit again.
max_pend = 2;
error = setsockopt( s, 0, SO_ATM_MAX_PEND, (void *)&max_pend, 1 );
if (error) {
    perror("set MAX_PENDING");
    exit(-1);
} /* endif */
while (1) {
    error = send( s, buff, BUFF_SIZE, 0 );
    if (error == -1) {
        if (errno == ENOSPC) {
            // The application has reached the maximum outstanding
            // transmits. It must wait before trying again.
            perror("send");
            sleep(1);
        } else {
            perror("send");
            size = sizeof(cause_t);
            error = getsockopt(s, 0, SO_ATM_CAUSE, (void *)&cause, &size);
            if (error) {
                perror("SO_ATM_CAUSE");
            } else {

```

```

        printf("cause = %d\n", cause.cause );
    }
    exit(-1);
} /* endif */
} else {
    printf("sent %d\n", error );
}
}
}
}

```

Receiving Data on an ATM Socket Rate-Enforced SVC Server Example Program

This program must be compiled with the **-D_BSD** and **-lbsd** options. For example, use the **cc prog.c -o prog -D_BSD -lbsd** command.

```

/*
 * ATM Sockets rate enforced SVC Server Example
 *
 * This program listens for and accepts an SVC and receives data on it.
 * It also demonstrates AAL negotiation.
 *
 */
#include <stdio.h>
#include <stddef.h>
#include <stdlib.h>
#include <errno.h>
#include <sys/socket.h>
#include <sys/ioctl.h>
#include <sys/ndd_var.h>
#include <sys/atmsock.h>
#define BUFF_SIZE      8192
char buff[BUFF_SIZE];
main(argc, argv)
    int argc;
    char *argv[];
{
    int          s;          // Socket file descriptor
    int          new_s;     // Socket returned by accept
    int          error;     // Function return code
    int          i;
    sockaddr_ndd_atm_t addr; // ATM Socket Address
    unsigned long size;    // Size of socket argument
    aal_parm_t  aal_parm;  // AAL parameters
    blli_t      blli[3];   // Broadband Lower Layer Info
    traffic_des_t traffic;  // Traffic Descriptor
    bearer_t    bearer;    // Broadband Bearer Capability
    cause_t     cause;     // Cause of failure
    unsigned char max_pend;
    indaccept_ie_t indaccept;
    // Create a socket in the AF_NDD domain of type SOCK_CONN_DGRAM
    // and NDD_PROT_ATM protocol.
    s = socket(AF_NDD, SOCK_CONN_DGRAM, NDD_PROT_ATM);
    if (s == -1) {
        perror("socket");
        exit(-1);
    }
    addr.sndd_atm_len = sizeof(addr);
    addr.sndd_atm_family = AF_NDD;
    strcpy( addr.sndd_atm_nddname, "atm0" ); // The name of the ATM device
                                           // which is to be used.
    // The bind command associates this socket with a particular
    // ATM device, as specified by addr.sndd_atm_nddname.
    error = bind( s, (struct sockaddr *)&addr, sizeof(addr) );
    if (error) {
        perror("bind");
    }
}

```

```

    exit(-1);
} /* endif */
// Although up to 3 BLLIs may be specified by the calling side,
// the listening side may only specify one.
bzero(blli, sizeof(blli_t) );
blli[0].length = sizeof(blli_t);
blli[1].length = 0;
blli[2].length = 0;
// If a call arrives that matches these two parameters, it will
// be given to this application.
blli[0].L2_prot = CM_L2_PROT_USER;
blli[0].L2_info = 2;
// Fields that are not used must be set to NOT_SPECIFIED_B (byte)
blli[0].L2_mode = NOT_SPECIFIED_B;
blli[0].L2_win_size = NOT_SPECIFIED_B;
blli[0].L3_prot = NOT_SPECIFIED_B;
blli[0].L3_mode = NOT_SPECIFIED_B;
blli[0].L3_def_pkt_size = NOT_SPECIFIED_B;
blli[0].L3_pkt_win_size = NOT_SPECIFIED_B;
blli[0].L3_info = NOT_SPECIFIED_B;
blli[0].ipi = NOT_SPECIFIED_B;
blli[0].snap_oui[0] = NOT_SPECIFIED_B;
blli[0].snap_oui[1] = NOT_SPECIFIED_B;
blli[0].snap_oui[2] = NOT_SPECIFIED_B;
blli[0].snap_pid[0] = NOT_SPECIFIED_B;
blli[0].snap_pid[1] = NOT_SPECIFIED_B;
error = setsockopt( s, 0, SO_ATM_BLLI, (void *)&blli,
                  sizeof(blli) );

if (error) {
    perror("setsockopt SO_ATM_BLLI");
    exit(-1);
} /* endif */
// Query and print out the ATM address of this station. The
// client application will need it.
bzero( &addr, sizeof(addr));
size = sizeof(addr);
error = getsockname( s, (struct sockaddr *)&addr, &size );
if (error) {
    printf("getsock error = %d errno = %d\n", error, errno );
    exit(-1);
} /* endif */
printf("My ATM address: ");
for (i=0; i<20; i++) {
    printf("%X.", addr.sndd_atm_addr.number.addr[i]);
} /* endfor */
printf("\n");
// The listen call enables this socket to receive incoming call
// that match its BLLI.
error = listen( s, 10 );
if (error) {
    // Listen will fail if the station is not connected to
    // an ATM switch.
    perror("listen");
    exit(-1);
} /* endif */
size = sizeof(addr);
printf("accepting\n");
// The accept will return a new socket of an incoming call
// for this socket, or sleep until one arrives.
new_s = accept( s, (struct sockaddr *)&addr, &size );
if (new_s == -1) {
    printf("accept error = %d errno = %d\n", new_s, errno );
    exit(-1);
} /* endif */
// Query the AAL parameters before fully establishing the
// connection. See the ATM UNI 3.0 for a description of
// which parameters may be negotiated.

```

```

size = sizeof(aal_parm_t);
error = getsockopt( new_s, 0, SO_ATM_AAL_PARM,
                   (void *)&aal_parm, &size );
indaccept.ia_aal_parm = aal_parm;
// Change the fwd_max_sdu_size down to 7520.
if (indaccept.ia_aal_parm.aal_info.aal5.fwd_max_sdu_size > 7520 ) {
    indaccept.ia_aal_parm.aal_info.aal5.fwd_max_sdu_size = 7520;
} /* endif */
size = sizeof(indaccept_ie_t);
error = setsockopt( new_s, 0, SO_ATM_ACCEPT,
                   (void *)&indaccept, size );

if (error) {
    perror("setsockopt ACCEPT");
    exit(-1);
} /* endif */
while (1) {
    error = recv( new_s, buff, BUFF_SIZE, 0 );
    if (error == -1) {
        // If a recv fails, the cause structure may contain useful
        // information for determining the reason of the failure.
        // The connection might have been closed by the other party,
        // or the physical network might have been disconnected.
        // See the ATM UNI 3.0 for a description of the cause values.
        // If the send failed for some other reason, the errno will
        // indicate this.
        perror("recv");
        size = sizeof(cause_t);
        error = getsockopt(new_s, 0, SO_ATM_CAUSE,
                           (void *)&cause, &size);

        if (error) {
            perror("SO_ATM_CAUSE");
        } else {
            printf("cause = %d\n", cause.cause );
        } /* endif */
        exit(0);
    } /* endif */
    printf("recv %d bytes\n", error);
}
}

```

Sending Data on an ATM Socket SVC Client Example Program

This program must be compiled with the **-D_BSD** and **-lbsd** options. For example, use the **cc prog.c -o prog -D_BSD -lbsd** command.

```

/*
 * ATM Sockets SVC Client Example
 *
 * This program opens a opens an best effort SVC and sends data on it.
 *
 */
#include <stdio.h>
#include <stddef.h>
#include <stdlib.h>
#include <errno.h>
#include <sys/socket.h>
#include <sys/ioctl.h>
#include <sys/ndd_var.h>
#include <sys/atmsock.h>
#define BUFF_SIZE 8192
char buff[BUFF_SIZE];
main(argc, argv)
    int argc;
    char *argv[];
{
    int s; // Socket file descriptor
    int error; // Function return code

```

```

int                i;
sockaddr_ndd_atm_t  addr;      // ATM Socket Address
unsigned long      size;      // Size of socket argument
aal_parm_t        aal_parm;   // AAL parameters
blli_t            blli[3];    // Broadband Lower Layer Info
traffic_des_t     traffic;    // Traffic Descriptor
bearer_t          bearer;     // Broadband Bearer Capability
int               o[20];      // Temporary variable for ATM
                                // address
cause_t           cause;     // Cause of failure
// Create a socket in the AF_NDD domain of type SOCK_CONN_DGRAM
// and NDD_PROT_ATM protocol.
s = socket(AF_NDD, SOCK_CONN_DGRAM, NDD_PROT_ATM);
if (s == -1) {                // Socket either returns the file descriptor
    perror("socket");        // or a -1 to indicate an error.
    exit(-1);
}
// The bind command associates this socket with a particular
// ATM device, as specified by addr.sndd_atm_nddname.
addr.sndd_atm_len = sizeof(addr);
addr.sndd_atm_family = AF_NDD;
strcpy( addr.sndd_atm_nddname, "atm0" ); // The name of the ATM device
                                        // which is to be used.
error = bind( s, (struct sockaddr *)&addr, sizeof(addr) );
if (error) {                    // An error from bind would indicate the
    perror("bind");            // requested ATM device is not available.
    exit(-1);                  // Check smitty devices.
} /* endif */
// Set the AAL parameters.
// See the ATM UNI 3.0 for valid combinations.
bzero( aal_parm, sizeof(aal_parm_t) );
aal_parm.length = sizeof(aal_5_t);
aal_parm.aal_type = CM_AAL_5;
aal_parm.aal_info.aal5.fwd_max_sdu_size = 9188;
aal_parm.aal_info.aal5.bak_max_sdu_size = 9188;
aal_parm.aal_info.aal5.mode = CM_MESSAGE_MODE;
aal_parm.aal_info.aal5.sscs_type = CM_NULL_SSCS;
error = setsockopt( s, 0, SO_ATM_AAL_PARM, (void *)&aal_parm,
    sizeof(aal_parm_t) );

if (error) {
    perror("setsockopt SO_AAL_PARM");
    exit(-1);
} /* endif */
// Up to three BLLI may be specified in the setup message.
// If a BLLI contains valid information, its length must be
// set to sizeof(blli_t). Otherwise set its length to 0.
bzero(blli, sizeof(blli_t) * 3);
blli[0].length = sizeof(blli_t); // Only use the first BLLI
blli[1].length = 0;
blli[2].length = 0;
// This call will be delivered to the application that is
// listening for calls that match these two parameters.
blli[0].L2_prot = CM_L2_PROT_USER;
blli[0].L2_info = 1;
// Fields that are not used must be set to NOT_SPECIFIED_B (byte)
blli[0].L2_mode = NOT_SPECIFIED_B;
blli[0].L2_win_size = NOT_SPECIFIED_B;
blli[0].L3_prot = NOT_SPECIFIED_B;
blli[0].L3_mode = NOT_SPECIFIED_B;
blli[0].L3_def_pkt_size = NOT_SPECIFIED_B;
blli[0].L3_pkt_win_size = NOT_SPECIFIED_B;
blli[0].L3_info = NOT_SPECIFIED_B;
blli[0].ipi = NOT_SPECIFIED_B;
blli[0].snap_oui[0] = NOT_SPECIFIED_B;
blli[0].snap_oui[1] = NOT_SPECIFIED_B;
blli[0].snap_oui[2] = NOT_SPECIFIED_B;
blli[0].snap_pid[0] = NOT_SPECIFIED_B;

```



```

blli[0].snap_pid[1] = NOT_SPECIFIED_B;
blli[1].length = 0; /* sizeof(blli_t); */
blli[2].length = 0;
error = setsockopt( s, 0, SO_ATM_BLLI, (void *)&blli,
                   sizeof(blli) );

if (error) {
    perror("setsockopt SO_ATM_BLLI");
    exit(-1);
} /* endif */
// Set the Traffic Descriptor
// See the ATM UNI 3.0 for valid settings.
bzero( traffic, sizeof(traffic_des_t) );
// Here we specify a 25 Mbps best effort connection. Best effort
// indicates that the adapter should not enforce the transmission
// rate. Note that the minimum rate will be depend on what
// best effort rate queues have bet configured for the ATM adapter.
// See SMIT for details.
traffic.best_effort = TRUE;           // No rate enforcement
traffic.fwd_peakrate_lp = 25000;     // Kbps
traffic.bak_peakrate_lp = 25000;     // Kbps
traffic.tagging_bak = FALSE;
traffic.tagging_fwd = FALSE;
// Fields that are not used must be set to NOT_SPECIFIED_L (long)
traffic.fwd_peakrate_hp = NOT_SPECIFIED_L;
traffic.bak_peakrate_hp = NOT_SPECIFIED_L;
traffic.fwd_sus_rate_hp = NOT_SPECIFIED_L;
traffic.bak_sus_rate_hp = NOT_SPECIFIED_L;
traffic.fwd_sus_rate_lp = NOT_SPECIFIED_L;
traffic.bak_sus_rate_lp = NOT_SPECIFIED_L;
traffic.fwd_bur_size_hp = NOT_SPECIFIED_L;
traffic.bak_bur_size_hp = NOT_SPECIFIED_L;
traffic.fwd_bur_size_lp = NOT_SPECIFIED_L;
traffic.bak_bur_size_lp = NOT_SPECIFIED_L;
error = setsockopt( s, 0, SO_ATM_TRAFFIC_DES, (void *)&traffic,
                   sizeof(traffic_des_t) );

if (error) {
    perror("set traffic");
    exit(-1);
} /* endif */
// Set the Broadband Bearer Capability
// See the UNI 3.0 for valid combinations
bearer.bearer_class = CM_CLASS_C;
bearer.traffic_type = NOT_SPECIFIED_B;
bearer.timing = NOT_SPECIFIED_B;
bearer.clipping = CM_NOT_SUSCEPTIBLE;
bearer.connection_cfg = CM_CON_CFG_PTP;
error = setsockopt( s, 0, SO_ATM_BEARER, (void *)&bearer,
                   sizeof(bearer_t) );

if (error) {
    perror("set bearer");
    exit(-1);
} /* endif */
printf("Input ATM address to be called:\n");
i = scanf( "%x.%x.%x.%x.%x.%x.%x.%x.%x.%x.%x.%x.%x.%x.%x.%x",
           &o[0], &o[1], &o[2], &o[3], &o[4],
           &o[5], &o[6], &o[7], &o[8], &o[9],
           &o[10], &o[11], &o[12], &o[13], &o[14],
           &o[15], &o[16], &o[17], &o[18], &o[19] );
if (i != 20) {
    printf("invalid atm address\n");
    exit(-1);
}
for (i=0; i<20; i++) {
    addr.sndd_atm_addr.number.addr[i] = o[i];
} /* endfor */
addr.sndd_atm_addr.length = ATM_ADDR_LEN;
addr.sndd_atm_addr.type = CM_INTL_ADDR_TYPE;

```

```

addr.sndd_atm_addr.plan_id = CM_NSAP;
addr.sndd_atm_addr.pres_ind = NOT_SPECIFIED_B;
addr.sndd_atm_addr.screening = NOT_SPECIFIED_B;
addr.sndd_atm_vc_type = CONN_SVC;
error = connect( s, (struct sockaddr *)&addr, sizeof(addr) );
if (error) {
    perror("connect");
    // If a connect fails, the cause structure may contain useful
    // information for determining the reason of the failure.
    // See the ATM UNI 3.0 for a description of the cause values.
    size = sizeof(cause_t);
    error = getsockopt(s, 0, SO_ATM_CAUSE, (void *)&cause, &size);
    if (error) {
        perror("SO_ATM_CAUSE");
    } else {
        printf("cause = %d\n", cause.cause );
    } /* endif */
    exit(-1);
} /* endif */
while (1) {
    error = send( s, buff, BUFF_SIZE, 0 );
    if (error == -1) {
        // If a send fails, the cause structure may contain useful
        // information for determining the reason of the failure.
        // The connection might have been closed by the other party,
        // or the physical network might have been disconnected.
        // See the ATM UNI 3.0 for a description of the cause values.
        // If the send failed for some other reason, the errno will
        // indicate this.
        perror("send");
        size = sizeof(cause_t);
        error = getsockopt(s, 0, SO_ATM_CAUSE, (void *)&cause, &size);
        if (error) {
            perror("SO_ATM_CAUSE");
        } else {
            printf("cause = %d\n", cause.cause );
        }
        exit(-1);
    } else {
        printf("sent %d bytes\n", error );
    }
    sleep(1);
}
}

```

Receiving Data on an ATM Socket SVC Server Example Program

This program must be compiled with the **-D_BSD** and **-lbsd** options. For example, use the **cc prog.c -o prog -D_BSD -lbsd** command.

```

/*
 * ATM Sockets SVC Server Example
 *
 * This program listens for and accepts an SVC and receives data on it.
 *
 */
#include <stdio.h>
#include <stddef.h>
#include <stdlib.h>
#include <errno.h>
#include <sys/socket.h>
#include <sys/ioctl.h>
#include <sys/ndd_var.h>
#include <sys/atmsock.h>
#define BUFF_SIZE      8192
char  buff[BUFF_SIZE];
main(argc, argv)

```

```

    int argc;
    char *argv[];
}
int          s;          // Socket file descriptor
int          new_s;     // Socket returned by accept
int          error;     // Function return code
int          i;
sockaddr_ndd_atm_t  addr; // ATM Socket Address
unsigned long size;    // Size of socket argument
aal_parm_t  aal_parm;  // AAL parameters
blli_t      blli[3];   // Broadband Lower Layer Info
traffic_des_t  traffic; // Traffic Descriptor
bearer_t     bearer;   // Broadband Bearer Capability
cause_t      cause;   // Cause of failure
// Create a socket in the AF_NDD domain of type SOCK_CONN_DGRAM
// and NDD_PROT_ATM protocol.
s = socket(AF_NDD, SOCK_CONN_DGRAM, NDD_PROT_ATM);
if (s == -1) {
    perror("socket");
    exit(-1);
}
// The bind command associates this socket with a particular
// ATM device, as specified by addr.sndd_atm_nddname.
addr.sndd_atm_len = sizeof(addr);
addr.sndd_atm_family = AF_NDD;
strcpy( addr.sndd_atm_nddname, "atm0" ); // The name of the ATM device
// which is to be used.
error = bind( s, (struct sockaddr *)&addr, sizeof(addr) );
if (error) {
    perror("bind");
    exit(-1);
} /* endif */
// Although up to 3 BLLIs may be specified by the calling side,
// the listening side may only specify one.
bzero(blli, sizeof(blli_t) );
blli[0].length = sizeof(blli_t);
blli[1].length = 0;
blli[2].length = 0;
// If a call arrives that matches these two parameters, it will
// be given to this application.
blli[0].L2_prot = CM_L2_PROT_USER;
blli[0].L2_info = 1;
// Fields that are not used must be set to NOT_SPECIFIED_B (byte)
blli[0].L2_mode = NOT_SPECIFIED_B;
blli[0].L2_win_size = NOT_SPECIFIED_B;
blli[0].L3_prot = NOT_SPECIFIED_B;
blli[0].L3_mode = NOT_SPECIFIED_B;
blli[0].L3_def_pkt_size = NOT_SPECIFIED_B;
blli[0].L3_pkt_win_size = NOT_SPECIFIED_B;
blli[0].L3_info = NOT_SPECIFIED_B;
blli[0].ipi = NOT_SPECIFIED_B;
blli[0].snap_oui[0] = NOT_SPECIFIED_B;
blli[0].snap_oui[1] = NOT_SPECIFIED_B;
blli[0].snap_oui[2] = NOT_SPECIFIED_B;
blli[0].snap_pid[0] = NOT_SPECIFIED_B;
blli[0].snap_pid[1] = NOT_SPECIFIED_B;
error = setsockopt( s, 0, SO_ATM_BLLI, (void *)&blli,
    sizeof(blli) );
if (error) {
    perror("setsockopt SO_ATM_BLLI");
    exit(-1);
} /* endif */
// Query and print out the ATM address of this station. The
// client application will need it.
bzero( &addr, sizeof(addr));
size = sizeof(addr);
error = getsockname( s, (struct sockaddr *)&addr, &size );

```

```

if (error) {
    perror("getsockname");
    exit(-1);
} /* endif */
printf("My ATM address: ");
for (i=0; i<20; i++) {
    printf("%X.", addr.sndd_atm_addr.number.addr[i]);
} /* endfor */
printf("\n");
// Although up to 3 BLLIs may be specified by the calling side,
// the listening side may only specify one.
bzero(blli, sizeof(blli_t) );
blli[0].length = sizeof(blli_t);
blli[1].length = 0;
blli[2].length = 0;
// If a call arrives that matches these two parameters, it will
// be given to this application.
blli[0].L2_prot = CM_L2_PROT_USER;
blli[0].L2_info = 1;
// Fields that are not used must be set to NOT_SPECIFIED_B (byte)
blli[0].L2_mode = NOT_SPECIFIED_B;
blli[0].L2_win_size = NOT_SPECIFIED_B;
blli[0].L3_prot = NOT_SPECIFIED_B;
blli[0].L3_mode = NOT_SPECIFIED_B;
blli[0].L3_def_pkt_size = NOT_SPECIFIED_B;
blli[0].L3_pkt_win_size = NOT_SPECIFIED_B;
blli[0].L3_info = NOT_SPECIFIED_B;
blli[0].ipi = NOT_SPECIFIED_B;
blli[0].snap_oui[0] = NOT_SPECIFIED_B;
blli[0].snap_oui[1] = NOT_SPECIFIED_B;
blli[0].snap_oui[2] = NOT_SPECIFIED_B;
blli[0].snap_pid[0] = NOT_SPECIFIED_B;
blli[0].snap_pid[1] = NOT_SPECIFIED_B;
error = setsockopt( s, 0, SO_ATM_BLLI, (void *)&blli,
    sizeof(blli) );

if (error) {
    perror("setsockopt SO_ATM_BLLI");
    exit(-1);
} /* endif */
// Query and print out the ATM address of this station. The
// client application will need it.
bzero( &addr, sizeof(addr));
size = sizeof(addr);
error = getsockname( s, (struct sockaddr *)&addr, &size );
if (error) {
    perror("getsockname");
    exit(-1);
} /* endif */
bzero( &addr, sizeof(addr));
size = sizeof(addr);
error = getsockname( s, (struct sockaddr *)&addr, &size );
if (error) {
    perror("getsockname");
    exit(-1);
} /* endif */
// The listen call enables this socket to receive incoming call
// that match its BLLI.
error = listen( s, 10 );
if (error) {
    // Listen will fail if the station is not connected to
    // an ATM switch.
    perror("listen");
    exit(-1);
} /* endif */
size = sizeof(addr);
// The accept will return a new socket of an incoming call
// for this socket, or sleep until one arrives.

```

```

new_s = accept( s, (struct sockaddr *)&addr, &size );
if (new_s == -1) {
    perror("accept");
    exit(-1);
} /* endif */
// In order for the connection to be fully established, the
// SO_ATM_ACCEPT setsockopt call must be issued. An application
// may query the parameters first with getsockopt before deciding
// to fully establish this connection and change some parameters.
// If no parameters are to be changed the third parameter may
// be NULL, otherwise it points to a indaccept_ie structure.
error = setsockopt( new_s, 0, SO_ATM_ACCEPT, NULL, 0 );
if (error) {
    perror("setsockopt ACCEPT");
    exit(-1);
} /* endif */
while (1) {
    error = recv( new_s, buff, BUFF_SIZE, 0 );
    if (error == -1) {
        // If a recv fails, the cause structure may contain useful
        // information for determining the reason of the failure.
        // The connection might have been closed by the other party,
        // or the physical network might have been disconnected.
        // See the ATM UNI 3.0 for a description of the cause values.
        // If the send failed for some other reason, the errno will
        // indicate this.
        perror("recv");
        size = sizeof(cause_t);
        error = getsockopt(new_s, 0, SO_ATM_CAUSE,
                          (void *)&cause, &size);

        if (error) {
            perror("SO_ATM_CAUSE");
        } else {
            printf("cause = %d\n", cause.cause );
        } /* endif */
        exit(-1);
    } else {
        printf("received %d bytes\n", error);
    } /* endif */
}
}

```

Receiving Packets Over Ethernet Example Program

```

#include <stdio.h>
#include <sys/ndd_var.h>
#include <sys/kinfo.h>
/*
 * Get the MAC address of the ethernet adapter we're using...
 */
getaddr(char *device, char *addr)
{
    int size;
    struct kinfo_ndd *nddp;
    void *end;
    int found = 0;
    size = getkerninfo(KINFO_NDD, 0, 0, 0);
    if (size == 0) {
        fprintf(stderr, "No ndds.\n");
        exit(0);
    }

    if (size < 0) {
        perror("getkerninfo 1");
        exit(1);
    }
    nddp = (struct kinfo_ndd *)malloc(size);

```

```

    if (!nddp) {
        perror("malloc");
        exit(1);
    }
    if (getkerninfo(KINFO_NDD, nddp, &size, 0) < 0) {
        perror("getkerninfo 2");
        exit(2);
    }
    end = (void *)nddp + size;
    while (((void *)nddp < end) && !found) {
        if (!strcmp(nddp->ndd_alias, device) ||
            !strcmp(nddp->ndd_name, device)) {
            found++;
            bcopy(nddp->ndd_addr, addr, 6);
        } else
            nddp++;
    }
    return (found);
}
/*
 * Hex print function...
 */
pit(str, buf, len)
u_char *str;
u_char *buf;
int len;
{
    int i;
    printf("%s", str);
    for (i=0; i<len; i++)
        printf("%2.2X", buf[i]);
    printf("\n");
    fflush(stdout);
}
/*
 * Ethernet packet format...
 */
typedef struct {
    unsigned char    dst[6];
    unsigned char    src[6];
    unsigned short   ethertype;
    unsigned char    data[1500];
} xmit;
main(int argc, char *argv[]) {
    char *device;
    u_int ethertype;
    xmit buf;
    int s;
    struct sockaddr_ndd_8022 sa;
    int cc;
    if (argc != 3) {
        printf("Usage: %s <ifname> ethertype\n", argv[0]);
        printf("EG:   %s ent0 0x600\n", argv[0]);
        exit(1);
    }
    device = argv[1];
    sscanf(argv[2], "%x", &ethertype);
    printf("Ethertype: %x\n", ethertype);
    s = socket(AF_NDD, SOCK_DGRAM, NDD_PROT_ETHER);
    if (s < 0) {
        perror("socket");
        exit(1);
    }
    sa.sndd_8022_family = AF_NDD;
    sa.sndd_8022_len = sizeof(sa);
    sa.sndd_8022_filtertype = NS_ETHERTYPE;

```

```

sa.sndd_8022_ethertype = (u_short)ethertype;
sa.sndd_8022_filterlen = sizeof(struct ns_8022);
bcopy(device, sa.sndd_8022_nddname, sizeof(sa.sndd_8022_nddname));
if (bind(s, (struct sockaddr *)&sa, sizeof(sa)) {
    perror("bind");
    exit(2);
}
if (connect(s, (struct sockaddr *)&sa, sizeof(sa)) < 0) {
    perror("connect");
    exit(3);
}
do {
    if ((cc = read(s, &buf, sizeof(buf))) < 0) {
        perror("write");
        exit(4);
    }
    if (cc) {
        printf("Read %d bytes:\n", cc);
        pit("\tsrc = ", buf.src, 6);
        pit("\tdst = ", buf.dst, 6);
        pit("\ttype = ", &(buf.ethertype), 2);
        printf("\tdata string: %s\n", buf.data);
    }
} while (cc > 0);
close(s);
}

```

Sending Packets Over Ethernet Example Program

```

#include <stdio.h>#include <sys/ndd_var.h>
#include <sys/kinfo.h>
/*
 * Get the MAC address of the ethernet adapter we're using...
 */
getaddr(char *device, char *addr)
{
    int size;
    struct kinfo_ndd *nddp;
    void *end;
    int found = 0;
    size = getkerninfo(KINFO_NDD, 0, 0, 0);
    if (size == 0) {
        fprintf(stderr, "No ndds.\n");
        exit(0);
    }

    if (size < 0) {
        perror("getkerninfo 1");
        exit(1);
    }
    nddp = (struct kinfo_ndd *)malloc(size);

    if (!nddp) {
        perror("malloc");
        exit(1);
    }
    if (getkerninfo(KINFO_NDD, nddp, &size, 0) < 0) {
        perror("getkerninfo 2");
        exit(2);
    }
    end = (void *)nddp + size;
    while (((void *)nddp < end) && !found) {
        if (!strcmp(nddp->ndd_alias, device) ||
            !strcmp(nddp->ndd_name, device)) {
            found++;
            bcopy(nddp->ndd_addr, addr, 6);
        } else

```

```

                                nddp++;
                                }
                                return (found);
}
/*
 * Hex print function...
 */
pit(str, buf, len)
u_char *str;
u_char *buf;
int len;
{
    int i;
    printf("%s", str);
    for (i=0; i<len; i++)
        printf("%2.2X", buf[i]);
    printf("\n");
    fflush(stdout);
}
/*
 * Ethernet packet format...
 */
typedef struct {
    unsigned char    dst[6];
    unsigned char    src[6];
    unsigned short   ethertype;
    unsigned char    data[1500];
} xmit;
/*
 * Convert ascii hardware address into byte string.
 */
hwaddr_aton(a, n)
char *a;
u_char *n;
{
    int i, o[6];
    i = sscanf(a, "%x:%x:%x:%x:%x:%x", &o[0], &o[1], &o[2],
                                                &o[3], &o[4], &o[5]);
    if (i != 6) {
        fprintf(stderr, "invalid hardware address '%s'\n");
        return (0);
    }
    for (i=0; i<6; i++)
        n[i] = o[i];
    return (6);
}
main(int argc, char *argv[]) {
    char srcaddr[6];
    char *device, dstaddr[6];
    u_int ethertype;
    u_int count, size;
    xmit buf;
    int s;
    struct sockaddr_ndd_8022 sa;
    int last;

    if (argc != 6) {
        printf("Usage: %s <ifname> dstaddr ethertype count size\n",
              argv[0]);
        printf("EG: %s en0 01:02:03:04:05:06 0x600 10 10\n",
              argv[0]);
        exit(1);
    }
    if (!getaddr(argv[1], srcaddr)) {
        printf("interface not found\n");
        exit(1);
    }
}

```



```

device=argv[1];
hwaddr_aton(argv[2], dstaddr);
pit("src addr = ", srcaddr, 6);
pit("dst addr = ", dstaddr, 6);
sscanf(argv[3], "%x", &ethertype);
count = atoi(argv[4]);
size = atoi(argv[5]);
if (size > 1500)
    size = 1500;
if (size < 60)
    size = 60;
printf("Ethertype: %x\n", ethertype);
printf("Count: %d\n", count);
printf("Size: %d\n", size);

s = socket(AF_NDD, SOCK_DGRAM, NDD_PROT_ETHER);
if (s < 0) {
    perror("socket");
    exit(1);
}
sa.sndd_8022_family = AF_NDD;
sa.sndd_8022_len = sizeof(sa);
sa.sndd_8022_filtertype = NS_ETHERTYPE;
sa.sndd_8022_ethertype = (u_short)ethertype;
sa.sndd_8022_filterlen = sizeof(struct ns_8022);
bcopy(device, sa.sndd_8022_nddname, sizeof(sa.sndd_8022_nddname));
if (bind(s, (struct sockaddr *)&sa, sizeof(sa))) {
    perror("bind");
    exit(2);
}
bcopy(dstaddr, buf.dst, sizeof(buf.dst));
bcopy(srcaddr, buf.src, sizeof(buf.src));
buf.ethertype = (u_short)ethertype;
if (connect(s, (struct sockaddr *)&sa, sizeof(sa)) < 0) {
    perror("connect");
    exit(3);
}
last = count;
while (count-- > 0) {
    sprintf(buf.data, "Foo%d", last-count);
    if (write(s, &buf, size) < 0) {
        perror("write");
        exit(4);
    }
}
close(s);
}

```

Analyzing Packets Over the Network Example Program

```

/*
 * Simple sniffer to capture 802.2 frames on 802.3 ethernet, token ring,
 * FDDI, and other CDLI devices that support 802.2 encapsulation...
 */
#include <stdio.h>
#include <sys/types.h>
#include <sys/ndd_var.h>
#include <sys/tok_demux.h>
#include <netinet/if_802_5.h>
main(argc, argv)
int argc;
char *argv[];
{
    int s;
    struct sockaddr_ndd_8022 sa;
    struct sockaddr_ndd_8022 from;

```

```

struct sockaddr *fromp = (struct sockaddr *)&from;
int len;
char buf[2000];
int cc;
u_long fromlen;
int sap;
struct ie5_mac_hdr *macp = (struct ie5_mac_hdr *)buf;
struct ie2_llc_hdr *llcp;
if (argc != 3) {
    printf("Usage %s <interface> <sap>\n", argv[0]);
    exit(1);
}
sscanf(argv[2], "%x", &sap);
printf("sap is %x\n", sap);
s = socket(AF_NDD, SOCK_DGRAM, 0);
if (s < 0) {
    perror("socket");
    exit(1);
}
sa.sndd_8022_family = AF_NDD;
sa.sndd_8022_len = sizeof(struct sockaddr_ndd_8022);
sa.sndd_8022_filtertype = NS_TAP;
sa.sndd_8022_filterlen = sizeof(ns_8022_t);
strcpy(sa.sndd_8022_nddname, argv[1]);
if (bind(s, (struct sockaddr *)&sa, sizeof(struct sockaddr_ndd_8022))) {
    perror("bind");
    exit(2);
}
len = sizeof(buf);
fromlen = sizeof(from);
while (TRUE) {
    if ((cc = recvfrom(s, buf, len, 0, fromp, &fromlen)) < 0) {
        perror("recvfrom");
        exit(3);
    }
    if (!strcmp(argv[1], "ent0"))
        llcp = (struct ie2_llc_hdr *) (buf+14);
    else
        llcp = (struct ie2_llc_hdr *) (buf + mac_size(macp));
    if ((llcp->dsap == sap) || (llcp->ssap == sap))
        printit(buf, cc);
}
printit(char *buf, int cc)
{
    int i;
    printf("FRAME: ");
    for (i=0; i < cc; i++)
        printf("%2.2x", *(buf+i));
    printf("\n");
}

```

List of Socket Programming References

The list includes:

- “Kernel Service Subroutines”
- “Network Library Subroutines” on page 249
- “Header Files” on page 250
- “Protocols” on page 250

Kernel Service Subroutines

accept Accepts a connection on a socket to create a new socket.

bind	Binds a name to a socket.
connect	Connects two sockets.
getdomainname	Gets the name of the current domain.
gethostid	Gets the unique identifier of the current host.
gethostname	Gets the unique name of the current host.
getpeername	Gets the name of the peer socket.
getsockname	Gets the socket name.
getsockopt	Gets options on sockets.
listen	Listens for socket connections and limits the backlog of incoming connections.
recv	Receives messages from connected sockets.
recvfrom	Receives messages from sockets.
recvmsg	Receives a message from any socket.
send	Sends messages from a connected socket.
sendmsg	Sends a message from a socket by using a message structure.
sendto	Sends messages through a socket.
send_file	Sends the contents of a file through a socket.
setdomainname	Sets the name of the current domain.
sethostid	Sets the unique identifier of the current host.
sethostname	Sets the unique name of the current host.
setsockopt	Sets socket options.
shutdown	Shuts down all socket send and receive operations.
socket	Creates an end point for communication and returns a descriptor.
socketpair	Creates a pair of connected sockets.

Network Library Subroutines

dn_comp	Compresses a domain name.
dn_expand	Expands a compressed domain name.
endhostent	Ends retrieval of network host entries.
endnetent	Closes the networks file.
endprotoent	Closes the /etc/protocols file.
endservent	Closes the /etc/service file entry.
gethostbyaddr	Gets network host entry by address.
gethostbyname	Gets network host entry by name.
gethostent	Gets host entry from the /etc/hosts file.
getnetbyaddr	Gets network entry by address.
getnetbyname	Gets network entry by name.
getnetent	Gets network entry.
getprotobyname	Gets protocol entry from the /etc/protocols file by protocol name.
getprotobynumber	Gets a protocol entry from the /etc/protocols file by number.
getprotoent	Gets protocol entry from the /etc/protocols file.
_getlong	Retrieves long byte quantities.
_getshort	Retrieves short byte quantities.
getservbyname	Gets service entry by name.
getservbyport	Gets service entry by port.
getservent	Gets services file entry.
htonl	Converts an unsigned long integer from host byte order to Internet-network byte order.
htons	Converts an unsigned short integer from host byte order to Internet-network byte order.
inet_addr	Converts Internet addresses to Internet numbers.
inet_lnaof	Separates local Internet addresses into their network number and local network address.
inet_makeaddr	Makes an Internet address.

inet_netof	Separates network Internet addresses into their network number and local network address.
inet_network	Converts Internet network addresses in . (dot) notation to Internet numbers.
inet_ntoa	Converts an Internet address into an ASCII string.
ntohl	Converts an unsigned long integer from Internet-network standard byte order to host byte order.
ntohs	Converts an unsigned short integer from Internet-network byte order to host byte order.
_putlong	Places long byte quantities into the byte stream.
_putshort	Places short byte quantities into the byte stream.
rcmd	Allows execution of commands on a remote host.
res_init	Searches for a default domain name and Internet address.
res_mkquery	Makes query messages for name server.
res_query	Provides an interface to the server query mechanism.
res_search	Makes a query and awaits a response.
res_send	Sends a query to a name server and retrieves a response.
rexec	Allows command execution on a remote host.
rresvport	Retrieves a socket with a privileged address.
ruserok	Allows servers to authenticate clients.
sethostent	Opens network host file.
setnetent	Opens and rewinds the network file.
setprotoent	Opens and rewinds the /etc/protocols file.
setservent	Opens and rewinds the service file.
socks5tcp_connect	Connect to a SOCKS version 5 server and request a connection to an external destination.
socks5tcp_bind	Connect to a SOCKS version 5 server and request a listening socket for incoming remote connections.
socks5tcp_accept	Awaits an incoming connection to a socket from a previous socks5tcp_bind call.
socks5udp_associate	Connects to a SOCKS version 5 server and requests a UDP association for subsequent UDP socket communications.
socks5udp_sendto	Send UDP packets through a SOCKS version 5 server.
socks5_getserv	Returns the address of the SOCKS version 5 server (if any) to use when connecting to a given destination.

Header Files

/usr/include/netinet/in.h	Defines Internet constants and structures.
/usr/include/arpa/nameser.h	Contains Internet name-server information.
/usr/include/netdb.h	Contains data definitions for socket subroutines.
/usr/include/resolv.h	Contains resolver global definitions and variables.
/usr/include/sys/socket.h	Contains data definitions and socket structures.
/usr/include/sys/socketvar.h	Defines the kernel structure per socket and contains buffer queues.
/usr/include/sys/types.h	Contains data type definitions.
/usr/include/sys/un.h	Defines structures for the UNIX Interprocess Communication domain.

Protocols

PF_UNIX	Local communication
PF_INET	Internet (TCP/IP)

Chapter 10. STREAMS

STREAMS is a general, flexible facility and a set of tools for developing system communication services. With STREAMS, developers can provide services ranging from complete networking protocol suites to individual device drivers.

This chapter provides an overview of the major STREAMS concepts. Consult *UNIX System V Release 4, Programmer's Guide: STREAMS* and *Data Link Provider Interface Specification* for additional information.

The following concepts are discussed:

- "STREAMS Introduction"
- "Benefits and Features of STREAMS" on page 254
- "STREAMS Flow Control" on page 256
- "STREAMS Synchronization" on page 257
- "Using STREAMS" on page 264
- "STREAMS Tunable Parameters" on page 265
- "streamio (STREAMS ioctl) Operations" on page 267
- "Building STREAMS" on page 267
- "STREAMS Messages" on page 270
- "Put and Service Procedures" on page 273
- "STREAMS Drivers and Modules" on page 274
- "log Device Driver" on page 277
- "Configuring Drivers and Modules in the Portable Streams Environment" on page 279.
- "An Asynchronous Protocol STREAMS Example" on page 282
- "Differences Between Portable Streams Environment and V.4 STREAMS" on page 287
- "List of STREAMS Programming References" on page 289
- "Transport Service Library Interface Overview" on page 291

STREAMS Introduction

STREAMS represent a collection of system calls, kernel resources, and kernel utility routines that can create, use, and dismantle a stream. A *stream* is a full-duplex processing and data transfer path between a driver in kernel space and a process in user space.

The STREAMS mechanism constructs a stream by serially connecting kernel-resident STREAMS components, each constructed from a specific set of structures. As shown in the Stream Detail figure (Figure 32 on page 252), the primary STREAMS components are:

stream head	Provides the interface between the stream and user processes. Its principal function is to process STREAMS-related user system calls. <u>STREAMS system calls can be used from 64-bit and 32-bit user processes.</u>
module	Processes data that travels between the stream head and driver. Modules are optional.
stream end	Provides the services of an external input/output device or an internal software driver. The internal software driver is commonly called a pseudo-device driver.

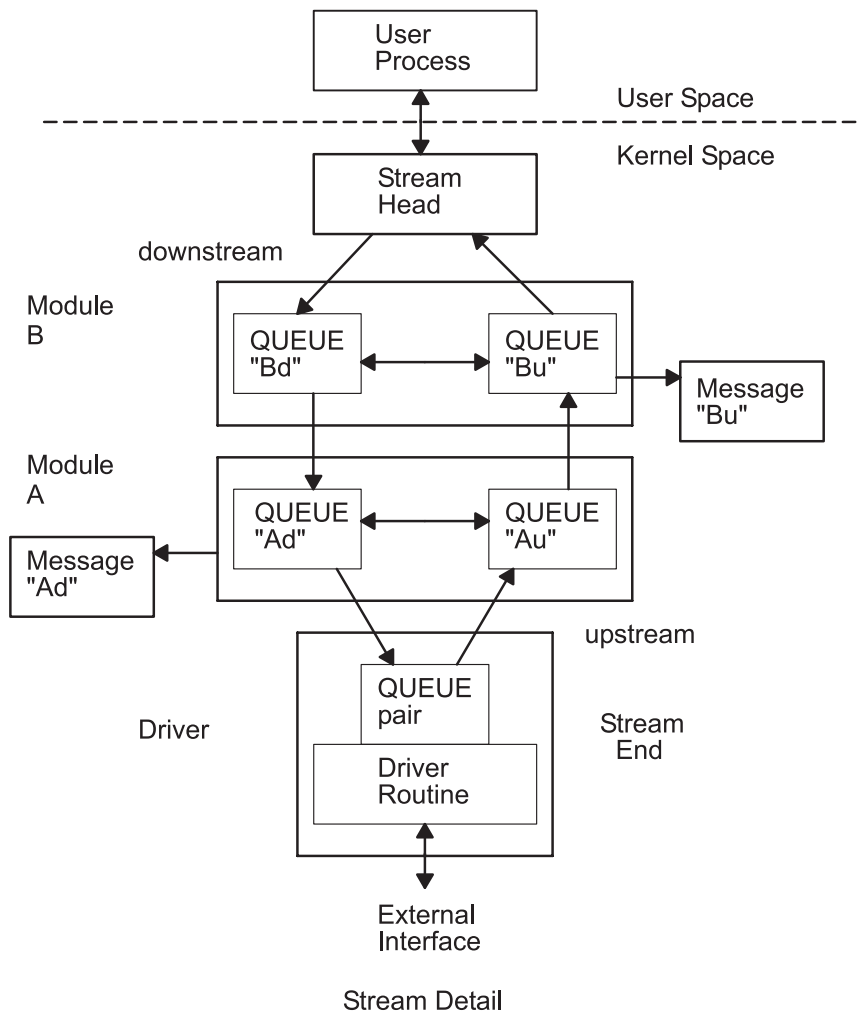

Figure 32. Stream Detail. This diagram shows the user process at the top with a bidirectional arrow going into the kernel space to the stream head. On the downstream path (or left) an arrow travels from the stream head to queue "Bd" in module B, and then an arrow goes to queue "Ad" in module A (with message "Ad" as a parameter). An arrow then travels from queue "Ad" to queue pair in the stream end. The driver routine is connected to the queue pair in the driver. There is a bidirectional arrow from the driver routine to the external interface. On the upstream path (or right), an arrow travels from the queue pair to queue "Au" in module A, and then an arrow travels to queue "Bu" in module B (with message "Bu" as a parameter). An arrow then travels from queue "Bu" to the stream head.

STREAMS defines standard interfaces for character input and output within the system kernel and between the kernel and the rest of the system. The associated mechanism is simple and open-ended. It consists of a set of system calls, kernel resources, and kernel utility routines. The standard interface and open-ended mechanism enable modular, portable development and easy integration of high-performance network services and components. STREAMS does not impose any specific network architecture. Instead, it provides a powerful framework with a consistent user interface that is compatible with the existing character input/output interface.

Using a combination of system calls, kernel routines, and kernel utilities, STREAMS passes data between a driver and the stream head in the form of messages. Messages that are passed from the stream head toward the driver are said to travel *downstream* while messages passed in the other direction travel *upstream*.

Stream Head

The stream head transfers data between the data space of a user process and STREAMS kernel data space. Data sent to a driver from a user process is packaged into STREAMS messages and transmitted

downstream. Downstream messages arriving at the stream head are processed by the stream head, and data is copied from user buffers. STREAMS can insert one or more modules into a stream between the stream head and the driver to process data passing between the two.

The stream head provides an interface between the stream and an application program. The stream head processes STREAMS-related operations from the application and performs the bidirectional transfer of data and information between the application (in user space) and messages (in STREAMS kernel space).

Messages are the only means of transferring data and communicating within a stream. A STREAMS message contains data, status or control information, or a combination of both. Each message includes a specified message type indicator that identifies the contents.

For more information about the STREAMS message-passing scheme, see “STREAMS Messages” on page 270.

Modules

A module performs intermediate transformations on messages passing between the stream head and the driver. Zero or more modules can exist in a stream (zero when the driver performs all the required character and device processing).

Each module is constructed from a pair of QUEUE structures (see the Au/Ad QUEUE pair and the Bu/Bd QUEUE pair in the Stream Detail diagram shown previously). A pair of such structures is required to implement the bidirectional and symmetrical attributes of a stream. One QUEUE (such as the Au or Bu QUEUE) performs functions on messages passing upstream through the module. The other QUEUE (the Ad or Bd QUEUE) performs another set of functions on downstream messages. (A QUEUE, which is part of a module, is different from a message queue, which is described in “STREAMS Flow Control” on page 256.)

Each of the two QUEUES in a module generally have distinct functions; that is, unrelated processing procedures and data. The QUEUES operate independently so that the Au QUEUE does not know if a message passes through the Ad QUEUE unless the Ad QUEUE is programmed to inform it. Messages and data can be shared only if the developer specifically programs the module functions to perform the sharing.

Each QUEUE can directly access the adjacent QUEUE in the direction of message flow (for example, Au to Bu or stream head to Bd). In addition, within a module, a QUEUE can readily locate its mate and access its messages (for example, for echoing) and data.

Each QUEUE in a module can contain or point to:

- Messages — These are dynamically attached to the QUEUE on a linked list, or message queue (see Ad and Bu in the Figure 32 on page 252), as they pass through the module.
- Processing procedures — A put procedure must be incorporated in each QUEUE to process messages. An optional service procedure for sharing the message processing with the put procedure can also be incorporated. According to their function, the procedures can send messages upstream or downstream, and they can also modify the private data in their module.

For more information about processing procedures, see “Put and Service Procedures” on page 273.

- Data — Developers can provide private data if required by the QUEUE to perform message processing (for example, state information and translation tables).

In general, each of the two QUEUES in a module has a distinct set of all these elements. Additional module elements are described later. Although depicted as distinct from modules, a stream head and a stream end also contain a pair of QUEUES.

Stream End

A stream end is a module in which the module processing procedures are the driver routines. The procedures in the stream end are different from those in other modules because they are accessible from an external device and because the STREAMS mechanism allows multiple streams to be connected to the same driver.

The driver can be a device driver, providing an interface between kernel space and an external communications device, or an internal pseudo-device driver. A pseudo-device driver is not directly related to any external device, and it performs functions internal to the kernel.

Device drivers must transform all data and status or control information between STREAMS message formats and their external representation. For more information on the differences between STREAMS and character device drivers, see “STREAMS Drivers and Modules” on page 274.

STREAMS Modularity

STREAMS modularity and design reflect the layers and option characteristics of contemporary networking architectures. The basic components in a STREAMS implementation are referred to as *modules* (see “Modules” on page 275). The modules, which reside in the kernel, offer a set of processing functions and associated service interfaces. From a user level, modules can be selected dynamically and interconnected to provide any rational processing sequence. Kernel programming, assembly, and link editing are not required to create the interconnection. Modules can also be dynamically plugged into existing connections from user level. STREAMS modularity allows:

- User-level programs that are independent of underlying protocols and physical communication media
- Network architectures and high-level protocols that are independent of underlying protocols, drivers, and physical communication media
- High-level services that can be created by selecting and connecting low-level services and protocols
- Enhanced portability of protocol modules, resulting from the well-defined structure and interface standards of STREAMS.

STREAMS Facilities

In addition to modularity, STREAMS provides developers with integral functions, a library of utility routines, and facilities that expedite software design and implementation. The principal facilities are:

Buffer management	Maintains an independent buffer pool for STREAMS.
Scheduling	Incorporates a scheduling mechanism for STREAMS.
Asynchronous operation of STREAMS and user processes	Allows STREAMS-related operations to be performed efficiently from user level.

Other facilities include flow control (“STREAMS Flow Control” on page 256) to conserve STREAMS memory and processing resources.

Benefits and Features of STREAMS

STREAMS offers two major benefits for applications programmers:

- Easy creation of modules that offer standard data communications services. See “Creating Service Interfaces” on page 255.
- The ability to manipulate those modules on a stream. See “Manipulating Modules” on page 255.

Additional STREAMS features are provided to handle characteristic problems of protocol implementation and to assist in development. There are also kernel- and user-level facilities that support the implementation of advanced functions and allow asynchronous operation of a user process and STREAMS input and output. The following features are discussed:

- “STREAMS Flow Control” on page 256
- “STREAMS Synchronization” on page 257

Creating Service Interfaces

One benefit of STREAMS is that it simplifies the creation of modules that present a service interface to any neighboring application program, module, or device driver. A service interface is defined at the boundary between two neighbors. In STREAMS, a service interface is a specified set of messages and the rules for allowable sequences of these messages across the boundary. A module that implements a service interface will receive a message from a neighbor and respond with an appropriate action (for example, send back a request to retransmit) based on the specific message received and the preceding sequence of messages.

STREAMS provides features that make it easier to design various application processes and modules to common service interfaces. If these modules are written to comply with industry-standard service interfaces, they are called *protocol modules*.

In general, any two modules can be connected anywhere in a stream. However, rational sequences are generally constructed by connecting modules with compatible protocol service interfaces.

Manipulating Modules

STREAMS provides the capabilities to manipulate modules from user level, to interchange modules with common service interfaces, and to present a service interface to a stream user process. These capabilities yield benefits when implementing networking services and protocols, including:

- User-level programs can be independent of underlying protocols and physical communication media.
- Network architectures and high-level protocols can be independent of underlying protocols, drivers, and physical communication media.
- Higher-level services can be created by selecting and connecting lower-level services and protocols.

Examples of the benefits of STREAMS capabilities to developers for creating service interfaces and manipulating modules are:

- “Protocol Substitution”
- “Module Reusability”

Protocol Substitution

Alternative protocol modules (and device drivers) can be interchanged on the same machine if they are implemented to equivalent service interfaces.

Module Reusability

The Module Reusability figure (Figure 33 on page 256) shows the same canonical module (for example, one that provides delete and kill processing on character strings) reused in two different streams. This module typically is implemented as a filter, with no downstream service interface. In both cases, a tty interface is presented to the stream user process because the module is nearest the stream head.

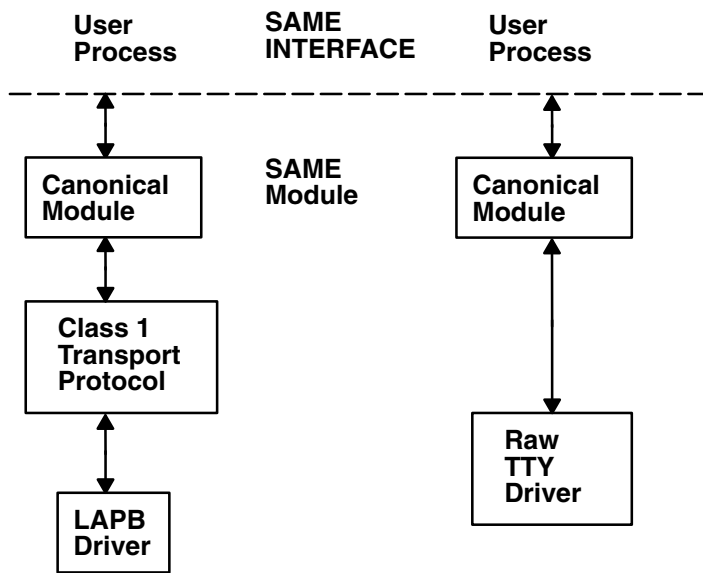

Module Reusability Diagram

Figure 33. Module Reusability Diagram. This diagram shows two of the same user processes using the same interface to communicate with two different streams. The first stream contains the following elements, which are connected with bidirectional arrows: same interface, canonical module, class 1 transport protocol, and LAPB driver. The second stream contains the following elements, which are connected with bidirectional arrows: same interface, canonical module, and raw TTY driver. In each stream, the elements below the a dashed line representing the same interface are in the same module.

STREAMS Flow Control

Even on a well-designed system, general system delays, malfunctions, and excessive accumulation on one or more streams can cause the message buffer pools to become depleted. Additionally, processing bursts can arise when a service procedure in one module has a long message queue and processes all its messages in one pass. STREAMS provides an independent mechanism to guard its message buffer pools from being depleted and to minimize long processing bursts at any one module.

Note: Flow control is applied only to normal priority messages.

The flow control mechanism is local to each stream and is advisory (voluntary), and it limits the number of characters that can be queued for processing at any QUEUE in a stream. This mechanism limits the buffers and related processing at any one QUEUE and in any one stream, but does not consider buffer pool levels or buffer usage in other streams.

The advisory mechanism operates between the two nearest QUEUES in a stream containing service procedures. Messages are generally held on a message queue only if a service procedure is present in the associated QUEUE.

Messages accumulate at a QUEUE when its service procedure processing does not keep pace with the message arrival rate, or when the procedure is blocked from placing its messages on the following stream component by the flow-control mechanism. Pushable modules contain independent upstream and downstream limits, which are set when a developer specifies high-water and low-water control values for the QUEUE. The stream head contains a preset upstream limit (which can be modified by a special message sent from downstream) and a driver may contain a downstream limit.

STREAMS flow control operates in the following order:

1. Each time a STREAMS message-handling routine (for example, the **putq** utility) adds or removes a message from a message queue in a QUEUE, the limits are checked. STREAMS calculates the total size of all message blocks on the message queue.
2. The total is compared to the QUEUE high-water and low-water values. If the total exceeds the high-water value, an internal full indicator is set for the QUEUE. The operation of the service procedure in this QUEUE is not affected if the indicator is set, and the service procedure continues to be scheduled (see “Service Procedures” on page 274).
3. The next part of flow control processing occurs in the nearest preceding QUEUE that contains a service procedure. In the Flow Control diagram (Figure 34), if D is full and C has no service procedure, then B is the nearest preceding QUEUE.

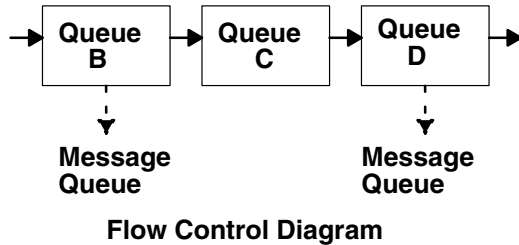

Figure 34. Flow Control. This diagram shows queue B, queue C, and queue D side-by-side. Beside each queue is an arrow coming from the left pointing toward that queue, then another arrow leaving that queue and pointing to the queue on the right. There are dashed arrows leading down from queue B and queue D to message queues.

4. In the Flow Control Diagram, the service procedure in B uses a STREAMS utility routine to see if a QUEUE ahead is marked full. If messages cannot be sent, the scheduler blocks the service procedure in B from further execution. B remains blocked until the low-water mark of the full QUEUE D is reached.
5. While B is blocked (in the Flow Control Diagram), any nonpriority messages that arrive at B will accumulate on its message queue (recall that priority messages are not blocked). In turn, B can reach a full state and the full condition will propagate back to the last module in the stream.
6. When the service procedure processing on D (in the Flow Control Diagram) causes the message block total to fall below the low-water mark, the full indicator is turned off. Then STREAMS automatically schedules the nearest preceding blocked QUEUE (in this case, B) and gets things moving again. This automatic scheduling is known as *back-enabling a QUEUE*.

To use flow control, a developer need only call the utility that tests if a full condition exists ahead (for example, the **canput** utility), and perform some housekeeping if it does. Everything else is automatically handled by STREAMS.

For more information about the STREAMS message-passing scheme, see “STREAMS Messages” on page 270.

STREAMS Synchronization

In a multi-threaded environment, several threads may access the same stream, the same module, or even the same queue at the same time. In order to protect the STREAMS resources (queues and other specific data), STREAMS provides per-thread resource synchronization. This synchronization is ensured by STREAMS and is completely transparent to the user.

Read the following to learn more about STREAMS synchronization:

- “Synchronization Mechanism” on page 258
- “Synchronization of timeout and bufcall Utilities” on page 258
- “Synchronization Levels” on page 258

- “Per-stream Synchronization” on page 262
- “Queue-Welding Mechanism” on page 263

Synchronization Mechanism

STREAMS uses a synchronization-queueing mechanism that maximizes execution throughput. A synchronization queue is a linked list of structures. Each structure encapsulates a callback to a function attempting to access a resource. A thread which cannot block (a service procedure, for example) can access the resource using a transparent call.

- If the resource is already held by another thread, the thread puts a request on the resource’s synchronization queue.
- If the resource is free, the thread executes its request immediately. After having done its job, and before releasing the resource, the thread goes through the synchronization queue and executes all the pending requests.

In either case, the call returns immediately. Routines performing synchronous operations, like stream head routines, are blocked until they gain access to the resource. Although the mechanism is completely transparent, the user needs to set the adequate synchronization level.

Synchronization of timeout and bufcall Utilities

On multiprocessor systems, the **timeout** and **bufcall** utilities present a particular problem to the synchronization mechanism. These utilities specify a callback function. Multiprocessor-safe modules or drivers require that the callback functions be interrupt-safe.

Multiprocessor-safe modules or drivers are designed to run on any processor. They are very similar to multiprocessor-safe device drivers. Interrupt-safe functions serialize their code with interrupt handlers. Functions such as the **qenable** utility or the **wakeup** kernel service are interrupt-safe.

To support callback functions that are not interrupt-safe, the **STR_QSAFETY** flag can be set when calling the **str_install** utility. When this flag is set, STREAMS ensures the data integrity of the module. Using this flag imposes an overhead to the module or driver, thus it should only be used when porting old code. When writing new code, callback functions must be interrupt-safe.

Synchronization Levels

The STREAMS synchronization mechanism offers flexible selection of synchronization levels. It is possible to select the set of resources serialized by one synchronization queue.

The synchronization levels are set dynamically by calling the **str_install** utility when a module or a driver is loaded. The synchronization levels are implemented by linking synchronization queues together, so that one synchronization queue is used for several resources. The following synchronization levels are defined:

- “No Synchronization Level”
- “Queue-Level Synchronization” on page 259
- “Queue Pair-Level Synchronization” on page 259
- “Module-Level Synchronization” on page 260
- “Arbitrary-Level Synchronization” on page 261
- “Global-Level Synchronization” on page 262

No Synchronization Level

No synchronization level indicates that each queue can be accessed by more than one thread at the same time. The protection of internal data and of **put** and **service** routines against the **timeout** or **bufcall** utilities is done by the module or driver itself.

This synchronization level is typically used by multiprocessor-efficient modules.

Queue-Level Synchronization

Queue-level synchronization protects an individual message queue. The module must ensure that no data inconsistency may occur when two different threads access both upstream and downstream queues at the same time.

This is the lowest level of synchronization available. It is typically used by modules with no need for synchronization, either because they share no state or provide their own synchronization or locking.

In the STREAMS Queue-Level Synchronization figure (Figure 35), the queue Bd (downstream queue of module B) is protected by queue-level synchronization. The bolded box shows the protected area; only one thread can access this area.

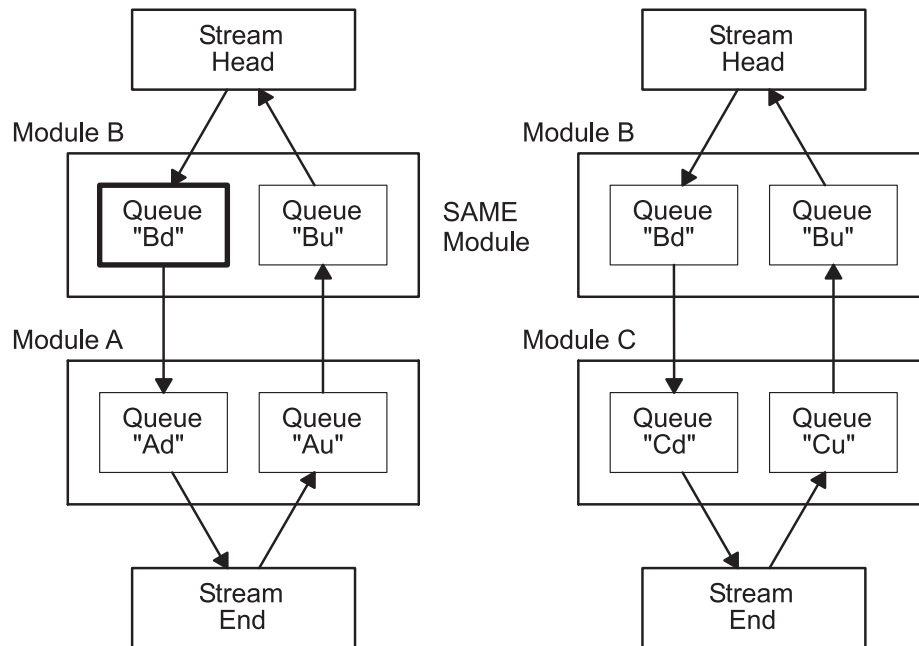

STREAMS Queue-Level Synchronization

Figure 35. STREAMS Queue-Level Synchronization. This diagram shows two streams, with two modules each, where the first module in each stream is an instance of the same module (Module B). The first stream (on the left) contains the protected Queue "Bd", which is downstream in the first instance of Module B.

Queue Pair-Level Synchronization

Queue pair-level synchronization protects the pair of message queues (downstream and upstream) of one instance of a module. The module may share common data between both queues, but it cannot assume that two instances of the module are accessed by two different threads at the same time.

Queue pair-level synchronization is a common synchronization level for most modules that have only per-stream data, such as TTY line disciplines. All stream-head queues are synchronized at this level.

In the Queue Pair-Level Synchronization figure (Figure 36 on page 260), the queue pair of module B's left instance is protected by queue pair-level synchronization. The boxes highlighted in bold show the protected area; only one thread can access this area.

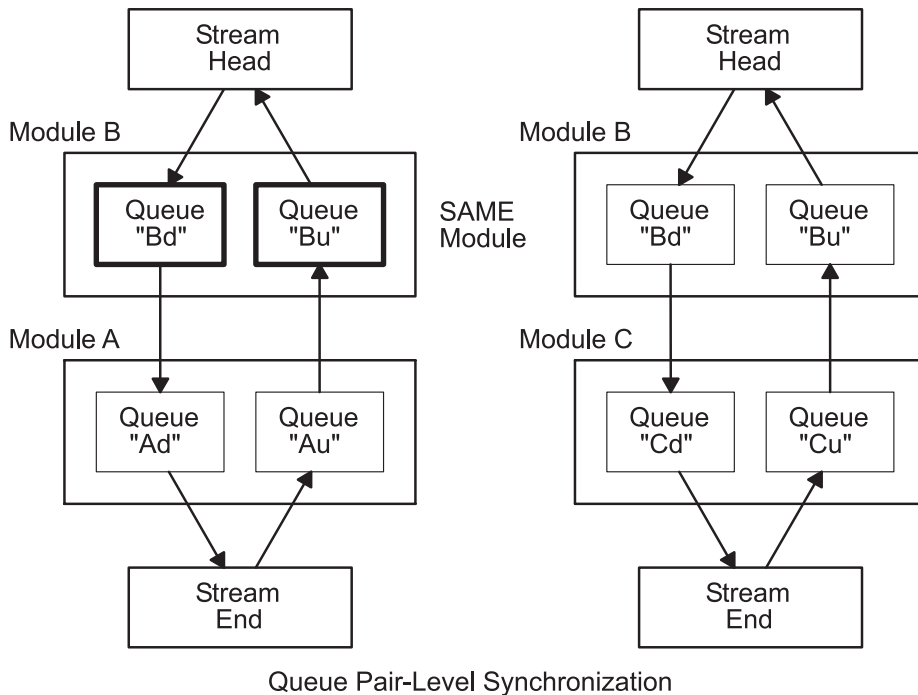

Figure 36. Queue Pair-Level Synchronization. This diagram shows two streams, with two modules each, where the first module in each stream is an instance of the same module (Module B). The first stream (on the left) contains two protected queues: Queue "Bd" which is downstream in the first instance of Module B, and Queue "Bu" which is upstream in the first instance of Module B.

Module-Level Synchronization

Module-level synchronization protects all instances of one module or driver. The module (or driver) can have global data, shared among all instances of the module. This data and all message queues are protected against concurrent access.

Module-level synchronization is the default synchronization level. Modules protected at this level are not required to be thread-safe, because multiple threads cannot access the module. Module-level synchronization is also used by modules that maintain shared state information.

In the Module-Level Synchronization figure (Figure 37 on page 261), module B (both instances) is protected by module-level synchronization. The boxes highlighted in bold show the protected area; only one thread can access this area.

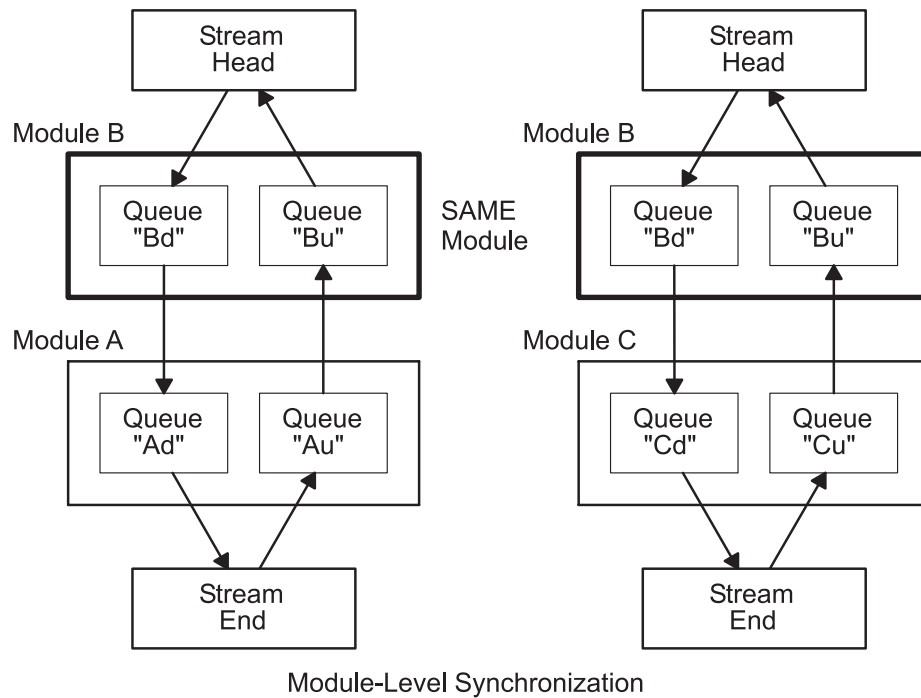

Figure 37. Module-Level Synchronization. This diagram shows two streams, with two modules each, where the first module in each stream is an instance of the same module (Module B). Each instance of Module B in each of the two streams is protected by module-level synchronization.

Arbitrary-Level Synchronization

Arbitrary-level synchronization protects an arbitrary group of modules or drivers (including all instances of each module or driver). A name passed when setting this level (with the **str_install** utility) is used to associate modules together. The name is decided by convention among cooperating modules.

Arbitrary-level synchronization is used for synchronizing a group of modules that access each other's data. An example might be a networking stack such as a Transmission Control Protocol (TCP) module and an Internet Protocol (IP) module, both of which share data. Such modules might agree to pass the string **"tcp/ip"**.

In the Arbitrary-Level Synchronization figure (Figure 38 on page 262), modules A and B are protected by arbitrary-level synchronization. Module A and both instances of module B are in the same group. The boxes highlighted in bold show the protected area; only one thread can access this area.

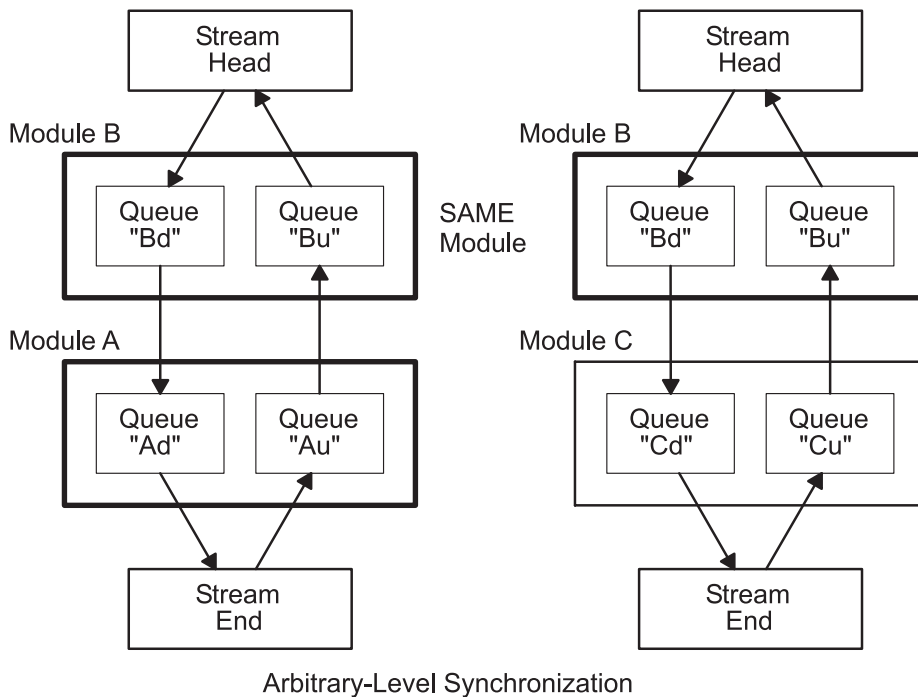

Figure 38. Arbitrary-Level Synchronization. This diagram shows two streams, with two modules each, where the first module in each stream is an instance of the same module (Module B). Each instance of Module B in each of the two streams is protected. Module A, the other module in the first stream, is also protected by the arbitrary-level synchronization.

Global-Level Synchronization

Global-level synchronization protects the entire STREAMS.

Note: This level can be useful for debugging purposes, but should not be used otherwise.

Per-stream Synchronization

Synchronization levels take all their signification in multiprocessor systems. In a uniprocessor system, the benefit of synchronization is reduced; and sometimes it is better to provide serialization rather than concurrent execution. The per-stream synchronization provides this serialization on a whole stream and can be applied only if the whole stream accepts to run on this mode. Two conditions are required for a module or driver to run at per-stream-synchronization level:

- The **STR_PERSTREAM** flag must be set when calling the **str_install** utility.
- Either the queue level or the queue pair-level synchronization must be set when calling the **str_install** utility.

If a module that does not support the per-stream synchronization is pushed in the stream, then all other modules and drivers will be reset to their original synchronization level (queue level or the queue-pair level).

In the same way, if a module that was not supporting the per-stream synchronization is popped out of the stream, a new check of the stream is done to see if it now deals with a per-stream synchronization.

Queue-Welding Mechanism

The STREAMS synchronization-queueing mechanism allows only one queue to be accessed at any one time. In some cases, however, it is necessary for a thread to establish queue connections between modules that are not in the same stream.

These queue connections (welding mechanism) are especially useful for STREAMS multiplexing and for echo-like STREAMS drivers.

Welding Queues

STREAMS uses a special synchronization queue for welding queues. As for individual queue synchronization, the welding and unwelding requests are queued. The actual operation is done safely by STREAMS, without any risk of deadlocks.

The **weldq** and **unweldq** utilities, respectively, establish and remove connections between one or two pairs of module or driver queues. Because the actual operation is done asynchronously, the utilities specify a callback function and its argument. The callback function is typically the **qenable** utility or the **e_wakeup** kernel service.

During the welding or unwelding operation, both pairs of queues are acquired, as shown in the STREAMS Queue-Welding Synchronization figure (Figure 39). However, it may be necessary to prevent another queue, queue pair, module, or group of modules from being accessed during the operation. Therefore, an additional queue can be specified when calling the **weldq** or **unweldq** utility; this queue will also be acquired during the operation. Depending on the synchronization level of the module to which this queue belongs, the queue, the queue pair, the module instance, all module instances, or an arbitrary group of modules will be acquired.

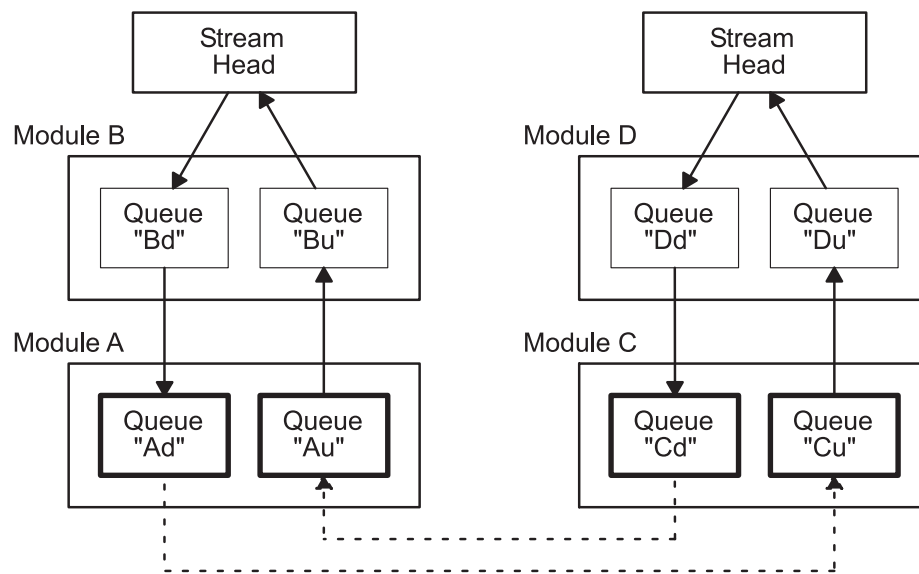

STREAMS Queue-Welding Synchronization

Figure 39. STREAMS Queue-Welding Synchronization. This diagram shows two streams side-by-side, each acquiring a queue from the other. The first stream (on the left) contains two modules with two queues each, as follows (from the top): Module B with Queue "Bd" and Queue "Bu", as well as Module A with Queues "Ad" and "Au". The second stream contains two modules with two queues each as follows (from the top): Module D with Queue "Dd" and Queue "Du", as well as Module C with Queues "Cd" and "Cu". A dotted arrow leads from Queue "Ad" to Queue "Cu". Another dotted arrow leads from Queue "Cd" to Queue "Au". The four queues involved are highlighted; they are Queues "Ad", "Cu", "Cd", and "Au".

For example, in the Queue Welding Using an Extra Queue figure (Figure 40 on page 264), the welding is done using the queue Bd as an extra synchronization queue. Module B is synchronized at module level.

Therefore, the queues Ad, Au, Cd, and Cu and all instances of module B will all be acquired for performing the weld operation.

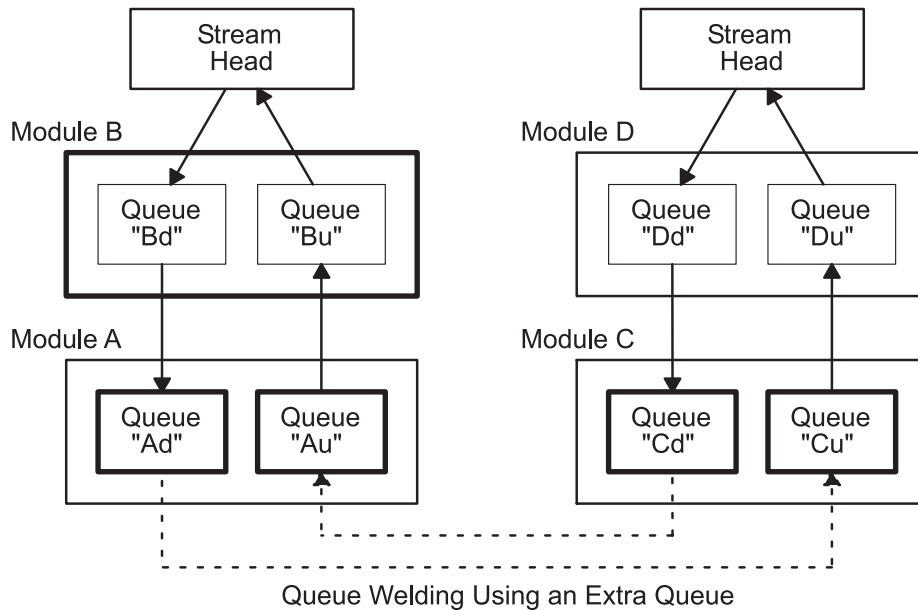

Figure 40. Queue Welding Using an Extra Queue. This diagram shows two streams side-by-side. The first stream (on the left) contains two modules with two queues each, as follows (from the top): Module B with Queue "Bd" and Queue "Bu", as well as Module A with Queue "Ad" and "Au". The second stream contains two modules with two queues each as follows (from the top): Module D with Queue "Dd" and Queue "Du", as well as Module C with Queue "Cd" and "Cu". A dotted arrow leads from Queue "Ad" to Queue "Cu". Another dotted arrow leads from Queue "Cd" to Queue "Au". The module and four queues involved are highlighted; they are Module B as well as Queues "Ad", "Cu", "Cd", and "Au".

Using STREAMS

Applications programmers can take advantage of the STREAMS facilities by using a set of system calls, subroutines, utilities, and operations (see "List of STREAMS Programming References" on page 289). The subroutine interface is upward-compatible with the existing character I/O facilities.

Subroutines

The **open**, **close**, **read**, and **write** subroutines support the basic set of operations on streams. In addition, new operations support advanced STREAMS facilities.

The **poll** subroutine enables an application program to poll multiple streams for various events. When used with the **I_SETSIG** operation, the **poll** subroutine allows an application to process I/O in an asynchronous manner.

The following is a set of STREAMS-related subroutines:

open	Opens a stream to the specified driver.
close	Closes a stream.
read	Reads data from a stream. Data is read in the same manner as character files and devices.
write	Writes data to a stream. Data is written in the same manner as character files and devices.
poll	Notifies the application program when selected events occur on a stream.

System Calls

The **putmsg** and **getmsg** system calls enable application programs to interact with STREAMS modules and drivers through a service interface.

getmsg	Receives the message at the stream head.
getpmsg	Receives the priority message at the stream head.
putmsg	Sends a message downstream.
putpmsg	Sends a priority message downstream.

streamio Operations

After a stream has been opened, `ioctl` operations allow a user process to insert and delete (push and pop) modules. That process can then communicate with and control the operation of the stream head, modules, and drivers, and can send and receive messages containing data and control information.

ioctl Controls a stream by enabling application programs to perform functions specific to a particular device. A set of generic STREAMS `ioctl` operations (referred to as **streamio** operations) support a variety of functions for accessing and controlling streams.

STREAMS Tunable Parameters

Certain system parameters referenced by STREAMS are configurable during system boot or while the system is running. These parameters are tunable based on requirements. There are two types of STREAMS tunable parameters: load-time configurable and run-time configurable parameters. At boot time, the **strload** command loads the STREAMS framework in the operating system kernel. This command is used to set both types of parameters using a configuration file. To configure the run-time parameters, use the **no** command. The **no** command also displays all the parameter values. See the **no** command description in *AIX 5L Version 5.3 Commands Reference* for more information.

Load-Time Parameters

The load-time parameters can only be set at initial STREAMS load time. The **strload** command reads the parameter names and values from the `/etc/pse_tune.conf` file. This file can be modified by privileged users only. It contains parameter names and values in the following format:

```
# Streams Tunable Parameters
#
# This file contains Streams tunable parameter values.
# The initial values are the same as the default values.
# To change any parameter, modify the parameter value and
# the next system reboot will make it effective.
# To change the run-time parameter, use the no command any time.
strmsgsz      0          # run-time parameter
strctlsz     1024       # run-time parameter
nstrpush      8          # load-time parameter
psetimers    20         # run-time parameter
psebufcalls   20         # run-time parameter
strturncnt   15         # run-time parameter
strthresh    85         # run-time parameter, 85% of "thewall"
lowthresh    90         # tun-time parameter, 90% of "thewall"
medthresh    95         # run-time parameter, 95% of "thewall"
pseintrstack 12288      # load-time parameter, (3 * 4096)
```

The initial values are the same as the default values. If the user changes any values, they are effective on the next system reboot. If this file is not present in the system or if it is empty, the **strload** command will not fail, and all the parameters are set to their default values.

The load-time parameters are as follows:

nstrpush Indicates the maximum number of modules that can be pushed onto a single STREAM. The default value is 8.

psetintrstack Indicates the maximum number of the interrupt stack size allowed by STREAMS while running in the offlevel. Sometimes, when a process, running other than INTBASE level, enters a STREAM, it encounters stack overflow problems because of not enough interrupt stack size. Tuning this parameter properly reduces the chances of stack overflow problems. The default value is 0x3000 (decimal 12288).

Run-Time Parameters

These parameters can be set using the **no -o** command or the **no -d** command, and they become effective immediately. If a user tries to set a load-time parameter to its default value or to a new value using the **no** command, it returns an error. The **no -a Parameter** and **no -o Parameter** commands show the parameter's current value.

The run-time parameters are as follows:

<i>strmsgsz</i>	Specifies the maximum number of bytes that a single system call can pass to a STREAM to be placed into the data part of a message (in M_DATA blocks). Any write subroutine exceeding this size will be broken into multiple messages. A putmsg subroutine with a data part exceeding this size will fail returning an ERANGE error code. The default value is 0.
<i>strctlsz</i>	Specifies the maximum number of bytes that a single system call can pass to a STREAM to be placed into the control part of a message (in an M_PROTO or M_PCPROTO block). A putmsg subroutine with a control part exceeding this size will fail returning an ERANGE error code. The default value is 1024.
<i>strthresh</i>	Specifies the maximum number of bytes STREAMS are allowed to allocate. When the threshold is passed, users without the appropriate privilege will not be allowed to open STREAMS, push modules, or write to STREAMS devices. The ENOSR error code is returned. The threshold applies only to the output side; therefore, data coming into the system is not affected and continues to work properly. A value of 0 indicates there is no threshold. The <i>strthresh</i> parameter represents a percentage of the value of the <i>thewall</i> parameter, and its value can be set between 0 and 100, inclusively. The <i>thewall</i> parameter indicates the maximum number of bytes that can be allocated by STREAMS and sockets using the net_malloc subroutine. The user can change the value of the <i>thewall</i> parameter using the no command. When the user changes the value of the <i>thewall</i> parameter, the threshold gets updated accordingly. The default value is 85, indicating the threshold is 85% of the value of the <i>thewall</i> parameter.
<i>psetimers</i>	Specifies the maximum number of timers allocated. In the operating system, the STREAM subsystem allocates a certain number of timer structures at initialization time, so the STREAMS driver or module can register the timeout requests. Lowering this value is not allowed until the system reboots, at which time it returns to its default value. The default value is 20.
<i>psebufcalls</i>	Specifies the maximum number of bufcalls allocated. In the operating system, the STREAM subsystem allocates a certain number of bufcall structures at initialization time. When an allocb subroutine fails, the user can register requests for the bufcall subroutine. Lowering this value is not allowed until the system reboots, at which time it returns to its default value. The default value is 20.
<i>strturncnt</i>	Specifies the maximum number of requests handled by the currently running thread for module- or elsewhere-level STREAMS synchronization. The module-level synchronization works in such a way that only one thread can run in the module at any given time, and all other threads trying to acquire the same module enqueue their requests and exit. After the currently running thread completes its work, it dequeues all the previously enqueued requests one at a time and starts them. If there are large numbers of requests enqueued in the list, the currently running thread must serve everyone. To eliminate this problem, the currently running thread serves only the <i>strturncnt</i> number of threads. After that, a separate kernel thread starts all the pending requests. The default value is 15.
<i>lowthresh</i>	Specifies the maximum number of bytes (in percentage) allocated by the <i>thewall</i> parameter using allocb for the BPRI_LO priority. When the total amount of memory allocated by the net_malloc subroutine reaches this threshold, the allocb request for the BPRI_LO priority returns 0. The <i>lowthresh</i> parameter can be set to any value between 0 and 100, inclusively. The default value is 90, indicating the threshold is at 90% of the value of the <i>thewall</i> parameter.

medthresh

Specifies the maximum number of bytes (in percentage) allocated by the *thewall* parameter using **allocb** for the BPRI_MED priority. When the total amount of memory allocated by the **net_malloc** subroutine reaches this threshold, the **allocb** request for the BPRI_MED priority returns 0. The *medthresh* parameter can be set to any value between 0 and 100, inclusively. The default value is 95, indicating the threshold is 95% of the value of the *thewall* parameter.

streamio (STREAMS ioctl) Operations

The **streamio** operations are a subset of ioctl operations that perform a variety of control functions on streams.

Because these STREAMS operations are a subset of the ioctl operations, they are subject to the errors described there. In addition to those errors, the call fails with the **errno** global variable set to **EINVAL**, without processing a control function, if the specified stream is linked below a multiplexor, or if the specified operation is not valid for a stream.

Also, as described in the ioctl operations, STREAMS modules and drivers can detect errors. In this case, the module or driver sends an error message to the stream head containing an error value. This causes subsequent system calls to fail with the **errno** global variable set to this value.

Building STREAMS

A stream is created on the first **open** subroutine to a character special file corresponding to a STREAMS driver.

A stream is usually built in two steps. Step one creates a minimal stream consisting of just the stream head (see “Stream Head” on page 252) and device driver, and step two adds modules to produce an expanded stream (see “Expanded Streams” on page 268) as shown in the Stream Setup diagram (Figure 41). Modules which can be added to a stream are known as pushable modules (see “Pushable Modules” on page 269).

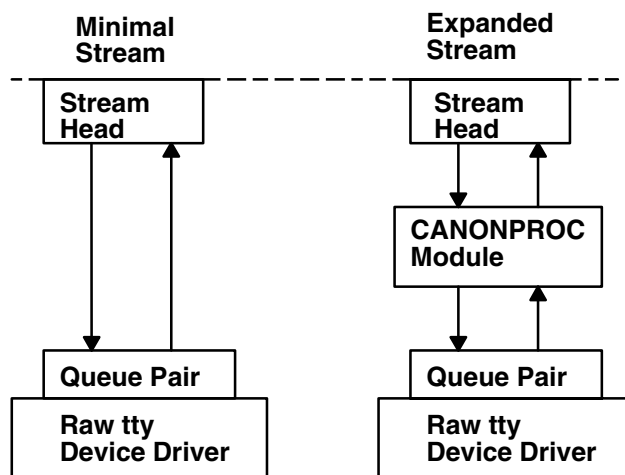

Stream Setup

Figure 41. Stream Setup. This diagram shows minimal stream setup on the left. The stream head is transmitting and receiving communication from the queue pair which sits on top of the raw tty device driver. The expanded stream on the right has a CANONPROC module between the queue pair and stream head. There is two-way communication between CANONPROC and the stream head and the queue pair.

The first step in building a stream has three parts:

1. Allocate and initialize head and driver structures.
2. Link the modules in the head and end to each other to form a stream.
3. Call the driver open routine.

If the driver performs all character and device processing required, no modules need to be added to a stream. Examples of STREAMS drivers include a raw tty driver (one that passes along input characters without change) and a driver with multiple streams open to it (corresponding to multiple minor devices opened to a character device driver).

When the driver receives characters from the device, it places them into messages. The messages are then transferred to the next stream component, the stream head, which extracts the contents of the message and copies them to user space. Similar processing occurs for downstream character output; the stream head copies data from user space into messages and sends them to the driver.

Expanded Streams

As the second step in building a stream, modules can be added to the stream. In the right-hand stream in the Stream Setup diagram (Figure 41 on page 267), the CANONPROC module was added to provide additional processing on the characters sent between head and driver.

Modules are added and removed from a stream in last-in-first-out (LIFO) order. They are inserted and deleted at the stream head by using ioctl operations. In the stream on the left of the Module Reusability diagram (Figure 42), the Class 1 Transport was added first, followed by the Canonical modules. To replace the Class 1 module with a Class 0 module, the Canonical module would have to be removed first, and then the Class 1 module. Finally, a Class 0 module would be added and the Canonical module put back.

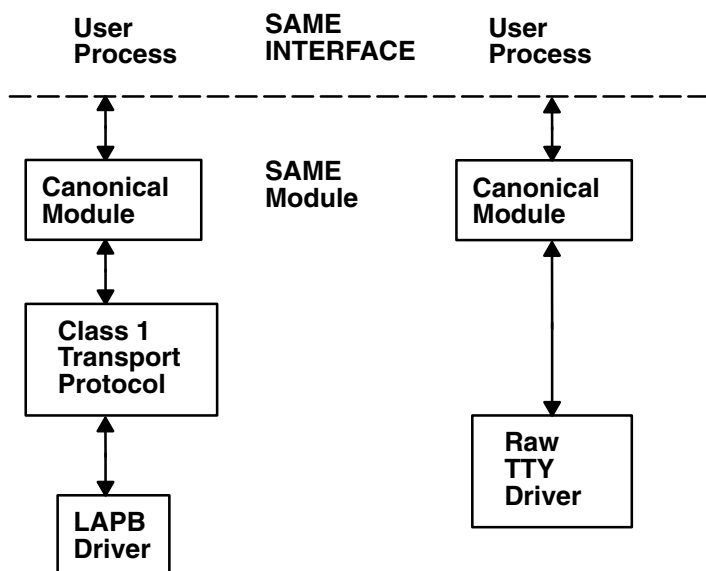

Module Reusability Diagram

Figure 42. Module Reusability. This diagram shows the user process on the left where the canonical module has two-way communication with the boarder of the SAME module and SAME interface. The canonical module also has two-way communication with the class 1 transport protocol. There is also two-way communication from the transport protocol to the LAPB (link-access procedure balanced) driver. The second stream user process on the right shows a canonical module which has two-way communication with the boarder of the SAME module and SAME interface. The canonical module also has two-way communication with the raw tty driver.

Because adding and removing modules resembles stack operations, an add routine is called a *push* and the remove routine is called a *pop*. **I_PUSH** and **I_POP** are two of the operations included in the STREAMS subset of ioctl operations (the **streamio** operations). These operations perform various manipulations of streams. The modules manipulated in this manner are called *pushable modules*, in

contrast to the modules contained in the stream head and stream end. This stack terminology applies only to the setup, modification, and breakdown of a stream.

Note: Subsequent use of the word *module* will refer to those pushable modules between stream head and stream end.

The stream head processes the **streamio** operation and executes the push, which is analogous to opening the stream driver. Modules are referenced by a unique symbolic name, contained in the STREAMS **fmodsw** module table (similar to the **devsw** table associated with a device file). The module table and module name are internal to STREAMS and are accessible from user space only through STREAMS **ioctl** subroutines. The **fmodsw** table points to the module template in the kernel. When a module is pushed, the template is located, the module structures for both QUEUES are allocated, and the template values are copied into the structures.

In addition to the module elements, each module contains pointers to an open routine and a close routine. The open routine is called when the module is pushed, and the close routine is called when the module is popped. Module open and close procedures are similar to a driver open and close.

As in other files, a STREAMS file is closed when the last process open to it closes the file by the **close** subroutine. This subroutine causes the stream to be dismantled (that is, modules are popped and the driver close routine is executed).

Pushable Modules

Modules are pushed onto a stream to provide special functions and additional protocol layers. In the Stream Set Up diagram (Figure 41 on page 267), the stream on the left is opened in a minimal configuration with a raw tty driver and no other module added. The driver receives one character at a time from the device, places the character in a message, then sends the message upstream. The stream head receives the message, extracts the single character, then copies it into the reading process buffer to send to the user process in response to the **read** subroutine. When the user process wants to send characters back to the driver, it issues the **write** subroutine, and the characters are sent to the stream head. The head copies the characters into one or more multiple-character messages and sends these messages downstream. An application program requiring no further kernel character processing would use this minimal stream.

A user requiring a more terminal-like interface would need to insert a module to perform functions such as echoing, character-erase, and line-kill. Assuming that the CANONPROC module shown in the Stream Set Up diagram (Figure 41 on page 267) fulfills this need, the application program first opens a raw tty stream. Then the CANONPROC module is pushed above the driver to create an expanded stream of the form shown on the right of the diagram. The driver is not aware that a module has been placed above it and therefore continues to send single character messages upstream. The module receives single-character messages from the driver, processes the characters, then accumulates them into line strings. Each line is placed into a message then sent to the stream head. The head now finds more than one character in the messages it receives from downstream.

Stream head implementation accommodates this change in format automatically and transfers the multiple-character data into user space. The stream head also keeps track of messages partially transferred into user space (for example, when the current user read buffer can only hold part of the current message). Downstream operation is not affected: the head sends, and the driver receives, multiple-character messages.

The stream head provides the interface between the stream and user process. Modules and drivers do not have to implement user interface functions other than the **open** and **close** subroutines.

STREAMS Messages

STREAMS provides a basic message-passing scheme based on the following concepts:

- “Message Blocks”
- “Message Allocation” on page 271
- “Message Types” on page 271
- “Message Queue Priority” on page 272
- “Sending and Receiving Messages” on page 273
- “Put Procedures” on page 273
- “Service Procedures” on page 274

Message Blocks

A STREAMS message consists of one or more linked message blocks. That is, the first message block of a message may be attached to other message blocks that are part of the same message. Multiple blocks in a message can occur, for example, as the result of processing that adds header or trailer data to the data contained in the message, or because of size limitations in the message buffer that cause the data to span multiple blocks. When a message is composed of multiple message blocks, the message type of the first block determines the type of the entire message, regardless of the types of the attached message blocks.

STREAMS allocates a message as a single block containing a buffer of a certain size. If the data for a message exceeds the size of the buffer containing the data, the procedure can allocate a new block containing a larger buffer, copy the current data to it, insert the new data, and deallocate the old block. Alternatively, the procedure can allocate an additional (smaller) block, place the new data in the new message block, and link it after or before the initial message block. Both alternatives yield one new message.

Messages can exist standalone when the message is being processed by a procedure. Alternatively, a message can await processing on a linked list of messages, called a *message queue*, in a QUEUE. In the Message Queue diagram (Figure 43 on page 271), Message 1 is linked to Message 2.

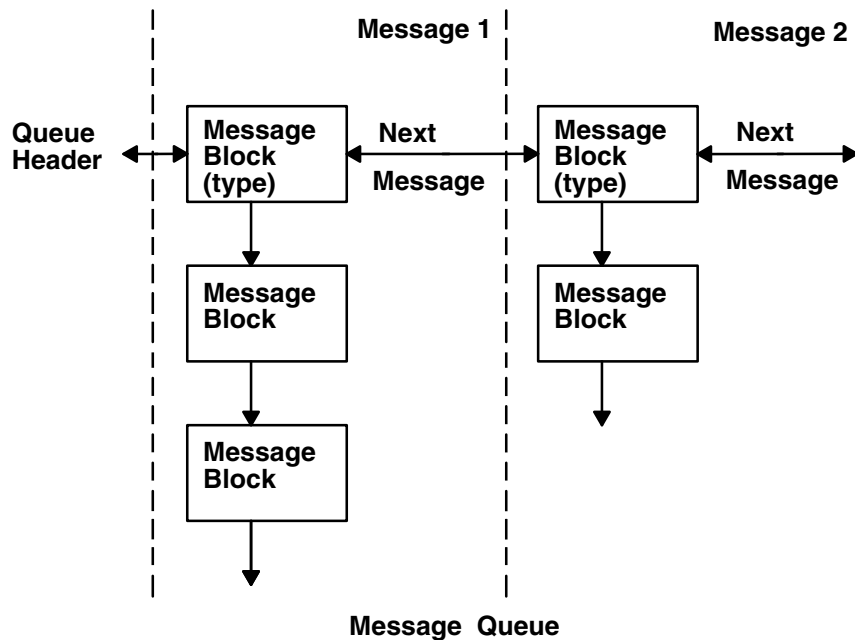

Figure 43. Message Queue. This diagram shows the queue header on the left which is bordered by message 1. The message block (type) in message 1 has a two-way arrow connected to the queue header and also another two-way arrow to the message block in message 2. Below this message block (type) an arrow points to another message block and that block, in turn, points to another message block within the message 1 area. The lowest message block has an arrow that points downward. To the right of message 1, is message 2. A two-way arrow exits the message block (type) on the right and continues to the next message. Below the message block (type) of message 2, an arrow points to a message block. That message block has an arrow that points downward.

When a message is queued, the first block of the message contains links to preceding and succeeding messages on the same message queue, in addition to containing a link to the second block of the message (if present). The message queue head and tail are contained in the QUEUE.

STREAMS utility routines enable developers to manipulate messages and message queues.

Message Allocation

STREAMS maintains its own storage pool for messages. A procedure can request the allocation of a message of a specified size at one of three message pool priorities. The **allocb** utility returns a message containing a single block with a buffer of at least the size requested, provided there is a buffer available at the priority requested. When requesting priority for messages, developers must weigh the process' need for resources against the needs of other processes on the same machine.

Message Types

All STREAMS messages are assigned message types to indicate their intended use by modules and drivers and to determine their handling by the stream head. A driver or module can assign most types to a message it generates, and a module can modify a message type during processing. The stream head will convert certain system calls to specified message types and send them downstream. It will also respond to other calls by copying the contents of certain message types that were sent upstream. Messages exist only in the kernel, so a user process can only send and receive buffers. The process is not explicitly aware of the message type, but it may be aware of message boundaries, depending on the system call used (see the distinction between the **getmsg** system call and the **read** subroutine in "Sending and Receiving Messages" on page 273).

Most message types are internal to STREAMS and can only be passed from one STREAMS module to another. A few message types, including M_DATA, M_PROTO, and M_PCPROTO, can also be passed between a stream and user processes. M_DATA messages carry data both within a stream and between a

stream and a user process. M_PROTO and M_PCPROTO messages carry both data and control information. However, the distinction between control information and data is generally determined by the developer when implementing a particular stream. Control information includes two types of information: service interface information and condition or status information. Service interface information is carried between two stream entities that present service interfaces. Condition or status information can be sent between any two stream entities regardless of their interface. An M_PCPROTO message has the same general use as an M_PROTO message, but the former moves faster through a stream.

Message Queue Priority

The STREAMS scheduler operates strictly in a first-in-first-out (FIFO) manner so that each QUEUE service procedure receives control in the order it was scheduled. When a service procedure receives control, it may encounter multiple messages on its message queue. This buildup can occur if there is a long interval between the time a message is queued by a put procedure and the time that the STREAMS scheduler calls the associated service procedure. In this interval, there can be multiple calls to the put procedure causing multiple messages. The service procedure processes all messages on its message queue unless prevented by flow control. Each message must pass through all the modules connecting its origin and destination in the stream.

If service procedures were used in all QUEUES and there was no message priority, the most recently scheduled message would be processed after all the other scheduled messages on all streams had been processed. In certain cases, message types containing urgent information (such as a break or alarm condition) must pass through the stream quickly. To accommodate these cases, STREAMS assigns priorities to the messages. These priorities order the messages on the queue. Each message has a priority band associated with it. Ordinary messages have a priority of 0. Message priorities range from 0 (ordinary) to 255 (highest). This provides up to 256 bands of message flow within a stream. (See Figure 44.)

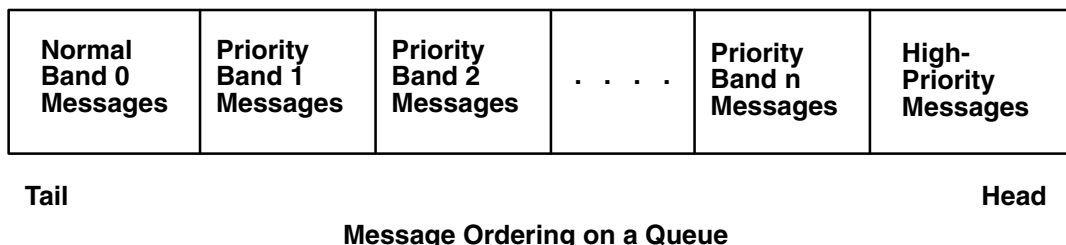

Figure 44. Message Ordering on a Queue. This diagram shows the head of the continuum of message ordering on the right and the tail on the left. At the head, are high-priority messages, followed by priority band n messages. The next box of dots represent all bands between n and 2. Following (to the left) are priority band 2 messages and priority band 1 messages. On the tail (left) end are normal band 0 messages.

High-priority messages are not affected by flow control. Their priority band is ignored. The **putq** utility places high priority messages at the head of the message queue, followed by priority band messages and ordinary messages. STREAMS prevents high-priority messages from being blocked by flow control and causes a service procedure to process them ahead of all other messages on the procedure queue. This procedure results in the high-priority message moving through each module with minimal delay.

Message queues are generally not present in a QUEUE unless that QUEUE contains a service procedure. When a message is passed to the **putq** utility to schedule the message for service procedure processing, the **putq** utility places the message on the message queue in order of priority. High-priority messages are placed ahead of all ordinary messages, but behind any other high-priority messages on the queue. Other messages are placed after messages of the same priority that are already on the queue. STREAMS utilities deliver the messages to the processing service procedure in a FIFO manner within each priority band. The service procedure is unaware of the message priority and receives the next message.

Message priority is defined by the message type; after a message is created, its priority cannot be changed. Certain message types come in equivalent high/ordinary priority pairs (for example, M_PCPROTO and M_PROTO), so that a module or device driver can choose between the two priorities when sending information.

Sending and Receiving Messages

The **putmsg** system call is a STREAMS-related system call that sends messages. It is similar to the **write** subroutine. The **putmsg** system call provides a data buffer that is converted into an M_DATA message. The system call can also provide a separate control buffer to be placed into an M_PROTO or M_PCPROTO block. The **write** subroutine provides byte-stream data to be converted into M_DATA messages.

The **getmsg** system call is a STREAMS-related system call that accepts messages. It is similar to the **read** subroutine. One difference between the two calls is that the **read** subroutine accepts only data (messages sent upstream to the stream head as message type M_DATA), such as the characters entered from the terminal. The **getmsg** system call can simultaneously accept both data and control information (that is, a message sent upstream as type M_PROTO or M_PCPROTO). The **getmsg** system call also differs from the **read** subroutine in that it preserves message boundaries so that the same boundaries exist above and below the stream head (that is, between a user process and a stream). The **read** subroutine generally ignores message boundaries, processing data as a byte stream.

Certain **streamio** operations, such as the **I_STR** operation, also cause messages to be sent or received on the stream. The **I_STR** operation provides the general ioctl capability of the character input/output subsystem. A user process above the stream head can issue the **putmsg** system call, the **getmsg** system call, the **I_STR** operation, and certain other STREAMS-related functions. Other **streamio** operations perform functions that include changing the state of the stream head, pushing and popping modules, or returning special information.

In addition to message types that explicitly transfer data to a process, some messages sent upstream result in information transfer. When these messages reach the stream head, they are transformed into various forms and sent to the user process. The forms include signals, error codes, and call return values.

Put and Service Procedures

The procedures in the QUEUE are the software routines that process messages as they transit the QUEUE. The processing is generally performed according to the message type and can result in a modified message, new messages, or no message. A resultant message is generally sent in the same direction in which it was received by the QUEUE, but may be sent in either direction. A QUEUE always contains a put procedure and may also contain an associated service procedure.

Put Procedures

A put procedure is the QUEUE routine that receives messages from the preceding QUEUE in the stream. Messages are passed between QUEUES by a procedure in one QUEUE calling the put procedure contained in the following QUEUE. A call to the put procedure in the appropriate direction is generally the only way to pass messages between modules. (Unless otherwise indicated, the term *modules* implies a module, driver, and stream head.) QUEUES in pushable modules contain a put procedure. In general, there is a separate put procedure for the read and write QUEUES in a module because of the full-duplex operation of most streams.

A put procedure is associated with immediate (as opposed to deferred) processing on a message. Each module accesses the adjacent put procedure as a subroutine. For example, suppose that modA, modB, and modC are three consecutive modules in a stream, with modC connected to the stream head. If modA receives a message to be sent upstream, modA processes that message and then calls the modB put procedure. The modB procedure processes the message and then calls the modC put procedure. Finally, the modC procedure processes the message and then calls the stream-head put procedure.

Thus, the message will be passed along the stream in one continuous processing sequence. This sequence has the benefit of completing the entire processing in a short time with low overhead (subroutine calls). However, it may not be desirable to use this manner of processing if this sequence is lengthy and the processing is implemented on a system with multiple users. Using this manner of processing under those circumstances may be good for this stream but detrimental to other streams since they may have to wait a long time to be processed.

In addition, some situations exist where the put procedure cannot immediately process the message but must hold it until processing is allowed. The most typical examples of this are a driver (which must wait until the current output completes before sending the next message) and the stream head (which may have to wait until a process initiates the **read** subroutine on the stream).

Service Procedures

STREAMS allows a service procedure to be contained in each QUEUE, in addition to the put procedure, to address the above cases and for either purposes. A service procedure is not required in a QUEUE and is associated with deferred processing. If a QUEUE has both a put and service procedure, message processing will generally be divided between the procedures. The put procedure is always called first, from a preceding QUEUE. After the put procedure completes its part of the message processing, it arranges for the service procedure to be called by passing the message to the **putq** utility. The **putq** utility does two things: it places the message on the message queue of the QUEUE, and it links the QUEUE to the end of the STREAMS scheduling queue. When the **putq** utility returns to the put procedure, the procedure typically exits. Some time later, the service procedure will be automatically called by the STREAMS scheduler.

The STREAMS scheduler is separate and distinct from the system process scheduler. It is concerned only with QUEUES linked on the STREAMS scheduling queue. The scheduler calls the service procedure of the scheduled QUEUE one at a time, in a FIFO manner.

Having both a put and service procedure in a QUEUE enables STREAMS to provide the rapid response and the queuing required in systems with many users. The put procedure allows rapid response to certain data and events, such as software echoing of input characters. Put procedures effectively have higher priority than any scheduled service procedures. When called from the preceding STREAMS component, a put procedure starts before the scheduled service procedures of any QUEUE are started.

The service procedure implies message queuing. Queuing results in deferred processing of the service procedure, following all other QUEUES currently on the scheduling queue. For example, terminal output, input erase, and kill processing would typically be performed in a service procedure because this type of processing does not have to be as timely as echoing. Using a service procedure also allows processing time to be more evenly spread among multiple streams. As with the put procedure, there will generally be a separate service procedure for each QUEUE in a module. The flow-control mechanism uses the service procedures.

STREAMS Drivers and Modules

This section compares operational features of character I/O device drivers with STREAMS drivers and modules. It is intended for experienced developers of system character device drivers. The Drivers section includes a discussion of **clone** device drivers and the **log** device driver. The Modules section includes a discussion of the **timod** and the **tirdwr** modules. The 64-Bit Support section discusses the impact of 64-bit support on STREAMS drivers and modules.

Environment

No user environment is generally available to STREAMS module procedures and drivers. Exceptions are the module and driver open and close routines, both of which have access to the *u_area* of the calling process and both of which can sleep. Otherwise, a STREAMS driver, module put procedure, and module service procedure have no user context and can neither sleep nor access the *u_area*.

Multiple streams can use a copy of the same module (that is, the same `fmodsw`), each containing the same processing procedures. Therefore, modules must be reentrant, and care must be exercised when using global data in a module. Put and service procedures are always passed the address of the `QUEUE` (for example, in the Stream Detail diagram (Figure 32 on page 252), Au calls the Bu put procedure with Bu as a parameter). The processing procedure establishes its environment solely from the `QUEUE` contents, which is typically the private data (for example, state information).

Drivers

At the interface to hardware devices, character I/O drivers have interrupt entry points; at the system interface, those same drivers generally have direct entry points (routines) to process **open**, **close**, **read**, and **write** subroutines, and `ioctl` operations.

`STREAMS` device drivers have similar interrupt entry points at the hardware device interface and have direct entry points only for the **open** and **close** subroutines. These entry points are accessed using `STREAMS`, and the call formats differ from character device drivers. The put procedure is a driver's third entry point, but it is a message (not system) interface. The stream head translates **write** subroutines and `ioctl` operations into messages and sends them downstream to be processed by the driver's write `QUEUE` put procedure. The **read** subroutine is seen directly only by the stream head, which contains the functions required to process subroutines. A driver does not know about system interfaces other than the **open** and **close** subroutines, but it can detect the absence of a **read** subroutine indirectly if flow control propagates from the stream head to the driver and affects the driver's ability to send messages upstream.

For input processing, when the driver is ready to send data or other information to a user process, it does not wake up the process. It prepares a message and sends it to the read `QUEUE` of the appropriate (minor device) stream. The driver's open routine generally stores the `QUEUE` address corresponding to this stream.

For output processing, the driver receives messages from the stream head instead of processing a **write** subroutine. If a message cannot be sent immediately to the hardware, it may be stored on the driver's write message queue. Subsequent output interrupts can remove messages from this queue.

Drivers and modules can pass signals, error codes, and return values to processes by using message types provided for that purpose.

There are three special device drivers:

- clone** Finds and opens an unused minor device on another `STREAMS` driver.
- log** Provides an interface for the `STREAMS` error-logging and event-tracing processes.
- sad** Provides an interface for administrative operations.

Modules

Modules have user context available only during the execution of their open and close routines. Otherwise, the `QUEUES` forming the module are not associated with the user process at the end of the stream, nor with any other process. Because of this, `QUEUE` procedures must not sleep when they cannot proceed; instead, they must explicitly return control to the system. The system saves no state information for the `QUEUE`. The `QUEUE` must store this information internally if it is to proceed from the same point on a later entry.

When a module or driver that requires private working storage (for example, for state information) is pushed, the open routine must obtain the storage from external sources. `STREAMS` copies the module template from the `fmodsw` table for the **I_PUSH** operation, so only fixed data can be contained in the module template. `STREAMS` has no automatic mechanism to allocate working storage to a module when it is opened. The sources for the storage typically include either a module-specific kernel array, installed when the system is configured, or the `STREAMS` buffer pool. When using an array as a module storage

pool, the maximum number of copies of the module that can exist at any one time must be determined. For drivers, this is typically determined from the physical devices connected, such as the number of ports on a multiplexor. However, certain types of modules may not be associated with a particular external physical limit. For example, the CANONICAL module shown in the Module Reusability diagram (Figure 45) could be used on different types of streams.

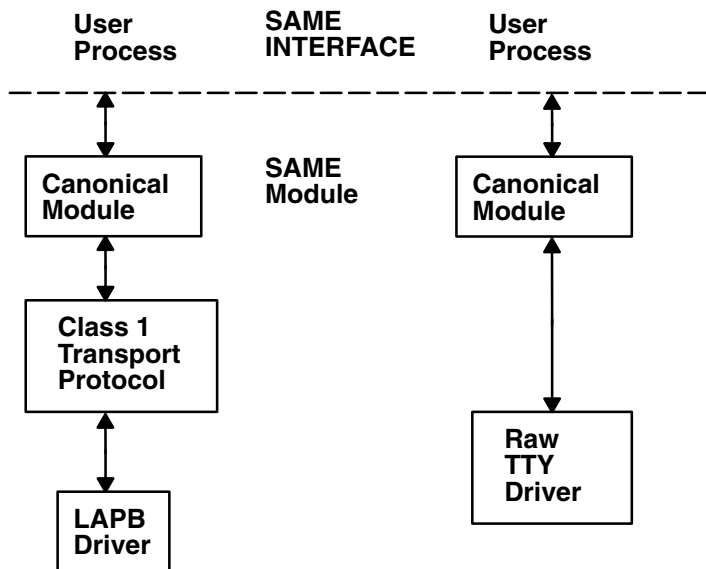

Module Reusability Diagram

Figure 45. Module Reusability. This diagram shows the user process on the left where the canonical module has two-way communication with the border of the SAME module and SAME interface. The canonical module also has two-way communication with the class 1 transport protocol. There is also two-way communication from the transport protocol to the LAPB (link-access procedure balanced) driver. The second stream user process on the right shows a canonical module which has two-way communication with the border of the SAME module and SAME interface. The canonical module also has two-way communication with the raw tty driver.

There are two special modules for use with the Transport Interface (TI) functions of the Network Services Library:

- timod** Converts a set of **ioctl** operations into STREAMS messages.
- tirdwr** Provides an alternate interface to a transport provider.

64-Bit Support

The STREAMS modules and drivers will set a new flag **STR_64BIT** in the **sc_flags** field of the **strconf_t** structure, to indicate their capability to support 64-bit data types. They will set this flag before calling the **str_install** subroutine.

At the driver open time, the stream head will set a per-stream 64-bit flag, if all **autopushed** modules (if any) and the driver support 64-bit data types. The same flag gets updated at the time of module push or pop, based on the module's 64-bit support capability. The system calls that pass data downstream in PSE, **putmsg** and **putpmsg**, will check this per-stream flag for that particular stream. Also, certain **ioctl** subroutines (such as **I_STR** and **I_STRFDINSERT**) and transparent **ioctls** will check this flag too. If the system call is issued by a 64-bit process and this flag is not set, the system call will fail. The 32-bit behavior is not affected by this flag. All of the present operating system Streams modules and drivers will support 64-bit user processes.

At link or unlink operation time, the stream head of upper half of the STREAMS multiplexor updates its per-stream 64-bit flag based on the flag value of the lower half stream head. For example, if the upper half

supports 64-bit and lower half does not, then the multiplexor will not support 64-bit processes. This is necessary because all the system calls are processed at the upper half of the multiplexor.

STREAMS Message Block MSG64BIT Flag

The STREAMS modules and drivers establish the 64-bit or 32-bit user process context by setting the message block flag (the `b_flag` field of `msgb` structure), **MSG64BIT**. This flag is set by the streams head when it allocates a message to process a system call from a 64-bit process. This flag is set for the **putmsg**, **putpmsg**, and **ioctl** system calls; for the **I_STR** and **I_STRFDINSERT** commands; and for transparent **ioctls**.

Transparent ioctls

The third argument of the transparent **ioctl** is a pointer to the data in user space to be copied in or out. This address is remapped properly by the **ioctl** system call. The streams driver or module passes **M_COPYIN** or **M_COPYOUT** messages to the stream head and the stream head calls the **copyin** or **copyout** subroutines.

If the third argument of the **ioctl** subroutine points to a structure that contains a pointer (for example, `ptr64`) or `long`, remapping is solved by a new structure, **copyreq64**, which contains a 64-bit user space pointer. If the message block flag is set to **MSG64BIT**, the driver or module will pass **M_COPYIN64** or **M_COPYOUT64** to copy in or out a pointer within a structure. In this case, the stream head will call **copyin64** or **copyout64** to move the data into or out of the user address space, respectively.

The **copyreq64** structure uses the last unused `cq_filler` field to store the 64-bit address. The **copyreq64** structure looks like the following example:

```
struct copyreq64 {
    int      cq_cmd;           /* command type == ioc_cmd */
    cred_t  *cq_cr;          /* pointer to full credentials*/
    int      cq_id;           /* ioctl id == ioc_id */
    ioc_pad  cq_ad;           /* addr to copy data to/from */
    uint     cq_size;         /* number of bytes to copy */
    int      cq_flag;         /* reserved */
    mblk_t  *cq_private;     /* module's private state info*/
    ptr64    cq_addr64;      /* 64-bit address */
    long     cq_filler[2];   /* reserved */
};
```

The `cq_addr64` field is added in the above structure and the size of the `cq_filler` is reduced, so overall size remains same. The driver or module first determines whether the **MSG64BIT** flag is set and, if so, stores the user-space 64-bit address in the `cq_addr64` field.

log Device Driver

The **log** driver is a STREAMS software device driver that provides an interface for the STREAMS error-logging and event-tracing processes. The **log** driver presents two separate interfaces:

- A function call interface in the kernel through which STREAMS drivers and modules submit **log** messages
- A subset of **ioctl** operations and STREAMS messages for interaction with a user-level error logger, a trace logger, or processes that need to submit their own **log** messages

Kernel Interface

The **log** messages are generated within the kernel by calls to the **strlog** utility.

User Interface

The **log** driver is opened using the clone interface, **/dev/slog**. Each open of **/dev/slog** obtains a separate stream to log. In order to receive **log** messages, a process must first notify the **log** driver whether it is an error logger or trace logger by using an **I_STR** operation.

For the error logger, the **I_STR** operation has an *ic_cmd* parameter value of **I_ERRLOG** with no accompanying data.

For the trace logger, the **I_STR** operation has an *ic_cmd* parameter value of **I_TRCLOG**, and must be accompanied by a data buffer containing an array of one or more **trace_ids** structures. Each **trace_ids** structure specifies a mid, sid, and level field from which messages are accepted. The **strlog** subroutine accepts messages whose values in the mid and sid fields exactly match those in the **trace_ids** structure, and whose level is less than or equal to the level given in the **trace_ids** structure. A value of -1 in any of the fields of the **trace_ids** structure indicates that any value is accepted for that field.

At most, one trace logger and one error logger can be active at a time. After the logger process has identified itself by using the **ioctl** operation, the **log** driver will begin sending messages, subject to the restrictions previously noted. These messages are obtained by using the **getmsg** system call. The control part of this message contains a **log_ctl** structure, which specifies the mid, sid, level, and flags fields, as well as the time in ticks since boot that the message was submitted, the corresponding time in seconds since Jan. 1, 1970, and a sequence number. The time in seconds since 1970 is provided so that the date and time of the message can be easily computed; the time in ticks since boot is provided so that the relative timing of **log** messages can be determined.

Different sequence numbers are maintained for the error-logging and trace-logging streams so that gaps in the sequence of messages can be determined. (During times of high message traffic, some messages may not be delivered by the logger to avoid tying up system resources.) The data part of the message contains the unexpanded text of the format string (null-terminated), followed by the arguments to the format string (up to the number specified by the **NLOGARGS** value), aligned on the first word boundary following the format string.

A process may also send a message of the same structure to the **log** driver, even if it is not an error or trace logger. The only fields of the **log_ctl** structure in the control part of the message that are accepted are the level and flags fields. All other fields are filled in by the **log** driver before being forwarded to the appropriate logger. The data portion must contain a null-terminated format string, and any arguments (up to **NLOGARGS**) must be packed one word each, on the next word boundary following the end of the format string.

Attempting to issue an **I_TRCLOG** or **I_ERRLOG** operation when a logging process of the given type already exists results in the **ENXIO** error being returned. Similarly, **ENXIO** is returned for **I_TRCLOG** operations without any **trace_ids** structures, or for any unrecognized **I_STR** operations. Incorrectly formatted log messages sent to the driver by a user process are silently ignored (no error results).

Examples

1. The following is an example of **I_ERRLOG** notification:

```
struct striocctl ioc;
ioc.ic_cmd = I_ERRLOG;
ioc.ic_timeout = 0;      /* default timeout (15 secs.)*/
ioc.ic_len = 0;
ioc.ic_dp = NULL;
ioctl(log, I_STR, &ioc);
```

2. The following is an example of **I_TRCLOG** notification:

```
struct trace_ids tid[2];
tid[0].ti_mid = 2;
tid[0].ti_sid = 0;
tid[0].ti_level = 1;
tid[1].ti_mid = 1002;
tid[1].ti_sid = -1; /* any sub-id will be allowed*/
tid[1].ti_level = -1; /* any level will be allowed*/
ioc.ic_cmd = I_TRCLOG;
```



```

ioc.ic_timeout = 0;
ioc.ic_len = 2 * sizeof(struct trace_ids);
ioc.ic_dp = (char *)tid;
ioctl(log, I_STR, &ioc);

```

3. The following is an example of submitting a log message (no arguments):

```

struct strbuf ctl, dat;
struct log_ctl lc;
char *message = "Honey, I'm working late again.";
ctl.len = ctl.maxlen = sizeof(lc);
ctl.buf = (char *)&lc;
dat.len = dat.maxlen = strlen(message);
dat.buf = message;
lc.level = 0
lc.flags = SL_ERRORS;
putmsg(log, &ctl, &dat, 0);

```

Configuring Drivers and Modules in the Portable Streams Environment

Portable Streams Environment (PSE) drivers and modules are dynamically loaded and unloaded. To support this feature, each driver and module must have a configuration routine that performs the necessary initialization and setup operations.

PSE provides the **strload** command to load drivers and modules. After loading the extension, the **strload** command calls the extension entry point using the **SYS_CFGDD** and **SYS_CFGKMOD** operations explained in the **sysconfig** subroutine section in *AIX 5L Version 5.3 Technical Reference*.

Each PSE kernel extension configuration routine must eventually call the **str_install** utility to link into STREAMS.

Commonly used extensions can be placed in a configuration file, which controls the normal setup and tear-down of PSE. The configuration file allows more flexibility when loading extensions by providing user-specified nodes and arguments. For a detailed description of the configuration file, see the **strload** command.

Loading and Unloading PSE

To load PSE using the default configuration, type the following command with no flags:

```
strload
```

To unload PSE, type the following command with the unload flag:

```
strload -u
```

Loading and Unloading a Driver or Module

PSE drivers and modules can be added and removed as necessary. This is especially helpful during development of new extensions. To load only a new driver, type the following command:

```
strload -d newdriver
```

To unload the driver, type:

```
strload -u -d newdriver
```

Modules can also be added and removed with the **strload** command by using the **-m** flag instead of the **-d** flag.

PSE Configuration Routines

To support dynamic loading and unloading, each PSE extension must provide a configuration routine. This routine is called each time the extension is referenced in a load or unload operation. Detailed information

about kernel extension configuration routines can be found in the **sysconfig** subroutine section in *AIX 5L Version 5.3 Kernel Extensions and Device Support Programming Concepts*. However, PSE requires additional logic to successfully configure an extension.

To establish the linkage between PSE and the extension, the extension configuration routine must eventually call the **str_install** utility. This utility performs the internal operations necessary to add or remove the extension from PSE internal tables.

The following code fragment provides an example of a minimal configuration routine for a driver called *dgb*. Device-specific configuration and initialization logic can be added as necessary. The *dgb_config* entry point defines and initializes the **strconf_t** structure required by the **str_install** utility. In this example, the **dgb_config** operation retrieves the argument pointed to by the *uiop* parameter and uses it as an example of usage. An extension may ignore the argument. The major number is required for drivers and is retrieved from the *dev* parameter. Because the **dgb** driver requires no initialization, its last step is to perform the indicated operation by calling the **str_install** utility. Other drivers may need to perform other initialization steps either before or after calling the **str_install** utility.

```
#include <sys/device.h>          /* for the CFG_* constants */
#include <sys/strconf.h>        /* for the STR_* constants */
dgb_config(dev, cmd, uiop)
    dev_t dev;
    int cmd;
    struct uio *uiop;
{
    char buf[FMNAMESZ+1];
    static strconf_t conf = {
        "dgb", &dgbinfo, STR_NEW_OPEN,
    };
    if (uiomove(buf, sizeof buf, UIO_WRITE, uiop))
        return EFAULT;
    buf[FMNAMESZ] = 0;
    conf.sc_name = buf;
    conf.sc_major = major(dev);
    switch (cmd) {
    case CFG_INIT: return str_install(STR_LOAD_DEV, &conf);
    case CFG_TERM: return str_install(STR_UNLOAD_DEV, &conf);
    default:      return EINVAL;
    }
}
```

A module configuration routine is similar to the driver routine, except a major number is not required and the calling convention is slightly different. The following code fragment provides an example of a minimal complete configuration routine:

```
#include <sys/device.h>
#include <sys/strconf.h>
/* ARGSUSED */
aoot_config(cmd, uiop)
    int cmd;
    struct uio *uiop;
{
    static strconf_t conf = {
        "aoot", &aootinfo, STR_NEW_OPEN,
    };
    /* uiop ignored */
    switch (cmd) {
    case CFG_INIT: return str_install(STR_LOAD_MOD, &conf);
    case CFG_TERM: return str_install(STR_UNLOAD_MOD, &conf);
    default:      return EINVAL;
    }
}
```

For the **strload** command to successfully install an extension, the configuration routine of each extension must be marked as the entry point. Assuming the extension exists in a file called **dgb.c**, and has a configuration routine named **dgb_config**, a PSE object named **dgb** can be created by the following commands:

```
cc -c dgb.c
ld -o dgb dgb.o -edgb_config -bimport:/lib/pse.exp -lcsys
```

A driver extension created in such a manner can be installed with the following command:

```
strload -d dgb
```

and removed with the following command:

```
strload -u -d dgb
```

Example Module

The following is a compilable example of a module called **pass**.

Note: Before it can be compiled, the code must exist in a file called **pass.c**.

```
#include <errno.h>
#include <sys/stream.h>

static int passclose(), passopen
(), passrput(), passwput();
static struct module_info minfo = { 0, "pass", 0, INFPSZ, 2048, 128 };
static struct qinit rinit = { passrput, 0, passopen, passclose, 0, &minfo };
static struct qinit winit = { passwput, 0, 0, 0, 0, &minfo };
struct streamtab passinfo = { &rinit, &winit };

static int
passclose (queue_t *q)
{
    return 0;
}

static int
passopen (queue_t *q, dev_t *devp, int flag, int sflag, cred_t *credp)
{
    return 0;
}

static int
passrput (queue_t *q, mblk_t *mp)
{
    putnext(q, mp);
    return 0;
}

static int
passwput (queue_t *q, mblk_t *mp)
{
    putnext(q, mp);
    return 0;
}

#include <sys/device.h>
#include <sys/strconf.h>

int
passconfig(int cmd, struct uio *uiop)
{
    static strconf_t conf = {
        "pass", &passinfo, STR_NEW_OPEN,
    };
}
```

```

switch (cmd) {
case CFG_INIT:   return str_install(STR_LOAD_MOD, &conf);
case CFG_TERM:  return str_install(STR_UNLOAD_MOD, &conf);
default:        return EINVAL;
}
}

```

The object named `pass` can be created using the following commands:

```

cc -c pass.c
ld -o pass pass.o -epass_config -bimport:/lib/pse.exp -lcsys

```

Use the following command to install the module:

```
strload -m pass
```

Use the following command to remove the module:

```
strload -u -m pass
```

An Asynchronous Protocol STREAMS Example

In this example, suppose that the computer supports different kinds of asynchronous terminals, each logging in on its own port. The port hardware is limited in function; for example, it detects and reports line and modem status, but does not check parity.

Communications software support for these terminals is provided using a STREAMS-implemented asynchronous protocol. The protocol includes a variety of options that are set when a terminal operator dials in to log on. The options are determined by a **getty**-type STREAMS user-written process, **getstrm**, which analyzes data sent to it through a series of dialogs (prompts and responses) between the process and terminal operator.

Note: The **getstrm** process used in this example is a nonexistent process. It is not supported by this system.

The process sets the terminal options for the duration of the connection by pushing modules onto the stream by sending control messages to cause changes in modules (or in the device driver) already on the stream. The options supported include:

- ASCII or EBCDIC character codes
- For ASCII code, the parity (odd, even, or none)
- Echoing or no echoing of input characters
- Canonical input and output processing or transparent (raw) character handling

These options are set with the following modules:

CHARPROC	Provides input character-processing functions, including dynamically settable (using control messages passed to the module) character echo and parity checking. The module default settings are meant to echo characters and do not check character parity.
CANONPROC	Performs canonical processing on ASCII characters upstream and downstream, this module performs some processing in a different manner from the standard character I/O tty subsystem.
ASCEBC	Translates EBCDIC code to ASCII, upstream, and ASCII to EBCDIC, downstream.

Note: The modules used in this example are nonexistent. They are not supported by this system.

Initializing the Stream

At system initialization a user-written process, **getstrm**, is created for each tty port. The **getstrm** process opens a stream to its port and pushes the **CHARPROC** module onto the stream by use of a **I_PUSH**

operation. Then, the process issues a **getmsg** system call to the stream and sleeps until a message reaches the stream head. The stream is now in its idle state.

The initial idle stream contains only one pushable module, CHARPROC. The device driver is a limited-function, raw tty driver connected to a limited-function communication port. The driver and port transparently transmit and receive one unbuffered character at a time.

Upon receipt of initial input from a tty port, the **getstrm** process establishes a connection with the terminal, analyzes the option requests, verifies them, and issues STREAMS subroutines to set the options. After setting up the options, the **getstrm** process creates a user application process. Later, when the user terminates that application, the **getstrm** process restores the stream to its idle state by use of subroutines.

The next step is to analyze in more detail how the stream sets up the communications options.

Using Messages in the Example

The **getstrm** process has issued a **getmsg** system call and is sleeping until the arrival of a message from the stream head. Such a message would result from the driver detecting activity on the associated tty port.

An incoming call arrives at port 1 and causes a ring-detect signal in the modem. The driver receives the ring signal, answers the call, and sends upstream an M_PROTO message containing information indicating an incoming call. The **getstrm** process is notified of all incoming calls, although it can choose to refuse the call because of system limits. In this idle state, the **getstrm** process will also accept M_PROTO messages indicating, for example, error conditions such as detection of line or modem problems on the idle line.

The M_PROTO message containing notification of the incoming call flows upstream from the driver into the CHARPROC module. The CHARPROC module inspects the message type, determines that message processing is not required, and passes the unmodified message upstream to the stream head. The stream head copies the message into the **getmsg** buffers (one buffer for control information, the other for data) associated with the **getstrm** process and wakes up the process. The **getstrm** process sends its acceptance of the incoming call with a **putmsg** system call, which results in a downstream M_PROTO message to the driver.

Then, the **getstrm** process sends a prompt to the operator with a **write** subroutine and issues a **getmsg** system call to receive the response. A **read** subroutine could have been used to receive the response, but the **getmsg** system call allows concurrent monitoring for control (M_PROTO and M_PCPROTO) information. The **getstrm** process will now sleep until the response characters, or information regarding possible error conditions detected by modules or driver, are sent upstream.

The first response, sent upstream in an M_DATA block, indicates that the code set is ASCII and that canonical processing is requested. The **getstrm** process implements these options by pushing the CANONPROC module onto the stream, above the CHARPROC module, to perform canonical processing on the input ASCII characters.

The response to the next prompt requests even-parity checking. The **getstrm** process sends an **I_STR** operation to the CHARPROC module, requesting the module to perform even-parity checking on upstream characters. When the dialog indicates that protocol-option setting is complete, the **getstrm** process creates an application process. At the end of the connection, the **getstrm** process will pop the CANONPROC module and then send an **I_STR** operation to the CHARPROC module requesting that module restore the no-parity idle state (the CHARPROC module remains on the stream).

As a result of the above dialogs, the terminal at port 1 operates in the following configuration:

- ASCII, even parity
- Echo
- Canonical processing

In similar fashion, an operator at a different type of terminal on port 2 requests a different set of options, resulting in the following configuration:

- EBCDIC
- No echo
- Canonical processing

The resultant streams for the two ports are shown in the Asynchronous Terminal STREAMS diagram (Figure 46). For port 1, the modules in the stream are CANONPROC and CHARPROC.

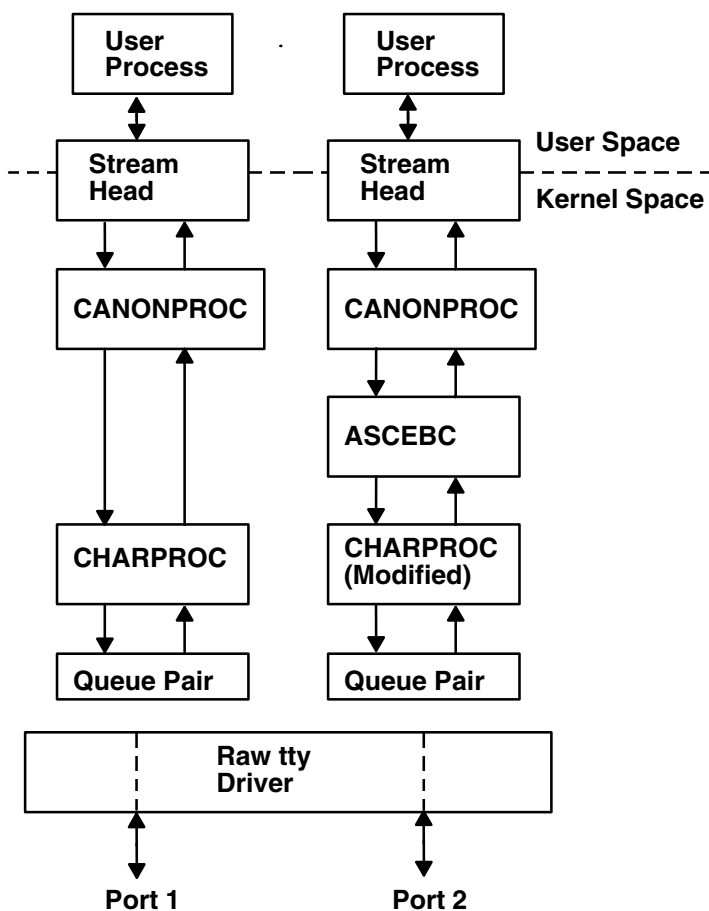

Asynchronous Terminal STREAMS

Figure 46. Asynchronous Terminal STREAMS. This diagram shows port 1 and port 2. Both streams have a user process in the user space. The processes receive and transmit to a stream head which extends from the user space into the kernel space. Each stream head transmits and receives a CANONPROC shown below it. In port 1, CANONPROC has a connection to and from CHARPROC, and CHARPROC receives and transmits to a queue pair below it. In port 2, CANONPROC receives and transmits to ASCEBC, and ASCEBC receives and transmits to a modified CHARPROC. This modified CHARPROC receives and transmits to a queue pair below it. Below the queue ports (yet unconnected from the queue pair) is a raw tty driver. Port 1 is on the left below the driver and port 2 is on the right. There are bidirectional arrows between the ports and the driver; dashed lines continue from these arrows through the driver.

For port 2, the resultant modules are CANONPROC, ASCEBC, and CHARPROC. The ASCEBC module has been pushed on this stream to translate between the ASCII interface at the downstream side of the CANONPROC module and the EBCDIC interface at the upstream output side of the CHARPROC module. In addition, the **getstrm** process has sent an **I_STR** operation to the CHARPROC module in this stream requesting it to disable echo. The resultant modification to the CHARPROC function is indicated by the word "modified" in the right stream of the diagram.

Because the CHARPROC module is now performing no function for port 2, it usually would be popped from the stream to be reinserted by the **getstrm** process at the end of the connection. However, the low overhead of STREAMS does not require its removal. The module remains on the stream, passing unmodified messages between the ASCEBC module and the driver. At the end of the connection, the **getstrm** process restores this stream to its idle configuration by popping the added modules and then sending an **I_STR** operation to the CHARPROC module to restore the echo default.

Note: The tty driver shown in the Asynchronous Terminal STREAMS diagram (Figure 46 on page 284) handles minor devices. Each minor device has a distinct stream connected from user space to the driver. This ability to handle multiple devices is a standard STREAMS feature, similar to the minor device mechanism in character I/O device drivers.

Other User Functions

The previous example illustrates basic STREAMS concepts. However, more efficient STREAMS calls or mechanisms could have been used in place of those described earlier.

For example, the initialization process that created a **getstrm** process for each tty port could have been implemented as a "supergetty" by use of the STREAMS-related **poll** subroutine. The **poll** subroutine allows a single process to efficiently monitor and control multiple streams. The "supergetty" process would handle all of the stream and terminal protocol initialization and would create application processes only for established connections.

Otherwise, the **M_PROTO** notification sent to the **getstrm** process could be sent by the driver as an **M_SIG** message that causes a specified signal to be sent to the process. Error and status information can also be sent upstream from a driver or module to user processes using different message types. These messages will be transformed by the stream head into a signal or error code.

Finally, a **I_STR** operation could be used in place of a **putmsg** system call **M_PROTO** message to send information to a driver. The sending process must receive an explicit response from an **I_STR** operation by a specified time period, or an error will be returned. A response message must be sent upstream by the destination module or driver to be translated into the user response by the stream head.

Kernel Processing

This section describes STREAMS kernel operations and associates them, where relevant, with user-level system calls. As a result of initializing operations and pushing a module, the stream for port 1 has the configuration shown in the Operational Stream diagram (Figure 47 on page 286).

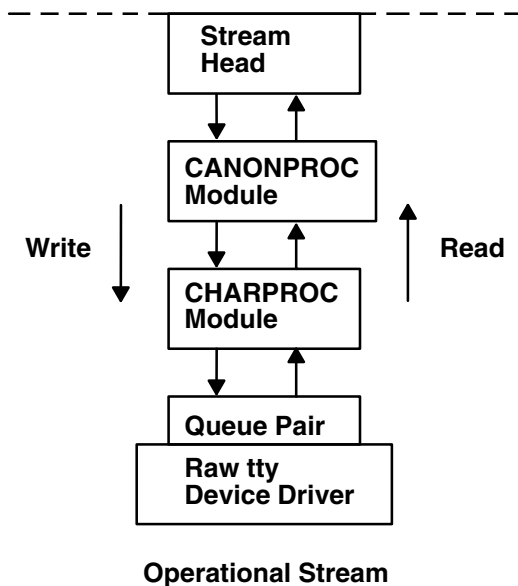

Figure 47. Operational Stream. This diagram shows the raw tty device driver and the queue pair joined. The CHARPROC module is above the queue pair and the CANONPROC module is between the stream head (at the top of the kernel space) and CHARPROC. The modules have the same communication arrows as used in the previous diagram. The upstream queue or read queue is on the right (signified by the upward arrow) while the downstream queue or write queue is on the left (signified by the downward arrow).

Here the upstream QUEUE is also referred to as the read QUEUE, reflecting the message flow in response to a **read** subroutine. The downstream QUEUE is referred to as the write QUEUE.

Read-Side Processing

In the example, read-side processing consists of driver processing, CHARPROC processing, and CANONPROC processing.

Driver Processing: In the example, the user process has blocked on the **getmsg** subroutine while waiting for a message to reach the stream head, and the device driver independently waits for input of a character from the port hardware or for a message from upstream. Upon receipt of an input character interrupt from the port, the driver places the associated character in an M_DATA message, allocated previously. Then, the driver sends the message to the CHARPROC module by calling the CHARPROC upstream put procedure. On return from the CHARPROC module, the driver calls the **allocb** utility routine to get another message for the next character.

CHARPROC: The CHARPROC module has both put and service procedures on its read side. As a result, the other QUEUES in the modules also have put and service procedures.

When the driver calls the CHARPROC read-QUEUE put procedure, the procedure checks private data flags in the QUEUE. In this case, the flags indicate that echoing is to be performed (recall that echoing is optional and that you are working with port hardware that cannot automatically echo). The CHARPROC module causes the echo to be transmitted back to the terminal by first making a copy of the message with a STREAMS utility. Then, the CHARPROC module uses another utility to obtain the address of its own write QUEUE. Finally, the CHARPROC read put procedure calls its write put procedure and passes it the message copy. The write procedure sends the message to the driver to effect the echo and then returns to the read procedure.

This part of read-side processing is implemented with put procedures so that the entire processing sequence occurs as an extension of the driver input-character interrupt. The CHARPROC read and write put procedures appear as subroutines (nested in the case of the write procedure) to the driver. This manner of processing is intended to produce the character echo in a minimal time frame.

After returning from echo processing, the CHARPROC read put procedure checks another of its private data flags and determines that parity checking should be performed on the input character. Usually, parity would be checked as part of echo processing. However, for this example, parity is checked only when the characters are sent upstream. As a result, parity checking can be deferred along with the canonical processing. The CHARPROC module uses the **putq** utility to schedule the (original) message for parity-check processing by its read service procedure. When the CHARPROC read service procedure is complete, it forwards the message to the read put procedure of the CANONPROC module. If parity checking were not required, the CHARPROC put procedure would call the CANONPROC put procedure directly.

CANONPROC: The CANONPROC module performs canonical processing. As implemented, all read QUEUE processing is performed in its service procedure. The CANONPROC put procedure calls the **putq** utility to schedule the message for its read service procedure, and then exits. The service procedure extracts the character from the message buffer and places it in the line buffer contained in another M_DATA message it is constructing. Then, the message containing the single character is returned to the buffer pool. If the character received was not an end-of-line, the CANONPROC module exits. Otherwise, a complete line has been assembled and the CANONPROC module sends the message upstream to the stream head, which unlocks the user process from the **getmsg** subroutine call and passes it the contents of the message.

Write-Side Processing

The write side of the stream carries two kinds of messages from the user process: **streamio** messages for the CHARPROC module and **M_DATA** messages to be output to the terminal.

The **streamio** messages are sent downstream as a result of an **I_STR** operation. When the CHARPROC module receives a **streamio** message type, it processes the message contents to modify internal QUEUE flags and then uses a utility to send an acknowledgment message upstream (read side) to the stream head. The stream head acts on the acknowledgment message by unblocking the user from the **streamio** message.

For terminal output, it is presumed that M_DATA messages, sent by **write** subroutines, contain multiple characters. In general, STREAMS returns to the user process immediately after processing the **write** subroutine so that the process may send additional messages. Flow control will eventually block the sending process. The messages can queue on the write side of the driver because of character-transmission timing. When a message is received by the driver's write put procedure, the procedure will use the **putq** utility to place the message on its write-side service message queue if the driver is currently transmitting a previous message buffer. However, there is generally no write-QUEUE service procedure in a device driver. Driver output-interrupt processing takes the place of scheduling and performs the service procedure functions, removing messages from the queue.

Analysis

For reasons of efficiency, a module implementation would generally avoid placing one character per message and using separate routines to echo and parity-check each character, as done in this example. Nevertheless, even this design yields potential benefits. Consider a case in which an alternative and more intelligent port hardware was substituted. If the hardware processed multiple input characters and performed the echo and parity-checking functions of the CHARPROC module, then the new driver could be implemented to present the same interface as the CHARPROC module. Other modules such as CANONPROC could continue to be used without modification.

Differences Between Portable Streams Environment and V.4 STREAMS

Portable Streams Environment (PSE) was implemented from the AT&T *UNIX System V Release 4, Programmer's Guide: STREAMS* document. It is designed for compatibility with existing STREAMS applications and modules that adhere to the STREAMS design guidelines.

Extensions to STREAMS

In some areas, the STREAMS definition is extended to enhance functionality. These enhancements include:

- Extended read modes. PSE supports an extra read mode, **RFILL**, which requests that the stream head fill a buffer completely before returning to the application. This is used in conjunction with a cooperating module and M_READ messages.
- The **putctl2** utility. A new utility routine, **putctl2**, is supported for creating M_ERROR messages with 2 bytes of data. The parameters are the same as for the **putctl1** utility.
- Autopush names. The PSE **autopush** command accepts device names in place of major numbers on the command line. It then translates names into major numbers with the help of the **sc** module.

Note: Although these extensions can be used freely in this operating system, their use limits portability.

Differences in PSE

Although PSE is written to the specifications in the AT&T document, there are places in which compatibility with the specification is not implemented or is not possible. These differences are:

- Include files. Not all structures and definitions in AT&T include files are discussed in the STREAMS documentation. Module and application writers can use only those symbols specified in the documentation.
- Module configuration. The configuration of modules and devices under PSE is different from AT&T System V Release 4 in that there is no master file or related structures. PSE maintains an fmodsw table for modules, and a dmodsw table for devices and multiplexors. Entries are dynamically placed in these tables as modules are loaded into a running system. Similarly, PSE normally supports **init** routines for modules and devices, but not **start** routines.
- Logging device. The STREAMS logging device is named **/dev/slog**. The **/dev/log** node refers to a different type of logging device.
- Structure definitions. PSE supports the standard STREAMS structure definitions in terms of field names and types, but also includes additional fields for host-specific needs. Modules and applications should not depend on the field position or structure size as taken from STREAMS documentation. Also, PSE does not support the notion of expanded fundamental types and the associated **_STYPES** definition.
- Queue flags. PSE defines, but does not implement, the **QBACK** and **QHLIST** queue flags.
- Memory allocation. PSE does not support the **rmalloc**, **rminit**, and **rmfree** memory allocation routines.
- Named streams. PSE does not support named streams and the associated **fdetach** program.
- Terminals. PSE does not include STREAMS-based terminals or the related modules and utilities (including job control primitives). However, nothing in PSE prevents STREAMS-based terminals from being added.
- Network selection. PSE does not support the V.4 Network Selection and Name-to-Address Mapping extensions to the TLI (Transport Layer Interface).

List of Streams Commands

System management commands are arranged by the following functions:

- Configuring
- Maintaining

For information about STREAMS operations, modules and drivers, subroutines, a function, system calls, and utilities, see “List of STREAMS Programming References” on page 289.

Configuring

autopush Configures lists of automatically pushed STREAMS modules.

strchg	Changes stream configuration.
strconf	Queries stream configuration.
strload	Loads and configures Portable Streams Environment (PSE).

Maintaining

scls	Produces a list of module and driver names.
strace	Prints STREAMS trace messages.
strclean	Cleans up the STREAMS error logger.
strerr	(Daemon) Receives error log messages from the STREAMS log driver.

List of STREAMS Programming References

The list includes:

- “Operation”
- “Modules and Drivers”
- “Subroutines”
- “Function” on page 290
- “System Calls” on page 290
- “Utilities” on page 290

For information about STREAMS commands for configuring and managing, see “List of Streams Commands” on page 288.

Operation

streamio	Lists the ioctl operations which perform a variety of control functions on streams.
-----------------	---

Modules and Drivers

The following modules and drivers are used in the STREAMS environment. The references are found in the list of subroutines.

pfmod	Selectively removes upstream data messages on a stream.
timod	Converts a set of streamio operations into STREAMS messages.
tirdwr	Supports the Transport Interface functions of the Network Services library.
xtiso	Provides access to sockets-based protocols to STREAMS applications.
dipi	Provides an interface to the data link provider.

Subroutines

t_accept	Accepts a connect request.
t_alloc	Allocates a library structure.
t_bind	Binds an address to a transport endpoint.
t_close	Closes a transport endpoint.
t_connect	Establishes a connection with another transport user.
t_error	Produces an error message.
t_free	Frees a library structure.
t_getinfo	Gets protocol-specific service information.
t_getstate	Gets the current state.
t_listen	Listens for a connect request.

t_look	Looks at the current event on a transport endpoint.
t_open	Establishes a transport endpoint.
t_optmgmt	Manages options for a transport endpoint.
t_rcv	Receives normal data or expedited data sent over a connection.
t_rcvconnect	Receives the confirmation from a connect request.
t_rcvdis	Retrieves information from disconnect.
t_rcvrel	Acknowledges receipt of an orderly release indication.
t_rcvudata	Receives a data unit.
t_rcvuderr	Receives a unit data error indication.
t_snd	Sends data or expedited data over a connection.
t_snddis	Sends a user-initiated disconnect request.
t_sndrel	Initiates an orderly release of a transport connection.
t_sndudata	Sends a data unit to another transport user.
t_sync	Synchronizes transport library.
t_unbind	Disables a transport endpoint.

Function

isastream Tests a file descriptor.

System Calls

getmsg Gets the next message off a stream.
getpmsg Gets the next priority message off a stream.
putmsg Sends a message on a stream.
putpmsg Sends a priority message on a stream.

Utilities

The following utilities are used by STREAMS:

adjmsg Trims bytes in a message.
allocb Allocates message and data blocks.
backq Returns a pointer to the queue behind a given queue.
bcnput Tests for flow control in the given priority band.
bufcall Recovers from a failure of the **allocb** utility.
canput Tests for available room in a queue.
copyb Copies a message block.
copymsg Copies a message.
datamsg Tests whether message is a data message.
dupb Duplicates a message-block descriptor.
dupmsg Duplicates a message.
enableok Enables a queue to be scheduled for service.
esballocc Allocates message and data blocks.
flushband Flushes the messages in a given priority band.
flushq Flushes a queue.
freeb Frees a single message block.
freemsg Frees all message blocks in a message.
getadmin Returns a pointer to a module.
getmid Returns a module ID.
getq Gets a message from a queue.
insq Puts a message at a specific place in a queue.
linkb Concatenates two messages into one.

mi_bufcall	Provides a reliable alternative to the bufcall utility.
mi_close_comm	Performs housekeeping during STREAMS module close operations.
mi_next_ptr	Traverses a STREAMS module's linked list of open streams.
mi_open_comm	Performs housekeeping during STREAMS module open operations.
msgdsz	Gets the number of data bytes in a message.
noenable	Prevents a queue from being scheduled.
OTHERQ	Returns the pointer to the mate queue.
pullupmsg	Concatenates and aligns bytes in a message.
putbq	Returns a message to the beginning of a queue.
putctl	Passes a control message.
putctl1	Passes a control message with a one-byte parameter.
putnext	Passes a message to the next queue.
putq	Puts a message on a queue.
qenable	Enables a queue.
qreply	Sends a message on a stream in the reverse direction.
qsize	Finds the number of messages on a queue.
RD	Gets the pointer to the read queue.
rmvb	Removes a message block from a message.
rmvq	Removes a message from a queue.
splstr	Sets the processor level.
splx	Terminates a section of code.
srv	Services queued messages for STREAMS modules or drivers.
str_install	Installs STREAMS modules and drivers.
strlog	Generates STREAMS error-logging and event-tracing messages.
strqget	Obtains information about a queue or band of the queue.
testb	Checks for an available buffer.
timeout	Schedules a function to be called after a specified interval.
unbufcall	Cancels a bufcall request.
unlinkb	Removes a message block from the head of a message.
untimeout	Cancels a pending time-out request.
unweldq	Removes a previously established weld connection between STREAMS queues.
wantio	Register direct I/O entry points with the stream head.
weldq	Establishes a unidirectional connection between STREAMS queues.
WR	Retrieves a pointer to the write queue.

Transport Service Library Interface Overview

Network applications that are either system-provided or developed in-house require a programming interface to the network, such as Transmission Control Protocol/Internet Protocol (TCP/IP). The transport level programming interface provides application developers a means of getting to the network protocols without requiring the knowledge of protocol-specific semantics, the framework which the protocols are loaded or the complexity of kernel interfaces.

Two libraries are provided for accessing well-known protocols such as TCP/IP. These libraries are:

- Transport Library Interface (TLI)
- X/OPEN Transport Library Interface (XTI)

These library interfaces are provided in addition to the existing socket system calls. Generally speaking, well-known protocols, such as TCP/IP and Open Systems Interconnection (OSI), are divided into two parts:

- Transport layer and below are in the kernel space
- Session layer and above services are in the user space.

The operating system supplies the socket-based TCP/IP protocol suites as a part of the base system. It also supplies the socket system calls and socket library calls (**libc.a**) for the existing applications which have been developed using the sockets applications programming interface (API).

TLI is a library that is used for porting applications developed using the AT&T System V-based UNIX operating systems.

XTI is a library implementation, as specified by X/OPEN CAE Specification of X/Open Transport Interface and fully conformant to *X/OPEN XPG4 Common Application Environment (CAE)* specification, that defines a set of transport-level services that are independent of any specific transport provider's protocol or its framework.

The purpose of XTI is to provide a universal programming interface for the transport layer functions regardless of the transport layer protocols, how the framework of the transport layer protocols are implemented, or the type of UNIX operating system. For example, an application which writes to XTI should not have to know that the service provider is written using STREAMS or sockets. The application accesses the transport end point (using the returned handle, *fd*, of the **t_open** subroutine) and requests and receives indications from the well-known service primitives. If desired or necessary, applications can obtain any protocol-specific information by calls to the **t_info** subroutine.

Both TLI and XTI are implemented using STREAMS. This implementation includes the following members:

- Transport Library - **libtli.a**
- X/OPEN Transport Library - **libxti.a**
- STREAMS driver - Sends STREAMS messages initiated from the XTI or TLI library to the sockets-based network protocol (as in the case of TCP/IP) or to other STREAMS drivers (as in the case of Netware).

The TLI (**libtli.a**) and XTI (**libxti.a**) libraries are shared libraries. This means that applications can run without recompiling, even though the system may update the libraries in the future.

The TLI and XTI calls syntax is similar. For the most part, XTI is a superset of TLI in terms of definitions, clarification of usage, and robustness of return codes. For specific XTI usage and return codes, see the X/OPEN CAE Specification of X/Open Transport Interface and the "Subroutines" on page 289.

TLI and XTI Characteristics

TLI and XTI are the interfaces for providing the transport layer services. The semantics of these interfaces closely resemble those of sockets. Some of the characteristics of the interfaces are:

- **Transport end points** - A transport end point specifies a communication path between a transport user and a specific transport provider. Similar to the **socket** subroutine (which returns the file descriptor, *s*), calls to the TLI and XTI **t_open** subroutines return the file descriptor, *fd*, as a handle to be used with subsequent calls.

A transport end point can support only one established transport connection at a time, though a transport provider, such as TCP/IP, serves the multiple transport end points. To activate and bind the local transport port, a transport end point must have a transport address associated with it by **t_bind** subroutine calls. To make an end-to-end connection between two active transport end points, the **t_connect** subroutine must follow. For a transport end point that needs a connectionless service, such as User Datagram Protocol/Internet Protocol (UDP/IP), a connect phase is skipped and the **t_rcvudata** subroutine can be called after the **t_bind** subroutine is issued.

- **Ownership of transport end points** - Once a transport end point is acquired from the transport provider (by getting the file descriptor, *fd*, from the **t_open** calls), the handle as specified by *fd* can be shared by multiple processes, such as the **fork** subroutine. However, the transport provider treats the processes sharing the same *fd* as a single return point. These processes must coordinate their activities to not violate the state of provider.

The **t_sync** subroutine calls return the state of the transport provider, allowing users to verify the transport provider state before taking further action. An application that wants to manage multiple transport providers, such as a server application, must call the **t_open** subroutine for each provider. For example, a server application that is waiting for incoming connect indications from several transport providers, such as TCP/IP and OSI, must open multiple **t_open** subroutines and listen for connection indications on each of the associated handles (*fd*).

- **Synchronous and asynchronous execution of calls** - TLI and XTI provide synchronous and asynchronous execution of calls. In the synchronous mode of operation, the calls block until a specific event is satisfied. Synchronous mode is the default mode of operation. In the asynchronous mode of operation (**t_open** subroutine with the **O_NONBLOCK** flag set), the call is returned immediately and the specified event is notified by either or both the **poll** and **select** system calls some time later.

Users are advised to choose a mode of execution based on the nature of its function. For example, a typical server application should exploit the asynchronous execution to facilitate multiple concurrent actions required for client requests.

- **Event Management** - For connection-oriented mode, it is important for users to know the state of the current connection or the change of any state caused by calls issued to that state. The TLI and XTI event management allows the state of event either by return code (**TLOOK**) or a call (**t_look** subroutine) to request the current state information.

The following tables list the typical sequence of calls a user must issue for various connection types.

Note: These tables are provided as examples of typical sequences, rather than the exact order in which the transport providers are required.

Connection oriented calls:

Server	Client
t_open()	t_open()
t_bind()	t_bind()
t_alloc()	t_alloc()
t_listen()	t_connect()
:	←----->:
:	:
t_accept()	:
	:
t_rcv()/t_snd()	t_snd()/t_rcv()
t_snddis()/t_rcvdis()	t_rcvdis()/t_snddis()
t_unbind()	t_unbind()
t_close()	t_close()

Connectionless calls:

Server	Client
t_open()	t_open()
t_bind()	t_bind()
t_alloc()	t_alloc()
t_rcvudata()/t_sndudata	t_sndudata/t_rcvudata
t_unbind()	t_unbind()
t_close()	t_close()

Chapter 11. Transmission Control Protocol/Internet Protocol

Transmission Control Protocol/Internet Protocol (TCP/IP) includes a suite of protocols that specify communications standards between computers as well as detail conventions for routing and interconnecting networks. TCP/IP is used extensively on the Internet and consequently allows research institutions, colleges and universities, government, industry, and individuals to communicate with each other.

This chapter provides the following:

- “DHCP Server API”
- “Dynamic Load API” on page 301
- “Service Location Protocol (SLP) APIs” on page 305
- “Lists of Programming References” on page 309

For information on name resolution, see “Network Address Translation” on page 214.

DHCP Server API

The DHCP server lets you define modules that can be linked to the DHCP Server and called at specified checkpoints during DHCP or **BOOTP** message processing. This section describes the following:

- “Loading User Objects”
- “Predefined Structures”
- “User-Defined Object Requirements” on page 297
- “User-Defined Object Optional Routine” on page 301

Note: Because the DHCP server is run with root-user authority, user-defined objects can introduce security vulnerabilities and performance degradation. Especially protect against buffer overrun exploitations and enforce security measures when an object writes to temporary files or executes system commands. Also, since many of the routines that can be defined by the object are executed during the normal processing path of each DHCP client’s message, monitor the response time to the DHCP client for any impacts on performance.

Loading User Objects

The DHCP server loads any user-defined object referenced in the configuration file with the `UserObject` configuration line or stanza. For example:

```
UserObject myobject
```

or

```
UserObject myobject
{
    file /tmp/myobject.log;
}
```

For both of these examples, the dynamically loadable shared object **myobject.dhcpc** is loaded from the `/usr/sbin` directory. In the second case, the object’s **Initialize** subroutine is passed a file pointer; the object must parse and handle its own configuration stanza.

Predefined Structures

The operating system provides the following structures through the `dhcp_api.h` file. The structures are more thoroughly described in the following sections:

- “dhcpcmessage” on page 296

- “dhcption”
- “dhcpclientid”
- “dhcplogseverity”

dhcpmessage

dhcpmessage defines the structure and fields of a basic DHCP message. The options field is variable in length and every routine that references a DHCP message also specifies the total length of the message. The content of the structure follows:

```
struct dhcpmessage
{
    uint8_t      op;
    uint8_t      htype;
    uint8_t      hlen;
    uint8_t      hops;
    uint32_t     xid;
    uint16_t     secs;
    uint16_t     flags;
    uint32_t     ciaddr;
    uint32_t     yiaddr;
    uint32_t     siaddr;
    uint32_t     giaddr;
    uint8_t      chaddr[16];
    uint8_t      sname[64];
    uint8_t      file[128];
    uint8_t      options[1];
};
```

dhcption

dhcption defines the framework of a DHCP option encoded in its type, length, data format. The content of the structure follows:

```
struct dhcption
{
    uint8_t      code;
    uint8_t      len;
    uint8_t      data[1];
};
```

dhcpclientid

dhcpclientid uniquely identifies a DHCP client. You can define it using the DHCP Client Identifier Option or it can be created from the hardware type, hardware length, and hardware address of a DHCP or BOOTP message that does not contain a Client Identifier Option. The DHCP message option and client identifier references always point to network byte-ordered data. The content of the structure follows:

```
struct dhcpclientid
{
    uint8_t      type;
    uint8_t      len;
    uint8_t      id[64];
};
```

dhcplogseverity

The enumerated type **dhcplogseverity** assigns a log severity level to a user-defined object’s error messages. An object’s error message is displayed to the DHCP server’s log file through the exported **dhcpapi_logmessage** routine, provided that logging severity level has been enabled.

```
enum dhcplogseverity
{
    dhcplog_syserr = 1 ,
    dhcplog_objerr ,
    dhcplog_protocol ,
    dhcplog_warning ,
    dhcplog_event ,
    dhcplog_action ,
};
```

```

    dhcplog_info ,
    dhcplog_accounting ,
    dhcplog_stats ,
    dhcplog_trace
};

```

User-Defined Object Requirements

The following are required for any user-defined object to conform to this API:

1. The object must use the **Initialize** routine (see “Initialize”).
2. The object must use the **Shutdown** routine (see “Shutdown”).
3. The object must contain at least one of the checkpoint routines defined in the API (see “Checkpoint Routines” on page 298).
4. The object must *never* alter any data provided by a **const** pointer reference to the routine.

Initialize

The **Initialize** routine must be defined by the object to be loaded by the server. It is used each time the server is started, including restarts, and is called each time the object is referenced in the DHCP server’s configuration file.

The following is the structure of the **Initialize** routine:

```

int Initialize      ( FILE *fp,
                    caddr_t *hObjectInstance      ) ;

```

Where:

fp Points to the configuration block for the loaded UserObject. The value of the pointer is NULL if no configuration block exists following the UserObject definition in the DHCP Server configuration file.

hObjectInstance Is set by the loaded object if the object requires private data to be returned to it through each invocation. One handle is created for each configuration instance of the loaded object.

If the file pointer *fp* is not NULL, its initial value references the first line of contained data within the configuration block of the user-defined object. Parsing should continue only as far as an unmatched close brace (}), which indicates the end of the configuration block.

The *Initialize* routine does not require setting the *hObjectInstance* handle. However, it is required that the routine return specific codes, depending on whether the initialization succeeded or failed. The required codes and their meanings follow:

0 (zero)	Instance is successfully initialized. The server can continue to link to each symbol.
!= 0 (non-zero)	Instance failed to initialize. The server can free its resources and continue to load, ignoring this section of the configuration file.

Shutdown

The **Shutdown** routine is used to reverse the effects of initialization: to deallocate data and to destroy threads. The **Shutdown** routine is called before shutting down the server and again before reloading the configuration file at each server reinitialization. The routine must return execution to the server so the server can reinitialize and properly shut down. The following is the structure of the **Shutdown** routine:

```

void Shutdown      ( caddr_t hObjectInstance      ) ;

```

Where:

hObjectInstance Is the same configuration instance handle created when this object was initialized.

Checkpoint Routines

A user-defined object must implement at least one of the following checkpoint routines. The routines are more thoroughly described in the following sections.

- “messageReceived”
- “addressOffered”
- “addressAssigned” on page 299
- “addressReleased” on page 299
- “addressExpired” on page 300
- “addressDeleted” on page 300
- “addressDeclined” on page 300

messageReceived: The **messageReceived** routine lets you add an external means of authentication to each received DHCP or BOOTP message. The routine is called just as the message is received by the protocol processor and before any parsing of the message itself.

In addition to the message, the server passes three IP addresses to the routine. These addresses, when used together, can determine whether the client is on a locally attached network or a remotely routed network and whether the server is receiving a broadcast message.

Additionally, you can use the **messageReceived** routine to alter the received message. Because changes directly affect the remainder of message processing, use this ability rarely and only under well-understood circumstances.

The following is the structure of the **messageReceived** routine:

```
int messageReceived ( caddr_t hObjectInstance,
                    struct dhcpmessage **inMessage,
                    size_t *messageSize,
                    const struct in_addr *receivingIP,
                    const struct in_addr *destinationIP,
                    const struct in_addr *sourceIP      ) ;
```

Where:

<i>hObjectInstance</i>	Is the same configuration instance handle created when this object was initialized.
<i>inMessage</i>	Is a pointer to the unaltered, incoming DHCP or BOOTP message.
<i>messageSize</i>	Is the total length, in bytes, of the received DHCP or BOOTP message.
<i>receivingIP</i>	Is the IP address of the interface receiving the DHCP or BOOTP message.
<i>destinationIP</i>	Is the destination IP address taken from the IP header of the received DHCP or BOOTP message.
<i>sourceIP</i>	Is the source IP address taken from the IP header of the received DHCP or BOOTP message.

The **messageReceived** routine returns one of the following values:

0 (zero)	The received message can continue to be parsed and the client possibly offered or given an address through the regular means of the DHCP server.
!= 0 (non-zero)	The source client of this message is not to be given any response from this server. This server remains silent to the client.

addressOffered: The **addressOffered** routine is used for accounting. Parameters passed to the routine are read-only. The routine has no return code to prevent sending the outgoing message. It is called when a DHCP client is ready to be sent an address OFFER message. The following is the structure of the **addressOffered** routine:

```
void addressOffered ( caddr_t hObjectInstance,
                    const struct dhcpclientid *cid,
                    const struct in_addr *addr,
                    const struct dhcpmessage *outMessage,
                    size_t messageSize
                    ) ;
```

Where:

<i>hObjectInstance</i>	Is the same configuration instance handle created when this object was initialized.
<i>cid</i>	Is the client identifier of the client.
<i>addr</i>	Is the address to be offered to the client.
<i>outMessage</i>	Is the outgoing message that is ready to be sent to the client.
<i>messageSize</i>	Is the length, in bytes, of the outgoing message that is ready to be sent to the client.

addressAssigned: The **addressAssigned** routine can be used for accounting purposes or to add an external means of name and address association. The *hostname* and *domain* arguments are selected based upon the A-record proxy update policy and the append domain policy (configured in the **db_file** database through the keywords proxyARec and appendDomain, respectively), as well as the defined and suggested *hostname* and *domain* options for the client.

The **addressAssigned** routine is called after the database has associated the address with the client and just before sending the BOOTP response or DHCP ACK to the client. If a DNS update is configured, the **addressAssigned** routine is called after the update has occurred or, at least, has been queued.

Parameters offered to the routine are read-only. The routine has no return code to prevent address and client binding. The structure of the **addressAssigned** routine follows:

```
void addressAssigned ( caddr_t hObjectInstance,
                    const struct dhcpclientid *cid,
                    const struct in_addr *addr,
                    const char *hostname,
                    const char *domain,
                    const struct dhcpmessage *outMessage,
                    size_t messageSize
                    ) ;
```

<i>hObjectInstance</i>	Is the same configuration instance handle created when this object was initialized.
<i>cid</i>	Is the client identifier of the client.
<i>addr</i>	Is the address selected for the client.
<i>hostname</i>	Is the host name which is (or should have been) associated with the client.
<i>domain</i>	Is the domain in which the host name for the client was (or should have been) updated.
<i>outMessage</i>	Is the outgoing message that is ready to be sent to the client.
<i>messageSize</i>	Is the length, in bytes, of the outgoing message that is ready to be sent to the client.

addressReleased: The **addressReleased** routine is used for accounting when DHCP clients are ready to be sent an address OFFER message. Parameters given to the routine are read-only.

The routine is called just after the database has been instructed to disassociate the client identifier and address binding. If so configured, the routine is called after the DNS server has been indicated to disassociate the name and address binding.

The structure of the **addressReleased** routine follows:

```
void addressReleased ( caddr_t hObjectInstance,
                    const struct dhcpclientid *cid,
                    const struct in_addr *addr,
                    const char *hostname,
                    const char *domain
                    ) ;
```

Where:

<i>hObjectInstance</i>	Is the same configuration instance handle created when this object was initialized.
<i>cid</i>	Is the client identifier of the client.
<i>addr</i>	Is the address previously used by the client.
<i>hostname</i>	Is the hostname previously associated with this client and address binding.
<i>domain</i>	Is the domain in which the hostname for the client was (or should have been) previously updated.

addressExpired: The **addressExpired** routine is used for accounting when any DHCP database detects an association must be cancelled because the address and client identifier association has existed beyond the end of the offered lease. Parameters given to the routine are read-only.

The structure of the **addressExpired** routine follows:

```
void addressExpired ( caddr_t hObjectInstance,
                    const struct dhcpclientid *cid,
                    const struct in_addr *addr,
                    const char *hostname,
                    const char *domain
                    ) ;
```

Where:

<i>hObjectInstance</i>	Is the same configuration instance handle created when this object was initialized.
<i>cid</i>	Is the client identifier of the client.
<i>addr</i>	Is the address previously used by the client.
<i>hostname</i>	Is the hostname previously associated with this client and address binding.
<i>domain</i>	Is the domain in which the hostname for the client was (or should have been) previously updated.

addressDeleted: The **addressDeleted** routine is used for accounting when any address association is explicitly deleted from lack of interaction with the client or because of a lease expired. Most commonly, this routine is invoked when the DHCP server is reinitialized, when a new configuration might cause a previous client and address association to become invalid, or when the administrator explicitly deletes an address using the **dadmin** command. Parameters given to the routine are read-only.

The structure of the **addressDeleted** routine follows:

```
void addressDeleted ( caddr_t hObjectInstance,
                    const struct dhcpclientid *cid,
                    const struct in_addr *addr,
                    const char *hostname,
                    const char *domain
                    ) ;
```

Where:

<i>hObjectInstance</i>	Is the same configuration instance handle created when this object was initialized.
<i>cid</i>	Is the client identifier of the client.
<i>addr</i>	Is the address previously used by the client.
<i>hostname</i>	Is the hostname previously associated with this client and address binding.
<i>domain</i>	Is the domain in which the hostname for the client was (or should have been) previously updated.

addressDeclined: The **addressDeclined** routine is used for accounting purposes when a DHCP client indicates to the server (through the DHCP DECLINE message type) that the given address is in use on the network. The routine is called immediately after the database has been instructed to disassociate the client identifier and address binding. If so configured, the routine is called after the DNS server has been indicated to disassociate the name and address binding. Parameters given to the routine are read-only.

The structure of the **addressDeclined** routine follows:

```
void addressDeclined ( caddr_t hObjectInstance,
                      const struct dhcpclientid *cid,
                      const struct in_addr *addr,
                      const char *hostname,
                      const char *domain
                      ) ;
```

Where:

hObjectInstance Is the same configuration instance handle created when this object was initialized.
cid Is the client identifier of the client.
addr Is the address that was declined by the client.
hostname Is the hostname previously associated with this client and address binding.
domain Is the domain in which the hostname for the client was (or should have been) previously updated.

User-Defined Object Optional Routine

The **dhcpapi_logmessage** routine is available to the user-defined object programmer. A prototype is available in **dhcpapi.h** with the symbol defined for linking in **/usr/lib/dhcp_api.exp**.

The routine specifies a message that is logged to the DHCP server's configured log file, provided that message severity level, which specified by the *s* parameter, has been enabled. The structure of the **dhcpapi_logmessage** routine follows:

```
void dhcpapi_logmessage ( enum dhcplogseverity s,
                         char *format,
                         ...
                         ) ;
```

s Is the severity level of the message to be logged. Message severities are defined in the **dhcpapi.h** header file and correspond directly to the DHCP server configuration `logItem` levels of logging.
format Is the typical **printf** format string.

Dynamic Load API

The operating system supports name resolution from five different maps:

- Domain Name Server (DNS)
- Network Information Server (NIS)
- NIS+
- Local methods of name resolution
- Dynamically loaded, user-defined APIs

With the Dynamic Load Application Programming Interface (API), you can load your own modules to provide routines that supplement the maps provided by the operating system. The Dynamic Load API enables you to create dynamically loading APIs in any of the following map classes:

- “Services Map Type” on page 302
- “Protocols Map Type” on page 302
- “Hosts Map Type” on page 302
- “Networks Map Type” on page 302
- “Netgroup Map Type” on page 303

You can build your own user modules containing APIs for any or all of the map classes. The following sections define an API's function names and prototypes for each of the five classes. To instantiate each map accessor, the operating system requires that a user-provided module use the specified function names and function prototypes for each map class.

For information about configuring a dynamically loading API, see “Configuring a Dynamic API” on page 304.

Services Map Type

The following is the required prototype for a user-defined services map class:

```
void *sv_pvtinit();
void sv_close(void *private);
struct servent * sv_byname(void *private, const char *name, const char *proto);
struct servent * sv_byport(void *private, int port, const char *proto);
struct servent * sv_next(void *private);
void sv_rewind(void *private);
void sv_minimize(void *private);
```

Function **sv_pvtinit** must exist. It is not required to return anything more than NULL. For example, the function can return NULL if the calling routine does not need private data.

Functions other than **sv_pvtinit** are optional for this class. The module can provide none or only part of the optional functions in its definition.

Protocols Map Type

The following is the required prototype for a user-defined protocols map class:

```
void *pr_pvtinit();
void pr_close(void *private);
struct protoent * pr_byname(void *private, const char *name);
struct protoent * pr_bynumber(void *private, int num);
struct protoent * pr_next(void *private);
void pr_rewind(void *private);
void pr_minimize(void *private);
```

Function **pr_pvtinit** must exist. It is not required to return anything more than NULL. For example, the function can return NULL if the calling routine does not need private data.

Functions other than **pr_pvtinit** are optional for this class. The module can provide none or only part of the optional functions in its definition.

Hosts Map Type

The following is the required prototype for a user-defined hosts map class:

```
void *ho_pvtinit();
void ho_close(void *private);
struct hostent * ho_byname(void *private, const char *name);
struct hostent * ho_byname2(void *private, const char *name, int af);
struct hostent * ho_byaddr(void *private, const void *addr, size_t len, int af);
struct hostent * ho_next(void *private);
void ho_rewind(void *private);
void ho_minimize(void *private);
```

Function **ho_pvtinit** must exist. It is not required to return anything more than NULL. For example, the function can return NULL if the calling routine does not need private data.

Functions other than **ho_pvtinit** are optional for this class. The module can provide none or only part of the optional functions in its definition.

Networks Map Type

The following is the required prototype for a user-defined networks map class:

```
void *nw_pvtinit();
void nw_close(void *private);
struct nwent * nw_byname(void *private, const char *name, int addrtype);
```



```

struct nwent * nw_byaddr(void *private, void *net, int length, int addrtype);
struct nwent * nw_next(void *private);
void nw_rewind(void *private);
void nw_minimize(void *private);

```

Function **nw_pvtinit** must exist. It is not required to return anything more than NULL. For example, the function can return NULL if the calling routine does not need private data.

Functions other than **nw_pvtinit** are optional for this class. The module can provide none or only part of the optional functions in its definition.

The operating system provides a data structure required to implement the networks map class, which uses this structure to communicate with the operating system.

```

struct nwent {
    char *name;          /* official name of net */
    char **n_aliases;   /* alias list */
    int n_addrtype;     /* net address type */
    void *n_addr;       /* network address */
    int n_length;       /* address length, in bits */
};

```

Netgroup Map Type

The following is the required prototype for a user-defined netgroup map class:

```

void * ng_pvtinit();
void ng_rewind(void *private, const char *group);
void ng_close(void *private);
int ng_next(void *private, char **host, char **user, char **domain);
int ng_test(void *private, const char *name, const char *host, const char *user,
const char *domain);
void ng_minimize(void *private);

```

Function **ng_pvtinit** must exist. It is not required to return anything more than NULL. For example, the function can return NULL if the calling routine does not need private data.

Functions other than **ng_pvtinit** are optional for this class. The module can provide none or only part of the optional functions in its definition.

Using the Dynamic Load API

You must name your user-defined module according to a pre-established convention. Also, you must configure it into the operating system before it will work. The following sections explain API module naming and configuration.

Naming the User-Provided Module

The names of modules containing user-defined APIs follow this general form:

NameAddressfamily

Where:

Name Is the name of the dynamic loadable module name. The length of the Name can be between one to eight characters.

The following key words are reserved as the user option name and may not be used as the name of the dynamically loadable module:

- local
- bind
- dns
- nis
- ldap
- nis_ldap

Addressfamily Represents the address family and can be either 4 or 6. If no number is specified, the address family is AF_UNSPEC. If the number is 4, the address family is AF_INET. If the number is 6, the address family is AF_INET6.

Any other format for user options is not valid.

Note: If a user calls the **gethostbyname2** system call from within the application, whatever the address family the user passed to the **gethostbyname2** system call overwrites the address family in the user option. For example, a user option is *david6* and there is a system call `gethostbyname2(name, AF_INET)` in the application. Given this example, the address family AF_INET overwrites the user option's address family (6, same as AF_INET6).

Configuring a Dynamic API

There are three ways to specify user-provided, dynamically loading resolver routines. You can use the NSORDER environment variable, the **/etc/netsvc.conf** configuration file, or the **/etc/irs.conf** configuration file. With any of these sources, you are not restricted in the number of options that you can enter, nor in the sequence in which they are entered. You are, however, restricted to a maximum number of 16 user modules that a user can specify from any of these sources.

The NSORDER environment variable is given the highest priority. Next is the **/etc/netsvc.conf** configuration file, then the **/etc/irs.conf** configuration file. A user option specified in a higher priority source (for example, NSORDER) causes any user options specified in the lower priority sources to be ignored.

NSORDER Environment Variable

You can specify zero or more user options in the environment variable NSORDER. For example, on the command line, you can type:

```
export NSORDER=local, bind, bob, nis, david4, jason6
```

In this example, the operating system invokes the listed name resolution modules, left to right, until the name is resolved. The modules named `local`, `bind`, and `nis` are reserved by the operating system, but `bob`, `david4`, and `jason6` are user-provided modules.

/etc/netsvc.conf Configuration File

You can specify zero or more user options in the configuration file **/etc/netsvc.conf**. For example:

```
hosts=nis, jason4, david, local, bob6, bind
```

/etc/irs.conf Configuration File

You can specify zero or more user options in the configuration file **/etc/irs.conf**. For example:

```
hosts dns continue
hosts jason6 merge
hosts david4
```

Procedures

To create and install a module containing a dynamically loading API, use the following procedure. The operating system provides a sample **Makefile**, sample export file, and sample user module file, which are located in the **/usr/samples/tcpip/dynload** directory.

1. Create the dynamic loadable module based on operating system specifications.
2. Create an export file (for example, **rnd.exp**) that exports all the symbols to be used.
3. After compilation, put all the dynamic loadable object files in the **/usr/lib/netsvc/dynload** directory.
4. Configure one of the sources described immediately before this procedure (NSORDER, **/etc/netsvc.conf**, or **/etc/irs.conf**).

Service Location Protocol (SLP) APIs

Service Location Protocol provides a flexible and scalable framework for providing hosts with access to information about the existence, location, and configuration of network services. Any TCP/IP application can take advantage of this protocol. SLP is based on RFC 2608 and RFC 2614.

This section shows sample code on how to use the SLP APIs. The SLP APIs are as follows. Documentation for these APIs can be found in *AIX 5L Version 5.3 Technical Reference: Communications Volume 2*.

- **SLPOpen**
- **SLPClose**
- **SLPFree**
- **SLPFindSrvs**
- **SLPFindSrvTypes**
- **SLPFindAttrs**
- **SLPEscape**
- **SLPUnescape**
- **SLPParseSrvURL**
- **SLPFindScopes**
- **SLPGetProperty**
- **SLPSrvTypeCallback**
- **SLPSrvURLCallback**
- **SLPAttrCallback**
- **SLPReg**
- **SLPDereg**
- **SLPRegReport**

```
* To compile it this sample code:
* cc -o samplecode samplecode.c -lslp
*
* To run the program:
* samplecode -s <scopes> -p <predicate> -a <attrids> -t <service_type> \
      -u <url_string> -n <naming_authority>
*/

#include <stdio.h>
#include <slp.h>

extern      int      optind;
extern      char     *optarg;

int      s_flag = 0,
         p_flag = 0,
         a_flag = 0,
         t_flag = 0,
         u_flag = 0,
         n_flag = 0;

void arginit(int argc, char *argv[]);
```

```

void Usage(void);

char *service_type = NULL,      /* For service type
    */
scopes = NULL,                 /* For scopes list
    */
*predicate = NULL,             /* For predicate list
    */
*attrids = NULL,               /* For attribute ids
    */
*url = NULL,                   /* For URL string
    */
*na = NULL;                    /* For naming authority string
    */

SLPBoolean SrvURLCallback (SLPHandle hslp,
                           const char *pcSrvURL,
                           unsigned short sLifetime,
                           SLPErrors errCode,
                           void *pvCookie)
{
    SLPSrvURL* ppSrvURL;
    SLPErrors err;

    if ( errCode == SLP_LAST_CALL)
    {
        *(SLPErrors *) pvCookie = errCode;
        return (SLP_FALSE); /* last call, no more data available */
    }
    else if (errCode != SLP_OK)
    {
        *(SLPErrors *) pvCookie = errCode;
        return (SLP_FALSE); /* error happened. don't want any more
data */
    }
    else
    {
        printf("pcSrvURL is: %s\n", pcSrvURL);
        printf("sLifetime is: %d\n", sLifetime);
        *(SLPErrors *) pvCookie = errCode;

        /* Will parse the pcSrvURL string. */
        err = SLPParseSrvURL((char *)pcSrvURL, &ppSrvURL);
        if (err != SLP_OK)
        {
            SLPFree((void *)ppSrvURL); /* release the dynamically
allocated memory */
            return(SLP_FALSE); /* don't want any more data */
        }
        SLPFree((void *)ppSrvURL); /* release the dynamically allocated
memory */

        return(SLP_TRUE); /* want more data */
    }
}

SLPBoolean SrvTypeCallback (SLPHandle hslp,
                            const char *pcSrvTypes,
                            SLPErrors errCode,
                            void *pvCookie)
{
    if ( errCode == SLP_LAST_CALL)
    {
        *(SLPErrors *) pvCookie = errCode;
        return (SLP_FALSE); /* last call, no more data available
    */
    }
}

```

```

        else if (errCode != SLP_OK)
        {
            *(SLPError *) pvCookie = errCode;
            return (SLP_FALSE); /* error happened. don't want any more
data */
        }
        else
        {
            printf("pcSrvTypes is: %s\n", pcSrvTypes);
            *(SLPError *) pvCookie = errCode;
            return(SLP_TRUE); /* want more data */
        }
    }

SLPBoolean AttrCallback (SLPHandle hslp,
                        const char *pcAttrList,
                        SLPError errCode,
                        void *pvCookie)
{
    if ( errCode == SLP_LAST_CALL)
    {
        *(SLPError *) pvCookie = errCode;
        return (SLP_FALSE); /* last call, no more data available
*/
    }
    else if (errCode != SLP_OK)
    {
        *(SLPError *) pvCookie = errCode;
        return (SLP_FALSE); /* error happened. don't want any more
data */
    }
    else
    {
        printf("pcAttrList is: %s\n", pcAttrList);
        *(SLPError *) pvCookie = errCode;
        return(SLP_TRUE); /* want more data */
    }
}

int main (int argc, char *argv[])
{
    SLPHandle slph;
    SLPError callbackerr;
    SLPError err;

    arginit(argc, argv);

    err = SLPOpen("en", SLP_FALSE, &slph);
    if (err != SLP_OK)
    {
        printf("SLPOpen returns error, err = %d\n", err);
        exit(1);
    }

    err = SLPFindSrvs (slph,
                      service_type,
                      scopes, /* if NULL, use static configuration
in /etc/slp.conf */
                      predicate,
                      SrvURLCallback,
                      &callbackerr);
    if (err != SLP_OK)
    {
        printf("SLPFindSrvs returns error, err = %d\n", err);
        exit(1);
    }
}

```

```

    err = SLPFindSrvTypes (slph,
                          na,
                          scopes, /* if NULL, use static configuration
in /etc/slp.conf*/
                          SrvTypeCallback,
                          &callbackerr);
    if (err != SLP_OK)
    {
        printf("SLPFindSrvTypes returns error, err = %d\n", err);
        exit(1);
    }

    err = SLPFindAttrs(slp,
                      url,
                      scopes, /* if NULL, use static configuration
in /etc/slp.conf */
                      attrids,
                      AttrCallback,
                      &callbackerr);
    if (err != SLP_OK)
    {
        printf("SLPFindAttrs returns error, err = %d\n", err);
        exit(1);
    }

    SLPClose(slp);

    return (err);
}

void Usage(void)
{
    printf("\n***Usage: samplecode -s <scopes> -p <predicate> -a
<attrids>\n");
    printf("\t -t <service_type> -u <url_string> -n <naming_authority>
\n");
    printf("Where:\n");
    printf("\t -s <scopes>, a scopes string. e.g. \"david,bob\"\n");
    printf("\t -p <predicate>, a predicate string. e.g. \"(cn=Hard Rock)\"
\n");
    printf("\t -a <attrids>, attribute string, e.g. \"\"\n");
    printf("\t -t <service_type>, e.g. \"service:ftp\"\n");
    printf("\t -u <url>, e.g. \"service:ftp\", or \"service:ftp://9.3.149.20\"\n");
    printf("\t -n <naming_authority>, e.g. \"\", or \"*\n");
    exit(1);
}

void arginit(int argc, char *argv[])
{
    char *opts = "s:p:a:t:u:n:";
    int i;

    if (argc <=1)
        Usage();

    while ((i=getopt(argc, argv, opts)) != EOF ) {
        switch (i) {
            case 's':
                if (++s_flag > 1)
                    Usage();
                scopes = optarg;
                break;
            case 'p':
                if (++p_flag > 1)
                    Usage();
                predicate = optarg;

```

```

        break;
    case 'a':
        if (++a_flag > 1)
            Usage();
        attrids = optarg;
        break;
    case 't':
        if (++t_flag > 1)
            Usage();
        service_type = optarg;
        break;
    case 'u':
        if (++u_flag > 1)
            Usage();
        url = optarg;
        break;
    case 'n':
        if (++n_flag > 1)
            Usage();
        na = optarg;
        break;
    default:
        Usage();
}
}
}

```

Lists of Programming References

The following lists provide references for Transmission Control Protocol/Internet Protocol (TCP/IP):

- “Methods”
- “Files and File Formats”
- “RFCs” on page 310

See “TCP/IP commands” in *Networks and communication management* for information about commands and daemons for using and managing Transmission Control Protocol/Internet Protocol (TCP/IP).

Methods

cfgif	Configures an interface instance in the system configuration database.
cfginet	Loads and configures an Internet instance and its associated instances.
chgif	Reconfigures an instance of a network interface.
chginet	Reconfigures the Internet instance.
defif	Defines a network interface in the configuration database.
definet	Defines an inet instance in the system configuration database.
stpinet	Disables the inet instance.
sttinnet	Enables the inet instance.
ucgif	Unloads an interface instance from the kernel.
ucginet	Unloads the Internet instance and all related interface instances from the kernel.
udefif	Removes an interface object from the system configuration database.
undefinet	Undefined the Internet instance in the configuration database.

Files and File Formats

Domain Cache file format	Defines the root name server or servers for a domain name server host.
Domain Data file format	Stores name resolution information for the named daemon.
Domain Local Data file format	Defines the local loopback information for named on the name server host.
Domain Reverse Data file format	Stores reverse name resolution information for the named daemon.

ftpusers file format	Specifies local user names that cannot be used by remote File Transfer Protocol (FTP) clients.
gated.conf file format	Contains configuration information for the gated daemon.
gateways file format	Specifies Internet routing information to the routed and gated daemons on a network.
hosts file format	Defines the Internet Protocol (IP) name and address of the local host and specifies the names and addresses of remote hosts.
hosts.equiv file format	Specifies remote systems that can execute commands on the local system.
hosts.lpd file format	Specifies remote hosts that can print on the local host.
inetd.conf file format	Defines how the inetd daemon handles Internet service requests.
map3270 file format	Defines a user keyboard mapping and colors for the tn3270 command.
named.conf file format	Defines how named initializes the domain name server file.
.netrc file format	Specifies automatic login information for the ftp and rexec commands.
networks file format	Contains the network name file.
protocols file format	Defines the Internet protocols used on the local host.
rc.net file format	Defines host configuration for the following areas: network interfaces, host name, default gateway, and any static routes.
rc.tcPIP file	Initializes daemons at each system startup.
resolv.conf file format	Defines domain name server information for local resolver routines.
.rhosts file format	Specifies remote users that can use a local user account on a network.
services file format	Defines the sockets and protocols used for Internet services.
Standard Resource Record Format	Defines the format of lines in the DOMAIN data files.
telnet.conf file format	Translates a client's terminal-type strings into terminfo file entries.
.3270keys file format	Defines the default keyboard mapping and colors for the tn and telnet commands.

RFCs

The list of Requests for Comments (RFCs) for TCP/IP includes:

- "Name Server"
- "Telnet" on page 311
- "FTP" on page 311
- "TFTP" on page 311
- "SNMP" on page 311
- "SMTP" on page 311
- "Name/Finger" on page 311
- "Time" on page 311
- "TCP" on page 311
- "UDP" on page 311
- "ARP" on page 311
- "IP" on page 312
- "ICMP" on page 312
- "Link (802.2)" on page 312
- "IP Multicasts" on page 213
- "Others" on page 312

Name Server

- Mail Routing and the Domain System, RFC 974, C. Partridge
- Domain Administrator's Guide, RFC 1032, M. Stahl
- Domain Administrator's Operations Guide, RFC 1033, M. Lottor
- Domain Names—Concepts and Facilities, RFC 1034, P. Mockapetris

- Domain Names—Implementations and Specification, RFC 1035, P. Mockapetris
- Requirements for Internet Hosts—Application and Support, RFC 1123, R. Braden, ed.

Telnet

- Telnet Protocol Specification, RFC 854, J. Postel, J. Reynolds
- Telnet Option Specifications, RFC 855, J. Postel, J. Reynolds
- Telnet Binary Transmission, RFC 856, J. Postel, J. Reynolds
- Telnet Echo Option, RFC 857, J. Postel, J. Reynolds
- Telnet Suppresses Go Ahead Option, RFC 858, J. Postel, J. Reynolds
- Telnet Timing Mark Option, RFC 860, J. Postel, J. Reynolds
- Telnet Window Size Option, RFC 1073, D. Waitzman
- Telnet Terminal Type Option, RFC 1091, J. Von Bokkelen
- Requirements for Internet Hosts—Application and Support, RFC 1123, R. Braden, ed.

FTP

- File Transfer Protocol, RFC 959, J. Postel
- Requirements for Internet Hosts—Application and Support, RFC 1123, R. Braden, ed.

TFTP

- Trivial File Transfer Protocol, RFC 783, K. R. Sollins
- Requirements for Internet Hosts—Application and Support, RFC 1123, R. Braden, ed.

SNMP

See “Simple Network Management Protocol” on page 119.

SMTP

- Simple Mail Transfer Protocol, RFC 821, J. Postel
- Mail Routing and the Domain System, RFC 974, C. Partridge
- Requirements for Internet Hosts—Application and Support, RFC 1123, R. Braden, ed.

Name/Finger

- Name/Finger, RFC 742, K. Harrenstien

Time

- Time Protocol, RFC 868, J. Postel, K. Harrenstien

TCP

- Transmission Control Protocol, RFC 793, J. Postel
- Requirements for Internet Hosts—Communication Layers, RFC 1122, R. Braden, ed.
- TCP Extensions for High Performance, RFC 1323, V. Jacobson, R. Braden, D. Borman

UDP

- User Datagram Protocol, RFC 768, J. Postel
- Requirements for Internet Hosts—Communication Layers, RFC 1122, R. Braden, ed.

ARP

- An Ethernet Address Resolution Protocol, RFC 826, D. Plummer
- Requirements for Internet Hosts—Communication Layers, RFC 1122, R. Braden, ed.
- A Reverse Address Resolution Protocol, RFC 903, R. Finlayson, T. Mann, J. Mogul, M. Theimer

IP

- Internet Protocol, RFC 791, J. Postel
- Stub Exterior Gateway Protocol, RFC 888, L. Seamonson, E. Rosen
- Exterior Gateway Protocol Implementation Schedule, RFC 890, J. Postel
- Exterior Gateway Protocol Format Specification, RFC 904, D. Mills
- Internet Standard Subnetting Procedure, RFC 950, J. Mogul
- Requirements for Internet Gateways, RFC 1009, R. Braden, J. Postel
- Routing Information Protocol, RFC 1058, C. Hedrick
- Requirements for Internet Hosts—Communication Layers, RFC 1122, R. Braden, ed.

ICMP

- Internet Control Message Protocol, RFC 792, J. Postel
- Requirements for Internet Hosts—Communication Layers, RFC 1122, R. Braden, ed.

Link (802.2)

- Standard for the Transmission of IP Datagrams over Public Data Networks, RFC 877, J. Korb
- A Standard for the Transmission of IP Datagrams over IEEE 802 Networks, RFC 1042, J. Postel, J. Reynolds

IP Multicasts

- Host Extensions for IP Multicasting, RFC 1112

Others

- Internet Assigned Numbers, RFC 1010, J. Reynolds, J. Postel
- Official Internet Protocols, RFC 1011, J. Reynolds, J. Postel
- Internet Numbers, RFC 1062, S. Romano, M. Stahl, M. Recker

Chapter 12. Packet Capture Library

The Packet Capture Library information in this chapter is valid only for AIX 5.1 and later releases.

The operating system provides the Berkeley Packet Filter (BPF) as a means of packet capture. The Packet Capture Library (**libpcap.a**) provides a user-level interface to that packet capture facility.

The following code samples are only for illustrating the use of the Packet Capture Library APIs. It is recommended that you write your own applications for optimal function in a production environment.

This chapter discusses the following topics:

- “Packet Capture Library Overview”
- “Packet Capture Library Subroutines” on page 314
- “Packet Capture Library Header Files” on page 314
- “Packet Capture Library Data Structures” on page 314
- “Packet Capture Library Filter Expressions” on page 315
- “Sample 1: Capturing Packet Data and Printing It in Binary Form to the Screen” on page 317
- “Sample 2: Capturing Packet Data and Saving It to a File for Processing Later” on page 320
- “Sample 3: Reading Previously Captured Packet Data from a Savefile and Processing It” on page 324

Packet Capture Library Overview

The Packet Capture Library provides a high-level interface to packet capture systems. In the operating system, the Berkeley Packet Filter (BPF) is the packet capture system. This library provides user-level subroutines that interface with the BPF to allow users access for reading unprocessed network traffic. By using the Packet Capture Library, users can write their own network-monitoring tools. Applications using the Packet Capture Library subroutines must be run as root user. A reference for BPF is in *UNIX Network Programming, Volume 1: Networking APIs: Sockets and XTI*, Second Edition by W. Richard Stevens, 1998.

Performing Packet Capture

To accomplish packet capture, follow these steps:

1. Decide which network device will be the packet capture device. Use the **pcap_lookupdev** subroutine to do this.
2. Obtain a packet capture descriptor by using the **pcap_open_live** subroutine.
3. Choose a packet filter. The filter expression identifies which packets you are interested in capturing.
4. Compile the packet filter into a filter program using the **pcap_compile** subroutine. The packet filter expression is specified in an ASCII string. Refer to Packet Capture Library Filter Expressions for more information.
5. After a BPF filter program is compiled, notify the packet capture device of the filter using the **pcap_setfilter** subroutine. If the packet capture data is to be saved to a file for processing later, open the previously saved packet capture data file, known as the *savefile*, using the **pcap_dump_open** subroutine.
6. Use the **pcap_dispatch** or **pcap_loop** subroutine to read in the captured packets and call the subroutine to process them. This processing subroutine can be the **pcap_dump** subroutine, if the packets are to be written to a *savefile*, or some other subroutine you provide.
7. Call the **pcap_close** subroutine to cleanup the open files and deallocate the resources used by the packet capture descriptor.

Packet Capture Library Subroutines

The Packet Capture Library (**libpcap.a**) subroutines allow users to communicate with the packet capture facility provided by the operating system to read unprocessed network traffic. Applications using these subroutines must be run as root user. The following subroutines are maintained in the **libpcap.a** library:

- **pcap_close**
- **pcap_compile**
- **pcap_datalink**
- **pcap_dispatch**
- **pcap_dump**
- **pcap_dump_close**
- **pcap_dump_open**
- **pcap_file**
- **pcap_fileno**
- **pcap_geterr**
- **pcap_is_swapped**
- **pcap_lookupdev**
- **pcap_lookupnet**
- **pcap_loop**
- **pcap_major_version**
- **pcap_minor_version**
- **pcap_next**
- **pcap_open_live**
- **pcap_open_offline**
- **pcap_perror**
- **pcap_setfilter**
- **pcap_snapshot**
- **pcap_stats**
- **pcap_strerror**

Packet Capture Library Header Files

The `/usr/include/pcap.h` file is the header file that should be included in all applications using **libpcap.a**. This file contains data definitions, structures, constants, and macros used by the packet capture library subroutines.

Packet Capture Library Data Structures

The three data structures defined in the `/usr/include/pcap.h` file for use with the **libpcap.a** subroutines are as follows:

struct pcap_file_header	This structure defines the first record in the <i>savefile</i> that contains the saved packet capture data.
struct pcap_pkthdr	This is the structure that defines the packet header that is added to the front of each packet that is written to the <i>savefile</i> .
struct pcap_stat	This structure is returned by the pcap_stats subroutine, and contains information related to the packet statistics from the start of the packet capture session to the time of the call to the pcap_stats subroutine.

Packet Capture Library Filter Expressions

The filter expression is passed into the `pcap_compile` subroutine to specify the packets that should be captured. If no filter expression is given, all packets on the network will be captured. Otherwise, only packets for which the filter expression is True will be captured. The filter expression is an ASCII string that consists of one or more primitives. Primitives usually consist of an *id* (name or number) preceded by one or more qualifiers. There are three types of qualifiers:

<i>type</i>	Specifies what kind of device the <i>id</i> name or number refers to. Possible types are host , net , and port . Examples are <code>host foo</code> , <code>net 128.3</code> , <code>port 20</code> . If there is no <i>type</i> qualifier, then host is assumed.
<i>dir</i>	Specifies a particular transfer direction to or from <i>id</i> . Possible directions are src , dst , src or dst , and src and dst . Some examples with <i>dir</i> qualifiers are: <code>src foo</code> , <code>dst net 128.3</code> , <code>srcor dst port ftp-data</code> . If there is no <i>dir</i> qualifier, src or dst is assumed.
<i>proto</i>	Restricts the match to a particular protocol. Possible <i>proto</i> qualifiers are: ether , ip , arp , rarp , tcp , and udp . Examples are: <code>ether src foo</code> , <code>arp net 128.3</code> , <code>tcp port 21</code> . If there is no <i>proto</i> qualifier, all protocols consistent with the <i>type</i> are assumed. For example, <code>src foo</code> means <code>ip</code> or <code>arp</code> , <code>net bar</code> means <code>ip</code> or <code>arp</code> or <code>rarp</code> , and <code>port 53</code> means <code>tcp</code> or <code>udp</code> port 53.

There are also some special primitive keywords that do not follow the pattern: **broadcast**, **multicast**, **less**, **greater**, and arithmetic expressions. All of these keywords are described in the following information.

Allowable Primitives

The following primitives are allowed:

dst host <i>Host</i>	True if the value of the IP (Internet Protocol) destination field of the packet is the same as the value of the <i>Host</i> variable, which can be either an address or a name.
dst port <i>Port</i>	True if the packet is TCP/IP (Transmission Control Protocol/Internet Protocol) or IP/UDP (Internet Protocol/User Datagram Protocol) and has a destination port value of <i>Port</i> . The port can be a number or a name used in /etc/services . If a name is used, both the port number and protocol are checked. If a number or ambiguous name is used, only the port number is checked (<code>dst port 513</code> will print both TCP/login traffic and UDP/who traffic, and <code>port domain</code> will print both TCP/domain and UDP/domain traffic).
DST net <i>Net</i>	True if the value of the IP destination address of the packet has a network number of <i>Net</i> . Note that <i>Net</i> must be in dotted decimal format.
greater <i>Length</i>	True if the packet has a length greater than or equal to the <i>Length</i> variable. This is equivalent to the following: len > = Length
host <i>Host</i>	True if the value of either the IP source or destination of the packet is the same as the value of the <i>Host</i> variable. You can add the keywords ip , arp , or rarp in front of any previous host expressions as in the following: ip host <i>Host</i> If the <i>Host</i> variable is a name with multiple IP addresses, each address will be checked for a match.
ip, arp, rarp	These keywords are abbreviated forms of the following: proto ip , proto arp , and proto rarp .
ip broadcast	True if the packet is an IP broadcast packet. It checks for the all-zeroes and all-ones broadcast conventions, and looks up the local subnet mask.
ip multicast	True if the packet is an IP multicast packet.
ip proto <i>Protocol</i>	True if the packet is an IP packet of protocol type <i>Protocol</i> . <i>Protocol</i> can be a number or one of the names icmp , udp , or tcp .
less <i>Length</i>	True if the packet has a length less than or equal to <i>Length</i> . This is equivalent to the following: len < = Length

net <i>Net</i>	True if the value of either the IP source or destination address of the packet has a network number of <i>Net</i> . Note that <i>Net</i> must be in dotted decimal format
net <i>Net/Len</i>	True if the value of either the IP source or destination address of the packet has a network number of <i>Net</i> and a netmask with the width of <i>Len</i> bits. Note that <i>Net</i> must be in dotted decimal format.
net <i>Net mask Mask</i>	True if the value of either the IP source or destination address of the packet has a network number of <i>Net</i> and the specific netmask of <i>Mask</i> . Note that <i>Net</i> and <i>Mask</i> must be in dotted decimal format.
port <i>Port</i>	True if the value of either the source or the destination port of the packet is <i>Port</i> . You can add the keywords tcp or udp in front of any of the previous port expressions, as in the following: tcp src port port which matches only TCP packets.
proto <i>Protocol</i>	True if the packet is of type <i>Protocol</i> . <i>Protocol</i> can be a number or a name like ip , arp , or rarp .
src host <i>Host</i>	True if the value of the IP source field of the packet is the same as the value of the <i>Host</i> variable.
src net <i>Net</i>	True if the value of the IP source address of the packet has a network number of <i>Net</i> . Note that <i>Net</i> must be in dotted decimal format.
src port <i>Port</i>	True if the value of the <i>Port</i> variable is the same as the value of the source port.
tcp, udp, icmp	These keywords are abbreviated forms of the following: ip proto tcp, ip proto udp, or ip proto icmp

Relational Operators of the Expression Parameter

The simple relationship:

expr relop expr

Is true where *relop* is one of the following:

- ampersand (&)
- asterisk (*)
- equal (=)
- exclamation point and equal sign (!=) and *expr* is an arithmetic expression composed of integer constants (expressed in standard C syntax)
- greater than (>)
- greater than or equal to (>=)
- less than (<)
- less than or equal to (<=)
- length operator
- minus sign (-)
- pipe (|)
- plus sign (+)
- slash (/)
- special packet data accessors

To access data inside the packet, use the following syntax:

proto [expr : size]

Proto is one of the keywords **ip**, **arp**, **rarp**, **tcp** or **icmp**, and indicates the protocol layer for the index operation. The byte offset relative to the indicated protocol layer is given by *expr*. The indicator *size* is

optional and indicates the number of bytes in the field of interest; it can be either one, two, or four, and defaults to one byte. The length operator, indicated by the keyword **len**, gives the length of the packet.

For example, expression `ip[0] & 0xf != 5` catches only nonfragmented datagrams and frag 0 of fragmented datagrams. This check is implicitly implied to the **tcp** and **udp** index operations. For example, **tcp[0]** always means the first byte of the TCP header, and never means the first byte of an intervening fragment.

Combining Primitives

More complex filter expressions are created by using the words **and**, **or**, and **not** to combine primitives. For example, `host foo and not port ftp and not port ftp-data`. To save typing, identical qualifier lists can be omitted. For example, `tcp dst port ftp or ftp-data or domain` is exactly the same as `tcp dst port ftp or tcp dst port ftp-data or tcp dst port domain`.

Primitives can be combined using a parenthesized group of primitives and operators:

- A
- Negation (`!` or `not`).
- Concatenation (`and`).
- Alternation (`or`).

Negation has highest precedence. Alternation and concatenation have equal precedence and associate left to right.

If an identifier is given without a keyword, the most recent keyword is assumed. For example:

```
not host gil and devo
```

This filter captures packets that do not have a source or destination of host gil and also packets that do have a source or destination of host devo. It is an abbreviated version of the following:

```
not host gil and host devo
```

Avoid confusing it with the following filter which captures packets that do not have a source or destination of either gil or devo:

```
not (host gil or devo)
```

Sample 1: Capturing Packet Data and Printing It in Binary Form to the Screen

The following code sample demonstrates capturing packet data and printing it in binary form to the screen. This sample is only for illustrating the use of the Packet Capture Library APIs. It is recommended that you write your own application for optimal function in a production environment.

```
/*
 * Use pcap_open_live() to open a packet capture device and use pcap_dump()
 * to output the packet capture data in binary format to standard out. The
 * output can be piped to another program, such as the one in Sample 3,
 * for formatting and readability.
 */

#include <stdio.h>
#include <pcap.h>
#include <netinet/in.h>
#include <sys/socket.h>

#include <string.h>

#define FLTRSZ 120
#define MAXHOSTSZ 256
#define ADDR_STRSZ 16
```

```

extern char *inet_ntoa();

int
main(int argc, char **argv)
{
    pcap_t *p;           /* packet capture descriptor */
    pcap_dumper_t *pd;  /* pointer to the dump file */
    char *ifname;       /* interface name (such as "en0") */
    char errbuf[PCAP_ERRBUF_SIZE]; /* buffer to hold error text */
    char lhost[MAXHOSTSZ]; /* local host name */
    char fltstr[FLTRSZ]; /* bpf filter string */
    char prestr[80];     /* prefix string for errors from pcap_perror */
    struct bpf_program prog; /* compiled bpf filter program */
    int optimize = 1;   /* passed to pcap_compile to do optimization */
    int snaplen = 80;   /* amount of data per packet */
    int promisc = 0;    /* do not change mode; if in promiscuous */
                        /* mode, stay in it, otherwise, do not */

    int to_ms = 1000;   /* timeout, in milliseconds */
    int count = 20;     /* number of packets to capture */
    u_int32 net = 0;    /* network IP address */
    u_int32 mask = 0;   /* network address mask */
    char netstr[INET_ADDRSTRLEN]; /* dotted decimal form of address */
    char maskstr[INET_ADDRSTRLEN]; /* dotted decimal form of net mask */

    /*
     * Find a network device on the system.
     */
    if (!(ifname = pcap_lookupdev(errbuf))) {
        fprintf(stderr, "Error getting device on system: %s\n", errbuf);
        exit(1);
    }

    /*
     * Open the network device for packet capture. This must be called
     * before any packets can be captured on the network device.
     */
    if (!(p = pcap_open_live(ifname, snaplen, promisc, to_ms, errbuf))) {
        fprintf(stderr,
            "Error opening interface %s: %s\n", ifname, errbuf);
        exit(2);
    }

    /*
     * Look up the network address and subnet mask for the network device
     * returned by pcap_lookupdev(). The network mask will be used later
     * in the call to pcap_compile().
     */
    if (pcap_lookupnet(ifname, &net, &mask, errbuf) < 0) {
        fprintf(stderr, "Error looking up network: %s\n", errbuf);
        exit(3);
    }

    /*
     * Create the filter and store it in the string called 'fltstr.'
     * Here, you want only incoming packets (destined for this host),
     * which use port 23 (telnet), and originate from a host on the
     * local network.
     */

    /* First, get the hostname of the local system */
    if (gethostname(lhost, sizeof(lhost)) < 0) {
        fprintf(stderr, "Error getting hostname.\n");
        exit(4);
    }

    /*

```



```

    * Second, get the dotted decimal representation of the network address
    * and netmask. These will be used as part of the filter string.
    */
inet_ntop(AF_INET, (char*) &net, netstr, sizeof netstr);
inet_ntop(AF_INET, (char*) &mask, maskstr, sizeof maskstr);

/* Next, put the filter expression into the fltstr string. */
sprintf(fltstr,"dst host %s and src net %s mask %s and tcp port 23",
        lhost, netstr, maskstr);

/*
 * Compile the filter. The filter will be converted from a text
 * string to a bpf program that can be used by the Berkely Packet
 * Filtering mechanism. The fourth argument, optimize, is set to 1 so
 * the resulting bpf program, prog, is compiled for better performance.
 */
if (pcap_compile(p,&prog,fltstr,optimize,mask) < 0) {
    /*
     * Print out appropriate text, followed by the error message
     * generated by the packet capture library.
     */
    fprintf(stderr, "Error compiling bpf filter on %s: %s\n",
            ifname, pcap_geterr(p));
    exit(5);
}

/*
 * Load the compiled filter program into the packet capture device.
 * This causes the capture of the packets defined by the filter
 * program, prog, to begin.
 */
if (pcap_setfilter(p, &prog) < 0) {
    /* Copy appropriate error text to prefix string, prestr */
    sprintf(prestr, "Error installing bpf filter on interface %s",
            ifname);
    /*
     * Print out error. The format will be the prefix string,
     * created above, followed by the error message that the packet
     * capture library generates.
     */
    pcap_perror(p,prestr);
    exit(6);
}

/*
 * Open dump device for writing packet capture data. Passing in "-"
 * indicates that packets are to be written to standard output.
 * pcap_dump() will be called to write the packet capture data in
 * binary format, so the output from this program can be piped into
 * another application for further processing or formatting before
 * reading.
 */
if ((pd = pcap_dump_open(p,"-")) == NULL) {
    /*
     * Print out error message if pcap_dump_open failed. This will
     * be the below message followed by the pcap library error text,
     * obtained by pcap_geterr().
     */
    fprintf(stderr, "Error opening dump device stdout: %s\n",
            pcap_geterr(p));
    exit(7);
}

/*
 * Call pcap_loop() to read and process a maximum of count (20)
 * packets. For each captured packet (a packet that matches the filter
 * specified to pcap_compile()), pcap_dump() will be called to write

```

```

    * the packet capture data (in binary format) to the savefile specified
    * to pcap_dump_open(). Note that the packet in this case may not be a
    * complete packet. The amount of data captured per packet is
    * determined by the snaplen variable which is passed to
    * pcap_open_live().
    */
if (pcap_loop(p, count, &pcap_dump, (char *)pd) < 0) {
    /*
     * Print out appropriate text, followed by the error message
     * generated by the packet capture library.
     */
    sprintf(prestr, "Error reading packets from interface %s",
            ifname);
    pcap_perror(p, prestr);
    exit(8);
}

/*
 * Close the packet capture device and free the memory used by the
 * packet capture descriptor.
 */
pcap_close(p);
}

```

Sample 2: Capturing Packet Data and Saving It to a File for Processing Later

The following code sample demonstrates capturing packet data and saving it to a file for processing. This sample is only for illustrating the use of the Packet Capture Library APIs. It is recommended that you write your own application for optimal function in a production environment.

```

/*
 * Use pcap_open_live() to open a packet capture device.
 * Use pcap_dump() to output the packet capture data in
 * binary format to a file for processing later.
 */

#include <unistd.h>
#include <stdio.h>
#include <pcap.h>
#include <netinet/in.h>
#include <sys/socket.h>

#define IFSZ 16
#define FLTRSZ 120
#define MAXHOSTSZ 256
#define PCAP_SAVEFILE "./pcap_savefile"

extern char *inet_ntoa();

int
usage(char *progname)
{
    printf("Usage: %s <interface> [<savefile name>]\n", basename(progname));
    exit(11);
}

int
main(int argc, char **argv)
{
    pcap_t *p;           /* packet capture descriptor */
    struct pcap_stat ps; /* packet statistics */
    pcap_dumper_t *pd;  /* pointer to the dump file */
    char ifname[IFSZ];  /* interface name (such as "en0") */
    char filename[80];  /* name of savefile for dumping packet data */
    char errbuf[PCAP_ERRBUF_SIZE]; /* buffer to hold error text */

```

```

char lhost[MAXHOSTSZ]; /* local host name */
char fltstr[FLTRSZ]; /* bpf filter string */
char prestr[80]; /* prefix string for errors from pcap_perror */
struct bpf_program prog; /* compiled bpf filter program */
int optimize = 1; /* passed to pcap_compile to do optimization */
int snaplen = 80; /* amount of data per packet */
int promisc = 0; /* do not change mode; if in promiscuous */
/* mode, stay in it, otherwise, do not */

int to_ms = 1000; /* timeout, in milliseconds */
int count = 20; /* number of packets to capture */
u_int32 net = 0; /* network IP address */
u_int32 mask = 0; /* network address mask */
char netstr[INET_ADDRSTRLEN]; /* dotted decimal form of address */
char maskstr[INET_ADDRSTRLEN]; /* dotted decimal form of net mask */
int linktype = 0; /* data link type */
int pcount = 0; /* number of packets actually read */

/*
 * For this program, the interface name must be passed to it on the
 * command line. The savefile name may be optionally passed in
 * as well. If no savefile name is passed in, "./pcap_savefile" is
 * used. If there are no arguments, the program has been invoked
 * incorrectly.
 */
if (argc < 2)
    usage(argv[0]);

if (strlen(argv[1]) > IFSZ) {
    fprintf(stderr, "Invalid interface name.\n");
    exit(1);
}
strcpy(iframe, argv[1]);

/*
 * If there is a second argument (the name of the savefile), save it in
 * filename. Otherwise, use the default name.
 */
if (argc >= 3)
    strcpy(filename, argv[2]);
else
    strcpy(filename, PCAP_SAVEFILE);

/*
 * Open the network device for packet capture. This must be called
 * before any packets can be captured on the network device.
 */
if (!(p = pcap_open_live(iframe, snaplen, promisc, to_ms, errbuf))) {
    fprintf(stderr, "Error opening interface %s: %s\n",
            iframe, errbuf);
    exit(2);
}

/*
 * Look up the network address and subnet mask for the network device
 * returned by pcap_lookupdev(). The network mask will be used later
 * in the call to pcap_compile().
 */
if (pcap_lookupnet(iframe, &net, &mask, errbuf) < 0) {
    fprintf(stderr, "Error looking up network: %s\n", errbuf);
    exit(3);
}

/*
 * Create the filter and store it in the string called 'fltstr.'
 * Here, you want only incoming packets (destined for this host),
 * which use port 69 (tftp), and originate from a host on the
 * local network.

```

```

*/

/* First, get the hostname of the local system */
if (gethostname(lhost,sizeof(lhost)) < 0) {
    fprintf(stderr, "Error getting hostname.\n");
    exit(4);
}

/*
 * Second, get the dotted decimal representation of the network address
 * and netmask. These will be used as part of the filter string.
 */
inet_ntop(AF_INET, (char*) &net, netstr, sizeof netstr);
inet_ntop(AF_INET, (char*) &mask, maskstr, sizeof maskstr);

/* Next, put the filter expression into the fltstr string. */
sprintf(fltstr,"dst host %s and src net %s mask %s and udp port 69",
    lhost, netstr, maskstr);

/*
 * Compile the filter. The filter will be converted from a text
 * string to a bpf program that can be used by the Berkely Packet
 * Filtering mechanism. The fourth argument, optimize, is set to 1 so
 * the resulting bpf program, prog, is compiled for better performance.
 */
if (pcap_compile(p,&prog,fltstr,optimize,mask) < 0) {
    /*
     * Print out appropriate text, followed by the error message
     * generated by the packet capture library.
     */
    fprintf(stderr, "Error compiling bpf filter on %s: %s\n",
        ifname, pcap_geterr(p));
    exit(5);
}

/*
 * Load the compiled filter program into the packet capture device.
 * This causes the capture of the packets defined by the filter
 * program, prog, to begin.
 */
if (pcap_setfilter(p, &prog) < 0) {
    /* Copy appropriate error text to prefix string, prestr */
    sprintf(prestr, "Error installing bpf filter on interface %s",
        ifname);
    /*
     * Print error to screen. The format will be the prefix string,
     * created above, followed by the error message that the packet
     * capture library generates.
     */
    pcap_perror(p,prestr);
    exit(6);
}

/*
 * Open dump device for writing packet capture data. In this sample,
 * the data will be written to a savefile. The name of the file is
 * passed in as the filename string.
 */
if ((pd = pcap_dump_open(p,filename)) == NULL) {
    /*
     * Print out error message if pcap_dump_open failed. This will
     * be the below message followed by the pcap library error text,
     * obtained by pcap_geterr().
     */
    fprintf(stderr,
        "Error opening savefile \"%s\" for writing: %s\n",
        filename, pcap_geterr(p));
}

```

```

        exit(7);
    }

    /*
    * Call pcap_dispatch() to read and process a maximum of count (20)
    * packets. For each captured packet (a packet that matches the filter
    * specified to pcap_compile()), pcap_dump() will be called to write
    * the packet capture data (in binary format) to the savefile specified
    * to pcap_dump_open(). Note that packet in this case may not be a
    * complete packet. The amount of data captured per packet is
    * determined by the snaplen variable which is passed to
    * pcap_open_live().
    */
    if ((pcount = pcap_dispatch(p, count, &pcap_dump, (char *)pd)) < 0) {
        /*
        * Print out appropriate text, followed by the error message
        * generated by the packet capture library.
        */
        sprintf(prestr, "Error reading packets from interface %s",
                ifname);
        pcap_perror(p, prestr);
        exit(8);
    }
    printf("Packets received and successfully passed through filter: %d.\n",
           pcount);

    /*
    * Get and print the link layer type for the packet capture device,
    * which is the network device selected for packet capture.
    */
    if (!(linktype = pcap_datalink(p))) {
        fprintf(stderr,
                "Error getting link layer type for interface %s",
                ifname);
        exit(9);
    }
    printf("The link layer type for packet capture device %s is: %d.\n",
           ifname, linktype);

    /*
    * Get the packet capture statistics associated with this packet
    * capture device. The values represent packet statistics from the time
    * pcap_open_live() was called up until this call.
    */
    if (pcap_stats(p, &ps) != 0) {
        fprintf(stderr, "Error getting Packet Capture stats: %s\n",
                pcap_geterr(p));
        exit(10);
    }

    /* Print the statistics out */
    printf("Packet Capture Statistics:\n");
    printf("%d packets received by filter\n", ps.ps_recv);
    printf("%d packets dropped by kernel\n", ps.ps_drop);

    /*
    * Close the savefile opened in pcap_dump_open().
    */
    pcap_dump_close(pd);
    /*
    * Close the packet capture device and free the memory used by the
    * packet capture descriptor.
    */
    pcap_close(p);
}

```

Sample 3: Reading Previously Captured Packet Data from a Savefile and Processing It

The following code sample demonstrates reading previously captured packet data from a *savefile* and processing it. This sample is only for illustrating the use of the Packet Capture Library APIs. It is recommended that you write your own application for optimal function in a production environment.

```
/*
 * Use pcap_open_offline() to open a savefile, containing packet capture data,
 * and use the print_addr() routine to print the source and destination IP
 * addresses from the packet capture data to stdout.
 */

#include <stdio.h>
#include <pcap.h>

#define IFSZ 16
#define FLTRSZ 120
#define MAXHOSTSZ 256
#define PCAP_SAVEFILE "./pcap_savefile"

int packets = 0; /* running count of packets read in */

int
usage(char *progname)
{
    printf("Usage: %s <interface> [<savefile name>]\n", basename(progname));
    exit(7);
}

/*
 * Function:    print_addr()
 *
 * Description: Write source and destination IP addresses from packet data
 *              out to stdout.
 *              For simplification, in this sample, assume the
 *              following about the captured packet data:
 *              - the addresses are IPv4 addresses
 *              - the data link type is ethernet
 *              - ethernet encapsulation, according to RFC 894, is used.
 *
 * Return:     0 upon success
 *            -1 on failure (if packet data was cut off before IP addresses).
 */
void
print_addr(u_char *user, const struct pcap_pkthdr *hdr, const u_char *data)
{
    int offset = 26; /* 14 bytes for MAC header +
                    * 12 byte offset into IP header for IP addresses
                    */

    if (hdr->caplen < 30) {
        /* captured data is not long enough to extract IP address */
        fprintf(stderr,
            "Error: not enough captured packet data present to extract IP addresses.\n");
        return;
    }

    printf("Packet received from source address %d.%d.%d.%d\n",
        data[offset], data[offset+1], data[offset+2], data[offset+3]);
    if (hdr->caplen >= 34) {
        printf("and destined for %d.%d.%d.%d\n",
            data[offset+4], data[offset+5],
            data[offset+6], data[offset+7]);
    }
}
```

```

        packets++; /* keep a running total of number of packets read in */
    }

int
main(int argc, char **argv)
{
    pcap_t *p;          /* packet capture descriptor */
    char ifname[IFSZ];  /* interface name (such as "en0") */
    char filename[80];  /* name of savefile to read packet data from */
    char errbuf[PCAP_ERRBUF_SIZE]; /* buffer to hold error text */
    char prestr[80];    /* prefix string for errors from pcap_perror */
    int majver = 0, minver = 0; /* major and minor numbers for the */
                                /* current Pcap library version */

    /*
     * For this program, the interface name must be passed to it on the
     * command line. The savefile name may optionally be passed in
     * as well. If no savefile name is passed in, "./pcap_savefile" is
     * assumed. If there are no arguments, program has been invoked
     * incorrectly.
     */
    if (argc < 2)
        usage(argv[0]);

    if (strlen(argv[1]) > IFSZ) {
        fprintf(stderr, "Invalid interface name.\n");
        exit(1);
    }
    strcpy(ifname, argv[1]);

    /*
     * If there is a second argument (the name of the savefile), save it in
     * filename. Otherwise, use the default name.
     */
    if (argc >= 3)
        strcpy(filename, argv[2]);
    else
        strcpy(filename, PCAP_SAVEFILE);

    /*
     * Open a file containing packet capture data. This must be called
     * before processing any of the packet capture data. The file
     * containing packet capture data should have been generated by a
     * previous call to pcap_open_live().
     */
    if (!(p = pcap_open_offline(filename, errbuf))) {
        fprintf(stderr,
            "Error in opening savefile, %s, for reading: %s\n",
            filename, errbuf);
        exit(2);
    }

    /*
     * Call pcap_dispatch() with a count of 0 which will cause
     * pcap_dispatch() to read and process packets until an error or EOF
     * occurs. For each packet read from the savefile, the output routine,
     * print_addr(), will be called to print the source and destinations
     * addresses from the IP header in the packet capture data.
     * Note that packet in this case may not be a complete packet. The
     * amount of data captured per packet is determined by the snaplen
     * variable which was passed into pcap_open_live() when the savefile
     * was created.
     */
    if (pcap_dispatch(p, 0, &print_addr, (char *)0) < 0) {
        /*
         * Print out appropriate text, followed by the error message

```

```

        * generated by the packet capture library.
        */
        sprintf(prestr,"Error reading packets from interface %s",
                ifname);
        pcap_perror(p,prestr);
        exit(4);
    }

    printf("\nPackets read in: %d\n", packets);

    /*
    * Print out the major and minor version numbers. These are the version
    * numbers associated with this revision of the packet capture library.
    * The major and minor version numbers can be used to help determine
    * what revision of libpcap created the savefile, and, therefore, what
    * format was used when it was written.
    */

    if (!(majver = pcap_major_version(p))) {
        fprintf(stderr,
                "Error getting major version number from interface %s",
                ifname);
        exit(5);
    }
    printf("The major version number used to create the savefile was: %d.\n", majver);

    if (!(minver = pcap_minor_version(p))) {
        fprintf(stderr,
                "Error getting minor version number from interface %s",
                ifname);
        exit(6);
    }
    printf("The minor version number used to create the savefile was: %d.\n", minver);

    /*
    * Close the packet capture device and free the memory used by the
    * packet capture descriptor.
    */

    pcap_close(p);
}

```

Appendix. Notices

This information was developed for products and services offered in the U.S.A.

IBM may not offer the products, services, or features discussed in this document in other countries. Consult your local IBM representative for information on the products and services currently available in your area. Any reference to an IBM product, program, or service is not intended to state or imply that only that IBM product, program, or service may be used. Any functionally equivalent product, program, or service that does not infringe any IBM intellectual property right may be used instead. However, it is the user's responsibility to evaluate and verify the operation of any non-IBM product, program, or service.

IBM may have patents or pending patent applications covering subject matter described in this document. The furnishing of this document does not give you any license to these patents. You can send license inquiries, in writing, to:

IBM Director of Licensing
IBM Corporation
North Castle Drive
Armonk, NY 10504-1785
U.S.A.

The following paragraph does not apply to the United Kingdom or any other country where such provisions are inconsistent with local law: INTERNATIONAL BUSINESS MACHINES CORPORATION PROVIDES THIS PUBLICATION "AS IS" WITHOUT WARRANTY OF ANY KIND, EITHER EXPRESS OR IMPLIED, INCLUDING, BUT NOT LIMITED TO, THE IMPLIED WARRANTIES OF NON-INFRINGEMENT, MERCHANTABILITY OR FITNESS FOR A PARTICULAR PURPOSE. Some states do not allow disclaimer of express or implied warranties in certain transactions, therefore, this statement may not apply to you.

This information could include technical inaccuracies or typographical errors. Changes are periodically made to the information herein; these changes will be incorporated in new editions of the publication. IBM may make improvements and/or changes in the product(s) and/or the program(s) described in this publication at any time without notice.

Licensees of this program who wish to have information about it for the purpose of enabling: (i) the exchange of information between independently created programs and other programs (including this one) and (ii) the mutual use of the information which has been exchanged, should contact:

IBM Corporation
Dept. LRAS/Bldg. 003
11400 Burnet Road
Austin, TX 78758-3498
U.S.A.

Such information may be available, subject to appropriate terms and conditions, including in some cases, payment of a fee.

The licensed program described in this document and all licensed material available for it are provided by IBM under terms of the IBM Customer Agreement, IBM International Program License Agreement or any equivalent agreement between us.

For license inquiries regarding double-byte (DBCS) information, contact the IBM Intellectual Property Department in your country or send inquiries, in writing, to:

IBM World Trade Asia Corporation
Licensing
2-31 Roppongi 3-chome, Minato-ku
Tokyo 106-0032, Japan

IBM may use or distribute any of the information you supply in any way it believes appropriate without incurring any obligation to you.

Information concerning non-IBM products was obtained from the suppliers of those products, their published announcements or other publicly available sources. IBM has not tested those products and cannot confirm the accuracy of performance, compatibility or any other claims related to non-IBM products. Questions on the capabilities of non-IBM products should be addressed to the suppliers of those products.

Any references in this information to non-IBM Web sites are provided for convenience only and do not in any manner serve as an endorsement of those Web sites. The materials at those Web sites are not part of the materials for this IBM product and use of those Web sites is at your own risk.

This information contains examples of data and reports used in daily business operations. To illustrate them as completely as possible, the examples include the names of individuals, companies, brands, and products. All of these names are fictitious and any similarity to the names and addresses used by an actual business enterprise is entirely coincidental.

COPYRIGHT LICENSE:

This information contains sample application programs in source language, which illustrates programming techniques on various operating platforms. You may copy, modify, and distribute these sample programs in any form without payment to IBM, for the purposes of developing, using, marketing or distributing application programs conforming to the application programming interface for the operating platform for which the sample programs are written. These examples have not been thoroughly tested under all conditions. IBM, therefore, cannot guarantee or imply reliability, serviceability, or function of these programs. You may copy, modify, and distribute these sample programs in any form without payment to IBM for the purposes of developing, using, marketing, or distributing application programs conforming to IBM's application programming interfaces.

Each copy or any portion of these sample programs or any derivative work, must include a copyright notice as follows:

(c) (your company name) (year). Portions of this code are derived from IBM Corp. Sample Programs. (c) Copyright IBM Corp. _enter the year or years_. All rights reserved.

Trademarks

IBM, the IBM logo, and ibm.com are trademarks or registered trademarks of International Business Machines Corp., registered in many jurisdictions worldwide. Other product and service names might be trademarks of IBM or other companies. A current list of IBM trademarks is available on the Web at www.ibm.com/legal/copytrade.shtml

UNIX is a registered trademark of The Open Group in the United States and other countries.

Other company, product, or service names may be the trademarks or service marks of others.

Index

A

- addresses
 - binding 206
 - NDD 199
 - obtaining 207
 - Socket
 - data structures 195
 - families 196
 - storage 198
 - TCP/IP 198
 - translation 214, 218
- agent (SNMP) 125
- array data type (XDR) 89
- arrays
 - XDR 106
 - XDR filter primitive 97
- authentication 138
 - DES
 - RPC 140, 168
 - NULL (RPC) 139
 - UNIX (RPC) 139, 166

B

- batching (RPC) 153
- binding
 - Sockets 205, 206
- binding processes (RPC) 133
- boolean
 - data type (XDR) 86
 - RPC 86
- booleans
 - RPC 159
- broadcasting (RPC) 154, 177
 - server side 161
- byte-order translation 218

C

- C preprocessor (RPC) 161
- callback
 - RPC 180
- callback procedures
 - RPC 154
- canonical data representation (XDR) 80
- client routines 109
- clients
 - agent 110, 112
 - binding 133
- clocks 141
- communications domains (Sockets) 196
- connections (Sockets) 207
- constants
 - RPC language 157
 - XDR language 92
- conversion routines 110

D

- data description 102
- data link control 2
- data representation
 - canonical 80
- data streams (XDR) 98
- data structures 314
- data transfer, (Sockets) 210
- data types
 - passing 175
- data types (XDR) 84
- database
 - MIB 123
- database manager 77
- datagram services
 - connectionless 209
- datagram sockets 203
- DBM
 - NDBM equivalents 78
 - subroutines 78
- DCL8023 (IEEE 802.3 Ethernet data link control) 24
- declarations
 - RPC language 158
 - XDR language 83
- DES
 - authentication
 - RPC 143, 168
- DES authentication
 - protocol 142
 - RPC 140
- Diffie-Hellman encryption 143
- discriminated union
 - example 91
- discriminated union (XDR)
 - example 107
 - XDR 91
- DLC (data link control) 12, 24, 34, 44
 - device manager environment
 - components 3
 - multiuser configuration 3
 - structure 2
 - error logging facility 9
 - generic 2
 - programming procedures 11
 - qualified logical link control 51
 - reference information 11
- DLC_ENABLE_SAP 21
- DLC8023
 - programming interfaces 31
 - protocol support 26
 - data packet 26
 - response modes 26
 - station types 26
- DLC8023 (IEEE 802.3 Ethernet data link control)
 - connection contention 30
 - direct network services 30

- DLC8023 (IEEE 802.3 Ethernet data link control)
 - (*continued*)
 - link sessions
 - initializing 30
 - terminating 31
 - name-discovery services 27
 - overview 24
 - DLC8023 device manager
 - functions 25
 - nodes 25
 - DLCETHER (standard Ethernet data link control) 34
 - connection contention 40
 - device manager functions 35
 - device manager nodes 35
 - direct network services 40
 - link sessions
 - initiating 40
 - terminating 41
 - name-discovery services 37
 - overview 34
 - programming interfaces 41
 - protocol support 36
 - DLCQLLC device manager 51
 - DLCTOKEN
 - device manager
 - ADM and ABME modes 13
 - functions of 14
 - introduction 12
 - DLCTOKEN (token-ring data link control) 12
 - connection contention 19
 - device manager functions 14
 - device manager nodes 13
 - direct network services 19
 - initiating link sessions 19
 - name-discovery services 16
 - programming interfaces 20
 - protocol support
 - data packet 15
 - response modes 15
 - station types 15
 - drivers
 - configuring, in PSE 279
 - STREAMS 275

E

- enumeration data type (XDR) 86
- enumerations
 - RPC language 157
 - XDR language 83
- error logging
 - SMUX example subroutines 128
- example
 - XDR 105
- eXternal Data Representation 79

F

- FDDIDLC
 - connection contention 63
 - device manager functions 58

- FDDIDLC (*continued*)
 - device manager nodes 58
 - device protocol support 59
 - direct network services 63
 - initiating link sessions 63
 - name-discovery services 60
 - programming interfaces 64
- Fiber Distributed Data Interface 57
- filter expressions 315
- filter primitives
 - basic 95
 - constructed 96
- floating-point data types (XDR) 86
- Flow Control, STREAMS 256

G

- GDLC
 - overview 2
- GDLC (generic data link control)
 - criteria 4
 - interface
 - implementing 4
 - ioctl operations 5
 - kernel services 7
 - problem determination
 - error logs 9
 - LAN monitor trace 10
 - link station trace 10
 - overview 8
 - status information 8
 - generic data link control 2

H

- handles
 - RPC 163, 164
- header files 314
 - Sockets 195, 250
- highest layer
 - RPC 149

I

- I/O modes
 - sockets 212
- idsocket 210
- include files
 - Sockets 195
- integer data type (XDR) 85
- interface (Sockets) 193, 194
- intermediate layer 149
 - RPC 170
- internet protocol
 - multicasts 213
- intrinsic functions
 - list of 127
- ioctl operations
 - Sockets 203
 - STREAMS 267

L

- LAN
 - monitor trace 10
- language (RPC) 155
- language specifications (XDR) 82
- libraries
 - RPC run-time 109
 - XDR 81, 94
- library
 - Sockets 194
 - XDR 95
- link station 6
- linked lists (XDR) 100
- links
 - testing 7
 - tracing 7
- LLC 13, 14
- local-busy mode 7
- location broker
 - client agent 110, 112
 - components 110
 - daemons 110
 - global 113
 - local 113
 - overview 110
- log device driver 277, 278
- lowest layer
 - RPC 151
- LS
 - definition 6
 - statistics
 - querying 7
- LS (link station)
 - trace facilities
 - channels 10
 - trace facility
 - entries 10
 - entry size 10
 - reports 10
 - using with DLCTOKEN 19, 20

M

- MAC 14
- Management Information Base 120
- memory
 - allocating 152
- message, sending 213
- messages
 - blocks 270
 - RPC 138
 - streams 270
- MIB
 - database 123
 - overview 120
 - variables 122, 123
- model (RPC) 132
- modules 269
 - 64-bit support 276
 - configuring (PSE) 279

- modules (*continued*)
 - introduction to streams 253
 - modules 276
 - user-context 275
- monitors
 - SNMP 125
- multiprogram versions
 - RPC 176

N

- NCS 109
- NDBM
 - DBM equivalents 77
 - subroutines 77
- NDD
 - protocols 199
 - socket addresses 199
- NDMB
 - problem diagnosis 77
- Network Computing System 109
- Network Information Service 115
- Network Management
 - SNMP 119
 - xgmon 119
- NIS
 - files 115
 - subroutines 115
- non-filter primitives
 - list 98
- nonfilter primitives
 - list 94

O

- opaque data type
 - RPC 160
- opaque data types
 - XDR 88
- optional data types (XDR) 93
- options, socket 210
- options, sockets 210
- out-of-band data 211

P

- packet capture library 313
 - data structures 314
 - delayed processing ex. 320
 - filter expressions 315
 - header files 314
 - print binary form ex. 317
 - savefile ex. 324
 - subroutines 314
- passing linked lists (XDR)
 - example 100
- ping program (RPC) 183
- pointers
 - XDR 108
- port mapper 144
- Portable Streams Environment 279

- ports
 - registering (RPC) 144
- primitives
 - filter 95
 - non-filter 98
 - nonfilter 94
- procedure
 - packet capture 313
- procedure numbers
 - list of 148
- procedure numbers (RPC)
 - assigning 148
- program numbers
 - assigning (RPC) 147
- protocol
 - RPC
 - port mapper 145
 - Sockets 203, 250
- protocol compilers
 - rpcgen 160
- protocols
 - RPC 133
 - authentication 138
 - specifications 148
- PSE 279
- put procedures
 - Streams 273

Q

- QLLC (qualified logical link control) DLC
 - describing device manager functions 52
- QLLC (Qualified Logical Link Control) DLC
 - describing programming interfaces 52
 - device manager 51
 - overview 51
- qualified logical link control 51
- QUEUES
 - processing messages with STREAMS 273

R

- records
 - RPC messages 138
- Remote Procedure Call (RPC)
 - highest layer 149
 - lowest layer 151
- remote procedure calls 109, 131
- RPC
 - arbitrary data types
 - passing 175
 - authentication 138
 - client side 139
 - DES overview 140
 - DES protocol 142
 - server side 140
 - batching 153
 - binding process 133
 - broadcasting 177
 - protocols 154
 - server side 161

- RPC (*continued*)
 - C preprocessor 161
 - callback 180
 - procedures 154
 - constants 157
 - converting local procedures 184
 - overview 160
 - declarations 158
 - enumerations 157
 - examples
 - list of 162
 - features 153
 - generating XDR routines 187
 - overview 161
 - intermediate layer 170
 - language 155
 - macros 162
 - message protocol 133
 - message replies 136
 - messages 134
 - model 132
 - multiple program versions 176
 - overview 131
 - port mapper 144
 - programming 146
 - programs
 - list of 148
 - rpc process (TCP) 178
 - rpcgen protocol compiler 160
 - select subroutine 178
 - on the server side 155
 - semantics 133
 - server procedures 162
 - starting
 - from inetd daemon 153
 - structures 156
 - subroutines 162
 - timeouts
 - changing 161
 - transports 133
 - type definitions 157
 - unions 156
 - XDR, using with 82
- RPC (Remote Procedure Call)
 - arbitrary data types
 - passing 151
 - intermediate layer 149
 - marking records in messages 138
- RPC authentication
 - DES 168
 - clock synchronization 141
 - Diffie-Hellman encryption 143
 - naming scheme 140
 - nicknames 141
 - on the client side 141
 - on the server side 141
 - verifiers 141
 - NULL 139
 - overview 138
 - protocol 138
 - UNIX 166

- RPC authentication (*continued*)
 - overview 139
- RPC example programs
 - generating XDR routines 187
 - ping program 183
 - select subroutine 178
 - UNIX authentication 166
- RPC language
 - constants 157
 - declarations 158
 - definitions 155
 - descriptions 155
 - enumerations 157
 - exceptions to rules
 - booleans 159
 - opaque data 160
 - strings 159
 - voids 160
 - overview 155
 - ping program 183
 - programs
 - syntax 157
 - rpcgen protocol compiler 160
 - structures 156
 - syntax requirements for program definition 159
 - type definitions 157
 - unions 156
- RPC layers
 - highest 170
 - intermediate
 - handling arbitrary data structures 149
 - routines 149
 - lowest 171
- RPC messages
 - calls 134
 - protocol requirements 134
 - replies 136
 - structures 134
- RPC port mapper
 - overview 144
 - procedures 146
 - protocol 145
 - registering ports with 144
- rpc process (RPC)
 - on TCP 178
- RPC programming
 - procedure numbers 148
 - program numbers 147
 - version numbers 147
- RPC programs
 - compiling 153
 - linking 153
 - list of 148
 - syntax 157
- RPC runtime library
 - NCS 109
 - routines
 - client 109
 - conversion 110
 - server 109

- rpcgen protocol compiler
 - broadcasting
 - server side 161
 - C preprocessor 161
 - changing timeouts 161
 - converting local procedures 160, 184
 - generating XDR routines 161, 187
 - other information passed to server 162
 - overview 160
- RPCL 159

S

- SAP
 - definition 6
 - statistics
 - querying 7
- SDLC 44
- SDLC (synchronous data link control) DLC
 - device manager functions 45
 - programming interfaces 48
 - providing protocol support 45
- SDLC (Synchronous Data Link Control) DLC
 - initiating asynchronous function subroutine calls 51
- select subroutines (RPC) 178
 - overview 155
- semantics (RPC) 133
- sending messages 213
- server procedures (RPC) 162
- servers
 - RPC routines and 109
- service access point 6
- service procedures
 - STREAMS 274
- short-hold mode 7
- shutdown sockets 212
- simple network management protocol 119
- SMUX subroutines 127
 - adios 128
 - advise 129
- SNMP
 - agent 125
 - database 120
 - monitor 125
 - overview 119
 - traps 126
- SNMP multiplexer (SMUX) 128
- socket
 - binding 198
 - communication domains 196
- sockets 198
 - accepting internet Streams connections 225
 - accepting UNIX Stream connections 228
 - address translation 214
 - atm socket pvc client
 - sending data 229
 - atm socket pvc server
 - receiving data 230
 - atm socket rate-enforced svc server
 - receiving data 235

- sockets (*continued*)
 - atm socket svc client
 - sending data 237
 - atm socket svc server
 - receiving data 240
 - atm sockets rate-enforced svc client
 - sending data 231
 - binding addresses 206
 - binding names 205
 - blocking mode 212
 - checking pending connections 226
 - closing 212
 - connecting 192
 - connectionless 209
 - connections 207
 - creating 192, 205
 - data structures 195
 - data transfer 193, 210
 - ethernet
 - receiving packets 243
 - sending packets 245
 - examples, understanding 220
 - header files 195, 250
 - I/O modes 212
 - Infiniband 203
 - interface 193, 194
 - internet datagrams
 - reading 221
 - sending 222
 - Internet Stream
 - initiating 224
 - kernel services
 - list of 248
 - layer 193
 - library 194
 - subroutines 249
 - names
 - binding 205
 - host 217
 - network 217
 - protocol 217
 - resolution 218
 - service 217
 - translation 218
 - network packets
 - analyzing 247
 - out-of-band data 211
 - protocols 203, 250
 - server connections 208
 - shutdown 212
 - socketpair subroutine 220
 - types 201
 - UNIX datagrams
 - reading 223
 - sending 223
 - UNIX Stream connections 227
 - XDR 105
- Sockets
 - options, get, set 210
 - overview 191
- standard Ethernet data link control 34

- statistics
 - querying
 - LS 7
 - SAP 7
- stream end 254
- stream head 252
- streams
 - TLI 291
- STREAMS
 - asynchronous protocol example 282
 - building 267
 - commands 288
 - configuring 288
 - maintaining 289
 - definition 251
 - differences between PSE and V.4 287
 - drivers
 - introduction 275
 - list of 289
 - Flow Control 256
 - functions
 - list of 290
 - ioctl operations 265
 - log device driver 277, 278
 - message queue 272
 - messages 270
 - allocation 271
 - sending and receiving 273
 - types 271
 - modules 253, 255, 275
 - list of 289
 - overview 251
 - protocol substitution 255
 - PSE 279
 - pushable modules 269
 - put procedures 273
 - QUEUE procedures 273
 - queues 272
 - service procedures 274
 - stream end 254
 - stream head 252
 - streamio operations 267
 - subroutines 264
 - list of 289
 - synchronization 257
 - system calls 264
 - list of 290
 - tunable parameters 265
 - understanding flow control 256
 - utilities
 - list of 290
 - welding mechanism 263
- strings
 - RPC 159
 - XDR 90
- structures
 - RPC language 156
 - XDR language 83, 91
- subroutine format (XDR) 81
- subroutines 314
- Synchronous Data Link Control 44

T

- TCP/IP
 - list of RFCs 310
 - programming references
 - list of files and file formats 309
 - list of methods 309
 - socket addresses 198
- timeouts
 - changing (RPC) 161
- token-ring data link control 12
- Transmission Control Protocol/Internet Protocol 295
- transport protocol
 - and RPC 133
- transport service library interface 291
- traps 126
- type definitions
 - RPC language 157
 - XDR language 92

U

- Understanding STREAMS Flow Control 256
- unions
 - discriminated 91
 - optional data 93
 - RPC language 156
 - XDR language 83
- UNIX authentication (RPC) 139, 166

V

- V.4 STREAMS
 - differences between and 287
- version numbers
 - assigning (RPC) 147
- voids
 - RPC 160
 - XDR 92

X

- XDR
 - canonical data representation 80
 - data streams 98
 - data types 84
 - filter primitives 95, 96
 - generating routines with RPC 161
 - language
 - specifications 82
 - library 81
 - memory allocation (RPC) 152
 - non-filter primitives 98
 - overview 79
 - primitives 95
 - programming reference library 94
 - remote procedure calls and 131
 - RPC
 - generating routines with 187
 - RPC, using with 82
 - structures 91

- XDR (*continued*)
 - subroutine format 81
 - type definitions 92
 - unions
 - optional data 93
 - unsupported representations 81
 - using rpc process with 178
- XDR (eXternal Data Representation)
 - unions
 - discriminated 91
- XDR example
 - array 106
 - data description 102
 - discriminated unions 107
 - justification for using 103
 - linked lists 100
 - pointers 108
- XDR language
 - block size 80
 - declarations 83
 - enumerations 83
 - lexical notes 82
 - structures 83
 - syntax notes 84
 - unions 83
- XTI 291

Readers' Comments — We'd Like to Hear from You

**AIX 5L™ Version 5.3
Communications Programming Concepts**

Publication No. SC23-4894-06

We appreciate your comments about this publication. Please comment on specific errors or omissions, accuracy, organization, subject matter, or completeness of this book. The comments you send should pertain to only the information in this manual or product and the way in which the information is presented.

For technical questions and information about products and prices, please contact your IBM branch office, your IBM business partner, or your authorized remarketer.

When you send comments to IBM, you grant IBM a nonexclusive right to use or distribute your comments in any way it believes appropriate without incurring any obligation to you. IBM or any other organizations will only use the personal information that you supply to contact you about the issues that you state on this form.

Comments:

Thank you for your support.

Submit your comments using one of these channels:

- Send your comments to the address on the reverse side of this form.
- Send your comments via e-mail to: pserinfo@us.ibm.com

If you would like a response from IBM, please fill in the following information:

Name

Address

Company or Organization

Phone No.

E-mail address



Fold and Tape

Please do not staple

Fold and Tape



NO POSTAGE
NECESSARY
IF MAILED IN THE
UNITED STATES

BUSINESS REPLY MAIL

FIRST-CLASS MAIL PERMIT NO. 40 ARMONK, NEW YORK

POSTAGE WILL BE PAID BY ADDRESSEE

IBM Corporation
Information Development
Department 04XA-905-6B013
11501 Burnet Road
Austin, TX 78758-3400



Fold and Tape

Please do not staple

Fold and Tape



Printed in U.S.A.

SC23-4894-06

