

Tru64 UNIX

Programming Support Tools

Part Number: AA-RH9WA-TE

July 1999

Product Version: Tru64 UNIX Version 5.0 or higher

This manual describes Compaq Tru64 UNIX (formerly DIGITAL UNIX) commands and utilities that you can use for program development.

© 1993, 1994, 1995, 1996, 1999 Compaq Computer Corporation

COMPAQ, the Compaq logo, and the Digital logo are registered in the U.S. Patent and Trademark Office. Alpha, AlphaServer, NonStop, TruCluster, and Tru64 are trademarks of Compaq Computer Corporation.

Microsoft and Windows NT are registered trademarks of Microsoft Corporation. Intel, Pentium, and Intel Inside are registered trademarks of Intel Corporation. UNIX is a registered trademark and The Open Group is a trademark of The Open Group in the United States and other countries. Other product names mentioned herein may be the trademarks of their respective companies.

Possession, use, or copying of the software described in this publication is authorized only pursuant to a valid written license from Compaq Computer Corporation or an authorized sublicensor.

Compaq Computer Corporation shall not be liable for technical or editorial errors or omissions contained herein. The information in this document is subject to change without notice.

Contents

About This Manual

1 Finding Information with Regular Expressions and the grep Command

1.1	Forming Regular Expressions	1-1
1.1.1	Basic Regular Expressions	1-2
1.1.2	Extended Regular Expressions	1-4
1.1.3	Matching Multiple Occurrences of a Regular Expression .	1-6
1.1.4	Matching Only Selected Characters	1-7
1.1.5	Specifying Multiple Regular Expressions	1-8
1.1.6	Special Collating Considerations in Regular Expressions .	1-8
1.2	Using the grep Command	1-9

2 Matching Patterns and Processing Information with awk

2.1	Running the awk Program	2-2
2.2	Printing in awk	2-5
2.3	Using Variables in awk	2-5
2.3.1	Simple Variables	2-6
2.3.2	Field Variables	2-7
2.3.3	Array Variables	2-8
2.3.4	Built-In awk Variables	2-8
2.4	More About Using Regular Expressions as Patterns	2-10
2.5	Using Relational Expressions and Combined Expressions as Patterns	2-11
2.6	Using Pattern Ranges	2-12
2.7	Actions in awk	2-13
2.8	Using Operators in an Action	2-13
2.9	Using Functions Within an Action	2-14
2.10	Using Control Structures in awk	2-17
2.11	Performing Actions Before or After Processing the Input	2-19
2.12	Concatenating Strings	2-19
2.13	Redirection and Pipes	2-20

3 Editing Files with the sed Editor

3.1	Overview of the sed Editor	3-1
3.2	Running the sed Editor	3-2
3.3	Selecting Lines for Editing	3-4
3.4	Summary of sed Commands	3-6
3.5	String Replacement	3-10

4 Creating Input Language Analyzers and Parsers

4.1	How the Lexical Analyzer Works	4-2
4.2	Writing a Lexical Analyzer Program with lex	4-3
4.3	The lex Specification File	4-4
4.3.1	Defining Substitution Strings	4-4
4.3.2	Rules	4-5
4.3.2.1	Regular Expressions	4-6
4.3.2.2	Matching Rules	4-7
4.3.2.2.1	Using Wildcard Characters to Match a String	4-8
4.3.2.2.2	Finding Strings Within Strings	4-8
4.3.2.3	Actions	4-9
4.3.2.3.1	Null Action	4-9
4.3.2.3.2	Using the Same Action for Multiple Expressions ..	4-10
4.3.2.3.3	Printing a Matched String	4-10
4.3.2.3.4	Finding the Length of a Matched String	4-10
4.3.2.3.5	Getting More Input	4-11
4.3.2.3.6	Returning Characters to the Input	4-11
4.3.3	Using or Overriding Standard Input/Output Routines	4-12
4.3.4	End-of-File Processing	4-13
4.3.5	Passing Code to the Generated Program	4-14
4.3.6	Start Conditions	4-14
4.4	Generating a Lexical Analyzer	4-15
4.5	Using lex with yacc	4-16
4.6	Creating a Parser with yacc	4-18
4.6.1	The main and yyerror Functions	4-19
4.6.2	The yylex Function	4-19
4.7	The Grammar File	4-20
4.7.1	Declarations	4-21
4.7.1.1	Defining Global Variables	4-22
4.7.1.2	Start Symbols	4-22
4.7.1.3	Token Numbers	4-23
4.7.2	Grammar Rules	4-23
4.7.2.1	Null String	4-25

4.7.2.2	End-of-Input Marker	4-25
4.7.2.3	Actions in yacc Parsers	4-25
4.7.3	Programs	4-27
4.7.4	Guidelines for Using Grammar Files	4-27
4.7.4.1	Using Comments	4-27
4.7.4.2	Using Literal Strings	4-27
4.7.4.3	Guidelines for Formatting the Grammar File	4-28
4.7.4.4	Using Recursion in a Grammar File	4-28
4.7.4.5	Errors in the Grammar File	4-29
4.7.5	Error Handling by the Parser	4-29
4.7.5.1	Providing for Error Correcting	4-30
4.7.5.2	Clearing the Look-Ahead Token	4-30
4.8	Parser Operation	4-30
4.8.1	The shift Action	4-31
4.8.2	The reduce Action	4-32
4.8.3	Ambiguous Rules and Parser Conflicts	4-33
4.9	Turning on Debug Mode	4-34
4.10	Creating a Simple Calculator Program	4-35
4.10.1	Parser Source Code	4-36
4.10.2	Lexical Analyzer Source Code	4-39

5 Using m4 Macros in Your Programs

5.1	Using Macros	5-1
5.2	Defining Macros	5-2
5.2.1	Using the Quote Characters	5-4
5.2.2	Macro Arguments	5-5
5.3	Using Other m4 Macros	5-6
5.3.1	Changing the Comment Characters	5-9
5.3.2	Changing the Quote Characters	5-9
5.3.3	Removing a Macro Definition	5-9
5.3.4	Checking for a Defined Macro	5-10
5.3.5	Using Integer Arithmetic	5-10
5.3.6	Manipulating Files	5-11
5.3.7	Redirecting Output	5-11
5.3.8	Using System Programs in a Program	5-12
5.3.9	Using Unique File Names	5-12
5.3.10	Using Conditional Expressions	5-12
5.3.11	Manipulating Strings	5-13
5.3.12	Printing	5-14

6 Revision Control: Managing Source Files with RCS or SCCS

6.1	Overview of Revision Control	6-1
6.2	Version Control Concepts	6-3
6.3	Managing Multiple Versions of Files	6-6
6.4	Creating a Version Control Library	6-8
6.5	Using RCS	6-8
6.5.1	Placing New Files in an RCS Library	6-10
6.5.2	Recording File-Identification Information with RCS	6-11
6.5.3	Getting Files from an RCS Library	6-12
6.5.4	Checking Edited Files Back into an RCS Library	6-13
6.5.5	Working with Multiple Versions of Files	6-13
6.5.6	Displaying Differences in RCS Files	6-14
6.5.7	Reporting Revision Histories of RCS Files	6-15
6.5.8	Configuration Control Concepts	6-16
6.6	Using SCCS	6-17
6.6.1	Placing New Files in an SCCS Library	6-19
6.6.2	Recording File-Identification Information with SCCS	6-20
6.6.3	Getting Files from an SCCS Library	6-21
6.6.3.1	Getting Files for Purposes Other Than Editing	6-21
6.6.3.2	Getting Files for Editing	6-22
6.6.3.3	Managing Multiple Files and New Releases	6-22
6.6.4	Checking Edited Files Back into an SCCS Library	6-23
6.6.5	Working with Multiple Versions of Files	6-24
6.6.6	Displaying Differences in SCCS Files	6-25
6.6.7	Reporting Revision Histories of SCCS Files	6-25
6.6.8	Performing Administrative Functions	6-26
6.6.9	Using SCCS Options	6-28
6.6.10	Summary of Individual SCCS Commands	6-29
6.7	Functional Comparison of RCS and SCCS Commands	6-30

7 Building Programs with the make Utility

7.1	Operation of the make Utility	7-1
7.2	Description Files	7-3
7.2.1	Format of a Description File Entry	7-4
7.2.2	Using Commands in a Description File	7-5
7.2.3	Preventing the make Utility from Echoing Commands	7-7
7.2.4	Preventing the make Utility from Stopping on Errors	7-7
7.2.5	Defining Default Conditions	7-7
7.2.6	Preventing make from Deleting Files	7-7
7.2.7	Simple Description File	7-8

7.2.8	Making the Description File Simpler	7-8
7.2.9	Defining Macros	7-9
7.2.10	Using Macros in a Description File	7-10
7.2.10.1	Macro Substitution	7-10
7.2.10.2	Conditional Macros	7-12
7.2.11	Calling the make Utility from a Description File	7-13
7.2.12	Internal Macros	7-13
7.2.12.1	Internal Target File Name Macro	7-14
7.2.12.2	Internal Label Name Macro	7-14
7.2.12.3	Internal Younger Files Macro	7-15
7.2.12.4	Internal First Out-of-Date File Macro	7-15
7.2.12.5	Internal Current File Name Prefix Macro	7-15
7.2.13	How make Uses Environment Variables	7-16
7.2.14	Internal Rules	7-16
7.2.14.1	Single Suffix Rules	7-19
7.2.14.2	Overriding Built-In make Macros	7-19
7.2.15	Including Other Files	7-20
7.2.16	Testing Description Files	7-20
7.2.17	Description File	7-21

Glossary

Index

Examples

4-1	Parser Source Code for a Calculator	4-36
4-2	Lexical Analyzer Source Code for a Calculator	4-40
7-1	A Simple Description File	7-8
7-2	Default Rules File	7-18
7-3	The makefile for the make Utility	7-21

Figures

2-1	Sequence of awk Processing	2-5
3-1	Sequence of sed Processing	3-4
4-1	Simple Finite State Model	4-3
4-2	Producing an Input Parser with lex and yacc	4-17
6-1	Contents of a Version Control File	6-4
6-2	A Typical RCS Library	6-5
6-3	A Typical SCCS Library	6-6

6-4	A Version Control File's Tree of Deltas	6-7
-----	---	-----

Tables

1-1	Rules for Basic Regular Expressions	1-2
1-2	Rules for Extended Regular Expressions	1-4
1-3	Behaviour of the grep Command	1-9
1-4	Flags for the grep Command	1-10
2-1	Flags for the awk Command	2-2
2-2	Built-In Variables in awk	2-9
2-3	Operators for awk Actions	2-13
2-4	Built-In awk Mathematical Functions	2-14
2-5	Built-In awk String Functions	2-15
2-6	Built-In awk Miscellaneous Functions	2-16
2-7	Control Structures in awk	2-18
3-1	Flags for the sed Command	3-2
3-2	Special Regular Expressions Recognized by sed	3-5
3-3	Text Editing and Movement Commands	3-6
3-4	Buffer Manipulation Commands	3-8
3-5	Flow-of-Control Commands	3-9
4-1	Regular Expression Operators for lex	4-6
4-2	Options for the lex Command	4-16
4-3	Processing-Condition Definition Keywords in yacc	4-22
5-1	Built-In m4 Macros	5-7
6-1	Features of RCS and SCCS	6-2
6-2	Summary of RCS Command Functions	6-9
6-3	RCS ID Keywords	6-11
6-4	Summary of sccs Command Functions	6-17
6-5	SCCS ID Keywords	6-20
6-6	SCCS admin Command Options	6-26
6-7	Flags for the admin Command	6-27
6-8	SCCS Command Options	6-29
6-9	Individual SCCS Commands	6-29
6-10	Functional Comparison: RCS and SCCS Commands	6-31
7-1	Internal make Macros	7-13

About This Manual

This manual describes several Compaq Tru64™ UNIX (formerly DIGITAL UNIX) commands and utilities, including facilities for text and string manipulation, macro and program generation, and source file management.

Audience

Although this book is intended primarily for programmers, much of the material about `grep` (*Chapter 1*), `awk` (*Chapter 2*), `sed` (*Chapter 3*), and RCS and SCCS (*Chapter 6*) is useful for moderately experienced users.

Organization

This manual is organized as follows:

- Chapter 1* Introduces the concept of regular expressions and describes the rules for forming them, and describes `grep`, a command that uses regular expressions for searching text files.
- Chapter 2* Describes the `awk` command and its text-processing language.
- Chapter 3* Describes the `sed` stream editor, a noninteractive tool for rapidly performing complex and repetitive editing tasks.
- Chapter 4* Describes the `lex` and `yacc` programs for generating lexical analyzers and parsers for processing input to a program.
- Chapter 5* Describes the `m4` macro preprocessor and explains how to create macros that can be used in programs or in other files such as documentation source.
- Chapter 6* Describes how to manage libraries of source files by using the Source Code Control System (SCCS) or the Revision Control System (RCS).
- Chapter 7* Describes how to use the `make` utility to build and maintain complex programs and applications.

Related Documents

This manual is an adjunct to the *Programmer's Guide*; neither manual requires that you have the other in order to use its contents.

Icons on Tru64 UNIX Printed Books

The printed version of the Tru64 UNIX documentation uses letter icons on the spines of the books to help specific audiences quickly find the books that meet their needs. (You can order the printed documentation from Compaq.) The following list describes this convention:

- G Books for general users
- S Books for system and network administrators
- P Books for programmers
- D Books for device driver writers
- R Books for reference page users

Some books in the documentation help meet the needs of several audiences. For example, the information in some system books is also used by programmers. Keep this in mind when searching for information on specific topics.

The *Documentation Overview* provides information on all of the books in the Tru64 UNIX documentation set.

Reader's Comments

Compaq welcomes any comments and suggestions you have on this and other Tru64 UNIX manuals.

You can send your comments in the following ways:

- Fax: 603-884-0120 Attn: UBPG Publications, ZKO3-3/Y32
- Internet electronic mail: readers_comment@zk3.dec.com

A Reader's Comment form is located on your system in the following location:

```
/usr/doc/readers_comment.txt
```

- Mail:

Compaq Computer Corporation
UBPG Publications Manager
ZKO3-3/Y32
110 Spit Brook Road
Nashua, NH 03062-2698

A Reader's Comment form is located in the back of each printed manual. The form is postage paid if you mail it in the United States.

Please include the following information along with your comments:

- The full title of the book and the order number. (The order number is printed on the title page of this book and on its back cover.)
- The section numbers and page numbers of the information on which you are commenting.
- The version of Tru64 UNIX that you are using.
- If known, the type of processor that is running the Tru64 UNIX software.

The Tru64 UNIX Publications group cannot respond to system problems or technical support inquiries. Please address technical questions to your local system vendor or to the appropriate Compaq technical support office. Information provided with the software media explains how to send problem reports to Compaq.

Conventions

The following typographical conventions are used in this manual:

%	
\$	A percent sign represents the C shell system prompt. A dollar sign represents the system prompt for the Bourne, Korn, and POSIX shells.
#	A number sign represents the superuser prompt.
% cat	Boldface type in interactive examples indicates typed user input.
<i>file</i>	Italic (slanted) type indicates variable values, placeholders, and function argument names.
[]	
{ }	In syntax definitions, brackets indicate items that are optional and braces indicate items that are required. Vertical bars separating items inside brackets or braces indicate that you choose one item from among those listed.
...	In syntax definitions, a horizontal ellipsis indicates that the preceding item can be repeated one or more times.
cat(1)	A cross-reference to a reference page includes the appropriate section number in parentheses.

For example, `cat(1)` indicates that you can find information on the `cat` command in Section 1 of the reference pages.

`Return`

In an example, a key name enclosed in a box indicates that you press that key.

`Ctrl/x`

This symbol indicates that you hold down the first named key while pressing the key or mouse button that follows the slash. In examples, this key combination is enclosed in a box (for example, `Ctrl/C`).

Finding Information with Regular Expressions and the `grep` Command

This chapter describes regular expressions and how to use them. Regular expressions are most commonly used in the context of pattern matching with the `grep` command, but they are also used with virtually all text-processing or filtering utilities and commands. A more thorough discussion of the `grep` command follows the introduction of regular expressions.

This chapter contains the following:

- Forming regular expressions
- Using the `grep` command

1.1 Forming Regular Expressions

This section contains the following:

- Basic regular expressions
- Extended regular expressions
- Matching multiple occurrences of a regular expression
- Matching only selected characters
- Specifying multiple regular expressions
- Special collating considerations in regular expressions

A regular expression specifies a set of strings to be matched. It contains ordinary text characters and **operator** characters. Ordinary characters match the corresponding characters in the strings being compared. Operator characters specify repetitions, choices, and other features. Regular expressions fall into two groups:

- Basic regular expressions
- Extended regular expressions

Section 1.1.1 and Section 1.1.2 describe the two types of regular expressions. In addition to the constructs described in these two sections, there are three special expression types related to character classes, collating sequences, and equivalence classes. See Section 1.1.6 for more information on these

classes. The order of precedence of the regular expression operators discussed in these three sections is as follows:

1. Collation-related bracket symbols: [= =], [. .], and [: :]
2. Escaped operator characters: `\char`
3. Bracket expressions: `[expr]`
4. Subexpressions and back-reference expressions: `\(expr\)`, `\n` in basic regular expressions; `(expr)` only in extended regular expressions
5. Duplication: `*`, `\{i\}`, `\{i,\}`, `\{i,j\}` in basic regular expressions; `*`, `?`, `+`, `{i}`, `{i,}`, `{i,j}` in extended regular expressions
6. Concatenation
7. Anchoring: `^`, `$`
8. Alternation in extended regular expressions: `|`

1.1.1 Basic Regular Expressions

Basic regular expressions are built by concatenating simpler basic regular expressions. The letters of the alphabet are ordinary characters. An ordinary character is an expression that always matches itself and nothing else. (Usually, digits are also ordinary characters, but a digit preceded by a backslash forms a back-reference expression; see Table 1–1.) For example, the expression `rabbit` matches the string `rabbit`, and the expression `a57D` matches the string `a57D`.

Ordinary characters and operator characters together make up the set of simple basic regular expressions. You can concatenate any number or combination of simple expressions to create a compound expression that will match any sequence of characters that corresponds to the concatenated simple expressions. Table 1–1 describes the rules for creating basic regular expressions.

The sections following Section 1.1.2 provide further explanation of some of the expressions listed in Table 1–1 and Table 1–2.

Table 1–1: Rules for Basic Regular Expressions

Expression	Name	Description
Letters, numbers, most punctuation	Ordinary character	Matches itself.
.	Period (dot)	Matches any single character except the newline character.
*	Asterisk	Matches any number of occurrences of the preceding simple expression, including none.

Table 1–1: Rules for Basic Regular Expressions (cont.)

Expression	Name	Description
<code>\{i,j\}</code>	Interval expression	Matches a more restricted number of instances of the preceding simple expression; for example, <code>ab\{3\}c</code> matches only <code>abbbbc</code> , while <code>ab\{2,3\}c</code> matches <code>abbc</code> or <code>abbbbc</code> , but not <code>abc</code> or <code>abbbbc</code> .
<code>\(expr\)</code>	Subexpression (hold delimiters)	Matches <code>expr</code> , causing basic regular expression operators to treat it as a unit; for example, <code>a\(bc\)\{2,3\}d</code> matches <code>abcbbcd</code> or <code>abcbcbcd</code> but not <code>abcd</code> or <code>abcbcbcbcd</code> . Additionally, the subexpression is saved into a numbered holding space (up to nine per expression) for reuse later in the expression to specify another match on the same subexpression.
<code>\n</code>	Back-reference expression	Repeats the contents of the <i>n</i> th subexpression in the regular expression.
<code>[chars]</code>	Bracket expression	Matches a single instance of any one of the characters within the brackets. Ranges of characters can be abbreviated by using a hyphen. For example, <code>[0-9a-z]</code> matches any single digit or lowercase letter. Within brackets, all characters are ordinary characters except the hyphen (when used in a range abbreviation) and the circumflex (when used as the first character inside the brackets).
<code>^</code>	Circumflex	When used at the beginning of a regular expression (or a subexpression), matches the beginning of a line ('anchors' the expression to the beginning of the line). When used as the first character inside brackets, excludes the bracketed characters from being matched. Otherwise, has no special properties.
<code>\$</code>	Dollar sign	When used at the end of a regular expression, matches the end of a line ('anchors' the expression to the end of the line). Otherwise, has no special properties.
<code>\char</code>	Backslash	Except within a bracket expression, escapes the next character to permit matching on explicit instances of characters that are usually basic regular expression operators.
<code>expr expr ...</code>	Concatenation	Matches any string that matches all of the concatenated expressions in sequence.

1.1.2 Extended Regular Expressions

In general, extended regular expressions are like the basic regular expressions described in Section 1.1.1. However, extended regular expressions comprise a larger set that is used by certain programs, such as `awk`, that can perform more powerful file-manipulation and filtering operations than programs such as `grep` (when used without its `-E` flag) or `sed`. It is better, then, to consider extended regular expressions separately from basic regular expressions despite the fact that the two types of expressions share many constructs. Table 1–2 lists the rules for forming extended regular expressions; note that constructs that are shared between basic and extended regular expressions are listed both in Table 1–2 and in Table 1–1.

Table 1–2: Rules for Extended Regular Expressions

Expression	Name	Description
Letters, numbers, most punctuation	Ordinary character	Matches itself.
.	Period (dot)	Matches any single character except the newline character.
*	Asterisk	Matches any number of occurrences of the preceding simple expression, including none.
?	Question mark	Matches zero or one occurrence of the preceding simple expression.
+	Plus sign	Matches one or more occurrences of the preceding simple expression.
{ <i>i</i> , <i>j</i> }	Interval expression	Matches a more restricted number of instances of the preceding simple expression; for example, <code>ab{3}c</code> matches only <code>abbbc</code> , while <code>ab{2,3}c</code> matches <code>abbc</code> or <code>abbbc</code> , but not <code>abc</code> or <code>abbbbc</code> . Basic regular expression interval expressions are delimited by escaped braces. To match a literal expression that has the form of an interval expression using an extended regular expression, escape the left brace. For example, <code>\{2,3}</code> matches the explicit string <code>{2,3}</code> .

Table 1–2: Rules for Extended Regular Expressions (cont.)

Expression	Name	Description
<code>(<i>expr</i>)</code>	Subexpression	Matches <i>expr</i> , causing extended regular expression operators to treat it as a unit; for example, <code>a(bc)?d</code> matches <code>ad</code> or <code>abcd</code> but not <code>abcbcd</code> , <code>abcbcbcd</code> , or other similar strings. Basic regular expression subexpressions are delimited by escaped parentheses. To match a literal parenthesized expression using an extended regular expression, escape the left parenthesis. For example, <code>\(abc)</code> matches the explicit string <code>(abc)</code> .
<code>[<i>chars</i>]</code>	Bracket expression	Matches a single instance of any one of the characters within the brackets. Ranges of characters can be abbreviated by using a hyphen. For example, <code>[0-9a-z]</code> matches any single digit or lowercase letter. Within brackets, all characters are ordinary characters except the hyphen (when used in a range abbreviation) and the circumflex (when used as the first character inside the brackets).
<code>^</code>	Circumflex	When used at the beginning of an expression (or a subexpression), matches the beginning of a line (anchors the expression to the beginning of the line). When used as the first character inside brackets, excludes the bracketed characters from being matched. Otherwise, has no special properties.
<code>\$</code>	Dollar sign	When used at the end of an expression, matches the end of a line (anchors the expression to the end of the line). Otherwise, has no special properties.
<code>\char</code>	Backslash	Except within a bracket expression, escapes the next character to permit matching on explicit instances of characters that are usually extended regular expression operators.
<code><i>expr expr</i> ...</code>	Concatenation	Matches any string that matches all of the concatenated expressions in sequence.
<code><i>expr expr</i> ...</code>	Vertical bar (alternation)	Separates multiple extended regular expressions; matches any of the bar-separated expressions.

1.1.3 Matching Multiple Occurrences of a Regular Expression

An asterisk (*) acts on the simple regular expression immediately preceding it, causing that expression to match any number of occurrences of a matching pattern, even none. When an asterisk follows a period, the combination indicates a match on any sequence of characters, even none. A period and an asterisk always match as much text as possible; for example:

```
% echo "A B C D" | sed 's/^.*/E/'
ED
```

The `sed` stream editor command in the previous example indicates that `sed` is to match the expression between the first and second slashes and replace the matching pattern with the string between the second and third slashes. This regular expression will match any string that starts at the beginning of the line, contains any sequence of characters, and ends in a space. Nominally, the string “A ” satisfies this expression; but the longest matching pattern is “A B C ”, so `sed` replaces “A B C ” with “E” to yield `ED` as the output. See Chapter 3 for a discussion of the `sed` stream editor.

An asterisk matches any number of instances of the preceding regular expression (both basic and extended). To limit the number of instances that a particular extended regular expression will match, use a plus sign (+) or a question mark (?). The plus sign requires at least one instance of its matching pattern. The question mark refuses to accept more than one instance. The following chart illustrates the matching characteristics of the asterisk, plus sign, and question mark:

Regular Expression	Matching Strings
<code>ab?c</code>	<code>ac</code> <code>abc</code>
<code>ab*c</code>	<code>ac</code> <code>abc</code> <code>abbc</code> , <code>abbbc</code> , ...
<code>ab+c</code>	<code>abc</code> <code>abbc</code> , <code>abbbc</code> , ...

You can also specify more restrictive numbers of instances of the regular expression with an interval expression. The following list illustrates the various forms of interval expressions in basic regular expressions:

- `expr\{i\}` Matches exactly *i* instances of anything `expr` matches. For example, `ab\{3\}c` matches `abbbc` but does not match either `abbc` or `abbbbc`.
- `\{i,\}` Matches at least *i* instances. For example, `ab\{3,\}c` matches `abbbc`, `abbbbc`, and so on, but not `ac`, `abc`, or `abbc`.
- `\{i,j\}` Matches any number of instances from *i* to *j*, inclusive. For example, `ab\{2,4\}c` matches `abbc`, `abbbc`, or `abbbbc` but not `abc` or `abbbbbc`. You can use 0 (zero) for *i*.

For extended regular expressions, omit the backslashes, making the previous examples `ab{3}c`, `ab{3,}c`, and `ab{2,4}c`.

Using the subexpression delimiters, you can save up to nine basic regular expression subexpression patterns on a line. Counting from left to right on the line, the first pattern saved is placed in the first holding space, the second pattern is placed in the second holding space, and so on.

The back-reference character sequence `\n` (where *n* is a digit from 1 to 9) matches the *n*th saved pattern. Consider the following basic regular expression:

```
\(A\) \(B\) C\2\1
```

This expression matches the string `ABCBA`. You can nest patterns to be saved in holding spaces. Whether the enclosed patterns are nested or in a series, *n* refers to the *n*th occurrence, counting from the left, of the subexpression delimiters. You can also use `\n` back-reference expressions in replacement strings as well as address patterns for editors such as `ed` and `sed`. Extended regular expressions do not support back-referencing.

1.1.4 Matching Only Selected Characters

A period in an expression matches any character except the newline character. To restrict the characters to be matched, place the characters inside brackets (`[]`). Each string of bracketed characters is a single-character expression that matches any one of the bracketed characters. Except for the circumflex (`^`), regular expression operators within brackets are interpreted literally, without special meaning. The circumflex excludes the bracketed characters if it is the first character in the brackets; otherwise, it has no special meaning.

When you specify a range of characters with a hyphen (for example, `[a-z]`), the characters that fall within the range are determined by the current collating sequence defined by the current setting of the `LC_CTYPE` environment variable. (See the discussion on using internationalization features in the *Command and Shell User's Guide* for more information on collating sequences.) The hyphen has no special meaning if it is the first or last character in a bracketed string or in a range expression in a bracketed string, or if it immediately follows a circumflex that is the first character in a bracketed string. To include a right bracket in a bracket expression, place it first or after the initial circumflex.

You can use the `grep` command's `-i` flag to perform a case insensitive match. (The `-y` flag is an exact synonym for `-i`.) To create an expression that is not case sensitive for other utilities, or to form an expression that is only partially case insensitive, use a bracket expression consisting of just the uppercase and lowercase versions of the character you want. For example:

```
% grep '[Jj]ones' group-list
```

1.1.5 Specifying Multiple Regular Expressions

Some utilities, such as `grep` (with its `-E` flag) and `awk`, permit you to specify multiple alternative extended regular expressions simultaneously by separating the individual expressions with a vertical bar. For example:

```
% awk '/[Bb]lack|[Ww]hite/ {print NR ":", $0}' .Xdefaults
55: sm.pointer_foreground: black
56: sm.pointer_background: white
```

1.1.6 Special Collating Considerations in Regular Expressions

Bracket expressions can include three special types of expressions called classes:

- **Character class**
Specifies a general type of character, such as uppercase letters.
- **Collating-symbol class**
In internationalized usages, specifies multicharacter strings that sort as single characters.
- **Equivalence class**
In internationalized usages, specifies collections of characters that have the same primary sort value.

When not used within a bracket expression, all of the constructs described in this section are interpreted literally as the explicit sequences of characters that make them up.

A character class name enclosed in bracket-colon delimiters, `[: and :]`, matches any of the set of characters in the named class. Members of each of the sets are determined by the current setting of the `LC_CTYPE` environment variable. The supported classes are `alnum`, `alpha`, `cntrl`, `digit`, `graph`, `lower`, `print`, `punct`, `space`, `upper`, and `xdigit`. For example, `[[:lower:]]` matches any lowercase letter in the current locale.

Some collating sequences include multicharacter strings that must be sorted as if they were single characters. For example, in Hungarian, the strings `cs`, `dz`, and others are each collating symbols. (The Hungarian primary sort order is `a`, `á`, `b`, `c`, `cs`, `d`, `dz`, `e`, ...). These special strings are called **collating symbols**, and they are indicated by being enclosed within bracket-period delimiters, `[. and .]`. The bracket-period delimiters in the regular expression syntax distinguish multicharacter collating elements from a list of the individual characters that make up the element. When using Hungarian collation rules, for example, `[[.cs.]]` is treated as an

expression matching the sequence `cs`, while `[cs]` is treated as an expression matching `c` or `s`. In addition, `[a-[.cs.]]` matches `a`, `á`, `b`, `c`, and `cs`.

A collating sequence can define equivalence classes for characters. An equivalence class is a set of collating elements that all sort to the same primary location. They are enclosed within bracket-equal delimiters, `[= and =]`. An equivalence class generally is designed to deal with primary-secondary sorting; that is, for languages like French that define groups of characters as sorting to the same primary location, and then have a tie-breaking, secondary sort. For example, if `e`, `é`, and `ê` belong to the same equivalence class, then `[[=e=] fg]`, `[[=é=] fg]`, and `[[=ê=] fg]` are each equivalent to `[eéêfg]`. For more information on collating sequences and their use, see the discussion on using internationalization features in the *Command and Shell User's Guide*.

1.2 Using the grep Command

The name of the `grep` command is an acronym for global regular expression printer. The `egrep` and `fgrep` commands, allied to `grep`, are obsolescent and should be replaced with `grep -E` and `grep -F`, respectively. The differences in the way `grep` behaves when used with these flags are summarized in Table 1–3.

Table 1–3: Behaviour of the grep Command

grep Version	Description
<code>grep</code>	Basic <code>grep</code> patterns (for <code>grep</code> with neither the <code>-E</code> nor the <code>-F</code> flag) are interpreted as basic regular expressions.
<code>grep -E (egrep)</code>	Extended <code>grep</code> patterns are interpreted as extended regular expressions.
<code>grep -F (fgrep)</code>	Fixed <code>grep</code> patterns are fixed strings; all regular expression operators are interpreted literally.

All forms of the `grep` command let you specify more than one expression as a multiline list. Surround the list with apostrophes, and separate the expressions with newline characters, as in this example using the Bourne shell:

```
$ strings hpcalc | grep -F 'math.h
> fatal.h'
```

In the C shell, you must enter a backslash before each newline character:

```
% strings hpcalc | grep -F 'math.h\
fatal.h'
```

You can also use the `-e` flag to specify multiple expressions on one line. For example:

```
% grep -e 'ab*c' -e 'de*f' myfile
```

By default, the `grep` command finds each line containing a match for the expression or expressions you specify. Table 1–4 describes command-line flags that let you specify other results from your searches.

Table 1–4: Flags for the `grep` Command

Flag	Description
<code>-b</code>	Precedes each output line with its disk block number. This flag is of use primarily to programmers who are trying to identify specific blocks on a disk by searching for the information contained in them.
<code>-c</code>	Counts matching lines and prints only the count.
<code>-e pattern_list</code>	Specifies matching on <i>pattern_list</i> ; multiple patterns must be separated with newlines. Useful if <i>pattern_list</i> begins with a minus sign (<code>-</code>).
<code>-f pattern_file</code>	Uses the contents of <i>pattern_file</i> to supply the expressions to be matched. Specify one expression per line in <i>pattern_file</i> .
<code>-h</code>	Suppresses reporting of file names when multiple files are processed.
<code>-l</code>	Lists only the names of files containing matching lines. Each file name is listed only once, even if the file contains multiple matches. If standard input is specified among the files to be processed with this flag, <code>grep</code> returns the parenthesized phrase (<code>standard input</code>) for the file name on relevant matches.
<code>-n</code>	Precedes each matching line with its line number.
<code>-p paragraph_sep</code>	Uses <i>paragraph_sep</i> as a paragraph separator, and displays the entire paragraph containing each matched line. Does not display the paragraph separator lines. The default paragraph separator is a blank line.
<code>-q</code>	Operates in quiet mode, printing nothing except error messages. ^a
<code>-s</code>	Suppresses error messages arising from nonexistent or unreadable files. Other error messages are still displayed. ^a
<code>-v</code>	Outputs only lines that do not match the specified expressions.
<code>-w expr</code>	Matches only if <i>expr</i> is found as a separate word in the text. A word is any string of alphanumeric characters (letters, numbers, and underscores) delimited by nonalphanumeric characters (punctuation or white space) or by the beginning or end of the line. For example, <code>word1</code> is a word; <code>A+B</code> is not a word.

Table 1–4: Flags for the grep Command (cont.)

Flag	Description
-x	Outputs only lines matched in their entirety.
-y	Exact synonym for <code>-i</code> .

^a To suppress all output for cases in which only success or failure status is wanted, as in a shell script, close standard output and standard error or redirect them both to `/dev/null`.

See the `grep(1)` reference page for more information about `grep` and regular expressions.

2

Matching Patterns and Processing Information with `awk`

This chapter describes the `awk` command, a tool with the ability to match lines of text in a file and a set of commands that you can use to manipulate the matched lines. In addition to matching text with the full set of extended regular expressions described in Chapter 1, `awk` treats each line, or **record**, as a set of elements, or **fields**, that can be manipulated individually or in combination. Thus, `awk` can perform more complex operations, such as:

- Writing selected fields of a record
- Reordering or replacing the contents of a record; for example, to change syntax in a program source file or change system calls when porting from one system to another
- Processing input to find numeric counts, sums, or subtotals
- Verifying that a given field contains only numeric information
- Checking to see that delimiters are balanced in a programming file
- Processing data contained in fields within records
- Changing data from one program into a form that can be used by a different program

This chapter contains the following sections:

- Running the `Awk` program
- Printing in `awk`
- Using variables in `awk`
- More about using regular expressions as patterns
- Using relational expressions and combined expressions as patterns
- Using pattern ranges
- Actions in `awk`
- Using operators in an action
- Using Functions within an Action
- Using Control Structures in `awk`
- Performing actions before or after processing the input

- Concatenating strings
- Redirections and pipes

2.1 Running the awk Program

The `awk` command has the following syntax:

```
awk [[-F ERE]] [[-v var= val]] {[-f prog_file] | [prog_text]} [file1 [file2 ...]]
```

Table 2–1 describes the flags for the `awk` command.

Table 2–1: Flags for the awk Command

Flag	Description
<code>-F ERE</code>	Specifies an extended regular expression to be used as a field separator. By default, <code>awk</code> uses white space (any number of adjacent tabs or spaces) to separate fields in a record. To specify an alternate separator containing white space or a shell metacharacter, enclose the entire flag in apostrophes. For example: <pre>% awk '-F <code>Tab</code>' '-f myprog' report</pre> The <code>-F</code> flag must precede any other command-line argument.
<code>-v var=val</code>	Assigns the value <code>val</code> to a variable named <code>var</code> ; such assignments are available to the <code>BEGIN</code> block of a program.
<code>-f prog_file</code>	Specifies the name of a file containing an <code>awk</code> program. This flag requires a file name as an argument. The <code>awk</code> command accepts multiple <code>-f</code> flags, concatenating all the program files and treating them as a single program.

You can specify the `awk` program to be executed either with the `-f prog_file` flag or as a program on the command line. Enclose a command-line program with apostrophes (' ') or quotation marks (" ") as needed to control file name expansion and variable substitution.

Usually, you create an `awk` program file before running `awk`. The program file is a series of statements that look like the following:

```
pattern { action }
```

In this structure, a *pattern* is one or more expressions that define the text to be matched. Patterns can consist of the following:

- `BEGIN` or `END`
- Boolean combinations of regular expressions using the operators `!` (NOT), `||` (Logical OR), and `&&` (AND), with parentheses for grouping expressions

- Boolean combinations of relational operations on strings, numbers, fields, and variables
- Ranges of records, specified in this way:

pattern1, pattern2

An *action* is one or more steps to be executed, designated with `awk` commands, operands, and operators. Actions can consist of the following:

- Assignment statements
- Statements to format and print data
- Tests to alter the flow of control
- Control structures, such as `if-else`, `while`, and `for` statements
- Redirection of output to one or more output streams besides standard output
- Piping of output and input

The braces (`{ }`) are delimiters separating the action from the search pattern. Actions can be specified on a single line, or on multiple lines to give a visual structure to the program. If you place an action consisting of several commands on one line, separate the commands with semicolons (`;`). For example, either of the two following programs will find every record containing either 'Gunther' or 'gunther'. For each matching record, it will print two lines, first the number of the record on which the match was made and then the first two fields of the matched record:

Program 1:

```
/[Gg]unther/ { print "Record:", NR ; print $1, $2 }
```

Program 2:

```
/[Gg]unther/ {
  print "Record:", NR
  print $1, $2
}
```

Output from these programs might look like the following:

```
Record: 382
Schuller Gunther
Record: 397
schwarz gunther
```

Both the pattern and the action are optional elements of a program line. If you omit the pattern, `awk` performs the action on every record in the file; if you omit the action, `awk` copies the record to standard output. A null program passes its input unmodified to the output.

Once you create the program file, enter the `awk` command on the command line as follows:

```
$ awk -f progfile infile > outfile
```

This command uses the program in `progfile` to process `infile`, and writes the output to `outfile`. The input file is not changed.

With a short program, you can accomplish the same job by entering the program on the command line before the name of the input file. For example:

```
$ awk '/[Gg]unther/ { print $1, $2 }' infile
```

When you use `awk` in this way, enclose the program in single or double quotation marks as required to control shell file name expansion and variable substitution.

When you start `awk`, it reads the program, checking for syntax. It then reads the first record of the input file, testing the record against each of the patterns in the program file in order of their appearance. When `awk` finds a pattern that matches the record, it performs the associated action. Then `awk` continues to search for matches in the program file. When it has compared the first input record against all patterns in the program file and performed all the actions required for that record, `awk` reads the next input record and repeats the program with that record. Processing continues in this manner until the end of the input file is reached. Figure 2-1 is a flowchart of this sequence. Compare the operation of `awk` with the very similar operation of the `sed` editor, shown in Figure 3-1.

Figure 2–1: Sequence of awk Processing

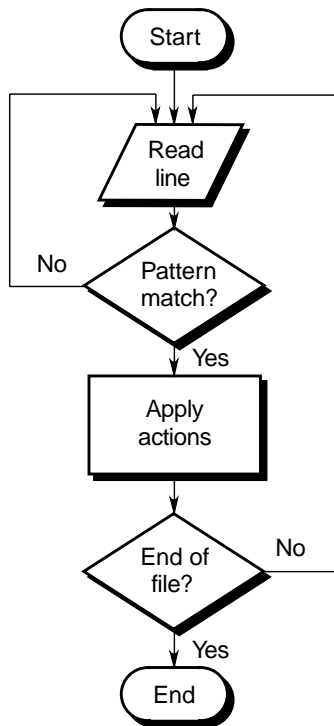

ZK0471UR

2.2 Printing in awk

You can use either the `print` command or the `printf` command to produce output in `awk`. The `print` command prints its arguments as already described; that is, arguments separated by commas are printed separated by the current output field separator, and arguments not separated by commas are concatenated as they are printed.

```
printf( "format", value1 [, value2, ...] )
```

This command prints the arguments `value1`, `value2`, and so on, formatted as defined by the `format` string. Refer to the `awk(1)` and `printf(3)` reference pages for information on constructing format specifiers.

2.3 Using Variables in awk

The `awk` program uses variables to manipulate information. Variables are of the following types:

- Simple variables

- Field variables
- Array variables
- Built-In `awk` variables

The `awk` language supports the set of built-in variables described in Section 2.3.4. You can also create and modify variables of all three types. For example, the following assignment statement creates a variable named `var` whose value is the sum of the third and fourth field variables in the current record:

```
var = $3 + $4
```

You can use variables as part of a pattern, and you can manipulate them in actions. For example, the following program assigns a value to a variable named `tst` and then uses `tst` as part of a pattern for further actions:

```
{ tst = $1 }
tst == $3 { print }
```

Section 2.3.1, Section 2.3.2, and Section 2.3.3 discuss the three types of variables and how to use them. Some of the examples in these sections illustrate the use of other `awk` features; beginning with Section 2.4, the remaining sections in the chapter provide more detailed information about these features.

2.3.1 Simple Variables

You can create any number of simple (scalar) variables, assigning values to them as required. If you refer to a variable before explicitly assigning a value to it, `awk` creates the variable and assigns it a value of 0 (zero). Variables can have numeric (floating-point) values or string values depending on their use in the action expression. For example, in the expression `x = 1`, `x` is a numeric variable. Similarly, in the expression `x = "smith"`, `x` is a string variable. However, `awk` converts freely between strings and numbers when needed. Therefore, in the expression `x = "3"+"4"`, `awk` assigns a value of 7 (numeric) to `x`, even though the arguments are literal strings. If you use a variable containing a nonnumeric value in a numeric expression, `awk` assigns it a numeric value of 0. For example:

```
y = 0
z = "ABC"
x = y+z
print x, z
```

This sequence prints “0 0” because `y` is assigned a value of 0 and `z` assumes a value of 0 when used numerically.

You can force a variable to be treated as a string by concatenating the null string (“”) to the variable; for example, `x = 2 ""`. (See Section 2.12

for information on concatenating strings.) You can force a variable to be treated numerically by adding zero to it. Forcing variables to be treated as particular types can be useful. For example, if x is "0100" and y is "1", `awk` usually treats both variables as numerics and considers that x is greater than y . Forcing both variables to be treated as strings causes x to be less than y because "0" precedes "1" in standard character collating sequences.

2.3.2 Field Variables

Fields in the current record, also called **field variables**, share the properties of simple variables. They can be used in arithmetic or string operations and can be assigned numeric or string values. You can modify `$0` explicitly in `awk`. The following action replaces the first field with the record number and then prints the resulting record:

```
{ $1 = NR; print }
```

The next example adds the second and third fields and stores the result in the first field:

```
{ $1 = $2 + $3; print $0 }
```

(Printing `$0` is identical to printing with no arguments.)

You can use numeric expressions for field references; the following example prints the first, second, and sixth fields:

```
i = 1
n = 5
{ print $i, $(i+1), $(i+n) }
```

As described in Section 2.3.1, `awk` converts between string and numeric values. How you use a field determines whether `awk` treats it as a string or numeric value. If it cannot tell how a given field is used, `awk` treats it as a string.

The `awk` program splits input records into fields as needed. You can split any literal string or string variable into an array by using the `split` function. For example:

```
x = split(s, array1)
y = split("Thu Mar 18 11:19:40 EST 1999", array2)
```

The first line in this example splits the variable `s` into elements of an array named `array1`, creating `array1[1]` to `array1[n]` where `n` is the number of fields in the string. The second line splits a literal string in the same manner into `array2`. The `split` function can split strings by using an alternative field separator; see Section 2.9 for more information on using this function. See Section 2.3.3 for information on using arrays.

2.3.3 Array Variables

Like field variables, array variables share the properties of simple variables. They can be used in arithmetic or string operations and can be assigned numeric or string values. You do not need to declare or initialize array elements; `awk` creates them and initializes them to zero upon first reference. Subscripts are indicated by being enclosed in brackets. You can use any value that is not null, including a string value, for a subscript. An example of a numeric subscript follows:

```
x[NR] = $0
```

This expression creates the *NR*th element of the array *x* and assigns the contents of the current input record to it. The following example illustrates using string subscripts:

```
/apple/ { x["apple"]++ }
/orange/ { x["orange"]++ }
END     { print x["apple"], x["orange"] }
```

For each input record containing `apple`, this program increments the `apple`th element of array `x` (and similarly for `orange`), thereby producing and printing a count of the records containing each of these words. (This is not a count of the number of occurrences, because a word can appear more than once in a record.)

Problems can occur when you use an `if` or `while` statement to locate an array element. (See Section 2.10 for information on using these and other control structures.) If the array subscript does not exist, the statement adds the subscript as a new B-tree node with a null value. For example:

```
{ if (exists[$2] == 1) }
```

To avoid this type of problem, use code similar to the following, in which *i* is printed after an `if` statement within a `for` loop:

```
for (i in exists) {
    if (exists[i] != "") print i
}
```

Also use this type of coding when `while` is used with a relational operator.

2.3.4 Built-In `awk` Variables

The `awk` programs recognize the set of built-in variables listed in Table 2-2.

Table 2–2: Built-In Variables in awk

Variable	Description
\$0	The contents of the current record.
\$n	The contents of field <i>n</i> of the input record. In <code>awk</code> you can modify the entire record (<code>\$0</code>).
ARGC	A count of the arguments given to <code>awk</code> . This variable is modifiable. Does not include the command name, flags preceded by minus signs, the script file name (if any), or variable assignments.
ARGV	An array containing the arguments given to <code>awk</code> . The elements of this array are modifiable. Does not include the command name, flags preceded by minus signs, the script file name (if any), or variable assignments.
CONVFMT	The conversion format for numbers (by default, <code>%.6g</code>).
ENVIRON	A modifiable array containing the current set of environment variables; accessible by <code>ENVIRON[<i>var</i>]</code> , where <i>var</i> is the name of the environmental variable. Changing an element in this array does not affect the environment passed to commands that <code>awk</code> spawns by redirection, piping, or the <code>system()</code> function.
FILENAME	The name of the current input file. If no input file was named, <code>FILENAME</code> contains a single minus sign. Inside a <code>BEGIN</code> action, <code>FILENAME</code> is undefined. Inside an <code>END</code> action, <code>FILENAME</code> reflects the last file read.
FNR	The number of the current record within the current file. Differs from <code>NR</code> if multiple files are being processed and the current file is not the first file read.
FS	The character or expression used for a field separator. By default, any amount of white space. In <code>awk</code> , field separators can be multibyte regular expressions and can be multiply defined. For example, the following statement defines either a comma followed by any amount of white space or at least one white-space character as the field separator: <code>FS = ", [<code>Tab</code>] * [<code>Tab</code>] +"</code>
NF	The number of fields in the current record.
NR	The number of the current record, counted sequentially from the beginning of the first file read. Differs from <code>FNR</code> if multiple files are being processed and the current file is not the first file read.
OFMT	The format specification for numbers on output (by default, <code>%.6g</code>).
OFS	The output field separator; or string inserted between fields when the data is written. By default, a space character.

Table 2–2: Built-In Variables in awk (cont.)

Variable	Description
ORS	The character used for the output record separator (the character between records when the data is written). By default, a newline character.
RLENGTH	The length of the string matched by <code>match()</code> ; set to <code>-1</code> if no match.
RS	The character used for a record separator.
RSTART	The index (position within the string) of the first character matched by <code>match()</code> ; set to <code>0</code> if no match.
SUBSEP	The separator for multiple subscripts in array elements (by default <code>\034</code> , the ASCII FS character).

See the `awk(1)` reference page for more information about these variables.

2.4 More About Using Regular Expressions as Patterns

The simplest regular expression is a literal string of characters. Expressions in `awk` must be enclosed in slashes. To include a slash as part of an expression, escape the slash with a backslash. For example, `/\usr/share/` is an expression that matches the string `/usr/share`.

Following is an example of an `awk` program that prints all records containing the string `the`.

```
/the/
```

Because this expression does not specify blanks or other qualifiers, the program displays records containing “the” as a separate word and records containing the string as part of words such as “northern”. Regular expressions are case sensitive. To find either “The” or “the”, use a bracketed expression as follows:

```
/[Tt]he/
```

The `awk` language supports the full set of extended regular expressions described in Chapter 1. Additionally, in `awk` the circumflex (^) and dollar sign (\$) can apply to a specific field or variable as well as to the entire line. The following example will match a field consisting of the word, `cat`, or the word, `cats`, but will not match any word containing these strings (such as `concatenate`):

```
{ for (i=1;i<=NF;i++) if ($i ~ /^cats?$/) print }
```

2.5 Using Relational Expressions and Combined Expressions as Patterns

Relational expressions let you restrict a match to a specific field of a record or to make other tests, either numeric or string-related. One example earlier in this chapter (in Section 2.3) illustrates the use of relational expressions in patterns. The `awk` program defines the following relational operators for use in building patterns:

<code>==</code>	Equivalent
<code>!=</code>	Not equivalent
<code><</code>	Less than
<code>></code>	Greater than
<code><=</code>	Less than or equal
<code>>=</code>	Greater than or equal
<code>~</code>	Matches regular expression
<code>!~</code>	Does not match regular expression

Use the `==` (equivalent) and `!=` (not equivalent) operators to test literal strings and numeric values. For example:

```
str == "literal string"
num != 23
$NF == 1991
```

The last line in this example uses the `$n` syntax combined with the built-in variable `NF` to test the value of the last field of a record. To test against regular expressions, use the `~` (matches regular expression) and `!~` (does not match regular expression) operators as follows:

```
str ~ /[Ll]iteral/
```

You can test relational expressions against built-up expressions. For example, the following pattern finds all records whose second field (`$2`) is at least 100 greater than the first field (`$1`):

```
$2 > $1 + 100
```

The following pattern finds records that contain an even number of fields:

```
NF % 2 == 0
```

Use the operators listed in Section 2.8 to build expressions.

You can use magnitude-comparison operators to test strings. For example, the following pattern finds records that begin with `s` or any character that appears after it to the end of the character set:

```
$0 >= "s"
```

You can combine two or more patterns by using the following Boolean operators:

&&	AND
	Logical OR
!	NOT

For example, to prevent nonalphanumeric matches in the preceding example, you can combine two expressions as follows:

```
($0 >= "s" && $0 < "{")
```

(The left brace is the character immediately following the letter z in the ASCII code.)

2.6 Using Pattern Ranges

You can use a pattern range to select a group of records to operate on. A pattern range consists of two patterns separated by a comma; the first pattern specifies the start of the range, and the second pattern specifies the end of the range. The `awk` program performs the associated action on all records in the range, including the records that match the two patterns. For example:

```
NR==100,NR==200 { print }
```

This program prints 101 records from the input file, beginning with record 100 and ending with record 200.

Using a pattern range does not disable other patterns from matching records within the range. However, because the input file is processed record by record, with each record being subject to all the actions appropriate to it before the next record is considered, the actions taken can appear to be out of sequence. For example:

```
2,4 { print }  
/share/ { print "Found share" }
```

Apply this program to the following input file:

```
This is a test file  
Line two  
Try to share things  
Line four  
Last line of file
```

When this file is processed by `awk`, the output is as follows:

```
Line two  
Try to share things  
Found share  
Line four
```

The second action is applied to record 3 before record 4 is examined to see if it matches the first pattern.

2.7 Actions in awk

An action can be a single command, such as `print`, or it can be a series of commands. An action can include tests to select records or parts of records; you can also create a program that has no explicit patterns, relying instead on relational comparisons within its actions. Such a program can bear a strong resemblance to a C program; for example:

```
{
  if ($1 == 0) {
    print;
    printf("%5.2f\n", $2+$3)
  } else {
    printf("%5.2f\n", $1+$2)
  }
}
```

Note

The semicolon after the `print` command, which would be required in a C program, is not required by `awk`, but it does not cause an error.

2.8 Using Operators in an Action

Use the operators shown in Table 2–3 to build expressions within the action statement.

Table 2–3: Operators for awk Actions

Operator	Description	Example
+	Addition	2+3 = 5
+	Unary plus; placeholder	+4 = 4
-	Subtraction	7-3 = 4
-	Unary minus	-4 is negative 4
*	Multiplication	2*4 = 8
/	Division	6/3 = 2
%	Modulo (remaindering)	7%3 = 1
++	Increment	See the description following this table.

Table 2–3: Operators for awk Actions (cont.)

Operator	Description	Example
--	Decrement	See the description following this table.
+=	Increment by value	$x+=y$ is equivalent to $x = x+y$
-=	Decrement by value	$x-=y$ is equivalent to $x = x-y$
=	Multiply by value	$x=y$ is equivalent to $x = x*y$
/=	Divide by value	$x/=y$ is equivalent to $x = x/y$
%=	Modulo by value	$x%=y$ is equivalent to $x = x\%y$

The following example prints the sum of all the first fields and the sum of all the second fields in the input file:

```
{ s1 += $1; s2 += $2 }
END { print s1,s2 }
```

The position of the increment and decrement operators affects their interpretation. The expression $i++$ evaluates the current contents of i and then increments i . The expression $++i$ causes `awk` to increment i before evaluation. For example:

```
$ echo "3 3" | awk '{
>   print "$1 =", $1 "; $1++ =", $1++ "; new $1 =", $1
>   print "$2 =", $2 "; ++$2 =", ++$2 "; new $2 =", $2
> }'
$1 = 3; $1++ = 3; new $1 = 4
$2 = 3; ++$2 = 4; new $2 = 4
```

2.9 Using Functions Within an Action

The `awk` language includes the built-in mathematical functions listed in Table 2–4.

Table 2–4: Built-In awk Mathematical Functions

Function	Description
<code>atan2(x/y)</code>	Returns the arctangent of the value specified by x/y .
<code>cos(expr)</code>	Returns the cosine of the value (in radians) specified by <i>expr</i> .
<code>exp(arg)</code>	Returns the natural antilogarithm (base e) of <i>arg</i> . For example, <code>exp(0.693147)</code> returns 2. See <code>log(arg)</code> .
<code>int(arg)</code>	Returns the integer part of <i>arg</i> .

Table 2–4: Built-In awk Mathematical Functions (cont.)

Function	Description
<code>log(arg)</code>	Returns the natural logarithm (base e) of <i>arg</i> . For example, <code>log(2)</code> returns 0.693147. See <code>exp(arg)</code> .
<code>rand</code>	Returns a pseudorandom number ($0 \leq n < 1$).
<code>sin(arg)</code>	Returns the sine of the value (in radians) specified by <i>arg</i> .
<code>sqrt(arg)</code>	Returns the square root of <i>arg</i> .
<code>srand(seed)</code>	Uses <i>seed</i> as the seed for a pseudorandom number sequence for subsequent calls to <code>rand</code> . If no seed is specified, the time of day is used. The return value is the previous seed.

The `awk` language includes the built-in string functions listed in Table 2–5.

Table 2–5: Built-In awk String Functions

Function	Description
<code>gsub(expr, s1, s2)</code>	Replaces every sequence of characters in string <i>s2</i> that matches the expression <i>expr</i> with the string specified by <i>s1</i> . If <i>s2</i> is not supplied, the current input record is used. Expression <i>expr</i> is reevaluated for each match. This function returns a value representing the number of replacements. See also <code>sub(expr, s1, s2)</code> .
<code>index(s1, s2)</code>	Returns the character position in string <i>s1</i> where string <i>s2</i> occurs. If <i>s2</i> is not in <i>s1</i> , this function returns a zero.
<code>length</code>	Returns the length in characters of the current record.
<code>length(arg)</code>	Returns the length in characters of the string specified by <i>arg</i> . See <code>length</code> .
<code>match(s, expr)</code>	Returns the character position in string <i>s</i> where a match is found for the expression <i>expr</i> ; sets the variable <code>RSTART</code> to the character position at which the match begins and <code>RLENGTH</code> to a value representing the length of the matched string. If no match is found, this function returns a zero.
<code>split(s, array, sep)</code>	Splits string <i>s</i> into consecutive elements of <code>array[1] . . . [n]</code> and returns the number of elements. The optional <i>sep</i> argument specifies a field separator other than the one currently in force (the contents of the <code>FS</code> variable).

Table 2–5: Built-In awk String Functions (cont.)

Function	Description
<code>sprintf(f, e1, e2 , ...)</code>	Returns (but does not print) a string containing the arguments <i>e1</i> and so on, formatted in the same manner as by the <code>printf</code> command.
<code>strftime(f, time)</code>	Formats <i>time</i> into a string as specified by <i>f</i> . The <i>time</i> value should be specified in the form returned by <code>systemtime()</code> . See the <code>strftime(3)</code> reference page for a list of the available format conversions.
<code>sub(expr, s1, s2)</code>	Replaces the first sequence of characters in string <i>s2</i> that matches the expression <i>expr</i> with the string specified by <i>s1</i> . If <i>s2</i> is not supplied, the current input record is used. This function returns a value representing the number of replacements (0 or 1). See also <code>gsub(expr, s1, s2)</code> .
<code>substr(s, m, n)</code>	Returns the substring of <i>s</i> that begins at character position <i>m</i> and is <i>n</i> characters long. The first character in <i>s</i> is at position 1. If <i>n</i> is omitted or if the string is not long enough to supply <i>n</i> characters, the rest of the string is returned.
<code>tolower(s)</code>	Translates all uppercase letters in string <i>s</i> to lowercase. If there is no argument, the function operates on the current record.
<code>toupper(s)</code>	Translates all lowercase letters in string <i>s</i> to uppercase. If there is no argument, the function operates on the current record.

The `awk` language includes the built-in miscellaneous functions listed in Table 2–6.

Table 2–6: Built-In awk Miscellaneous Functions

Function	Description
<code>close(arg)</code>	Closes the file or pipe named by <i>arg</i> .
<code>delete(array[sub])</code>	Deletes the element of <i>array</i> indicated by <i>sub</i> .
<code>system("command")</code>	Executes the system command specified and returns its exit status. The entire command must be enclosed in quotation marks to prevent <code>awk</code> from attempting to interpret it as one or more variable names.
<code>systemtime()</code>	Returns the current time of day as the number of seconds since midnight, January 1, 1970.

The `awk` language also lets you create functions by using the following syntax:

```
function name (parameter-list) {
    statements
}
```

The word `func` can be used in place of `function`. For functions that you create, the left parenthesis both in the function's definition and in its use must immediately follow the function name with no intervening space. The names in the function declaration's parameter list are the formal parameters for use within the function. When you call a function, `awk` replaces these formal parameters with the values you supply in the calling statement. Functions can be recursive.

You can define local variables for a given function by declaring them as extra formal parameters; upon function entry, all local variables are initialized as empty strings or the number 0. To avoid visual confusion between real parameters and local variables, you can separate the local variables with extra spaces in the function declaration. For example:

```
function foo(in, out,      local1, local2) {
    local1 = "foo"
    local2 = "bar"
    :
}
```

2.10 Using Control Structures in `awk`

The `awk` language provides the control structures listed in Table 2-7. Except where noted, these structures work exactly as they do in the C language. To perform several statements in a single control structure's action, enclose the statements in braces. If only a single statement is to be performed, the braces are optional. Each of the first two `if` structures in the following example includes a single statement to be executed; these structures are equivalent:

```
{
    if (x == y) print
    if (x == y) {
        print
    }
    if (x == y) {
        print $3
        printf("Sum = %d\n", x+z)
    }
}
```

Table 2–7: Control Structures in awk

Structure	Description
if-else	The condition in parentheses in an if-else structure is evaluated. If true, the statements following the if are performed. If false, the statements following the optional else keyword are performed.
while	The statements following the while statement are performed as long as the tested condition is true. The following example prints all the fields in the input records, one field per line: <pre>{ i = 1 while(i<=NF) print \$i++ }</pre>
for	The for(<i>expr1</i> ; <i>expr2</i> ; <i>expr3</i>) statements structure is equivalent to the following while construct: <pre>{ <i>expr1</i> while(<i>expr2</i>) { <i>statements</i> <i>expr3</i> } }</pre> <p>The previous while example could also be written as follows:</p> <pre>{ for(i=1;i<=NF;++i) print \$i }</pre>
break	The break statement causes an immediate exit from an enclosing while or for loop.
Comments	Include comments in an awk program file to explain program logic. Comments begin with the number sign (#) and end with the end of the line. For example: <pre>{ print x,y # This is a comment }</pre>
continue	The continue statement causes the next iteration of an enclosing loop to begin.
getline	The getline statement causes awk to discard the current input record, read the next input record, and continue scanning patterns from the present location. By using getline <i>var</i> , you can assign the getline input to a variable; without <i>var</i> , the input is assigned to the current record.

Table 2–7: Control Structures in awk (cont.)

Structure	Description
<code>next</code>	The <code>next</code> statement causes <code>awk</code> to discard the current input record, read the next input record, and begin scanning patterns from the start of the program file.
<code>exit</code>	The <code>exit</code> statement causes the program to stop as if the end of the input occurred.

2.11 Performing Actions Before or After Processing the Input

The `awk` program recognizes two special pattern keywords that define the beginning (`BEGIN`) and the end (`END`) of the input file. `BEGIN` matches the beginning of the input before reading the first record. Therefore, `awk` performs any actions associated with this pattern once, before processing the input file. `BEGIN` must be the first pattern in the program file. For example, to change the field separator to a colon (`:`) for all records in the file, include the following line as the first line of the program file:

```
BEGIN { FS = ":" }
```

This example action works the same as using the `-F:` flag on the command line.

Similarly, `END` matches the end of the input file after processing the last record. Therefore, `awk` performs any actions associated with this pattern once, after processing the input file. `END` must be the last pattern in the program file. For example, to print the total number of records in the input file, include the following line as the last line in the program file:

```
END { print NR }
```

2.12 Concatenating Strings

You concatenate strings by placing their variable names together in an expression. For example, the command `print $1 $2` prints a string consisting of the first two fields from the current record, with no space between them. You can use variables, numeric operators, and functions when concatenating strings. (See Section 2.3.1 and Section 2.8 for information on variables and numeric operators.) The function `length($1 $2 $3)` returns the length in characters of the first three fields. (See Section 2.9 for a list of the functions in `awk`.) If the strings you want to concatenate are field variables (see Section 2.3.2), you are not required to separate the names with white space; the expression `$1$2` is identical to `$1 $2`.

2.13 Redirection and Pipes

Unless otherwise specified, `print` and `printf` statements write their output to the standard output file. You can redirect the output of any printing statement by using standard redirection operators. For example:

```
print $0, $3, amt >> "reportfile"
```

This example appends its output to a file named `reportfile` instead of writing to the standard output. (If `reportfile` does not exist before the first instance of redirection, it is created.) The output file name in this example is enclosed in quotation marks. The quotation marks are required to distinguish the file name from a variable name. You can mix writing to named files with writing to the standard output.

You can also pipe printed output through other commands. The following example pipes `awk`'s output through the `tr` command to convert all uppercase letters to lowercase letters:

```
print | "tr ' [A-Z]' '[a-z]'"
```

As with redirection, the command to which you pipe the output must be enclosed in quotation marks. In `awk` you can redirect the input to `getline` using standard redirection operators, and you can supply the input to `getline` from a pipe. For example:

```
expr | getline
```

Here, `expr` is interpreted as a system command.

Only a limited number of files can be open for output. The `awk` program uses your default open file descriptor limit. For efficiency, however, you can use the `close(arg)` statement to close files that you have opened for output and no longer need.

Editing Files with the sed Editor

This chapter describes the `sed` stream editor, which is a program that works much like the interactive `ed` program, but you do not need to know how to use the `ed` line editor to use the material presented here. The following sections explain the `sed` editor:

- Overview of the `sed` editor
- Running the `sed` editor
- Selecting lines for editing
- Summary of `sed` commands
- String replacement

Unlike `ed`, `sed` edits files by using a prepared list of commands, called a **script**, instead of interacting with the user. This method of operation makes `sed` particularly well suited for tasks like the following:

- Editing large files
- Performing complex editing operations many times without extensive retyping and cursor positioning
- Performing global changes in one pass through the input

3.1 Overview of the sed Editor

The `sed` stream editor receives its input from standard input or from a named file, changes that input as directed by commands in a command file or on the command line, and writes the resulting stream to standard output. If you specify more than one input file, `sed` processes each file in sequence and concatenates the results to standard output. If you do not provide a command file and do not use any with the `sed` command flags, `sed` copies standard input to standard output without change. The editor keeps only a few lines of the file being edited in memory at one time and does not use temporary files. Therefore, the size of the file to be edited is limited only by the available disk space.

The command script for `sed` can be a file that you create before running the editor, a series of commands you enter as a command flag, or both. The editor cannot process more than 99 commands in a single invocation; for this

reason or to accomplish certain extremely complex editing tasks, you might need to pipe the output from `sed` into another instance of `sed`.

3.2 Running the `sed` Editor

The syntax for the `sed` command is as follows:

```
sed [[-n]] [[[-e]] [script]] [[-f script_file]] [[source_file1][[source_file2 ...]]]
```

Table 3-1 describes the flags for the `sed` command.

Table 3-1: Flags for the `sed` Command

Flag	Description
<code>-e <i>script</i></code>	Adds the editing commands specified by the string <i>script</i> to the end of the script of editing commands. If you are using just one <code>-e</code> flag and no <code>-f</code> flag, you can omit the <code>-e</code> flag and include the single <i>script</i> on the command line as an argument to <code>sed</code> .
<code>-f <i>script_file</i></code>	Uses <i>script_file</i> as the source of the edit script. The <i>script_file</i> is a set of editing commands to be applied to the input.
<code>-n</code>	Suppresses all information usually written to standard output.

The order of presentation of the `-e` and `-f` options is important. Usually, you create a command file containing the editing commands before running `sed`. The `sed` editor's command set is powerful and requires little typing. Each command in the command file can be on a separate line, or you can place multiple commands on one line by separating them with semicolons (;). For example, either of the following two scripts will delete all lines beginning with `.ne`, `.RE`, or `.RS`:

Script 1:

```
/^\.ne/d  
/^\.R[ES]/d
```

Script 2:

```
/^\.ne/d;/^\.R[ES]/d
```

Once you create the command file (`cmdfile` in the following example), enter the `sed` command as in this example:

```
$ sed -f cmdfile infile > outfile
```

This command edits `infile` using the commands contained in `cmdfile`, and writes the output to `outfile`. The input file is not changed.

With a short editing script, you can accomplish the same job by entering the editing commands as an argument to the `-e` flag on the command line:

```
$ sed -e '/^\.ne/d;/^\.R[ES]/d' infile > outfile
```

If you use the `-e` and `-f` flags together on a command line, `sed` applies all the commands specified by both flags, in the order in which the flags appear. For example:

```
$ echo "s/line/foo/" > sedx
$ echo "Test line" | sed -f sedx -e 's/line/bar/'
Test foo
$ echo "Test line" | sed -e 's/line/bar/' -f sedx
Test bar
```

You can use the `-e` and `-f` flags more than once with a given `sed` command. For example:

```
$ sed -f script1 -e 's/foo/bar/' -f script2 msgs > msgs2
```

When you start `sed`, the editor reads and compiles the command script, checking for syntax and organizing the commands for efficiency. It then reads the input file one line at a time into an area of memory called the **pattern space**. The editor then tries to match the addresses specified by the commands in the script, one after another, to the lines in the pattern space. Whenever a command's address matches any line or lines in the pattern space, `sed` applies that editing command to the matched text.

Commands are applied in sequence to the text, and the results of each command are used as the input for subsequent commands. When no more commands match a given line in the pattern space, `sed` writes that line to the output, reads more input, and repeats the process. Figure 3-1 is a flowchart of this sequence. Compare the operation of `sed` with the very similar operation of the `awk` program, shown in Figure 2-1.

Figure 3–1: Sequence of sed Processing

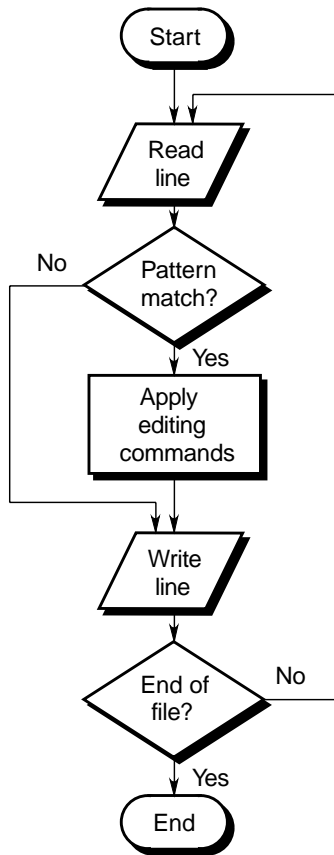

ZK0453UR

Some editing commands change the way the editing process operates by causing the editor to bypass other script commands, by inhibiting the writing of certain lines (by deleting them), or by ending the process prematurely.

3.3 Selecting Lines for Editing

The `sed` editor identifies lines to be edited by matching addresses. An address can be either a line number or a context address:

- **Line numbers:** The first line in the input stream is line 1, and each successive line increments the line counter by one. The dollar sign (\$) is a shorthand way to specify the last line of the input stream. If you edit more than one file in a single invocation of `sed`, the line counter is cumulative across all the files edited; for example, if the first file contains 100 lines, the first line of the second file is line 101.

- **Context addresses:** A context address is a regular expression enclosed in pattern delimiters (usually slashes); for example, `/^\.R[ES]/` matches any line beginning with either `.RE` or `.RS`.

You can specify any character as a pattern delimiter for a given command by preceding the first use of the character with a backslash. For example, the following two patterns are interpreted identically:

```
/abc/
\xabcx
```

In the second pattern, the letter `x` is used as the pattern delimiter. If you use an alternative pattern delimiter in this way, you can match a literal occurrence of that character by preceding it with a backslash; the pattern `\x\xyzx` matches the string “xyz”.

The `sed` editor recognizes the standard set of basic regular expressions described in Chapter 1. In addition to these expressions, `sed` recognizes the special expressions shown in Table 3–2.

Table 3–2: Special Regular Expressions Recognized by `sed`

Expression	Name	Rule
<code>\n</code>	Embedded newline (a backslash followed by the letter <code>n</code>)	Matches an embedded newline character in a line formed by joining multiple lines.
<code>//</code>	Empty pattern delimiters (slashes by default)	Matches the text that matched the most recently specified regular expression.

Some `sed` commands do not accept addresses. Commands that accept addresses behave differently depending on the number of addresses, as follows:

- If no address is specified, the command is applied to every line in the input stream.
- If one address is specified, the command is applied to each line that matches the address.
- If two addresses are specified, the command is applied to a group of lines starting with a line that matches the first address and ending with the first subsequent line that matches the second address. The editor then tries to match the first address again to find another range.

Note

If two addresses are specified but `sed` cannot find a line matching the ending address, `sed` operates on every line from the first address to the end of the file.

3.4 Summary of `sed` Commands

Each `sed` command consists of a single letter with optional addresses. Some commands require arguments and accept qualifiers that alter their behavior. Do not include any space between the addresses and the letter. If you use two addresses with a command, separate them with a comma. The `r` and `w` commands and the `w` flag for the `s` command require a single space between the letter and the argument; otherwise, do not include any space between the letter and the argument.

In the tables below, the following conventions apply:

- The term, range of lines, can mean a single line, a group of lines, or all lines, as specified by the number of addresses given to the command.
- Brackets [] enclose optional elements. Nested brackets indicate that the nested element can be used only if the enclosing element is present.
- *Italic (slanted) type* indicates a general name for an object that you specify; for example, *file* represents a command argument that must be the name of a file.

The following example illustrates a correctly formed `s` command with all optional elements:

```
1,/^\$/s/vizier//g
```

This example processes the header of a mail message (line 1 to the first completely blank line), replacing the string `vizier` with nothing wherever the string occurs on any line in the specified range.

Table 3–3 describes the text editing and movement `sed` commands, showing the syntaxes.

Table 3–3: Text Editing and Movement Commands

Command	Description
Append text	
<code>[addr1]a\ text\ text...</code>	Writes the specified text ^a to the output after the line specified by <code>addr1</code> . See also the <code>i</code> command.
Change lines	

Table 3–3: Text Editing and Movement Commands (cont.)

Command	Description
<code>[addr1[,addr2]]c\ text\ text...</code>	Deletes the addressed range of lines and writes the specified text ^a to the output in its place. ^b
Delete lines	
<code>[addr1[,addr2]]d</code>	Deletes the specified range of lines. ^b
Delete the first line of the pattern space	
<code>[addr1[,addr2]]D</code>	Deletes all text in the pattern space up to and including the first newline character. If only one line is in the pattern space, this command reads another line from the input into the pattern space. After these operations, the command starts the complete list of editing commands again from the beginning.
Insert lines	
<code>[addr1]i\ text\ text...</code>	Writes the specified text ^a to the output before the line specified by <i>addr1</i> . See also the <i>a</i> command.
Advance in the file	
<code>[addr1[,addr2]]n</code>	Writes the indicated range from the pattern space (if not deleted) to the output and then reads the next line from the input into the pattern space.
Join lines	
<code>[addr1[,addr2]]N</code>	Joins the indicated lines together as a single line with embedded newline characters. If only one address is given, the command joins the specified line to the next line in the input stream. Pattern matches for addressing or for string replacement can extend across embedded newline characters. Use <code>\n</code> to indicate an embedded newline character for matching.
Print lines	
<code>[addr1[,addr2]]p</code>	Writes the specified range of lines to the output at the point in the editing process where the <i>p</i> command appears. This command can be used to reorder sections of a file.
Print the first line in the pattern space	
<code>[addr1[,addr2]]P</code>	Writes all text in the pattern space, up to and including the first newline character, to the output at the point in the editing process where the <i>P</i> command appears.
Read and append a file	

Table 3–3: Text Editing and Movement Commands (cont.)

Command	Description
<code>[addr1]r file</code>	Reads the named file ^c and writes the file's contents to the output after <i>addr1</i> .
Substitute text	
<code>[addr1[,addr2]]s/expr/string/[flags]</code>	Searches the indicated lines for a string of characters matching the expression defined by <i>expr</i> , and replaces that set of characters with <i>string</i> . This command's operation is modified by the <i>g</i> , <i>p</i> , and <i>w</i> <i>file</i> flags. If either <i>expr</i> or <i>string</i> includes a slash (/), you must escape the literal slash with a backslash (<code>s/path/path\file/</code>) or use alternative delimiters such as the at sign (@) or question mark (?). For example, <code>s@path@path/file@</code> replaces <i>path</i> with <i>path/file</i> . ^d
Write a named file	
<code>[addr1[,addr2]]w file</code>	Writes the specified range of lines to the named file ^e at the point in the editing process where the <i>w</i> command appears.
Print line number	
<code>[addr1]=</code>	Writes the line number of the indicated line to the output.

^a If the text to be written consists of multiple lines, each line except the last must have a backslash (\) before the terminal newline character. The text is always written regardless of anything subsequent commands do to the line that caused it to be written, including deletion of that line. It is neither scanned for address matches nor affected by subsequent editing commands, and it has no effect on the editor's line counter.

^b If no addresses are given, the *d* command deletes all lines in the pattern space; unless constrained by a range controlling a group of commands in braces, the command deletes the entire contents of the file.

^c Include exactly one space between the *r* command and the file name. If *file* cannot be accessed, *sed* behaves as if it had read an empty file and gives no abnormal indication. A combined maximum of 10 files can be named for reading or writing in any given editing process.

^d See Section 3.5 for descriptions of the *s* command's optional flags.

^e Include exactly one space between the *w* command and the file name. If *file* exists, it is overwritten; if not, it is created. A combined maximum of 10 files can be named for reading or writing in any given editing process.

Table 3–4 describes the buffer manipulation *sed* commands, showing the syntaxes.

Table 3–4: Buffer Manipulation Commands

Command	Description
Retrieve text from hold area	

Table 3–4: Buffer Manipulation Commands (cont.)

Command	Description
<code>[addr1[,addr2]]g</code>	Copies the contents of the hold area to the pattern space indicated by <code>addr1</code> and <code>addr2</code> , if present. The <code>g</code> command destroys the existing contents of the pattern space; the <code>G</code> command appends the held text to the contents of the pattern space, separating the previous text from the appended text with a newline character.
<code>[addr1[,addr2]]G</code>	
Move text to the hold area	
<code>[addr1[,addr2]]h</code>	Copies the indicated range from the pattern space to the hold area. The <code>h</code> command destroys the existing contents of the hold area; the <code>H</code> command appends the text in the pattern space to the contents of the hold area, separating the previous text from the appended text with a newline character.
<code>[addr1[,addr2]]H</code>	
Exchange pattern space and hold area	
<code>[addr1[,addr2]]x</code>	Exchanges the contents of the pattern space with those of the hold area.

Table 3–5 describes the flow of control `sed` commands, showing the syntaxes.

Table 3–5: Flow-of-Control Commands

Command	Description
Range negation	
<code>[addr1[,addr2]]!cmd</code>	The exclamation point (!) instructs <code>sed</code> to apply the command following it on the same line to the parts of the input file that are not selected by <code>addr1</code> and <code>addr2</code> instead of applying it to the selected range.
Command grouping	
<code>[addr1[,addr2]]{ <i>nested commands</i> }</code>	The left and right braces enclose a group of commands to be applied as a set to the range specified by <code>addr1</code> and <code>addr2</code> . The first command in the set can be on the line following the left brace, as illustrated in this table, or it can be on the same line with the brace. The right brace must be on a line by itself. Groups can be nested within other groups.
Label	
<code>:label</code>	Marks a place in the stream of editing commands to be used as a destination of a branch command. The label is a string of up to 8 bytes. Each label in the editing stream must be unique. For a related discussion, see the description of the <code>t</code> command in the <code>sed(1)</code> reference page.

Table 3–5: Flow-of-Control Commands (cont.)

Command	Description
Branch	
<i>blabel</i>	Branches to the point in the editing script indicated by <i>label</i> and continues processing the current input line with the commands following the label. If <i>label</i> is null, the <i>b</i> command bypasses the rest of the editing script, reads a new input line, and starts the editing script over from the beginning.
Conditional branch	
<i>tlabel</i>	If any successful substitutions were made on the current input line, branches to <i>label</i> ; otherwise, the command does not branch. In either case, the command clears the flag that indicates a substitution was made. This flag is also cleared at the start of each new input line. If <i>label</i> is null and the branch is taken, the <i>t</i> command bypasses the rest of the editing script, reads a new input line, and starts the editing script over from the beginning.
Stop	
<i>[addr1]q</i>	Stops editing in an orderly fashion by writing the current line to the output, writing any appended or read text to the output, and then exiting.

3.5 String Replacement

The *s* command performs string replacement on the indicated lines in the input file. If the editor finds a string of characters in the input file that satisfies the pattern expression *expr*, it replaces that string with the set of characters specified in *string*. The *string* argument is not a regular expression, and it is not scanned or otherwise interpreted except as follows:

- Any backslash characters (\) appearing in *string* must be escaped. See Table 3–3 for an explanation of how to handle slash characters (/) in *string*.
- The following two special symbols can be used in *string*:
 - Ampersand (&) This symbol in *string* is replaced by the exact string of characters in the input lines that matched *expr*. For example, apply the command *s/[Bb]oy/&s/* to the following line:

The boy watched the game.

This command tells *sed* to find either *Boy* or *boy* in the input line and copy whichever pattern it finds to the output with an appended *s*. Because the command finds *boy*, it transfers that string to the output with the modification, and the result is as follows:

The boys watched the game.

- **Back-reference expression ($\backslash n$)** The number n is a single digit. This symbol in *string* is replaced by the string in the input line that matches the n th subexpression in *expr*. Subexpressions in basic regular expressions are delimited by backslash-parentheses sets, $\backslash ($ and $\backslash)$. For example, apply the command `s/\(stu\)\(dy\)/\1r\2/` to the following line:

The study chair.

This command tells `sed` to find `study` in the input line and copy that pattern to the output with an `r` inserted in the middle. The result is as follows:

The sturdy chair.

You can modify the behavior of the `s` command with flags, as follows:

- Usually, only the first matching string in each line of the range is replaced. The `g` (global) flag causes `sed` to make the substitution for all matching strings anywhere on any line in the range. The matching strings do not have to be identical; the expression *expr* is evaluated again for each potential match.
- The `p` (print) flag instructs `sed` to write the indicated lines explicitly after making any substitutions; this writing action is in addition to `sed`'s normal operation.
- The `w file` (write) flag instructs `sed` to write the indicated lines to the named file after making any substitutions. Include exactly one space between the `w` flag and the file name.

Any or all of these flags can be used with a given `s` command; in combinations, the `w` flag must be the last flag specified.

4

Creating Input Language Analyzers and Parsers

If a program needs to receive and process input, there must be a means of analyzing the input before it is processed. You can analyze input with one or more routines within the program, or with a separate program designed to filter the input before passing it to the main program. The complexity of the input interface depends on the complexity of the input; complicated input can require significant code to parse it (break it into pieces that are meaningful to the program).

This chapter describes the following two tools that help develop input interfaces:

- The `lex` tool uses a set of rules to generate a program, called a **lexical analyzer**, which analyzes input and breaks it into categories, such as numbers, letters, or operators.
- The `yacc` tool uses a set of rules to generate a program, called a **parser**, which analyzes input using the categories identified by the lexical analyzer and determines what to do with the input. The `yacc` tool generates left-associative, left-recursive (LALR) parsers. For further information about LALR grammars, refer to a compiler book such as *Compilers: Principles, Techniques, and Tools*, by Alfred Aho, Ravi Sethi, and Jeffrey Ullman.¹

To avoid confusion between the `lex` and `yacc` programs and the programs they generate, `lex` and `yacc` are referred to throughout this chapter as tools.

The following sections explain the two tools:

- How the lexical analyzer works
- Writing a lexical analyzer program with `lex`
- The `lex` specification file
- Generating a lexical analyzer
- Using `lex` with `yacc`
- Creating a parser with `yacc`

¹ Alfred Aho, Ravi Sethi, and Jeffrey Ullman. *Compilers: Principles, Techniques, and Tools*, Reading, MA, U.S.A.: Addison-Wesley Publishing Co., 1986.

- The grammar file
- Parser operation
- Turning on debug mode
- Creating a simple calculator program

4.1 How the Lexical Analyzer Works

The lexical analyzer that `lex` generates is a **deterministic finite-state automaton**. This design provides for a limited number of states that the lexical analyzer can exist in, along with the rules that determine what state the lexical analyzer moves to upon reading and interpreting the next input character.

The compiled lexical analyzer performs the following functions:

- Reads an input stream of characters.
- Copies the input stream to an output stream.
- Breaks the input stream into smaller strings that match the regular expressions in the `lex` specification file.
- Executes an action for each regular expression that it recognizes. Actions are C language program fragments in the `lex` specification file. An action fragment does not have to be complete within itself; it can call subroutines or other actions.

Figure 4–1 illustrates a simple lexical analyzer that has three states: `start`, `good`, and `bad`. The program reads an input stream of characters. It begins in the `start` condition. When it receives the first character, the program compares the character with the rule. If the character is alphabetic (according to the rule), the program changes to the `good` state; if it is not alphabetic, the program changes to the `bad` state. The program stays in the `good` state until it finds a character that does not match its conditions, and then it moves to the `bad` state, which terminates the program.

Figure 4–1: Simple Finite State Model

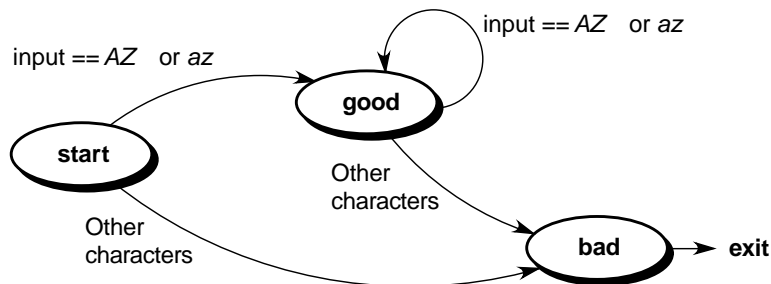

ZK0454UR

The automaton allows the generated lexical analyzer to look ahead more than one or two characters in an input stream. For example, suppose the `lex` specification file defines a rule that looks for the string, `ab`, and another rule that looks for the string, `abcdefg`. If the lexical analyzer gets an input string of `abcdefh`, it reads enough characters to attempt a match on `abcdefg`. When the `h` disqualifies a match on `abcdefg`, the analyzer returns to the rule that looks for `ab`. The first two characters of the input match `ab`, so the analyzer performs any action specified in that rule and then begins trying to find another match using the remaining input, `cdefh`.

4.2 Writing a Lexical Analyzer Program with `lex`

The `lex` tool helps write a C language lexical analyzer program that can receive character stream input and translate that input into program actions. To use `lex`, you must write a specification file that contains the following parts:

- Regular expressions – Character patterns that the generated lexical analyzer will recognize
- Action statements – C language program fragments that define how the generated lexical analyzer is to react to regular expressions that it recognizes

The actual format and logic allowed in the specification file are discussed in Section 4.3.

The `lex` tool uses the information in the specification file to generate the lexical analyzer. The tool names the created analyzer program `yy.lex.c`. The `yy.lex.c` program contains a set of standard functions together with the analysis code that is generated from the specification file. The analysis code is contained in the `yylex` function. Lexical analyzers created by `lex` recognize simple grammar structures and regular expressions. You can compile a simple `lex` analyzer program with the following command:

```
% cc -ll yy.lex.c
```

The `-ll` option tells the compiler to use the `lex` function library. This command yields an executable lexical analyzer. If your program uses complex grammar rules, or if it uses no grammar rules, you should create a parser (by combining the `lex` and `yacc` tools) to ensure proper handling of the input. (See Section 4.6.)

The `yy.lex.c` output file can be moved to any other system having a C compiler that supports the `lex` library functions.

4.3 The `lex` Specification File

The format of the `lex` specification file is as follows:

```
[ { definitions } ]  
%%  
[ { rules } ]  
[ %%  
{ user subroutines } ]
```

Except for the first pair of percent signs (`%%`), which mark the beginning of the rules, all parts of the specification file are optional. The minimum `lex` specification file contains no definitions, no rules, and no user subroutines. Without a specified action for a pattern match, the lexical analyzer copies the input pattern to the output without changing it. Therefore, this minimum specification file produces a lexical analyzer that copies all input to the output unchanged.

This section contains the following information:

- Defining substitution strings
- Rules
- Using or overriding standard input/output routines
- End-of-file processing
- Passing code to the generated program
- Start conditions

4.3.1 Defining Substitution Strings

You can define string macros before the first pair of percent signs in the `lex` specification file. The `lex` tool expands these macros when it generates the lexical analyzer. Any line in this section that begins in column 1 and that does not lie between `%{` and `%}` delimiters defines a `lex` substitution string. Substitution string definitions have the following general format:

```
name translation
```

The *name* and *translation* elements are separated by at least one blank or tab, and *name* begins with a letter. When `lex` finds the string *name* enclosed in braces (`{ }`) in the rules part of the specification file, it changes *name* to the string defined in *translation* and deletes the braces.

For example, to define the names `D` and `E`, place the following definitions before the first `%%` delimiter in the specification file:

```
D          [0-9]
E          [DEde] [-+]{D}+
```

These definitions can be used in the rules section to make identification of integers and real numbers more compact:

```
{D}+          printf("integer");
{D}+"."{D}*({E})?|
{D}*"."{D}+({E})?|
{D}+{E}       printf("real");
```

You can also include the following items in the definitions section:

- Character set table (described in Section 4.3.3)
- List of start conditions (described in Section 4.3.6)
- Changes to size of arrays to accommodate larger source programs

4.3.2 Rules

The rules section of the specification file contains control decisions that define the lexical analyzer that `lex` generates. The rules are in the form of a two-column table. The left column of the table contains regular expressions; the right column of the table contains actions, one for each expression. Actions are C language program fragments that can be as simple as a semicolon (the null statement) or as complex as needed. The lexical analyzer that `lex` creates contains both the expressions and the actions; when it finds a match for one of the expressions, it executes the corresponding action.

For example, to create a lexical analyzer to look for the string `integer`, and print a message when the string is found, define the following rule:

```
integer      printf ("found keyword integer");
```

This example uses the C language library function `printf` to print a message string. The first blank or tab character in the rule indicates the end of the regular expression. When you use only one statement in an action, put the statement on the same line and to the right of the expression (`integer` in this example). When you use more than one statement, or if the statement takes more than one line, enclose the action in braces, as in a C language program. For example:

```
integer      {
              printf ("found keyword integer");
            }
```

```
    hits++;  
}
```

A lexical analyzer that changes some words in a file from British spellings to the American spellings would have a specification file that contains rules such as the following:

```
colour      printf("color");  
mechanise   printf("mechanize");  
petrol      printf("gas");
```

This specification file is not complete, however, because it changes the word petroleum to gaseum.

4.3.2.1 Regular Expressions

With a few specialized additions, `lex` recognizes the standard set of extended regular expressions described in Chapter 1. Table 4–1 lists the expression operators that are special to `lex`.

Table 4–1: Regular Expression Operators for `lex`

Operator	Name	Description
<code>{name}</code>	Braces	When braces enclose a name, the name represents a string defined earlier in the specification file. For example, <code>{digit}</code> looks for a defined string named <code>digit</code> and inserts that string at the point in the expression where <code>{digit}</code> occurs. Do not confuse this construct with an interval expression; both are recognized by <code>lex</code> .
<code>"</code>	Quotation marks	Encloses literal strings to interpret as text characters. For example, <code>"\$"</code> prevents <code>lex</code> from interpreting the dollar sign as an operator. You can use quotation marks for only part of a string; for example, both <code>"abc++"</code> and <code>abc"++"</code> match the literal string <code>"abc++"</code> .
<code>a/<b</code>	Slash	Enables a match on the first expression (a) only if the second expression (b) follows it immediately. For example, <code>dog/cat</code> matches <code>dog</code> if, and only if, <code>cat</code> immediately follows <code>dog</code> .

Table 4–1: Regular Expression Operators for lex (cont.)

Operator	Name	Description
<x>	Angle brackets	Encloses a start condition. Executes the associated action only if the lexical analyzer is in the indicated start condition <x>. If the condition of being at the beginning of a line is start condition ONE, then the circumflex (^) operator would be the same as the expression <ONE>.
\n	Newline character	Do not use the actual newline character in an expression. Do not confuse the \n construct with the \n back-reference operator used in basic regular expressions.
\t	Tab	Matches a literal tab character (09 hexadecimal)
\b	Backspace	Matches a literal backspace (08 hexadecimal)
\\	Backslash	Matches a literal backslash.
\digits	Digits	The character whose encoding is represented by the three digit octal number.
\xdigits	xDigits	The character whose encoding is represented by the hexadecimal integer.

Usually, white space (blanks or tabs) delimits the end of an expression and the start of its associated action. However, you can enclose blanks or tab characters in quotation marks (" ") to include them in an expression. Use quotation marks around all blanks in expressions that are not already within sets of brackets ([]).

4.3.2.2 Matching Rules

When more than one expression in the rules section of a specification file can match the current input, the lexical analyzer chooses which rule to apply using the following criteria:

1. The longest matching string of characters
2. Among rules that match the same number of characters, the rule that occurs first

For example, consider the following rules:

```
integer      printf("found int keyword");
[a-z]+      printf("found identifier");
```

If the rules are given in this order and `integer` is the input word, the analyzer calls the input an identifier because `[a-z]+` matches all eight characters of the word while `integer` matches only seven. However, if the

input is integer, both rules match. In this case, `lex` selects the keyword rule because it occurs first. A shorter input, such as `int`, does not match the expression `integer`, so `lex` selects the identifier rule.

4.3.2.2.1 Using Wildcard Characters to Match a String

Because the lexical analyzer chooses the longest match first, you must be careful not to use an expression that is too powerful for your intended purpose. For example, a period followed by an asterisk and enclosed in apostrophes (`' .* '`) might seem like a good way to recognize any string enclosed in apostrophes. However, the analyzer reads far ahead, looking for a distant apostrophe to complete the longest possible match. Consider the following text:

```
'first' quoted string here, 'second' here
```

Given this input, the analyzer will match on the following string:

```
'first' quoted string here, 'second'
```

Because the period operator does not match a newline character, errors of this type are usually not far reaching. Expressions like `.*` stop on the current line. Do not try to defeat this action with expressions like the following:

```
[.\n]+
```

Given this expression, the lexical analyzer tries to read the entire input file, and an internal buffer overflow occurs.

The following rule finds the smaller quoted strings `'first'` and `'second'` from the preceding text example:

```
' [^\n]* ''
```

This rule stops after matching `'first'` because it looks for an apostrophe followed by any number of characters except another apostrophe or a newline character, then followed by a second apostrophe. The analyzer then begins again to search for an appropriate expression, and it will find `'second'` as it should. This expression also matches an empty quoted string (`' '`).

4.3.2.2.2 Finding Strings Within Strings

Usually, the lexical analyzer program partitions the input stream. It does not search for all possible matches of each expression. Each character is accounted for exactly once. For example, to count occurrences of both `'she'` and `'he'` in an input text, consider the following rules:

```
she      s++;  
he       h++;  
\n       ;  
.
```

The last two rules ignore everything other than the two strings of interest. However, because 'she' includes 'he', the analyzer does not recognize the instances of 'he' that are included within 'she'.

A special action, `REJECT`, is provided to override this behavior. This directive tells the analyzer to execute the rule that contains it and then, before executing the next rule, restore the position of the input pointer to where it was before the first rule was executed. For example, to count the instances of 'he' that are included within 'she', use the following rules:

```
she      {s++; REJECT; }
he       {h++; REJECT; }
\n       ;
.
```

After counting an occurrence of 'she', the analyzer rejects the input stream and then counts the included occurrence of 'he'. In this example, 'she' includes 'he' but the reverse is not true, and you can omit the `REJECT` action on 'he'. In other cases, such as when a wildcard regular expression is being matched, determining which input characters are in both classes can be difficult.

In general, `REJECT` is useful whenever the purpose is not to partition the input stream but rather to detect all examples of some items in the input where the instances of these items can overlap or include each other.

4.3.2.3 Actions

When the lexical analyzer matches one of the expressions in the rules section of the specification file, it executes the action that corresponds to the expression. Without rules to match all strings in the input stream, the lexical analyzer copies the input to standard output. Therefore, do not create a rule that only copies the input to the output. Use this default output to find conditions not covered by the rules.

When you use a `lex`-generated analyzer to process input for a parser that `yacc` produces, provide rules to match all input strings. Those rules must generate output that `yacc` can interpret. For information on using `lex` with `yacc`, see Section 4.5.

4.3.2.3.1 Null Action

To ignore the input associated with an expression, use a semicolon (`;`), the C language null statement, as an action. For example:

```
[ \t\n]      ;
```

This rule ignores the three spacing characters (blank, tab, and newline character).

4.3.2.3.2 Using the Same Action for Multiple Expressions

To use the same action for several different expressions, create a series of rules (one for each expression except the last) whose actions consist of only a vertical bar character (`|`). For the last expression, specify the action as you would usually specify it. The vertical bar character indicates that the action for the rule containing it is the same as the action for the next rule. For example, to ignore blank, tab, and newline characters (shown in Section 4.3.2.3.1), you could use the following set of rules:

```
" "      |
"\t"     |
"\n"     ;
```

The quotation marks around the special character sequences (`\n` and `\t`) in this example are not mandatory.

4.3.2.3.3 Printing a Matched String

To find out what text matched an expression in the rules section of the specification file, include a C language `printf` function as one of the actions for that expression. When the lexical analyzer finds a match in the input stream, the program puts that matched string in an external character array, called `yytext`. To print the matched string, use a rule like the following:

```
[a-z]+      printf("%s", yytext);
```

Printing the output in this way is common. You can define an expression like this `printf` statement as a macro in the definitions section of the specification file. If this action is defined as `ECHO`, then the rules section entry looks like the following:

```
[a-z]+      ECHO;
```

See Section 4.3.1 for information on defining macros.

4.3.2.3.4 Finding the Length of a Matched String

To find the number of characters that the lexical analyzer matched for a particular expression, use the external variable `yylen`. For example, the following rule counts both the number of words and the number of characters in words in the input:

```
[a-zA-Z]+   {words++; chars += yylen;}
```

This action totals the number of characters in the words matched and assigns that value to the `chars` variable.

The following expression finds the last character in the string matched:

```
yytext[yylen-1]
```

4.3.2.3.5 Getting More Input

The lexical analyzer can run out of input before it completely matches an expression in a rules file. In this case, include a call to the `lex` function `yymore` in the action for that rule. Usually, the next string from the input stream overwrites the current entry in `yytext`. The `yymore` action appends the next string from the input stream to the end of the current entry in `yytext`. For example, consider a language that includes the following syntax:

- A string is any set of characters between quotation marks (" ").
- A backslash (\) escapes the next character to make that character part of the string. For example, the combination of a backslash and a quotation mark (\) indicates that the quotation mark is part of the string instead of being the closing delimiter for the string.

The following rule processes these lexical characteristics:

```
\"[^"]*" {
    if (yytext[yytextlen-1] == '\\')
        yymore();
    else
        ... normal user processing
}
```

When this lexical analyzer receives a string such as "abc\def" (with the quotation marks exactly as shown), it first matches the first five characters, "abc\". The backslash causes a call to `yymore` to add the next part of the string, "def", to the end. The part of the action code labeled "normal user processing" must process the quotation mark that ends the string.

4.3.2.3.6 Returning Characters to the Input

In some cases the lexical analyzer does not need all of the characters that are matched by the currently successful regular expression; or it might need to return matched characters to the input stream to be checked again for another match.

To return characters to the input stream, use the `yylex(n)` call, where `n` is the number of characters of the current string that you want to keep. Characters beyond the `n`th character in the stream are returned to the input stream. This function provides the same type of look-ahead that the slash operator (/) uses, but `yylex` allows more control over the look-ahead. Using `yylex(0)` is equivalent to using `REJECT`.

Use the `yylex` function to process text more than once. For example, a C language expression such as `x=-a` is ambiguous. It could mean `x = -a`, or it could be an obsolete representation of `x -= a`, which is evaluated as `x = x - a`. To treat this ambiguous expression as `x = -a` and print a warning message, use a rule such as the following:

```

--[a-zA-Z]      {
    printf("Operator (==) ambiguous\n");
    yyless(yylen-1);
    ... action for ==...
}

```

4.3.3 Using or Overriding Standard Input/Output Routines

The `lex` program provides a set of input/output (I/O) routines for the lexical analyzer to use. Include calls to the following routines in the C code fragments in your specification file:

- `input` – Returns the next input character
- `output(c)` – Writes the character `c` on the output
- `unput(c)` – Pushes the character `c` back onto the input stream to be read later by `input`

These routines are provided as macro definitions. You can override them by writing your own code for routines of the same names in the user subroutines section. These routines define the relationship between external files and internal characters. If you change them, change them all in the same way. They should follow these rules:

- All routines must use the same character set.
- The input routine must return a value of 0 to indicate end-of-file.

If you write your own code, you must undefine these macros in the definitions section of the specification file before the code for your own definitions:

```

%{
#undef   input
#undef   unput
#undef   output
}%

```

Note

Changing the relationship of `unput` to `input` causes the look-ahead functions not to work.

When you are using a `lex`-generated lexical analyzer as a simple transformer/recognizer for piping from standard input to standard output, you can avoid writing the framework by using the `lex` library (`libl.a`). This library contains the `main` routine, which calls the `yylex` function for you. The standard `lex` library lets the lexical analyzer back up a maximum of 100 characters.

If you need to be able to read an input file containing the NUL character (00 hexadecimal), you must create a different version of the `input` routine. The standard version of `input` returns a value of 0 when reading a null, and the analyzer interprets this value as indicating the end of the file.

The lexical analyzers that `lex` generates process character I/O through the `input`, `output`, and `unput` routines. Therefore, to return values in `yytext`, the analyzer uses the character representation that these routines use. Internally, however, each character is represented with a small integer. With the standard library, this integer is the value of the bit pattern that the computer uses to represent the character.

Usually, the letter `,a`, is represented in the same form as the character constant `a`. If you change this interpretation with different I/O routines, you must include a translation table in the definitions section of the specification file. The translation table begins and ends with lines that contain only the `%T` keyword, and it contains lines of the following form:

```
[[ integer } { character string }]
```

The following example shows table entries that associate the letter `,A`, and the digit `,0`, (zero) with their standard values:

```
%T
{65} {A}
{48} {0}
%T
```

4.3.4 End-of-File Processing

When the lexical analyzer reaches the end of a file, it calls a library routine named `yywrap`. This routine returns a value of 1 to indicate to the lexical analyzer that it should continue with normal wrap-up (operations associated with the end of processing). However, if the analyzer receives input from more than one source, you must change the `yywrap` function. The new function must get the new input and return a value of 0 to the lexical analyzer. A return value of 0 indicates that the program should continue processing.

Multiple files specified on the command line are treated as a single input file for the purpose of end-of-file handling.

You can also include code to print summary reports and tables in a special version of `yywrap`. The `yywrap` function is the only way to force `yylex` to recognize the end of the input.

4.3.5 Passing Code to the Generated Program

You can define variables in either the definitions section or the rules section of the specification file. When you process a specification file, `lex` changes statements in the file into a lexical analyzer. Any line in the specification file that `lex` cannot interpret is passed unchanged to the lexical analyzer. The following four types of entries can be passed to the lexical analyzer in this manner:

- Lines beginning with a blank or tab that are not a part of a `lex` rule are copied into the lexical analyzer. If this entry occurs before the first pair of percent signs (`%%`) in the specification file, the entry is external to any function in the code. If the entry occurs after the first `%%`, it must be a C language program fragment that defines a variable. You must define these statements before the first `lex` rule in the specification file.
- Lines beginning with a blank or tab that are program comments are included as comments in the generated lexical analyzer. The comments must be in the C language format for comments.
- Any lines that lie between lines containing only `%{` and `%}` are copied to the lexical analyzer. The symbols `%{` and `%}` are not copied. Use this format to enter preprocessor statements that must begin in column 1, or to copy lines that do not look like program statements.
- Any lines occurring after the third `%%` delimiter are copied to the lexical analyzer without format restrictions.

4.3.6 Start Conditions

Any rule can be associated with a start condition; the lexical analyzer recognizes that rule only when the analyzer is in that start condition. You can change the current start condition at any time.

You define start conditions in the definitions section of the specification file by using a line with the following format:

```
% Start [ name1] [[ name2 ...]]
```

The *name1* and *name2* symbols represent conditions. There is no limit to the number of conditions, and they can appear in any order. You can abbreviate `Start` to either `S` or `s`. Start-condition names cannot be reserved words in C, nor can they be declared as the names of variables, fields, and so on.

When using a start condition in the rules section of the specification file, enclose the name of the start condition in angle brackets (`< >`) at the beginning of the rule. The following format defines a rule with a start condition:

```
[< name1] [[, name2 ...]] [> expression]
```

The lexical analyzer recognizes *expression* only when the analyzer is in the condition corresponding to one of the names. To put `lex` in a particular start condition, execute the following action statement (in the action part of a rule):

```
BEGIN name;
```

This statement changes the start condition to *name*. To resume the normal state, use the following action:

```
BEGIN 0;
```

As shown in the preceding syntax diagram, a rule can be active in several start conditions. For example:

```
<start1,start2,start3> [0-9]+ printf("integer");
```

This rule prints `integer` only if it finds an integer while in one of the three named start conditions. Any rule that does not begin with a start condition is always active.

4.4 Generating a Lexical Analyzer

Generating a `lex`-based lexical analyzer program is a two-step process, as follows:

1. Run `lex` to change the specification file into a C language program. The resulting program is in a file named `lex.yy.c`.
2. Process `lex.yy.c` with the `cc -ll` command to compile the program and link it with a library of `lex` subroutines. The resulting executable program is named `a.out`.

For example, if the `lex` specification file is called `lextest`, enter the following commands:

```
% lex lextest
% cc lex.yy.c -ll
```

Although the default `lex` I/O routines use the C language standard library, the lexical analyzers that `lex` generates do not require them. You can include different copies of the `input`, `output`, and `unput` routines to avoid using those in the library. (See Section 4.3.3.)

Table 4-2 describes the options for the `lex` command.

Table 4–2: Options for the `lex` Command

Option	Description
<code>-n</code>	Suppresses the statistics summary that is produced by default when you set your own table sizes for the finite state machine. See the <code>lex(1)</code> reference page for information about specifying the state machine.
<code>-t</code>	Writes the generated lexical analyzer code to standard output instead of to the <code>lex.yy.c</code> file.
<code>-v</code>	Provides a one-line summary of the general finite state machine statistics.

Because `lex` uses fixed names for intermediate and output files, you can have only one `lex`-generated program in a given directory unless you use the `-t` option to specify an alternative file name.

4.5 Using `lex` with `yacc`

When used alone, the `lex` tool creates a lexical analyzer that recognizes simple one-word input or receives statistical input. You can also use `lex` with a parser generator, such as `yacc`. The `yacc` tool generates a program, called a parser, that analyzes the construction of multiple-word input. This parser program operates well with lexical analyzers that `lex` generates; these lexical analyzers recognize only regular expressions and format them into character packages called **tokens**.

A token is the smallest independent unit of meaning as defined by either the parser or the lexical analyzer. A token can contain data, a language keyword, an identifier, or other parts of a language syntax. A token can be any string of characters; it can be part or all of a word or series of words. The `yacc` tool produces parsers that recognize many types of grammar with no regard to context. These parsers need a preprocessor, such as a `lex`-generated lexical analyzer, to recognize input tokens.

When a `lex`-generated lexical analyzer is used as the preprocessor for a `yacc`-generated parser, the lexical analyzer partitions the input stream. The parser assigns structure to the resulting pieces. Figure 4–2 shows how `lex` and `yacc` generate programs and how the programs work together. You can also use other programs along with those generated by `lex` or `yacc`.

Figure 4–2: Producing an Input Parser with lex and yacc

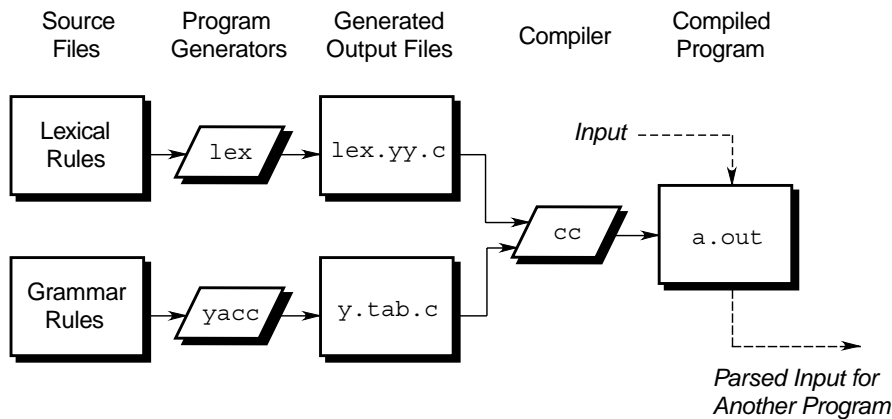

ZK0455UR

The parser program requires that its preprocessor (the lexical analysis function) be named `yylex`. This is the name `lex` gives to the analysis code in a lexical analyzer it generates. If a lexical analyzer is used by itself, the default `main` program in the `lex` library calls the `yylex` routine, but if a `yacc`-generated parser is loaded and its `main` program is used, the parser calls `yylex`. In this case, each `lex` rule should end with the following line, where the appropriate token value is returned:

```
return(token);
```

To find the names for tokens that `yacc` uses, compile the lexical analyzer (the `lex` output file) as part of the parser (the `yacc` output file) by placing the following line in the last section of the `yacc` grammar file:

```
#include lex.yy.c
```

Alternatively, you can include the `yacc` output (the `y.tab.h` file) into your `lex` program specification file, and use the token names that `y.tab.h` defines. For example, if the grammar file is named `good` and the specification file is named `better`, the following command sequence creates the final program:

```
% yacc good
% lex better
% cc y.tab.c -ly -ll
```

To get a `main` program that invokes the `yacc` parser, load the `yacc` library (`-ly` in the preceding example) before the `lex` library. You can generate `lex` and `yacc` programs in either order.

4.6 Creating a Parser with yacc

To generate a parser with `yacc`, you must write a grammar file that describes the input data stream and what the parser is to do with the data. The grammar file includes rules describing the input structure, code to be invoked when these rules are recognized, and a routine to do the basic input.

The `yacc` tool uses the information in the grammar file to generate `yyparse`, a program that controls the input process. This is the parser that calls the `yylex` input routine (the lexical analyzer) to pick up tokens from the input stream. The parser organizes these tokens according to the structure rules in the grammar file. The structure rules are called grammar rules. When the parser recognizes a grammar rule, it executes the user code (action) supplied for that rule. Actions return values and use the values returned by other actions.

In addition to the specifications that `yacc` recognizes and uses, the grammar file can also contain the following functions:

- `main` – A C language function that contains, as a minimum, a call to the `yyparse` function, which `yacc` generates. A limited form of this function is in the `yacc` library.
- `yyerror` – A C language function to handle errors that can occur during parser operation. A limited form of this function is in the `yacc` library.
- `yylex` – A C language function to perform lexical analysis on the input stream and pass tokens (with values, if required) to the parser. The function must return an integer that represents the kind of token that was read. The integer is called the token number. In addition, if a value is associated with the token, the lexical analyzer must assign that value to the external variable `yyval`. See Section 4.7.1.3 for more information on token numbers. To build a lexical analyzer that works well with the parser that `yacc` generates, use the `lex` tool (see Section 4.3).

The `yacc` tool processes a grammar file to generate a file of C language functions and data, named `y.tab.c`. When compiled using the `cc` command, these functions form a combined function named `yyparse`. This `yyparse` function calls `yylex`, the lexical analyzer, to get input tokens.

The analyzer continues providing input until the parser detects an error or the analyzer returns an `endmarker` token to indicate the end of the operation. If an error occurs and `yyparse` cannot recover, `yyparse` returns a value of 1 to the `main` function. If it finds the `endmarker` token, `yyparse` returns a value of 0 to `main`.

Use the C programming language to write the action code and other subroutines. The `yacc` program uses many of the C language syntax conventions for the grammar file.

4.6.1 The main and yyerror Functions

You must provide function routines named `main` and `yyerror` in the grammar file. To ease the initial effort of using `yacc`, the `yacc` library provides simple versions of the `main` and `yyerror` routines. You can include these routines by using the `-ly` option to the loader or the `cc` command. The source code for the `main` library function is as follows:

```
main()
{
    yyparse();
}
```

The source code for the `yyerror` library function follows:

```
#include <stdio.h>

void yyerror(s)
    char *s;
{
    fprintf( stderr, " %s\n" ,s);
}
```

The argument to `yyerror` is a string containing an error message, usually the string syntax error.

These are very limited programs. You should provide more sophistication in these routines, such as keeping track of the input line number and printing it along with the message when a syntax error is detected. You can use the value of the external integer variable `yychar`. This variable contains the look-ahead token number at the time the error was detected.

4.6.2 The yylex Function

The `yylex` program input routine that you supply must be able to do the following:

- Read the input stream
- Recognize basic patterns in the input stream
- Pass the patterns to `yyparse` along with tokens that identify them

A token is a symbol or name that tells `yyparse` which pattern is being sent to it by the input routine. A symbol can be in one of the following two classes:

- Terminal symbols – Values returned by `yylex` to represent the primitive building blocks of the grammar, as bricks are the primitive elements of a wall.

- Nonterminal symbols – The composite symbols that are used by the `yacc` grammar to describe more complex orderings or aggregations of the terminal symbols, as a wall is an assembly of bricks.

For example, if the lexical analyzer recognizes any numbers, names, and operators, these elements are taken to be terminal symbols. Nonterminal symbols that the `yacc` grammar recognizes are elements like `EXPR`, `TERM`, and `FACTOR`. Suppose the input routine separates an input stream into the tokens of `WORD`, `NUMBER`, and `PUNCTUATION`. Consider the input sentence “I have 9 turkeys.” The analyzer could pass the following strings and tokens to the parser:

String	Token
I	WORD
have	WORD
9	NUMBER
turkeys	WORD
.	PUNCTUATION

The `yyparse` function must contain definitions for the tokens that the input routine passes to it. The `yacc` command’s `-d` option causes the program to generate a list of tokens in a file named `y.tab.h`. This list is a set of `#define` statements that let `yylex` use the same tokens as the parser.

To avoid conflict with the parser, do not use names that begin with the letters `yy`. You can use `lex` to generate the input routine, or you can write it in the C language. See Section 4.3 for information about using `lex`.

4.7 The Grammar File

A `yacc` grammar file consists of the following three sections:

- Declarations
- Rules
- Programs

Two percent signs (`%%`) that appear together separate the sections of the grammar file. To make the file easier to read, put the percent signs on a line by themselves. A grammar file has the following format:

```
[ declarations ]
%%
rules
[ %%
programs ]
```

Except for the first pair of percent signs (%%), which mark the beginning of the rules, and the rules themselves, all parts of the grammar file are optional. The minimum `yacc` grammar file contains no definitions and no programs, as follows:

```
%%  
rules
```

Except within names or reserved symbols, the `yacc` program ignores blanks, tabs, and newline characters in the grammar file. You can use these characters to make the grammar file easier to read. Do not use blanks, tabs, or newline characters in names or reserved symbols.

4.7.1 Declarations

The declarations section of the `yacc` grammar file contains the following elements:

- Declarations for any variables or constants used in other parts of the grammar file
- The `#include` statements to call in other files as part of this file (used for library header files)
- Statements that define processing conditions for the generated parser

Declarations for variables or constants conform to the syntax of the C programming language, as follows:

```
type-specifier declarator;
```

In this syntax, *type-specifier* is a data type keyword and *declarator* is the name of the variable or constant. Names can be any length and can consist of letters, dots, underscores, and digits. A name cannot begin with a digit. Uppercase and lowercase letters are distinct. The names used in the body of a grammar rule can represent tokens or nonterminal symbols.

If you do not declare a name in the declarations section, you can use that name only as a nonterminal symbol. Define each nonterminal symbol by using it as the left side of at least one rule in the rules section. The `#include` statements are identical to C language syntax and perform the same function.

The `yacc` tool has a set of keywords, listed in Table 4–3, that define processing conditions for the generated parser. Each of the keywords begins with a percent sign (%) and is followed by a list of tokens.

Table 4–3: Processing-Condition Definition Keywords in yacc

Keyword	description
<code>%left</code>	Identifies tokens that are left-associative with other tokens.
<code>%nonassoc</code>	Identifies tokens that are not associative with other tokens.
<code>%right</code>	Identifies tokens that are right-associative with other tokens.
<code>%start</code>	Identifies a name for the start symbol.
<code>%token</code>	Identifies the token names that <code>yacc</code> accepts. Declare all token names in the declarations section.

All tokens listed on the same line have the same precedence level and association; lines appear in the file in order of increasing precedence or binding strength. For example:

```
%left      '+'  '-'
%left      '*'  '/'
```

This example describes the precedence and associativity of the four arithmetic operators. The addition (+) and subtraction (–) operators are left-associative and have lower precedence than the multiplication (*) and division (/) operators, which are also left-associative.

4.7.1.1 Defining Global Variables

You can define global variables to be used by some or all parser actions, as well as by the lexical analyzer, by enclosing the declarations for those variables in matched pairs of symbols consisting of a percent sign and a brace (`%{` and `%}`). For example, to make the `var` variable available to all parts of the complete program, place the following entry in the declarations section of the grammar file:

```
%{ int var = 0; %}
```

4.7.1.2 Start Symbols

The parser recognizes a special symbol called the start symbol. The start symbol is the name assigned to the grammar rule that describes the most general structure of the language to be parsed. Because it is the most general structure, it is the structure where the parser starts in its top-down analysis of the input stream. You declare the start symbol in the declarations section by using the `%start` keyword. If you do not declare a start symbol, the parser uses the name of the first grammar rule in the file.

For example, in parsing a C language procedure, the following is the most general structure for the parser to recognize:

```
main()
{
```

```
    code_segment
}
```

The start symbol should point to the rule that describes this structure. All remaining rules in the file describe ways to identify lower-level structures within the procedure.

4.7.1.3 Token Numbers

Token numbers are nonnegative integers that represent the names of tokens. Because the lexical analyzer passes the token number to the parser instead of the actual token name, the programs must assign the same numbers to the tokens.

You can assign numbers to the tokens used in the `yacc` grammar file. If you do not assign numbers to the tokens, `yacc` assigns numbers using the following rules:

- A literal character is assigned the numeric value of the character in the ASCII character set.
- Other names are assigned token numbers starting at 257.

Note

Do not assign a token number of 0 (zero). This number is assigned to the `endmarker` token. You cannot redefine it.

To assign a number to a token (including literals) in the declarations section of the grammar file, put a nonzero positive integer immediately after the token name in the `%token` line. This integer is the token number of the name or literal. Each number must be unique. Any lexical analyzer used with `yacc` must return either 0 (zero) or a negative value for a token when the end of the input is reached.

4.7.2 Grammar Rules

The rules section of the `yacc` grammar file contains one or more grammar rules. Each rule describes a structure and gives it a name. A grammar rule has the following format:

```
[ nonterminal-name : BODY ;]
```

In this syntax, *BODY* is a sequence of zero or more names and literals. The colon and the semicolon are required `yacc` punctuation.

If there are several grammar rules with the same nonterminal name, use the vertical bar (|) to avoid rewriting the left side. In addition, use the

semicolon (;) only at the end of all rules joined by vertical bars. The two following sets of grammar rules are equivalent:

Set 1

```
A : B C D ;  
A : E F ;  
A : G ;
```

Set 2

```
A : B C D  
  | E F  
  | G  
  ;
```

4.7.2.1 Null String

To indicate a nonterminal symbol that matches the null string, use a semicolon by itself in the body of the rule, as follows:

```
nullstr : ;
```

4.7.2.2 End-of-Input Marker

When the lexical analyzer reaches the end of the input stream, it sends a special token, called `endmarker`, to the parser. This token signals the end of the input and has a token value of 0. When the parser receives an `endmarker` token, it checks to see that it has assigned all of the input to defined grammar rules and that the processed input forms a complete unit (as defined in the `yacc` grammar file). If the input is a complete unit, the parser stops. If the input is not a complete unit, the parser signals an error and stops.

The lexical analyzer must send the `endmarker` token at the correct time, such as the end of a file, or the end of a record.

4.7.2.3 Actions in yacc Parsers

With each grammar rule, you can specify actions to be performed each time the parser recognizes the rule in the input stream. Actions return values and obtain the values returned by previous actions. The lexical analyzer can also return values for tokens.

An action is a C language statement that does input and output, calls subprograms, and alters external vectors and variables. You specify an action in the grammar file with one or more statements enclosed in braces (`{ }`). For example, the following are grammar rules with actions:

```
A : '( 'B' )'
  {
    hello(1, "abc" );
  };
XXX : YYZ ZZZ
    {
    printf("a message\n");
    flag = 25;
    }
```

An action can receive values generated by other actions by using numbered `yacc` parameter keywords (`$1`, `$2`, and so on). These keywords refer to the values returned by the components of the right side of a rule, reading from left to right. For example:

```
A : B C D ;
```

When this code is executed, \$1 has the value returned by the rule that recognized B, \$2 the value returned by the rule that recognized C, and \$3 the value returned by the rule that recognized D.

To return a value, the action sets the pseudovariable \$\$ to some value. For example, the following action returns a value of 1:

```
{ $$ = 1; }
```

By default, the value of a rule is the value of the first element in it (\$1). Therefore, you do not need to provide actions for rules that have the following form:

```
A : B ;
```

To get control of the parsing process before a rule is completed, write an action in the middle of a rule. If this rule returns a value through the \$n parameters, actions that come after it can use that value. The action can use values returned by actions that come before it. Therefore, the following rule sets x to 1 and y to the value returned by C:

```
A : B
    {
        $$ = 1;
    }
    C
    {
        x = $2;
        y = $3;
    }
    ;
```

Internally, yacc creates a new nonterminal symbol name for the action that occurs in the middle, and it creates a new rule matching this name to the null string. Therefore, yacc treats the preceding program as if it were written in the following form, where \$ACT is an empty action:

```
$ACT : /* null string */
    {
        $$ = 1;
    }
    ;
A : B $ACT C
    {
        x = $2;
        y = $3;
    }
    ;
```

4.7.3 Programs

The programs section of the `yacc` grammar file contains C language functions that can be used by the actions in the rules section. In addition, if you write a lexical analyzer (`yyllex`, the input routine to the parser), include it in the programs section.

4.7.4 Guidelines for Using Grammar Files

The following sections describe some general guidelines for using `yacc` grammar files. They provide information on the following:

- Using comments
- Using literal strings
- Formatting grammar files
- Using recursion
- Correcting errors

4.7.4.1 Using Comments

Comments in the grammar file explain what the program is doing. You can put comments anywhere in the grammar file that you can put a name. However, to make the file easier to read, put the comments on lines by themselves at the beginning of functional blocks of rules. Comments in a `yacc` grammar file have exactly the same form as comments in a C language program; that is, they begin with a slash and an asterisk (`/*`) and end with an asterisk and a slash (`*/`). For example:

```
/* This is a comment on a line by itself. */
```

4.7.4.2 Using Literal Strings

A literal string is one or more characters enclosed in apostrophes, or single quotation marks (`' '`). As in the C language, the backslash (`\`) is an escape character within literals, and all the C language special-character sequences are recognized, as follows:

<code>\n</code>	Newline character
<code>\r</code>	Return
<code>\'</code>	Apostrophe, or single quote
<code>\\</code>	Backslash
<code>\t</code>	Tab
<code>\b</code>	Backspace

`\f` Form feed
`\nnn` The value *nnn* in octal

Never use `\0` or `0` (the null character) in grammar rules.

4.7.4.3 Guidelines for Formatting the Grammar File

The following guidelines will help make the `yacc` grammar file more readable:

- Use uppercase letters for token names and lowercase letters for nonterminal symbol names.
- Put grammar rules and actions on separate lines to allow for changing either one without changing the other.
- Put all rules with the same left side together. Enter the left side once and use vertical bars (|) to begin the rest of the rules for that left side.
- For each set of rules with the same left side, enter the semicolon (;) once on a line by itself following the last rule for that left side. You can then add new rules easily.
- Indent rule bodies by two tab stops and action bodies by three tab stops.

4.7.4.4 Using Recursion in a Grammar File

Recursion is the process of using a function to define itself. In language definitions, these rules usually take the following form:

```
rule      :      end case
          |      rule, end case
```

The simplest case of `rule` is the `end case`, but `rule` can also be made up of more than one occurrence of `end case`. The entry in the second line that uses `rule` in the definition of `rule` is the instance of recursion. Given this rule, the parser cycles through the input until the stream is reduced to the final `end case`.

The `yacc` tool supports left-recursive grammar, not right-recursive. When you use recursion in a rule, always put the call to the name of the rule as the leftmost entry in the rule (as it is in the preceding example). If the call to the name of the rule occurs later in the line, as in the following example, the parser can run out of internal stack space and crash:

```
rule      :      end case
          |      end case, rule
```

4.7.4.5 Errors in the Grammar File

The `yacc` tool cannot produce a parser for all sets of grammar specifications. If the grammar rules contradict themselves or require matching techniques different from those that `yacc` has, `yacc` will not produce a parser. In most cases, `yacc` provides messages to indicate the errors. To correct these errors, redesign the rules in the grammar file or provide a lexical analyzer to recognize the patterns that `yacc` cannot handle.

4.7.5 Error Handling by the Parser

When the parser reads an input stream, that input stream can fail to match the rules in the grammar file. If there is an error-handling routine in the grammar file, the parser can allow for entering the data again, skipping over the bad data, or for a cleanup and recovery action. When the parser finds an error, for example, it might need to reclaim parse tree storage, delete or alter symbol table entries, and set switches to avoid generating any further output.

When an error occurs, the parser stops unless you provide error-handling routines. To continue processing the input to find more errors, restart the parser at a point in the input stream where the parser can try to recognize more input. One way to restart the parser when an error occurs is to discard some of the tokens following the error, and try to restart the parser at that point in the input stream.

The `yacc` tool has a special token name, `error`, to use for error handling. Put this token in your grammar file at places where an input error might occur so that you can provide a recovery routine. If an input error occurs in a position protected by the `error` token, the parser executes the action for the `error` token rather than the normal action.

To prevent a single error from producing many error messages, the parser remains in an error state until it successfully processes three tokens following an error. If another error occurs while the parser is in the error state, the parser discards the input token and does not produce a message. You can also specify a point at which the parser should resume processing by providing an argument to the `error` action. For example:

```
stat : error ';' ;
```

This rule tells the parser that, when there is an error, it should skip over the token and all following tokens until it finds the next semicolon. All tokens after the error and before the next semicolon are discarded. When the parser finds the semicolon, it reduces this rule and performs any cleanup action associated with it.

4.7.5.1 Providing for Error Correcting

You can allow the person entering the input stream in an interactive environment to correct any input errors by reentering a line in the data stream. For example:

```
input    :    error '\n'
        {
            printf(" Reenter last line: " );
        }
input
        {
            $$ = $4;
        }
        ;
```

In the previous example the parser stays in the error state for three input tokens following the error. If an error is encountered in the first three tokens, the parser deletes the tokens and does not display a message. Use the `yyerrok;` statement for recovery. When the parser encounters the `yyerrok;` statement, it leaves the error state and begins normal processing. Following is the recovery example:

```
input    :    error    '\n'
        {
            yyerrok;
            printf( "Reenter last line: " );
        }
input
        {
            $$ = $4
        }
        ;
```

4.7.5.2 Clearing the Look-Ahead Token

The look-ahead token is the next token to be examined by the parser. When an error occurs, the look-ahead token becomes the token at which the error was detected. However, if the error recovery action includes code to find the correct place to start processing again, that code must also change the look-ahead token. To clear the look-ahead token, include the `yyclearin;` statement in the error recovery action.

4.8 Parser Operation

The `yacc` program turns the grammar file into a C language program that, when compiled and executed, parses the input according to the grammar rules.

The parser is a finite state machine with a stack. The parser can read and remember the next input token (the look-ahead token). The current state is always the state that is on the top of the stack. The states of the finite state machine are represented by small integers. Initially, the machine is in state 0 (zero), the stack contains only 0 (zero), and no look-ahead token has been read.

The machine can perform one of the following four actions:

- `shift n` The parser pushes the current state onto the stack, makes *n* the current state, and clears the look-ahead token.
- `reduce r` The *r* argument is a rule number. When the parser finds a token sequence matching rule number *r* in the input stream, the parser replaces that sequence with the rule number in the output stream.
- `accept` The parser has looked at all input, matched it to the grammar specification, and recognized the input as satisfying the highest level structure (defined by the start symbol). This action appears only when the look-ahead token is the end marker and indicates that the parser has successfully done its job.
- `error` The parser cannot continue processing the input stream and still successfully match it with any rule defined in the grammar specification. The input tokens it looked at, together with the look-ahead token, cannot be followed by anything that would result in a legal input. The parser reports an error and attempts to recover the situation and resume parsing.

The parser performs the following actions during one process step:

1. Based on its current state, the parser decides whether it needs a look-ahead token to decide the action to take. If it needs one and does not have one, it calls `yylex` to obtain the next token.
2. Using the current state and the look-ahead token if needed, the parser decides on its next action and carries it out. This can result in states being pushed onto the stack or popped off the stack and in the look-ahead token being processed or left alone.

4.8.1 The shift Action

The `shift` action is the most common action the parser takes. Whenever the parser does a `shift`, there is always a look-ahead token. Consider the following parser action rule:

```
IF shift 34
```

When the parser is in the state that contains this rule and the look-ahead token is `IF`, the parser performs the following steps:

1. Pushes the current state down on the stack

2. Makes state 34 the current state (puts it on the top of the stack)
3. Clears the look-ahead token

4.8.2 The reduce Action

The `reduce` action prevents the stack from growing too large. The parser uses reducing actions after it has matched the right side of a rule with the input stream and is ready to replace the tokens in the input stream with the left side of the rule. The parser might have to use the look-ahead token to decide if the pattern is a complete match.

Reducing actions are associated with individual grammar rules. Because grammar rules also have small integer numbers, you can easily confuse the meanings of the numbers in the `shift` and `reduce` actions. For example, the first of the two following actions refers to grammar rule 18; the second refers to machine state 34:

```
reduce 18
IF shift 34
```

For example, consider reducing the following rule:

```
A : x y z ;
```

The parser pops off the top three states from the stack. The number of states popped equals the number of symbols on the right side of the rule. These states are the ones put on the stack while recognizing `x`, `y`, and `z`. After popping these states, the parser uncovers the state the parser was in before beginning to process the rule (the state that needed to recognize rule `A` to satisfy its rule). Using this uncovered state and the symbol on the left side of the rule, the parser performs a `goto` action, which is similar to a `shift` of `A`. A new state is obtained and pushed onto the stack, and parsing continues.

The `goto` action is different from an ordinary `shift` of a token. The look-ahead token is cleared by a `shift` but is not affected by a `goto`. When the three states are popped in this example, the uncovered state contains an entry such as the following:

```
A goto 20
```

This entry causes state 20 to be pushed onto the stack and become the current state.

The `reduce` action is also important in the treatment of user-supplied actions and values. When a rule is reduced, the parser executes the code that you included in the rule before adjusting the stack. In addition to the stack holding the states, another stack running in parallel with it holds the values returned from the lexical analyzer and the actions. When a `shift` takes place, the external variable `yyval` is copied onto the value stack. After executing the code that you provide, the parser performs the reduction.

When the parser performs the `goto` action, it copies the external variable `yylval` onto the value stack. The `yacc` variables whose names begin with a dollar sign (\$) refer to the value stack.

4.8.3 Ambiguous Rules and Parser Conflicts

A set of grammar rules is ambiguous if any possible input string can be structured in two or more different ways. For example:

```
expr : expr '-' expr
```

This rule forms an arithmetic expression by putting two other expressions together with a minus sign between them, but this grammar rule does not specify how to structure all complex inputs. For example:

```
expr - expr - expr
```

Using the preceding rule, a program could structure this input as either left-associative or right-associative:

```
( expr - expr ) - expr
```

or

```
expr - ( expr - expr )
```

These two forms produce different results when evaluated.

When the parser tries to handle an ambiguous rule, it can become confused over which of its four actions to perform when processing the input. The following two types of conflicts develop:

Shift/reduce conflict A rule can be evaluated correctly using either a `shift` action or a `reduce` action, with different results.

Reduce/reduce conflict A rule can be evaluated correctly using one of two different `reduce` actions, producing two different actions.

A `shift/shift` conflict is not possible.

These conflicts result when a rule is not as complete as it could be. For example, consider the following input and the preceding ambiguous rule:

```
a - b - c
```

After reading the first three parts of the input, the parser has the following:

```
a - b
```

This input matches the right side of the grammar rule. The parser can reduce the input by applying this rule. After applying the rule, the input becomes the following:

```
expr
```

This is the left side of the rule. The parser then reads the final part of the input, as follows:

- c

The parser now has the following:

expr - c

Reducing this input produces a left-associative interpretation.

However, the parser can also look ahead in the input stream. If, after receiving the first three parts of the input, it continues reading the input stream until it has the next two parts, it then has the following input:

a - b - c

Applying the rule to the rightmost three parts reduces b - c to *expr*. The parser then has the following:

a - *expr*

Reducing the expression once more produces a right-associative interpretation.

Therefore, at the point where the parser has read the first three parts, it can take one of two legal actions: a *shift* or a *reduce*. If the parser has no rule by which to decide between the actions, a *shift/reduce conflict* results.

A similar situation occurs if the parser can choose between two valid *reduce* actions. That situation is called a *reduce/reduce conflict*.

When *shift/reduce* or *reduce/reduce* conflicts occur, *yacc* produces a parser by selecting a valid step wherever it has a choice. If you do not provide a rule to make the choice, *yacc* uses the following rules:

- In a *shift/reduce* conflict, *shift*.
- In a *reduce/reduce* conflict, *reduce* by the grammar rule that can be applied at the earliest point in the input stream.

Using actions within rules can cause conflicts if the action must be done before the parser can be sure which rule is being recognized. In these cases, using the preceding rules leads to an incorrect parser. For this reason, *yacc* reports the number of *shift/reduce* and *reduce/reduce* conflicts that it has resolved by applying its rules.

4.9 Turning on Debug Mode

For normal operation, the external integer variable *yydebug* is set to 0. However, if you set it to any nonzero value, the parser generates a running description of the input tokens that it receives and the actions that it takes for each token. You can set the *yydebug* variable in one of the following two ways:

- Use the `yydebug` function by including the following C language statement in the declarations section of the `yacc` grammar file:

```
yydebug = 1;
```

- Use a debugger to execute the final parser, and set the `yydebug` variable on or off using debugger commands. For further details about using debuggers, such as `dbx`, see the reference pages for the various debuggers.

4.10 Creating a Simple Calculator Program

You can use the programs for a `lex`-generated lexical analyzer and a `yacc`-generated parser, shown in Example 4-1 and Example 4-2, to create a simple desk calculator program that performs addition, subtraction, multiplication, and division operations. The calculator program also lets you assign values to variables (each designated by a single lowercase letter) and then use the variables in calculations. The files that contain the programs are as follows:

- `calc.l` – The `lex` specification file that defines the lexical analysis rules
- `calc.y` – The `yacc` grammar file that defines the parsing rules, and calls the `yylex` function created by `lex` to provide input

By convention, `lex` and `yacc` programs use the letters `.l` and `.y` respectively as file name suffixes. Example 4-1 and Example 4-2 contain the program fragments exactly as they should be entered.

The following processing instructions assume that the files are in your current directory; perform the steps in the order shown to create the calculator program using `lex` and `yacc`:

1. Process the `yacc` grammar file by using the following command. The `-d` option tells `yacc` to create a file that defines the tokens it uses in addition to the C language source code.

```
% yacc -d calc.y
```

This command creates the following files:

- `y.tab.c` – The C language source file that `yacc` created for the parser
- `y.tab.h` – A header file containing `define` statements for the tokens used by the parser

2. Process the `lex` specification file by using the following command:

```
% lex calc.l
```

This command creates the `lex.yy.c` file, containing the C language source file that `lex` created for the lexical analyzer.

3. Compile and link the two C language source files by using the following command:

```
% cc -o calc y.tab.c lex.yy.c
```

4. Use the `ls` command to verify that the following files were created:

- `y.tab.o` – The object file for `y.tab.c`
- `lex.yy.o` – The object file for `lex.yy.c`
- `calc` – The executable program file

You can run the program by entering the `calc` command. You can then enter numbers and operators in algebraic fashion. After you press Return, the program displays the result of the operation. You can assign a value to a variable as follows:

```
m=4
```

You can use variables in calculations as follows:

```
m+5  
9
```

4.10.1 Parser Source Code

Example 4–1 shows the contents of the `calc.y` file. This file has entries in all three of the sections of a `yacc` grammar file: declarations, rules, and programs. The grammar defined by this file supports the usual algebraic hierarchy of operator precedence.

Descriptions of the various elements of the file and their functions follow the example.

Example 4–1: Parser Source Code for a Calculator

```
%{  
#include <stdio.h>      1  
  
int regs[26];          2  
int base;  
  
%}  
  
%start list           3  
  
%token DIGIT LETTER  4  
  
%left '|'            5  
%left '&  
%left '+' '-'  
%left '*' '/' '%'
```

Example 4–1: Parser Source Code for a Calculator (cont.)

```
%left UMINUS /*supplies precedence for unary minus */

%%
/* beginning of rules section */

list:
    /*empty */
    | list stat'\n'
    | list error'\n'
    {
        yyerrok;
    }
    ;
stat:  expr
    {
        printf("%d\n", $1);
    }
    |
    LETTER '=' expr
    {
        regs[$1] = $3;
    }
    ;
expr:  '(' expr ')'
    {
        $$ = $2;
    }
    |
    expr '*' expr
    {
        $$ = $1 * $3;
    }
    |
    expr '/' expr
    {
        $$ = $1 / $3;
    }
    |
    expr '%' expr
    {
        $$ = $1 % $3;
    }
    |
    expr '+' expr
    {
        $$ = $1 + $3;
    }
    |
    expr '-' expr
```

Example 4–1: Parser Source Code for a Calculator (cont.)

```
    {
        $$ = $1 - $3;
    }
    |
    expr '&' expr
    {
        $$ = $1 & $3;
    }
    |
    expr '|' expr
    {
        $$ = $1 | $3;
    }
    |
    '-' expr %prec UMINUS
    {
        $$ = -$2;
    }
    |
    LETTER
    {
        $$ = regs[$1];
    }
    |
    number
    ;
number: DIGIT
    {
        $$ = $1;
        base = ($1==0) ? 8:10;
    }
    |
    number DIGIT
    {
        $$ = base * $1 + $2;
    }
    ;

%%
main()
{
    return(yyparse());
}

yyerror(s)
char *s;
{
    fprintf(stderr, "%s\n",s);
}
```

Example 4–1: Parser Source Code for a Calculator (cont.)

```
}  
  
yywrap()  
{  
    return(1);  
}
```

The declarations section contains entries that perform the following functions:

- ❶ Include standard I/O header file
- ❷ Define global variables
- ❸ Define the rule list as the place to start processing
- ❹ Define the tokens used by the parser
- ❺ Define the operators and their precedence

The rules section defines the rules that parse the input stream.

The programs section contains the following routines. Because these routines are included in this file, you do not need to use the `yacc` library when processing this file.

- `main()` – The required main program that calls `yyparse()` to start the program
- `yyerror(s)` – The error-handling routine, which prints a syntax error message
- `yywrap()` – The wrap-up routine that returns a value of 1 when the end of input occurs

4.10.2 Lexical Analyzer Source Code

Example 4–2 shows the contents of the `calc.l` file. This file contains `#include` statements for standard input and output and for the `y.tab.h` file, which is generated by `yacc` before you run `lex` on `calc.l`. The `y.tab.h` file defines the tokens that the parser program uses. Also, `calc.l` defines the rules to generate the tokens from the input stream.

Example 4–2: Lexical Analyzer Source Code for a Calculator

```
%{  
  
#include <stdio.h>  
#include "y.tab.h"  
int c;  
extern int yylval;  
%}  
%%  
" " ;  
[a-z] {  
    c = yytext[0];  
    yylval = c - 'a';  
    return(LETTER);  
}  
[0-9] {  
    c = yytext[0];  
    yylval = c - '0';  
    return(DIGIT);  
}  
[^a-z0-9\b] {  
    c = yytext[0];  
    return(c);  
}
```

Using m4 Macros in Your Programs

This chapter describes the `m4` macro preprocessor, a front-end filter that lets you define macros by placing `m4` macro definitions at the beginning of your source files. You can use the `m4` preprocessor with either program source files or document source files.

This chapter contains the following information on Macros:

- Using macros
- Defining macros
- Using other `m4` macros

5.1 Using Macros

Macros ease your programming or writing tasks by allowing you to substitute a simple word or two for a great amount of material. Macro calls in a source file have the following form:

```
name [ ( arg1 [ , arg2 ] ) ]
```

For example, suppose you have a C program in which you want to print the same message at several points. You could code a series of `printf` statements like the following:

```
printf("\nThese %d files are in %s:\n",cnt,dir);
```

As your program evolves, you decide to change the wording; but you have to edit each instance of the message. Defining a macro like the following will save you a great deal of work:

```
define(filmsg,`printf("\nThese %d files are in %s:\n",$1,$2)`)
```

Then, everywhere you want to output this message, you use the macro this way:

```
filmsg(cnt,dir);
```

With this implementation, you only need to edit the message in one place.

A **macro definition** consists of a symbolic name (called a **token**) and the character string that is to replace it. A token is any string of alphanumeric characters (letters, numbers, and underscores) beginning with a letter or an underscore and delimited by nonalphanumeric characters (punctuation or white space). For example, `N12` and `N` are both tokens but `A+B` is not a token. When you process your file through `m4`, each occurrence of a recognized

macro is replaced by its definition. In addition to replacing symbolic names with text, `m4` also can perform the following operations:

- Arithmetic calculation
- File manipulation
- Conditional macro expansion
- String and substring functions
- System command execution

The `m4` program reads each token in the file and determines if the token is a macro name. Macro names that are embedded in other tokens are not recognized; for example, `m4` does not interpret `N12` as containing an occurrence of the token `N`. If the token is a macro name, `m4` replaces it with its defining text and pushes the resulting string back onto the input to be rescanned.

Macro expansion is thus recursive; macro definitions can include nested occurrences of other macros to any depth of nesting. You can call macros with arguments, in which case the arguments are collected and substituted into the right places in the defining text before the defining text is rescanned.

The `m4` preprocessor is a standard UNIX filter. It accepts input from standard input or from a list of input files and writes its output to standard output. The following lines illustrate correct `m4` usage:

```
% grep -v '#include' file1 file2 | m4 > outfile
% m4 file1 file2 | cc
```

The `m4` program processes each argument in order. If there are no arguments, or if an argument is a minus sign (`-`), `m4` reads standard input as its input file.

5.2 Defining Macros

You create a macro definition with the `define` command, one of about 20 built-in macros provided by `m4`. For example:

```
define(N,100)
```

The open parenthesis must follow the word `define` with no intervening space.

Given this macro definition, the token `N` will be replaced by `100` wherever it appears in the file being processed. The defining text can be any text, except that if the text contains parentheses, the number of open (left) parentheses must match the number of close (right) parentheses unless you protect an unmatched parenthesis by quoting it. See Section 5.2.1 for an explanation of quoting.

Built-in and user-defined macros work the same way except that some of the built-in macros change the state of the process. Refer to Section 5.3 for a list of the built-in macros.

You can define macros in terms of other macros. For example:

```
define(N,100)
define(M,N)
```

This example defines both `M` and `N` to be `100`. If you later change the definition of `N` and assign it a new value, `M` retains the value of `100`, not the new value you give `N`. The value of `M` does not track that of `N` because the `m4` preprocessor expands macro names into their defining text as soon as possible. The overall result, as far as `M` is concerned, is the same as using the following input in the first place: `define(M,100)` If you want the value of `M` to track the value of `N`, you can reverse the order of the definitions, as follows:

```
define(M,N)
define(N,100)
```

Now `M` is defined to be the string `N`. When the value of `M` is requested later, the `M` is replaced by `N`, which is then rescanned and replaced by whatever value `N` has at that time.

Macro definitions made with the `define` command do not delete characters following the close parenthesis. For example:

```
Now is the time for all good persons.
define(N,100)
Testing N definition.
```

This example produces the following result:

```
Now is the time for all good persons.
```

```
Testing 100 definition.
```

The blank line results from the presence of a newline character at the end of the line containing the `define` macro. The built-in `dnl` macro deletes all characters that follow it, up to and including the next newline character. Use this macro to delete empty lines. For example:

```
Now is the time for all good persons.
define(N,100)dnl
Testing N definition.
```

This example produces the following result:

```
Now is the time for all good persons.
Testing 100 definition.
```

This section contains the following information:

- Using the Quote Characters
- Macro Arguments

5.2.1 Using the Quote Characters

To delay the expansion of a `define` macro's arguments, enclose them in a matched pair of quote characters. The default quote characters are left and right single quotation marks (``` and `'`), but you can use the built-in `changequote` macro to specify different characters. (See Section 5.3.) Any text surrounded by quote characters is not expanded immediately, but the quote characters are removed. The value of a quoted string is the string with the quote characters removed. Consider the following example:

```
define(N,100)
define(M,`N')
```

The quote characters around the `N` are removed as the argument is being collected. The result of using quote characters is to define `M` as the string `N`, not `100`. This example makes the value of `M` track that of `N`, and it is thus another way to accomplish the effect of the following definitions, shown in Section 5.2:

```
define(M,N)
define(N,100)
```

The general rule is that `m4` always strips off one level of quote characters whenever it evaluates something. This is true even outside macros. For example, to make the word, `define`, appear in the output, enter the word in quote characters, as follows:

```
`define' = 1
```

Because of the way `m4` handles quoted strings, you must be careful about nesting macros. For example:

```
define(dog,canine)
define(cat,animal chased by `dog')
define(mouse,animal chased by cat)
```

When the definition of `cat` is processed, `dog` is not expanded to `canine` immediately because it is quoted. But when `mouse` is processed, the definition of `cat` (animal chased by `dog`) is used; this time, `dog` is not quoted, and the definition of `mouse` becomes animal chased by animal chased by `canine`. If the previous example is included in a file named `infile`:

```
% cat infile
define(dog,canine)
define(cat,animal chased by `dog')
define(mouse,animal chased by cat)
```

```
dog
cat
mouse
% m4 infile
canine
```

```
animal chased by canine
animal chased by animal chased by canine
```

When you redefine an existing macro, you must quote the first argument (the macro name), as follows:

```
define(N,100)
:
define('N',200)
```

Without the quote characters, the second `define` macro sees `N`, recognizes it, and substitutes its value, producing the following result:

```
define(100,200)
```

The `m4` program ignores this statement because it only can define names, not numbers.

5.2.2 Macro Arguments

The simplest form of macro processing is replacing one string with another (fixed) string as illustrated in the previous sections. However, macros can also have arguments, so that you can use a given macro in different places with different results. To indicate where an argument is to be used within the replacement text for a macro (the second argument of its definition), use the symbol $\$n$ to indicate the n th argument. For example, the symbol $\$1$ refers to the first argument of a macro. When the macro is used, `m4` replaces the symbol with the value of the indicated argument. For example:

```
define(bump,$1=$1+1)
:
bump(x);
```

In this example, `m4` will replace the `bump(x)` statement with `x=x+1`.

A macro can have as many arguments as needed. However, you can access only nine arguments by using the $\$n$ symbols ($\$1$ through $\$9$). To access arguments past the ninth argument, use the `shift` macro, which drops the first argument and reassigns the remaining arguments to the $\$n$ symbols (second argument to $\$1$, third to $\$2$, and so on). Using the `shift` macro more than once allows access to all arguments used with the macro.

The symbol $\$0$ returns the name of the macro. Arguments that are not supplied are replaced by null strings, so that you can define a macro that concatenates its arguments as follows:

```
define(cat,$1$2$3$4$5$6$7$8$9)
:
```

```
cat (x,y,z)
```

This example replaces the `cat (x,y,z)` statement with `xyz`. Arguments \$4 through \$9 in this example are null because corresponding arguments were not provided.

When scanning a macro, the `m4` program discards leading unquoted blanks, tabs, or newline characters in arguments, but keeps all other white space. For example:

```
define(a,      "$1 $2$3")
:
a(b,
c,
d)
```

This example expands the `a` macro to be `b cd`. In the `define` macro, however, newline characters are meaningful. For example:

```
define(a,$1
$2$3)
:
a(b,c,d)
```

This latter example expands the `a` macro as follows:

```
b
cd
```

Macro arguments are separated by commas. Use parentheses to enclose arguments containing commas, so that the commas are not misinterpreted as ending the arguments containing them. For example, the following statement has only two arguments:

```
define(a, (b,c))
```

The first argument is `a`, and the second is `(b,c)`. To use a single parenthesis in an argument, enclose it in quote characters:

```
define(a,b`)'c)
```

In this example, `b)c` is the second argument.

5.3 Using Other `m4` Macros

The `m4` program provides a set of macros that are already defined (built-in macros). Table 5-1 lists all of these macros and describes them briefly.

The following sections further explain many of the macros and how to use them:

- Changing the comment characters

- Changing the quote characters
- Removing a macro definition
- Checking for a defined macro
- Using integer arithmetic
- Manipulating files
- Redirecting output
- Using system programs in a program
- Using unique file names
- Using conditional expressions
- Manipulating strings
- Printing

Table 5–1: Built-In m4 Macros

Macro	Description
<code>changeocom(<i>l</i>, <i>r</i>)</code>	Changes the left and right comment characters to the characters represented by <i>l</i> and <i>r</i> . The two characters must be different.
<code>changequote(<i>l</i>, <i>r</i>)</code>	Changes the left and right quote characters to the characters represented by <i>l</i> and <i>r</i> . The two characters must be different.
<code>decr(<i>n</i>)</code>	Returns the value of <i>n</i> –1.
<code>define(<i>name</i>, <i>replacement</i>)</code>	Defines a new macro, named <i>name</i> , with a value of <i>replacement</i> .
<code>defn(<i>name</i>)</code>	Returns the quoted definition of <i>name</i> .
<code>divert(<i>n</i>)</code>	Changes the output stream to the temporary file number <i>n</i> .
<code>divnum</code>	Returns the number of the currently active temporary file.
<code>dnl</code>	Deletes text up to a newline character.
<code>dumpdef('name' [, 'name' ...])</code>	Prints the names and current definitions of the named macros.
<code>errprint(<i>str</i>)</code>	Prints <i>str</i> to the standard error file.
<code>eval(<i>expr</i>)</code>	Evaluates <i>expr</i> as a 32-bit arithmetic expression.
<code>ifdef('name', <i>arg1</i>, <i>arg2</i>)</code>	If macro <i>name</i> is defined, returns <i>arg1</i> ; otherwise, returns <i>arg2</i> .

Table 5–1: Built-In m4 Macros (cont.)

Macro	Description
<code>ifelse(<i>str1</i>, <i>str2</i>, <i>arg1</i>, <i>arg2</i>)</code>	Compares the strings <i>str1</i> and <i>str2</i> . If they match, <code>ifelse</code> returns the value of <i>arg1</i> ; otherwise, it returns the value of <i>arg2</i> .
<code>include(<i>file</i>)</code> <code>sinclude(<i>file</i>)</code>	Returns the contents of <i>file</i> . The <code>sinclude</code> macro does not report an error if it cannot access the file.
<code>incr(<i>n</i>)</code>	Returns the value of <i>n</i> +1.
<code>index(<i>str1</i>, <i>str2</i>)</code>	Returns the character position in string <i>str1</i> where <i>str2</i> starts, or -1 if <i>str1</i> does not contain <i>str2</i> .
<code>len(<i>str</i>)</code> <code>dlen(<i>str</i>)</code>	Returns the number of characters in <i>str</i> . The <code>dlen</code> macro operates on strings containing 2-byte representations of international characters.
<code>m4exit(<i>code</i>)</code>	Exits m4 with a return code of <i>code</i> .
<code>m4wrap(<i>name</i>)</code>	Runs macro <i>name</i> before exiting, after completing all other processing.
<code>maketemp(<i>str</i>XXXXX<i>str</i>)</code>	Creates a unique file name by replacing the literal string XXXXX in the argument string with the current process ID.
<code>popdef(<i>name</i>)</code>	Replaces the current definition of <i>name</i> with the previous definition, saved with the <code>pushdef</code> macro.
<code>pushdef(<i>name</i>, <i>replacement</i>)</code>	Saves the current definition of <i>name</i> and then defines <i>name</i> to be <i>replacement</i> in the same way as <code>define</code> .
<code>shift(<i>param_list</i>)</code>	Shifts the parameter list leftward one position, destroying the original first element of the list.
<code>substr(<i>string</i>, <i>pos</i>, <i>len</i>)</code>	Returns the substring of <i>string</i> that begins at character position <i>pos</i> and is <i>len</i> characters long.
<code>syscmd(<i>command</i>)</code>	Executes the specified system command with no return value.
<code>sysval</code>	Gets the return code from the last use of the <code>syscmd</code> macro.
<code>traceoff(<i>macro_list</i>)</code>	Turns off trace for any macro in the list. If <i>macro_list</i> is null, turns off all tracing.
<code>traceon(<i>name</i>)</code>	Turns on trace for the named macro. If <i>name</i> is null, turns trace on for all macros.

Table 5–1: Built-In m4 Macros (cont.)

Macro	Description
<code>translit(<i>string</i>, <i>set1</i>, <i>set2</i>)</code>	Replaces any characters from <i>set1</i> that appear in <i>string</i> with the corresponding characters from <i>set2</i> .
<code>undefine('name')</code>	Removes the definition of the named macro.
<code>undivert(<i>n</i>, <i>n</i>[, <i>n</i>...])</code>	Appends the contents of the indicated temporary files to the current temporary file.

5.3.1 Changing the Comment Characters

To include comments in your m4 programs, delimit the comment lines with the comment characters. The default left comment character is the number sign (#); the default right comment character is the newline character. If these characters are not convenient, use the built-in `changeocom` macro. For example:

```
changeocom({, })
```

This example makes the left and right braces the new comment characters. To restore the original comment characters, use `changeocom` as follows:

```
changeocom(#,  
)
```

Using `changeocom` with no arguments disables commenting.

5.3.2 Changing the Quote Characters

The default quote characters are the left and right single quotation marks (‘ and ’). If these characters are not convenient, change the quote characters with the built-in `changequote` macro. For example:

```
changequote([,])
```

This example makes the left and right brackets the new quote characters. To restore the original quote characters, use `changequote` without arguments, as follows:

```
changequote
```

5.3.3 Removing a Macro Definition

The `undefine` macro removes macro definitions. For example:

```
undefine('N')
```

This example removes the definition of N. You must quote the name of the macro to be undefined. You can use `undefine` to remove built-in macros,

but once you remove a built-in macro, you cannot recover that macro for later use.

5.3.4 Checking for a Defined Macro

The built-in `ifdef` macro determines if a macro is currently defined. The `ifdef` macro accepts three arguments. If the first argument is defined, the value of `ifdef` is the second argument. If the first argument is not defined, the value of `ifdef` is the third argument. If there is no third argument, the value of `ifdef` is null.

5.3.5 Using Integer Arithmetic

The `m4` program provides the following built-in functions for doing arithmetic on integers only:

<code>incr</code>	Increments its numeric argument by 1
<code>decr</code>	Decrements its numeric argument by 1
<code>eval</code>	Evaluates an arithmetic expression

For example, you can create a variable `N1` such that its value will always be one greater than `N`, as follows:

```
define(N,100)
define(N1,`incr(N)`)
```

The `eval` function can evaluate expressions containing the following operators (listed in decreasing order of precedence):

- unary + (plus), unary - (minus)
- `**` or `^` (exponentiation)
- `*`, `/`, `%` (modulo)
- `+`, `-`
- `==`, `!=`, `<`, `<=`, `>`, `>=`
- `!` (NOT)
- `&` or `&&` (logical AND)
- `|` or `||` (logical OR)

Use parentheses to group operations where needed. All operands of an expression must be numeric. The numeric value of a true relation such as `1>0` is 1, and false is 0 (zero). The precision in `eval` is 32 bits. For example, to define `M` as `2==N+1`, use `eval` as follows:

```
define(N,3)
define(M,`eval(2==N+1)`)
```

Use quote characters around the text that defines a macro, unless the text is simple and contains no instances of macro names.

5.3.6 Manipulating Files

To merge a new file in the input, use the built-in `include` macro as follows:

```
include(myfile)
```

This example inserts the contents of `myfile` in place of the `include` command. As the included file is read, `m4` scans it for macros as if it were part of the primary input.

With the `include` macro, a fatal error occurs if the named file cannot be accessed. To avoid an error, use the alternative form, `sinclude` (silent include). The `sinclude` macro continues without error if the named file cannot be accessed.

5.3.7 Redirecting Output

You can redirect the output of `m4` to temporary files during processing, and the collected material can be output upon command. The `m4` program can maintain up to nine temporary files, numbered 1 through 9. To redirect output, use the `divert` macro as in the following example:

```
divert(4)
```

When this command is encountered, `m4` begins writing its output to the end of temporary file 4. The `m4` program discards the output if you redirect the output to a temporary file other than 1 through 9; you can use this feature to make `m4` omit a portion of the input file. Use `divert(0)` or `divert` with no argument to return the output to the standard output stream.

At the end of its processing, `m4` writes all redirected output to the standard output stream, reading from the temporary files in numeric order and then destroying the temporary files.

To retrieve the information from all temporary files in numeric order at any time before processing is completed, use the built-in `undivert` macro with no arguments. To retrieve selected temporary files in a specified order, use `undivert` with arguments. When using `undivert`, `m4` discards the temporary files that are recovered and does not search the recovered information for macros.

The value of `undivert` is not the diverted text.

The built-in `divnum` macro returns the number of the currently active temporary file. If you do not change the output file with the `divert` macro, `m4` puts all output in temporary file 0 (zero).

5.3.8 Using System Programs in a Program

You can run any program in the operating system from a program by using the built-in `syscmd` macro. If the system command returns information, that information is the value of the `syscmd` macro; otherwise, the macro's value is null. For example:

```
syscmd(date)
```

5.3.9 Using Unique File Names

Use the built-in `maketemp` macro to make a unique file name from a program. If the literal string `XXXXX` is present in the macro's argument, `m4` replaces the `XXXXX` with the process ID of the current process. For example:

```
maketemp(myfileXXXXX)
```

If the current process ID is 23498, this example returns `myfile23498`. You can use this string to name a temporary file.

5.3.10 Using Conditional Expressions

The built-in `ifelse` macro performs conditional testing. The simplest form is the following:

```
ifelse(a,b,c,d)
```

This example compares the two strings `a` and `b`. If they are identical, `ifelse` returns string `c`. If they are not identical, it returns string `d`. For example, you can define a macro called `compare` to compare two strings and return `yes` if they are the same or `no` if they are different, as follows:

```
define(compare, `ifelse($1,$2,yes,no)`)
```

The quote characters prevent the evaluation of `ifelse` from occurring too early. If the fourth argument is missing, it is treated as empty.

The `ifelse` macro can have any number of arguments, and it therefore provides a limited form of multiple path decision capability. For example:

```
ifelse(a,b,c,d,e,f,g)
```

This statement is logically the same as the following fragment:

```
if(a == b) x = c;  
else if(d == e) x = f;  
else x = g;  
return(x);
```

If the final argument is omitted, the result is null.

5.3.11 Manipulating Strings

The built-in `len` macro returns the byte length of the string that makes up its argument. For example, `len(abcdef)` is 6, and `len((a,b))` is 5.

The built-in `dlen` macro returns the length of the displayable characters in a string. In certain international usages, 2-byte codes are displayed as one character. Thus, if the string contains any 2-byte international character codes, the result of `dlen` will differ from the result of `len`.

The built-in `substr` macro returns the substring (beginning at the character position specified by the second argument) from a specified string (first argument). The third argument specifies the length in bytes of the returned substring. For example:

```
substr(Krazy Kat,6,5)
```

This example returns “Kat”, which is the 3-character substring beginning at character position 6 of the string “Krazy Kat”. The first character in the string is at position 0 (zero). If the third argument is omitted or if the string is not long enough to satisfy the third argument, as in this example, the rest of the string is returned.

The built-in `index` macro returns the byte position, or index, in a string (first argument) where a substring (second argument) begins. If the substring is not present, `index` returns `-1`. As with `substr`, the origin for strings is 0 (zero). For example:

```
index(Krazy Kat,Kat)
```

This example returns 6.

The built-in `translit` macro performs one-for-one character substitution, or transliteration. The first argument is a string to be processed. The second and third arguments are lists of characters. Each instance of a character from the second argument that is found in the string is replaced by the corresponding character from the third argument. For example:

```
translit(the quick brown fox jumps over the lazy dog,aeiou,AEIOU)
```

This example returns the following:

```
thE qUICK brOwn fOx jUmPs OvEr thE lAZy dOg
```

If the third argument is shorter than the second argument, characters from the second argument that are not in the third argument are deleted. If the third argument is missing, all characters present in the second argument are deleted.

Note

The `substr`, `index`, and `translit` macros do not differentiate between 1- and 2-byte displayable characters and can return unexpected results in some international usages.

5.3.12 Printing

The built-in `errprint` macro writes its arguments to the standard error file. For example:

```
errprint ('error')
```

The built-in `dumpdef` macro dumps the current names and definitions of items named as arguments. Names must be quoted. If you supply no arguments, `dumpdef` prints all current names and definitions. The `dumpdef` macro writes to the standard error file.

6

Revision Control: Managing Source Files with RCS or SCCS

This chapter describes how to keep your program or documentation source files well organized by using a **version control** system. A version control system automates the storage, retrieval, logging, identification, and merging of document revisions. Version control is most useful for text that is revised frequently, such as programs, documentation, graphics, papers, and so on. The Tru64 UNIX operating system provides the following two version control systems with slightly different features:

- Revision Control System (RCS)
- Source Code Control System (SCCS)

This chapter introduces basic version control concepts, describes how to use the RCS and SCCS commands and utilities, and provides more advanced information about using each system:

- Overview of revision control
- Version control concepts
- Managing multiple versions of files
- Creating a version control library
- Using RCS
- Using SCCS
- Functional comparison of RCS and SCCS commands

Examples in this chapter describe a hypothetical kit for a product called “Orpheus Authoring Tools.” The example kit is considered to be one of several Orpheus products. Because this particular kit is a document builder, the kit name is abbreviated as DCB and the main project directory is `dcb_tools`.

6.1 Overview of Revision Control

Using the Revision Control System (RCS) or the Source Code Control System (SCCS) lets you keep your source files in a common library and maintain control over them. Both systems provide easy-to-use, command-line interfaces. Knowing the basic commands lets you **check in** the source file to be modified into a **version control file** that contains all of the revisions

of that source file. When you want to **check out** a version control file for editing, the system retrieves the revision or revisions you specify from the library and creates a **working file** for you to use.

Using more advanced interface commands lets you do the following:

- Identify the current status of any file, including the name of the person editing it.
- Reconstruct earlier versions of your files. For each version, the system stores the changes made to produce that version, the name of the person making the changes, and the reasons for the changes.
- Prevent the problems that can occur when two people change a file at the same time without each other's knowledge.
- Maintain multiple branch versions of your files. Branched versions can be merged back into the original sequence.
- Protect files from unauthorized modification.
- RCS also allows for release and configuration control. Revisions can be assigned symbolic names and marked according to the state of the file (for example, released, stable, experimental, and so on).

Depending on your development environment and unique revision control requirements, you can select either RCS or SCCS as your version control system. Your choice depends on the amount of security and versatility you require. Table 6–1 summarizes some of the more widely used features of each system.

Table 6–1: Features of RCS and SCCS

Feature	Comments
Stores and retrieves multiple revisions of text.	Both systems provide a simple way to store and retrieve all changes made to a file. In addition, RCS can retrieve revisions based on ranges of revision numbers, symbolic names, dates, authors, and states.
Maintains a complete history of changes.	Both systems log changes automatically. Besides the text of each revision, both systems store the author, date and time of the checkin, and a log message summarizing the changes.
Resolves access conflicts.	Both systems prevent two people from modifying a file without each other's knowledge.
Maintains tree of revisions.	Both systems can maintain separate lines of development for each file.

Table 6–1: Features of RCS and SCCS (cont.)

Feature	Comments
Merges revised files with conflict resolution.	Both systems provide a way to merge changes to a file from two separate lines of development. RCS also alerts the user if there are overlapping changes to the file versions.
Allows for release and configuration control. (<i>RCS only</i>)	RCS can assign symbolic names to revisions so that configurations of modules can be described simply and directly.
Automates identification of each revision.	Both systems use keywords to tag revisions of files with name, revision number, time, author, and so on.

6.2 Version Control Concepts

RCS and SCCS store files in a reserved directory, called a **version control library**. The contents of each source file are stored as a single version control file (called an **RCS file** in RCS or an **s-file** in SCCS). A version control file contains the original file (called a **g-file** in SCCS) together with all the changes, or **deltas**, that have been applied to it. Each delta is described by text telling who made the change and why. The change information itself is stored in the form of marked lines of text. Every line that is deleted or changed is marked as deleted but is not actually removed. New lines can be either edited versions of old lines or completely new material inserted at the appropriate places and marked. Your version control system can reconstruct any version of the file by applying all the deletions and additions for versions up to the desired version and by ignoring all later versions.

In RCS, RCS files are identified by the suffix `,v` added to their names; for example, `attr,v` would be the RCS-file for the source file named `attr`.

In SCCS, s-files are identified by the prefix `s.` added to their names; for example, `s.attr` would be the s-file for the source file named `attr`. Figure 6–1 illustrates the contents of a typical version control file. RCS and SCCS files contain the same kinds of information, but their organization is different.

Figure 6–1: Contents of a Version Control File

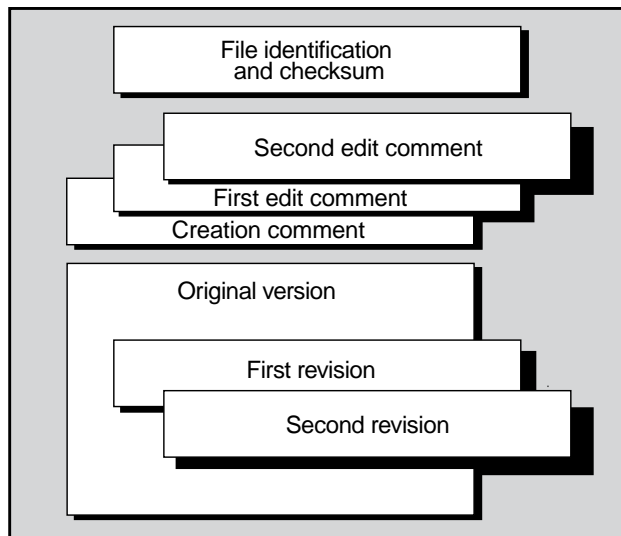

ZK0456UR

A version identification number is applied to a particular revision of the version control file. In SCCS, this number is called an **SID**. The identification number for SCCS can contain up to four elements; RCS provides for additional elements. The first two elements are the release number and the level number within that release, and the third and fourth represent the same items of information (called the branch and the sequence) for a branched version of the file. (See Section 6.3.) Release identification numbers begin at 1. Level identification numbers within a release begin at .1 and advance by .1, so that the first version of a file is 1.1, the second version is 1.2, and so on. Figure 6–4 (in Section 6.3) illustrates the numbering sequence for one file's deltas.

A version control library is a directory in which all the version control files for a given project are stored. When you retrieve a file from the library, both RCS and SCCS provide a **locking mechanism** that prevents two people from accessing the file at the same time. File locking is discussed in detail in the following sections.

Usually, but not always, the library is given the name `RCS` or `SCCS`, depending on the system you use. Figure 6–2 and Figure 6–3 illustrate how a project's directory tree might appear with the RCS or SCCS library placed below the project's main directory.

Figure 6–2: A Typical RCS Library

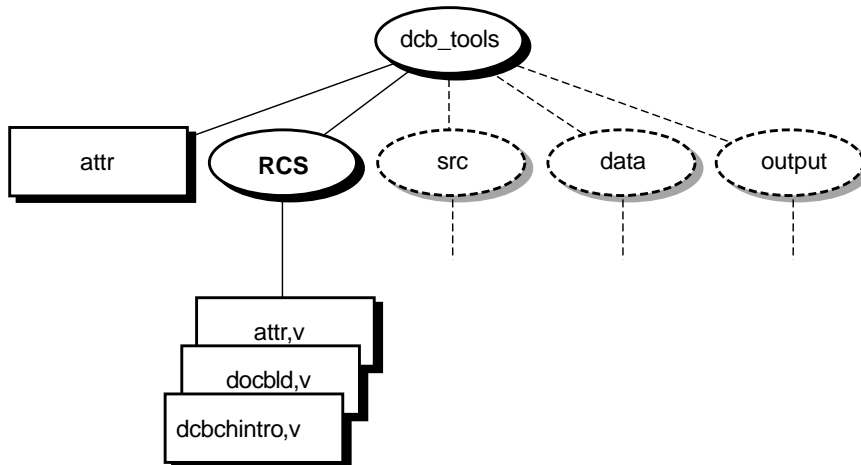

ZK0621UR

Figure 6–2 shows three RCS files. When a file is checked out of the library for editing, RCS correlates all the deltas and delivers a copy of the specified version, as illustrated here with the `attr` file. RCS also edits the RCS-file to insert the name of the person checking out the file. This information is stored in the `$Locker$` keyword. See Section 6.5.2 for more information about using keywords in RCS.

RCS differs from SCCS in that file locking is enforced at checkin time. A file can be checked out by more than one person, but only the first person to check it out (the one holding the lock) can check it back in to the library. Even if a revision is locked, it can still be checked out for reading, compiling, and so on. Locking ensures that only one developer at a time can check in the next update of the file. In other words, locking prevents a checkin by anybody but the locker (the first person to check out the file).

If your RCS file is private and you will be the only person making revisions to it, you can turn off the strict locking feature of RCS. When a file is checked back in, RCS removes the user's name from the `$Locker$` keyword. If strict locking is turned off, the owner of the file does not need to have a lock for checkin, but all others do. Use the following commands to turn strict locking off and on:

```
% rcs -U filename
```

and

```
% rcs -L filename
```

For more detailed information on file locking, refer to Section 6.5.3, Section 6.5.5, and the `co(1)` reference page.

Figure 6–3 illustrates three s-files and one other file, named `p.attr`, in the SCCS library. When a file is checked out of the library for editing, SCCS correlates all the deltas and delivers a copy of the specified version, as illustrated here with the `attr` file. SCCS also creates a lock file, called a **p-file**. If another person tries to check out the same file for editing, SCCS reports that the file is being edited and refuses to give access to the second person. A p-file has the letter `p` added as a prefix to its name. When a file is checked back in to the library, SCCS removes the p-file.

Figure 6–3: A Typical SCCS Library

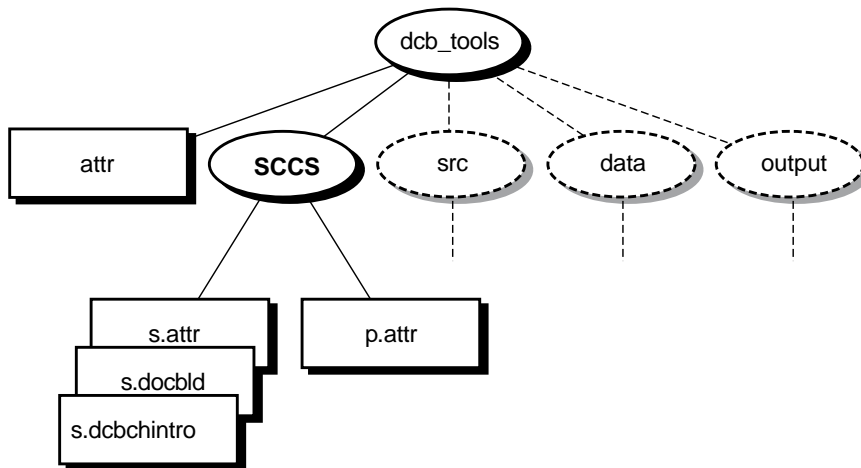

ZK0457UR

6.3 Managing Multiple Versions of Files

Usually, file versions progress in a straight line, with only one current version. In this case, file identification numbers contain two elements and progress by steps of `.1`, so that the first version number applied to a file is `1.1` and the eighth, for example, is `1.8`.

Projects running in parallel to develop new versions of the same basic program can use the same version control file. As the different versions are put into the library, a tree develops. For example, suppose two teams begin development on separate versions of a file or module, starting from the most recent revision.

As the two development streams continue, a complex tree of deltas can be created, as illustrated in Figure 6–4.

Figure 6–4: A Version Control File’s Tree of Deltas

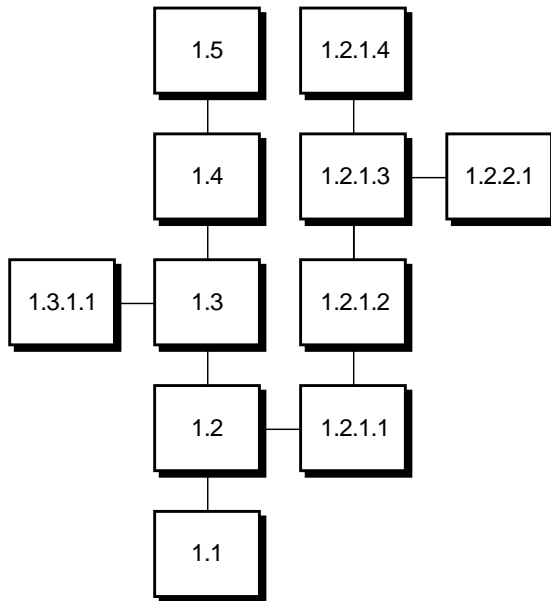

ZK0458UR

To get or edit a file from one of the branches, you must specify its branch number. Figure 6–4 shows a tree for a version control file that consists of a main trunk (contains revisions numbers 1.1, 1.2, 1.3, and so on) and branches. For the delta numbers shown, the first two elements reflect the version number from which it is branched, and the second two elements reflect the new element’s version number.

As an example, suppose the two development teams are working with revision number 1.2 of a file. Both RCS and SCCS will allocate a number of 1.3 to the first team to access the file. For the second team, the version control system will create a delta numbered 1.2.1.1. Because this is the first delta along this 1.2 branch, the last two elements of this version number are shown as 1.1.

As the two versions are developed, they can themselves be branched from; for example, a programmer might branch a new file from revision number 1.2.1.3 after revision number 1.2.1.4 has been created.

For more information and specific examples on branching in RCS and SCCS, see Section 6.5.5 and Section 6.6.5.

6.4 Creating a Version Control Library

Once you have selected the version control system you want to use for your development project, you should create a directory in which you will place the RCS or SCCS files. Depending on the size and complexity of your development project, you might want to involve your system administrator, who can help you determine ownership and protection settings for the directory and source files.

When setting up your directory, you might want to assign ownership of the directory to the `rcs` or `sccs` user ID and set its permissions to prevent users other than `rcs` or `sccs` from writing to it. This method provides good security in that only RCS or SCCS can directly manipulate the files in the library.

If you are going to use the `sccs` command, the library's directory should be named `SCCS`, as illustrated in Figure 6-3. If the library directory is not named `SCCS`, you must use the `-d` option with the `sccs` command to access files in the library. (See Table 6-8.) For RCS, the directory should be named `RCS`; otherwise, you must specify a complete path (absolute or relative) to the RCS-file.

6.5 Using RCS

This section explains the different features of RCS:

- Placing new files in an RCS library
- Recording file-identification information with RCS
- Getting files from an RCS library
- Checking edited files back into an RCS library
- Working with multiple versions of files
- Displaying differences in RCS files
- Reporting revision histories of RCS files
- Configuration control concepts

The RCS system provides a set of UNIX commands that assist in the task of version control for your text files. It is designed for both production and development environments where flexibility and file access control are high priorities. In production environments, access controls can detect update conflicts and prevent overlapping changes. In fast-changing development environments, where such strong controls may not be appropriate, users can easily modify the controls to suit individual project needs.

The RCS system comprises a set of independent commands. Table 6-2 lists the RCS commands provided. The sections following the table provide more

information on some of these commands. Refer to the appropriate reference page for additional information on the available command options.

Table 6–2: Summary of RCS Command Functions

Command	Description								
ci	Checks in revisions. Stores the contents of a working file in the corresponding RCS file as a new revision.								
	<table border="1"> <thead> <tr> <th>Option</th> <th>Description</th> </tr> </thead> <tbody> <tr> <td>-u or -l</td> <td>Using one of these options prevents a working file from being deleted at checkin time.</td> </tr> <tr> <td>-r</td> <td>Assigns a revision number to the file being checked in.</td> </tr> <tr> <td>-k</td> <td>Searches the checked-in file for identification markers, and assigns them to new revisions.</td> </tr> </tbody> </table>	Option	Description	-u or -l	Using one of these options prevents a working file from being deleted at checkin time.	-r	Assigns a revision number to the file being checked in.	-k	Searches the checked-in file for identification markers, and assigns them to new revisions.
Option	Description								
-u or -l	Using one of these options prevents a working file from being deleted at checkin time.								
-r	Assigns a revision number to the file being checked in.								
-k	Searches the checked-in file for identification markers, and assigns them to new revisions.								
co	Checks out revisions. Retrieves revisions according to revision number, date, author, and state attributes. Always expands the identification markers (keywords).								
	<table border="1"> <thead> <tr> <th>Option</th> <th>Description</th> </tr> </thead> <tbody> <tr> <td>-l</td> <td>Locks the revision during file checkout to prevent overlapping modifications if several people work on the same file.</td> </tr> </tbody> </table>	Option	Description	-l	Locks the revision during file checkout to prevent overlapping modifications if several people work on the same file.				
Option	Description								
-l	Locks the revision during file checkout to prevent overlapping modifications if several people work on the same file.								
ident	Extracts the identification markers from a file and prints them. The identification markers (keywords) are always expanded by co.								
rccs	Changes RCS file attributes. Changes (as an administrative operation) access lists, modifies file locking attributes, sets state attributes and symbolic revision numbers, changes the description, and deletes revisions. A revision only can be deleted if it is not the fork of a side branch.								
	<table border="1"> <thead> <tr> <th>Option</th> <th>Description</th> </tr> </thead> <tbody> <tr> <td>-L</td> <td>Sets the strict file locking mode. This means that the owner of an RCS file must lock the file at checkin. This default is determined by the system administrator.</td> </tr> <tr> <td>-U</td> <td>Sets the nonstrict file locking mode. This means that the owner of the file does not need to lock the file at checkin. This default is determined by the system administrator.</td> </tr> </tbody> </table>	Option	Description	-L	Sets the strict file locking mode. This means that the owner of an RCS file must lock the file at checkin. This default is determined by the system administrator.	-U	Sets the nonstrict file locking mode. This means that the owner of the file does not need to lock the file at checkin. This default is determined by the system administrator.		
Option	Description								
-L	Sets the strict file locking mode. This means that the owner of an RCS file must lock the file at checkin. This default is determined by the system administrator.								
-U	Sets the nonstrict file locking mode. This means that the owner of the file does not need to lock the file at checkin. This default is determined by the system administrator.								
rccs-clean	Cleans your working directory. Removes working files that were checked out but never changed.								
rccs-diff	Compares two revisions and prints out their differences, using the diff command. One of the revisions compared can be checked out. This command is useful for finding out about changes.								

Table 6–2: Summary of RCS Command Functions (cont.)

Command	Description						
<code>rcsfreeze</code>	Freezes a configuration. Assigns the same symbolic revision number to a given revision in all RCS files. This command is useful for accurately recording a configuration.						
<code>rcsmerge</code>	Merges two revisions, <i>rev1</i> and <i>rev2</i> , with respect to a common ancestor. A three-way file comparison determines the parts of lines that are the same in all three revisions, the same in two revisions, or different in all three. Overlapping changes are flagged and reported to the user.						
	<table border="1"><thead><tr><th>Option</th><th>Description</th></tr></thead><tbody><tr><td><code>-p</code></td><td>Prints the result of the merged files to the standard output; otherwise, the resulting merged file overwrites the working file.</td></tr></tbody></table>	Option	Description	<code>-p</code>	Prints the result of the merged files to the standard output; otherwise, the resulting merged file overwrites the working file.		
Option	Description						
<code>-p</code>	Prints the result of the merged files to the standard output; otherwise, the resulting merged file overwrites the working file.						
<code>rlog</code>	Reads log messages. Prints the log messages and other information in an RCS file, for example: RCS file name, working file name, head (the number of the latest revision on the trunk), default branch, access list, locks, symbolic names, number of revisions and descriptive text.						
	<table border="1"><thead><tr><th>Option</th><th>Description</th></tr></thead><tbody><tr><td><code>-h</code></td><td>Prints only the RCS file name, working file name, head, default branch, access list, locks, symbolic names, and suffix.</td></tr><tr><td><code>-t</code></td><td>Prints the same information as does <code>-h</code>, plus the descriptive text.</td></tr></tbody></table>	Option	Description	<code>-h</code>	Prints only the RCS file name, working file name, head, default branch, access list, locks, symbolic names, and suffix.	<code>-t</code>	Prints the same information as does <code>-h</code> , plus the descriptive text.
Option	Description						
<code>-h</code>	Prints only the RCS file name, working file name, head, default branch, access list, locks, symbolic names, and suffix.						
<code>-t</code>	Prints the same information as does <code>-h</code> , plus the descriptive text.						

6.5.1 Placing New Files in an RCS Library

You can use the `ci` command to place new files in a library. The following example assumes that you are in the library's parent directory and want to add the `attr` file to the library:

```
% ci attr
RCS/attr,v <---- attr
enter description, terminated with single '.' or end of file:
>> Orpheus Authoring Tools attr command
>> .
initial revision: 1.1
done
```

The `ci` command creates the RCS file `attr,v` and stores `attr` in it as revision 1.1. The command prompts you for a description, which should be a synopsis of the contents of the file. All later checkin commands will prompt you for a log entry, which should summarize the changes you made.

You can enter a series of files in a single operation. For example:

```
% ci attr docbld dcb.ch-intro
```

6.5.2 Recording File-Identification Information with RCS

The RCS system provides a syntax for including **keywords** or **ID markers** in source files to provide file-identification information. An ID marker consists of a keyword enclosed within dollar signs (\$). When you retrieve a file from the RCS library, RCS expands the keyword by replacing it with the appropriate information, such as the file name or revision number.

RCS lets you use keyword markers anywhere in your file as literal strings or comments to identify a revision. For example, if you place the marker `$Header: full_pathname/file-name rev_num yyyy/mm/dd HH:mm:ss author state $` into your text file, RCS (with the `co` command) will replace this keyword with the following information:

```
$Header: full_pathname/filename rev_num yyyy/mm/dd HH:mm:ss author
state $
```

Table 6-3 lists the RCS keywords and their corresponding values.

Table 6-3: RCS ID Keywords

Keyword	Description
<code>\$Author\$</code>	The login name of the user who checked in the revision.
<code>\$Date\$</code>	The date and time the revision was checked in.
<code>\$Header\$</code>	A standard header containing the full pathname of the RCS file, the revision number, the date, the author, the state, and the locker (if locked).
<code>\$Id\$</code>	Same as the full standard header except that the RCS file name is without a path.
<code>\$Locker\$</code>	The login name of the user who locked the revision (empty if unlocked).
<code>\$Log\$</code>	The log message supplied during checkin, preceded by a header containing the RCS file name, the revision number, the author, and the date. Existing log messages are not replaced; instead, the new log message is inserted after <code>\$Log:...\$</code> .
<code>\$RCSfile\$</code>	The name of the RCS file without path.
<code>\$Revision\$</code>	The revision number assigned to the revision.
<code>\$Source\$</code>	The full pathname of the RCS file.
<code>\$State\$</code>	The state assigned to the revision with the <code>-s</code> option of <code>rcs</code> or <code>ci</code> .

The `ident` command finds and extracts keywords from any file, even object files and dumps. It searches the files you specify for all occurrences of the pattern `$keyword :... $`. For example, suppose the C program `myfile.c` contains the following information:

```
char resid [] = "$Header: /usr/doc/osf1doc/basedocs/rcs/src/prog/prog_tools_gd/ch-sccs.sgml,v 1.1.6.7 1999/06/21 19:35:35 Lui
```

The command `ident` will print the following:

```
myfile.c : $Header: full_pathname/filename rev_num yyyy/mm/dd  
HH:mm:ss author state $
```

For more detailed information on using keywords in RCS, refer to the `co(1)` reference page.

6.5.3 Getting Files from an RCS Library

To retrieve a file revision from an RCS file, check it out of the RCS library by using the `co` command. The `co` command retrieves a revision from the RCS-file and stores it in a corresponding working file.

Revisions of an RCS file can be checked out locked or unlocked. Locking a revision prevents overlapping updates. When you check out a file for reasons other than editing (reading or processing, for example), the revision need not be locked. (A revision checked out for editing and later checkin usually must be locked.) For example:

```
% cd /usr/projects/dcb_tools  
  
% co -u attr  
RCS/attr,v ----> attr  
revision 1.6 (unlocked)  
done
```

This command creates a copy of the most recent version of the RCS-file (with keyword information included) and places it in your current directory (`/usr/projects/dcb_tools` in this example). The `-u` option prevents RCS from locking the file. To get a copy of any earlier version, use the `-r` option. For example, to retrieve version 1.5 of a file that is now at version 1.8, you would use a command like the following:

```
% cd /usr/projects/dcb_tools  
  
% co -r1.5 attr  
RCS/attr,v ----> attr  
revision 1.5  
done
```

You can also retrieve a series of files with a single `co` command. For example:

```
% co attr unstamp  
RCS/attr,v ----> attr  
revision 1.5  
done  
  
RCS/unstamp,v ----> unstamp  
revision 1.2  
done
```

6.5.4 Checking Edited Files Back into an RCS Library

To replace one or more edited files, use the `ci` command. This command places the contents of each working file in the corresponding RCS file. Usually, RCS checks whether the revision to be deposited in the library is different from the preceding one, and alerts the user.

Also, because the `ci` command deletes your working files during checkin, you may want to use either the `-l` option or the `-u` option to preserve your working files by performing an implicit checkout operation. Use the `ci` command with the `-l` or `-u` option if you want to save the current revisions and continue editing.

6.5.5 Working with Multiple Versions of Files

Section 6.3 provides an overview of branching concepts in a version control system. The following discussion provides specific examples that illustrate how RCS handles branching of multiple files.

RCS arranges file revisions in a tree of deltas. Each file in a revision tree contains the following kinds of information: a revision number, a checkin time and date, the author's identification, a log entry, a state, and the actual text. All of these file attributes are determined at the time the revision is checked in to the library. The 'state' attribute indicates the status of the revision, which is set to 'experimental' during checkin, but which can be later changed to stable or released.

The `ci` command creates a revision tree with a root revision that is usually numbered 1.1. Unless you specify a revision number explicitly, `ci` assigns new revision numbers by incrementing the level number of the previous revision (1.2, 1.3, 1.4, and so on). To begin a new release, use the following command:

```
% ci -r2.1 unstamp
```

or

```
% ci -r2 unstamp
```

This action assigns the number 2.1 to the new revision. Checking in the file to the library without the `-r` option automatically assigns the numbers 2.2, 2.3, and so on, to the later revisions of the file.

Suppose two development teams begin development on separate releases of the `unstamp` command, beginning from revision number 1.2. At this point, both teams can check out the latest revision by using the `co` command with the `-l` option as follows:

```
% co -l unstamp
```

After editing the file, the first team can check in the file by using the `ci` command, and will be alerted by RCS that the new revision number is 1.3. For example:

```
% ci unstamp
RCS/unstamp,v <----- unstamp
new revision 1.3; previous revision 1.2
enter log message:
(terminate with a ^D or single '.')
>> Changed defaults check.
>> .
done
```

However, if the second team tries to check in the file with the same action, RCS will issue the following message:

```
RCS/unstamp,v <----- unstamp
ci error: no lock set by user-name
```

At this point, the second team can create a branch by using the `ci` command as follows:

```
% ci -r1.3.1 unstamp
```

This action results in a branch with revision number 1.3.1.1. To continue development along this branch, the second team should use the current branch revision number on all subsequent checkouts of the file. For example:

```
% co -r1.3.1.1 unstamp
```

Creating new branches in RCS is accomplished through the use of the `ci` command; to continue development along a particular branch, use the `-r` option with the `co` command.

The preceding discussion describes how RCS handles revisions of individual files; the system also lets you work with groups (or sets) of files that you specify. See Section 6.5.8 for more information on working with file configurations in RCS.

6.5.6 Displaying Differences in RCS Files

You can examine an RCS file for differences between versions with the `rcsdiff` command.

The `rcsdiff` command runs `diff` to compare two revisions of each RCS file given. For example, to find the differences between the latest version of the `attr` file (1.8, being edited to become 1.9) and the immediately preceding version (1.7), you would use the following command:

```
% rcsdiff -r1.7 attr
=====
RCS file: RCS/attr,v
retrieving revision 1.7
diff -r1.7 attr
31d30
<# and is version linked to the docbld command
```

To check the differences between versions 1.3 and 1.4 of the `attr` file, you would use the following command:

```
% rcsdiff -r1.3 -r1.4 attr
=====
RCS file: RCS/attr,v
retrieving revision 1.3
retrieving revision 1.4
diff -r1.3 -r1.4
5a6
< uts=-04
---
> uts=-05
```

6.5.7 Reporting Revision Histories of RCS Files

Use the `rlog` command to examine the revision history of a file. For example, the `rlog` command provides you with the following detailed information:

```
% rlog unstamp
RCS file:      RCS/unstamp,v; Working file:      unstamp
head:         1.2
branch:
locks:        ; strict
access list:
symbolic names:
comment leader: "# "
total revisions: 2; selected revisions: 2
description:
unstamp source file

-----
revision 1.2
date: 92/06/09 15:51:16; author:gunther; state:Exp; lines
added/del:
Fixed copyright notice

-----
revision 1.1
date: 92/06/09 15:49:16; author:gunther; state:Exp;
Initial revision
```

Note the type and amount of information that is available to you using the `rlog` command. RCS prints the following information for each RCS file:

- RCS file name
- Working file name
- Head (the number of the latest revision on the trunk)
- Default branch
- Access list
- Locks on the file
- Symbolic names (if any)
- Suffix
- Total number of revisions
- Number of revisions selected for printing

- Descriptive text

This information is followed by entries for the selected revisions in reverse chronological order for each branch. If entered without specifying options, `rlog` prints complete information for the file you select. See the `rlog(1)` reference page for more information on using options to restrict the output of the `rlog` command.

6.5.8 Configuration Control Concepts

A **configuration** in RCS refers to a group or set of file revisions, in which each revision comes from a different file revision group. File revisions can be selected (checked out) according to certain criteria. You can check out sets of files from an RCS library based on the following selection criteria:

- **Default selection:** You can choose the latest revision of all files by default. For example, the following command retrieves the latest revision on the default branch of each RCS file in the library:

```
% co *,v
```

- **Release-based selection:** You can also specify a release or branch number to select the latest revision in that release or branch. For example, the following command retrieves the latest revision with release number 2 from each RCS file:

```
% co -r2 *,v
```

- **State and author-based selection:** You can select files according to state attributes. For example, suppose you want to retrieve the latest revision with release number 2 whose state attribute is 'Released.' This can be accomplished by issuing the following command:

```
% co -r2 -sReleased *,v
```

You can also select a revision by author, by using the `-w` option.

- **Date-based selection:** You can also select revisions by date. Suppose a release of an entire system was completed and current as of June 15, at 2:00 p.m. The following command checks out all files of that release, with the `-d` option specifying the cutoff date as June 15:

```
% co -d "June 15,2:00 pm" *,v
```

- **Name-based selection (using symbolic names):** You can assign **symbolic names** to revisions and branches. In large systems and development efforts, a single release number or date may not be sufficient to collect all the appropriate revisions from all groups. For example, suppose you need to combine release 2 of one subsystem with release 10 of another. Most likely, the creation dates of these revisions will be different, so passing a single revision number or date to the `co` command will not be appropriate in this case. Using symbolic revision names can help solve this problem; each RCS file can contain a set of symbolic names that are

mapped to the numeric revision numbers. For instance, suppose you set the symbolic name IFT2 to release number 2 in the file `attr,v` and to revision number 10.2 in `unstamp,v`. In this case, a single `co` command retrieves the latest revision of release 2 from `attr,v` and revision 10.2 from `unstamp,v` as follows:

```
% co -rIFT2 attr,v unstamp,v
```

You can use the `rcsfreeze` command to assign a symbolic revision name to a set of RCS files that form a configuration. To assign a unique symbolic revision name to the most recent revision of each RCS file of the main trunk, use the `rcsfreeze` command each time a new version is checked in. For more information on assigning symbolic names to RCS-files, refer to the `rcsfreeze(1)` reference page. For large software development efforts, the ability to retrieve all revisions with one command makes configuration management an organized and efficient task.

6.6 Using SCCS

The SCCS system is composed of several independent commands, each of which can be used independently. The `sccs` command is a unified interface that simplifies the usage of the most common SCCS commands and provides several additional functions by combining the operations of multiple commands. It does not support all of the functions of the individual commands.

Each form of the `sccs` command includes the keyword `sccs` and the name of one function, such as `edit`, followed by options and the names of the file or files to be manipulated. Table 6-4 lists the `sccs` commands. The sections following the table provide more information on some of these commands. In these discussions, command options are omitted except where required. Commands that are also individual low level commands are indicated in the table. The complete list of individual commands is summarized in Table 6-9; for detailed information on their use, along with descriptions of their options, refer to their individual reference pages.

Table 6-4: Summary of `sccs` Command Functions

Command Name	Low Level	Description
<code>admin</code>	Yes	Creates an s-file or changes some characteristic of an existing s-file.
<code>check</code>	No	Reports on files being edited and the names of the users editing them. Differs from <code>info</code> in that <code>check</code> returns a meaningful exit status and displays no report if no files are being edited.

Table 6–4: Summary of sccs Command Functions (cont.)

Command Name	Low Level	Description
clean	No	Removes from your directory all files that can be regenerated from the named s-file.
create	No	Creates an s-file without removing the g-file.
deledit	No	Performs a <code>delta</code> operation followed by an <code>edit</code> operation on the same file.
delget	No	Performs a <code>delta</code> operation followed by a <code>get</code> operation on the same file.
delta	Yes	Checks an edited g-file back into the library, recording the changes made and their history. Removes the p-file.
diffs	No	Compares a g-file that is checked out for editing with an earlier version reconstructed from the s-file.
edit	No	Checks out an s-file for editing; regenerates the g-file and places it in your directory. Creates a p-file.
fix	No	Removes the most recent delta and presents the g-file for reediting. Same as entering <code>rmDEL</code> followed by <code>edit</code> .
get	Yes	Regenerates a g-file, usually but not always for a purpose other than editing. (The <code>sccs edit</code> command, which duplicates the function of <code>sccs get -e</code> , is the usual way to regenerate a g-file for editing.)
help	Yes	Given a command name or an SCCS message number, displays information about that item. (The individual command's form is <code>sccshelp</code> .) Each SCCS message has an identification code; for example, the "no ID keywords" message's code is <code>cm7</code> . The <code>sccs help cm7</code> command displays a description of this error. The <code>sccshelp delta</code> command returns a syntax diagram for the <code>delta</code> command.
info	No	Reports on files being edited and the names of the users editing them.
print	No	Displays the revision histories of the named file or files, then displays the SCCS file, with ID information added to the beginning of each line.
prs	Yes	Displays the revision histories of the named file or files.
prt	No	Same as <code>prs</code> .
rmDEL	Yes	Removes the most recent delta from the specified branch of a named s-file.
sccsdiff	Yes	Compares two versions of the s-file. Requires explicit specification of the s-file name.

Table 6–4: Summary of sccs Command Functions (cont.)

Command Name	Low Level	Description
tell	No	Reports on files being edited. Differs from <code>info</code> in that only file names are reported.
unedit	No	Aborts editing of a g-file. Deletes the p-file, releasing the s-file so that other users can check it out. If the g-file is present in your working directory, <code>sccs unedit</code> removes it and performs a <code>get</code> command on the s-file; if no g-file is present, no <code>get</code> command is executed. (Equivalent to the <code>unget</code> command.)
what	Yes	Searches a file for an SCCS ID pattern and displays the text that follows it.

6.6.1 Placing New Files in an SCCS Library

You can use the `sccs create` command to place new files in a library. The following example assumes that you are in the library's parent directory and want to add the `attr` file to the library:

```
% sccs create attr
attr:
1.1
141 lines
```

Do not include the prefix `s.` in the file name you specify; SCCS applies it automatically.

You can enter a series of files in a single operation. For example:

```
% sccs create attr docbld dcb.ch-intro
```

After creating the s-file in the library, the `sccs create` command adds a comma as a prefix to the name of the original file; for example, `attr` becomes `,attr`. This action preserves the original g-file with its keywords (if any) unexpanded. Then SCCS fetches a copy of the file by using a `get` command; this fetched version is ready for distribution.

You can also insert files in the library with the `sccs admin -i` command, using the following syntax:

```
sccs admin -i [[path/]] [input-file] [[path/]] [s-filename]
```

For example:

```
% sccs admin -iunstamp unstamp
```

The name `path/input-file` specifies the input file. Regardless of the name of this file, the s-file will be named `s.s-filename`. Do not include any white space between the `-i` option and `path/input-file`. Do not include the prefix `s.` in `s-filename`; SCCS applies it automatically. Using

the `admin -i` command avoids the renaming of the original g-file and the fetching of a version with expanded keywords. See Section 6.6.8 for more information on using the `admin` command.

You can use the `admin -i` option to enter several files with a short shell script; the following command-line example is implemented in `csch`:

```
% foreach x (attr docbld dcb.ch-intro)
? sccs admin -i$x $x
? end
```

6.6.2 Recording File-Identification Information with SCCS

The SCCS system provides a syntax for including ID keywords in source files to provide file-identification information. An ID keyword consists of a single letter enclosed within percent signs (%). When you retrieve a file for any purpose other than editing, SCCS expands each ID keyword by replacing it with the appropriate information, such as the SID or the file name. Table 6-5 lists the SCCS ID keywords.

Table 6-5: SCCS ID Keywords

Keyword	Description
%B%	The branch number of a retrieved g-file
%C%	The current line number in the file, intended to identify messages output by a program
%D%	The retrieval date of a g-file retrieved by a <code>get</code> command in the form <i>yy/ mm/ dd</i>
%E%	The creation date of a delta, in the form <i>yy/ mm/ dd</i>
%F%	The file name of the s-file
%G%	The creation date of a delta, in the form <i>mm/ dd/ yy</i>
%H%	The retrieval date of a g-file retrieved by a <code>get</code> command, in the form <i>mm/ dd/ yy</i>
%I%	The highest SID applied to the file retrieved
%L%	The level number of a retrieved g-file
%M%	The current module (file) name; for example, <code>prog.c</code>
%P%	The full pathname of the s-file
%Q%	The value of the <code>q</code> flag in the s-file
%R%	The release number of a retrieved g-file
%S%	The sequence number of a retrieved g-file

Table 6–5: SCCS ID Keywords (cont.)

Keyword	Description
%T%	The retrieval time of a g-file retrieved by a <code>get</code> command, in the form <i>hh: mm: ss</i>
%U%	The creation time of a delta, in the form <i>hh: mm: ss</i>
%W%	A shorthand for %Z%%M% Tab %I%
%Y%	A placeholder for the value of the <code>t</code> flag (set by the <code>admin</code> command); not meaningful to SCCS itself
%Z%	A placeholder that expands to the string <code>@(#)</code> for the <code>what</code> command to find

SCCS handles ID keywords anywhere in a file. The purpose of the `SCCS what` command is to find and display expanded ID keywords in a file. The `what` command searches for lines containing the string `@(#)`, which is generated by the `%Z%` keyword or the `%W%` shorthand keyword, and displays those lines. For example:

```
% what /usr/bin/attr
/usr/bin/attr:
    attr 1.8 of 4/15/92
```

The line displayed in this example is part of a shell script and was coded as follows:

```
# SCCSID: %Z%%M% %I% of %G%
```

If your file does not contain ID keywords, SCCS reports that fact when you put the file in the library and when you retrieve it. You can set the file's `i` flag to specify that this condition will be a fatal error. (See Section 6.6.8 for a description of file flags.) The purpose of the `i` flag is to prevent a `delta` command from merging a g-file with expanded keywords (or with no keywords) with the s-file.

6.6.3 Getting Files from an SCCS Library

There are two reasons to get files from an SCCS library: for any use except editing, such as distribution, or for editing.

You can edit a file as part of the straight-line progress of its version history, or you can create a branching tree. Section 6.6.5 describes how to create a tree wherein multiple parallel versions are stored together in the same s-file.

6.6.3.1 Getting Files for Purposes Other Than Editing

For any use except editing, you get SCCS files with the `sccs get` command. For example:

```
% cd /usr/projects/dcb_tools
% sccs get attr
1.8
126 lines
```

This command creates a copy of the most recent version of the s-file with SCCS keywords expanded (see Table 6–5) and places it in your current directory (/usr/projects/dcb_tools in this example). To get a copy of any earlier version, use the `-rSID` option. For example, to retrieve version 1.5 of a file that is now at version 1.8, you would use a command like the following:

```
% cd /usr/projects/dcb_tools
% sccs get -r1.5 attr
1.5
128 lines
```

See Section 6.6.5 for information on managing more complex trees of SCCS files.

You can use the `-p` option to retrieve a file and write it to standard output instead of implicitly creating a g-file with the same name as the s-file. See the `get(1)` reference page for more information.

6.6.3.2 Getting Files for Editing

To edit a file, check it out of the library with the `sccs edit` command. For example:

```
% sccs edit attr
1.8
new delta 1.9
126 lines
```

This command creates a copy of the most recent version of the s-file with SCCS keywords unexpanded (see Table 6–5) and places it in your directory for editing. The command also creates a p-file identifying the person who checked out the file for editing.

You can check on the status of files with the `sccs info` command. For example:

```
% sccs info
unstamp: is being edited: 1.4 1.5 gunther 99/03/07 10:42:19
```

You can also use the `get -e` command to retrieve a file for editing.

6.6.3.3 Managing Multiple Files and New Releases

You can retrieve a series of files with a single `get` or `edit` command. For example:

```
% sccs get attr unstamp
SCCS/s.attr:
1.8
126 lines

SCCS/s.unstamp:
1.2
55 lines
```

If you specify the name `SCCS` instead of one or more file names, `SCCS` retrieves every `s`-file in the library.

To create a new release of a file, you fetch it using the `-r` option to specify the new release number in the `sccs edit` command. For example, the following command initiates Release 2 of the `docbld` file:

```
% sccs edit -r2 SCCS
SCCS/s.docbld:
1.50
new delta 2.1
1042 lines

SCCS/s.dcb_defaults:
1.50
new delta 2.1
63 lines

SCCS/s.dcb_diag.sed:
1.50
new delta 2.1
188 lines
```

6.6.4 Checking Edited Files Back into an SCCS Library

To replace a file in the library you have edited, use the `sccs delta` command. `SCCS` prompts you for a comment. For example:

```
% sccs delta attr

Comments? (^D to end)

Changed defaults check. Now looks only for "flc="

Ctrl/D

1.9
4 inserted
4 deleted
124 unchanged
```

If you specify the name `SCCS` instead of one or more file names, `SCCS` performs a `delta` on every `s`-file in the library. Coupled with a similar `edit` command, this function is useful for sets of files that must be kept in version synchronization even when not all of them are edited. `SCCS` asks for comments only once and applies the same comment to each file.

The `sccs delget` and `sccs delemit` commands perform a `delta` followed by a `get` or an `edit` operation respectively.

6.6.5 Working with Multiple Versions of Files

Section 6.3 provides an overview of branching concepts in a version control system. The following section provides specific examples that illustrate how SCCS handles branching of multiple versions of files.

Suppose two development teams begin development on separate versions of the `unstamp` file, beginning from SID 1.2. To enable branching, run the `sccs admin -fb` command as follows:

```
% sccs admin -fb unstamp
```

The first team uses an `edit` command to create version 1.3 as follows:

```
% sccs edit unstamp
1.2
new delta 1.3
55 lines
```

The second team uses an `edit -b` command to create a branch as follows:

```
% sccs edit -b unstamp
1.2
new delta 1.2.1.1
55 lines
```

Consider now a tree for the `unstamp` file with a main trunk and branches numbered 1.2.1, 1.2.2, and 1.3.1. To get the latest version from branch 1.2.2 for distribution, you would use the following command:

```
% sccs get -r1.2.2 unstamp
1.2.2.1
55 lines
```

As an SCCS tree becomes more complex, ensuring that you have the latest delta for editing can become cumbersome because you must know the delta you want to retrieve. You can use the `-t` option to the `sccs get` and `sccs edit` commands to specify the absolute latest delta regardless of its SID.

You can merge a branched SCCS file back into the main trunk by using the `sccs edit -i` command and by specifying the version or versions you want to merge. For example, the following command creates version 1.5 of the `unstamp` command, including all the deltas in the range from 1.2.1.1 to 1.2.1.3. The deltas are correlated so that the result is the accumulation of all specified changes.

```
% sccs edit -i1.2.1.1-1.2.1.3 unstamp
Included:
1.2.1.1
1.2.1.2
1.2.1.3
1.4
new delta 1.5
55 lines
```

6.6.6 Displaying Differences in SCCS Files

You can examine an SCCS file for differences between versions with either the `sccs diffs` command or the `sccsdiff` command, depending on what forms of the file are available.

The `sccs diffs` command compares the `g`-file with the specified version of the `s`-file. For example, to find the differences between the latest version of the `attr` file (1.8, being edited to become 1.9) and the immediately preceding version (1.7) you would use the following command:

```
% sccs diffs -r1.7 attr
----- attr -----
31d30
<# and is version-linked to the docbld command
```

To check the differences between versions 1.3 and 1.4 of the `attr` file, you would use the following command:

```
% sccs sccsdiff -r1.3 -r1.4 SCCS/s.attr
< uts=-04
---
> uts=-05
```

As this example shows, you can enter a pathname for the `s`-file itself. Because of this design, you can use this command from any directory instead of having to change to the directory containing the SCCS library.

6.6.7 Reporting Revision Histories of SCCS Files

Use the `sccs prs` command to examine the revision history of a file. For example:

```
% sccs prs unstamp
SCCS/s.unstamp:

D 1.2 99/03/20 11:23:36 gunther 2 1      00000/00006/00055 1
MRs:                                  2
COMMENTS:                             3
Fixed copyright notice

D 1.1 99/03/19 09:39:11 gunther 1 0      00061/00000/00000
MRs:
COMMENTS:
date and time created 99/03/19 09:39:11 by gunther
```

The `D`, `MRs`, and `COMMENTS` keywords indicated by callouts in this display are part of the complete set of SCCS keywords. Use the `sccs help` command to display a list of the keywords and their meanings.

- 1** The `D` keyword marks delta information. The two numbers after `gunther`(the programmer's user name) indicate the new and old revision levels. The slash-separated numbers indicate the numbers of lines added, deleted, and left unchanged.

- 2 The `MRS` keyword lists major revisions; the major revision is the first element of a file's SID.
- 3 The `COMMENTS` keyword provides a place for historical information in freeform text format.

Use the `sccs get -m` command to retrieve a copy of the file with SID numbers added as a prefix to each line. A file retrieved in this way shows you what delta produced every line in the retrieved version. Keep in mind that a given delta can be overlaid by later deltas; you might need to use the `-r` option to find particular changes.

6.6.8 Performing Administrative Functions

The `sccs admin` command performs several administrative functions. Each function is specified by an option to the `admin` command, as described in Table 6-6.

Note

Your system administrator can set permissions so that only the administrator can use the `admin` command.

Table 6-6: SCCS admin Command Options

Option	description
<code>-auser s-file</code>	Adds the specified user to the list of users allowed to make changes to the named s-file. The user name can be a group ID; all users in that group are added.
<code>-dflag s-file</code>	Turns off (deletes) the named flag in the s-file.
<code>-euser s-file</code>	Removes the specified user from the list of users allowed to make changes to the named s-file. The user name can be a group ID; all users in that group are removed.
<code>-fflag s-file</code>	Turns on the named flag in the s-file.
<code>-h s-file</code>	Checks the structure of the named s-file and compares a newly computed checksum with the checksum that is stored in the s-file. This option helps you detect both accidental damage and damage caused by modifying SCCS files directly with non-SCCS commands.
<code>-iinput-file s-file</code>	Creates <code>SCCS/s.s-file</code> , using <code>input-file</code> as the initial contents. Differs from <code>sccs create</code> in that <code>admin -i</code> does not rename the g-file or fetch a copy of the s-file; the g-file is left untouched in your directory.

Table 6–6: SCCS admin Command Options (cont.)

Option	description
<code>-mMR-list s-file</code>	Specifies a list of Modification Request (MR) numbers to be inserted into the SCCS file as the reason for creating the initial delta.
<code>-ns-file</code>	Creates an empty s-file.
<code>-rSID s-file</code>	Specifies the initial SID when creating an s-file.
<code>-tfile s-file</code>	Adds the contents of <i>file</i> to the s-file, flagging it as added text. If <i>file</i> is omitted, any such added text is deleted. Useful for including documentation to ensure its distribution with the s-file.
<code>-y"comment" s-file</code>	Inserts the comment text in the initial delta in a manner identical to the workings of the <code>delta</code> command. The default comment, if the <code>-y</code> option is not used, is a line giving the date and time of the file's creation and the name of the user who created it.
<code>-z s-file</code>	Recomputes the s-file's checksum in case the file has been corrupted.

Caution

Using the `val` and `admin -z` commands to repair damaged s-files is risky and should be left to your system administrator or to a designated SCCS librarian.

The flags for the `admin -f` and `admin -d` options are described in Table 6–7.

Table 6–7: Flags for the admin Command

Flag	Description
<code>b</code>	Allows branches to be made using the <code>-b</code> flag to the <code>edit</code> command.
<code>cSID</code>	Specifies <i>SID</i> as the highest delta that a <code>get -e</code> command can use.
<code>dSID</code>	Specifies the default SID to be used on a <code>get</code> or <code>edit</code> command.
<code>fSID</code>	Specifies <i>SID</i> as the lowest delta that a <code>get -e</code> command can use.
<code>i</code>	Causes the “no Id keywords” error message to be a fatal error rather than a warning.
<code>j</code>	Permits editing of the s-file by more than one person concurrently.
<code>lSID [,SID. .]</code>	Locks the specified <i>SIDs</i> from being retrieved for editing. You can lock all deltas with the <code>-fla</code> flag, and you can unlock specific deltas with the <code>-d</code> flag.

Table 6–7: Flags for the admin Command (cont.)

Flag	Description
<i>mname</i>	Substitutes <i>name</i> for all occurrences of the %M% keyword when keywords are expanded by a <code>get</code> command. The default name is the s-file's name without the <i>s</i> prefix.
<i>n</i>	Causes the <code>delta</code> command to create a null delta in any releases that are skipped when a delta is made in a new release. For example, if you make delta 5.1 after delta 2.7, releases 3 and 4 will be null. The resulting null deltas can serve as points from which to build branch deltas. Without this flag, skipped releases do not appear in the s-file.
<i>q"text"</i>	Substitutes <i>text</i> for all occurrences of the %Q% keyword when keywords are expanded by a <code>get</code> command.
<i>ttype</i>	Substitutes <i>type</i> for all occurrences of the %Y% keyword when keywords are expanded by a <code>get</code> command.
<i>v[program]</i>	Makes delta prompt for Modification Request (MR) numbers as the reason for creating a delta. The name <i>program</i> specifies the name of an MR number validity-checking program. (See the <code>delta(1)</code> reference page.)

For example, the following command uses the contents of an existing text file to create an s-file beginning at SID 2.1 and identified with a comment. The s-file's *i* flag is set. The command places the resulting s-file in the SCCS library under the user's working directory.

```
% sccs admin -iunstamp -fi -r2 -y"Initial release" unstamp
```

This example does not destroy the original file.

6.6.9 Using SCCS Options

The `sccs` command supports the options listed in Table 6–8. These options must include the SCCS function command keyword as shown in the examples in the table. Do not include any space between the options and their arguments.

Table 6–8: SCCS Command Options

Option	Description
<code>-ddirname</code>	<p>Specifies a directory to use as the SCCS library's parent. Allows access to SCCS libraries without requiring that your working directory be the parent. For example:</p> <pre>% pwd /usr/users/gunther % sccs -d/usr/src/dcb_tools get attr 1.8 126 lines</pre>
<code>-ppath</code>	<p>Adds <code>path</code> to the final element of the pathname for the file you specify. By default, SCCS adds <code>SCCS</code> so that the path specified in the <code>-d</code> example resolves to <code>/usr/src/dcb_tools/SCCS/s.attr</code>. If your SCCS library is not named <code>SCCS</code>, use the <code>-d</code> option to modify this component of the path.</p>
<code>-r</code>	<p>Runs with the real user's UID instead of changing to the <code>sccs</code> UID. For security purposes, SCCS usually sets the ownership of files in an SCCS library so that they belong to the <code>sccs</code> UID. This option is useful if you are using SCCS to manage a library for yourself only; you can create the <code>SCCS</code> directory with normal permissions, and the <code>-r</code> option will cause SCCS to manipulate files therein using your own UID.</p>

6.6.10 Summary of Individual SCCS Commands

Table 6–9 provides a brief description of the individual SCCS commands. Some of these commands are not supported by the `sccs` command. Refer to the appropriate command's reference page for more detailed information.

Table 6–9: Individual SCCS Commands

Command	Supported by <code>sccs</code> Command	Description
<code>admin</code>	Yes	Creates an s-file or changes some characteristic of an existing s-file.
<code>cdc</code>	No	Changes the comments associated with a delta.
<code>comb</code>	No	Combines two or more consecutive deltas of an s-file into a single delta. Combining deltas can reduce storage requirements.
<code>delta</code>	Yes	Checks an edited g-file back into the library, recording the changes made and their history. Removes the p-file.

Table 6–9: Individual SCCS Commands (cont.)

Command	Supported by sccs Command	Description
get	Yes	Gets a specified version of an s-file. Use this command to get a copy of a file to edit or compile. For editing, use the <code>get -e</code> command, which checks out an s-file for editing, regenerates the g-file and places it in your directory, and creates a p-file.
prs	Yes	Displays the revision histories of the named s-file or s-files.
rmDEL	Yes	Removes the most recent delta from the specified branch of a named s-file.
sccsdiff	Yes	Compares two versions of the s-file. Requires explicit specification of the s-file name.
sccshelp	No	Provides an explanation of a diagnostic message or of an SCCS command name.
unget	No	Removes the effect of a previous use of the <code>get -e</code> command by deleting the p-file and replacing the g-file with a copy having its ID keywords expanded. (Equivalent to the <code>sccs unedit</code> command.)
val	No	Computes a checksum on an s-file to see if the result matches the checksum stored in the file. Use this command with the <code>sccs admin -z</code> command to detect and repair corrupted files.
what	Yes	Searches a file for an SCCS ID pattern and displays the text that follows it. Use this command to find identifying information describing the source versions (kept under SCCS control) used to construct a program.

Caution

Using the `val` and `admin -z` commands to repair damaged s-files is risky and should be left to your system administrator or to a designated SCCS librarian.

6.7 Functional Comparison of RCS and SCCS Commands

Table 6–10 provides a brief comparison of the operations of RCS and SCCS and the commands that are used to achieve similar functions. Refer to the reference pages for detailed information on using the individual commands.

Table 6–10: Functional Comparison: RCS and SCCS Commands

Tasks	RCS Command	SCCS Commands
Create a new file from your original.	<code>ci file</code>	<code>sccs create file</code> <code>sccs admin -isfile gfile</code> <code>admin -ipath/sfile gfile</code>
Get a copy of a file with expanded keywords.	<code>co -u file</code>	<code>sccs get file</code> <code>get file</code>
Get a copy of a file with unexpanded keywords.		<code>sccs get -k file</code> <code>get -k file</code>
Check out a file.	<code>co -l file</code>	<code>sccs edit file</code> <code>get -e file</code>
Check in an edited file.	<code>ci file</code>	<code>sccs delta file</code> <code>delta file</code>
Show revision histories of a file.	<code>rlog file</code>	<code>sccs prs file</code> <code>prs file</code>
Examine differences between file revisions.	<code>rcsdiff -rrev file</code>	<code>sccs diffs -rrev file</code> <code>sccsdiff -rrev -rrev file</code>
Merge file revisions.	<code>rcsmmerge -rrevs file</code>	<code>sccs edit -irevs file</code>
Find identifying information.	<code>ident</code>	<code>sccs what</code> <code>what</code>
Perform administrative tasks.	<code>rcs</code>	<code>admin</code>
Clean up your directory. (Remove unchanged files.)	<code>rcsclean</code>	<code>sccs clean</code>

7

Building Programs with the make Utility

The `make` utility builds up-to-date versions of programs. It is most useful for large programming projects in which multiple source files are combined to form a single program or for building a set of programs that are part of a single product or application.

This chapter explains the following information:

- Operation of the `make` utility
- Description files

The `make` command accepts options to control or modify how the building process is performed. The `make` utility does not address the problem of maintaining more than one version of the same source file.

By using the `make` utility to maintain programs, you can do the following:

- Combine the instructions for creating a large program in a single file
- Define macros to use within the `make` description file
- Use shell commands
- Create or update libraries
- Include files from other programs

The operating system provides several versions of the `make` command; this chapter describes the default version, `make(1)`. The other versions, both of which offer features provided by `make(1)`, are `make(1u)` and `make(1p)`. In addition to its extended feature set, the `make(1p)` version is POSIX compliant.

The `make(1)` and `make(1u)` versions are included in the base operating system subsets. The `make(1p)` version is included in the “Software Development Environment (Software Development)” subset.

Refer to the `make(1)`, `make(1u)` and `make(1p)` reference pages for further information.

7.1 Operation of the make Utility

The `make` utility works by comparing the creation date of a program to be built, called the **target** or **target file**, with the dates of the files that make it up, called **dependency files** or **dependents**. If any of a given target's

dependents are newer than the target, `make` considers that the target is out of date. In this case, `make` rebuilds the target by performing the necessary compiling, linking, or other steps. Each dependent can also be a target; for example, an executable program is made from object modules, which are in turn made from source files. Dependents that are newer than the target are called **younger** files.

The `make` utility uses the following sources of information:

- A description file that you create
- File names
- Time stamps of the files from the file system
- A set of rules that tell `make` how to build files

The `make` utility depends on files' time stamps. For `make` to work properly on a distributed system, the date and time on all systems in the network must be synchronized.

The `make` utility creates a target file using the following step-by-step procedure:

1. Finds the name of the target file in the description file
2. Finds a line that describes the dependents of the target, called a **dependency line**
3. Ensures that all the target's dependency files exist and are up to date
4. Determines if the target is current with respect to its dependents
5. Creates the target by one of the following methods if the target or one of the dependents is out of date:
 - Executes commands from the description file
 - Uses internal rules to create the file (if they apply)
 - Uses default rules from the description file

If all files described on the dependency line are up to date when `make` is run, `make` indicates that the target is up to date and then stops. If any dependents are newer than their targets, `make` recreates only those targets that are out of date. Any missing files are deemed to be out of date.

If a given target has no dependents, it is always out of date, and `make` rebuilds it every time you run `make`. The `make` process works from the top down in determining what targets need to be rebuilt and from the bottom up in the actual rebuilding stage.

When the `make` utility runs commands to create a target, it replaces macros with their values, echoes each command line to the standard output, and

then runs the command. (See Section 7.2.9 for information about macros.) The `make` utility runs commands that it can execute directly, such as `rm` or `cc`, without invoking a new shell. The utility invokes each command line that includes shell functions, such as pipes or redirection, in a new shell.

You start the `make` utility in the directory that contains the description file. The syntax of the `make` command is as follows:

```
make [[-f ]makefile] [options] [targets] [macro definitions]
```

The `make` utility examines the command line entries to determine what to do. First, it assigns values for the macro definitions on the command line (entries containing equal signs), if there are any, and for the macro definitions in the description file. If there is a definition on the command line for a macro name that is also defined in the description file, `make` uses the command line definition and ignores the definition in the description file.

Next, `make` looks at the options. Refer to the `make(1)` reference page for a complete list of the options that `make` supports.

The `make` utility interprets the remaining command line entries as the names of targets. It processes the targets in left-to-right order. If there are no targets on the command line, `make` processes the first target named in the description file and then stops.

7.2 Description Files

The description file tells `make` how to build the target by defining what dependencies are involved and what their relationships are to the other files in the procedure. The description file contains the following information:

- Definitions of macros in the description file
- One or more target names
- Dependency file names that make up the target files
- Commands that create the target files from the dependents
- Any of the pseudotargets `.DEFAULT`, `.IGNORE`, `.PRECIOUS`, `.SILENT`, or `.SUFFIXES`. These identifiers are called pseudotargets because they are not real targets. They are built-in names that `make` interprets in special ways. For example, the `.SILENT` pseudotarget instructs `make` not to echo command lines as it runs them. Do not use any of these names for a real target. Refer to the `make(1)` reference page for additional information on pseudotargets.

The `make` utility determines what files to create to get an up-to-date copy of the target by checking the dates of the dependency files. If any dependency file was changed more recently than the target, `make` creates all the files

that are affected by the change, including the target. In most cases, the description file is easy to write and does not change often.

The `make` utility usually looks for a description file named either `makefile` or `Makefile`. If you name the description file `makefile` or `Makefile` and are working in the directory containing that description file, you enter the `make` command without any options or arguments to bring the first target and its dependency files up to date, regardless of the number of files that were changed since the last time `make` created the target file. You can override the default file name by using the `-f` option to the `make` utility to specify the name of the desired description file, as in the following example:

```
% make -f my_makefile
```

This option lets you keep several description files in the same directory.

This section explains the description file:

- Format of a description file entry
- Using commands in a description file
- Preventing the `make` utility from echoing commands
- Preventing the `make` utility from stopping on errors
- Defining default conditions
- Preventing `make` from deleting files
- Simple description file
- Making the description file simpler
- Defining macros
- Using macros in a description file
- Calling the `make` utility from a description file
- Internal macros
- How `make` uses environment variables
- Internal rules
- Including other files
- Testing description files
- Description file

7.2.1 Format of a Description File Entry

The general format of a description file entry is as follows:

```
[ target1 [ target2... ] [:] [[:]] [[ dependent... ] [[:] ] commands] [[#  
] comment...]
```

The items inside brackets are optional. Targets and dependents are file names (strings of letters, numbers, periods, and slashes). The `make` command recognizes wildcard characters, such as asterisks (*) and question marks (?). Each line in the description file that contains a target name is called a dependency line. The dependency line is followed by one or more command lines that specify the process steps to create the target.

Because `make` uses the dollar sign (\$) to designate a macro, you must not use this character in file names of targets and dependencies. Similarly, do not use the dollar sign in commands in the description file unless you are referring to a defined `make` macro. (Macros are described in Section 7.2.9, Section 7.2.10, and Section 7.2.12.)

To place comments in the description file, use a number sign (#) to begin the comment text. The `make` utility ignores the number sign and all characters on the same line after the number sign. The `make` utility also ignores blank lines.

You can enter lines that are longer than the line width of the input device by putting a backslash (\) at the end of the line that is to be continued. Do not extend comment lines in this way; begin each new comment line with its own number sign.

7.2.2 Using Commands in a Description File

A command is any string of characters, except a number sign or a newline character. Commands can appear after a semicolon (;) on a dependency line or on lines immediately following a dependency line. Each command line after the dependency line must begin with a single tab character.

When you define command sequences for the targets in the description file, either specify one command sequence for each target or specify separate command sequences for special sets of dependencies.

To use one command sequence for every use of the target, use a single colon (:) following the target name on the dependency line. For example, the following lines define a target, `test`, with a set of dependency files and a set of commands to create the target:

```
test:  dependency list1...
      command list...
:
test:  dependency list2...
```

As shown here, a target name can appear in several places in the description file with different dependency lists, but there can be only one command list associated with the target name. The `make` utility finds all the dependency

lines for a given target and concatenates all their dependency lists into a single list. When any of the dependents have been changed, `make` can run the commands in the one command list to create the target.

To specify more than one set of commands to create a particular target file, enter more than one dependency definition. Each dependency line must have the target name followed by two colons (`::`), a dependency list, and a command list that `make` uses if any of the files in the dependency list changes. For example, the following lines define two separate processes to create the target file `test`:

```
test:: dependency list1...
        command list1...
:
test:: dependency list2...
        command list2...
```

If any of the files in dependency `list1` changes, `make` runs `command list1`; if any of the files in dependency `list2` changes, `make` runs `command list2`. To avoid conflicts, a given dependency file cannot appear in both dependency `list1` and dependency `list2`.

Note

Because `make` runs the commands on each command line independently of preceding or subsequent command lines, be careful when using certain commands (for example, `cd`). In the following example, the `cd` command has no effect on the `cc` command that follows it:

```
test: test.o
      cd /u/tom/newtest
      cc main.o subs.o -o test
```

To make the `cd` command affect the `cc` command, place both commands on the same line, separated by a semicolon. For example:

```
test: test.o
      cd /u/tom/newtest; cc main.o subs.o -o test
```

You can simulate a multiline shell script by using backslashes on continued lines:

```
test: test.o
      cd /u/tom/newtest; \
      cc main.o subs.o -o test
```

This example works exactly the same as the one immediately before it. Each line continued with a backslash (the `cd` line in this example) must have a semicolon before the backslash.

7.2.3 Preventing the make Utility from Echoing Commands

To prevent `make` from echoing the commands that it is executing to standard output, use any one of the following procedures:

- Use the `-s` flag on the command line when you enter the `make` command.
- Put the pseudotarget name `.SILENT:` on a line by itself in the description file. See Section 7.2 for an explanation of pseudotargets.
- Put an at sign (`@`) in the first character position (after the tab) of each command line in the description file that `make` should not echo.

7.2.4 Preventing the make Utility from Stopping on Errors

The `make` utility usually stops if any command returns a nonzero status code to indicate an error.

To prevent `make` from stopping on errors, use any of the following procedures:

- Use the `-i` flag on the command line when you enter the `make` command.
- Put the pseudotarget name `.IGNORE:` on a line by itself in the description file. See Section 7.2 for an explanation of pseudotargets.
- Put a hyphen (`-`) in the first character position (after the tab) of each command line in the description file where `make` should not stop on errors.

7.2.5 Defining Default Conditions

When `make` creates a target but cannot find either explicit command lines or internal rules to create the file, it looks at the description file for default conditions. To define the commands that `make` performs in this case, use the `.DEFAULT:` pseudotarget name in the description file, entering the default command sequence as for any other target.

Use the `.DEFAULT:` pseudotarget for an error recovery routine or for a general procedure to create all files in the program that are not defined by an internal rule of the `make` utility.

7.2.6 Preventing make from Deleting Files

To prevent completion of a build using potentially corrupted target files, `make` usually removes target files if an error is returned during the build.

To prevent `make` from removing files when an error is detected, use the `.PRECIOUS` pseudotarget in the description file. After the pseudotarget name, list the target names to be saved. If you specify the `-u` option on the command line, `make` does not remove any RCS files it checked out. See the `make(1)` reference page for more information on how `make` interacts with RCS.

7.2.7 Simple Description File

In Example 7–1, a program named `prog` is made by compiling and loading three C language files: `x.c`, `y.c`, and `z.c`. The files `x.c` and `y.c` share some declarations in a file named `defs`. The `z.c` file does not share those declarations.

Example 7–1: A Simple Description File

```
# Make prog from 3 object files
prog: x.o y.o z.o
# Use the cc program to make prog
    cc x.o y.o z.o -o prog

# Make x.o from 2 other files
x.o: x.c defs
# Use the cc program to make x.o
    cc -c x.c

# Make y.o from 2 other files
y.o: y.c defs
# Use the cc program to make y.o
    cc -c y.c

# Make z.o from z.c
z.o: z.c
# Use the cc program to make z.o
    cc -c z.c
```

If this file is called `makefile`, you can enter the `make` command with no options or arguments to make an up-to-date copy of `prog` after making changes to any of the four source files `x.c`, `y.c`, `z.c`, or `defs`.

7.2.8 Making the Description File Simpler

To make the description file simpler, use the internal rules of the `make` utility. Using file system naming conventions, `make` knows that there are three `.c` files corresponding to the needed `.o` files. It also knows how to generate an object from a source file (that is, issue a `cc -c` command). By taking advantage of these internal rules, the description file becomes the following:

```

# Make prog from 3 object files
prog: x.o y.o z.o
# Use the cc program to make prog
    cc x.o y.o z.o -o prog

# Use the file defs and the appropriate .c file
# when making x.o and y.o
x.o y.o: defs

```

Section 7.2.14 describes the internal rules used by make.

7.2.9 Defining Macros

A macro is a name to use in place of one or more other names. It is a shorthand way of using the longer string of characters. You can define macros in the description file or on the command line. To define a macro in the description file, do the following:

1. Start a new line with the name of the macro.
2. Follow the name with an equal sign (=).
3. To the right of the equal sign, enter the string of characters that the macro name represents. The string can contain blanks.

The macro definition can contain blanks before and after the equal sign without affecting the result. The macro definition cannot contain a colon (:) or a tab before the equal sign. The make utility ignores leading and trailing blanks in the defining string. The following examples are macro definitions:

```

# Macro ABC has a value of "ls -la"
ABC = ls -la

# Macro LIBES has a null value
LIBES =

# Macro DIRECT includes the definition of macro ROOT
# The expanded value of DIRECT is "/usr/home/fred"
ROOT  = /usr/home
DIRECT = $(ROOT)/fred

```

The `DIRECT` macro in this example uses another definition as part of its own definition. See Section 7.2.10 for instructions on using macros.

To define a macro on a command line, follow the same syntax as for defining macros in the description file, but include all of your macro definitions on the same line. When you define a macro with blanks from the command line, enclose the definition in quotation marks ("name = definition"). Without the quotation marks, the shell interprets the blanks as parameter separators and not as part of the macro.

7.2.10 Using Macros in a Description File

After you define a macro in a description file, refer to the macro's value in the description file by putting a dollar sign (\$) before the name of the macro. If the macro name is longer than one character, put parentheses or braces around it, as illustrated by the following examples:

```
$(CFLAGS)
${xy}
$Z
$(Z)
```

The effect of the last two examples is identical.

7.2.10.1 Macro Substitution

You can substitute a different value for part or all of a macro's defined value. The three forms of macro substitution are as follows:

- The first form replaces every occurrence of *string1* in the defined value of *MACRO* with *string2*:

```
[$(MACRO: string1= string2)]
```

For example:

```
# Define macro MAC1
MAC1 = xxx yyy zzz
:

# Evaluate MAC1
project:
    @ echo $(MAC1:yyy=abc)
```

When you run `make` with this description file, `make` substitutes `abc` for the occurrence of `yyy`, and displays the following line:

```
xxx abc zzz
```

- The second form applies a substitution to each word in the defined value. The *location* parameter specifies what portion of the word is to be replaced with *string*:

```
[$(MACRO/ location/ string)]
```

The *location* parameter is restricted to the following values:

- Circumflex (^) - The *string* value is added as a prefix to each defined word. For example:

```
# Define macro MAC1
MAC1 = abc def ghi
:
```



```
# Evaluate MAC1
project:
    @ echo $(MAC1/^/xyz)
```

When you run make with this description file, make adds xyz to the beginning of each defined word and displays the following line:

```
xyzabc xyzdef xyzghi
```

- **Asterisk (*)** – The *string* value replaces all of each defined word. For example:

```
# Define macro MAC1
MAC1 = abc def ghi
```

```
:
```

```
# Evaluate MAC1
project:
    @ echo $(MAC1/*/xyz)
```

When you run make with this description file, make substitutes xyz for each defined word and displays the following line:

```
xyz xyz xyz
```

With the asterisk, you can use an ampersand (&) in the *string* value. The ampersand represents the defined word that is being substituted for, and it causes that word to be interpolated in the result. For example:

```
# Define macro MAC1
MAC1 = abc def ghi
```

```
:
```

```
# Evaluate MAC1
project:
    @ echo $(MAC1/*/x&z)
```

When you run make with this description file, make substitutes x&z for each defined word, interpolating the defined word for the ampersand, and displays the following line:

```
xabcz xdefz xghiz
```

- **Dollar sign (\$)** - The *string* value is appended to each defined word. For example:

```
# Define macro MAC1
MAC1 = abc def ghi
```

```
:
```

```
# Evaluate MAC1
project:
    @ echo $(MAC1/$/xyz)
```

When you run `make` with this description file, `make` appends `xyz` to the end of each defined word and displays the following line:

```
abcxyz defxyz ghxyz
```

- The third form makes one of two possible substitutions depending on whether `MACRO` is defined:

```
[$(MACRO? string1: string2)]
```

If `MACRO` is defined, `string1` is substituted for the entire defined value. If `MACRO` is not defined, `string2` is used. For example:

```
# Define macro MAC1
MAC1 = abc def ghi
:

# Evaluate MAC1 and MAC2.  MAC2 is not defined.
project:
    @ echo $(MAC1?uvw:xyz)
    @ echo $(MAC2?123:456)
```

When you run `make` with this description file, `make` substitutes `uvw` for the value of `MAC1` and `456` for the undefined `MAC2`, and displays the following lines:

```
uvw
456
```

The first two forms of substitution produce a null string if `MACRO` is undefined.

7.2.10.2 Conditional Macros

The value of a macro can be assigned based on a preexisting condition. This type of macro is a conditional macro. You cannot define conditional macros on the command line; all conditional macro definitions must be in the description file. The syntax of the conditional macro is as follows:

```
[target:=MACRO= string]
```

The macro is assigned the value of the string if the specified target is the current target of the `make` command. Otherwise, the macro's value is null. The following description file uses a conditional substitution for `MAC1`:

```
# Define the conditional macro MAC1
target2:=MAC1 = xxx yyy xxxyyy
:

#list targets and command lines
#
target1:;@echo $(MAC1)
target2:;@echo $(MAC1)
```

When you run `make` with this description file, you get the following results:

```
% make target1
% make target2
xxx yyy xxxyyy
```

7.2.11 Calling the make Utility from a Description File

You can nest calls to the `make` utility within a `make` description file by including the `$(MAKE)` macro in one of the command lines in the file. If this macro is present, `make` executes another copy of `make`, even if the `-n` option is set. See Section 7.2.16 for a description of the `-n` option.

7.2.12 Internal Macros

The `make` utility has built-in macro definitions for use in the description file. These macros help specify variables in the description file. The `make` utility replaces the macros with the values indicated in Table 7-1.

Table 7-1: Internal make Macros

Macro	Value
<code>\$\$@</code>	The name of the current target file
<code>\$\$\$@</code>	The target names on the dependency line
<code>\$\$?</code>	The names of the dependency files that have changed more recently than the target
<code>\$\$<</code>	The name of the out-of-date file that caused a target file to be created
<code>\$\$*</code>	The name of the current dependency file without the suffix

Each of these macros resolves to a single file name at the time `make` is actually using it. You can modify the interpretation of any of these macros by using a `D` suffix to indicate that you want only the directory portion of the name. For example, if the current target is `/u/tom/bin/fred`, the `$(@D)` macro returns only the `/u/tom/bin` portion of the name. Similarly, an `F` suffix returns only the file name portion. For example, the `$(@F)` macro returns `fred` if given the same target. All internal macros except the `$$?` macro can take the `D` or `F` suffix.

Before using any internal macros on a distributed file system, you must ensure that the system clocks show the same date and time for all nodes that contain files for `make` to process.

The `make` utility replaces these symbols only when it runs commands from the description file to create the target file. The following sections explain these macros in more detail.

7.2.12.1 Internal Target File Name Macro

The `make` utility substitutes the full name of the current target for every occurrence of the `$$@` macro in the command sequence for building the target. The replacement is made before running the command. For example:

```
/u/tom/bin/test: test.o
                cc test.o -o $$@
```

This example produces an executable file named `/u/tom/bin/test`.

7.2.12.2 Internal Label Name Macro

If the `$$@` macro is used on the right side of the colon on a dependency line in a description file, `make` replaces this symbol with the label name that is on the left side of the colon in the dependency line. This name could be a target name or the name of another macro. For example:

```
cat: $$@.c
```

The `make` utility interprets this line as follows:

```
cat: cat.c
```

Use this macro to build a group of files, each of which has only one source file. For example, to maintain a directory of system commands, use a description file like the following:

```
# Define macro CMDS as a series of command names
CMDS = cat dd echo date cc cmp comm ar ld chown

# Each command depends on a .c file
$(CMDS): $$@.c

# Create the new command set by compiling the out of
# date files ($?) to the current target file name ($@)
                cc -O $? -o $$@
```

The `make` utility changes the `$$(@F)` macro to the file part of `$$@` when it runs. For example, you could use this symbol when maintaining the `usr/include` directory while using a description file in another directory. That description file would look like the following example:

```
# Define directory name macro INCDIR
INCDIR = /usr/include

# Define a group of files in the directory
# with the macro name INCLUDES
INCLUDES = \
            $(INCDIR)/stdio.h \
            $(INCDIR)/pwd.h \
            $(INCDIR)/dir.h \
            $(INCDIR)/a.out.h
```

```
# Each file in the list depends on a file
# of the same name in the current directory
$(INCLUDES):      $$(@F)
```

```
# Copy the younger files from the current
# directory to /usr/include
cp $? @$
```

```
# Set the target files to read only status
chmod 0444 @$
```

This description file creates a file in the `/usr/include` directory when the corresponding file in the current directory has been changed.

7.2.12.3 Internal Younger Files Macro

If the `$?` macro is in the command sequence in the description file, `make` replaces the symbol with a list of dependency files that have been changed since the target file was last changed.

7.2.12.4 Internal First Out-of-Date File Macro

If the `$<` macro is in the command sequence in the description file, `make` replaces the macro with the name of the first file that started the file creation. This file name is the name of the specific dependency file that was out of date with the target file and therefore caused `make` to create the target file again. This is different from the `$?` macro, which returns a complete list of younger files.

The `make` utility replaces this symbol only when it runs commands from its internal rules or from the `.DEFAULT:` list. The symbol has no effect in an explicitly stated command line.

7.2.12.5 Internal Current File Name Prefix Macro

If the `$*` macro is in the command sequence in the description file, `make` replaces the symbol with the file name part (without the suffix) of the dependency file that `make` is currently using to generate the target file. For example, if `make` is building the target `test.c`, the `$*` symbol represents the file name `test`.

The `make` utility replaces this symbol only when it runs commands from its internal rules or from the `.DEFAULT:` list. The symbol has no effect in an explicitly stated command line.

7.2.13 How make Uses Environment Variables

Each time `make` runs, it reads the current environment variables and adds them to its defined macros. In addition, it creates a new macro called `MAKEFLAGS`. This macro is a collection of all the options that were entered on the command line. Command line options and assignments in the description file can also change the value of the `MAKEFLAGS` macro. When `make` starts another process, it exports `MAKEFLAGS` to that process. See Section 7.2.16 for a discussion of how the `MAKEFLAGS` macro affects recursive `make` processes.

The `make` utility assigns macro definitions in the following order with later steps overriding earlier ones where there are conflicts:

1. Reads the `MAKEFLAGS` environment variable to set options specified by the variable. If `MAKEFLAGS` is not present or is null, `make` sets its internal `MAKEFLAGS` macro to the null string. Otherwise, `make` assumes that each letter in `MAKEFLAGS` is an input option. The `make` utility uses these options (except for `-f`, `-p`, and `-r`) to determine its operating conditions.
2. Reads and sets the input flags from the command line. Any options specified explicitly on the command line are added to the settings from the `MAKEFLAGS` environment variable.
3. Reads macro definitions from the command line. These definitions override any definitions for the same names in the description file.
4. Reads the internal macro definitions.
5. Reads the environment, including the `MAKEFLAGS` macro. The `make` utility treats all environment variables as macro definitions and passes them to shells it invokes to execute commands.

7.2.14 Internal Rules

The `make` utility has a set of internal rules that it uses to determine how to build a target. You can override these rules by invoking `make` with the `-r` option; in this case, you must supply any rules that are required to build the targets in your description file. The internal rules contain a list of file name suffixes defined using the pseudotarget `.SUFFIXES:`, along with the rules that tell `make` how to create a file with one suffix from a file with another suffix. To see the complete list of conversions supported by `make`'s internal rules, run the following command:

```
% make -p | more
```

If you do not change the list by default, `make` understands the following suffixes:

Suffix	File Type
.o	Object file
.c	C source file
.e	efl source file
.r	Ratfor source file
.f or .F	FORTTRAN source file
.s	Assembler source file
.Y	yacc C source grammar
.Yr	yacc Ratfor source grammar
.Ye	yacc efl source grammar
.l	lex source grammar
.out	Executable file
.p	Pascal source file
.sh	Bourne shell script
.csh	C shell script
.h	C header file

You can add suffixes to this list by including a `.SUFFIXES:` line in the description file with one or more space-separated suffixes. For example, the following line adds the suffixes `.f77` and `.ksh` to the existing list. For example:

```
.SUFFIXES: .f77 .ksh
```

To erase `make`'s default list of suffixes, include a `.SUFFIXES:` line with no names on it. You can replace the default list with a completely new list by using first an empty list and then your new list:

```
.SUFFIXES:
.SUFFIXES: .o .c .p .sh .ksh .csh
```

Because `make` looks at the suffixes list in left-to-right order, the order of the entries is important. The preceding example ensures that `make` will look first for an object file, then a C source file, and so on.

The `make` utility uses the first entry in the list that satisfies the following two requirements:

- The entry matches input and output suffix requirements.
- The entry has a rule assigned to it.

If you add suffixes to the list that `make` recognizes, you must provide rules that describe how to build a target from its dependents. A rule looks like a

dependency line and the corresponding series of commands. The `make` utility creates the name of the rule from the two suffixes of the files that the rule defines. For example, the name of the rule to transform a `.r` file to a `.o` file is `.r.o`. Example 7-2 illustrates a portion of the standard default rules file.

Example 7-2: Default Rules File

```
# Create a .o file from a .c
# file with the cc program
.c.o
    $(CC) $(CFLAGS) -c $<

# Create a .o file from either a
# .e , a .r , or a .f
# file with the efl compiler
    $(EC) $(RFLAGS) $(EFLAGS) $(FFLAGS) -c $<

# Create a .o file from
# a .s file with the assembler
.s.o:

    $(AS) -o $@ $<

.y.o:
# Use yacc to create an intermediate file

    $(YACC) $(YFLAGS) $<
# Use cc compiler

    $(CC) $(CFLAGS) -c y.tab.c
# Erase the intermediate file

    rm y.tab.c
# Move to target file

    mv y.tab.o $@

.y.c:
# Use yacc to create an intermediate file

    $(YACC) $(YFLAGS) $<
# Move to target file

    mv y.tab.c $@
```

7.2.14.1 Single Suffix Rules

The `make` utility also has a set of single suffix rules to create targets with no suffixes, such as command files. The `make` utility has rules to change the following source files with a suffix to object files without a suffix:

Suffix	Source File Type
<code>.c</code>	From a C language source file
<code>.sh</code>	From a shell file

For example, to maintain a program like `cat` if all of the needed files are in the current directory, enter the following command:

```
% make cat
```

7.2.14.2 Overriding Built-In make Macros

The `make` utility uses macro definitions in its internal rules. To change these macro definitions, enter new definitions for those macros on the command line or in the description file. For commands and language processors, the `make` utility uses the following macro names:

Command or Function	Command Macro	Command Options or Other Macros
Archive program (<code>ar</code>)	AR	ARFLAGS
Archive table of contents creation		RANLIB
Assembler	AS	ASFLAGS
C Compiler	CC	CFLAGS
C libraries		LOADLIBS
RCS checkout	CO	COFLAGS
The copy command (<code>cp</code>)	CP	CPFLAGS
<code>efl</code> compiler	EC	EFLAGS
Linker command (<code>ld</code>)	LD	LDFLAGS
The <code>lex</code> command	LEX	LFLAGS
The <code>lint</code> command	LINT	LINTFLAGS
The <code>make</code> command	MAKE	
Recursive <code>make</code> calling flags		MAKEFLAGS
The <code>mv</code> command	MV	MVFLAGS
The <code>pc</code> command	PC	PFLAGS

Command or Function	Command Macro	Command Options or Other Macros
The <code>f77</code> compiler	RC	FFLAGS
Ratfor compiler flags		RFLAGS
The <code>rm</code> command	RM	RMFLAGS
For locating files related to dependency		VPATH
The <code>yacc</code> command	YACC	YFLAGS
The <code>yacc -e</code> command	YACCE	YFLAGS
The <code>yacc -r</code> command	YACCR	YFLAGS

For example, the following command runs `make`, substituting the `newcc` program in place of the previously defined C language compiler:

```
% make CC=newcc
```

Similarly, the following command tells `make` to optimize the final object code produced by the C language compiler.

```
% make "CFLAGS=-O"
```

To look at the internal rules that `make` uses, enter the following command from the Bourne shell:

```
$ make -fp -< /dev/null 2>/dev/null
```

The output appears on the standard output.

7.2.15 Including Other Files

You can include files in addition to the current description file by using the word `include` as the first word on any line in the description file. Follow the word with a blank or a tab and then the set of file names for `make` to include in the operation. For example:

```
include    /u/tom/temp /u/tom/sample
```

7.2.16 Testing Description Files

To test a description file, run `make` with the `-n` command option. This option instructs `make` to echo command lines without executing them. Even commands preceded by at signs (`@`) are echoed so that you can see the entire process as `make` would execute it. When the `-n` option is in effect, the `$(MAKE)` macro, unlike all other commands, is actually executed.

If the description file includes an instance of the `$(MAKE)` macro, `make` calls the new copy of `make` with the `MAKEFLAGS` macro's value set to the list of

options, including `-n`, that you entered on the command line. The new copy of `make` observes that the `-n` option is set, and it bypasses command execution in the same way as the copy that called it. You can test a set of description files that use recursive calls to `make` by entering a single `make` command.

7.2.17 Description File

Example 7-3 shows the description file that maintains the `make` utility. The source code for `make` is contained in a number of C language source files and a `yacc` grammar file. For more information on `yacc`, see Chapter 4.

Example 7-3: The makefile for the make Utility

```
# Description file for the Make program

# Macro def: send to be printed
P = lpr

# Macro def: source file names used
FILES = Makefile version.c defs main.c

        doname.c misc.c files.c
        dosy.c gram.y lex.c gcos.c

# Macro def: object file names used
OBJECTS = version.o main.o doname.o \
        misc.o files.o dosys.o gram.o

# Macro def: lint program and flags
LINT = lint -p

# Macro def: C compiler flags
CFLAGS = -O

# make depends on the files specified
# in the OBJECTS macro definition
make:    $(OBJECTS)
# Build make with the cc program
        cc $(CFLAGS) $(OBJECTS) -o make
# Show the file sizes
        size make

# The object files depend on a file
# named defs
$(OBJECTS):  defs

# The file gram.o depends on lex.c
# uses internal rules to build gram.o
gram.o:  lex.c
```

Example 7-3: The makefile for the make Utility (cont.)

```
# Clean up the intermediate files
clean:
    rm *.o gram.c

# Copy the newly created program
# to /usr/bin and deletes the program
# from the current directory
install:
    cp make /usr/bin/make ; rm make

# Empty file 'print' depends on the
# files included in the macro FILES
print: $(FILES)
# Print the recently changed files
    lpr $?
# Change the date on the empty file,
# print, to show the date of the last
# printing
    touch print

# Check the date of the old
# file against the date
# of the newly created file
test:
    make -dp | grep -v TIME >1zap
    /usr/bin/make -dp | grep -v TIME >2zap
    diff 1zap 2zap
    rm 1zap 2zap

# The program, lint, depends on the
# files that are listed
lint: dosys.c doname.c files.c main.c misc.c \
    version.c gram.c
# Run lint on the files listed
# LINT is an internal macro
    $(LINT) dosys. doname.c files.c main.c \
    misc.c version.c gram.c
    rm gram.c

# Archive the files that build make
arch:
    ar uv /sys/source/s2/make.a $(FILES)
```

Glossary

This glossary defines terms used in this manual.

C

carriage return

A character that forces all following text to the left margin of the next line or that signals the end of user input. The Return key is usually used to produce a carriage return. The carriage return character is the default record separator for record-oriented programs such as `awk`.

check in

In the Revision Control System (RCS), to store a file or revision in the RCS library.

check out

In the Revision Control System (RCS), to retrieve a file or revision from the RCS library.

collating symbol

In a regular expression, a name that defines a particular subset of the available characters, such as lowercase characters, in a collating sequence that uses multicharacter strings to represent single characters.

D

delta

In a Revision Control System (RCS) or Source Code Control System (SCCS) file, the set of changes that constitute a specific version of the file.

dependency file

See *dependent*

dependency line

In the `make` utility, a line in the description file that describes the dependents on which a given target depends.

dependent

Also called a **dependency file**. In the `make` utility, an entity on which a file to be built (the **target**) depends. A source file is a dependent of an object module.

F

field

In `awk`, one element of an input record; fields are separated by a field separator, which can be specified and is by default any amount of white space. The beginning and end of the record are also field separators.

See also *record*

field variable

In `awk`, a variable that is a field of the input record; field variables can be manipulated as any other variable.

G

g-file

In the Source Code Control System (SCCS), the file whose contents are used to create the s-file or to apply a delta to it.

I

ID keyword

In the Source Code Control System (SCCS), a symbol composed of a single letter enclosed by percent signs (%). In the Revision Control System (RCS), a symbol composed of a keyword name enclosed by dollar signs (\$). In expanded form, a keyword provides identification information about the file, such as its date, version number, or name.

L

lexical analyzer

A program or program fragment for analyzing input and assigning elements of it to categories to assist in parsing the input. The `lex` program assists in the creation of lexical analyzers.

See also *parser*

locking

In a version control system, the creation and use of information flagging a version control file as being checked out for editing.

locking mechanism

In a version control system, a way to prevent overlapping and concurrent changes to a file. SCCS uses p-files to indicate which files are currently out for editing; RCS creates locks by editing the RCS file to insert lock information.

M

macro definition

For the `m4` macro processor or the `make` utility, a statement creating a macro name and defining the text and argument substitutions for which the macro stands.

O

operator

In regular expressions, a character that is interpreted to mean something other than its literal meaning. For example, a pair of brackets (`[]`) form an operator that enables a single-character match on any one of the characters enclosed by the brackets.

P

p-file

In the Source Code Control System (SCCS), a lock file whose presence indicates that the s-file of the same name is currently being edited.

parser

A program or program fragment for interpreting input and determining how to act upon it. The `yacc` program assists in the creation of parsers.

pattern space

In the `sed` editor, the range of lines currently being edited; the pattern space is selected by an address or pair of addresses.

R

RCS file

In the Revision Control System (RCS), a file stored in the RCS library, containing the text of the original file and the list of deltas that have been applied to it.

RCS (Revision Control System)

A set of programs for managing program and documentation source files so that any revision of a given file can be retrieved. Revisions to a file are stored as a series of incremental changes (deltas) applied to the original version instead of as complete copies of all the versions. The system provides locking mechanisms so that only a single user can apply changes to a given file at any one time.

See also *SCCS (Source Code Control System)*

RCS file

A file stored in the Revision Control System (RCS) library containing the text of the original file and the list of deltas that have been applied to it.

RCS library

The directory in which Revision Control System (RCS) files are stored.

record

In `awk`, the information between two consecutive occurrences of the record separator, which can be specified and is by default a newline character. For most purposes, a record can be thought of as a line from the input file. The beginning and end of the file are also record separators.

S**s-file**

In the Source Code Control System (SCCS), a file stored in the SCCS library, containing the text of the original file and the list of deltas that have been applied to it.

SCCS (Source Code Control System)

A set of programs for managing program and documentation source files so that any revision of a given file can be retrieved. Revisions to a file are stored as a series of incremental changes (deltas) applied to the original version instead of as complete copies of all the versions. The system provides locking mechanisms so that only a single user can apply changes to a given file at any one time.

See also *RCS (Revision Control System)*

SCCS library

The directory in which Source Code Control System (SCCS) s-files and p-files are stored.

script

In the `sed` editor, a list of editing commands to be applied to the input file.

SID

In SCCS, the numeric identification applied to a particular delta.

See also *SCCS (Source Code Control System)*

Source Code Control System

See *SCCS (Source Code Control System)*

T

target

Also called a **target file**. In the `make` utility, an entity to be built from its **dependents**. An executable program is a target that is built from one or more object modules.

token

For the `m4` macro processor, a recognizable entity that can be a macro name. A token consists of alphanumeric characters delimited by nonalphanumeric characters and cannot contain other tokens. For `lex`-generated lexical analyzers and `yacc`-generated parsers, the smallest independent unit of meaning as defined by either the parser or the lexical analyzer. A token can contain data, a language keyword, an identifier, or other parts of a language syntax.

V

version control file

In a version control system, a file that consists of original text and a set of revisions (deltas) that have been made to it. In the Revision Control System (RCS), this file is called an RCS-file; in the Source Code Control System (SCCS), an s-file.

version control library

A directory that contains files that are organized and maintained under a version control system such as the Revision Control System (RCS) or the Source Code Control System (SCCS).

version control system

A software tool that aids in the organization and maintenance of file revisions and configurations. In particular, it automates the storing, logging, retrieval, and identification of revisions to source programs, documentation, and data files.

Y

younger file

For the `make` utility, a dependency file that has changed more recently than its target.

Index

Numbers and Special Characters

\$
(See dollar sign)
*
(See asterisk)
+
(See plus sign)
.
(See period)
/
(See slash)
:
(See colon)
?
(See question mark)
@
(See at sign)
\
(See backslash)
^
(See circumflex)
|
(See vertical bar)
()
(See parentheses)
[]
(See brackets)
{ }
(See braces)
< >
(See angle brackets)

A

action

in awk, 2-3, 2-13
lexical analyzer, 4-2, 4-3, 4-5, 4-9
multiple actions for one expression, 4-10
null action, 4-9
in yacc
ambiguous, 4-33
ambiguous, resolving, 4-34
conflicts, 4-33
conflicts, resolving, 4-34
reduce, 4-32
shift, 4-31
yacc parsers, 4-18, 4-25
address, sed editor, 3-4
admin command, 6-19, 6-26
ampersand
in make, 7-11
in sed, 3-10
&
(See ampersand)
angle brackets
in lex, 4-6
in make, 7-15
archiving source files
(See RCS, SCCS)
arithmetic, in m4, 5-10
array, in awk, 2-8
asterisk
in basic regular expressions, 1-2
in extended regular expressions, 1-4
in regular expressions, 1-6
in make, 7-5, 7-11
in \$* macro, 7-15
at sign

- in make, 7-7
 - in \$@ macro, 7-14
 - in \$\$@ macro, 7-14
 - awk utility, 2-1
 - action, 2-3, 2-13
 - before or after processing the file, 2-19
 - omitting, 2-3
 - action operator, 2-13
 - backslash, 2-10
 - BEGIN statement, 2-19
 - beginning of a field in an expression, 2-10
 - command-line syntax, 2-2
 - comments in programs, 2-17
 - concatenating strings, 2-19
 - control structure, 2-17
 - end of a field in an expression, 2-10
 - END statement, 2-19
 - field separator, 2-2
 - field variable, 2-7
 - fields in, 2-1
 - flag, 2-2
 - function
 - mathematical, 2-14
 - miscellaneous, 2-16
 - string, 2-15
 - functions, 2-14
 - pattern
 - omitting, 2-3
 - regular expressions, 2-10
 - to specify ranges of records, 2-12
 - patterns, 2-2
 - pipe, 2-20
 - print command, 2-5
 - printf command, 2-5
 - program, 2-2
 - entering on the command line, 2-4e
 - syntax, 2-2
 - program structure, 2-3
 - ranges of records, 2-12
 - records in, 2-1
 - redirection, 2-20
 - regular expressions as patterns, 2-10
 - relational expression, 2-11
 - semicolons in a program, 2-3, 2-13
 - separating patterns from actions, 2-3
 - sequence of operations, 2-4, 2-12
 - slash, 2-10
 - split function, 2-7
 - string manipulation, 2-7, 2-11, 2-19
 - variable, 2-5
 - array, 2-8
 - built-in, 2-8
 - creating, 2-6
 - field, 2-7
 - internal, 2-8
 - RLENGTH, 2-15
 - RSTART, 2-15
 - simple, 2-6
 - string, 2-6
 - treatment of, 2-6, 2-7
 - value if uninitialized, 2-6
- ## B
-
- backslash
 - in awk, 2-10
 - in basic regular expressions, 1-2
 - in extended regular expressions, 1-4
 - in regular expressions, 1-2
 - in sed, 3-6, 3-10
 - basic regular expression, 1-2
 - BEGIN statement
 - in awk, 2-19
 - in lex, 4-15
 - blank characters in macros, in m4, 5-6
 - blank lines (spurious) in m4 output, 5-3
 - braces

- in awk, 2-3
- in basic regular expressions, 1-2
- in extended regular expressions, 1-4
- in lex, 4-4, 4-5, 4-14
- in make, 7-10
- in yacc, 4-22

brackets

- in basic regular expressions, 1-2
- in extended regular expressions, 1-4

building programs

(See lex program, make utility, yacc program)

built-in macro

(See macro)

C

caret

(See circumflex)

changeom macro, in m4, 5-9

changequote command

- in m4, 5-4

changequote macro, in m4, 5-9

character class

- in regular expressions, 1-7

ci command, 6-10, 6-13

circumflex

- in awk, 2-10
- in basic regular expressions, 1-2
- in extended regular expressions, 1-4
- in make, 7-10

collating sequence

- in regular expressions, 1-8

collating symbol

- in regular expressions, 1-8

colon, in yacc, 4-23

comment characters, in m4, 5-9

conditional action

- in m4, 5-12

- in make, 7-12

context address

- in sed, 3-5

control structure

- in awk, 2-17
- in sed, 3-9

controlling revisions of source files

(See RCS, SCCS)

create command, 6-19

creating a new release

- RCS, 6-13
- SCCS, 6-23

D

declaration, in yacc, 4-21

define command, in m4, 5-2

defining macros

(See m4 macro preprocessor, make utility)

delelit command, 6-23

delget command, 6-23

delta, 6-3

delta command, 6-23

dependency file

- defined, 7-1

dependent

(See dependency file)

description file, in make, 7-21e

- command, 7-10, 7-13
- commands in, 7-5
- echoing commands in, 7-3, 7-7
- stopping on errors, 7-7
- testing, 7-20

diffs command, 6-25

divert macro, in m4, 5-11

divnum macro, in m4, 5-11

dlen macro, in m4, 5-13

dnl command, in m4, 5-3

dollar sign

- in awk, 2-10
- in basic regular expressions, 1-2

- in extended regular expressions, 1-4
- in m4, 5-5
- in make, 7-5, 7-11
- in sed, 3-4
- dumpdef macro, in m4, 5-14

E

- echoing commands in make, 7-3, 7-7
- edit command, 6-22
 - merging branches with, in SCCS, 6-24
 - r option, 6-23
- editing of files, simultaneous, management of
 - by RCS, 6-5
 - by SCCS, 6-6
- editor
 - (See sed editor)
- egrep
 - (See grep utility)
- embedded newline character
 - in sed, 3-5
- end of file
 - in lex, 4-13
 - in sed, 3-4
- endmarker token, 4-18, 4-25
 - value of, 4-23
- environment variable, in make, 7-16
- error token, in yacc, 4-29
- escape character
 - in basic regular expressions, 1-2
 - in extended regular expressions, 1-4
 - in lex, 4-6, 4-7
 - in sed, 3-10
- eval macro, in m4, 5-10
- extended regular expression, 1-4

F

- fgrep
 - (See grep utility)

- field
 - in awk, 2-1, 2-7
- file
 - creating
 - in RCS, 6-10
 - in SCCS, 6-19
 - editing, SCCS, 6-22
 - getting multiple, in SCCS, 6-22
 - getting status of, in SCCS, 6-22
 - getting, SCCS, 6-21
 - names in RCS, 6-10
 - names in SCCS, 6-19
 - versions of, in RCS or SCCS, 6-3
- file name
 - SCCS, 6-19
- finite-state automaton, 4-2, 4-31
 - stack usage, 4-31
- flag
 - in sed, 3-11
- flags in SCCS files, 6-21
 - list of, 6-27
- functions in awk, 2-14

G

- g-file, defined, 6-3
- get command, 6-21
 - p option, 6-22
- getting files from an RCS library, 6-12
 - specifying version, 6-12
- getting files from an SCCS library, 6-21
 - for editing, 6-22
 - specifying version, 6-22
 - writing to standard output, 6-22
- getting multiple SCCS files, 6-22
- getting status of SCCS files, 6-22
- grammar file, in yacc, 4-20
 - contents of, 4-20
 - declarations section, 4-21
 - error, 4-29
 - guidelines, 4-28

programs section, 4-27
rules section, 4-23
grep utility, 1-9

H

help command, in SCCS, 6-25

I

ID keywords in SCCS, 6-20
(*See also* SCCS; percent sign)
ifdef macro, in m4, 5-10
ifndef macro, in m4, 5-12
include macro, in m4, 5-11
index macro, in m4, 5-13
info command, 6-22
input/output routines, in lex, 4-12
 null character in, 4-13
 overriding, 4-12
 translation table for, 4-13
internal macro
(*See* macro)

K

keyword, processing, in yacc, 4-21
 associativity, 4-22
 precedence, 4-22

L

LC_TYPE environment variable
(*See* collating sequence)
len macro, in m4, 5-13
lex library, 4-4, 4-12
lex program, 4-1
(*See also* lexical analyzer)
 calculator example, 4-35
 escape character, 4-6, 4-7
 finding substrings, 4-8

 matching wildcards, 4-8
 quote characters, 4-6, 4-7
 REJECT action, 4-9
 alternative to, 4-11
 returning input to the input stream,
 4-9
 using, 4-15
 using with yacc, 4-16
 yyless function action, 4-11
lex utility
 macro, 4-4
 expansion, 4-5
 substitution string, 4-4
lexical analyzer, 4-1
(*See also* lex program)
 action, 4-2, 4-3, 4-5, 4-9
 multiple for one expression, 4-10
 null, 4-9
 with yacc parsers, 4-9
 action if no rule specified, 4-4
 BEGIN statement, 4-15
 default action, 4-4
 end of file, 4-13
 endmarker token, 4-18
 file name, 4-3, 4-16
 generating, 4-15
 getting more input, 4-11
 input look-ahead, 4-3
 input/output routines, 4-12
 null character in, 4-13
 overriding, 4-12
 translation table for, 4-13
 length of a matched string, 4-10
 lex library, 4-4, 4-12
 passing code to generated program,
 4-14
 printf function, 4-10
 printing a matched string, 4-10
 regular expressions in, 4-3, 4-6,
 4-8
 return statement, 4-17

- returning input to the input stream, 4-11
 - extent of, 4-12
- rule, 4-5
 - conflicts in, 4-7
 - matching input, 4-7
- specification file
 - definitions section, 4-4
 - definitions section, using `y.tab.h` in, 4-17
 - elements of, 4-3
 - format of, 4-4
 - incomplete, 4-6
 - lines `lex` cannot interpret, 4-14
 - matching input, 4-7
 - rules section, 4-5
 - start condition, 4-14
 - setting, 4-15
 - translation table, 4-13
 - `yyleng` variable, 4-10
 - `yylval` variable, 4-18
 - `yymore` function, 4-11
 - `yytext` variable, 4-10
 - `yywrap` function, 4-13
- library, RCS
 - (*See* RCS)
- library, SCCS
 - (*See* SCCS)
- line number
 - in `sed`, 3-4
- literal string, in `yacc`, 4-27
- look-ahead
 - lexical analyzer, 4-3
- look-ahead token, in `yacc`
 - clearing, 4-30
 - number, 4-19
- conditional action, 5-12
- defining macros, 5-2
 - in terms of other macros, 5-3e
 - to track other macros, 5-3
- `divert` macro, 5-11
- `divnum` macro, 5-11
- `dlen` macro, 5-13
- `dnl` macro, 5-3
- `dumpdef`, 5-14
- `eval` macro, 5-10
- `ifdef` macro, 5-10
- `ifndef` macro, 5-12
- including a file, 5-11
- `index` macro, 5-13
- `len` macro, 5-13
- macro
 - built-in, 5-7
 - internal, 5-7
- macro argument, 5-6
- macro syntax, 5-1
- `maketemp` macro, 5-12
- `print` macro, 5-14
- printing, 5-14
- quote characters, 5-4
- quoting in nested macros, 5-4
- recursion, 5-2
- redefining macros, 5-5
- redirection, 5-11
- spurious blank lines in output, 5-3
- string manipulation, 5-13
- `substr` macro, 5-13
- temporary file, 5-12
- `translit` macro, 5-13
- `undefine` macro, 5-9
- `undivert` macro, 5-11
- using system programs, 5-12
- macro, 5-1, 7-9
 - (*See also* `m4` macro preprocessor; `make` utility)
 - arguments, in `m4`, 5-5
 - built-in
 - in `m4`, 5-7
 - in `make`, 7-13

- checking for definition of, in m4, 5-10
- defined, for m4, 5-1
- defining
 - in make, 7-9
- defining, in m4, 5-2
 - in terms of another macro, 5-3e
 - to track another macro, 5-3
- definition, in make, 7-3
- expansion, in m4
 - delaying, 5-4
 - recursive nature of, 5-2
- internal
 - in m4, 5-7
 - in make, 7-13, 7-15
- in lex, 4-4
 - expansion of, 4-5
- nested, in m4
 - quoting in, 5-4
- precedence of definitions in make, 7-3
- redefining, in m4, 5-5
- removing, in m4, 5-9
- substitution, in make, 7-10
- main function, in yacc, 4-18, 4-19
- \$(MAKE) macro, 7-13
 - testing description files with, 7-20
- make utility, 7-1
 - command execution by, 7-3
 - command syntax, 7-3
 - conditional action, 7-12
 - creating files, 7-2
 - defining macros, 7-9, 7-12
 - dependency list, 7-6
 - description file, 7-4, 7-10, 7-21e
 - example, 7-8, 7-21
 - environment variable, 7-16
 - including other files, 7-20
 - internal macro, 7-13
 - file name prefix, 7-15
 - first out-of-date file, 7-15
 - out-of-date file list, 7-15
 - target file name, 7-14
 - target file name, on dependency line, 7-14
 - macro definition, 7-3
 - macro substitution, 7-10
 - nested call, 7-13
 - on distributed system, 7-2
 - operation of, 7-1
 - out-of-date file, 7-2, 7-15
 - recursion, 7-13
 - rules
 - defining, 7-18
 - internal, 7-7, 7-16
 - internal, simplifying, 7-8
 - single suffix, 7-19
 - rules file example, 7-18e
 - shell invocation by, 7-3
 - suffixes, 7-16
 - adding, 7-17
 - replacing, 7-17
 - target file creation process, 7-2
 - target files with no dependents, 7-2
 - testing description files, 7-20
 - updating files, 7-2
- MAKEFLAGS macro, 7-16
- maketemp macro, in m4, 5-12
- merging branches of an SCCS file, 6-24
- multiple matches in the sed editor, 3-11

N

- \n
 - (See embedded newline character)
- noninteractive editing
 - (See sed editor)
- nonterminal symbol, 4-20, 4-21, 4-25

- internal, 4-26
- null character
 - grammar rule, 4-28
 - in lex, 4-13
- null string, in yacc, 4-25

O

- operator
 - action, in awk, 2-13
 - Boolean, in awk, 2-2, 2-12
 - regular expression, defined for, 1-1
 - relational, in awk, 2-11

P

- p-file, 6-6
- parentheses
 - in awk, 2-2
 - in basic regular expressions, 1-2
 - in extended regular expressions, 1-4
 - in m4, 5-6, 5-10
 - in make, 7-10
- parser, 4-18, 4-19
 - (*See also* yacc program)
 - action, 4-25
 - ambiguous action, 4-33
 - resolving, 4-34
 - conflicting actions, 4-33
 - resolving, 4-34
 - controlling during a rule's action, 4-26
 - endmarker token, 4-18, 4-25
 - error handling, 4-29
 - to allow correction, 4-30
 - including the yylex function, 4-27
 - main function, 4-17, 4-19
 - reduce action, 4-32
 - shift action, 4-31
 - using with a lexical analyzer, 4-16
 - yychar variable, 4-19
 - yyerror function, 4-18, 4-19

- yylex function, 4-18
- yyval variable, 4-18
- pattern, 3-10
 - (*See also* regular expression)
 - in awk, 2-2, 2-3, 2-10
 - ranges of records, 2-12
 - in sed, 3-5, 3-10
- pattern space, 3-3
- percent sign
 - in lex, 4-4, 4-14
 - SCCS, 6-20
 - in yacc, 4-20, 4-22
- period
 - in basic regular expressions, 1-2
 - in extended regular expressions, 1-4
- pipes, in awk, 2-20
- placing files in an RCS library, 6-10
- placing files in an SCCS library, 6-19
- plus sign
 - in extended regular expressions, 1-4
 - in regular expressions, 1-6
- print command
 - in awk, 2-5
- print macro, in m4, 5-14
- printf command
 - in awk, 2-5
- processing text files
 - (*See* awk utility, m4 macro preprocessor, sed editor)
- prs command, 6-25

Q

- question mark
 - in extended regular expressions, 1-4
 - in regular expressions, 1-6
 - in make, 7-5
 - in \$? macro, 7-15
- quote characters, in m4, 5-9
- quoting strings
 - in lex, 4-6, 4-7

in m4, 5-4

R

RCS, 6-1

ci command, 6-10, 6-13

creating a new release, 6-13

file names, 6-10

file storage, 6-3

getting files from the library, 6-12

specifying version, 6-12

ID keywords, 6-11

library, 6-3

creating, 6-8

getting files from, 6-12

getting files from, specifying

version, 6-12

name of, 6-4

placing files in, 6-10

security, 6-8

placing files in the library, 6-10

preventing simultaneous editing of
files, 6-5

rcsdiff command, 6-15

versions of files, 6-3

rcs command

functions, 6-9

RCS-file, 6-3

illustrated, 6-3

rcsdiff command, 6-14, 6-15

record

in awk, 2-1

recursion

in m4, 5-2

in make, 7-13

in yacc, 4-28

redefining macros, in m4, 5-5

redirection

in awk, 2-20

in m4, 5-11

reduce action, in yacc, 4-32

regular expression, 1-1

in awk, 2-10

basic

escape character in, 1-2

rules, 1-2

saving and reusing patterns, 1-7

character classes, 1-7

collating considerations, 1-7

collating sequences, 1-8

concatenating multiple, 1-2

equivalence classes in, 1-9

extended

escape character in, 1-4

rules, 1-4

internationalized usage, 1-7

length of attempted match, 1-6

in lex, 4-3, 4-6, 4-8

matching selected characters, 1-7

precedence of operators in, 1-2

restricting matches, 1-7

restricting matches in, 1-6

rules, for sed editor, 3-5

specifying multiple, 1-8

REJECT action, in lex, 4-9

alternative to, 4-11

relational expression

in awk, 2-11

release, creating new

RCS, 6-13

SCCS, 6-23

removing a macro, in m4, 5-9

repeating matches in the sed editor,

3-11

return statement, in lex, 4-17

Revision Control System, 6-1

(*See also* RCS)

RLENGTH variable, in awk, 2-15

RSTART variable, in awk, 2-15

rule

in lex, 4-5

conflicts in, 4-7

matching input, 4-7

in make, 7-2
internal, 7-7
in yacc, 4-23

S

s-file, 6-3
SCCS, 6-1
admin command, 6-19, 6-26
commands, 6-29
create command, 6-19
creating a new release, 6-23
deledit command, 6-23
delget command, 6-23
delta command, 6-23
diffs command, 6-25
edit command, 6-22
merging branches with, 6-24
-r option, 6-23
file names, 6-19
file storage, 6-3
g-file, 6-3
get command, 6-21
-p option, 6-22
getting files from the library, 6-21
for editing, 6-22
specifying version, 6-22
writing to standard output, 6-22
getting multiple files, 6-22
getting status of files, 6-22
help command, 6-25
ID keywords, 6-20
locating, 6-21
requiring, 6-21
info command, 6-22
library, 6-3
creating, 6-8
getting files from, 6-21
getting files from, for editing,
6-22
getting files from, specifying
version, 6-22
getting files from, writing to
standard output, 6-22
name of, 6-4, 6-8
placing files in, 6-19
security, 6-8, 6-28
specifying path to, 6-8
p-file, 6-6
placing files in the library, 6-19
preventing simultaneous editing of
files, 6-6
prs command, 6-25
s-file, 6-3
sccsdiff command, 6-25
versions of files, 6-3
scs command, 6-17
-d option, 6-8
functions, 6-17
options, list of, 6-28
sccsdiff command, 6-25
script
(See sed editor, command
script)
searching for text with grep, 1-9
security for RCS libraries, 6-8
security for SCCS libraries, 6-8, 6-28
sed editor, 3-1
address, 3-4
limitations on using, 3-5
combining flags, 3-3
command
buffer manipulation, 3-8
editing, 3-6
flow-of-control, 3-9
command script, 3-1
command syntax, 3-6
multiple, using together, 3-3
on the command line, 3-3e
command-line syntax, 3-2
context address, 3-5
control structure, 3-9
escape character, 3-10
flag, 3-2
hold area, 3-8

- input and output, 3-1
- input file, treatment of, 3-2
- limitations of, 3-1
- line number, 3-4
- order of operations, 3-3
- pattern space, 3-3
- patterns in, 3-5, 3-10
- printing lines
 - after substituting text, 3-11
 - repeating matches, 3-11
 - selecting lines for editing, 3-4
 - string manipulation, 3-10
 - substituting text
 - modifying command behavior, 3-11
 - using flags, 3-11
 - using an ampersand, 3-10
 - using backslashes, 3-6, 3-10
 - using semicolons, 3-2
 - using slashes, 3-5
 - using the hold area, 3-8
 - writing a file, 3-11
- semicolon
 - in awk, 2-3, 2-13
 - in lex, 4-5
 - in sed, 3-2
 - in yacc, 4-23
- ;
- (*See semicolon*)
- shift action, in yacc, 4-31
- shift command, in m4, 5-5
- SID, 6-4
- simultaneous editing of files,
 - management of
 - by RCS, 6-5
 - by SCCS, 6-6
- sinclue macro, in m4, 5-11
- slash
 - in awk, 2-10
 - in sed, 3-5
- Source Code Control System, 6-1
 - (*See also SCCS*)
- specification file, in lex, 4-3
 - definitions section
 - using y.tab.h in, 4-17
 - Definitions section, 4-4
 - format of, 4-4
 - incomplete, 4-6
 - lines lex cannot interpret, 4-14
 - matching input, 4-7
 - rules section, 4-5
- split function, in awk, 2-7
- start condition, in lex, 4-14
 - setting, 4-15
- start symbol, in yacc, 4-22
- stopping on errors in make, 7-7
- stream editor
 - (*See sed editor*)
- string manipulation
 - in awk, 2-7, 2-11, 2-19
 - in lex, 4-4
 - in m4, 5-13
 - in sed, 3-10
- string variable, in awk, 2-6
- substr macro, in m4, 5-13
- substring, 4-8
- symbol, in yacc, 4-20, 4-21
 - start, 4-22
- syntax
 - (*See individual utility entries*)
- syscmd macro, in m4, 5-12

T

- target file
 - creation process in make, 7-2
 - defined, 7-1
 - without dependents, 7-2
- temporary file, in m4, 5-12
- terminal symbol, 4-19
- time stamp
 - used by make utility, 7-2
- token
 - in m4

- defined, 5-1
- interpretation of, 5-2
- in yacc
 - defined, 4-16
 - finding names of, 4-17
 - list of, 4-20
- token number, in yacc, 4-23
- translation table, in lex, 4-13
- translit macro, in m4, 5-13

U

- undefine macro, in m4, 5-9
- undivert macro, in m4, 5-11

V

- variable
 - in awk, 2-5
 - array, 2-8
 - built-in, 2-8
 - creating, 2-6
 - field, 2-7
 - internal, 2-8
 - numeric, 2-6
 - simple, 2-6
 - treatment of, 2-6, 2-7
 - value if uninitialized, 2-6
 - global, in yacc, 4-22
- vertical bar
 - in extended regular expressions, 1-4
 - in lex, 4-10
 - in yacc, 4-23

W

- what command, 6-21

Y

- y.tab.c file, 4-18
- y.tab.h file, 4-35, 4-39

- list of tokens, 4-20
- using in lex specification file, 4-17
- yacc program, 4-16, 4-19
 - (*See also* parser)
 - calculator example, 4-35
 - debug mode, 4-34
 - declaration, 4-21
 - finding token names, 4-17
 - global variable, 4-22
 - grammar file, 4-20
 - declarations section, 4-21
 - error, 4-29
 - guidelines, 4-28
 - programs section, 4-27
 - rules section, 4-23
 - library routines, 4-19
 - look-ahead token, clearing, 4-30
 - null character, 4-28
 - null string, 4-25
 - parameter keywords, 4-25
 - default values, 4-26
 - processing keywords, 4-21
 - associativity, 4-22
 - precedence, 4-22
 - recursion, 4-28
 - start symbol, 4-22
 - token number, 4-23
 - using with lex, 4-16
- younger file
 - defined, 7-2
- yy.lex.c file, 4-3, 4-16
- yychar variable, 4-19
- yyerror function, 4-18, 4-19
- yy leng variable, 4-10
- yyless function, in lex, 4-11
- yy lex function, 4-3, 4-18
 - called by yyparse, 4-18
 - including in a parser, 4-27
 - requirements, 4-19
- yy lval variable, 4-18, 4-32, 4-33
- yy more function, 4-11
- yyparse function, 4-18
- yytext variable, 4-10

yywrap function

in lex, 4-13

How to Order Tru64 UNIX Documentation

To order Tru64 UNIX documentation in the United States and Canada, call **800-344-4825**. In other countries, contact your local Compaq subsidiary.

If you have access to Compaq's intranet, you can place an order at the following Web site:

<http://asmorder.nqo.dec.com/>

If you need help deciding which documentation best meets your needs, see the Tru64 UNIX *Documentation Overview*, which describes the structure and organization of the Tru64 UNIX documentation and provides brief overviews of each document.

The following table provides the order numbers for the Tru64 UNIX operating system documentation kits. For additional information about ordering this and related documentation, see the *Documentation Overview* or contact Compaq.

Name	Order Number
Tru64 UNIX Documentation CD-ROM	QA-6ADAA-G8
Tru64 UNIX Documentation Kit	QA-6ADAA-GZ
End User Documentation Kit	QA-6ADAB-GZ
Startup Documentation Kit	QA-6ADAC-GZ
General User Documentation Kit	QA-6ADAD-GZ
System and Network Management Documentation Kit	QA-6ADAE-GZ
Developer's Documentation Kit	QA-6ADAF-GZ
Reference Pages Documentation Kit	QA-6ADAG-GZ
TruCluster Server Documentation Kit	QA-6BRAA-GZ

Reader's Comments

Tru64 UNIX

Programming Support Tools
AA-RH9WA-TE

Compaq welcomes your comments and suggestions on this manual. Your input will help us to write documentation that meets your needs. Please send your suggestions using one of the following methods:

- This postage-paid form
- Internet electronic mail: readers_comment@zk3.dec.com
- Fax: (603) 884-0120, Attn: UBPG Publications, ZKO3-3/Y32

If you are not using this form, please be sure you include the name of the document, the page number, and the product name and version.

Please rate this manual:

	Excellent	Good	Fair	Poor
Accuracy (software works as manual says)	<input type="checkbox"/>	<input type="checkbox"/>	<input type="checkbox"/>	<input type="checkbox"/>
Clarity (easy to understand)	<input type="checkbox"/>	<input type="checkbox"/>	<input type="checkbox"/>	<input type="checkbox"/>
Organization (structure of subject matter)	<input type="checkbox"/>	<input type="checkbox"/>	<input type="checkbox"/>	<input type="checkbox"/>
Figures (useful)	<input type="checkbox"/>	<input type="checkbox"/>	<input type="checkbox"/>	<input type="checkbox"/>
Examples (useful)	<input type="checkbox"/>	<input type="checkbox"/>	<input type="checkbox"/>	<input type="checkbox"/>
Index (ability to find topic)	<input type="checkbox"/>	<input type="checkbox"/>	<input type="checkbox"/>	<input type="checkbox"/>
Usability (ability to access information quickly)	<input type="checkbox"/>	<input type="checkbox"/>	<input type="checkbox"/>	<input type="checkbox"/>

Please list errors you have found in this manual:

Page	Description
_____	_____
_____	_____
_____	_____
_____	_____

Additional comments or suggestions to improve this manual:

What version of the software described by this manual are you using? _____

Name, title, department _____
Mailing address _____
Electronic mail _____
Telephone _____
Date _____

----- Do Not Cut or Tear - Fold Here and Tape -----

COMPAQ

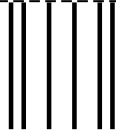

NO POSTAGE
NECESSARY IF
MAILED IN THE
UNITED STATES

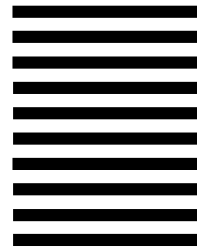

BUSINESS REPLY MAIL

FIRST CLASS MAIL PERMIT NO. 33 MAYNARD MA

POSTAGE WILL BE PAID BY ADDRESSEE

COMPAQ COMPUTER CORPORATION
UBPG PUBLICATIONS MANAGER
ZKO3-3/Y32
110 SPIT BROOK RD
NASHUA NH 03062-2698



----- Do Not Cut or Tear - Fold Here -----

Cut on This Line