

Tru64 UNIX

Technical Reference for Using Chinese Features

June 2001

This guide provides information on the use of the Chinese-specific features supported on the Compaq Tru64 UNIX operating system.

Software Version:

Tru64 UNIX Version 5.1A or higher

**Compaq Computer Corporation
Houston, Texas**

© 2001 Compaq Computer Corporation

COMPAQ and the Compaq logo Registered in U.S. Patent and Trademark Office. Tru64 is a trademark of Compaq Information Technologies Group, L.P. in the United States and other countries.

Microsoft, Windows, and Windows NT are trademarks of Microsoft Corporation in the United States and other countries. Motif, OSF/1, UNIX, and X/Open are trademarks of The Open Group in the United States and other countries. All other product names mentioned herein may be trademarks of their respective companies.

Confidential computer software. Valid license from Compaq required for possession, use, or copying. Consistent with FAR 12.211 and 12.212, Commercial Computer Software, Computer Software Documentation, and Technical Data for Commercial Items are licensed to the U.S. Government under vendor's standard commercial license.

Compaq shall not be liable for technical or editorial errors or omissions contained herein. The information in this publication is provided "as is" without warranty of any kind and is subject to change without notice. The warranties for Compaq products are set forth in the express limited warranty statements accompanying such products. Nothing herein should be construed as constituting an additional warranty.

Table of Contents

Preface

1 Character Sets	1-1
1.1 CNS 11643	1-1
1.2 DTSCS	1-4
1.3 Big-5	1-5
1.4 GB2312-80	1-6
1.5 Extended GB	1-7
1.6 GBK and GB18030-2000.....	1-7
1.7 Unicode	1-7
1.8 ISO/IEC 10646	1-8
2 Codesets and Codeset Conversion	2-1
2.1 DEC Hanyu	2-1
2.1.1 ASCII CODE	2-2
2.1.2 CNS 11643 Code	2-2
2.1.3 DTSCS Code	2-3
2.1.4 User-Defined Characters	2-4
2.2 Taiwanese EUC	2-5
2.3 Big-5	2-7
2.4 DEC Hanzi	2-8
2.5 GBK	2-10
2.6 GB18030	2-11
2.7 Shift Big-5	2-12
2.8 Telecode.....	2-13

2.8.1 Plane 1 Character Encoding	2-13
2.8.2 Plane 2 Character Encoding	2-13
2.9 UCS-4/UCS-2	2-14
2.10 UTF-8	2-14
2.11 Codeset Conversion	2-14
2.11.1 Default Conversion String	2-16
2.11.2 One-to-Many Conversion	2-17
2.11.3 User-Defined Character Mappings	2-17
2.12 Codeset for Peripheral Devices	2-18

3 Locales 3-1

4 Local Language Devices4-1

4.1 Terminals	4-1
4.2 Printers	4-1

5 Fonts 5-1

5.1 DECwindows Fonts	5-1
5.1.1 XLFD Font Names	5-2
5.1.2 Bitmap Font Samples	5-4
5.1.3 Font Encodings	5-7
5.1.4 Specifying Fonts in DECwindows Applications	5-11
5.2 Outline Fonts	5-11
5.2.1 XLFD Font Names of Chinese Outline Fonts	5-12
5.3 TrueType Fonts	5-13

6 Keyboards.....6-1

7 Input Methods.....7-1

7.1 Activating and Deactivating Chinese Input Methods	7-2
7.1.1 Character-Cell Terminal Applications	7-2
7.1.2 DECwindows Motif Applications	7-2
7.1.3 CDE Applications	7-4
7.2 Switching Input Method	7-5
7.3 Motif Interface Input Method	7-7
7.3.1 Input Areas	7-8
7.3.2 Interaction Styles	7-8

7.3.2.1	Root Window Interaction.....	7-8
7.3.2.2	Off-the-Spot Interaction.....	7-10
7.3.3	Input Server Operations	7-11
7.3.4	Options Menu	7-12
7.3.4.1	Vertical Layout.....	7-12
7.3.4.2	Horizontal Layout.....	7-12
7.3.4.3	Select Phrase Input Class.....	7-12
7.3.4.4	User Phrase Database.....	7-13
7.3.4.5	System Phrase Database.....	7-13
7.3.4.6	Current Window	7-13
7.3.4.7	Input Method Customization.....	7-15
7.3.4.8	Help.....	7-20
7.3.4.9	Quit	7-21
7.3.5	Saving Your New Settings	7-21
7.4	Alphabetic Input Methods (dxhanyuim and dxhanziim)	7-21
7.5	Tsang-Chi Input Method (dxhanyuim)	7-21
7.5.1	Tsang-Chi Root Radicals.....	7-22
7.5.2	Tsang-Chi Code Generation	7-27
7.5.2.1	General Rules	7-27
7.5.2.2	Connected Characters	7-28
7.5.2.3	Composite Characters	7-29
7.5.2.4	Exceptional Characters	7-31
7.5.3	Invoking Tsang-Chi Input Method.....	7-33
7.5.4	Multiple Candidates	7-33
7.5.5	Repeat Character Input.....	7-35
7.5.6	Error Handling	7-35
7.6	Quick Tsang-Chi Input Method (dxhanyuim)	7-35
7.6.1	Quick Tsang-Chi Code Generation	7-35
7.6.2	Invoking Quick Tsang-Chi Input Method	7-35
7.6.3	Entering Quick Tsang-Chi Code.....	7-36
7.6.4	Multiple Candidates	7-36
7.6.5	Repeat Character Input.....	7-36
7.6.6	Error Handling	7-36
7.7	Phonetic Input Method (dxhanyuim).....	7-36
7.7.1	Phonetic Symbol Categories.....	7-37
7.7.2	Phonetic Code Generation.....	7-39
7.7.3	Invoking Phonetic Input Method	7-39
7.7.4	Entering Phonetic Code.....	7-39
7.7.5	Multiple Candidates	7-40
7.7.6	Repeat Character Input.....	7-41
7.7.7	Error Handling	7-41
7.8	Internal Code Input Method (dxhanyuim)	7-41
7.8.1	Input Procedure.....	7-41

7.8.2 Repeat Character Input	7-42
7.8.3 Error Handling.....	7-42
7.9 Phrase Input Method (dxhanyuim and dxhanziim)	7-42
7.9.1 Input Procedure.....	7-43
7.9.2 Error Handling.....	7-44
7.9.2.1 Condition 1.....	7-44
7.9.2.2 Condition 2.....	7-44
7.10 Symbol Input in dxhanyuim.....	7-45
7.10.1 Invoking Symbol Input Mode.....	7-45
7.10.2 Rules of Symbol Input	7-46
7.10.3 Entering Symbol Code	7-48
7.10.4 Multiple Candidates.....	7-48
7.10.5 Error Handling.....	7-49
7.11 Input of User-Defined Characters in DECwindows Motif.....	7-49
7.12 5-Stroke Input Method (dxhanziim)	7-50
7.12.1 Input Mechanism	7-51
7.12.1.1 Single Character Input	7-52
7.12.1.2 Input of Terms.....	7-52
7.12.2 Input Procedure.....	7-54
7.12.3 Multiple Candidates.....	7-54
7.12.4 The Association Mode	7-55
7.12.5 Wildcard Key.....	7-55
7.13 5-Shape Input Method (dxhanziim).....	7-56
7.13.1 Distribution of Radicals	7-56
7.13.2 Decomposition of Chinese Characters.....	7-59
7.13.3 Distinction Code	7-60
7.13.4 Principles of Character Decomposition	7-61
7.13.5 Input Mechanism	7-61
7.13.5.1 Single Character Input	7-62
7.13.5.2 Term Input.....	7-63
7.13.6 Input Procedure.....	7-64
7.13.7 Multiple Candidates.....	7-64
7.13.8 Association Mode	7-64
7.13.9 Simple Code Characters.....	7-64
7.13.9.1 Frequently-Used Characters (Level 1 Simple Code).....	7-64
7.13.9.2 Level 2 Simple Code	7-65
7.13.9.3 Level 3 Simple Code	7-66
7.13.10 Wildcard Key.....	7-66
7.13.11 Entering 5-Shape Code Through the Numeric Keypad.....	7-67
7.14 Pin-Yin Input Method (dxhanziim)	7-67
7.14.1 Input Mechanism	7-67
7.14.2 Input Procedure.....	7-68
7.14.3 Multiple Candidates.....	7-68

7.14.4 Association Mode	7-69
7.14.5 Multiple Phonetic Representations	7-69
7.14.6 Radical Characters	7-69
7.15 Qu-Wei Input Method (dxhanziim)	7-69
7.15.1 DEC GB2312 Characters	7-70
7.15.2 Extended GB Characters	7-70
7.15.3 Entity Names and Unicode Values	7-70
7.16 Telex Code Input Method (dxhanziim)	7-73
7.17 Intelligent ABC Input Method (dxhanziim).....	7-74
7.17.1 Basic Input Methods	7-74
7.17.2 Input Process.....	7-76
7.17.3 Intelligent ABC Input Method Features.....	7-77
7.17.4 Intelligent ABC Usage Notes	7-78
7.18 Symbol Input in dxhanziim	7-79
7.19 Conversion Between Input Servers and DECwindows Motif Applications	7-79

8 Chinese Printing Support..... 8-1

8.1 Supported Printers	8-1
8.1.1 Text Printers	8-1
8.1.2 PostScript Printers.....	8-1
8.2 8.2 Print File Formats	8-1
8.3 Printing Features.....	8-2
8.3.1 Font Embedding.....	8-2
8.3.2 Font Faulting.....	8-2
8.3.3 Software On-Demand Font Loading	8-3
8.3.4 Codeset Conversion	8-3
8.3.5 Outline Fonts	8-4
8.4 Commands and Daemons.....	8-4
8.4.1 Country-Specific Options to the lpr Command.....	8-4
8.4.2 PostScript Font Management Utility (pfsetup).....	8-6
8.4.3 Font-Faulting Daemon (ffd)	8-7
8.4.4 PrintServer Printing Command wwlpspr	8-8
8.5 Chinese Printing Setup.....	8-8
8.5.1 Dot Matrix Printers	8-8
8.5.2 DEClaser 1152.....	8-9
8.5.3 DEClaser 5100.....	8-11
8.5.4 PrintServer 17	8-13
8.5.5 Generic PostScript Printers.....	8-14

9 Other Chinese Features 9-1

9.1 Phrase Support in the VT382-D.....	9-1
--	-----

9.1.1 Creating a Phrase Definition File	9-1
9.1.2 Syntax of Phrase Definitions	9-1
9.1.3 Phrase Downloading	9-3
9.2 Sorting Utility.....	9-4
9.2.1 asort Utility.....	9-5
9.2.2 Multiple Collating Sequences	9-5
9.2.3 Depth-First Against Breadth-First.....	9-6
9.2.4 User-Defined Characters	9-6
9.3 Hanyu and Hanzi DECterm	9-6
9.3.1 Creating a Hanyu or Hanzi DECterm.....	9-6
9.3.2 Customizing DECterm.....	9-7
9.3.3 Font Sizes	9-7
9.3.4 Terminal ID.....	9-7
9.3.5 Interaction Style.....	9-7
9.3.6 Input Server	9-7
9.3.7 Copying Information.....	9-8
9.3.8 Default Character Set.....	9-8
9.3.9 Chinese Character Input/Output	9-8
9.3.10 Reconnecting the Input Server	9-8
9.3.11 VT382-D and VT382-C Terminal Functions.....	9-8
9.4 Phrase Conversion	9-10
9.5 Special Characters in nroff	9-10

Figures

Figure 1-1: CNS 11643 Character Planes	1-2
Figure 1-2: CNS 11643 First Character Planes	1-3
Figure 1-3: CNS 11643 Second Character Plane	1-3
Figure 1-4: EDPC Recommended Character Set	1-5
Figure 1-5: GB2312-80 Character Set	1-6
Figure 2-1: DEC Hanyu Encoding of CNS 11643 Planes	2-2
Figure 2-2: Code Space for CNS 11643 in DEC Hanyu	2-3
Figure 2-3: DEC Hanyu Encoding of DTSCS Characters.....	2-4
Figure 2-4: Code Space for DTSCS in DEC Hanyu.....	2-4
Figure 2-5: Encoding of Taiwanese EUC.....	2-6
Figure 2-6: Code Space for Big-5	2-8
Figure 2-7: DEC Hanzi Character Encoding	2-9
Figure 2-8: GB2312-80 and Extended GB Code Space	2-10
Figure 3-1: Chinese Language Names.....	3-3
Figure 5-1: Sung Font Sample.....	5-5
Figure 5-2: Hei Font Sample.....	5-5

Figure 5-3: Songti Font Sample.....	5-6
Figure 5-4:Heiti Font Sample.....	5-6
Figure 5-5: Fangsongti Font Sample.....	5-7
Figure 5-6: Kaiti Font Sample.....	5-7
Figure 5-7: CNS 11643-1986 Font Encoding Scheme	5-8
Figure 5-8: DTSCS Font Encoding Scheme	5-9
Figure 5-9: GB2312-80 Font Encoding Schemes.....	5-10
Figure 6-1: LK201-D Keyboard Layout	6-2
Figure 6-2: LK401-D Keyboard Layout	6-2
Figure 6-3: LK201-C Keyboard Layout	6-3
Figure 6-4: LK401-C Keyboard Layout	6-3
Figure 6-5: Numeric Keypad for 5-Stroke Input Method	6-4
Figure 7-1: Chinese Root Window Interaction Style	7-9
Figure 7-2: Chinese Input Window Icon.....	7-9
Figure 7-3: Off-the-Spot Interaction Style.....	7-10
Figure 7-4: Customization of Invocation Key Sequences in dxhanyuim.....	7-19
Figure 7-5: Customization of Invocation Key Sequences in dxhanziim.....	7-20
Figure 7-6: Full Form Alphabet Input Method.....	7-21
Figure 7-7: Invocation of the Tsang-Chi Input Method.....	7-33
Figure 7-8: Entering a Tsang-Chi Radical	7-33
Figure 7-9: Multiple Candidates.....	7-34
Figure 7-10: The Quick Tsang-Chi Input Method.....	7-35
Figure 7-11: Entering a Quick Tsang-Chi Code.....	7-36
Figure 7-12: Entering the Phonetic Symbols for “吉”	7-39
Figure 7-13: Input of “例” Using the Internal Code Input Method.....	7-42
Figure 7-14: Entering a Phrase Code.....	7-43
Figure 7-15: Converting a Phrase Code to a Phrase	7-43
Figure 7-16: Distribution of Radicals	7-57
Figure 7-17: 5-Shape Radical Keys	7-58
Figure 7-18: Distinction Code for the 5-Shape Input Method	7-60
Figure 8-1: Two-Channel Communication of the Font-Faulting Mechanism	8-9

Tables

Table 1-1: Characters Defined in CNS 11643-1986.....	1-2
Table 1-2: Characters Defined in CNS 11643-1992.....	1-4
Table 1-3: Mapping of EDPC Recommended Character Set to CNS 11643-1992.....	1-5
Table 2-1: CNS 11643 Code Range in DEC Hanyu.....	2-2
Table 2-2: UDC Code Range in DEC Hanyu.....	2-5
Table 2-3: Big-5 Code Range.....	2-7

Table 2-4: Big-5 User-Defined Spaces.....	2-7
Table 2-5: Big-5 to Shift Big-5 Character Mappings.....	2-12
Table 2-6: Chinese Codeset Conversion.....	2-15
Table 2-7: Codeset Names and Associated Strings.....	2-16
Table 2-8: Mapping Between Big-5 and DEC Hanyu User-Defined Characters.....	2-18
Table 2-9: Feasible Chinese Codesets for Applications, Terminals, and Printers.....	2-18
Table 3-1: Chinese Locales.....	3-1
Table 4-1: Chinese Print Filters.....	4-2
Table 5-1: Traditional Chinese Screen Fonts.....	5-1
Table 5-2: Simplified Chinese Screen Fonts.....	5-2
Table 5-3: XLFD of Miscellaneous Chinese Screen Fonts.....	5-4
Table 5-4: Chinese DECwindows Font Encodings.....	5-8
Table 5-5: Font Encoding Conversion.....	5-9
Table 5-6: Chinese DECwindows Font Encodings.....	5-10
Table 5-7: GR to GL Font Encoding Conversion.....	5-10
Table 5-8: Traditional Chinese Default Fonts.....	5-11
Table 5-9: Simplified Chinese Default Fonts.....	5-11
Table 7-1: Key Sequences that Invoke Chinese Input Method.....	7-6
Table 7-2: Key Sequences Used to Select Traditional Chinese Input Method.....	7-6
Table 7-3: Key Sequences Used to Select Simplified Chinese input Method.....	7-7
Table 7-4: Window Input Areas.....	7-8
Table 7-5: Modifier State Customization.....	7-18
Table 7-6: Tsang-Chi root Radicals Classification.....	7-23
Table 7-7: Quick Reference Table of the Tsang-Chi Root Radicals.....	7-26
Table 7-8: Composition Form Characters.....	7-27
Table 7-9: Connected Form Characters.....	7-27
Table 7-10: Examples of Connected Character Decomposition.....	7-28
Table 7-11: Composite Character Decomposition.....	7-30
Table 7-12: Compound Characters.....	7-31
Table 7-13: Difficult Characters.....	7-32
Table 7-14: Special Characters.....	7-33
Table 7-15: Meaning of Arrow Characters.....	7-34
Table 7-16: Phonetic Symbols.....	7-38
Table 7-17: Examples of Phonetic Input.....	7-39
Table 7-18: Phonetic Symbols with Different Termination Keys.....	7-40
Table 7-19: Stroke Categories.....	7-51
Table 7-20: 5-Stroke Code.....	7-51
Table 7-21: Input of Single Characters with the 5-Stroke Input Method.....	7-52
Table 7-22: Input Terms with the 5-Stroke Input Method.....	7-53
Table 7-23: Shape Code.....	7-56
Table 7-24: Entering Basic Strokes.....	7-62
Table 7-25: Input of Terms with the 5-Shape Input Method.....	7-63
Table 7-26: Pin-Yin Tone Marks.....	7-68

Table 9-1: Phrase definitions.....	9-2
Table 9-2: Traditional Chinese Sorting Methods.....	9-4
Table 9-3: Simplified Chinese Sorting Methods.....	9-4

Preface

This guide provides Chinese-specific information, such as character sets and locales, for end users and programmers who want to use and develop internationalized applications in Chinese locales on the Compaq Tru64 UNIX operating system. Details of the Chinese features are also documented in this guide.

Intended Audience

This guide is for new and experienced end users and programmers who are interested in the Chinese variant of the Compaq Tru64 UNIX operating system.

Structure of this Guide

This guide consists of nine chapters:

- Chapter 1 Describes the Chinese character sets supported in the Compaq Tru64 UNIX operating system software
- Chapter 2 Describes the Chinese codesets and the conversion among different codesets
- Chapter 3 Describes the Chinese locales
- Chapter 4 Describes the local hardware devices that support the Chinese locales
- Chapter 5 Provides information on Chinese fonts
- Chapter 6 Provides information on Chinese keyboards
- Chapter 7 Describes how to input Chinese characters
- Chapter 8 Introduces the Chinese printing support
- Chapter 9 Provides descriptions of other Chinese features

Related Documents

Writing Software for the International Market

Programming for the World: A Guide to Internationalization, Sandra Martin O'Donnell, Prentice Hall, 1994

OSF/Motif User's Guide Revision 1.2, Open Software Foundation, Prentice Hall, Englewood Cliffs, New Jersey 07632

OSF/Motif Style Guide Revision 1.2, Open Software Foundation, Prentice Hall, Englewood Cliffs, New Jersey 07632

X Window System, Third Edition, Robert W. Scheifler and James Gettys, Digital Press

Programmer's Supplement for Release 5 of the X Window System, Version 11, David Flanagan, O'Reilly & Associates, Inc.

The Unicode Standard, Version 2.0, The Unicode Consortium, Addison Wesley, Reading, MA, 1996

Information Technology-Universal Multiple-Octet Coded Character Set, ISO/IEC 10646: 1993

Chinese Code for Data Communication

Conventions

The following typographical conventions are used in this manual:

<code>%</code>	A percent sign represents the C shell system prompt. A
<code>\$</code>	dollar sign represents the system prompt for the Bourne and Korn shell.
<code>#</code>	A number sign represents the superuser prompt.
<code>% cat</code>	Boldface type in interactive examples indicates typed user input.
<i>File</i>	Italic (slanted) type indicates variable values, placeholders, and function argument names.
<code>[]</code> <code>{ }</code>	In syntax definitions, brackets indicate items that are optional and braces indicate items that are required. Vertical bars separating items inside brackets or braces indicate that you choose one item from among those listed.
<code>...</code>	In syntax definitions, a horizontal ellipsis indicates that the preceding item can be repeated one or more times.
<code>cat(1)</code>	A cross-reference to a reference page includes the appropriate section number in parentheses. For example, <code>cat(1)</code> indicates that you can find information on the <code>cat</code> command in Section 1 of the reference pages.
<code>[RETURN]</code>	In an example, a key name enclosed in a box indicates that you press that key.
<code>Ctrl/x</code>	This symbol indicates that you hold down the first named key while pressing the key or mouse button that follows the slash. In examples, this key combination is enclosed in a box (for example <code>[Ctrl/C]</code>).

Character Sets

The Compaq Tru64 UNIX operating system software supports the following Chinese character sets:

- CNS 11643
- DTSCS
- Big-5
- GB2312-80
- Extended GB
- GBK and GB18030-2000
- Unicode
- ISO/IEC 10646

The CNS 11643 and Big-5 character sets are commonly used for traditional Chinese characters. The GB2312-80 and GB18030-2000 character sets are commonly used for Simplified Chinese characters. The Unicode and ISO/IEC 10646 character sets are common to both traditional and Simplified Chinese.

1.1 CNS 11643

The CNS (Chinese National Standard) 11643 character set standard was published by the National Bureau of Standards of Taiwan in 1986 and was updated in 1992. It was also called "Standard Interchange Code for Generally-used Chinese Character" (SICGCC). CNS 11643 provides 16 character planes for defining Chinese characters. Each character plane is divided into 94 rows and each row has 94 columns. Altogether, a total number of 8,836 characters can be accommodated in each plane.

Character planes 1-11 are reserved for defining standard Chinese characters while character planes 12-16 are user-defined areas.

Figure 1–1: CNS 11643 Character Planes

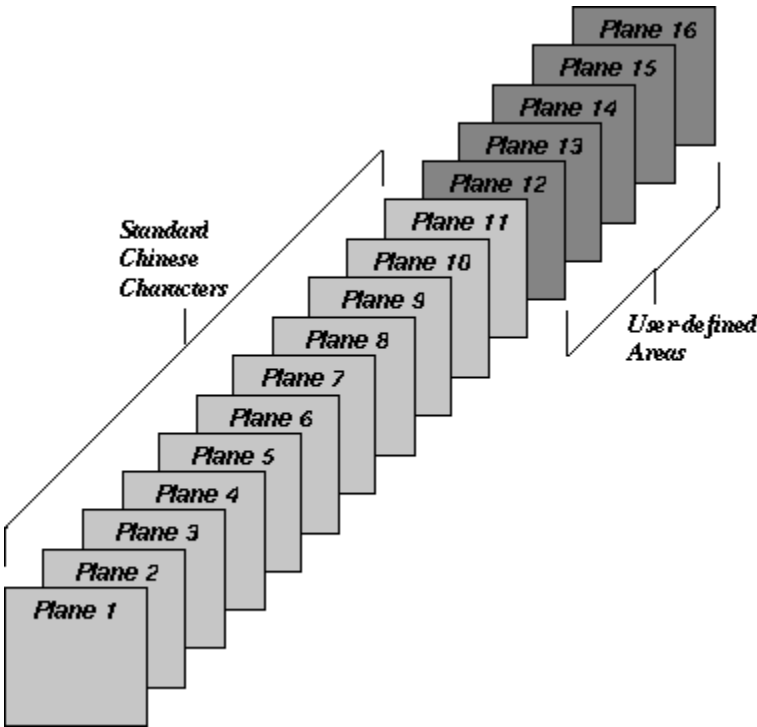

The original CNS 11643 standard, published in 1986, defines certain groups of characters only on the first and second character planes. Table 1–1 shows these groups of characters.

Table 1–1: Characters Defined in CNS 11643-1986

Character Plane	Character Type	Number of Characters
Plane 1	Special characters	651
	Control characters	33
	Frequently-used characters	5,401
Plane 2	Less frequently-used characters	7,650

Figure 1–2 and Figure 1–3 illustrate the positions of these characters in the first and second character planes.

Figure 1-2: CNS 11643 First Character Planes

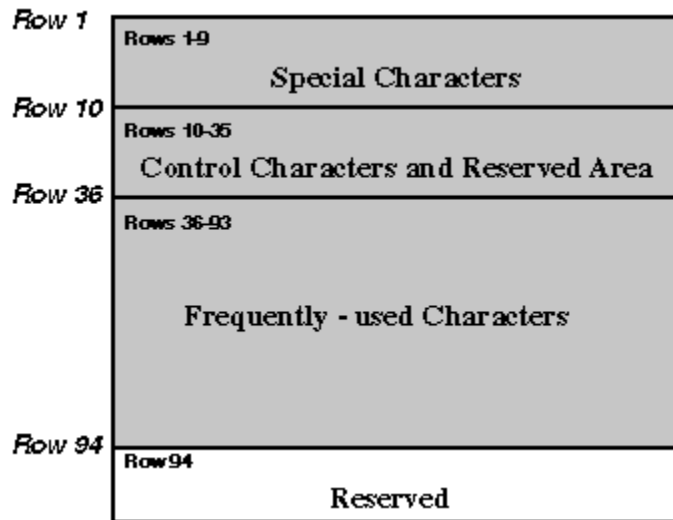
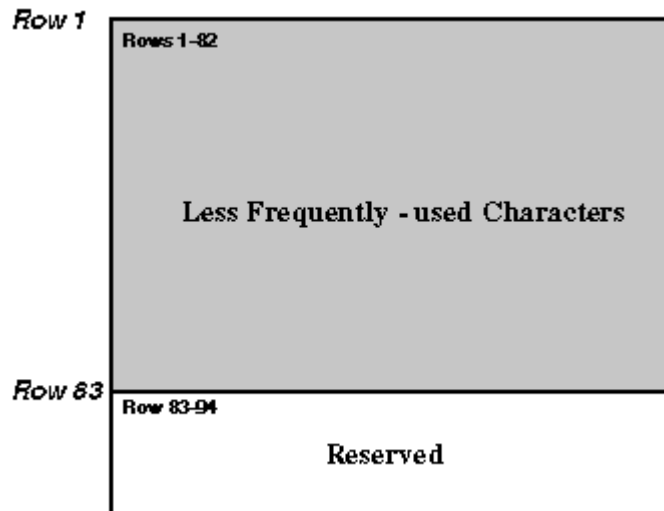

Figure 1-3: CNS 11643 Second Character Plane



As the CNS11643-1986 character set was not rich enough to meet most of the application requirements, such as names and addresses, the information industry in Taiwan requested to expand the character set. In 1991, the Bureau of National Standard formed a team to study how to expand CNS 11643. On August 4, 1992, the Bureau of National Standard published the revised CNS 11643 - Chinese Standard Interchange Code (CSIC)

The revised CNS 11643, called CNS 11643-1992, defined 651 special characters, 33 control characters and 48,027 Chinese characters, as shown in Table 1–2.

Table 1–2: Characters Defined in CNS 11643-1992

Character Plane	Character Type	Number of Characters
Plane 1	Special characters	651
	Control characters	33
	Frequently-used characters	5,401
Plane 2	Less frequently-used characters	7,650
Plane 3	Rarely-used characters (EDPC Part I)	6,148
Plane 4	Used for residency system, ISO 2nd edition DIS 10646 Han characters, 171 EDPC Part II Characters	7,298
Plane 5	Rarely-used characters (Based on the Ministry of Education publications)	8,603
Plane 6	Variants based on the Ministry of Education publications (<=14 strokes)	6,388
Plane 7	Variants based on the Ministry of Education publications (>14 strokes)	6,539

Since the number of characters defined in CNS 11643-1992 is far greater than those required for general use, the revised CNS 11643 is called "Chinese Standard Interchange Code (CSIC)".

Note

In this release, the new characters added to CNS 11643-1992 are not supported. Only the characters defined in CNS 11643-1986 and DTSCS (which will be described in the next section) are supported.

1.2 DTSCS

In addition to CNS 11643, the Compaq Tru64 UNIX operating system supports the DIGITAL Taiwan Supplemental Character Set (DTSCS). Currently, only the EDPC Recommended Character Set, which defines a total of 6,319 characters, is included in DTSCS. EDPC Recommended Character Set was first published by the Electronic Data Processing Center of Executive Yuen in June, 1988.

Figure 1–4: EDCP Recommended Character Set

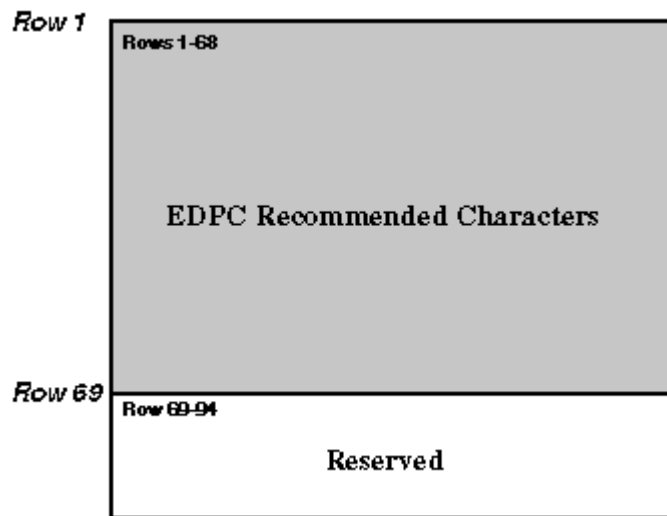

As a de facto standard, computer vendors support the EDCP Recommended Character Set and assign it to CNS 11643 character plane 14.

In the revised CNS 11643-1992, the 6,319 characters in the EDCP Recommended Character Set are assigned to the third and fourth character planes of CNS 11643, as shown in Table 1–3.

Table 1–3: Mapping of EDCP Recommended Character Set to CNS 11643-1992

EDCP Characters	Character Plane	Number of Characters
Part I	Plane 3	6,148
Part II	Plane 4	171

1.3 Big–5

The Big-5 character set, though not a national standard, is commonly used by the Taiwan information industry, particularly in the PC and workstation market. Big-5 character set was designed to meet the requirements of five major software vendors in Taiwan. Since its publication, much software and hardware, and many peripheral devices have been developed to support Big-5.

Big-5 is very similar to the first two planes of CNS 11643-1992. The frequently used Chinese characters (5,401) defined in the two character sets are exactly the same except

that their positions in the code table are different. For the less frequently used Chinese characters, Big-5 defines two more characters in addition to the 7,650 characters defined in the second character plane of CNS 11643, and their positions in the code table are different.

1.4 GB2312-80

The GB2312-80 character set is a standard published by the State Bureau of Standardization of the People's Republic of China (PRC) in 1980 and put in force in May, 1981.

GB2312-80 defines 7,445 characters, including 6,763 Chinese characters:

- Graphic symbols
682 graphic symbols are defined and placed in rows 1-9.
- Level 1 characters
Those are 3,755 frequently used characters placed in rows 16-55.
- Level 2 characters
Those are 3,008 less frequently used characters placed in rows 56-87. See Figure 1-5.

The GB2312-80 code table is divided into 94 rows (Qu), numbered from 1 to 94. Each row has 94 columns (Wei), also numbered from 1 to 94.

Figure 1-5: GB2312-80 Character Set

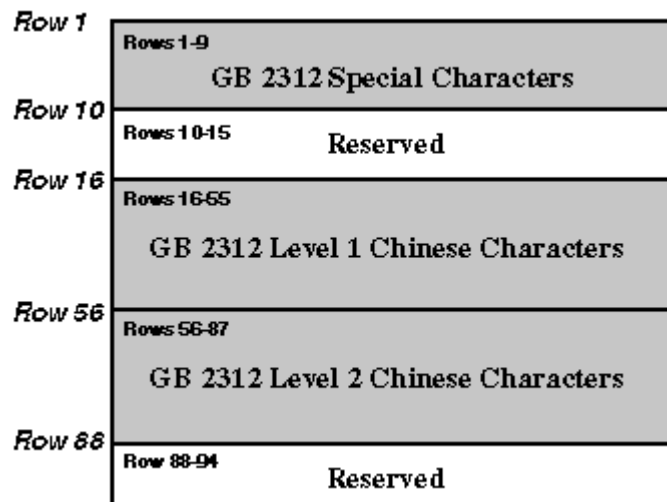

1.5 Extended GB

The extended GB character set provides 8,836 (94 x 94) code points for defining user-defined characters. The 8,836 code points are divided into two regions:

- User-Defined Area — Spans rows 1-87 and provides 8,178 code positions.
- User-Defined (reserved) Area — Spans rows 88-94 and provides 658 code positions. This area is where users define special and frequently used user-defined characters.

The extended GB code table is similar to the GB2312 code table. It is divided into 94 rows and each row has 94 columns.

1.6 GBK and GB18030-2000

The GBK character set is an extension to the GB 2312-80 character set. GBK includes all of the Hanzi characters specified by the ISO 10646-1:1993 standard (also known as the GB13000:1.93 character set) that are not already included in GB 2312:80. GBK is therefore defined as a normative annex of GB13000.1-93.

The GB18030-2000 character set, defined by the Chinese National Standard organization, further extends GBK by means of 4-byte code points. That is, the GB18030-2000 character set has 4-byte encoding in addition to the 1-byte and 2-byte encoding of GBK.

GB18030-2000 incorporates GBK support for the Hanzi characters specified by ISO 10646-1:1993 as well as the set of characters covered by Unicode Version 3.0 and the ISO/IEC 10646-2000 standard.

1.7 Unicode

The Unicode Standard, Version 3.0 specifies a universal character set (UCS) that contains definitions for 49,194 characters and includes a Private Use Area for vendor-defined or user-defined characters. The main features of this character set are:

- All characters are treated as 16-bit units.
- Each 16-bit unit has an abstract character identity.
- Certain sequences of 16-bit characters in a text stream are transformed into other characters, called composed characters.
- All characters have properties, such as base, numeric, spacing, combination, and directionality. The Unicode standard provides rules for ordering characters with different properties so that parsing of character sequences is unambiguous.
- The relationship between Unicode characters and the glyphs in the native language script that users see, type, or print is not necessarily one-to-one. A glyph may be mapped to a single abstract character or a composed character. Conversely, more than one glyph can be mapped to a character.

- The ISO 8859-1 character set occupies the first 256 code positions (and the ASCII character set the first 128 positions) of the UCS.

1.8 ISO/IEC 10646

The ISO/IEC 10646 standard, which is specified in Information Technology-Universal Multiple-Octet Coded Character Set, ISO/IEC 10646, allows characters to be specified as either 32-bit units or like Unicode, as 16-bit units. In their 32-bit form, the 16-bit character values in Unicode are zero-extended through a second 16-bit unit to conform to ISO/IEC 10646.

Codesets and Codeset Conversion

The Compaq Tru64 UNIX operating system fully supports the following Chinese codesets by including locales and codeset conversion support:

- DEC Hanyu
- Taiwanese EUC (Extended UNIX Code)
- Big-5
- DEC Hanzi
- GBK
- GB18030
- UTF-8

It also provides codeset conversion support for the following codesets:

- Telecode
- Shift Big-5
- UCS-2
- UCS-4

2.1 DEC Hanyu

The DEC Hanyu codeset, denoted by `dechanyu`, consists of the following character sets:

- ASCII
- CNS11643, the first and second character planes
- DTSCS

- User-Defined Characters

DEC Hanyu uses a combination of single-byte, 2-byte, and 4-byte data to represent ASCII characters, symbols, or ideographic characters.

2.1.1 ASCII CODE

All ASCII characters can be represented in the form of single-byte 7-bit data in DEC Hanyu. That is, the most significant bit (MSB) of ASCII characters is always set off.

2.1.2 CNS 11643 Code

Each CNS 11643 character is represented by a 2-byte code in DEC Hanyu, which complies with the CNS 11643 standard. The MSB of the first byte is always set on while that of the second byte can be on for the first character plane or off for the second character plane. See Figure 2-1.

Figure 2-1: DEC Hanyu Encoding of CNS 11643 Planes

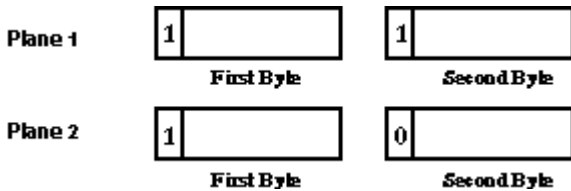

The first byte of a CNS 11643 code determines the row number of the character, while the second byte determines its column number. Table 2-1 illustrates the code range of a CNS 11643 code.

Table 2-1: CNS 11643 Code Range in DEC Hanyu

Character Plane	1st Byte (hex)	2nd Byte (hex)
Plane 1	A1 to FE	A1 to FE
Plane 2	A1 to FE	21 to 7E

The following formulas illustrate the code of a CNS 11643 character in relation to its row and column numbers.

CNS 11643 plane 1 character:

$$\begin{aligned} \text{First byte} &= A0 + \text{row number} \\ \text{Second byte} &= A0 + \text{column number} \end{aligned}$$

CNS 11643 plane 2 character:

First byte = A0 + row number
 Second byte = 20 + column number

For example, if a character is positioned at the first column of the 36th row on CNS 11643 plane 1, its encoding value is calculated as follows:

First byte = A0 (hex) + 36 = C4 (hex)
 Second byte = 20 (hex) + 01 = 21 (hex)

Its encoded value is C4A1.

Similarly, if a character is positioned at the first column of the 36th row on CNS 11643 plane 2, its encoding value is calculated as follows:

First byte = A0 (hex) + 36 = C4 (hex)
 Second byte = 20 (hex) + 01 = 21 (hex)

Its encoded value is C421.

Figure 2–2 illustrates the division of a 2-byte code space and the position of CNS 11643 characters.

Figure 2–2: Code Space for CNS 11643 in DEC Hanyu

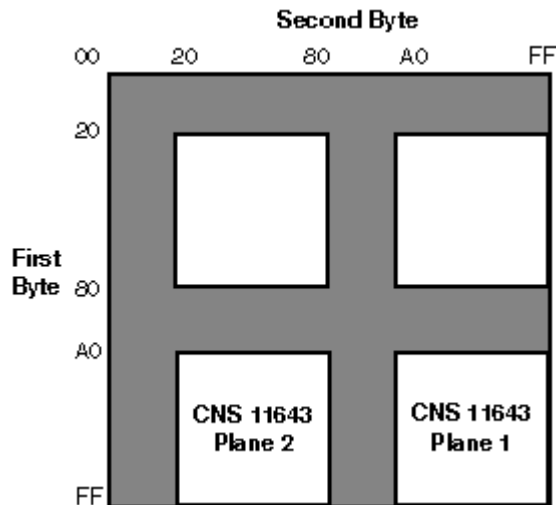

2.1.3 DTSCS Code

Each DTSCS character is represented by a 4-byte code in DEC Hanyu. The first two bytes are the leading codes, namely 0xC2 and 0xCB, which are used as a designator sequence for the DTSCS character set. The MSB of the third and fourth bytes is set on for the EDPIC Recommended Character Set.

Figure 2-3: DEC Hanyu Encoding of DTSCS Characters

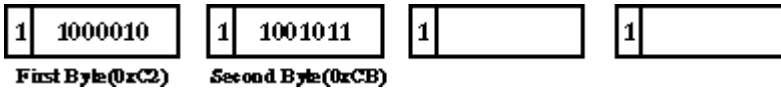
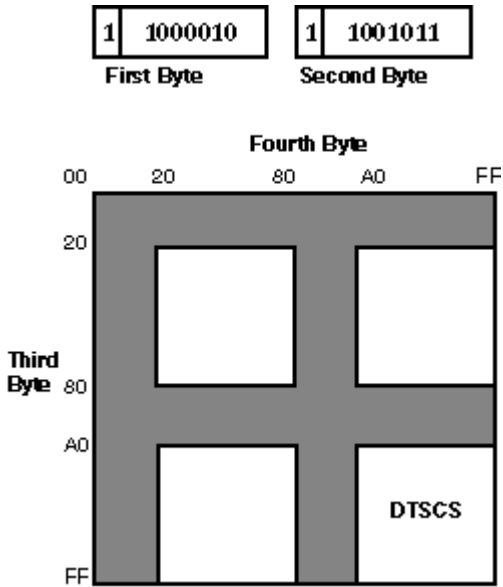

Figure 2-4 illustrates the 4-byte code space and the position of DTSCS characters.

Figure 2-4: Code Space for DTSCS in DEC Hanyu



2.1.4 User-Defined Characters

In addition to the CNS11643 and the DTSCS character sets described above, DEC Hanyu provides 3,587 positions for user-defined characters (UDC). The positions for UDCs are those unused (but not reserved) code points on the CNS 11643 first and second character planes. Therefore, the encoding of UDC is exactly the same as that of CNS 11643 except that they occupy different regions, as shown in Table 2-2.

Table 2–2: UDC Code Range in DEC Hanyu

Character Plane	Number of UDC	Code Range
Plane 1	145	FDCC - FEFE
Plane 1	2,256	AAA1 - C1FE
Plane 2	1,186	F245 - FE7E

2.2 Taiwanese EUC

Taiwanese EUC (extended UNIX code), denoted as `eucTW`, is another codeset to support CNS 11643. The design of Taiwanese EUC allows the 16 character planes of CNS 11643 to be encoded in a unified way. A stream of data encoded in Taiwanese EUC can contain characters defined in ASCII and the 16 character planes. Figure 2–5 illustrates the encoding of Taiwanese EUC.

Figure 2-5: Encoding of Taiwanese EUC

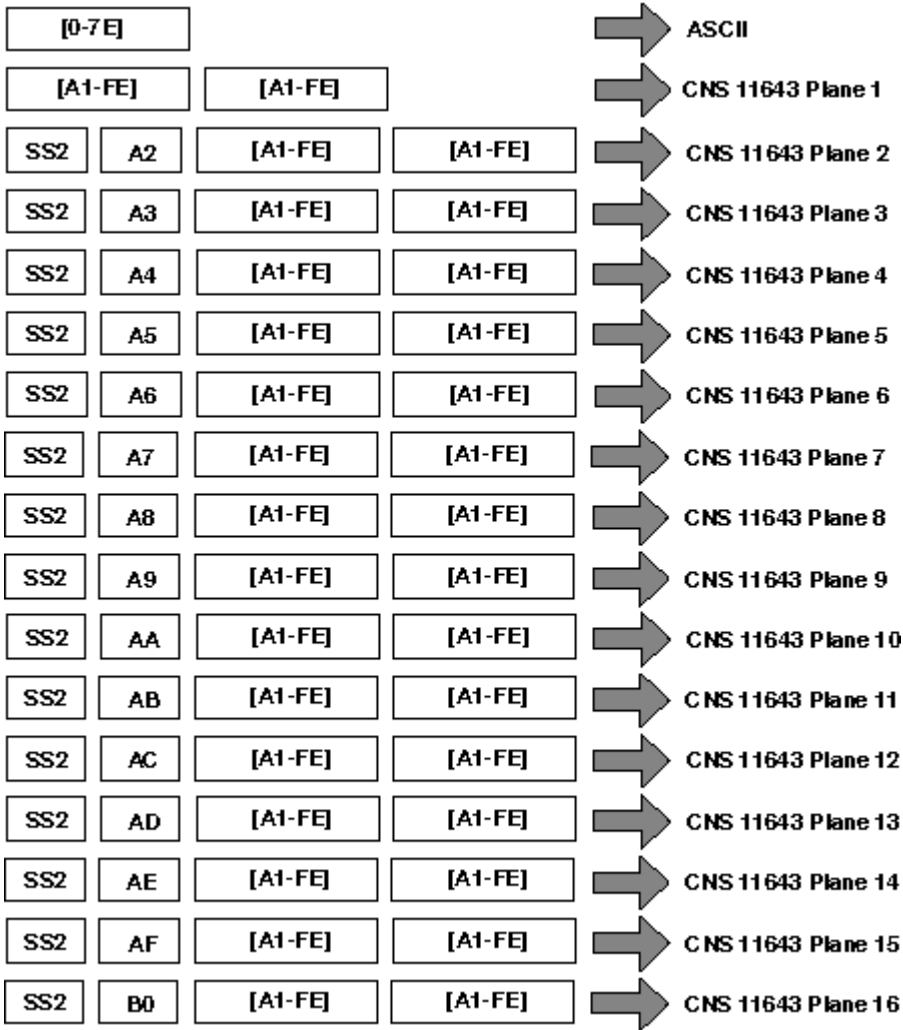

Taiwanese EUC uses the Single-Shift 2 control character (SS2) and an additional byte to specify a character plane. The only exception is the first plane, which does not require leading codes. Instead, two bytes specify a character's position on the first plane. The first byte determines its row number, while the second determines its column number. The MSBs of the two bytes are set on.

In this release, only the characters defined in the first and second planes of CNS 11643 and those in the EDPC Recommended Character Set that have been remapped into the third and fourth character planes of the revised CNS 11643-1992 are supported in Taiwanese

EUC. Other characters that were added to the CNS 11643-1992 standard are not supported.

2.3 Big-5

The Big-5 codeset, denoted as `big5`, is the only codeset that supports the Big-5 character set. The encoding of the Big-5 codeset is similar to that of CNS 11643 in DEC Hanyu. Each Big-5 character is represented by a 2-byte code, which complies with the Big-5 standard. The MSB of the first byte is always set on while that of the second byte can be set on or off.

The Big-5 code range is defined as shown in Table 2-3.

Table 2-3: Big-5 Code Range

Character	Number of Characters	Code Range
Special symbols	408	A140-A3BF
Level 1 characters	5,401	A440-C67E
Level 2 characters	7,652	C940-F9D5

In addition to the code points for special symbols and Chinese characters shown in Table 2-3, three areas are set aside for user-defined spaces. Some vendors in Taiwan support user-defined characters in the code ranges shown in Table 2-4.

Table 2-4: Big-5 User-Defined Spaces

Character	Number of Characters	Code Range
Level 1 user-defined space	785	FA40-FEFE
Level 2 user-defined space	2,983	8E40-A0FE
Level 3 user-defined space	2,041	8140-8DFE

The valid ranges of the two bytes are:

Byte	Valid Ranges
First byte	81-FE
Second byte	40-7E and A1-FE

Figure 2-6 illustrates the encoding of the Big-5 codeset in a 2-byte code space.

Figure 2-6: Code Space for Big-5

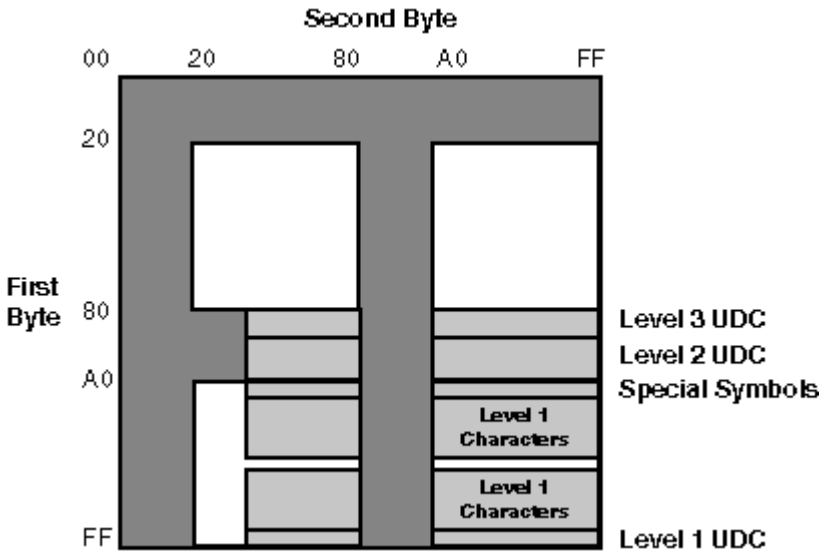

2.4 DEC Hanzi

The ASCII, GB2312-80 and extended GB character sets are combined to form the DEC Hanzi codeset.

DEC Hanzi, denoted as `dechanzi`, uses a 2-byte data representation for symbols and ideographic characters defined in the GB2312-80 character set. To differentiate GB2312-80 codes from ASCII codes, MSB of the first byte is always set on while that of the second byte is on for GB2312-80 and off for extended GB as shown in Figure 2-7.

Figure 2-7: DEC Hanzi Character Encoding

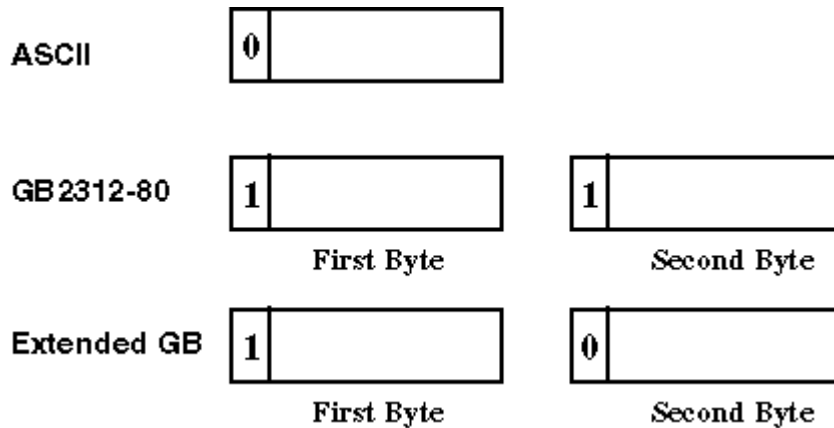

The first byte of a 2-byte code determines its row number, while the second byte determines its column number.

The following formulas illustrate the code of a GB2312-80 character or an extended GB character in relation to its row and column numbers.

GB2312-80 character:

$$\begin{aligned}\text{First byte} &= A0 + \text{row number} \\ \text{Second byte} &= A0 + \text{column number}\end{aligned}$$

Extended GB character:

$$\begin{aligned}\text{First byte} &= A0 + \text{row number} \\ \text{Second byte} &= 20 + \text{column number}\end{aligned}$$

For example, if a character is positioned at the first column of the 16th row on the GB2312-80 code plane, its encoding value is calculated as follows:

$$\begin{aligned}\text{First byte} &= A0 \text{ (hex)} + 16 = B0 \text{ (hex)} \\ \text{Second byte} &= A0 \text{ (hex)} + 01 = A1 \text{ (hex)}\end{aligned}$$

Its encoded value is B0A1.

Similarly, if a character is positioned at the first column of the 16th row on the extended GB code plane, its encoding value is calculated as follows:

$$\begin{aligned}\text{First byte} &= A0 \text{ (hex)} + 16 = B0 \text{ (hex)} \\ \text{Second byte} &= 20 \text{ (hex)} + 01 = 21 \text{ (hex)}\end{aligned}$$

Its encoded value is B021.

Figure 2–8 illustrates the division of a 2-byte code space and the position of the Chinese character sets.

Figure 2–8: GB2312-80 and Extended GB Code Space

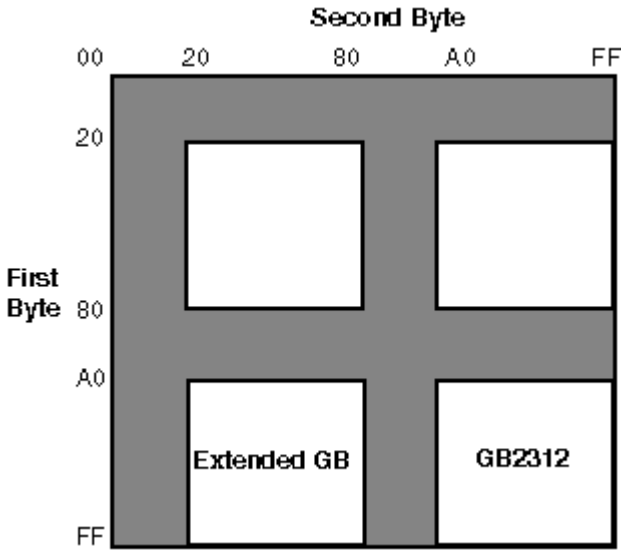

2.5 GBK

The GBK codeset is a character encoding system for Simplified Chinese.

The GBK codeset provides a total of 23,940 code points, 21,886 of which are assigned. Each row in the GBK code table consists of 190 characters. ASCII characters, which are single-byte characters, are defined in the range 0x21 to 0x7E. Encoding ranges for 2-byte characters are 0x81 to 0xFE for the first byte and 0x40 to 0x7E and 0x80 to 0xFE for the second byte.

In terms of character-to-code allocation, the sub-range for GB2321-80 characters (0xA1A1-0xFEFE) in GBK is the same encoding range defined for these characters in EUC. GBK is therefore backward compatible with Chinese EUC coding as well as forward compatible with the encoding defined in the ISO 10646-1:1993 standard.

The GBK codeset is divided into five levels as follows:

Level	Encoding Range	Code Points	Characters
GBK/1	0xA1A1 to 0xA9FE	846	717
GBK/2	0xB0A1 to 0xF7FE	6768	6763
GBK/3	0x8140 to 0xA0FE	6080	6080
GBK/4	0xAA40 to 0xFE40	8160	8160
GBK/5	0xA840 to 0xA9A0	192	166

In addition, the GBK codeset includes the following code points for user-defined characters:

Encoding Range	Code Points
0xAAA1 to 0xAFFE	564
0xF8A1 to 0xFEFE	658
0xA140 to 0xA7A0	672

The operating system provides the following codeset converter pairs for converting Simplified Chinese characters between GBK and Unicode formats (UCS-2, UCS-4, and UCF-8):

- UCS-2_GBK and GBK_UCS-2
- UCS-4_GBK and GBK_UCS-4
- UTF-8_GBK and GBK_UTF-8

2.6 GB18030

The GB18030 codeset provides 1-byte, 2-byte, and 4-byte encoding with the following structure:

Number of Bytes	Encoding Range	Code Points
1 byte	0x00 to 0x7F	128
2 byte	0x81 to 0xFE	23940
	0x40 to 0xFE (except 0x7F)	
4 byte	0x81 to 0xFE	1587600
	0x30 to 0x39	
	0x81 to 0xFE	
	0x30 to 0x39	

GB18030 1-byte code supports ASCII characters.

GB18030 2-byte code supports all the CJK characters (Chinese, Japanese, Korean) in the Unicode Version 2.1 standard.

GB18030 4-byte code supports Unicode Version 3.0 additions. The 4-byte code also leaves a large number of unassigned codepoints available for future use.

The GB18030-2000 character set maps the invalid Unicode code points (U+FFFE and U+FFFF) to 4-byte codes. Because these two code points are invalid in UCS, this mapping can cause problems with conversions between the two character sets. Also, the GB18030-2000 character set does no mapping from 4-byte code to the UCS surrogate area (U+D800 to U+DFFF).

The operating system provides the following codeset converter pairs for converting Simplified Chinese characters between GB18030 and Unicode formats (UCS-2, UCS-4, and UCF-8):

- UCS-2_GB18030 and GB18030_UCS-2
- UCS-4_GB18030 and GB18030_UCS-4
- UTF-8_GB18030 and GB18030_UTF-8

2.7 Shift Big-5

The Shift Big-5 codeset, denoted as `sbig5`, is a variant of the Big-5 codeset. The difference between the two is that the second byte of some Big-5 characters is mapped to other values to form Shift Big-5 characters. Table 2-5 illustrates the mappings of Big-5 characters to Shift Big-5 characters.

Table 2-5: Big-5 to Shift Big-5 Character Mappings

Big-5 (Second Byte)	Shift Big-5 (Second Byte)
40	30
5B	31
5C	32
5D	33
5E	34
5F	35
60	36
7B	37
7C	38
7D	39
7E	9F

The Shift Big-5 codeset can be used in codeset conversion and terminal display. Refer to Section 2.11 for details.

2.8 Telecode

The Telecode codeset (called Mitac Telex in early versions of the operating system), denoted as `telecode`, consists of two character planes. Each character plane has 8836 character positions. In plane 1, standard characters occupy positions 0001 to 8045; the remaining 791 positions are for user-defined characters. In plane 2, standard characters occupy positions 0001 to 8489; the remaining 346 positions are for user-defined characters. Telecode uses 2-byte values to represent characters on both planes.

Note

For information about the character sets encoded by Telecode, refer to *Chinese Code For Data Communication*.

Telecode can be used in codeset conversion and terminal display. Refer to Section 2.11 for further details.

2.8.1 Plane 1 Character Encoding

To differentiate plane 1 code from plane 2 code, MSB is set on in both bytes of a plane 1 character code. You can use the following formula to calculate the value of a plane 1 character from its position on the plane:

$$\text{First byte} = M + 161$$

$$\text{Second byte} = N + 161 - M \times 94$$

In this formula, N is the position of the character and $M = N / 94$.

For example, if a character is at position 2502 on plane 1, its encoded value is BBDB, which is calculated as follows:

$$N = 2502, M = 2502 / 94 = 26$$

$$\text{First byte} = 26 + 161 = 187 \text{ (or, BB (hex))}$$

$$\text{Second byte} = 2502 + 161 - 26 \times 94 = 219 \text{ (or, DB (hex))}$$

2.8.2 Plane 2 Character Encoding

To differentiate plane 2 code from plane 1 code, the MSB of the first byte is set on and that of the second byte is set off for each plane 2 character code. You can use the following formula to calculate the value of a plane 2 character from its position:

$$\text{First byte} = M + 161$$

$$\text{Second byte} = N + 33 - M \times 94$$

In this formula, N is the position of the character on the plane and $M = N / 94$.

For example, if a character is at position 2502 on plane 2, its encoded value is BB5B, which is calculated as follows:

$$N = 2502, M = 2502/94 = 26$$

$$\text{First byte} = 26 + 161 = 187 \text{ (or, BB (hex))}$$

$$\text{Second byte} = 2502 + 33 - 26 \times 94 = 91 \text{ (or, 5B, hex)}$$

2.9 UCS-4/UCS-2

The UCS codeset is a standard character encoding for the universal character set (UCS) specified in Unicode and ISO/IEC 10646. There are two encoding schemes for UCS. An implementation that parses in 16-bit units (2 octets) is known as UCS-2. This is the canonical Unicode encoding in wide use on personal computers. An implementation that parses in 32-bit units (4 octets) is known as UCS-4. This is the canonical ISO/IEC 10646 encoding that is in use on systems that can support larger data unit size.

On Compaq Tru64 UNIX, UCS-2 and UCS-4 can be used in codeset conversion. In addition, UCS-4 is used as an internal process code for some locales. For codeset conversion, see Section 2.11. For locale variants, see Chapter 3.

2.10 UTF-8

The Unicode and ISO/IEC 10646 standards define transformation formats for the UCS. The following UCS transformation formats (UTFs) exist mainly to transform UCS values into sequences of bytes for handling by various byte-oriented protocols:

- UTF-8 is the standard method for transforming UCS-encoded data into a sequence of 8-bit bytes and ensuring interchange transparency for characters in C0 code positions (0 to 31), the SPACE (32) character, and the DEL (127) character.
- UTF-7 is the standard interchange format for environments that strip the eighth bit from each byte.
- UTF-16 is a transformation format that allows systems that are limited to processing of 16-bit units (specified by UCS-2 encoding) to support the extended character definition space that is included in UCS-4.

The current version of Compaq Tru64 UNIX supports UTF-8. UTF-8 can be used in codeset conversion and in locales. For codeset conversion, see Section 2.11. For locale variants, see Chapter 3.

2.11 Codeset Conversion

Users may sometimes need to convert files from one codeset to another. The `iconv` utility provided by Compaq Tru64 UNIX is used to convert the encoding of characters in

one codeset to another and write the results to standard output. Table 2–6 shows the pairs of Chinese codeset converters that are provided.

Table 2–6: Chinese Codeset Conversion

	DEC Hanyu	Taiwan EUC	Big-5	Shift Big-5	Tele-code	DEC Hanzi	GBK	GB-18030	UCS4	UCS2	UTF8
DEC Hanyu	–	Y	Y	N	Y	Y	N	N	Y	Y	Y
Taiwan EUC	Y	–	Y	Y	Y	Y	N	N	Y	Y	Y
BIG-5	Y	Y	–	Y	Y	Y	N	N	Y	Y	Y
Shift Big-5	N	Y	Y	–	N	N	N	N	N	N	N
Telecode	Y	Y	Y	N	–	N	N	N	N	N	N
DEC Hanzi	Y	Y	Y	N	N	–	N	N	Y	Y	Y
GBK	N	N	N	N	N	N	–	N	Y	Y	Y
GB18030	N	N	N	N	N	N	N	–	Y	Y	Y
UCS4	Y	Y	Y	N	N	Y	N	N	–	Y	Y
UCS2	Y	Y	Y	N	N	N	N	N	Y	–	Y
UTF8	Y	Y	Y	N	N	Y	N	N	Y	Y	–

For example, the following command converts a DEC Hanyu file to Big-5:

```
% iconv -f dechanyu -t big5 <file>
```

Table 2–7 shows the string names you can use as the parameters of the `iconv` utility.

Table 2–7: Codeset Names and Associated Strings

Codeset	String
DEC Hanyu	dechanyu
Taiwanese EUC	eucTW
Big-5	big5
Shift Big-5	sbig5
Telecode	Telecode
DEC Hanzi	dechanzi
GBK	GBK
GB18030	GB18030
Universal Codeset (4 octet form)	UCS-4
Universal Codeset (2-octet form)	UCS-2
Universal Transfer Format	UTF-8

2.11.1 Default Conversion String

When converting from one codeset to another, characters in the source codeset that have no corresponding code point in the destination codeset will not be converted. By default, the characters that cannot be converted are skipped and have no representation in the converted output.

You can control this behavior by using the `ICONV_DEFSTR` environment variable to define a default string to replace those unconvertible characters. If you specify a numeric value for this environment variable, the corresponding character value will be used.

The `ICONV_DEFSTR` environment variable affects all Chinese `iconv` converters. You can also use the "`ICONV_DEFSTR_<from_code>_<to_code>`" environment variable to control specific codeset conversion. For example, to convert a DEC Hanyu input file to DEC Hanzi with unconvertible characters converted to "?", you would enter the following commands:

```
%setenv ICONV_DEFSTR_dehanyu_dechanzi "?"
%iconv -f dechanyu -t dechanzi hanzi_input > hanyu_output
```

For codeset converters that end in UCS-2, UCS-4, or UTF-8, you can use the "`U+XXXX`" notation to specify the default character for conversion failure fallback.

Note

During cut-and-paste operations, those traditional Chinese characters that cannot be converted to Simplified Chinese characters are shown as default characters in the applications.

2.11.2 One-to-Many Conversion

When converting from the DEC Hanzi codeset to other Chinese codesets, one Simplified Chinese character may be mapped to multiple traditional Chinese characters. By default, the `iconv` utility picks up only the most likely candidate from a list of possible choices. You can control the behavior of the `iconv` utility with the `ICONV_ACTION` environment variable.

The `ICONV_ACTION` environment variable determines how the `iconv` utility behaves when there are one-to-many mappings. The possible values are:

- `batch` – The most likely or preferred candidate will be picked up. This is the default.
- `conv_all` – All possible choices are generated within the brackets "{" and "}" so that you can edit the converted file manually and determine which one should be used.
- `conv_all_nosym` – All characters except symbols (for example, punctuation marks) are handled in the same manner as `conv_all`.

Note

During cut-and-paste operations, the batch mode is always used for one-to-many character mappings.

Note

The `ICONV_ACTION` environment variable applies to Simplified Chinese to traditional Chinese conversion only and has no effect on UCS-4 and UTF-8 converters.

2.11.3 User-Defined Character Mappings

Some user-defined characters in the Big-5 codeset have predefined mappings to user-defined spaces in DEC Hanyu. These mappings are the same as those supported by Pathworks/Hanyu. Table 2-8 shows this mapping.

Table 2–8: Mapping Between Big–5 and DEC Hanyu User-Defined Characters

DEC Hanyu	Big-5	Code Size
F321 - FB41	FA40 - FEFE	785
FB42 - FEFE	8E40 - 905C	343
AAA1 - C1FE	905D - 9EB8	2256

These predefined user-defined character mappings are supported by both the `iconv` methods and the terminal driver.

Because some user-defined characters do not have predefined mappings, Compaq recommends that you use only those user-defined characters that have predefined mappings.

2.12 Codeset for Peripheral Devices

The Compaq Tru64 UNIX software provides a mechanism for you to use to configure your system to run applications with peripherals, such as terminals and printers, that support different codesets. You can specify the codesets for the applications, terminals, and printers independently, as shown in Table 2–9. The Compaq Tru64 UNIX software automatically does the necessary codeset conversion.

Table 2–9: Feasible Chinese Codesets for Applications, Terminals, and Printers

Application Code	Terminal Code	Printer Code
DEC Hanyu	DEC Hanyu	DEC Hanyu
Taiwanese EUC	Taiwanese EUC	Taiwanese EUC
Big-5	Big-5	Big-5
DEC Hanzi	DEC Hanzi	DEC Hanzi
	Shift Big-5	
	Telecode	
UTF-8	UTF-8	

Note

Chinese DECterm software supports only DEC Hanyu, Big5, or DEC Hanzi as its terminal code. You must activate the stty drive and set tcode to dechanyu when running in a Taiwanese EUC locale. For example:

```
% stty adec tcode dechanyu
```

The `dxterm` does not support UTF-8 as a terminal code. Use `dtterm` when UTF-8 is required for a terminal code.

For details about setting up codesets for terminals and printers, see *Writing Software for the International Market*.

Locales

The Compaq Tru64 UNIX operating system supports different Chinese locales for different countries and areas. These include Taiwan, People's Republic of China (PRC), and Hong Kong. Table 3–1 shows the valid Chinese locales with different countries, codesets, and collating sequences.

Note

zh_TW is an alias of zh_TW.eucTW, and zh_CN is an alias of zh_CN.dechanyi.

Table 3–1: Chinese Locales

Codeset	Locale	Collation Sequence
DEC Hanyu	zh_TW	Internal code
	zh_TW.dechanyu	Internal code
	zh_TW@ucs4	Internal code
	zh_TW.dechanyu@ucs4	Internal code
	zh_TW.dechanyu@radical	Radical
	zh_TW.dechanyu@radical@ucs4	Radical
	zh_TW.dechanyu@stroke	Stroke
	zh_TW.dechanyu@stroke@ucs4	Stroke
	zh_TW.dechanyu@chuyin	Chuyin (Phonetic)
	zh_TW.dechanyu@chuyin@ucs4	Chuyin (Phonetic)
	zh_HK.dechanyu	Internal code
	zh_HK.dechanyu@ucs4	Internal code

Table 3-1: (Cont.) Chinese Locales

Codeset	Locale	Collation Sequence
Taiwanese EUC	zh_TW.eucTW	Internal code
	zh_TW.eucTW@ucs4	Internal code
	zh_TW.eucTW@radical	Radical
	zh_TW.eucTW@radical@ucs4	Radical
	zh_TW.eucTW@stroke	Stroke
	zh_TW.eucTW@stroke@ucs4	Stroke
	zh_TW.eucTW@chuyin	Chuyin (Phonetic)
	zh_TW.eucTW@chuyin@ucs4	Chuyin (Phonetic)
	zh_HK.eucTW	Internal code
zh_HK.eucTW@ucs4	Internal code	
Big-5	zh_TW.big5	Internal code
	zh_TW.big5@radical	Radical
	zh_TW.big5@stroke	Stroke
	zh_TW.big5@chuyin	Chuyin (Phonetic)
	zh_HK.big5	Internal code
DEC Hanzi	zh_CN	Internal code
	zh_CN.dechanzi	Internal code
	zh_CN@ucs4	Internal code
	zh_CN.dechanzi@ucs4	Internal code
	zh_CN.dechanzi@radical	Radical
	zh_CN.dechanzi@radical ucs4	Radical
	zh_CN.dechanzi@stroke	Stroke
	zh_CN.dechanzi@stroke@ucs4	Stroke
	zh_CN.dechanzi@pinyin	Pinyin (Phonetic)
	zh_CN.dechanzi@pinyin@ucs4	Pinyin (Phonetic)
	zh_HK.dechanzi	Internal code
zh_HK.dechanzi@ucs4	Internal code	
GBK	zh_CN.GBK	Internal code (however, all characters in GB 2312 character set are ordered first, followed by GBK extension characters)
GB18030	zh_CN.GB18030	Internal code (however, all characters in GB 2312 character set are ordered first, followed by GBK characters not already ordered, followed by GB18030 characters not already ordered)
UTF-8	zh_CN.UTF-8	zh_CN.GB18030
	zh_TW.UTF-8	zh_TW.dechanyu
	zh_HK.UTF-8	zh_HK.dechanyu

Locales that support the same country and codeset are basically the same. The `radical`, `stroke`, `pinyin`, and `chuyin` modifiers after the at (@) sign specify different criterion for collation and sorting. Moreover, the characters defined in character set standards have collating precedence over user-defined characters, which, in turn, have precedence over undefined or reserved characters.

The `ucs4` modifier indicates that UCS-4 is used as the internal processing code. The classification information, however, is not provided for the full set of UCS-4 characters, but only for the corresponding language.

If you are using DECwindows Motif, you can select the locale through the Language Menu of Session Manager. If you are using CDE, you can select the locale using the language menu on the CDE login screen. The applicable locales are shown in Table 3-1.

Figure 3-1: Chinese Language Names

Locale	Language Name
zh_TW	Chinese Taiwan
zh_TW.dechanyu	Chinese Taiwan (DEC Hanyu)
zh_TW.eucTW	Chinese Taiwan (EUC)
zh_TW.big5	Chinese Taiwan (Big5)
zh_TW.UTF-8	Chinese Taiwan (Unicode)
zh_HK.dechanyu	Chinese Hong Kong (DEC Hanyu)
zh_HK.dechanzi	Chinese Hong Kong (DEC Hanzi)
zh_HK.eucTW	Chinese Hong Kong (EUC)
zh_HK.big5	Chinese Hong Kong (Big5)
zh_HK.UTF-8	Chinese Hong Kong (Unicode)
zh_CN	Chinese China
zh_CN.dechanzi	Chinese China (DEC Hanzi)
zh_CN.GBK	Chinese China (GBK)
zh_CN.GB18030	Chinese China (GB18030)
zh_CN.UTF-8	Chinese China (Unicode)

Note

For DECwindows Motif and CDE, the locale modifier is ignored.

Local Language Devices

4.1 Terminals

The Compaq Tru64 UNIX operating system supports the VT382-D and VT382-C Chinese terminals. The VT382-D terminal is for traditional Chinese and the VT382-C terminal is for Simplified Chinese. Hanyu DECterm and Hanzi DECterm are the emulation of the VT382-D Chinese terminal and Simplified Chinese terminal respectively, which provide compatible functions for running Chinese character-cell terminal applications. For details of Hanyu DECterm and Hanzi DECterm, see Chapter 9, Other Chinese Features. You can also use `dtterm` running in a Chinese locale to display Chinese in a character-cell application.

4.2 Printers

The Compaq Tru64 UNIX operating system supports the following dot matrix Chinese printers:

- CP382-D (traditional Chinese)
- LA88-C (Simplified Chinese)
- LA380-CB (Simplified Chinese)

The following PostScript printers can be configured for traditional or Simplified Chinese:

- DEClaser 1152
- DEClaser 5100 with font disk (LN09X-HD)
- PrintServer 17
- All PostScript level 2 printers

The print filters listed in Table 4–1 are provided to support these Chinese printers.

Table 4–1: Chinese Print Filters

Filter Name	Printer Name
cp382dof	CP382-D printer
la88cof	LA88-C printer
la380cbof	LA380-CB printer
dl1152wrof	DEClaser 1152
dl5100wrof	DEClaser 5100
lpsof	PrintServer 17
wwpsof	Level 2 PostScript printers

Note

To use PrintServer 17, the PrintServer Software Version 5.0 or later for Compaq Tru64 UNIX is also required.

For details about setting up Chinese printer queues, see Chapter 8, Chinese Printing Support.

5.1 DECwindows Fonts

The Compaq Tru64 UNIX operating system provides Chinese DECwindows fonts in various sizes and typefaces for 75 dpi (dots-per-inch) display devices. Table 5–1 lists the screen fonts for traditional Chinese.

Table 5–1: Traditional Chinese Screen Fonts

Typefaces	Glyph Size	Bounding Box	Remarks
Screen	15 x 16	16 x 18	Mandatory font
	22 x 22	24 x 24	Mandatory font
Sung	22 x 22	24 x 24	Optional font
	30 x 30	32 x 32	Optional font
Hei	15 x 16	16 x 16	Optional font
	22 x 22	24 x 24	Optional font

There are two sets of DECwindows fonts, one for CNS 11643-1986 and one for DTSCS.

Table 5–2 lists the screen fonts for Simplified Chinese.

Table 5–2: Simplified Chinese Screen Fonts

Typefaces	Glyph Size	Bounding Box	Remarks
Screen	15 x 16*	16 x 18	Mandatory font, defined in GB5199.1-85
	22 x 22*	24 x 24	Mandatory font
Songti	15 x 16*	16 x 16	Optional font, defined in GB5199.1-85
	22 x 22*	24 x 24	Optional font
	32 x 32*	34 x 34	Optional font, defined in GB6345.1-86
Heiti	15 x 16	16 x 16	Optional font
	22 x 22*	24 x 24	Optional font
	32 x 32*	34 x 34	Optional font, defined in GB12036-89
Fangsongti	22 x 22*	24 x 24	Optional font
	32 x 32*	34 x 34	Optional font, defined in GB12034-89
Kaiti	22 x 22*	24 x 24	Optional font
	32 x 32*	34 x 34	Optional font, defined in GB12035-89

*The fonts marked with an asterisk are supplied by China Standard Technology Development Corporation (CSTDC) of People's Republic of China.

In addition to these Chinese fonts, several miscellaneous screen fonts are provided for use in Hanyu and Hanzi DECterm, and the Motif toolkit. The operating system also provides default TrueType fonts for DEC Hanzi, GBK, and GB18030 codesets as described in Section 5.3.

The mandatory fonts are available after you install the Chinese language support from the worldwide language support software. Other optional fonts are available only if you install the optional Chinese font subsets. If you do not find the optional fonts on your system, please contact your system administrator.

No 100 dpi Chinese fonts are provided in the kit. To allow you to use the Chinese fonts on 100 dpi display devices, a font alias file is provided to map the 75 dpi font names to 100 dpi font names.

5.1.1 XLFD Font Names

You must specify the DECwindows font names in X Logical Font Description (XLFD) format in your application programs or in the application resource files. You can specify wildcards for any fields in the font names.

You can use the following font names for both 75 dpi and 100 dpi display devices. If you want to state the display resolution explicitly, you can specify 75 or 100 in the X- and Y-resolution fields, that is, the second and third asterisks in the following XLFD names.

- Traditional Chinese Screen family font names in XLFD format:

CNS 11643-1986 Fonts

-ADECW-Screen-Medium-R-Normal--*-180-*-*-*M-160-DEC.CNS11643.1986-2
-ADECW-Screen-Medium-R-Normal--*-240-*-*-*M-240-DEC.CNS11643.1986-2

DTSCS Fonts

-ADECW-Screen-Medium-R-Normal--*-180-*-*-*M-160-DEC.DTSCS.1990-2
-ADECW-Screen-Medium-R-Normal--*-240-*-*-*M-240-DEC.DTSCS.1990-2

- Traditional Chinese Sung family font names in XLFD format:

CNS 11643-1986 Fonts

-ADECW-Sung-Medium-R-Normal--*-240-*-*-*M-240-DEC.CNS11643.1986-2
-ADECW-Sung-Medium-R-Normal--*-320-*-*-*M-320-DEC.CNS11643.1986-2

DTSCS Fonts

-ADECW-Sung-Medium-R-Normal--*-240-*-*-*M-240-DEC.DTSCS.1990-2
-ADECW-Sung-Medium-R-Normal--*-320-*-*-*M-320-DEC.DTSCS.1990-2

- Traditional Chinese Hei family font names in XLFD format:

CNS 11643-1986 Fonts

-ADECW-Hei-Medium-R-Normal--*-160-*-*-*M-160-DEC.CNS11643.1986-2
-ADECW-Hei-Medium-R-Normal--*-240-*-*-*M-240-DEC.CNS11643.1986-2

DTSCS Fonts

-ADECW-Hei-Medium-R-Normal--*-160-*-*-*M-160-DEC.DTSCS.1990-2
-ADECW-Hei-Medium-R-Normal--*-240-*-*-*M-240-DEC.DTSCS.1990-2

- Simplified Chinese Screen family font names in XLFD format:

-ADECW-Screen-Medium-R-Normal--*-180-*-*-*M-160-GB2312.1980-1
-ADECW-Screen-Medium-R-Normal--*-240-*-*-*M-240-GB2312.1980-1

- Simplified Chinese Songti family font names in XLFD format:

-ADECW-Songti-Medium-R-Normal--*-160-*-*-*M-160-GB2312.1980-1
-ADECW-Songti-Medium-R-Normal--*-240-*-*-*M-240-GB2312.1980-1
-ADECW-Songti-Medium-R-Normal--*-340-*-*-*M-340-GB2312.1980-1

- Simplified Chinese Heiti family font names in XLFD format:
 - ADECW-Heiti-Medium-R-Normal--*-160-*-*M-160-GB2312.1980-1
 - ADECW-Heiti-Medium-R-Normal--*-240-*-*M-240-GB2312.1980-1
 - ADECW-Heiti-Medium-R-Normal--*-340-*-*M-340-GB2312.1980-1
- Simplified Chinese Fangsongti family font names in XLFD format:
 - ADECW-Fangsongti-Medium-R-Normal--*-240-*-*M-240-GB2312.1980-1
 - ADECW-Fangsongti-Medium-R-Normal--*-340-*-*M-340-GB2312.1980-1
- Simplified Chinese Kaiti family font names in XLFD format:
 - ADECW-Kaiti-Medium-R-Normal--*-240-*-*M-240-GB2312.1980-1
 - ADECW-Kaiti-Medium-R-Normal--*-340-*-*M-340-GB2312.1980-1

Table 5–3 shows the font names, in XLFD format, of several miscellaneous Chinese screen fonts.

Table 5–3: XLFD of Miscellaneous Chinese Screen Fonts

XLFD Font Name	Character Set
-ADECW-Screen-Medium-R-Normal--*-180-*-*M-80-iso8859-1	ISO Latin-1
-ADECW-Screen-Medium-R-Normal--*-180-*-*M-80-DEC-DECctrl	DEC Display Control
-ADECW-Screen-Medium-R-Normal--*-180-*-*M-80-DEC-DECsuppl	DEC Supplemental
-ADECW-Screen-Medium-R-Normal--*-180-*-*M-80-DEC-DECtech	DEC Technical
-ADECW-Screen-Medium-R-Normal--*-180-*-*M-80-DEC-DRCS	DEC DRCS
-ADECW-Screen-Medium-R-Normal--*-240-*-*M-120-iso8859-1	ISO Latin-1
-ADECW-Screen-Medium-R-Normal--*-240-*-*M-120-DEC-DECctrl	DEC Display Control
-ADECW-Screen-Medium-R-Normal--*-240-*-*M-120-DEC-DECsuppl	DEC Supplemental
-ADECW-Screen-Medium-R-Normal--*-240-*-*M-120-DEC-DECtech	DEC Technical
-ADECW-Screen-Medium-R-Normal--*-240-*-*M-120-DEC-DRCS	DEC DRCS

5.1.2 Bitmap Font Samples

Figure 5–1 through Figure 5–6 illustrate samples of Chinese fonts.

Figure 5-1: Sung Font Sample

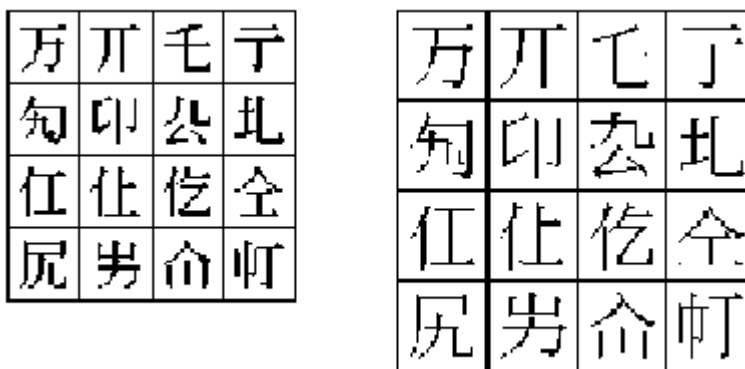

Figure 5-2: Hei Font Sample

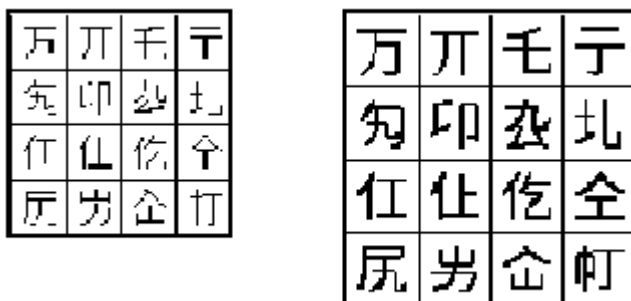

Figure 5-3: Songti Font Sample



Figure 5-4: Heiti Font Sample

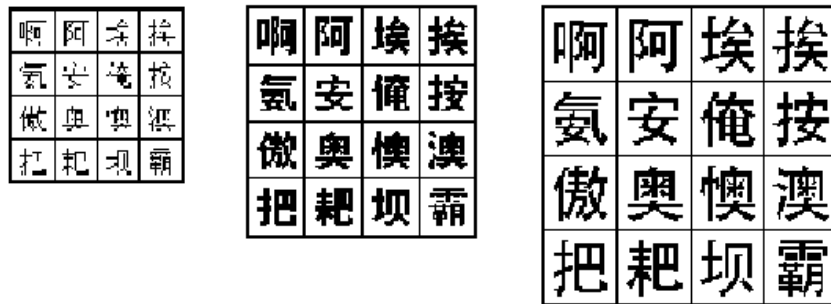

Figure 5-5: Fangsongti Font Sample

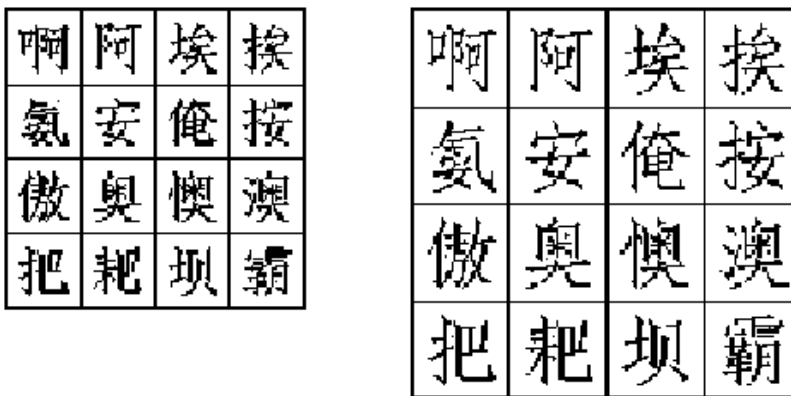
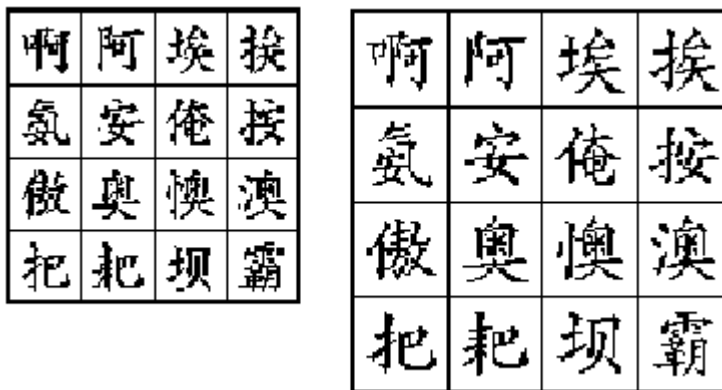

Figure 5-6: Kaiti Font Sample



5.1.3 Font Encodings

The X Consortium registers names for font encodings that are used in XLFDs. However, no names currently are registered for CNS 11643 and DTSCS. Therefore, they are currently supported as Compaq private encodings as shown in Table 5-4.

Table 5-4: Chinese DECwindows Font Encodings

Character Set	Character Set Registry
CNS 11643-1986	DEC.CNS11643.1986-2
DTSCS	DEC.DTSCS.1990-2

Since the X Window System provides only basic Xlib functions for handling 8-bit and 16-bit characters, the 4-byte data representation of DTSCS is trimmed to remove the two leading bytes, C2 CB, to form a 2-byte encoding. DECwindows applications should either preprocess the 4-byte data and then handle them with the low level Xlib functions or handle Chinese strings with the internationalized text drawing functions provided by X11R6 Xlib or Motif Toolkit.

Figure 5-7 and Figure 5-8 illustrate these two encoding schemes.

Figure 5-7: CNS 11643-1986 Font Encoding Scheme

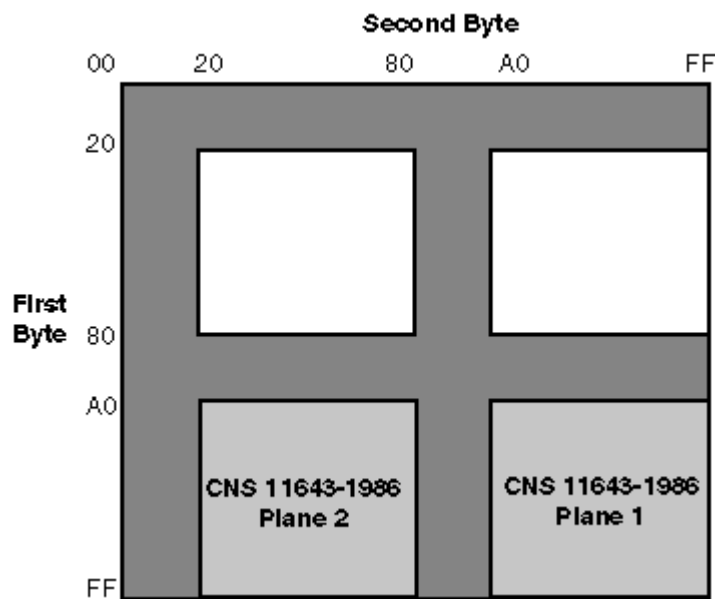
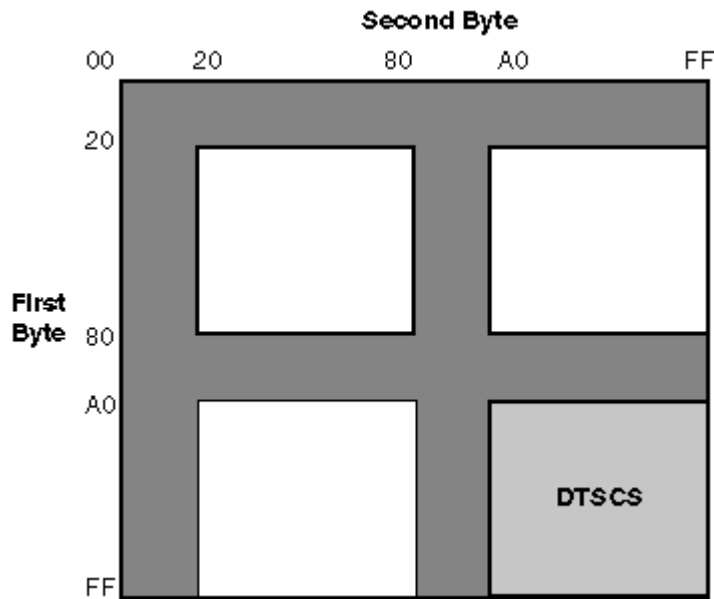

Figure 5–8: DTSCS Font Encoding Scheme



Vendors may adopt different encoding schemes or even different character sets to produce their fonts. The fonts supplied by Compaq are all in the encoding schemes defined in this section. To allow you to run applications on third-party workstations on which different font encodings are installed, the Compaq Tru64 UNIX implementation of X11R6 Xlib supports the conversion of encodings during text display.

Table 5–5 shows these encoding conversions.

Table 5–5: Font Encoding Conversion

Character Set	Convert From	Convert To
Taiwanese EUC	euctw-1 (plane 1)	dec.cns11643.1986-2
	euctw-2 (plane 2)	dec.cns11643.1986-2
	euctw-3 (plane 3)	dec.dtscs.1990-2
	euctw-4 (plane 4)	dec.dtscs.1990-2
Big-5	big5-0	dec.cns11643.1986-2

For Simplified Chinese, the X Window System defines two encodings for the GB2312-80 character set as shown in Table 5–6.

Table 5–6: Chinese DECwindows Font Encodings

Encoding	Character Set Registry
GL	GB2312.1980-0
GR	GB2312.1980-1

Figure 5–9: GB2312-80 Font Encoding Schemes

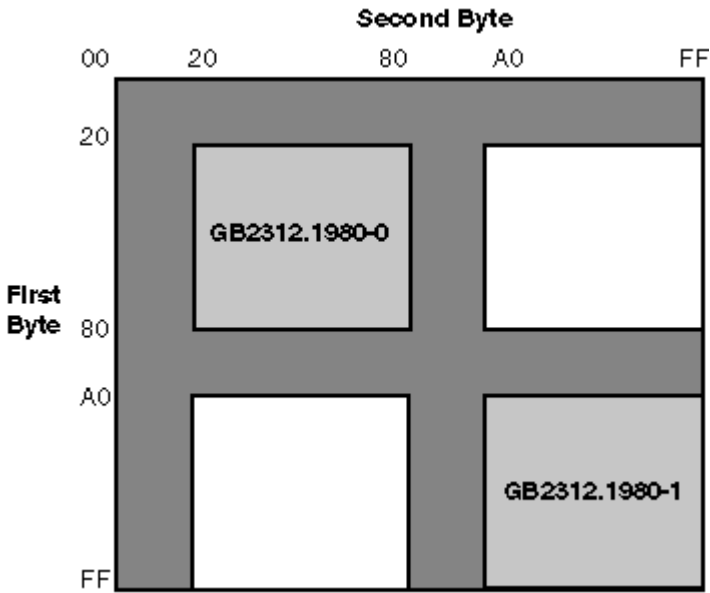

The Chinese DECwindows fonts supplied by Compaq are all in GR encoding. To allow you to run applications on third-party workstations on which only GL-encoded fonts are installed, the Compaq Tru64 UNIX implementation of X11R6 Xlib supports the conversion of GR encoding to GL encoding for text drawing and measurement, as shown in Table 5–7.

Table 5–7: GR to GL Font Encoding Conversion

Convert From	Convert To
gb2312.1980-1	gb2312.1980-0

For details, see *Writing Software for the International Market*.

5.1.4 Specifying Fonts in DECwindows Applications

Table 5–8 and Table 5–9 show the default fonts used in the Motif Toolkit.

Table 5–8: Traditional Chinese Default Fonts

XLFD Font Name	Character Set
-ADECW-Screen-Medium-R-Normal--*-180-*-*M-80-iso8859-1	ISO8859-1
-ADECW-Screen-Medium-R-Normal--*-180-*-*M-160-DEC.CNS11643.1986-2	DEC.CNS11643.1986-2
-ADECW-Screen-Medium-R-Normal--*-180-*-*M-160-DEC.CNS11643.1986-2-UDC	DEC.CNS11643.1986-2-UDC
-ADECW-Screen-Medium-R-Normal--*-180-*-*M-160-DEC.DTSCS.1990-2	DEC.DTSCS.1990-2
-ADECW-Screen-Medium-R-Normal--*-180-*-*-*-*	Fontset

Table 5–9: Simplified Chinese Default Fonts

XLFD Font Name	Character Set
-ADECW-Screen-Medium-R-Normal--*-180-*-*M-80-iso8859-1	ISO8859-1
-ADECW-Screen-Medium-R-Normal--*-180-*-*M-160-GB2312.1980-1	GB2312.1980-1
-ADECW-Screen-Medium-R-Normal--*-180-*-*M-160-GB2312.1980-UDC	GB2312.1980-UDC
-ADECW-Screen-Medium-R-Normal--*-180-*-*-*-*	Fontset

To override the default fonts of a traditional Chinese DECwindows application, you should specify the ISO Latin-1, DTSCS, and CNS11643 (UDC) fonts as well as the Chinese fontset when creating widget instances. For a Simplified Chinese DECwindows application, you should specify the ISO Latin-1, GB2312-80, and extended GB (UDC) fonts as well as the Chinese fontset when creating widget instances. For details, see *Writing Software for the International Market*.

5.2 Outline Fonts

The Compaq Tru64 UNIX software provides the following traditional and Simplified Chinese outline fonts for printing on PostScript printers and for display through Level II Display PostScript extension.

For traditional Chinese:

- Sung-Light-CNS11643
- Hei-Light-CNS11643

For Simplified Chinese:

- XiSong-GB2312-80
- Hei-GB2312-80

The encoding of this font is the same as that illustrated in Figure 5–7 and Figure 5–9.

These Chinese outline fonts have the following uses:

- Printing on PostScript printers. For details see Chapter 8, Chinese Printing Support.
- Displaying through the R6 X Windows System Type 1 rasterizer. To use these outline fonts, add the `$I18NPATH/usr/lib/X11/fonts/TChinesePS` and `$I18NPATH/usr/lib/X11/fonts/SChinesePS` directories to your font path with the following command:

```
% xset +fp $I18NPATH/usr/lib/X11/fonts/TChinesePS,  
$I18NPATH/usr/lib/X11/fonts/SChinesePS
```

This is done automatically when the outline fonts are installed.

- Displaying through Display PostScript. You can view PostScript files with Chinese characters using the CDA Viewer or through the Display PostScript extension.

5.2.1 XLFD Font Names of Chinese Outline Fonts

To use the Chinese outline fonts through the Type 1 rasterizer, you can specify the font names in XLFD (X Logical Font Description) format in your application programs or in the application resource files, just like ordinary DECwindows bitmap fonts.

To specify the XLFD font name of an outline font, you should replace the fields currently marked with 0 (zero) with the following information:

- Field 1 — The font height in number of dots. An asterisk (*) usually is entered in this field.
- Field 2 — The font height in point size. For example, you can enter 240 to specify a 24-point font.
- Fields 3 and 4 — The X- and Y-resolution. They usually have the value of 75 or 100.
- Field 5 — The average font width in point size. An asterisk (*) usually is put in this field.

For example, if you want to use a 48-point font of the Sung-Light-CNS11643 family for a 100 dpi display device, you would specify:

```
-dyna-sung-medium-r-normal--*-480-100-100-m-*-CNS11643.1986
```

5.3 TrueType Fonts

The operating system provides both screen and printer TrueType fonts for Chinese characters sets. The following sets of Simplified Chinese TrueType fonts are installed as the default fonts for the DEC Hanzi, GBK, and GB18030 codesets.

DEC Hanzi Fonts:

FangSong

```
-css_dongwen-fangsong-medium-r-normal--0-0-0-0-c-0-gb2312.1980-0  
-css_dongwen-fangsong-medium-r-normal--0-0-0-0-c-0-gb2312.1980-1  
-css_dongwen-fangsong-medium-r-normal--0-0-0-0-c-0-iso8859-1
```

HeiTi

```
-css_dongwen-heiti-medium-r-normal--0-0-0-0-c-0-gb2312.1980-0  
-css_dongwen-heiti-medium-r-normal--0-0-0-0-c-0-gb2312.1980-1  
-css_dongwen-heiti-medium-r-normal--0-0-0-0-c-0-iso8859-1
```

KaiTi

```
-css_dongwen-kaiti-medium-r-normal--0-0-0-0-c-0-gb2312.1980-0  
-css_dongwen-kaiti-medium-r-normal--0-0-0-0-c-0-gb2312.1980-1  
-css_dongwen-kaiti-medium-r-normal--0-0-0-0-c-0-iso8859-1
```

SongTi

```
-css_dongwen-songti-medium-r-normal--0-0-0-0-c-0-gb2312.1980-0  
-css_dongwen-songti-medium-r-normal--0-0-0-0-c-0-gb2312.1980-1  
-css_dongwen-songti-medium-r-normal--0-0-0-0-c-0-iso8859-1
```

GBK Fonts:

FangSong

```
-css_dongwen-fangsong-medium-r-normal--0-0-0-0-c-0-gbk-1  
-css_dongwen-fangsong-medium-r-normal--0-0-0-0-c-0-iso8859-1
```

HeiTi

```
-css_dongwen-heiti-medium-r-normal--0-0-0-0-c-0-gbk-1  
-css_dongwen-heiti-medium-r-normal--0-0-0-0-c-0-iso8859-1
```

KaiTi

-css_dongwen-kaiti-medium-r-normal--0-0-0-0-c-0-gbk-1
-css_dongwen-kaiti-medium-r-normal--0-0-0-0-c-0-iso8859-1

SongTi

-css_dongwen-songti-medium-r-normal--0-0-0-0-c-0-gbk-1
-css_dongwen-songti-medium-r-normal--0-0-0-0-c-0-iso8859-1

GB18030 Fonts:

FangSong

-css_dongwen-fangsong-medium-r-normal--0-0-0-0-c-0-iso10646-1
-css_dongwen-fangsong-medium-r-normal--0-0-0-0-c-0-iso8859-1

HeiTi

-css_dongwen-heiti-medium-r-normal--0-0-0-0-c-0- iso10646-1
-css_dongwen-heiti-medium-r-normal--0-0-0-0-c-0-iso8859-1

KaiTi

-css_dongwen-kaiti-medium-r-normal--0-0-0-0-c-0- iso10646-1
-css_dongwen-kaiti-medium-r-normal--0-0-0-0-c-0-iso8859-1

SongTi

-css_dongwen-songti-medium-r-normal--0-0-0-0-c-0- iso10646-1
-css_dongwen-songti-medium-r-normal--0-0-0-0-c-0-iso8859-1

Keyboards

The Compaq Tru64 UNIX operating system supports the following Chinese keyboard types:

- LK201
- LK401
- PCXAL

There are some variants for these keyboards in different countries. For example, in Taiwan, the LK201-D variant has additional symbols printed on the keycaps for different Chinese input methods. The figures in this chapter show some of these Chinese keyboard layouts. You can find online copies of these figures at the location specified. These figures are in .ddif format.

Figure 6–1: LK201-D Keyboard Layout

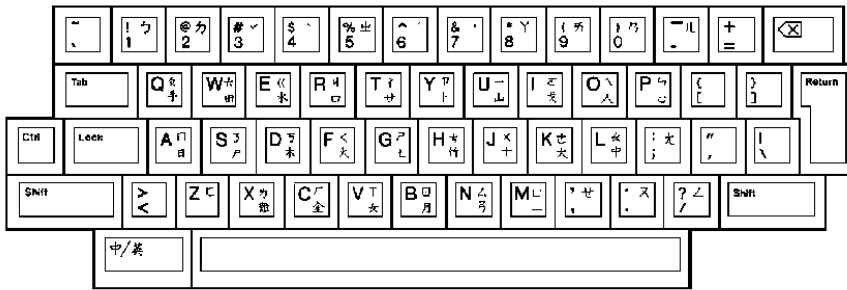

Required Keymap: us_lk201re
Location of file: /usr/lib/cda/hanyu-lk201d-100.ddif

Figure 6–2: LK401-D Keyboard Layout

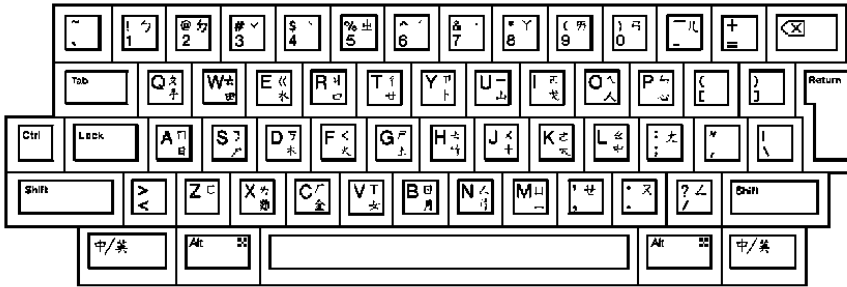

Required Keymap us_lk401aa
Location of file: /usr/lib/cda/hanyu-lk401d-100.ddif

Figure 6-5: Numeric Keypad for 5-Stroke Input Method

PF1	PF2	PF3	PF4
7	8	9	-
4 捺 ㇇	5 折 乙	6	,
1 横 一	2 竖 丨	3 撇 ㇇	Enter
0		.	

Location of file: /usr/lib/cda/hanzi-keypad-100.ddif

Input Methods

This chapter describes the input methods for entering Chinese characters. There are two groups of input methods, one for traditional Chinese and the other for Simplified Chinese. Traditional Chinese has the following input methods:

- Full-form alphabets
- Tsang-Chi (倉頡)
- Quick Tsang-Chi, also known as Easy (速成)
- Phonetic (注音)
- Internal Code (內碼)
- Phrase Input Method (片語)
- Symbol Input (符號)

Simplified Chinese has the following input methods:

- Full-form alphabets
- 5-Stroke (五笔画)
- 5-Shape (五笔字型)
- Pin-Yin, or Phonetic (拼音)
- Qu-Wei or Row-Column in GB2312-80 (国标区位码)
- Telex Code (电报码)
- Phrase Input Method (片语)
- ItABC or Intelligent ABC

This chapter also describes:

- The mechanism for activating and deactivating Chinese input methods
- The mechanism for switching input methods
- The DECwindows Motif interface and its customization

7.1 Activating and Deactivating Chinese Input Methods

This section describes how to activate and deactivate the Chinese input methods for character-cell terminal applications, DECwindows Motif applications, and CDE applications.

7.1.1 Character–Cell Terminal Applications

For character-cell terminal applications, traditional and Simplified Chinese input methods are implemented by the firmware of the VT382-D traditional Chinese terminal and VT382-C Simplified Chinese terminal respectively, or incorporated in the terminal emulation software, such as Hanyu DECterm for the former and Hanzi DECterm for the latter. Applications do not need to provide their own support for Chinese input. They can rely on the terminal or emulation software to provide the input method services.

Hanyu DECterm and Hanzi DECterm are considered as part of the DECwindows Motif applications. Therefore, the activating and deactivating method follows those of DECwindows Motif, discussed in Section 7.1.2.

On VT382-D or VT382-C terminals, you select the input mode using the Compose key, which is located on the lower-left side of the main keyboard. On the Chinese version of LK201 or LK401 keyboard (that is, LK201-C, LK201-D, LK401-C or LK401-D), the Compose key is labeled as 中/英. For details, see Chapter 6.

Once the Chinese input mode is activated, the firmware of the terminal or the input methods incorporated in DECterm automatically compose Chinese characters and return the input data as appropriate.

7.1.2 DECwindows Motif Applications

For DECwindows Motif applications, Chinese input methods are implemented in the form of independent processes called input servers. These Chinese input servers are X client processes that can work on a standard X server provided the X server has the required Chinese fonts installed. This means that the Chinese input server can run on any system which can access your X display device, including the device itself.

Although the codesets returned by traditional and Simplified Chinese input servers are fixed, the Compaq Tru64 UNIX software allows you to connect applications to the input servers using any valid Chinese locale. The Compaq Tru64 UNIX software provides the required codeset conversion.

The traditional Chinese input server provided with the Compaq Tru64 UNIX software is interoperable with all existing DECwindows Motif /Hanyu platforms, including OpenVMS DECwindows Motif /Hanyu and UWS/Hanyu. The Simplified Chinese input server provided with the Compaq Tru64 UNIX software is interoperable with all existing DECwindows Motif /Hanzi platforms, including OpenVMS DECwindows Motif /Hanzi and UWS/Hanzi. Both input servers also provide input method services to the R6 X library (Xlib) supported by the Compaq Tru64 UNIX software. You can write internationalized applications using the standard R6 application programming interface and communicate with this input server. For details about developing internationalized software with X11R6, see *Writing Software for the International Market*.

Before you can input Chinese data, you must start the Chinese input server on your workstation or any system on your network that can be accessed by your workstation.

English and Chinese user interfaces are provided, so be sure to set the correct session language before starting the input server. There are several ways to start the Chinese input server:

- Using the Session Manager

You can start the Chinese input server after logging in to a session by selecting Hanyu IM or Hanzi IM from the Applications menu of the Session Manager, just like starting an ordinary DECwindows application.

- Automatic Startup of the Input Server

If you start up your session in one of the traditional Chinese locales, by default, the Hanyu IM menu item is added to the Session Manager's Automatic Startup list. Hanzi IM is the default for Simplified Chinese. When you log in, the input server starts automatically. If you do not want to auto-start the input server, you can remove this item from the Automatic Startup list by using the Session Manager's Customize menu.

- Using a Command

You can start the input server on a workstation that you are using by entering one of the following commands:

```
% /usr/bin/X11/dxhanyuim &  
% /usr/bin/X11/dxhanziim &
```

You can start the input server on a remote system for Hanyu IM by entering the following command on that system:

```
% setenv DISPLAY <display-name>:0  
% /usr/bin/X11/dxhanyuim &
```

For Hanzi IM, enter the following commands:

```
% setenv DISPLAY <display-name>:0
% /usr/bin/X11/dxhanziim &
```

In these examples, <display-name> is the display name of your workstation.

After you invoke the Chinese input server, DECwindows Motif applications that have been internationalized for Chinese can communicate with it to provide input method services.

Note

Applications that are started before Hanyu IM or Hanzi IM cannot connect to the input server. Therefore, Hanyu IM or Hanzi IM should be the first item on the Automatic Startup list. However, if the application contains an `XmText` or `XmTextField` widget with the reconnectable resource set to `True`, the application is able to establish a connection with the input server if the application starts before the input server or when the application is running and the input server stops and restarts. For more information, see the operating system reference pages for `XmText(3X)` and `XmTextField(3X)`.

7.1.3 CDE Applications

For CDE applications, Chinese input methods are implemented by input servers. Before you can input Chinese data, you must start the Chinese input server on your workstation or on any system that can be accessed by your workstation through the network.

Both English and Chinese user interfaces are provided. Make sure you set up the correct session language before you start the input server.

There are two ways to start the Chinese input servers in CDE:

- Automatic Startup of the Input Server

If Chinese is selected on the CDE login menu, the Chinese input server starts automatically. When you log in, the following script runs:

```
/usr/dt/config/Xsession.d/0020.dtims
```

The value of the `DTSTARTIMS` environment variable determines whether the script will automatically start the specified Chinese input server.

- Using a Command

You can enter one of the following commands to start the input server on a workstation you are using:

```
% /usr/bin/X11/dxhanyuim &
% /usr/bin/X11/dxhanziim &
```

You can enter one of the following commands on a remote system to start the input server on that system for Hanyu IM:

```
% setenv DISPLAY <display-name>:0
% /usr/bin/X11/dxhanyuim &
```

For Hanzi IM, enter the following command:

```
% setenv DISPLAY <display-name>:0
% /usr/bin/X11/dxhanziim &
```

In these examples, `<display-name>` is the display name of your workstation.

After you invoke the Chinese input server, the CDE applications that are internationalized to support Chinese can communicate with it to provide input method services.

Note

Applications that are started before Hanyu IM or Hanzi IM cannot connect to the input server. Therefore, Hanyu IM or Hanzi IM should be the first item on the Automatic Startup list. However, if the application contains an `XmText` or `XmTextField` widget with the `reconnectable` resource set to `True`, the application is able to establish a connection with the input server if the application starts before the input server or when the application is running and the input server stops and restarts. For more information, see the operating system reference pages for `XmText(3X)` and `XmTextField(3X)`.

7.2 Switching Input Method

Table 7-1 shows the key sequences for toggling between the English and Chinese input modes.

Table 7–1: Key Sequences that Invoke Chinese Input Method

Terminal or Keyboard Type	Default Key Sequence
VT382-D	[Compose]
VT382-C	
DECwindows Motif	
LK201	[Compose/Space]
LK401	[Compose]
PCXAL	[Alt/Space] for traditional Chinese [Ctrl/Space] for Simplified Chinese

Note

You can use the input server options menu to customize the key sequences used to invoke the Chinese input method.

Table 7–2 and Table 7-3 show the key sequences for selecting a specific traditional Chinese or Simplified Chinese input method once you are in Chinese input mode.

Table 7–2: Key Sequences Used to Select Traditional Chinese Input Method

Input Method	Default Key Sequence
Full-Form Alphabets	[Shift/Space]
Tsang—Chi (倉頡)	[F6]
Quick Tsang—Chi (倉頡)	[F7]
Internal Code (內碼)	[F8]
Phrase (片語)	[F9]
Phonetic (注音)	[F10]
Symbol Input (符號)	[Z] (in Tsang—Chi or Quick Tsang—Chi mode)

Table 7–3: Key Sequences Used to Select Simplified Chinese input Method

Input Method	Default Key Sequence
Intelligent ABC	[F4]
Phrase Input (片语)	[F5]
5-Stroke (五笔画)	[F6]
Qu-Wei (国标区位码)	[F7]
Pin-Yin (拼音)	[F8]
Telex Code (电报码)	[F9]
5-Shape (五笔字型)	[F10]

Note

You can use the Options menu to customize the key sequences used to select the input method.

In standard Motif, the function key [F10] is defined as the accelerator of the pull-down menu bar. In DECwindows Motif, the menu accelerator by default is [Ctrl/F10] so that [F10] can be used to invoke the Phonetic Input Method. To make your DECwindows Motif applications Motif compliant, insert the following line in your \$HOME/.Xdefaults file:

```
*menuAccelerator: Ctrl <Key> F10:
```

Note

If you change [F10] to the menu accelerator, you cannot invoke the Phonetic Input Method unless you change the invocation key to another key sequence.

7.3 Motif Interface Input Method

You can interact with the Chinese input server through a Motif-style user-interface. This interface allows an input method to provide feedback about the data being edited, to help you compose a character, list choices for selection, provide options for customizing the input server, and so on.

7.3.1 Input Areas

The X Input Method specification defines the three input areas shown in Table 7–4.

Table 7–4: Window Input Areas

Region	Description
Auxiliary area	An option menu helps you customize the Chinese input methods and the input method window.
Status area	Critical information about the internal state of the Chinese input methods is displayed in this area.
Pre-edit area	The intermediate text that is being composed is displayed in this area, which also displays a list of valid candidates for the input key sequences.

7.3.2 Interaction Styles

The use of the input areas depends on the interaction style (or pre-edit style) selected for the application. The Chinese input server supports two interaction styles:

- Root Window Interaction
- Off-the-Spot Interaction

7.3.2.1 Root Window Interaction

You can choose the root window interaction style if you want to display the pre-edit data in an input window that is separate from the application window. You can scale and move the input window to meet your preferences. If you want to free up more screen space, you can iconize the input method window. You can also choose to display pre-edit data in vertical or horizontal layout.

Figure 7-1: Chinese Root Window Interaction Style

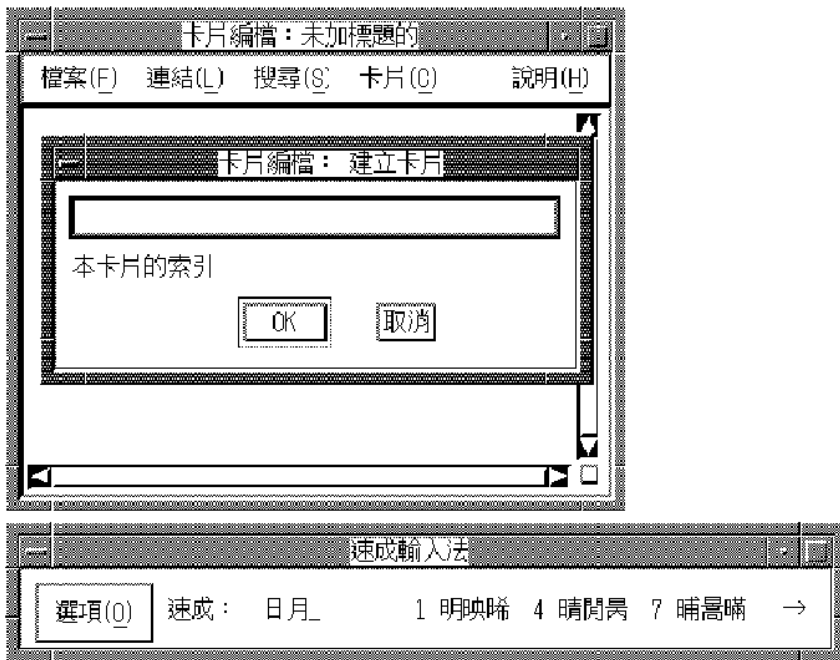
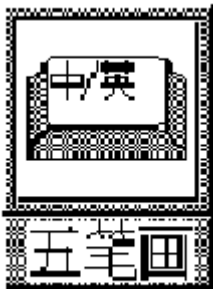

Figure 7-2: Chinese Input Window Icon



You can continue to input Chinese characters through a Chinese application window when the input window is iconized. The input state is displayed on the icon title, which is updated according to the input mode and the input focus. If you want to see the pre-edit data, you can double click the icon to redisplay the input window.

7.3.2.2 Off-the-Spot Interaction

If you want to display the pre-edit data in a fixed location of the application window, you can choose the off-the-spot interaction style. With this interaction style, the Chinese input server creates the input window at the bottom of the application window. You need not refer to the root window and you can iconize it to save screen area.

Figure 7–3: Off-the-Spot Interaction Style



You can specify the priority of the interaction styles of DECwindows Motif or CDE applications by specifying the VendorShell resource, `XmNpreeditType`. By default, the resource value is `overthespot`, `offthespot`, `root`, `onthespot`. This list is in priority order. The first style is used if available in an input method, else the second, and so on.

There are two ways to choose your preferred interaction style:

- Use the `-xrm` command line option to specify the resource value when you start an application. For example, the following command starts CDE Calendar Manager with the root window interaction style:

```
% dtcm -xrm '*preeditType: root,offthespot' &
```

To start CDE Calendar Manager with the off-the-spot interactive style, you can enter:

```
% dtcm -xrm '*preeditType: offthespot,root' &
```

- For DECwindows Motif, use the Session Manager's Options menu in XDM:
 - From the Session Manager's Options menu, select Input Method...
 - In the popup Input Method Options window, click on the appropriate pre-edit style button

The `XmNpreeditType` resource is set to a priority list beginning with the pre-edit style that you have chosen.

After you select your preferred interaction style, the applications you invoke start up with the new setting.

- For CDE, you can invoke the `dtimsstart` application to change the input method and the input style of the current input method.

Note

Some applications, such as DECterm, may provide their own user interface to handle interaction styles. Those mechanisms may override the methods described here.

7.3.3 Input Server Operations

When you start a Chinese input server, no application is connected to it and the title bar indicates that there is no connection. When an internationalized application starts in a Chinese locale, the string “ 英語 ” is displayed in the status area for `dxhanyuim`, and “ 英语 ” is displayed for `dxhanziim`, indicating that the application is connected to the Chinese input server and the mode is English. If you invoke a Chinese input method, the input state displayed in the status area and the title bar is updated accordingly. If you change the input focus to a noninternationalized application window, the title bar of the input window changes to indicate there is no connection.

The input server can maintain an individual state of composition for different input contexts or application windows. In addition, under the root window interaction style, each application window can be associated with its own attributes, such as font size, font style, layout, input window size, and position. You can set the input focus to an application window and then compose a Chinese character or customize the input window.

The input server retains the composing state and input window attributes. Thus, when you bring an application window into focus (that is, from the background to the foreground), the input server restores its original composing state and attributes. For example, if you are using an input window under the 5-Stroke input method, then shift focus to an input window under the Pin-Yin input method, when you bring the original window back in focus, the 5-Stroke input method will be active.

7.3.4 Options Menu

The auxiliary area of the input window provides an Options menu that you use to customize the input server. You can click on the Options button to access the customization pull-down menu. The menu provides the following options:

- Vertical Layout
- Horizontal Layout
- Select Phrase Input Class
- User Phrase Database
- System Phrase Database
- Current Window
- Input Method Customization
- Help
- Quit

7.3.4.1 Vertical Layout

You can choose the Vertical Layout option only if the current layout is horizontal. When you choose this option, the input window and the layout of its contexts immediately display in a vertical orientation. The vertical input window remains at the same origin.

7.3.4.2 Horizontal Layout

You can choose this option only if the current layout is vertical. When you choose this option, the input window and the layout of its context immediately display in a horizontal orientation. The horizontal input window remains at the same origin.

7.3.4.3 Select Phrase Input Class

You can use the Select Phrase option to customize the phrase input mode. DECwindows Motif shares the phrase databases that are created and managed by the base operating system Phrase Utility. After you create a phrase database and define your phrases, both character-cell terminal applications and DECwindows Motif applications can use the data for phrase input. In order to use the phrase databases, the LANG environment variable must be set to reflect the required codeset (for example, zh_TW.dechanyu). For details about the Phrase Utility and phrase definition file, see *Writing Software for the International Market*.

The Select Phrase Input Class option allows you to focus on a particular class of phrases during phrase input. When you choose this option, a dialog box pops up and you can select the phrase class that you want to use. To select all classes, you choose the * option. If you do this, the phrase input method searches all classes of phrase definitions for the phrase code that you entered.

When there is more than one phrase that matches the phrase definition, a list box is displayed. To choose the right phrase definition, select the appropriate item in the list box.

7.3.4.4 User Phrase Database

The Phrase Input method allows you to access two phrase definition databases: the system phrase database and the private user phrase database. The system phrase database is for public access by all users using your system. It should be created and modified by your system administrator. You can also create and maintain your own private phrase database for storing your frequently used phrases. This is called the user phrase database.

Note

The databases that you can access are the ones available on the system on which you start your Chinese input server.

For details about creating a phrase database, see *Writing Software for the International Market*.

If you choose this option, you will access your private user phrase database.

7.3.4.5 System Phrase Database

If you choose the System Phrase Database option, you will access the system phrase database.

7.3.4.6 Current Window

The Current Window option allows you to customize the attributes of a specific application window.

Note

The Current Window option is available only if you chose root window as your interaction style and you focused to an internationalized application input area. Otherwise, this option is dimmed out. If you choose the off-the-spot interaction style, the application determines the attributes.

When you choose this option, a dialog box pops up and the following options are displayed:

- Font Size

You can choose the font size for displaying pre-edit data. Click on either the Big Font or Small Font toggle buttons.

- Font Typeface

You can choose the font typeface to be used in the input window. To choose the font typeface in a traditional Chinese input server, click on one of the following toggle buttons:

- Hei
- Sung
- Screen

To choose the font typeface in a Simplified Chinese input server, click on one of the following toggle buttons:

- Heiti
- Songti
- Kaiti
- FangSongti
- Screen

You can define a typeface that does not exist in the options list in the Chinese input server resource file. This typeface will be displayed beside the Other: label in the customization window.

- Line Spacing

The Chinese input server can display pre-edit data on more than one text line. Usually, this happens when a list of items is displayed for your selection. You can use the Line Spacing option to specify the spacing between text lines in pixels. To adjust the line spacing, drag the Line Spacing slider or move the pointer to the desired position on the slider and click MB1.

- **Foreground and Background Colors**

You can customize the foreground and background colors of the input window.

For monochrome display, the following options are provided:

- Dark Text, Light Background
- Light Text, Dark Background

For color display, you can choose from a palette of colors to design a visually pleasing input window. To customize the foreground or background color, you should first select the color that you want to change by clicking one of the following toggle buttons:

- Input Window Foreground Color
- Input Window Background Color

A color mixing window pops up in which you can mix the color using the three sliders, which represent the intensities of the primary colors. The modified color is displayed in the right half of the color box while the left half displays the original color.

7.3.4.7 Input Method Customization

There are several customizable attributes that apply to all input windows.

In the traditional Chinese input server, the customizable options are:

- Default Input Method
- Bell Volume
- EDPC support
- Invocation Key

In the Simplified Chinese input server, the customizable options are:

- Default Input Method
- Active Input Method
- Bell Volume
- Display 5-Shape Radicals
- Word Frequency and Bixing Input – Intelligent ABC input method only
- Invocation Key

When you choose the Input Method Customization option, a dialog box displays in which you can customize the following attributes:

- Default Input Method

When the Chinese input server is activated, the default Chinese input method is set to the one you choose by means of this option. The input methods you can choose in the traditional Chinese input server (dxhanyuim) are:

- Alphabetic
- Tsang-chi
- Quick Tsang-chi
- Phonetic
- Internal code
- Phrase

The input methods you can choose in the Simplified Chinese input server (dxhanziim) are:

- Alphabetic
- Phrase
- 5-Stroke
- Qu-Wei (Row-Column)
- Pin-Yin
- Telex Code
- 5-Shape
- Intelligent ABC

- Active Input Method

The active input method allows you to decide which input methods can be activated at run time. By default, all input methods, except for the Simplified Chinese Telex input method, are active.

You use the Active Input Method list to add or remove an input method on the Active list. If you remove an input method from the Active list, you can no longer select that input method with an invocation key.

- Bell Volume

When you make an error while composing a Chinese character, the bell rings to alert you. To adjust the bell volume, drag the Bell Volume slider or move the pointer to the desired position on the slider and click MB1.

- EDPC support (in `dxhanyuim` only)

The traditional Chinese input server supports the input of both CNS 11643 and DTSCS (that is, EDPC) characters. However, you can choose to disable the input of EDPC characters so that the data that you can enter contains only CNS 11643 characters. This option is useful if you need to prepare Chinese data and interchange it with systems supporting only CNS 11643.

To enable or disable the input of EDPC characters, click on the EDPC Characters Input button.

- Display 5-Shape Radicals (in `dxhanziim` only)

If you choose the Input Method Customization option while running the 5-Stroke, Pin-Yin, Qu-Wei, or Telex input methods on the Simplified Chinese input server, a dialog box is displayed in which you can choose the Display 5-Shape Radicals option.

When you choose the Display 5-Shape Radicals option, the character candidates displayed in the 5-Stroke, Pin-Yin, Qu-Wei, or Telex input methods are associated with the 5-Shape key sequences required to enter those characters in the 5-Shape input method. You can use this option as an instructional tool. For example, if this option is active and you enter a character using the Pin-Yin input method, the resulting display provides instruction on the 5-Shape radical sequence required to produce that Pin-Yin character in the 5-Shape input method.

- Word Frequency and Bixing Input – Intelligent ABC input method only

If you choose the Input Method Customization option while running the Intelligent ABC input method on the Simplified Chinese input server, a pull-down menu is displayed in which you can automatically adjust word frequency in repeated selections and specify bixing input in repeated selections.

These property settings are described in Section 7.17.1, Basic Input Methods.

- Invocation Key

The key sequences for invoking and switching Chinese input methods are set by default. You can change these default key sequences to meet your personal preference or working style. This option allows you to customize the following key sequences for both `dxhanyuim` and `dxhanziim`:

- Start Input Method
- End Input Method
- Phrase Input

- Invoke Next Input Method
- Full and Half Form Alphabetic Input Method

The following choices are for `dxhanyuim` only:

- Tsang-chi
- Quick Tsang-chi
- Internal Code
- Phonetic

The following choices are for `dxhanzim` only:

- 5-Stroke
- Qu-Wei (Row-Column)
- Pin-Yin
- Telex Code
- 5-Shape
- Intelligent ABC

In the bottom part of the dialog box is an easy-to-use interface where you can customize a key sequence. You can select a trigger key and toggle the on/off state of the Ctrl, Alt, and Shift modifiers. The trigger keys that you can choose include NoSymbol, [F1] through [F20], [Space], [Return], [Compose] and [A] through [Z]. If you choose NoSymbol, no invocation sequence will be provided for the selected action.

For each modifier key, you can select the on/off state with the toggle buttons shown in Table 7-5.

Table 7-5: Modifier State Customization

Modifier	On State	Off State
Ctrl	Ctrl	~Ctrl
Shift	Shift	~Shift
Alt	Alt	~Alt

The tilde (~) sign means that you should not press that modifier key when invoking the action. In addition to the on/off state, you can also deselect both of the states for a modifier key so that neither state is selected. To do this, click the toggle button that is

currently set on. If you deselect a modifier, the input server will accept the invocation key with or without holding the modifier key.

When an invocation key sequence is selected, the state of the toggle switches and the trigger key displayed at the bottom of the dialog box is updated to reflect the current value and the label at the bottom left-hand side changes.

Figure 7-4: Customization of Invocation Key Sequences in dxhanyuim

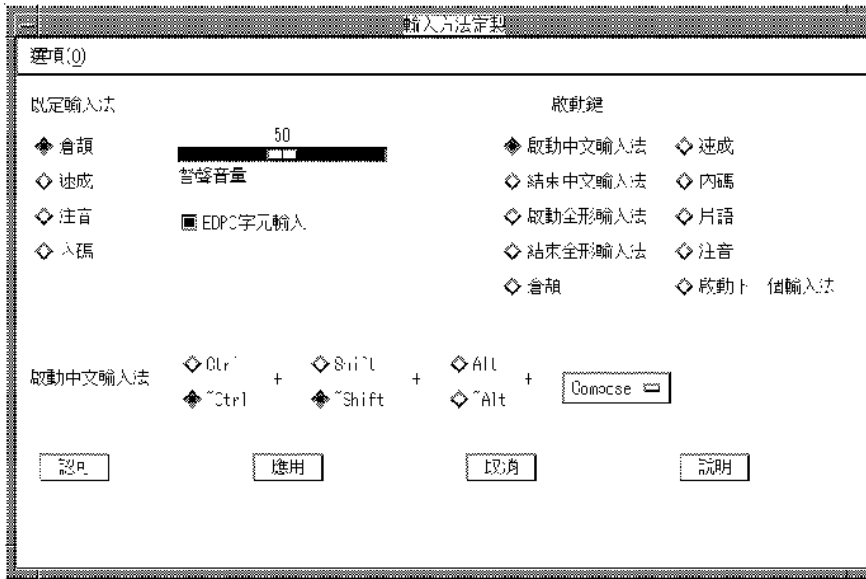
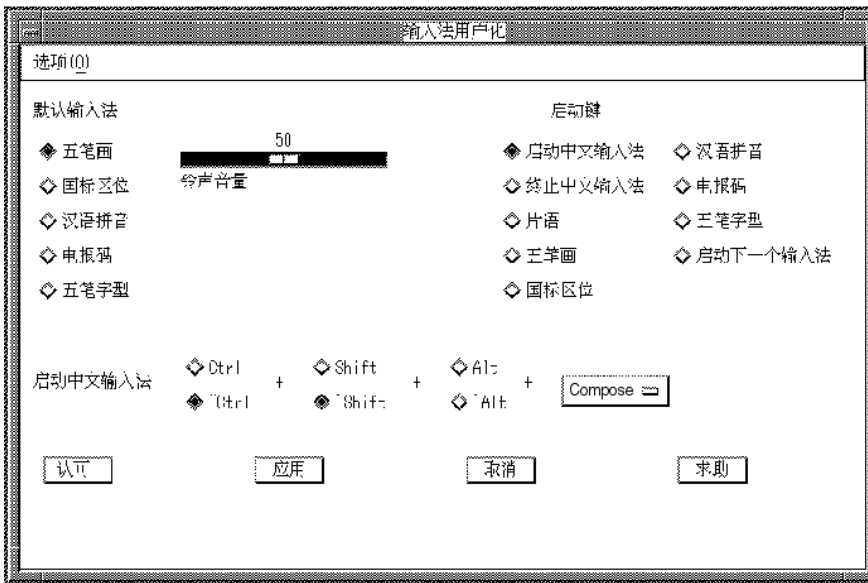

Figure 7-5: Customization of Invocation Key Sequences in dxhanziim



For example, if you want to change the End Input Method key sequence to [Ctrl/Space], select the Ctrl, ~Alt and ~Shift buttons.

To reduce the number of keys required for selecting input methods, set the hot keys for all the input methods to "NoSymbol", and define a key sequence for the Choose Next Input Method option. This method releases the [F6] to [F10] function keys for use by other DECwindows applications. To switch the input method, press the key sequence for Choose Next Input Method and the Chinese input server will cycle through all supported input methods. For example, if you use the Tsang-Chi input method and you want to switch to the internal code input method, press the hot key twice.

7.3.4.8 Help

The Help option provides the following menu items that you use to display help for the Chinese input server:

- Context-Sensitive Help
- Overview
- Using Help
- Product Information

7.3.4.9 Quit

Use the Quit option to terminate the input server. If you select this option, a dialog box pops up and asks if you really want to exit.

7.3.5 Saving Your New Settings

All attributes that you customize with the Current Window and Input Method Customization menus can be saved into a resource file in your login directory. Each customization window provides the following options:

- Save Settings as Defaults
Saves all current attributes as default values. These attributes are saved to a private resource file in your login directory; `.DXhanziim` if you are using `dxhanziim`, and `.DXhanyuim` if you are using `dxhanyuim`.
- Restore system setting
Restores all system default attributes

7.4 Alphabetic Input Methods (dxhanyuim and dxhanziim)

There are two alphabetic input methods available under the English mode; Half Form Alphabet and Full Form Alphabet.

The Half Form Alphabet method allows you to enter uppercase and lowercase English characters, numerals, and symbols marked on the keyboard. Full Form Alphabet allows you to enter 2-byte alphabets, numerals, and symbols defined in the Chinese character sets.

To invoke the Full Form Alphabet input method, press [Shift/Space]. The string “ 全形 ” (full form) is displayed in the status area, as shown in Figure 7-6. Once the prompt appears, all characters that you enter at the keyboard are sent as 2-byte characters.

To exit the Full Form Alphabet input method, press [Shift/Space] again.

Figure 7-6: Full Form Alphabet Input Method

```
A B A B _  
(全形)
```

7.5 Tsang-Chi Input Method (dxhanyuim)

To understand the Tsang-Chi input method, you must understand the concepts of Tsang-Chi root radicals, auxiliary forms, and character-splitting methods.

7.5.1 Tsang–Chi Root Radicals

The Tsang–Chi input method is based on the concept of root radicals. The input method requires a Chinese character to be broken down into various root radicals according to its shape. Altogether 24 Tsang–Chi root radicals have been defined with which almost all existing Chinese characters can be composed. The root radicals are divided into four groups and assigned to the alphabet keys [A] - [Y] (with the exception of the [X] key) on the main keyboard. Table 7–6 a-d illustrate the classification of the root radicals, their corresponding English keys, their auxiliary forms, and the way that they are derived. Table 7–7 is a shorter table for quick reference.

Table 7-6: Tsang-Chi root Radicals Classification

a. Philosophical:

類別	字根 (口訣)	英文號	輔助字形	聯想方式	例子
哲	日	A	日、日	取日的變形。	巳、眉、胃、見
	月	B	冂、冂 心、夕	取月的外形。 取月的變形。	冂、巾、冂、冂 采、受、受、然
	金	C	一 八、儿	取金的部分形。 取一的變形。	弟、丫、曾 克、父、匹
理	木	D	十 十 花	取木的主形。 取十的變形。 取木的主形。	寸、才、干、子 也、皮、五、夫 虎
	水	E	彡 又 水	取水做偏旁之形。 取水的左右重合之形。 取水的變形。	江、河、海、漢 支、雙、又、叔 未、泰、未、未
	火	F	灬 小 小	取火做字尾之形。 取火的上半形。 取小的變形。	杰、然、無、馬 尚、肖、半、紀 东、不、少、紀
類	土	G	去 士	取土做偏旁之形。 取土的變形。	坎、灯、坦、地 吉、寺、志、壬

b. Stroke:

類別	字根 (口訣)	英文鍵	輔助字形	聯想方式	例子
筆	竹 (斜)	H	ノ 厂	斜的定義為ノ。 取ノ的變形。	么、禾、天、八 反、激
	点 (點)	I	· 厶、厂	點的定義為·。 取·的變形。	火、之、南、太 台、公、屋、厚
	十 (交)	J	十	取十的變形。	容、完、來、安 寶、茂、寒、寧
畫	乂 (又)	K	乂 厂 マ	乂的定義為乂。 取乂的部分形。 取厂的變形。	又、引、艾、交 左、有、左、光 雅、深、深、流
	中 (橫)	L	丨 中 并	縱的定義為丨，即上而下。 中亦為縱向，意義相近。 取丨的變形。	川、片、介、查 書、書、初、初、初、初
	一 (橫)	M	一、厂 マ、一	皆取一的變形。	飛、亞、瓜、原 无、石、刁
類	弓 (鈎)	N	丿 一 乙、乙	鈎的定義為丿。 取丿的變形。 取乙的變形。 取一的變形。	了、丁、小、可 乙、定、去、子 月、久、久、少 几、亞、采、也

c. Human Body:

類別	字根 (口訣)	英文鍵	輔助字形	聯想方式	例子
人	人	O	亻 山、人 亻 亻	取人做偏旁之形。 取人做字首之形。 取人的部分形。 取人的變形。	仁、什、行、信 奪、臨、念、內 八、爪、子、之 象、兆、車、家
	心	P	忄 小 匕、匕 匕、匕	取心做偏旁之形。 取心做字尾之形。 取心的變形。 取匕的變形。	忄、社、怪、怡 恭、慕、恭、添 官、比、甸、民 彪、初、武
手	手	Q	扌 丰 丰、丰	取手做偏旁之形。 取手的主形。 取手的變形。	扌、扎、扒、把 夫、奉、奉、丰 夫、奉、丰、丰
	口	R			岡、吧、邑、員

d. Form:

類別	字根 (口訣)	發文鍵	輔助字形	聯想方式	例子
字	尸 (側)	S	コ、匚 丁、冫 冫	側的定義為左右向開口，所以為コ、匚。 取コ、匚的變形。 取冫的部分形。	尹、邑、巨、臣 器、凶、臣、肆 力、习、長、肆 非、聽
	廿 (並)	T	廿 廿、上 非、上 卅	並的定義為兩形相並，所以取廿。 取廿的變形。	草、卉、苗、曲 昔、兵、箭、羊 聯、並
	山 (仰)	U	山 少 し、レ	仰之定義為向上開口，故為山 取山的變形。 取山的變形。	凶、冫、扇、勾 連、巴、亂、氏、氏
形	女 (紐)	V	< レ、以	紐的定義為曲紐，所以為<。 取<的變形。	幻、迎、麗、玄 亡、衣、長
	田 (方)	W	口 冫	方的定義為一方框，內含其他形，所以為口。 取口的變形。	國、因、因、國 四、百、西、壹 尋、尋、尋、尋
	卜 (卜)	Y	一、卜 レ、レ レ、レ	取卜的變形。 取レ的變形。 取レ的變形。	市、卜、上、卓 冬、斗、廻、途 冷、列

Table 7-7: Quick Reference Table of the Tsang-Chi Root Radicals

哲 理 類		筆 畫 類		人 身 類		字 形 類		
日	四 日	竹	ノ 厂	人	、 <	尸	冂 匚 冫	冫 冫
	A	(斜)	H	イ 人	O	(側)	S	
月	冂 一	戈	、 厶	心	匕 乚	廿	什 一 止	止
	ハ 夕		广		七 夕		卅 止 卅	卅
	B	(點)	I		P	(並)	T	
金	ノ 八	十	、	手	丰 士	山	口 夕	夕
	儿				丰		厶 厶	厶 厶
	C	(交)	J	才	Q	(仰)	U	
木	十 卍	大	又 夕	口		女	、 厶	厶
	札		广		厶		厶	
	D	(又)	K		R	(細)	V	
水	又 水	中	丨 卍				田 口 冫	冫
			冫					
彡	E	(縱)	L			(方)	W	
火	巾 小	一	工 厂				ト 一 十 止	止
			厂 一				、 ；	；
灬	F	(橫)	M				Y	
土	士	弓	丨 一 厶					
			乙 乙					
土	G	(鈞)	N					

7.5.2 Tsang–Chi Code Generation

To input a Chinese character using the Tsang–Chi input method, its Tsang–Chi code should be generated based on character decomposition. Most Chinese characters can be divided into two categories: the composite form and the connected form. The composite form can be split into a character head and a character body while the connected form cannot.

Table 7–8: Composition Form Characters

Composite Form	Examples
Left-right form	針、憶、轉、謝
Top-bottom form	哲、靈
Inclusion form	國、圓

Table 7–9: Connected Form Characters

Connected Form	Examples
Connected form	亞、兩、爾

7.5.2.1 General Rules

The general rules for generating Tsang–Chi codes are:

- The character category must be composite or connected.
- The code according to the writing order is usually one of the following:
 - From outside to inside
 - From top to bottom
 - From left to right
- The number of radicals is up to five for composite characters, where the character head can be decomposed into at most two radicals and the character body can be decomposed into at most three radicals. Connected characters can be decomposed into no more than four radicals.
- If more than one Tsang–Chi code exists for a character, use the one with fewer radicals.

- If several Tsang-Chi codes have the same number of radicals, use the one that better represents the character.

7.5.2.2 Connected Characters

Connected characters are those which cannot be split due to the existence of crossed or connected strokes, such as 武, 面, 貞. Each character can be input by entering at most four radicals. If more than four radicals can be derived, the first three radicals and the last can be taken to generate the Tsang-Chi code. Table 7-10 illustrates some examples of decomposing connected characters.

Table 7-10: Examples of Connected Character Decomposition

字例	拆字	取碼	字首	取碼	字身	取碼
亡	卜女	YV	卜	Y	女	V
也	心木	FD	心	P	木	D
四	尸尸山	SSU	尸	S	尸山	SU
勿	心竹竹	FHH	心	P	竹竹	HH
斤	竹一中	HML	竹	H	一中	ML
斥	竹一卜	HMY	竹	H	一卜	MY
商	卜金月口	YCBR	卜	Y	金月口	CBR
世	心廿	PT	心	P	廿	T
甚	廿一一女	TMMV	廿	T	一一女	MMV
弟	金弓中竹	CNLH	金	C	弓中竹	NLH
靈	一口口土	MRRG	一	N	口口土	RRG
岡	月金口	BCR	月	B	金口	CR

7.5.2.3 Composite Characters

Composite characters are those that can be split from top to bottom, left to right, and outside to inside, such as 思, 珠, 圓. You can decompose the character head into one to two radicals. If more than two radicals are generated, take the first and the last radicals. The character body can be decomposed into one to three radicals. If it is made up of three or fewer radicals, you should enter all the radicals. If it is made up of more than three radicals that are connected, enter the first two radicals and the last. If the character body is itself a composite character, you can further decompose the character body into subhead and subbody. The radicals you should enter are the first and last radicals of the subhead, and the last radical of the subbody.

Table 7-11 illustrates examples of decomposing composite characters. In the "Shape" column, a solid square represents a character head while a square represents a radical of the character body.

Table 7-11: Composite Character Decomposition

	外觀	字例	字首	取碼	字身	取碼
邊		明計	日金	A C	月十	B J
		卦讀	土土 卜口	GG YR	卜金 土田金	Y GWC
		顏	人人	OO	一月金	MBC
列		勳 鄉	女木 口月	VO LB	大尸 弓中	KS NL
		劇	卜人	YO	中弓	LN
形		川棚	中手	L Q	中中 廿山月	LL TUB
		洲	水	E	中中中	LLL
上		曷占	日卜	A Y	日口	A R
		哉營	土土 竹人	GI HO	口日	R A
		是	女女	YV	田木	WD
下		直奎	土土 大	G K	口廿 土土	RT GG
		登	弓人	HO	一口廿	NR
包舍形		國區	田尸	W S S	戈口 中一口 口	IRM LMC RRR

7.5.2.4 Exceptional Characters

Approximately 95% of Chinese characters can be decomposed according to the rules described in Section 7.5.2.3. The remaining 5% are exceptional characters that need to be entered in different ways. The exceptional characters can be divided into the following groups:

- Compound Characters

The Tsang-Chi input method has defined nine compound characters. A compound character can be a connected character, or the character head or body of a composite character. In any case, compound characters must be represented by their first and last radicals.

Table 7-12: Compound Characters

複合字	拆字	取碼	舉例	拆字	取碼	備註
門	日弓	AN	關們	日弓尸口十 人日弓	ANSRJ OAN	門當字首使用，兩碼。 門當字身使用，只須兩碼。
目	月山	BU	睛盲	月山手一月 卜女月山	BUQMB YVB7J	目當字首使用。 目當字身使用。
鬼	竹戈	HI	魁魏	竹戈卜十 竹日竹戈	KIYJ RAHI	鬼當字首使用。 鬼當字身，只須取二碼。
冂	中弓	LN	關閑	中弓卜中月 中弓廿金	LNYLEB LNTC	冂當字首使用，取首字 形"冂"及尾字形"𠂇"。
冂	弓尸	NL	降那	冂中竹水手 一廿弓中	XLHEQ MTNL	冂當字首使用。 冂當字身，也是取兩碼。
住	人土	UG	隼隹	人土木 心山人土	UNG PUOG	住當字首使用。 住當字身，只取首尾兩碼。
扌	卜心	YP	扌扌	卜心尸一 口卜心一	YPSM RYPH	扌不分割，當字首使用 扌取"卜"及"七"。
女	女戈	VI	姦機	女兒田 末女戈人	VIW DVIO	"姦"字形，視作與下兩 字形分離，當字首。
冂	卜弓	YN	羸羸	卜弓女 卜弓廿手	YNV YNTQ	"羸"字形，整個當字首 使用。

- Difficult Characters

Difficult Characters are those which are difficult to decompose in the Tsang-Chi method. Usually, these characters are composed of some special root radicals that are neither the Tsang-Chi root radicals nor their auxiliary forms. Using the Tsang-Chi input method you can press the [X] key (which is labeled with 難 and therefore will be

referred to as the [難] in this document) to access the special root radicals and use them to compose difficult characters.

The rules of decomposing difficult characters are:

- If it is easy to identify the first and the last radicals, you can enter the first radical, the [難] key, and the last radical.

For example, “身” can be decomposed into “竹難竹” (HXH).

- If the first radical is easy to identify while the others are difficult, enter the first radical and then press the [難] key for the rest.

For example, “齊” can be decomposed into “卜難” (YX), and “白” can be decomposed into “竹難” (HX).

- Never use the [難] key for the first radical.

Table 7-13: Difficult Characters

舉例	拆字	取碼	舉例	拆字	取碼
身	竹難竹	HXH	鯨	弓火竹難竹	NFHXH
鷹	戈難火	IXF	薦	廿戈難火	TIXF
慶	戈難水	IXE	癩	廿手戈難水	TQIXE
鹿	戈難心	IXP	婦	女中難竹	VLXE
龜	弓難山	NXU	淵	水中難中	FLXL
兼	廿難金	TXC	國	中弓弓難山	LNNXU
颯	口難山	RXU	謀	卜口廿難金	YRTXC
白	竹難	HX	蠅	中戈口難山	LIRXU
肅	中難	LX	兒	竹難竹山	HXHU
齊	卜難	YX	蕭	廿中難	TLX
卮	弓難	NX	濟	水卜難	EYX

註：凡是字的外形與白字相近者，其拆字方式均相同，即只取白左上部的“𠂇”（竹），其餘均以〈難〉鍵代替。例如：

興-----> 竹難月金 HXBC 興-----> 竹難卜金 HXYC
 興-----> 竹難十金 HXJC 叟-----> 竹難中水 HXLE
 盞-----> 竹難月廿 HXBT 甬-----> 一十竹難 MJHX

• Special Characters

Some special characters are composed by superimposing the root radicals “木”, “大”, and “火” on other strokes or radicals. To keep the decomposed radicals as simple as possible, take the root radicals first, before the rest of the character is entered.

Table 7-14: Special Characters

特殊字	拆字	取碼	取形順序	說明
東	木田	DW	木田	先取木，再取相疊的田
束	木中	DL	木中	"中"字形較口完整。
束	木田火	DWF	木口灬	先取木，再取口、灬。
束	木月	DB	木冂	取木，再把冂重疊上去
末	木十	DJ	木十	先取木，再取重疊的十
來	木人人	DOO	木人人	先取木，再取人、人。
乘	竹木中	HDL	ノ木中	乘為連體字。
乘	竹木中心	HDLP	ノ木丨匕	ノ取完，再取木之主形
典	大大大大	KKKK	大乂乂乂	大主形先取，再取乂。
拳	火人手	FOQ	火人手	火主形先取，再取人。
脊	火金月	FCB	火八月	火主形先取，八再補上

7.5.3 Invoking Tsang-Chi Input Method

When you invoke the Tsang-Chi input method, the Chinese string “倉頡” is displayed in the status area, as shown in Figure 7-7.

Figure 7-7: Invocation of the Tsang-Chi Input Method

〔倉頡〕：|

The radicals that you enter with the Tsang-Chi input method are displayed in the pre-edit area, as shown in Figure 7-8. To correct the data, press the Delete key and reenter the correct radical. Alternatively, you can press the 倉頡 key (that is, F6 on a standard LK201 or LK401 keyboard) to erase all radicals in the pre-edit buffer. If fewer radicals are required to input a character, you can press the Return key or Space bar to signal the end of input.

Figure 7-8: Entering a Tsang-Chi Radical

〔倉頡〕：木|

7.5.4 Multiple Candidates

If there is exactly one character represented by a Tsang-Chi code, the character is sent directly to the application. Sometimes, multiple candidates for a Tsang-Chi code are

available for selection when the code represents more than one Chinese character. In this case, the candidates are displayed in the pre-edit area in the following order:

- Most frequently used
- Less frequently used
- Seldom used

The pre-edit area can display up to nine candidates at a time.

Figure 7–9: Multiple Candidates

1 X X X 4 X X X 7 X X X →

The numbers 1, 4, and 7 divide the nine characters into three groups so that you can easily select the desired candidate. To select a character that is displayed in the pre-edit area, press the corresponding numeric key on the main keyboard.

When there are more than nine candidates for selection, the indicators, “ → ”, “ ← → ” and “ ← ” are displayed in the pre-edit area. Table 7–15 lists the indicators and their definitions.

Table 7–15: Meaning of Arrow Characters

Indicator	Definition
→	The current row is the first row and you can press [Space] or [⇒] to move to the next row.
← →	The current row is somewhere between the first and the last row. You can press: <ul style="list-style-type: none"> • [Space] or [⇒] — move to the next row • [⇐] — move to the previous row • [↑] — move to the first row
←	The current row is the last row and you can press [⇐] to move to the previous row or [↑] to the first row.

If you enter another Tsang–Chi code without selecting a candidate, the first candidate in the list is sent to the application.

If you do not want to select any candidate, but want to clear the Tsang–Chi code, press the Return key or the 倉頡 key (that is, F6).

7.5.5 Repeat Character Input

If you want to repeat input of the same character, press the equals (=) key.

7.5.6 Error Handling

If you input incorrect data, the bell will ring. If no character is generated after you enter a Tsang–Chi code, this indicates that there is no character for the code. The radicals entered remain in the pre-edit buffer. To handle the error, you can do one of the following:

1. Press the Delete key to erase the radicals, one at a time, and then reenter the correct radicals.
2. Press the Return key or the 倉頡 key to erase all radicals in the pre-edit buffer, and then reenter the correct radicals.
3. Enter new radicals without pressing the Return key. The radicals in the pre-edit buffer are replaced by the newly entered radicals.

7.6 Quick Tsang–Chi Input Method (dxhanyuim)

The Quick Tsang–Chi input method, also known as the Quick input method or the so-called Easy input method, is a variant of the Tsang–Chi input method and follows the same principles and rules for decomposing characters into radicals. However, the process for entering radicals is simplified and requires only the first and the last radicals. For example, the character “商” is decomposed in the Tsang–Chi input method into “卜,” “金,” “月,” “口”. The Quick Tsang–Chi input method, in this case, requires input of only “卜” and “口”.

This section discusses the mechanism of the Quick Tsang–Chi input method. For details about character decomposition, see Section 7.5, Tsang–Chi Input Method.

7.6.1 Quick Tsang–Chi Code Generation

As in the Tsang–Chi input method, the character decomposition in Quick Tsang–Chi is based on whether a character is of the composite form or the connected form. However, the Quick Tsang–Chi input method requires only the first and the last radicals regardless of the number of radicals obtained.

7.6.2 Invoking Quick Tsang–Chi Input Method

When you invoke the Quick Tsang–Chi input method, the Chinese string “速成” is displayed in the status area, as shown in Figure 7–10.

Figure 7–10: The Quick Tsang–Chi Input Method

(速成) : |

7.6.3 Entering Quick Tsang–Chi Code

The radical that you enter is displayed in the pre-edit area, as shown in Figure 7–11. To correct the data, press the Delete key and reenter the correct radical. Alternatively, you can press the 速成 key (that is, F7 on a standard LK201 or LK401 keyboard) to erase all radicals in the pre-edit buffer. If only one radical is required to input a character, press the Return key or Space bar to signal the end of input.

Figure 7–11: Entering a Quick Tsang–Chi Code

(速成) : 月

7.6.4 Multiple Candidates

If exactly one character is represented by a Quick Tsang–Chi code, the character is sent directly to the application. Frequently, multiple candidates for a Quick Tsang–Chi code are available for selection when the Quick Tsang–Chi code represents more than one Chinese character. In this case, the candidates are displayed in the pre-edit area.

If you do not want to select any candidate, but want to clear the Tsang–Chi code, press the Return or the 速成 key (that is, F7).

7.6.5 Repeat Character Input

If you want to repeat the input of the same character, press the equals (=) key.

7.6.6 Error Handling

If you input incorrect data, the bell will ring. If no character is generated after you enter a Quick Tsang–Chi code, this indicates that there is no character for the code. The radicals entered remain in the pre-edit buffer. To handle the error, you can do one of the following:

- Press the Delete key to erase the radicals, one at a time, and then reenter the correct radicals.
- Press the Return key or the 速成 key to erase all radicals in the pre-edit buffer, and then reenter the correct radicals.
- Enter new radicals without pressing the Return key. The radicals in the pre-edit buffer are replaced by the newly entered radicals.

7.7 Phonetic Input Method (dxhanyuim)

The Phonetic input method is based on Chinese phonetic symbols (bopomofo) that represent the pronunciation of Chinese characters.

7.7.1 Phonetic Symbol Categories

Phonetic symbols can be divided into three categories: consonants, vowels, and tone marks. There are 21 consonants, 16 vowels, and 5 tone marks. The 5 tone marks for Chinese pronunciation are the first, the second, the third, the fourth and the light tones. Chinese phonetic symbols are assigned to the alphanumeric keys on the main keyboard. Table 7-16 summaries all consonants, vowels, and tone marks.

7.7.2 Phonetic Code Generation

The pronunciation of a Chinese character is composed of consonants, vowels, and tone marks. Therefore, a phonetic code can be generated according to the following rules:

- The phonetic symbols are entered in the following order:
 - Consonant
 - Vowel
 - Tone marks
- A phonetic representation must have at least one consonant or one vowel.
- The end of input must be indicated with a tone mark or a Return.

Table 7–17: Examples of Phonetic Input

Code Format	Phonetic Symbols	Characters
Consonant + vowel + tone mark	尸ㄨ´	誰
Consonant + [vowel] + tone mark	出	知, 織
Vowel + tone mark	ㄩ	安, 庵
Consonant + semivowel + vowel + tone mark	ㄒㄩㄣˇ	曉, 小
Semivowel + vowel + tone mark	ㄨㄛˇ	我

7.7.3 Invoking Phonetic Input Method

When you invoke the Phonetic input method, the Chinese string “ 注音” is displayed in the status area, as shown in Figure 7–12.

The example in Figure 7–12 shows how to input the character “ 吉” by entering the phonetic symbols ㄐㄧ´ (RU6) at the main keyboard.

Figure 7–12: Entering the Phonetic Symbols for “ 吉”

[注音] : ㄐㄧ´ █ 1 及吉吃 4 即急級 7 集極擊 →

7.7.4 Entering Phonetic Code

The phonetic symbols that you enter are displayed in the pre-edit area. To correct the data, press the Delete key and reenter the correct symbol. Alternatively, you can press the

7.7.6 Repeat Character Input

If you want to repeat the input of the same character, press the equals (=) key.

7.7.7 Error Handling

If you input incorrect data, the bell will ring. If no character is generated after you enter a phonetic code, this indicates that there is no character for the code. The phonetic symbols entered remain in the pre-edit buffer. To handle the error, you can do one of the following:

- Press the Delete key to erase the radicals, one at a time, and then re-enter the correct radicals.
- Press the Return key or the 注音 key to erase all phonetic symbols in the pre-edit buffer, and then reenter the correct phonetic symbols.
- Enter new phonetic symbols without pressing the Return key. The phonetic symbols in the pre-edit buffer are replaced by the newly entered symbols.

7.8 Internal Code Input Method (dxhanyuim)

Each character in DEC Hanyu has been assigned a unique internal code, just like the ID number of a company employee. For a complete list of the characters and their internal codes, see *The DEC Chinese Code Book* (Part Number EK-VT38D-CB-001).

Note

In this Compaq Tru64 UNIX release, the Internal Code input method supports only the DEC Hanyu internal code. The internal codes for Taiwanese EUC and Big-5 are not supported. Even if you set the locale to one of the Taiwanese EUC or Big-5 locales, this input method still requires you to specify the DEC Hanyu internal code.

7.8.1 Input Procedure

When you invoke the Internal Code input method, the Chinese string “ 內碼 ” is displayed in the status area.

To enter an internal code, you can optionally enter a character set number to be followed by a 4-digit hexadecimal number that specifies the position of the character with respect to the character set. The character set number can be 1 for the CNS 11643-1986 character set, or 2 for the DTSCS character set.

If you omit the character set number and enter only the 4-digit hexadecimal code, you must press the Return key or the Space bar to signal the end of input. If you enter the character set number and the 4-digit hexadecimal code, the respective character is sent

automatically without pressing the Return key. Figure 7–13 shows the input of “ 例” using the Internal Code input method.

Figure 7–13: Input of “ 例” Using the Internal Code Input Method

```
租賃契約條_
〔內碼〕: 1CBF█
```

The internal code that you enter is displayed in the pre-edit area. To correct the data, press the Delete key and re-enter the correct code. Alternatively, you can press the 內碼 key (that is, F8 on a standard LK201 or LK401 keyboard) to erase all characters in the pre-edit buffer.

Since internal codes are unique for any symbols or Chinese character in DEC Hanyu, there are no multiple candidates for an internal code.

7.8.2 Repeat Character Input

If you want to repeat the input of the same character, press the equals (=) key.

7.8.3 Error Handling

If you input incorrect data, the bell will ring. If no character is generated after you enter an internal code, this indicates that there is no character for the code. The internal code entered remains in the pre-edit buffer. To handle the error, you can do one of the following:

- Press the Delete key to erase the characters representing the internal code, one at a time, and then reenter the correct internal code.
- Press the Return key or the 內碼 key to erase all characters in the pre-edit buffer, and then reenter the correct internal code.
- Enter a new internal code without pressing the Return key. The characters in the pre-edit buffer are replaced by the newly entered internal code.

7.9 Phrase Input Method (dxhanyuim and dxhanziim)

The Phrase input method is a mechanism designed to facilitate the input of frequently used phrases. You can define your own frequently used phrases by preparing your own phrase database. Each phrase is identified by a phrase code. To input a phrase, you enter its phrase code and then convert it to the respective phrase.

The Compaq Tru64 UNIX operating system provides a Phrase Utility that you use to create phrase databases. For details, see *Writing Software for the International Market*.

In addition, the firmware of the VT382-D traditional Chinese terminal is designed to allow you to download phrases into its built-in memory. For DECwindows Motif applications, you do not need to download phrase definitions because the Chinese input servers can directly access the phrase databases. In addition, you can select the phrase database being used.

7.9.1 Input Procedure

When you invoke the Phrase input method, the Chinese string “片語” is displayed in the status area of `dxhanyuim`, and 古陋 in the status area of `dxhanziim`. Figure 7-14 shows an example of entering a phrase in `dxhanyuim` by specifying its phrase code. Figure 7-15 shows an example of converting the phrase code to the phrase.

Figure 7-14: Entering a Phrase Code

國際觀光旅館名錄

名稱: 國賓大飯店/AMBASSADOR

地址: 台北市中山北路二段63號

63, Chung Shan N. Rd., Sec. 2, Taipei

名稱: _

(片語): ASIA

Figure 7-15: Converting a Phrase Code to a Phrase

國際觀光旅館名錄

名稱: 國賓大飯店/AMBASSADOR

地址: 台北市中山北路二段63號

63, Chung Shan N. Rd., Sec. 2, Taipei

名稱: 環亞大飯店/ASIA WORLD PLAZA_ [倉韻]:

The phrase code that you enter is displayed in the pre-edit area, as shown in Figure 7-14. To correct the data, press the Delete key and reenter the correct code. Alternatively, you can press the 片語 key (that is, F9 on a standard LK201 or LK401 keyboard) to erase all characters in the pre-edit buffer.

The phrase code can consist of at most eight characters. If it has fewer than eight characters, press the Return key or Space bar to signal the end of input. If it has exactly eight characters, the respective phrase is sent automatically without having to press the Return key after you enter the last character.

The Phrase input method is different from other input methods in the sense that once a phrase is entered, the input mode switches back to the original input mode from which the Phrase input method was invoked. To input another phrase, press the 片語 key again and then enter another phrase code.

7.9.2 Error Handling

If the data that you input is incorrect, the bell will ring.

7.9.2.1 Condition 1

If the message “ 此片語不存在 ” (Requested phrase does not exist) is displayed when you enter a phrase code, you can check the following:

- Check to be sure that the phrase is in the phrase definition file.
- If you are using a VT382-D terminal:
 - Check to be sure that the phrase definition file containing the phrase definition has been downloaded to the VT382-D Chinese terminal.
 - Check to see if the terminal power supply has been interrupted since you last loaded the phrase definition file.
 - Check to see if you have reset the VT382-D terminal. The Recall and Default operations provided by the VT382-D setup menu clear the phrase definitions that have been downloaded.
- If you are using a Chinese input server:
 - Check to be sure that the phrase definition file containing the phrase definition has been selected by the Chinese input server.
 - Check to see if the LANG environment variable has been set up correctly before starting the Chinese input server.

If the phrase has been defined but it does not exist in the in-memory phrase database, reload or reselect the phrase definition file.

7.9.2.2 Condition 2

Errors can occur in the phrase definition file. If you cannot solve the problem using the procedures in Section 7.9.2.1, you can do one of the following:

- Check the syntax of the definition statements in the phrase definition file. A phrase cannot be downloaded if the syntax of its definition is incorrect.
- If you are using a VT382-D terminal, a maximum of 100 phrases can be downloaded. If the number of phrases in the phrase definition file exceeds this limit, the definitions beyond the limit are not downloaded.

7.10 Symbol Input in dxhanyuim

The Symbol input method is a more intuitive way to input 2-byte symbols, such as punctuation marks, table and mathematical symbols, foreign characters, phonetic symbols, and traditional Chinese control characters.

You can invoke the Symbol input method only from the Tsang–Chi or the Quick Tsang–Chi input method. You can use it to input more than 600 symbols, including all full form alphabets (A-Z, a-z), full form numerals (0-9), full form symbols (such as #, \$, % ...), phonetic elements (such as ㄅ, ㄆ, ㄇ, ㄏ), Chinese radicals and special symbols (such as 冫, 冫, ※).

7.10.1 Invoking Symbol Input Mode

To enter the Symbol input mode, press the Z key when invoking Tsang–Chi or the Quick Tsang–Chi input method. When you invoke the Symbol input mode, the Chinese string “符號” is displayed in the status area.

7.10.2 Rules of Symbol Input

Use the following rules when entering symbols:

- If a symbol exists on the keyboard, input it the same way you enter single-byte characters.

Symbol	Input Code	Key Sequence
!	!	<Shift/1>
#	#	<Shift/3>
\$	\$	<Shift/4>
A	A	[A]
a	A	[a]

- Symbols of similar form or meaning have the same key sequence.

Symbol	Input Code	Description
((vertical parenthesis
))	vertical parenthesis
((horizontal parenthesis
))	horizontal parenthesis

- If a symbol does not exist on the keyboard, decompose it according to its shape.

Symbol	Key Sequence
≠	[=][/]
♀	[O][+]
§	[S][S]
kg	[K][G]

- For graphical symbols, press the hyphen (-) key and a number within the range 1-8 to specify horizontal symbols or press the vertical bar key (|) and a number within the range 1-7 to specify vertical symbols.

Symbol	Key Sequence	Symbol	Key Sequence
-	[-][1]		[][1]
-	[-][2]		[][2]
-	[-][3]		[][3]
-	[-][8]		[][7]

- To enter symbols for constructing a table or diagram, press the T key and an alphabet key specifying the direction.

Symbol	Key Sequence
┌	[T][Z]
└	[T][X]
┐	[T][C]
┆, ┆	[T][A]
	[T][S]
┆, ┆	

┌ Q	└ W	┐ E
┆ A	┆ S	┆ D
└ Z	└ X	┐ C

- To enter arrows of various directions, press the A key and an alphabet key specifying the direction.

Symbol	Key Sequence
↖	[A][Z]
↓	[A][X]
↘	[A][C]
←	[A][A]

↖ Q	↑ W	↗ E
← A		→ D
↖ Z	↓ X	↘ C

- Press the P key to indicate the input of phonetic symbols. To specify the required symbol, press the key with the respective phonetic symbol marked on the keyboard. See Chapter 6 for the keymap of phonetic symbols.

Symbol	Key Sequence
勺	[P][1]
夕	[P][Q]
冂	[P][A]
匚	[P][Z]
勹	[P][2]

- Press the G key (or g for the lowercase) to input Greek letters and then enter the first two letters of the Greek character's name. Use uppercase or lowercase letters as appropriate.

Symbol	Key Sequence
A	[G][A][L]
B	[G][B][E]
A	[g][a][l]
B	[g][b][e]
E	[G][E][P]

7.10.3 Entering Symbol Code

You can input a symbol by entering its symbol code and then pressing the Return key or Space bar to signal the end of input.

The following example describes how to enter the full form alphabet “ A ” :

1. Press the Z key to invoke the Symbol input mode.

〔符號〕 : █

2. Press the A key to enter the first alphabet of the Symbol code.

〔符號〕 : A █

7.10.4 Multiple Candidates

If a symbol code matches exactly one character, the character is sent directly to the application. However, sometimes a symbol code matches multiple candidates. In this case, the candidates are displayed in the pre-edit area. To continue the preceding example:

1. In the preceding example, press the Return key to signal the end of input.

〔符號〕 : A █ 1 A 日 日

2. Press the 1 key to select “ A”

A_

(倉韻) : |

Note

After the symbol is input, the input mode switches back to the original input mode.

7.10.5 Error Handling

If no symbol is input after you enter a symbol code, the symbol code is invalid and the input mode switches back to the original input mode. You can press the Z key to invoke the Symbol input mode again and reenter the correct symbol code.

7.11 Input of User-Defined Characters in DECwindows Motif

The Compaq Tru64 UNIX software supports the input of user-defined characters (UDC) through the Tsang-Chi and Quick Tsang-Chi input methods. When you invoke the Chinese input server, the following Tsang-Chi dictionaries are loaded:

- The private UDC Tsang-Chi dictionary that you create
- The system wide UDC Tsang-Chi dictionary
- The system default Tsang-Chi dictionary

The Tsang-Chi and Quick Tsang-Chi input methods display candidates, which match the input key sequence you enter, in this order.

You can use the `credit` utility to define the input sequences of user-defined characters and then use the `cgen` command with the `-iks` option to produce a UDC Tsang-Chi dictionary for the Chinese input server. You should also define the corresponding font glyphs (both 18X16 and 24X24 size fonts). After you define the user-defined characters and their corresponding information in the system or user database, restart the input server to reread the database. For details, see *Writing Software for the International Market* or the `cgen` reference pages.

By default, the Chinese input server puts your private UDC Tsang-Chi dictionary in the `~/ .iks/dwimdb-dechanyu` directory. You can use the `USER_UCD_DICT` environment variable to override this default.

The system wide UDC Tsang-Chi dictionary is, by default, placed in the `/var/i18n/iks/dwimdb-dechanyu` directory. If the dictionary is located elsewhere

on your system, you use the `SYSTEM_UDC_DICT` variable to override the default location. If you are a system administrator, you can install a UDC Tsang-Chi dictionary by placing it at the default location and setting proper access mode for system-wide use.

The system default Tsang-Chi dictionary, which is shipped with the Compaq Tru64 UNIX system, is placed in the `/usr/i18n/hanyu/hanyu_tsangchi.dic` directory. If it is installed at a different location, you can use the `HANYU_SYSTEM_DICT` environment variable to specify the location.

Note

In this Compaq Tru64 UNIX release, the Chinese input server supports UDC input key sequences only in the DEC Hanyu codeset.

To display UDC in DECwindows Motif applications or the Chinese input server, UDC fonts should be available on your system. For instance, the Chinese input server will display UDC using the fonts `-adecw-screen-*--18-*--cns11643.1986-udc` or `-adecw-screen-*--24-*--cns11643.1986-udc`.

If you define your own UDC fonts, you can override the system UDC fonts by adding the directory in which the UDC fonts are located to the font path. For example, if your private UDC fonts are located in the `~/fonts` directory, you can enter the following command to update the font path:

```
%xset +fp ~/fonts
```

Use the `cedit` utility to define UDC font glyphs (both 18X16 and 24X24 size fonts) and the `cgen` utility to generate fonts for use in DECwindows Motif. For details, see *Writing Software for the International Market*.

7.12 5-Stroke Input Method (dxhanziim)

The 5-Stroke input method makes use of the basic strokes to construct the Chinese characters. A stroke is a segment of continuous line or curve that constitutes a Chinese character. Table 7-19 describes the five categories of strokes

Table 7–19: Stroke Categories

Category	Description
Horizontal strokes or 横〔一〕	Horizontal lines and left-to-right ticks〔提〕
Vertical strokes or 竖〔丨〕	Vertical lines and right-to-left hooks〔竖左钩〕
Slash or 撇〔丿〕	Slanting lines and curves drawn towards lower-left
Backslash or 捺〔丶〕	Dots〔点〕, slanting lines, and curves drawn towards lower-right
Zip-zap curves or 折〔乙〕	Including different types of joints or corners which can be drawn in single continuous strokes

Using the 5-Stroke input method you can input single Chinese characters and Chinese terms. Approximately 5,000 terms can be input using this method.

7.12.1 Input Mechanism

To input a Chinese character using the 5-Stroke input method, enter its 5-stroke code through the numeric keypad according to the writing order. Table 7–20 shows the codes representing the five categories of strokes.

Table 7–20: 5-Stroke Code

Stroke	Code	Key
一	1	[KP1]
丨	2	[KP2]
丿	3	[KP3]
丶	4	[KP4]
乙	5	[KP5]

Figure 6–5 shows the numeric keypad layout for entering 5-Stroke codes.

The following are the general rules of writing order for Chinese characters:

1. From top to bottom
2. From left to right
3. From outside to inside
4. Writing radical inside before drawing the last stroke of the outside radical (for example, the last stroke of “ 围 ” is “ 一 ”)

7.12.1.1 Single Character Input

If a Chinese character is composed of exactly five strokes, enter the strokes according to the writing order. If it is composed of fewer than five strokes, press the KP0 key to signal the end of input. If it is composed of more than five strokes, enter the first four strokes and the last stroke. Table 7–21 shows some examples of using the 5-Stroke input method.

Table 7–21: Input of Single Characters with the 5-Stroke Input Method

Character	No. of Strokes	Write Order	5-Stroke Code	Key Sequence
用	5	丿, 乙, 一, 一,	35112	[KP3][KP5][KP1][KP1][KP2]
五	4	一, , 乙, 一	12510	[KP1][KP2][KP5][KP1][KP0]
总	9	丶, 丿, , 乙, 丶	43254	[KP4][KP3][KP2][KP5][KP4]

If you are uncertain about the type of strokes or the writing order of strokes, press the wildcard key (KP6) in place of the strokes. For details, see Section 7.12.5, Wildcard Key.

7.12.1.2 Input of Terms

The 5-Stroke input method can be used to input terms. Eight strokes are required for entering terms. Press the [KP7] key before inputting strokes. The [KP7] key signals the system that subsequent key strokes are for composing a term instead of a character.

The number of strokes input for each character in a term depends on the number of characters composing the term as shown in Table 7-22.

Table 7–22: Input Terms with the 5-Stroke Input Method

Number of Characters in Term	Strokes to be Input
2	First 4 strokes of each character
3	First 2 strokes of the first two characters and the first 4 strokes of the last character
4	First 2 strokes of each character
> 4	First 2 strokes of the first three characters and the last character

If a character is composed of fewer strokes than required, press the KP6 key for the outstanding strokes. If this character is the last character, press the KP0 key to signal the end of input.

Term	Number of Characters	Characters	No. of Strokes	Req'd Strokes	5-Stroke Code	Key Sequence
世界	2	世界	5	4	1221	[KP7][KP1][KP2]
			9	4	2512	[KP2][KP1][KP2] [KP5][KP1][KP2]
工人	2	工人	3	4	121(6)	[KP7][KP1][KP2]
			2	4	34(0)	[KP1][KP6][KP3] [KP4][KP0]
计算机	3	计算机	4	2	45	[KP7][KP4][KP5]
			14	2	31	[KP3][KP1][KP1]
			6	4	1234	[KP2][KP3][KP4]
星期一	3	星期一	9	2	25	[KP7][KP2][KP5]
			12	2	12	[KP1][KP2][KP1]
			1	4	1(0)	[KP0]
百货公司	4	百货公司	6	2	13	[KP7][KP1][KP3]
			8	2	32]KP3][KP2][KP3]
			4	2	34	[KP4][KP5][KP1]
			5	2	51	
一分为二	4	一分为二	1	2	1(6)	[KP7][KP1][KP6]
			4	2	34	[KP3][KP4][KP4]
			4	2	43	[KP3][KP1][KP1]
			2	2	11	
中华人民共和国	7	中华人民共和国	4	2	25	[KP7][KP2][KP5]
			6	2	32	[KP3][KP2][KP3]
			2	2	34	[KP4][KP2][KP5]
			8	2	25	

7.12.2 Input Procedure

When you invoke the 5-Stroke input method, the string “五笔画” is displayed in the status area. When you input the 5-Stroke code, all the Chinese characters that match the code sequence are displayed in the 26th line of the terminal or the pre-edit area of the display. Each character is associated with a number and you can select the character immediately using the corresponding numeric key on the main keyboard.

For example, if you press the KP1 key, all characters starting with a horizontal stroke are displayed in the pre-edit area.

五笔画:1 1有DEF 2地FBN 3来GOI 4于GFK 5下GHI +

If you press the KP2 key, all Chinese characters with starting 5-Stroke code 12 are displayed in the pre-edit area.

五笔画:12 1地FBN 2下GHI 3可SKD 4机SMN 5本SGD +

You can use the Delete key to correct the 5-Stroke code. When you delete digits in the 5-Stroke code, the characters displayed in the pre-edit area are changed to match the remaining 5-Stroke code.

For example, press the Delete key once:

五笔画:1 1有DEF 2地FBN 3来GOI 4于GFK 5下GHI +

Press the Delete key once more:

五笔画:

Alternatively, you can press the Return key without selecting any character. The pre-edit area is refreshed and you can enter a new 5-Stroke code.

7.12.3 Multiple Candidates

Because the same 5-Stroke code can represent more than one Chinese character, sometimes, multiple candidates are available for selection when you enter a 5-Stroke code. For example:

将所有区域_

五笔画: 12345 1机SMN 2榜SUPY 3概SUCQ 4棍SJXX 5杭SYMN +

To select a character that is displayed in the pre-edit area, press the corresponding numeric key on the main keyboard. In the example, press numeric key 3 to select “概”. If the desired character is displayed at the first position (in this case, the “机” character), you do not need to press the 1 key to select “机”. Enter another 5-Stroke code and the character will automatically be selected. This character is called the default character.

If there are too many candidates for selection, the candidates are displayed in two or more rows and a plus (+) sign is displayed to signal this. Press the Space bar or KP9 key to display the next row of characters. If you want to see the previous row of characters, press [Shift/Space] or the KP8 key.

7.12.4 The Association Mode

To enhance input efficiency, the Chinese input method maintains a list of built-in phrases in memory. If you select a character from the candidate list (See Section 7.12.3, Multiple Candidates) and there is a built-in phrase whose first character matches this character, Association Mode is automatically activated. For example:

将所有区域划_

联想 → 1- 分

The string “ 联想→ ” is displayed in the status area. You can select one of the built-in phrases in Association Mode. After you select the phrase, you automatically exit Association Mode.

If there are many built-in phrases, they are displayed in two or more rows and a plus (+) sign is displayed to signal this. Press the Space bar or KP9 key to view the next row of phrases. To move backwards, press [Shift/Space] or the KP8 key.

If you do not want to use any of the associated phrases, enter another 5-Stroke code to automatically exit the Association Mode.

Notes

Association Mode is only active during single character input. It cannot be activated during term input.

Association Mode is activated only if you press a numeric key to select a single character. If you do not press the 1 key to select the default character, the Association Mode is not activated though the default character is entered.

7.12.5 Wildcard Key

The KP6 key is a wildcard key, like an asterisk in a file specification, which can replace any strokes about which you are uncertain.

For example:

“ 字” - “ \ ” , “ ? ” , “ 乙 ” , “ 乙 ” , “ 一 ”

This example assumes you are uncertain about the second stroke, and so press KP4, KP6, KP5, KP5, KP1.

Another example:

“ 化” - “ 丿” , “ |” , “ ?” , “ ?”

This example assumes you are uncertain about the third and the fourth strokes, and so press KP3, KP2, KP6, KP6, KP0.

7.13 5–Shape Input Method (dxhanziim)

The 5-Shape input method is a high performance input method that composes root radicals (字根) to form Chinese characters. Using the 5-Shape input method, you can enter one to four root radicals to input thousands of Chinese characters and terms.

In addition to character input, the 5-Shape input method also supports term input. The 5-Shape input method supports approximately 5,000 terms, each of which can be defined by four radicals.

Note

When using a VT382-C terminal with SoftODL enabled, you can use a user-defined key sequence in the 5-Shape input method to input a user-defined character (UDC). This assumes the key sequence does not apply to other existing characters. Use `credit` to create UDCs and their corresponding input key sequences.

7.13.1 Distribution of Radicals

There are 130 root radicals defined on 25 keys on the main keyboard. (See Figure 6-3 and Figure 6-4 for the layout of the LK201-C and LK401-C keyboards.) The 25 keys are divided into five groups, each containing five keys, as shown in Table 7-23.

Table 7–23: Shape Code

	Key 1	Key 2	Key 3	Key 4	Key 5
Group 1	[11]/[G]	[12]/[F]	[13]/[D]	[14]/[S]	[15]/[A]
Group 2	[21]/[H]	[22]/[J]	[23]/[K]	[24]/[L]	[25]/[M]
Group 3	[31]/[T]	[32]/[R]	[33]/[E]	[34]/[W]	[35]/[Q]
Group 4	[41]/[Y]	[42]/[U]	[43]/[I]	[44]/[O]	[45]/[P]
Group 5	[51]/[N]	[52]/[B]	[53]/[V]	[54]/[C]	[55]/[X]

Figure 7-16: Distribution of Radicals

金 隹 卂 一 35 Q	人 亻 大 攴 攴 34 W	月 冂 冂 冂 33 E	日 日 日 日 32 R	禾 禾 禾 禾 31 T	富 富 富 富 41 Y	立 立 立 立 42 U	水 水 水 水 43 I	火 火 火 火 44 O	之 之 之 之 45 P
工 工 工 工 15 A	木 木 木 木 14 S	大 大 大 大 13 D	土 土 土 土 12 F	王 王 王 王 11 G	目 目 目 目 21 H	日 日 日 日 22 J	口 口 口 口 23 K	田 田 田 田 24 L	
Z	彳 彳 彳 彳 55 X	又 又 又 又 54 C	女 女 女 女 53 V	子 子 子 子 52 B	邑 邑 邑 邑 51 N	山 山 山 山 25 M			

Figure 7-17: 5-Shape Radical Keys

五笔字型键位字根

字母	键号	笔画	键名 基本字根
G	11	一	王 土戈五一
F	12	二	土 土二千十申寸雨
D	13	三	大 犬三羊彡县古石厂アナナ
S	14		木 丁西
A	15		工 戈升甘廿口七弋
H	21	丨	目 且上止止卜卜广广
J	22		日 日 日 早 日 日 虫
K	23		口 川
L	24		田 甲 口 四 皿 皿 车 力
M	25		山 由 贝 冂 几
T	31	ノ	禾 禾 竹 丩 禾 女 女
R	32	夕	白 手 才 尹 夕 厂 斤 斤
E	33	彡	月 日 舟 彡 彡 乃 用 冢 冢 以 衣
W	34		人 亻 八 廾 廾
Q	35		金 钅 勺 角 了 儿 儿 儿 夕 夕 夕
Y	41	丶	言 讠 文 方 广 广 广 圭
U	42	冫	立 辛 冫 冫 冫 六 立 冫 广
I	43	彳	水 氵 水 水 彳 彳 小 小 小
O	44		火 业 小 米
P	45		之 辶 辶 一 一
N	51	乙	己 巳 己 冫 尸 尸 乙 心 十 羽
B	52	㇀	子 子 耳 卩 卩 巳 了 也 口
V	53	㇁	女 刀 九 冫 日 ㇁
C	54		又 又 又 巴 马 么
X	55		纟 纟 弓 匕 匕 么 弓

Figure 7–16 and Figure 7–17 show that the distribution of radicals has three characteristics:

1. The root radicals and the Chinese key name are similar in shape. For example:

The key name of Key [11] is “王” while its radicals include “五”, and so on.

2. The code for the first stroke of a root radical is the same as the group number, while the code for the second stroke is the same as the key number. For example:

The first stroke of the radicals on key [41] such as “文”, “方” and “广” is “丶”, which is the same as the group number. The second stroke is “一”, which is the same as the key number.

3. The key number denotes the number of strokes for constructing the root radicals. That is, the key number equals the number of strokes of the radicals, for example:

The group number of “一” is 1. Therefore, “一” is located on key [11], “二” is located on key [12], and “三” is located on key [13].

7.13.2 Decomposition of Chinese Characters

The 5-Shape input method decomposes Chinese characters according to their root radicals. The decomposition can be categorized as follows:

- Left-Right Type (Type 1)

The character can be split into a left half and a right half, such as “汉”, “对”, and “湘”.

- Upper-Lower Type (Type 2)

The character can be split into an upper half and a lower half, such as “华”, “字”, and “想”.

- Miscellaneous Type (Type 3)

The character does not have a clear separation of left-right or upper-lower. Examples include “本”, “同”, and “这”.

The miscellaneous type can be further divided into individual type and inclusion type.

Examples of individual type include

“本”, “天”, “册”, “司”, “头”, “进”, and “厢”. Inclusion type refers to those characters with one of their root radicals totally or partially included in another root radical, such as “司”, “连”, “凶”, and “回”.

7.13.3 Distinction Code

If a character is composed of fewer than four root radicals, you must enter a code that represents the decomposition type and the type of the last stroke, which is called the Distinction code.

Figure 7–18: Distinction Code for the 5-Shape Input Method

字型 末笔形		左右型 □	上下型 ■	杂合型 ⊠
		1	2	3
横	1	11(一)	12(二)	13(三)
竖	2	21(丨)	22(丨丨)	23(丨丨丨)
撇	3	31(丿)	32(丿丿)	33(丿丿丿)
捺	4	41(丶)	42(丶丶)	43(丶丶丶)
折	5	51(乙)	52(乙乙)	53(乙乙乙)

For example, the codes for “汀”, “洒”, and “沐” are all [43][14]. To distinguish among them, you must enter the distinction code.

Character	Last Stroke	Decomposition	Distinction Code
汀	丨 (2)	Left-Right (1)	[21]
洒	一 (1)	Left-Right (1)	[11]
沐	丶 (4)	Left-Right (1)	[41]

Notes

The root radicals available on the main keyboard do not require a distinction code. Although the characters which are key names (such as “大”) and radical names (such as “上”) are composed of fewer than four radicals, no distinction code is required. For example, “厂” can be decomposed into “一” and “丿”.

For those characters that do not have a unique writing order, such as “刀”, “切”, “力”, “九”, and “七”, you can use zip-zap stroke code (5) for the last stroke. For example, “仇” can be decomposed into “亻”, and “九”, and you may add the distinction code [51].

For those inclusion type characters, such as “国”, “围”, “团”, “进”, and “这”, you should take the last stroke of the interior radical. For example, the distinction code for “进” is [23] because the last stroke is [2].

Single dots located near a radical, such as the point in “义” and “太”, belong to decomposition type 3. For example, the distinction code of “为” is [43].

7.13.4 Principles of Character Decomposition

The following four principles can be used for decomposing Chinese characters:

1. Writing order. For example, “远” should be decomposed into “二”, “儿”, and “辶” instead of “辶”, “二”, “儿”.
2. Priority for larger radicals. Among the different ways of decomposition, choose the one that results in larger radicals. For example, “尺” should be decomposed into “尸” and “丿” instead of “丿” and “人”.

Another interpretation of this principle is that you should choose the decomposition method that creates fewer radicals.

3. Separated structure. If a character can be decomposed as a separated structure or a cross structure, choose the separated structure. For example, “于” should be decomposed as “一” and “十” instead of “二”, and “丨”.
4. Intuition. If you cannot choose a character decomposition method based strictly on one of the previous principals, apply a reasonable approach based on a combination of your experience and the previous three principals.

7.13.5 Input Mechanism

The 5-Shape input method allows for single-character input and term input.

7.13.5.1 Single Character Input

Each Chinese character can be composed of one to four root radicals. If the character is available on the keycap as a keyname, press the key four times. For example:

“ 言 ” - press [41][41][41][41]

If the character is a root radical, press the key for the radical and enter the first, second, and last strokes. If the character is defined with fewer than four codes, press the Space bar to signal the end of input, for example:

Character	Decomposed Radicals	Number of Radicals	Key Sequence
西	西, 一, 丨, 一	4	[14][11][21][11]
厂	厂, 一, 丿	3	[12][11][31][Space]

There is one exception for the five basic strokes. The characters“ 一 ”,“ 丨 ”,“ 丿 ”,“ 丶 ”, and“ 乙 ” are single-stroke characters and they require two codes for input. To avoid multiple candidates for the same code, the 5-Shape input method requires adding two more codes [24] [24]. Table 7–24 shows the key sequences for entering these basic strokes.

Table 7–24: Entering Basic Strokes

Basic Stroke	Key Sequence
一	[11][11][24][24]
丨	[21][21][24][24]
丿	[31][31][24][24]
丶	[41][41][24][24]
乙	[51][51][24][24]

If the character does not appear on the keycap, follow the decomposition principles described in the previous section. If the character is composed of exactly four root radicals, enter the root radicals according to the writing order. If it is composed of more than four root radicals, enter the first, second, third, and last root radicals. If it is composed of less than four radicals, enter the radicals together with the distinction code. If the number of codes is still less than four, press the Space bar to signal the end of input.

For example:

Character	Decomposed Radicals	Distinction Code	Key Sequence
到	一, 厶, 土, 丿	-	[11][54][12][22]
攀	木, X, X, 手	-	[14][35][35][32]
°汉	讠, 又	[41]	[43][54][41][Space]

7.13.5.2 Term Input

Approximately 5,000 built-in terms are defined in the Chinese input methods. You can use the 5-Shape input method to input multiple character terms by entering four root radicals as shown in Table 7-25.

Table 7-25: Input of Terms with the 5-Shape Input Method

Number of Characters in Term	Root Radicals to be Entered				
2	The first two root radicals of each character				
3	The first root radicals of the first two characters and the first two root radicals of the last character				
4	The first root radical of each character				
> 4	The first root radicals of the first three characters and the last character				

Term	Number of Characters	Character	Number of Req'd Root Radicals	Root Radical	5-Shape Code
经济	2	经济	2 2	纟, 又 讠, 文	[55][54][43][41]
计算机	3	计算机	1 1 2	讠 竹 木, 几	[41][31][14][25]
艰苦奋斗	4	艰苦奋斗	1 1 1 1	又 艹 大 讠	[54][51][13][42]
电子计算机	5	电子计机	1 1 1 1	日 子 讠 木	[22][52][41][14]

7.13.6 Input Procedure

When the 5-Shape input method is invoked, the string “五笔字型” is displayed in the status area. You can enter a 5-Shape code through the main keyboard and the data is displayed in the pre-edit area. When a complete 5-Shape code is entered, the character that matches the code is sent. For example:

吊_
五笔字型 : kmhj

To correct the input data, press the Delete or Return key to erase the data.

If there is no valid character for the 5-Shape code, the bell rings to signal an error and you can enter another code.

7.13.7 Multiple Candidates

If input codes match multiple candidates, valid candidates are displayed in the pre-edit area.

五笔字型 : bnh_ 1了BNH 2 冫BNH 3 冫 BNH 4 冫BNH

The mechanism for selecting candidates is similar to that for the 5-Stroke input method. For details, see Section 7.12, 5-Stroke Input Method.

7.13.8 Association Mode

As with the 5-Stroke input method, Association Mode is activated automatically when you select a character from the candidate list. For details, see Section 7.12, 5-Stroke Input Method.

7.13.9 Simple Code Characters

There are three levels of simple code characters; Frequently-Used Characters (Level 1), Level 2, and Level 3.

7.13.9.1 Frequently-Used Characters (Level 1 Simple Code)

Among the 6,000 Chinese characters defined in GB2312-80, there are 25 very frequently used characters. These are defined on the keys [11] to [55]. To input these characters, press the key associated with the character (such as [11], [25]) and then press the Space bar.

The 25 frequently used characters are:

	[*1]	[*2]	[*3]	[*4]	[*5]
[1*]	一	地	在	要	工
[2*]	上	是	中	国	同
[3*]	和	的	有	人	我
[4*]	主	产	不	为	这
[5*]	民	了	发	以	经

7.13.9.2 Level 2 Simple Code

The 5-Shape input method has about 600 Level 2 Simple Code Characters. To input a Level 2 Simple Code Character, enter the first two radicals and then press the Space bar. For example, the 5-Shape code for “帮” is [13][31][52][21] (that is, DTBH). But since it is a Level 2 Simple Code Character, you can press [13][31] and the Space bar to input the character.

The Level 2 Simple Code Characters include:

啊阿爱安暗芭吧百瓣半办帮包保报北
 本比笔必避陛边变表宾冰并伯泊不步
 部才财采菜餐参惭灿册查产昌长偿吵
 炒车晨忱陈称城成呈承持池弛耻赤炽
 充抽出处春磁此从粗村达答打大呆代
 胆淡当档刀导到得灯邓迪地第帝电佃
 甸盯钉锭定订东度断队对多夺朵儿二
 罚法凡反贩芳方防妨纺放肥分坟粉丰
 风烽冯凤夫服负妇肝敢肛纲高革格蛤
 个各给耿攻功公宫贡共垢构估孤姑骨
 顾怪关官观管光归轨辍果过害汉好恨
 虹红后呼胡虎互画划化怀换蝗煌晃灰
 毁会婚伙或圾基机肌吉极及级几季寂
 计记际继纪家加尖间艰检渐江匠降胶
 交角较叫节杰结介届紧进近睛经景久
 九旧舅就居具决军开楷苛科可克客肯
 空扣枯宽昆困扩拉来乐累肋类楞离理

李历立力联脸良量辽料列林灵另刘六
龙娄搂卢卤录吕屡率绿罗妈马嘛慢么
玫煤没们眯迷米秘绵面秒民明名未牟
姆睦哪奶南男难内能尼你年宁怕炮朋
批皮平普妻七岂钱前欠强悄峭切且亲
沁轻顷庆秋区曲取权全劝然让认扔仍
如入闰弱洒三扫色砂纱闪商少社审生
失时实史式示世事氏收手守曙术甩霜
双水睡顺说思肆寺四诉虽孙所他它台
太膛提啼天条铁厅听烺瞳同屯驼妥拓
外晚宛汪为委胃卫闻无五物务析吸习
戏细瞎下仙嫌显现限线相向宵小肖协
械懈心信兴行凶胸休秀旭轩喧眩学雪
旬寻巡训押呀牙烟炎眼燕央杨洋阳样
遥药要也业叶衣姨矣亿忆义因阴引隐
蝇哟用由邮友右于愉与玉遇原员约匀
允晕杂灾载早澡灶则增曾赠粘斩崭占
站张涨找折这珍贞针阵争芝支知脂之
职直止只旨志炙中肿轴宙珠朱烛主注
驻妆浊籽子字棕综最昨左作

7.13.9.3 Level 3 Simple Code

Approximately 4,000 Chinese characters defined in GB2312-80 are classified as Level 3 Simple Code Characters. To input these characters, enter the first three radicals and then press the Space bar.

7.13.10 Wildcard Key

The Z key on the main keyboard is the wildcard key for the 5-Shape input method. When inputting a single character, the Z key can replace any root radicals about which you are uncertain.

For example, if you are not sure whether “律” should be decomposed into “彳”, “ヨ”, “二”, and “丨” (TVFH) or “彳”, “ヨ”, “丨”, and “二” (TVHF), you can enter [31][53][Z][Z] and all characters with starting root radicals [31] and [53] will be displayed for your selection. For example:

五笔字型 : tvzz_ 1很TVEY 2律TVFH 3笋TVTR 4魏TVRC +

7.13.11 Entering 5–Shape Code Through the Numeric Keypad

The 25 alphabetic keys on the main keyboard (all except the wildcard “Z” key) are used to enter 5-Shape code. You can also enter 5-Shape codes through the numeric keypad.

For instance, the 5-Shape code of “丙” is [11][[25][34][43] (GMWI). To enter “丙”, you can press [KP1][KP1][KP2][KP5][KP3][KP4][KP4][KP3] on the numeric keypad. The function of the [KP0] key is similar to the function of the Space bar.

To enter the wildcard code through the numeric keypad, press the KP6 key twice.

7.14 Pin–Yin Input Method (dxhanziim)

The 6,000 Chinese characters defined in GB2312-80 are sorted according to the Pin-Yin (phonetic) representation. Each character has its own Pin-Yin representation that you can use to input the character. To use this input method, you should have basic knowledge of Putonghua (Mandarin) and Chinese pronunciation.

The Pin-Yin input method requires each character to be entered by using one to six Roman characters and one tone mark (-, /, v, \, or o).

Only single characters can be entered using the Pin-Yin input method. Term input is not supported. But you can activate Association Mode when selecting a character.

7.14.1 Input Mechanism

Each Chinese character has a phonetic representation that can be specified in a sequence of syllables. To enter the pronunciation, enter the syllables through the main keyboard (keys A - Z). To enter the tone marks, press the key with preassigned tone marks as defined in Table 7-26.

Table 7–26: Pin-Yin Tone Marks

Tone Mark	Symbol	Key Label
First tone	-	;
Second tone	/	,
Third tone	V	\
Fourth tone	\	[
Light tone	O]

For example, the phonetic representation of “日” is "ri". Press [R][I].

7.14.2 Input Procedure

When you invoke the Pin-Yin input method, the string “汉语拼音” is displayed in the status area. When you enter the phonetic representation, the data is displayed in the pre-edit area. All characters that match the representation are displayed.

For example, when you press the A key, all characters with phonetic representations starting with "a" are displayed in the pre-edit area:

汉语拼音：a_ 1呵KSKG 2吶KUHH 3啊KBSK 4啊QBSK +

When you press the N key, all characters with phonetic representations starting with "an" are displayed:

汉语拼音：an_ 1鞍AFPV 2按SPVG 3厂DGT 4鹈DJNG +

If the phonetic representation is invalid, the bell rings. You can correct the data by using the Delete key or press Return to clear the data.

Note

If the phonetic representation has only one character, you must press the 1 key to select the character.

7.14.3 Multiple Candidates

If a Pin-Yin string matches multiple candidates, the candidates are displayed in the pre-edit area. To select one, press the corresponding numeric key. For details, see Section 7.12, 5–Stroke Input Method.

To reduce the number of candidates, you can enter a tone mark after the phonetic representation. The input method displays only those characters with the specified tone.

For example, the phonetic representation of “牛” is "niu". Eight characters are displayed for selection after you press [N][I][U]:

汉语拼音：niu_ 1妞VNFG 2牛RHK 3扭RNFG 4钮QNFG +

If you press the / key after [N][I][U], there will be only one candidate for selection:

汉语拼音：niu2_ 1牛RHK

Note

If you enter a tone mark after entering a phonetic representation, you do not need to press the [1] key to select the character in the first position. The first candidate is selected automatically when you enter another phonetic representation.

7.14.4 Association Mode

Similar to the 5-Stroke input method, Association Mode is activated automatically when you select a character from the candidate list. For details, see Section 7.12, 5–Stroke Input Method.

7.14.5 Multiple Phonetic Representations

It is possible to have multiple phonetic representations for the same character. For example, “调” can be pronounced as "diao" and "tiao". Therefore, you can enter either [D][I][A][O] or [T][I][A][O] for “调” .

7.14.6 Radical Characters

Approximately 20 radical characters are defined in GB2312-80. To input those characters using the Pin-Yin input method, input the phonetic representation of the first character of the radical name. For example, the radical name of “艹” is "cao zi tou" (草字头) . You would enter [C][A][O].

7.15 Qu–Wei Input Method (dxhanziim)

The Qu-Wei code is the representation of Qu (row) and Wei (column) in the DEC Hanzi codeset. For example, “啊” is placed in the first column of the sixteenth row. Its Qu-Wei code is 1601. To input “啊” , press [1][6][0][1].

Use the Qu-Wei input method to input any characters from the GB18030 and Unicode standards.

Because each Qu-Wei, Hexadecimal, or Unicode code or entity name in the GB18030-2000 standard unambiguously defines one Chinese character, the Qu-Wei input method does not support term input and Association Mode.

The Qu-Wei input method accepts the following input formats:

- 1601 – Qu-Wei codes in the DEC GB2312 character set: input four digits.
- 11601 – Qu-Wei codes in the extended GB character set: input five digits starting with the number 1.
- x7a or X7a – Hexadecimal value: input two, four, or eight digits.
- u5de5 or U5de5 – Unicode values U+5de5: input four or six digits.
- ¥ – The entity string name for the yen character.

When you invoke the Qu-Wei input method, the string “ 国标区位” is displayed in the status area. The input methods for the various codes are:

- To input a Qu-Wei code, enter the code by using the numeric keys (0 - 9) on the main keyboard.
- To input a Hexadecimal code, enter x or X followed by the Hexadecimal value.
- To input a Unicode value, enter u or U followed by the Unicode value. See Section 7.15.3 for a table of Entity Code and Unicode Value equivalents.
- To input an entity, enter & followed by the entity string name.

7.15.1 DEC GB2312 Characters

“ 啊” is defined in the DEC GB2312 character set and its Qu-Wei code is 1601. To input “ 啊” , enter [0][1][6][0][1] or [1][6][0][1] from the main keyboard, and press the Space bar to complete the input.

7.15.2 Extended GB Characters

The Qu-Wei codes of characters in the extended GB character set start with "1". For example, if you press [1][1][6][0][1], the user-defined character in the first column of the sixteenth row is entered.

If you make a mistake during input, you can correct the data by pressing the Delete key to erase the last key stroke, or the Return key to clear the entire code.

7.15.3 Entity Names and Unicode Values

The Qu-Wei input method allows you to input Unicode values. The following table describes character entity names and their corresponding Unicode values, as defined by the World Wide Web Consortium, that may be helpful to you.

Entity Name	Unicode Value	Entity Name	Unicode Value	Entity Name	Unicode Value
nbsp	U+00A0	ocirc	U+00F4	rArr	U+21D2
iexcl	U+00A1	otilde	U+00F5	dArr	U+21D3
cent	U+00A2	ouml	U+00F6	hArr	U+21D4
pound	U+00A3	divide	U+00F7	forall	U+2200
curren	U+00A4	oslash	U+00F8	part	U+2202
yen	U+00A5	ugrave	U+00F9	exist	U+2203
brvbar	U+00A6	uacute	U+00FA	empty	U+2205
sect	U+00A7	ucirc	U+00FB	nabla	U+2207
uml	U+00A8	uuml	U+00FC	isin	U+2208
copy	U+00A9	yacute	U+00FD	notin	U+2209
ordf	U+00AA	thorn	U+00FE	ni	U+220B
laquo	U+00AB	yuml	U+00FF	prod	U+220F
not	U+00AC	fnof	U+0192	sum	U+2211
shy	U+00AD	Alpha	U+0391	minus	U+2212
reg	U+00AE	Beta	U+0392	lowast	U+2217
macr	U+00AF	Gamma	U+0393	radic	U+221A
deg	U+00B0	Delta	U+0394	prop	U+221D
plusmn	U+00B1	Epsilon	U+0395	infin	U+221E
sup2	U+00B2	Zeta	U+0396	ang	U+2220
sup3	U+00B3	Eta	U+0397	and	U+2227
acute	U+00B4	Theta	U+0398	or	U+2228
micro	U+00B5	Iota	U+0399	cap	U+2229
para	U+00B6	Kappa	U+039A	cup	U+222A
middot	U+00B7	Lambda	U+039B	int	U+222B
cedil	U+00B8	Mu	U+039C	there4	U+2234
sup1	U+00B9	Nu	U+039D	sim	U+223C
ordm	U+00BA	Xi	U+039E	cong	U+2245
raquo	U+00BB	Omicron	U+039F	asympt	U+2248
frac14	U+00BC	Pi	U+03A0	ne	U+2260
frac12	U+00BD	Rho	U+03A1	equiv	U+2261
frac34	U+00BE	Sigma	U+03A3	le	U+2264

Entity Name	Unicode Value	Entity Name	Unicode Value	Entity Name	Unicode Value
iquest	U+00BF	Tau	U+03A4	ge	U+2265
Agrave	U+00C0	Upsilon	U+03A5	sub	U+2282
Acute	U+00C1	Phi	U+03A6	sup	U+2283
Acirc	U+00C2	Chi	U+03A7	nsub	U+2284
Atilde	U+00C3	Psi	U+03A8	sube	U+2286
Auml	U+00C4	Omega	U+03A9	supe	U+2287
Aring	U+00C5	alpha	U+03B1	oplus	U+2295
AElig	U+00C6	beta	U+03B2	otimes	U+2297
Ccedil	U+00C7	gamma	U+03B3	perp	U+22A5
Egrave	U+00C8	delta	U+03B4	sdot	U+22C5
Eacute	U+00C9	epsilon	U+03B5	lceil	U+2308
Ecirc	U+00CA	zeta	U+03B6	rceil	U+2309
Euml	U+00CB	eta	U+03B7	lfloor	U+230A
Igrave	U+00CC	theta	U+03B8	rfloor	U+230B
Iacute	U+00CD	iota	U+03B9	lang	U+2329
Icirc	U+00CE	kappa	U+03BA	rang	U+232A
Iuml	U+00CF	lambda	U+03BB	loz	U+25CA
ETH	U+00D0	mu	U+03BC	spades	U+2660
Ntilde	U+00D1	nu	U+03BD	clubs	U+2663
Ograve	U+00D2	xi	U+03BE	hearts	U+2665
Oacute	U+00D3	omicron	U+03BF	diams	U+2666
Ocirc	U+00D4	pi	U+03C0	quot	U+0022
Otilde	U+00D5	rho	U+03C1	amp	U+0026
Ouml	U+00D6	sigmaf	U+03C2	lt	U+003C
times	U+00D7	sigma	U+03C3	gt	U+003E
Oslash	U+00D8	tau	U+03C4	OElig	U+0152
Ugrave	U+00D9	upsilon	U+03C5	oelig	U+0153
Uacute	U+00DA	phi	U+03C6	Scaron	U+0160
Ucirc	U+00DB	chi	U+03C7	scaron	U+0161
Uuml	U+00DC	psi	U+03C8	Yuml	U+0178
Yacute	U+00DD	omega	U+03C9	circ	U+02C6
THORN	U+00DE	thetasym	U+03D1	tilde	U+02DC
szlig	U+00DF	upsih	U+03D2	ensp	U+2002

Entity Name	Unicode Value	Entity Name	Unicode Value	Entity Name	Unicode Value
agrave	U+00E0	piv	U+03D6	emsp	U+2003
aacute	U+00E1	bull	U+2022	thinsp	U+2009
acirc	U+00E2	hellip	U+2026	zwnj	U+200C
atilde	U+00E3	prime	U+2032	zwj	U+200D
auml	U+00E4	Prime	U+2033	lrm	U+200E
aring	U+00E5	oline	U+203E	rlm	U+200F
aelig	U+00E6	frasl	U+2044	ndash	U+2013
ccedil	U+00E7	weierp	U+2118	mdash	U+2014
egrave	U+00E8	image	U+2111	lsquo	U+2018
eacute	U+00E9	real	U+211C	rsquo	U+2019
ecirc	U+00EA	trade	U+2122	sbquo	U+201A
euml	U+00EB	alefsym	U+2135	ldquo	U+201C
igrave	U+00EC	larr	U+2190	rdquo	U+201D
iacute	U+00ED	uarr	U+2191	bdquo	U+201E
icirc	U+00EE	rarr	U+2192	dagger	U+2020
iuml	U+00EF	darr	U+2193	Dagger	U+2021
eth	U+00F0	harr	U+2194	permil	U+2030
ntilde	U+00F1	crarr	U+21B5	lsaquo	U+2039
ograve	U+00F2	lArr	U+21D0	rsaquo	U+203A
oacute	U+00F3	uArr	U+21D1	euro	U+20AC

7.16 Telex Code Input Method (dxhanziim)

Telex Code is a four-digit code used to define:

- Single Chinese characters
- Terms
- Non-Chinese symbols

It is based on the Standard Telex Code 《标准电码本》 published by the People's Republic of China. The Telex Code input method is simple and straightforward. You can input characters, terms, or symbols by entering their corresponding Telex Code from the keyboard.

When you invoke the Telex Code input method, the string “电报码” is displayed in the status area. Use the numeric keys 0 - 9 on the main keyboard to enter the codes for characters, terms, or symbols:

Character/String	Type	Telex Code	Key Sequence
乎	Character	0039	[0][0][3][9]
十六日	Term	9916	[9][9][1][6]
IX	Symbol	9949	[9][9][4][9]

7.17 Intelligent ABC Input Method (dxhanziim)

The Intelligent ABC (ItABC) input method is one of the most popular Chinese input methods because it is easy to learn and usually faster than other input methods. Intelligent ABC supports full and mixed input of words, phrases, and short sentences (Quanpin and Jianpin), coordinated input of Chinese characters and other marks (Hunpin), character shape input (Bixing), and combined input of pronunciation elements and Chinese character shapes (Yinxinghunhe).

The following sections describe the various types of input, the input process, and useful features of Intelligent ABC. For a full description of Intelligent ABC and examples of how best to use this and other input methods of the Simplified Chinese Input Server, see the online help for dxhanziim.

7.17.1 Basic Input Methods

The Intelligent ABC input method offers you five types of input; Quanpin, Jianpin, Hunpin, Bixing, and Yinxinghunhe.

- **Quanpin Input**

If you are familiar with Chinese Pin-Yin, use Quanpin input. The Quanpin input process is the same as the Chinese Pin-Yin writing process if you use standard Chinese Pin-Yin input.

When using Quanpin input, enter phrases separated by spaces or by marks, such as commas or periods. You can also use normal Pin-Yin input. The system generates an audible warning if the input is greater than the allowed number of characters and marks.

When you use Quanpin input, pay particular attention to phrases without punctuation or syllable-dividing marks.

- **Jianpin Input**

If you are not familiar with Chinese Pin-Yin, use Jianpin input.

Under Jianpin input, you use the first letter of each syllable. However, for the syllables zh, ch, and sh, use the first two letters. Also, when you select Jianpin input, make frequent use of syllable-dividing marks.

- Hunpin Input

Hunpin input is open and comprehensive, allowing a mix of full and simplified input. For example, when a phrase has more than two syllables, some syllables can use Quanpin and some syllables use Jianpin.

Keep in mind that syllable-dividing marks are very important when you select Hunpin input.

- Bixing input

With Bixing input, Intelligent ABC follows the Bixing code of eight strokes. The eight strokes are:

- heng (including ti)
- shu (including shuwangou)
- pie
- dian and na
- zhe (clockwise)
- wan (counterclockwise)
- cha
- fang

To determine the Bixing code, follow the order of strokes observed in calligraphy, but remember that you are limited to a maximum of six strokes. For more information on Bixing code and Chinese characters, see the online help for dxhanziim.

- Yinxinghunhe input

If you are familiar with the Intelligent ABC input method, select Yinxinghunhe input. With Yinxinghunhe input, you can combine Pin-Yin, and Bixing input (pronunciation and shape, respectively) to avoid overlapping codes in Quanpin or Jianpin input.

Yinxinghunhe input has the following format (where “pinyin” can be Quanpin, Jianpin, or Hunpin input):

(pinyin + [bixing description]) + (pinyin + [bixing description])
+ + (pinyin + [bixing description])

You must use “pinyin”, pronunciation input, when you input multisyllable words. You can, however, omit the [bixing description] value for shape input. When used, [bixing description] must not be more than two strokes.

When you input single syllable words or characters, you can specify the [bixing description] value alone. Also, you can mix “pinyin” and [bixing description] input to avoid overlapping codes in Quanpin and Jianpin input.

7.17.2 Input Process

The input process you use can take one of the following forms:

- Basic input process

The basic input process is a three-step process of start, middle, and finish.

Start – Press a key to enter the Pin-Yin process. This initial key is one of the 26 letters (uppercase or lowercase) from the English alphabet. If the initial key is the letter i, l, u, or v, the input has special meaning.

Middle – Input sentences. You can use any characters or marks, including numerals, as sentence input. However, for standard alteration, sentence input should conform to the combination rules.

Finish – Enter a key signifying end of input. Use a space or punctuation mark to signify the end of word input. Use the Enter key to signify character input. Under special circumstances, use [,] or CTRL+-.

If there is more than one selection, use the display of candidates on the selection window. If alteration cannot be completed, the division and formation of words is retained in memory.

- Customize the Intelligent ABC Input Method

See Section 7.3.4.7 for information on Input Method customization.

- Define New Words

In the Input Method Customization window, you can click on the customization button to display a pull-down menu. The pull-down menu includes an option labeled, Define New Words by Intelligent ABC Input Method.

If you choose this option, a dialog box displays that allows you to add or delete words and phrases. If you add words and phrases, they are saved in the file of user-defined words and phrases. If you input the outer codes of words and phrases after specific alteration of “u” type, the corresponding words and phrases are returned to the application program.

- Keyboard Definition

See the online help for dxhanziim for an example of Input Method Keyboard Definition.

7.17.3 Intelligent ABC Input Method Features

The Intelligent ABC Input Method provides the following features. The online help for the Chinese Input Server, dxhanziim, fully describes the use of these features.

- Automatic Dividing and Forming of Words

Automatic dividing of words refers to the process of dividing the continuous input of a Pin-Yin passage into several simple paragraphs and converting those paragraphs into Chinese phrases according to grammatical rules.

Forming of words refers to the process of combining several words and word elements into a new word.

- Automatic Memory

Automatic memory is usually used to retain new words such as the names of people or places that do not exist in the word palette. The process is done automatically or with little user intervention. The words of automatic memory are all standard Pin-Yin words and can be used in the same manner as the words in the basic word palette.

- Forcible Memory

Use Forcible Memory to define nonstandard Chinese Pin-Yin words. With this function, you can add new words to your word palette directly.

To retain a new word, you must input both the contents of the word and the code for it. The contents of the word can be Chinese words, expressions, and phrases, and it can consist of Chinese characters and other marks. The code for a word can be the Chinese Pin-Yin, original foreign language words, or any other marks you wish to use.

The nonstandard words you define must not be greater than 15 characters. The word code you define must not be greater than 9 marks. You can define up to 400 words.

- Obscure Recall

This function allows you to use incomplete information to recall a word that was recently used. You use the CTRL+- key to operate the Obscure Recall function.

Obscure Recall is useful when you enter a simple passage containing repetitious content.

- Frequency Adjustment and Memory

The frequency of a word refers to the frequency of word usage. The word order of homonyms in the Intelligent ABC standard word palette reflects the regular pattern of

its usage. But an individual user may need to adjust the default word order. The Frequency Adjustment and Memory function allows you to make these adjustments under the Intelligent ABC input method.

If you select Word Frequency Adjustment in the property setting, the Frequency Adjustment and Memory function begins automatically.

Because the system uses the most frequently used word as the recognized alteration result, you can use this feature to adjust this frequency and, thus, the alteration result.

The Frequency Adjustment and Memory function handles a word length range of 1 to 3 syllables. For words of single syllables, the word frequency is not adjusted until the words are used two times.

- **Leading Characters and Succeeding Characters**

The system treats a leading character (or prefix) and a succeeding character (or suffix) automatically in the process of forming new words. Some characters can be used only as leading characters and some words can be used only as succeeding characters. The dxhazziim online help describes these cases.

Intelligent ABC can distinguish leading and succeeding characters and combines the words automatically in the process of input.

- **Word Palette System**

Intelligent ABC has a basic word palette of approximately 60,000 words.

In addition, Intelligent ABC has an automatic screening function. The vocabulary for Automatic Memory is up to 17,000 words and the vocabulary for Forcible Memory is up to 400 words.

7.17.4 Intelligent ABC Usage Notes

Consider the following when using the Intelligent ABC input method. These usage notes are covered in detail by the dxhazziim online help.

- The Intelligent ABC input method allows you to convert Arabic numerals to Chinese numerals and to simplify input of some common classifiers. See the dxhazziim online help for details on transformation of punctuation marks, letters in numeral input, and normal and emphasized Chinese numerals.
- You can use a multisyllable word to reduce the number of candidates in Chinese character input. The multisyllable word you use can be from the standard palette or from a user-defined palette. The dxhazziim online help provides an example of this.
- If you use the Forcible Memory function to define a word in advance, start your input with the letter u. Likewise, to input figures and marks, in the normal state enter the

letter v and the appropriate number (1 through 9) of the GB-2312 set of characters and marks.

- To type an English word or phrase during input of Pin-Yin, enter v as an indication mark, then type the English word or phrase, and terminate with the space key.
- The input of Chinese punctuation marks is the same among different input methods. (See the dxhanziim online help for information on automatic input of shuminghao under Intelligent ABC.)

7.18 Symbol Input in dxhanziim

When you press [Ctrl/0] in the 5-Stroke, 5-Shape, or Pin-Yin mode, the string “ 符号 ” is displayed in the status area. All letters and numerals that you enter are converted to two-byte letters and numerals.

To return to the original input mode, press [Ctrl/0] again.

7.19 Conversion Between Input Servers and DECwindows Motif Applications

If you need to work with both Simplified and traditional Chinese data, you can use DECwindows Motif to enter Simplified Chinese data with the traditional Chinese input server, and vice versa.

To set up the environment for entering Simplified Chinese data with the traditional Chinese input server, you should:

1. Set the session language to Chinese China.
2. Set the XMODIFIERS environment variable to select the Chinese input server:

```
%setenv XMODIFIERS @im=DECTW
```

Hereafter, applications start in Simplified Chinese and are connected to the traditional Chinese input server. You can enter Simplified Chinese data using the input methods provided by the Chinese input server, such as the Tsang-Chi input method.

If you do not set this modifier and both Simplified and traditional Chinese input servers are running, a Chinese application connects to the first input server that is started.

Note

The data in the pre-edit area of the Chinese input server is displayed in Simplified Chinese.

Those Chinese characters that cannot be converted to Simplified Chinese characters are represented by a reverse question mark. If two or more user-defined characters have the same input key sequence, two or more reverse question marks might appear near the end of the line. In that case, you should try each one to find the character you want.

Use the UDC Manager (`cedit`) to define the user-defined characters and their corresponding input key sequences. Since a VT382-D terminal is a DEC Hanyu terminal, you can create an input key sequence file only under the DEC Hanyu locale. Generation of an input key sequence file under the Taiwanese EUC and BIG-5 locales is not supported in this release.

To set up the environment for entering traditional Chinese data with the Simplified Chinese input server:

1. Set the session language to Chinese Taiwan.
2. Set the `XMODIFIERS` environment variable to select the Simplified Chinese input server:

```
%setenv XMODIFIERS @im=DECCN
```

Hereafter, applications start in Chinese and are connected to the Simplified Chinese input server. You can enter Chinese data using the input methods provided by the Simplified Chinese input server, such as the 5-Shape and the 5-Stroke input methods.

Chinese Printing Support

This chapter introduces the Chinese printing support provided by the Compaq Tru64 UNIX operating system. It describes the supported printers, print file formats, features, and maintenance procedures for supporting Chinese printing.

8.1 Supported Printers

The Compaq Tru64 UNIX software supports text and PostScript printers.

8.1.1 Text Printers

The Compaq Tru64 UNIX software supports text printers with built-in Chinese fonts.

8.1.2 PostScript Printers

The Compaq Tru64 UNIX software supports Chinese printing on PostScript printers in two ways:

- Based on the built-in or downloaded fonts installed in printers
- Based on the *font-faulting* mechanism, which is explained in Section 8.3, Printing Features
- Based on the font-embedding mechanism

For details about the supported printer types and print filters, see Chapter 4, Local Language Devices.

8.2 8.2 Print File Formats

The Compaq Tru64 UNIX software supports printing mixed ASCII and Chinese characters in the following print file formats:

- Plain text files on text printers and PostScript printers

- Files with the nroff control sequences (for printing with underline, superscript, subscript, and bold attributes) on text printers and PostScript printers
- PostScript files on PostScript printers

The print filters for PostScript printers can automatically detect the format of a print file and convert it to the proper format for printing.

8.3 Printing Features

The Compaq Tru64 UNIX software supports the following printing features:

- Font embedding
- Font faulting
- Software on-demand font loading (SoftODL)
- Codeset conversion
- Outline fonts

8.3.1 Font Embedding

Font embedding refers to a mechanism where all the necessary font data is embedded within the printer input file. It is not necessary for printers to have resident fonts. This mechanism is supported only on PostScript printers that support PostScript level 2 or level 1 with multibyte font extension. Outline fonts are used for the embedding, if available. Otherwise, lower quality bitmap fonts are used.

The font-embedding mechanism is useful since few printers have Chinese resident fonts. However, there must be enough memory inside the printer to hold the font data or the print job might fail. The amount of memory required depends on the nature of the print job. It is recommended that at least 4 MB or more printer memory be available for the embedding mechanism.

Because of the large amount of data transferred to the printer, it is also necessary to use a high-speed link between the host computer and the printer. Using the serial port for printing is too slow for the font-embedding mechanism.

See the `wwpsof(8)` reference page for more information about how to use the font embedding mechanism.

8.3.2 Font Faulting

Font faulting is a mechanism used to handle the large memory required by fonts for some codesets, particularly multibyte codesets for Asian languages. Using font faulting, font information is stored on either:

- The secondary storage of a supporting host machine, called a font-faulting server, or

- An internal font disk

The font information is loaded into the printer on demand, thus conserving printer memory.

Font faulting is often essential for multibyte ideographic fonts because the memory required to store a single font can exceed the memory capacity of many printers. Specialized local language printers, such as Japanese printers, do not require font faulting because the local language fonts reside on the printer. However, other printers require a mechanism to load these fonts as needed for different parts of the same print job.

The font-faulting mechanism is very useful for a desktop printing environment, in which a large number of different single-byte fonts may be required. In this case, simultaneously storing all the fonts in memory reduces the available memory, and therefore speed, of the printer. Also, it is possible that the number of required fonts is so large that they cannot all be in memory at the same time.

Font faulting for multibyte fonts is done on a per character (or per glyph) basis because these fonts support extremely large numbers of characters. Font faulting for single-byte fonts is done on a per font basis. Single-byte fonts are small and relatively simple, so loading the whole font is more efficient.

The font-faulting mechanism can be used with the following printers:

- DEClaser 1152
- DEClaser 5100
- PrintServer 17

See Section 8.5, Chinese Printing Setup for information about configuring these printers.

8.3.3 Software On-Demand Font Loading

Software On-Demand Font Loading (SoftODL) is a mechanism through which a terminal or a bitmap printer downloads the relevant bitmap font information for a user-defined character (UDC) at the time the character needs to be displayed or printed. The Chinese bitmap printers that support this feature include:

- CP382D controller (for traditional Chinese)
- LA88-C (for Simplified Chinese)
- LA380-CB (for Simplified Chinese)

8.3.4 Codeset Conversion

The Compaq Tru64 UNIX software includes a codeset conversion mechanism used to print text files that have a codeset different from the one used by the printer. For printers with built-in or downloaded Chinese fonts, the codeset of the printer should be defined to match

the codeset of the built-in fonts. For printers using the font-faulting mechanism, the codeset of the printer should be defined to match the codeset of the font to be loaded. For printers using the font-embedding mechanism, the codeset of the printer should not be defined.

8.3.5 Outline Fonts

The Compaq Tru64 UNIX software provides a large set of outline fonts for printing files in various languages. Depending on how many local language support subsets are installed on your system, more than 150 outline fonts may be available.

There are four sets of Chinese outline fonts, two for traditional Chinese and two for Simplified Chinese. These fonts are:

- Sung-Light-CNS11643
- Hei-Light-CNS11643
- Hei-GB2312-80Xi
- XiSong-GB2312-80

Those fonts with the CNS11643 extension are traditional Chinese fonts encoded in the DEC Hanyu codeset, with glyphs for plane 1 and plane 2 characters. Those fonts with the GB2312-80 extension are Simplified Chinese fonts encoded in DEC Hanzi.

8.4 Commands and Daemons

Before you can utilize the printing features supported by the Compaq Tru64 UNIX software, there are some commands and daemons that you should understand. This section discusses these commands and daemons in detail and the following section illustrates how they are used for configuration.

8.4.1 Country-Specific Options to the lpr Command

In addition to the usual options to the `lpr` command, the `-A` option is used to pass country-specific parameters. You can use `ya` to set the parameters to the `-A` option in the `/etc/printcap` file. For example, you can specify the parameters using the `-A` option to the `lpr` command as:

```
% lpr -A "flocale=zh_TW.big5 font=Sung-Light-CNS11643 plocale=zh_TW.dechanyu" <file>
```

You can define the same set of parameters in the `/etc/printcap` file as:

```
:ya="flocale=zh_TW.big5 font=Sung-Light-CNS11643 plocale=zh_TW.dechanyu":\
```

The parameters supplied with the `-A` option to the `lpr` command override the corresponding default values in the `/etc/printcap` file.

The following parameters are applicable to Chinese printing:

- `flocale=<any valid locale>`

Specifies the locale for the source text file. The printer filters use this locale to validate the characters inside the source text file. If this value is not set properly, the text is interpreted using the current locale. In Chinese printing, this value is particularly important in order for the `lpr` command to correctly interpret the characters. Moreover, if the `plocale` option is also set, the `lpr` command performs codeset conversion for the source text file.
- `plocale=<any valid locale>`

Specifies the locale for the printer. If the printer has built-in fonts, the `plocale` value should match the codeset of the built-in fonts. If the printer employs the font faulting mechanism, the `plocale` value should match the font used to print the text file.
- `font=<supported outline font>`

Specifies the font name for printing the source text files on a PostScript printer. This parameter is used for printing text files only, as PostScript files are already tagged with the required font name.
- `odldb=<odl database path>`

Specifies the path of the SoftODL database files. This parameter is used to override the system default SoftODL database path, hence allowing users to access their own SoftODL database.
- `odlstyle=<odl style and size>`

Specifies what SoftODL font style and size to use. The value is of the form `<style>-<NxN>` (that is, normal-24x24). If not specified, the system default SoftODL style and size are used.
- `line=<number of lines>`

Specifies the number of lines per page. You can use this parameter with the `-w` command to control the font size and orientation of the output.

8.4.2 PostScript Font Management Utility (pfsetup)

A PostScript font management utility, `pfsetup`, is provided to help you set up print queues to use the font-faulting mechanism. This utility has the following syntax:

```
pfsetup [-s] [-d] [queue_name...]
```

The following options can be used:

- s setup mode — Allows you to set up lists of fonts to be downloaded
- d download mode — Downloads fonts to printers according to the lists prepared with the -s option

If you do not specify an option, `pfsetup` displays the information about the print queues that have been set up with this utility. If you do not specify a particular queue name, the `pfsetup` command processes every applicable queue.

In setup mode, the `pfsetup` command displays all PostScript printer fonts available on the system and prompts you to select the fonts or font headers to be downloaded onto individual print queues:

```
% /usr/sbin/pfsetup -s
=====
Printer queue: lp1 | 1 | dl1152w
No font has been setup for downloading in queue lp1
These are fonts available in your system for downloading. Fonts
chosen for downloading are marked with *

1 Hei-Light-CNS11643          2 Sung-Light-CNS11643
3 Hei-GB2312-80              4 XiSong-GB2312-80
5 XiSong-GB2312-80          6 AngsanaUPC-Bold@
7 AngsanaUPC-BoldItalic@    8 AngsanaUPC-Italic
9 AngsanaUPC-Light          10 CordiaUPC-Bold
11 CordiaUPC-BoldItalic     12 CordiaUPC-Italic
13 CordiaUPC-Light          14 EucrosiaUPC-Bold
15 EucrosiaUPC-BoldItalic   16 EucrosiaUPC-Italic
17 EucrosiaUPC-Light        18 FreesiaUPC-Bold
19 FreesiaUPC-BoldItalic    20 FreesiaUPC-Italic
21 FreesiaUPC-Light         22 IrisUPC-Bold
23 IrisUPC-BoldItalic       24 IrisUPC-Italic
25 IrisUPC-Light            26 JasmineUPC-Bold

[C]ontinue | [S]etup | [L]ist fonts | [Q]uit | [N]ext queue <C>
```

The action keys provided by `pfsetup` have the following meaning:

Key	Action
[C]ontinue	Displays a further font listing
[S]etup	Proceed to setup
[L]ist fonts	List fonts again
[Q]uit	Quit <code>pfsetup</code>
[N]ext queue	Proceed to the next queue

If you choose the `s` option, another prompt is displayed:

```
[A]dd fonts | [R]emove fonts | [L]ist fonts | [Q]uit |  
[N]ext queue <N>
```

In response to the prompt, you can enter `a` to add fonts to or `r` to delete fonts from the list for a print queue. The fonts you select are highlighted with an asterisk (*).

Note

The fonts on this list vary according to the language variants that have been installed on your system.

To download the fonts or font headers selected in setup mode, use the `pfsetup` command with the `-d` option.

For fonts of ideographic character sets, the `pfsetup` utility downloads only their font headers. Data defining their font glyphs is downloaded only on an as-needed basis through the font faulting mechanism. This saves printer memory. For single-byte fonts, the utility downloads the entire font onto printers for efficiency.

8.4.3 Font-Faulting Daemon (ffd)

To handle font-faulting requests from a PostScript printer with the two channel approach, (as DEClaser 1152 see Section 8.5.2), the font faulting-daemon, `ffd`, must be running on your system. When the daemon receives a font data request, it extracts the required font glyph data from the specified font and sends it to the printer through the secondary channel.

If you configure a print queue that uses the two channel approach, or modify the secondary channel of a print queue, you must restart the font-faulting daemon.

To restart the font-faulting daemon, log in as a superuser and stop the existing font-faulting daemon with the following command:

```
% /sbin/init.d/ffserver stop
```

To start the font-faulting daemon, you can enter:

```
% /sbin/init.d/ffserver
```

8.4.4 PrintServer Printing Command `wwlpspr`

To fully utilize the features of PrintServer 17 such as two-sided printing, multiple pages per side, and so on, it is necessary to use the `lpspr` command provided by PrintServer Software Version 5.0 or later for Compaq Tru64 UNIX. This command, however, does not provide the features like locales and fonts for printing text files. To support printing files to PrintServer 17, the Compaq Tru64 UNIX software provides a unified `wwlpspr` command.

The `wwlpspr` command is a front-end program that parses the parameters passed by users and calls different commands such as print filter, `lpr`, or `lpspr` with the appropriate command. This provides users with a unified interface.

For details on the `wwlpspr` command, refer to the `wwlpspr(1)` reference page.

8.5 Chinese Printing Setup

This section describes how to set up the following printers to print Chinese characters:

- CP382-D, LA88-C, and LA380-CB Dot Matrix Printers
- DEClaser 1152
- DEClaser 5100
- PrintServer 17
- Generic PostScript printers

8.5.1 Dot Matrix Printers

The only consideration in configuring the CP382-D, LA88-C, and LA380-CB printers is whether ODL printing should be enabled or not, and, if enabled, the default ODL database path and style.

To configure any of the Chinese dot matrix printers:

1. Add a printer using the `lprsetup` command and specify the `cp382d`, `la88c`, or `la380cb` printer.

The following prompt is displayed:

```
Do you want to enable ODL? [n]
```

2. Answer `y` if you want ODL printing, and `n` if you do not.

If you answer `y`, the default ODL database and style will be used and the following prompt is displayed:

```
Enter symbol name:
```

3. To change the default, enter `ya` at the prompt. The following prompt is displayed:

```
Enter a new value for symbol 'ya'?  
["plocale=zh_TW.dechanyu"]
```

4. Enter the following string at the prompt, using the pathname and style of your ODL:

```
"plocale=zh_TW.dechanyu odldb=<path to the default ODL db>  
odlstyle=<default ODL style>"
```

Remember the double quotation marks around the parameters, and replace the `plocale` with the value found in the previous prompt.

You can now use the `lpr` command to send Chinese text files to print queues connected to these dot matrix printers. You can either set the `LANG` environment variable or use the `-A` option to denote the codeset of the text files. For example, the following command prints the file encoded in the Taiwanese EUC codeset:

```
% lpr -A "flocale=zh_TW.eucTW" my.file1
```

You can override the default ODL path by including the `odldb` and `odlstyle` options to the `-A` option of the `lpr` command. For example, the following command uses the ODL database in the `/usr/priv/odl` directory:

```
% lpr -A "odldb=/usr/priv odlstyle=normal-24x24" my.file2
```

8.5.2 DEClaser 1152

The DEClaser 1152 printer can be used to print Chinese characters by using the font faulting mechanism with two communications channels; one channel is for normal data and the second channel is for font-faulting data, as shown in Figure 8-1.

Figure 8-1: Two-Channel Communication of the Font-Faulting Mechanism

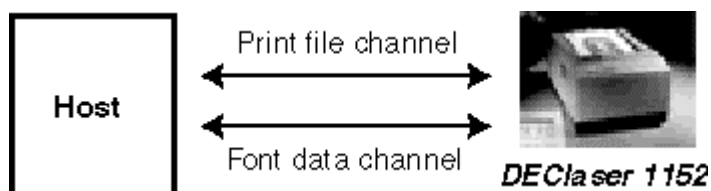

Font faulting requires 4MB of printer memory. If your DEClaser 1152 printer has only 2MB of memory, you must install the LN07X-UF memory board to provide the additional 2MB of memory. Refer to the printer manual for information about installing the LN07X-UF memory board.

You also must establish one and only one system to be the font-faulting server for the printer. This server sends font information to the printer through a secondary communication interface, or channel. The printer's secondary channel connection to the font-faulting server can be through either a local port or a Local Area Transport (LAT) port. If the connection is through a LAT port, make sure that no other applications or hosts are using that port.

An 8 pin Din to 6 Pos MMJ Adapter is needed to convert the Apple-talk interface on the printer to be the secondary channel that the font-faulting mechanism uses. The baud rate of the secondary interface should match the value of the \$BAUD variable in the /sbin/init.d/ffserver file. By default, this value is 9600 baud.

To configure the DEClaser 1152 to print Chinese files:

1. Add a printer using the `lprsetup` command and select the `dl1152w` printer type. The following prompt is displayed:

```
Do you want to configure this machine as font faulting
server for the DEClaser 1152 printer? One and only one font
faulting server should be configured for every DEClaser
1152 employing font faulting mechanism. [n]
```

2. If this machine is the font-faulting server for the printer, answer `y` to the prompt, and then enter the full pathname of the port used to connect the secondary channel for the `ya` capability.

The following prompt is displayed:

```
Do you want to set up the printer codeset or default font
for printing non-ASCII text? If your answer is 'y', please
consult printcap.4 for the parameters. *** Remember to
enclose the parameters with a pair of double quotes. [n]
```

3. Answer `y` to the prompt, and then define `plocale` and `font` in one of the following ways:

```
"plocale=<Chinese locale> font=<font>"
```

- Define `plocale` as `zh_TW.dechanyu` if you are printing traditional Chinese

characters, and define `font` as either `Sung-Light-CNS11643` or `Hei-Light-CNS11643`;

- Define `plocale` as `zh_CN.dechanzi` if you are printing Simplified Chinese characters, and define `font` as either `XiSong-GB2312-80` or `Hei-GB2312-80`.

4. Use the `pfsetup` command to download the fonts. For greatest efficiency, download all the Chinese fonts unless there are some you will never use, plus the most frequently used single-byte fonts. The printer can access the fonts that are not manually downloaded, but there is overhead for dynamically downloading fonts.
5. If you configured this machine as the font-faulting host, enter the following commands to notify the font-faulting daemon about the new printer:

```
% /sbin/init.d/ffserver stop
% /sbin/init.d/ffserver start
```

You need to enter these commands only after you add or modify the printer queue. The next time you reboot the server, the font-faulting daemon will locate the printer.

6. Each time the font-faulting server or the DEClaser 1152 is restarted, you should use the `pfsetup` command to download the fonts again.

For details about the font-faulting daemon and the `pfsetup` utility, see Section 8.4, *Commands and Daemons*.

To send Chinese text files to print queues connected to a DEClaser 1152, use the `lpr` command. You can either set the `LANG` environment variable or use the `-A` option to denote the codeset of the text files. For example, the following command prints the file encoded in the Taiwanese EUC codeset:

```
% lpr -A "flocale=zh_TW.eucTW" my.file1
```

You can override the default `plocale` and `font` setting in the `/etc/printcap` file using the `-A` option of the `lpr` command, but be sure the font you use matches the codeset of `plocale`. For example, the following command gets the file encoded in Taiwanese EUC, converts it to DEC Hanzi, and prints it using the `XiSong-GB2312-80` font:

```
% lpr -A "flocale=zh_TW.eucTW
plocale=zh_CN.dechanzi font=XiSong-GB2312-80" my.file2
```

8.5.3 DEClaser 5100

The DEClaser 5100 printer can be used to print Chinese characters by using the font-faulting mechanism with built-in hard disk. The LN90X-HD model that supports the font-faulting mechanism also includes the 128 MB hard disk option. The printer also must have at least 6 MB of memory.

To configure the DEClaser 5100 to print Chinese files:

1. Add a printer using the `lprsetup` command and select the `dl5100w` printer type.

The following prompt is displayed:

```
Do you want to set up the printer codeset or default font
for printing non-ASCII text?  If your answer is 'y', please
consult printcap.4 for the parameters. *** Remember to
enclose the parameters with a pair of double quotes. [n]
```

2. Answer `y` to the prompt and define the `plocale` and `font` in one of the following ways:

```
"plocale=<Chinese locale> font=<font>"
```

- Define `plocale` as `zh_TW.dechanyu` if you are printing traditional Chinese characters, and define `font` as either `Sung-Light-CNS11643` or `Hei-Light-CNS11643`;

- Define `plocale` as `zh_CN.dechanzi` if you are printing Simplified Chinese characters, and define `font` as either `XiSong-GB2312-80` or `Hei-GB2312-80`.

3. Use the `pfsetup` command to download the fonts. For greatest efficiency, download all fonts that you expect the printer to need; any fonts not manually downloaded are not accessible to the printer.

You need to download fonts only once. The fonts remain on the printer until they are manually removed or the hard disk is reformatted.

For details about the `pfsetup` utility, see Section 8.4, Commands and Daemons.

To send Chinese text files to print queues connected to a DEClaser 5100, use the `lpr` command. You can either set the `LANG` environment variable or use the `-A` option to denote the codeset of the text files. For example, the following command prints the file encoded in the Taiwanese EUC codeset:

```
% lpr -A "flocale=zh_TW.eucTW" my.file1
```

You can override the default `plocale` and `font` setting in the `/etc/printcap` file by using the `-A` option to the `lpr` command, but be sure the font you use matches the codeset of the `plocale`. For example, the following command gets the file encoded in Taiwanese EUC, converts it to DEC Hanzi, and prints it using the `XiSong-GB2312-80` font:

```
% lpr -A "flocale=zh_TW.eucTW
plocale=zh_CN.dechanzi font=XiSong-GB2312-80"
my.file2
```

8.5.4 PrintServer 17

The PrintServer 17 printer can be used to print Chinese characters by using the font-faulting mechanism through the network. There are no special hardware requirements.

To configure the PrintServer 17 to print Chinese files:

1. Install the PrintServer Software Version 5.0 or later for Compaq Tru64 UNIX. This is a layered product, purchased separately. Refer to the installation guide for installing and configuring the PrintServer software.
2. If you want to define default the printer codeset or default font to print Chinese text, use the `lprsetup` command or manually update the `/etc/printcap` file to include the `ya` option. Add the following string to the file:

```
:ya="plocale=<Chinese locale> font=<font>":\
```

- Define `plocale` as `zh_TW.dechanyu` if you are printing traditional Chinese characters, and define `font` as either `Sung-Light-CNS11643` or `Hei-Light-CNS11643`;

- Define `plocale` as `zh_CN.dechanzi` if you are printing Simplified Chinese characters, and define `font` as either `XiSong-GB2312-80` or `Hei-GB2312-80`.

3. Use the `pfsetup` command to define the fonts to be downloaded. For greatest efficiency, download all Chinese fonts unless there are some you will never use, plus the most frequently used single-byte fonts. The printer can access the fonts that are not manually downloaded, but there is overhead for dynamically downloading fonts.

Note that you should execute the `pfsetup` command in the Configuration Host of the PrintServer Printer. After executing `pfsetup`, restart the Management Client to initialize the new configuration. Refer to the document on PrintServer Software Version 5.0 or later for further details.

4. Turn off the PrintServer 17 and then turn it on. The fonts defined in step 3 will be downloaded automatically.

Hereafter, each time you restart the PrintServer 17, the fonts download automatically. Hence the `pfsetup` command is executed only once as long as you do not modify the configuration.

For details about the `pfsetup` utility, see Section 8.4, Commands and Daemons.

To send Chinese text files to print queues connected to a PrintServer 17, use the `wlpspr` command. You can either set the `LANG` environment variable or use the `-A` option to denote the codeset of the text files. For example, the following command prints the file encoded in the Taiwanese EUC codeset:

```
% wlpspr -A "flocale=zh_TW.eucTW" my.file1
```

You can override the default `plocale` and `font` setting in the `/etc/printcap` file by using the `-A` option of the `wlpspr` command, but make sure the font you use matches the codeset of the `plocale`. For example, the following command gets the file encoded in Taiwanese EUC, converts it to DEC Hanzi, and prints it using the XiSong-GB2312-80 font:

```
% wlpspr -A "flocale=zh_TW.eucTW  
plocale=zh_CN.dechanzi font=XiSong-GB2312-80" my.file2
```

8.5.5 Generic PostScript Printers

Any PostScript printer that supports PostScript level 2 or level 1 with multibyte font extension and sufficient memory can be used to print Chinese using the font-embedding mechanism.

To configure a printer to use font embedding, use the `lprsetup` or `printconfig` utility to set up a print queue using the `wpsof` filter. You do not need to specify the printer locale as this mechanism can print any language as long as the fonts are available in the system. See the `wpsof(8)` reference page for information on how to use the features available for this print filter.

Other Chinese Features

This chapter describes features specific to the Chinese locale in Compaq Tru64 UNIX that are not described elsewhere.

9.1 Phrase Support in the VT382-D

You can download up to 100 phrase definitions into the built-in memory of the VT382-D traditional Chinese terminal. You can create a phrase definition file containing the definitions and then download the file to the terminal through the serial port.

Note

The information presented in this section is not applicable to DECwindows Motif or CDE.

9.1.1 Creating a Phrase Definition File

Each phrase definition file can contain up to 100 phrase definitions. You can create the file using any editor (such as `vi`) that allows you to edit Chinese data.

9.1.2 Syntax of Phrase Definitions

Phrase definitions have the following syntax:

```
DCS Pc SP v phrase-code / phrase-data ST
```

The parameters are:

Table 9–1: Phrase definitions

DCS	A phrase identifier defined by the Compaq Tru64 UNIX software. Its hexadecimal code is 90. For the 7-bit environment, you can use ESC P (hexadecimal code 1B 50) instead.
Pc	A parameter that controls whether the old phrase definitions in the memory should be cleared before a new one is downloaded. If Pc is equal to zero or is omitted, the old phrase definitions are kept. They are cleared if Pc equals 1.
SP	A space character.
V	A lowercase v.
Phrase-code	A phrase code is a string of up to 8 alphanumeric characters. Uppercase and lowercase letters are regarded as same characters.
/	A slash character separates a phrase code from its phrase data.
phrase-data	A phrase containing up to 80 characters. Characters can be Chinese characters, English letters, numerals, or printable symbols.
ST	An identifier that signals the end of the DCS statement. Its hexadecimal code is 9C. For the 7-bit environment, you can use ESC \ (hexadecimal code 1B 5C) instead.

The following examples show two phrase definition files for the 8-bit and 7-bit environments respectively.

- For the 8-bit environment
 - <DCS>1 vBL/提貨單<ST>
 - <DCS>0 vBW/保稅倉庫<ST>
 - <DCS>0 vBTT/銀行電匯<ST>
 - <DCS>0 vCBC/中央銀行<ST>
 - <DCS>0 vCH/票據交換所<ST>
 - <DCS>0 vCL/託收<ST>
 - <DCS>0 vCM/佣金<ST>
 - <DCS>0 vCPD/運費付訖<ST>
 - <DCS>0 vCWO/憑票即付<ST>
 - <DCS>0 vFAS/船邊交貨<ST>
 - <DCS>0 vLC/信用狀<ST>

- For the 7-bit environment:

In this example, the second slash in each phrase definition is regarded as part of the phrase definition:

```
<ESC>P1 vAMBASSAD/國寶大飯店/AMBASSADOR<ESC>\
<ESC>P0 vASIA/環亞大飯店/ASIA WORLD PLAZA<ESC>\
<ESC>P0 vBROTHER/兄弟大飯店/BROTHER<ESC>\
<ESC>P0 vCENT/世紀大飯店/CENTURY PLAZA<ESC>\
<ESC>P0 vFORTUNA/富都大飯店/FORTUNA<ESC>\
```

9.1.3 Phrase Downloading

The procedure for transferring phrase definitions from a disk file to the terminal is called downloading. The downloaded phrases are kept in the terminal memory as long as the terminal is powered on. Consequently, a phrase definition file needs to be downloaded only once in a terminal session.

To download a phrase definition file to a terminal, display the file onto a terminal using one of the Compaq Tru64 UNIX commands, such as `cat`. You can also download phrase definitions using the Phrase Utility. For details, see *Writing Software for the International Market*.

The following situations may occur during downloading:

- If a phrase code is duplicated, the new phrase definition replaces the old one.
- If a phrase code contains more than eight characters, the phrase definition is not accepted.

- If the ST code is typed incorrectly, all the characters from the first slash to the correct ST code (with the exception of DCS) are treated as part of the phrase. For example:

```
<DCS>1 vPHONETIC/注音輸入法AT
<DCS>0 vINTERNAL/內碼輸入法<ST>
```

The AT at the end of the first line is incorrect. If you enter the phrase code "PHONETIC", the following string is input:

```
注音輸入法AT0 vINTERNAL/內碼輸入法
```

- If there are more than 100 phrase definitions, the phrase definitions beyond the limit are ignored.

9.2 Sorting Utility

The methods for sorting Chinese characters are shown in Table 9–2 and Table 9–3:

Table 9–2: Traditional Chinese Sorting Methods

Sorting Method	Full Option Name	Short Option Name
Internal code	Code	c
Phonetic	Phonetic	p
Radical	Radical	r
Stroke	Stroke	s

Table 9–3: Simplified Chinese Sorting Methods

Sorting Method	Full Option Name	Short Option Name
Qu-Wei	Quwei	q
Pinyin	Pinyin	p
Radical	Radical	r
Stroke	Stroke	s

You can sort Chinese data using the internationalized `sort` utility. This utility allows you to use one sorting method by selecting the respective locale as described in Chapter 3. In some cases, you may find that using one sorting method is insufficient to meet your needs. You might need to sort your data with multiple collating sequences. For instance, many characters can have the same number of strokes and you might want to sort these characters further according to their radicals.

9.2.1 asort Utility

To sort characters according to their radicals, the Compaq Tru64 UNIX software provides an extended sort utility, called `asort`, that you can use to sort or merge files containing Chinese characters according to specified collating sequences. The `asort` utility has the same syntax as that of the `sort` utility, but it provides two additional options:

- C"collate_sequence" Defines the collating sequences where `collate_sequence` is a list of identifiers or abbreviations of the collating sequences for sorting or merging a file.
- v Specifies to sort Chinese data in breadth-first comparison, just like the behavior of the VMS/Hanyu or VMS/Hanzi sorting mechanism. By default, depth-first comparison is used.

9.2.2 Multiple Collating Sequences

The `asort` utility allows you to specify multiple collating sequences. By default, Chinese data is sorted by internal code. You can specify collating sequences with the `-C` option so that Chinese data can be sorted using other collation methods. For example, the following command sorts DEC Hanyu data files in the order of stroke, radical, and then phonetic:

```
% setenv LANG zh_TW.dechanyu
% asort -C"Stroke Radical Phonetic" input.dat > output.dat
```

Alternatively you can enter:

```
% setenv LANG zh_TW.dechanyu
% asort -C"srp" input.dat > output.dat
```

These commands first sort the input data file according to the number of strokes. If multiple characters have the same number of strokes, they are then sorted by radical. If multiple characters within this group start with the same radical, they will then be sorted by phonetic order.

Note

The `asort` utility is locale sensitive. You should first set the `LANG` environment variable to the required Chinese locales before using the `asort` utility.

9.2.3 Depth–First Against Breadth–First

By default, the `asort` utility compares Chinese data according to the specified collating sequences using depth-first comparison. That is, each character in a sort field is compared using all the specified collating sequences until the collating order is resolved. When two characters have the same collating order, the next pair of characters is compared.

OpenVMS/Hanyu or OpenVMS/Hanzi use a slightly different sorting mechanism. The `HSORT` utility provided with OpenVMS/Hanyu sorts characters in the whole sort field using the first collating method. The second collating method applies only if the collating order of the two sorting fields is identical. This is called breadth-first comparison. If you want your sorting results to be compatible with that generated by OpenVMS/Hanyu or OpenVMS/Hanzi, you can specify the `-v` option:

```
% asort -C"srp" -v input.dat > output.dat
```

9.2.4 User–Defined Characters

The `asort` utility supports the sorting of user-defined characters with the collating values defined through the `cedit` utility. If required, the `asort` utility looks up the collating values from the UDC database and sorts the data accordingly. The mechanism for sorting UDCs is totally transparent to you.

9.3 Hanyu and Hanzi DECterm

Hanyu DECterm is a VT382-D terminal emulator; Hanzi DECterm is a VT382-C terminal emulator. This section describes the Chinese features that are specific to the Hanyu and Hanzi DECterm. For the details of the common internationalization features provided by DECterm, see *Writing Software for the International Market*.

This section describes:

- How to create a Hanyu or Hanzi DECterm
- How to use terminal emulator features
- How to use input and output Chinese characters
- How to use other VT382-D and VT382-C functions

9.3.1 Creating a Hanyu or Hanzi DECterm

The terminal type that DECterm emulates is sensitive to the session language.

To create a Hanyu DECterm through the Session Manager, set the session language to one of the traditional Chinese locales, for example, Chinese Taiwan, and then select DECterm from the Applications menu of Session Manager. To create a Hanzi DECterm, select one of the Simplified Chinese locales, for example, Chinese China.

Alternatively, you can use the `-xnllanguage` qualifier to specify the terminal type of the DECterm to create. For example, you can use `zh_CN.dechanzi` as the value for `-xnllanguage` to create a Hanzi DECterm:

```
% /usr/bin/X11/dxterm -xnllanguage \ zh_CN.dechanzi
```

If you specify an unknown value for `-xnllanguage`, then ISO Latin-1 DECterm is assumed. If no Chinese font exists, it defaults to ISO Latin-1 DECterm.

The user interface language of Hanyu and Hanzi DECterm always follows the terminal type. The language is independent of the language selection.

9.3.2 Customizing DECterm

Except for customization of NRCS character sets, all customization features applicable to the ISO Latin-1 DECterm window can also be applied to any Hanyu or Hanzi DECterm window.

Customized features can be saved and restored in the same way as in ISO Latin-1 DECterm.

9.3.3 Font Sizes

By choosing the Big Font or Little Font option from the Window... item of the Options menu you can choose either the 24x24 or 16x18 Chinese fonts.

9.3.4 Terminal ID

By choosing the General... item from the Options menu you can change the general features, such as the terminal type, for the Hanyu and Hanzi DECterm from a dialog box. You can also choose the VT382 ID from the dialog box.

9.3.5 Interaction Style

By choosing the Input Method... item from the Options menu you can select the interaction style for Hanyu and Hanzi DECterm. For example, if you want to select the root window interaction style, you can click on the Root Window button and then apply the change. If you click on the ISO Latin 1 Input button, Hanyu and Hanzi DECterm disable the input of Chinese data until another style is selected.

9.3.6 Input Server

By choosing the Input Method... item from the Options menu you can switch to use another input server for Hanyu and Hanzi DECterm. By default, the traditional Chinese input server is used for Hanyu DECterm, and Simplified Chinese input server is used for Hanzi DECterm. To select another input server, you can click on the Other button and then enter the input server name on the input field.

For Hanyu DECterm, you can enter DECCN to switch to the Simplified Chinese input server. For Hanzi DECterm, you can enter DECTW to switch to the traditional Chinese input server. For details about these input servers, see Chapter 7.

9.3.7 Copying Information

You can use the Edit menu to copy information within or between DECterm windows. The Cut-and-Paste operation is enhanced to handle mixed ASCII and Chinese characters. Beyond this, conversion between traditional and Simplified Chinese data is performed when data is copied between Hanyu DECterm and Simplified Chinese applications, and between Hanzi DECterm and traditional Chinese applications, through the cut-and-paste or quick copying operation.

9.3.8 Default Character Set

Hanyu DECterm supports CNS 11643 (first and second planes), DTSCS and all character sets supported by the ISO Latin-1 DECterm. Hanzi DECterm supports GB2312 and all character sets supported by the ISO Latin-1 DECterm.

ISO Latin-1 DECterm uses the ISO 8859-1 (Latin-1) as the default character set. You can override this setting by choosing another option from the General... item on the Options menu. For Hanyu DECterm, the default character set for 8-bit data is the Hanyu character set (CNS 11643 and DTSCS). For Hanzi DECterm, the default character set for 8-bit data is the Hanzi character set GB2312.

In general, Hanyu and Hanzi DECterm cannot display mixed accented Latin-1 characters and Chinese characters. If you want to achieve this, you can output the data together with the designated character set escape sequences.

9.3.9 Chinese Character Input/Output

You can enter Chinese characters in Hanyu and Hanzi DECterm by invoking any of the Chinese input modes as described in Chapter 7. Mixed ASCII and Chinese characters can be displayed properly in Hanyu and Hanzi DECterm without any special settings.

9.3.10 Reconnecting the Input Server

The Chinese input server provides you the ability to input Chinese characters. If this process does not exist or terminates for some reason, the message `Hanyu input method does not exist` or `Hanzi input method does not exist` is displayed. You can restart the input server and then use the Reset Terminal option from the Commands menu to reconnect the Hanyu and Hanzi DECterm to the input server.

9.3.11 VT382–D and VT382–C Terminal Functions

The following functions of the VT382-D and VT382-C terminal are implemented in the Hanyu and Hanzi DECterm terminal emulator respectively:

- Display characteristics and capabilities
- Text capabilities
 - Level 3 terminal compatibility
 - * VT300 mode
 - * VT100 mode
 - * VT52 mode
 - ANSI compatible control functions
- Support for Terminal State Interrogation (TSI)
- Support for all of the Chinese input methods
- Support for the following character sets:
 - DEC Special Graphics Character Set (line drawing)
 - DEC Supplemental Character Set
 - DEC Technical Character Set
 - ISO Latin-1 Character Set
 - CNS11643-1986 and DTSCS-1990 Character Sets for VT382-D, and GB2312-80 Characters Sets for VT382-C
- Control Representation mode
- Support for sixel graphics
- Support for UDK editing function
- Support for Chinese character display attributes: reverse, underline, bold, blink, double height/width

The following functions of the VT382-D terminal are implemented in the Hanyu DECterm terminal emulator:

- Display/Suppress leading code

A selection button is added in the Display... item under the Options menu for users to enable or disable the display of a symbol for the leading code in a 4-byte EDPC character.
- The escape sequence DECLCSM, that is, Leading Code Suppression Mode, is also supported in Hanyu DECterm.

no-last characters. For traditional Chinese, the no-last characters include the following:

({ ~ { ~ 【 《 ≪ ≻ ⌈ ⌋
≡({ { ‘ “ ” <<

For Simplified Chinese, the no-last characters include the following:

~ ‘ “ { < ≪ ⌈ ⌋ 【 】 ([{

- Some English characters are handled similarly according to this rule.

No-first English characters:

!), . : ; > ?])

No-last English characters:

(< [(

- Right justification - To justify the right margin of a paragraph, `nroff` inserts space characters at proper break points.

For English, space characters are usually inserted at word breaks.

For Chinese, space characters are inserted only at the following places:

- Before a can-space-before character if it is not placed at the beginning of a text line.

For traditional Chinese, the can-space-before characters include the following:

({ ~ { ~ 【 《 ≪ ≻ ⌈ ⌋
≡({ { ‘ “ ” <<

For Simplified Chinese, the can-space-before characters include the following:

‘ “ { < ≪ ⌈ ⌋ 【 】 ([{

- After a can-space-after character if it is not placed at the end of a text line.

For traditional Chinese, the can-space-after characters include the following:

, \ ° ? ! ? !) ~ } ~ } ~] ~
》 ≡ > < 』 』 』 』 } } } ” ” ‘ > =

For Simplified Chinese, the can-space-after characters include the following:

、 ° ’ ” } } > 』 』 』 』 !) , . > ?] }